

# UC Davis

## UC Davis Previously Published Works

### Title

Near Surface Residual Stress Measurement Using Slotting

### Permalink

<https://escholarship.org/uc/item/719014k8>

### Journal

Experimental Mechanics, 62(8)

### ISSN

0014-4851

### Authors

Olson, MD  
Watanabe, BT  
Wong, TA  
[et al.](#)

### Publication Date

2022-10-01

### DOI

10.1007/s11340-022-00858-2

Peer reviewed

# Near surface residual stress measurement using slotting

M.D. Olson<sup>1\*</sup>, B.T. Watanabe<sup>1</sup>, T.A. Wong<sup>1</sup>, A.T. DeWald<sup>1</sup>, and M.R. Hill<sup>2</sup>

<sup>1</sup>Hill Engineering, LLC, 3083 Gold Canal Drive, Rancho Cordova, CA

<sup>2</sup>Department of Mechanical and Aerospace Engineering, University of California,  
One Shields Avenue, Davis, CA  
(Author's accepted manuscript)

Submitted for publication in *Experimental Mechanics*, January 2022

Accepted for publication, April 2022, <https://doi.org/10.1007/s11340-022-00858-2>

---

## ABSTRACT

**Background:** There are various experimental measurement techniques used to measure residual stress and this work describes one such method, the slotting method, and its application to measure near surface residual stresses. **Objective:** This work examines its application to macro-scale specimens. **Methods:** A series of numerical experiments were performed to understand the size required to assume that the specimen is infinitely large, namely the thickness, width, and height. To assess measurement repeatability, 12 slotting measurements were performed in a shot peened aluminum plate. **Results:** The numerical experiments determined the specimen should have a thickness greater than or equal to 21.6 mm (0.85 in), a total specimen width (normal to the slot length) greater than or equal to 44.5 mm (1.75 in), and total height (parallel to the slot) greater than or equal to 38.1 mm (1.5 in) for the specimen to be assumed to be infinite. Slotting measurement repeatability was found to have a maximum repeatability standard deviation of 30 MPa at the surface that decays rapidly to 5 MPa at a depth of 0.3 mm from the surface. Comparison x-ray diffraction measurements were performed. **Conclusions:** Infinite plate dimensions and slot length were determined as well as measurement repeatability. Slotting was shown to have significantly better repeatability than X-ray diffraction with layer removal for this application.

*Keywords: Residual stress measurement, slotting method, measurement repeatability, infinite specimen dimensions, infinite slot length, residual stress comparison*

---

## 1. INTRODUCTION

Mechanical release methods for residual stress measurement have been around for many decades and key technological advances (e.g., computers, strain gages, CNC machining, and finite element methods) have enabled these techniques to become robust and reliable methods for measuring residual stress. One important advantage of mechanical release methods is that they are based on simple and straightforward assumptions and tend to measure properties that are easy to quantify (distortion or strain).

Two commonly used mechanical release methods for residual stress measurement are hole drilling and slitting. Hole drilling measurements are performed by incrementally drilling a small blind hole (Figure 1a) and using strain gages to monitor the deformation near the hole (caused by residual stress release) as a function of hole depth [1]. This technique has many strengths (e.g., it has an associated ASTM standard, it can be applied on a variety of materials and geometries, and it can be applied in the field since the test equipment is portable). However, the physics of a hole-drilling measurement (relatively small hole with nearby strain gages) results in low signal, which produces measurements with modest repeatability. For example, hole-drilling measurement repeatability was determined in [1] and was 14 MPa for nominally stress-free AISI 1018 carbon-steel specimens and 12 MPa for nominally stress-free 304 stainless steel specimens. That study included a cautionary note stating that measurements in specimens with non-zero residual stresses would be expected to exhibit larger variability compared to unstressed samples and additionally the variability would be larger when determining near-zero residual stress as a function of depth (i.e., a residual stress versus depth profile) compared to constant, near-zero stress as assumed in the prior study. Furthermore, the reproducibility standard deviation of hole-drilling was also determined in [2] and was around 40 MPa for friction stir welded aluminum specimens and several hundred MPa for shot peened steel specimens. Lastly, hole-drilling measurements are limited to measuring near surface residual stresses (up to 2.0 mm (0.080 in)

for the largest 1/8 in nominal Type A gage diameter, but more commonly up to 1 mm (0.040 in) for the more routinely used 1/16 in nominal Type A gage diameter).

The slitting method [3, 4] is another mechanical release measurement technique used to determine the distribution of bulk residual stress as a function of depth from the surface of a specimen. With the slitting method, a slit (i.e., a narrow cut, Figure 1b) is introduced into the workpiece and the resulting deformation (due to the redistribution of residual stress) is measured using a strain gage. The record of strain and cut depth is then used to compute the pre-cut residual stress distribution using the principles of elasticity. One of the key advantages of the slitting method is the high signal-to-noise ratio in the experimental data, which leads to excellent sensitivity, repeatability, and resolution. The slitting method produces higher quality data than hole-drilling. For example, [5] found a maximum repeatability standard deviation of 3.2 MPa using quenched 7050-T7451 aluminum plate specimens. However, the slitting method has limited ability to make measurements in specimens with complex geometry and is limited to laboratory applications since the required equipment is relatively large.

Slotting is a hybrid of slitting and hole-drilling and draws on the strengths of each measurement approach. Under this approach, the volume of removed material is an elongated slot (Figure 1c). This measurement configuration is experimentally simple (maintaining the advantages of hole-drilling) and would have similar measurement quality to the slitting technique (the elongated slot produces a high measurement signal).

The goal of this work is to introduce the slotting method for near-surface residual stress measurements and define limits such that the specimen can be assumed to be an infinite plate, determine measurement repeatability, and compare the results from the slotting measurements to complimentary results obtained using laboratory x-ray diffraction with layer removal.

## 2. METHODS

### 2.1. Slotting Measurement Technique

The slotting method is a residual stress measurement technique for generating a profile of residual stress versus depth from the material surface. The stress computation is similar to slitting [5] but offers more sensitivity near the surface due to the proximity of the strain gage. Furthermore, slotting is globally less invasive than slitting because the volume of removed material is localized to the surface and does not typically extend through most of the specimen thickness (Figure 1). The physical application of slotting is like hole-drilling, however instead of a shallow hole being milled into the body of a specimen containing residual stress, the material removed is a shallow slot. The strain released with each incremental slot depth is measured near the slot using a strain gage. The measured strain versus slot depth data are used to calculate the residual stress that was initially in the specimen through an elastic inverse solution.

The elastic inverse solution consists of assuming elastic deformation during slotting and employing the principle of elastic superposition. The strain (at the location of the strain gage) as a function of slot depth can also be expressed as

$$[(GF)^T GF + \beta C^T S^T HSC] \sigma = (GF)^T F \epsilon \quad (1)$$

where  $G$  is a *compliance matrix* that contains the strains that would be caused from assumed residual stress basis functions,  $\sigma$  is a vector of unknown residual stresses assumed to act over each slot depth increment,  $F$  is a diagonal matrix of factors that alleviates a singularity that occurs when the slot depths are large, and  $\epsilon$  is a vector of the measured strain at each cut depth.  $G$  and  $F$  are square matrices of size  $N \times N$ , with  $N$  equal to the number of cut depth increments used in the experiment. Each entry in the compliance matrix,  $G_{ij}$ , is the strain that arises at the strain gage location when a uniform unit stress (the chosen stress basis function used here) acts over a slot depth increment specified by  $i$  (i.e.,  $\sigma_{xx}(y) = 1$

over the range  $h_{i-1} < y < h_i$ , where  $h_0 = 0$ ), for a specific depth of slot  $h_j$ , where the  $x$ -direction is perpendicular to the slot and the  $y$ -direction is along the slot depth. Because this compliance matrix uses basis functions that are pulses of constant unit stress over each cut depth increment, it is called a *unit pulse* compliance matrix. The diagonal entries in  $\mathbf{F}$  are given by  $F_{(i)(i)} = [(W - h_i)/W]^2$  [6], where  $W$  is the thickness in the  $y$ -direction. This formulation of the constitutive equation uses Tikhonov regularization [6], where the  $\mathbf{C}$  matrix evaluates the chosen derivative of the residual stress solution that is to be penalized. Typically,  $\mathbf{C}$  uses second derivative regularization where the first and last rows are zero and the other rows ( $i = 2, N - 1$ ) have a tridiagonal structure given by Eq. (2):

$$\frac{-2(W/N)^2}{(h_{i+1} - h_{i-1})(h_i - h_{i-1})}, \frac{2(W/N)^2}{(h_i - h_{i-1})(h_{i+1} - h_i)}, \frac{-2(W/N)^2}{(h_{i+1} - h_i)(h_{i+1} - h_{i-1})}. \quad (2)$$

$\mathbf{S}$  is a diagonal matrix that contains the standard errors associated with the deformation data at each cut depth and is given by  $S_{(i)(i)} = F_{(i)(i)}U_{\varepsilon(i)}$ , where  $\mathbf{U}_{\varepsilon}$  is a vector of strain uncertainty versus depth.  $\mathbf{H}$  is a diagonal matrix that contains the normalized cut depth increment length (i.e.,  $H_{(i)(i)} = (h_i - h_{i-1})/W$ , where  $h_0 = 0$ ), and  $\beta$  is a scalar value called the regularization parameter.

## 2.2. Determination of infinite plate and slot length dimensions

To further investigate the practical geometric variables related to the slotting method, a series of compliance coefficients ( $G_{ij}$  in Eq. (2)) were developed for common specimen geometries and materials. This work developed calibration coefficients for many plate-like geometries. Each calibration coefficient was generated using a similar plate-like finite element model as shown in Figure 2. The model was quarter-symmetric and had a thickness,  $t$ , a width  $W$ , and a height,  $H$  (Note: Only  $W/2$  and  $H/2$  were modeled using symmetry boundary conditions). For all simulations, the slot length was 22.86 mm (0.90 in) and the slot width was 1.78 mm (0.07 in). All the models used 3D quadratic interpolation brick elements. The nodal seed spacing was 0.32 mm (0.0125 in) in all directions near the slot and was biased

away from the slot, such that the elements along the edges of the sample had nodal spacing of 0.64 mm (0.025 in). The total number of elements ranged from approximately 90,000 to 200,000.

The first portion of this work determined the thickness, width, and height for each of those dimensions to be assumed effectively infinite. To determine the “infinite” thickness dimension, the model used a width of 50.8 mm (2.0 in), a height of 76.2 mm (3.0 in), and varied the thickness from 6.35 to 50.8 mm (0.25 to 2.0 in).

After the infinite thickness dimension was determined, a thickness larger than the minimum to be assumed effectively infinite was used in subsequent modeling efforts to determine the infinite width and height dimensions. The model used to determine infinite width had a height of 127 mm (5.0 in), a thickness of 25.4 mm (1.0 in), and the width varied from 19.05 to 127.0 mm (0.75 to 5.0 in). The model used to determine infinite height had a width of 50.8 mm (2.0 in), a thickness of 25.4 mm (1.0 in), and the width varied from 25.4 to 127.0 mm (1.0 to 5.0 in).

The effect of the slot length was also investigated. Those investigations used the same basic model as shown in Figure 2, except the slot length was modeled as a truncated trench and varied from 2.54 to 22.86 mm (0.1 to 0.9 in). Those models used a thickness of 25.4 mm (1.0 in), width of 50.8 mm (2.0 in), and a height of 38.1 mm (1.5 in). This work used a consistent gage length of 0.81 mm (0.032 in).

### 2.3. *Slotting method repeatability experiment*

To assess measurement repeatability, 12 slotting measurements were performed. The specimen was made from a 7050-T7451 aluminum plate that had been stress relieved by stretching. The specimen underwent shot peening to introduce residual stresses that were nominally equibiaxial. The plate had a nominal length of 381 mm (15 in), width of 190.5 mm (7.5 in), and thickness of 25.4 mm (1 in), as seen in Figure 3. The coordinate system used here has the  $x$ -direction along the width, the  $y$ -direction along

the length, and the  $z$ -direction along the thickness (Figure 3). The plate was assumed to have an elastic modulus of 71.7 GPa (10,400 ksi) and a Poisson's ratio of 0.33.

The 12 slotting measurements were performed at various locations on the plate. The measurement location was instrumented with a strain gage on the surface adjacent to the slot. The strain gage was placed along the mid-length of the slot, at a transverse distance of 3.07 mm (0.121 in) (slot center to gage center) and had a gage length of 0.81 mm (0.032 in) (Micro-Measurements CEA-13-032UW-350) and installed using standard procedures [7]. Following application of the strain gage, the slot was cut using a bespoke milling machine, which is equipped with a high-speed electric spindle driving a small end-mill (Figure 4). The slot dimensions were approximately 22.86 mm (0.9 in) (long) (not including the cutter radius) by 1.78 mm (0.070 in) (wide). The slot was cut in a single pass for each incremental slot depth, using a drill speed of 30,000 RPM, and the strain change was monitored and recorded using a commercial Wheatstone bridge instrument. The measured strain versus slot depth data were used to compute residual stress according to the procedure outlined above.

Each measurement provided  $\sigma_{xx}$  stress as a function of depth from the surface. All measurements were performed in a consistent manner to assess measurement repeatability. Given data from the slotting measurements, the mean and repeatability standard deviation were calculated as functions of depth using standard formulae.

#### 2.4. *Comparison to X-ray diffraction*

For comparison, 12 measurements were performed using x-ray diffraction with layer removal on the same plate as the slotting measurements. The x-ray diffraction measurements were performed at a commercial measurement laboratory using a LXRD 06024 device with a 24 kV and 25 mA target power using the  $\sin^2\psi$  method [8] and 11 tilt angles with x-ray elastic constants that are consistent with those given above. The aperture area was 1 x 3 mm. Each measurement location employed layer removal to



measure stress as a function of depth from the surface. Electropolishing was applied such that measurement depths were at the surface and 0.05 mm, 0.13 mm, 0.25 mm, and 5.1 mm (0.002, 0.005, 0.010 and 0.020 in) below the surface. The commercial measurement laboratory performing these measurements accounted for stress redistribution using built in software.

### 3. RESULTS

#### 3.1. *Infinite plate and slot length dimensions*

The results from the numerical experiments to determine the relevant dimensions to assume an effectively infinite plate are shown in Figure 5 through Figure 8. The results are depicted by showing the cumulative sum of each row of  $\mathbf{G}$  and is called the flat load compliance matrix ( $\mathbf{G}_{fl}$ ); the diagonal of  $\mathbf{G}_{fl}$  is shown as a function of cut depth. The flat load compliance is beneficial since it is monotonic for increasing cut depth whereas the pulse compliance ( $\mathbf{G}$ ) is not. The results to determine the dimension of the thickness for the plate to be assumed infinitely thick are shown in Figure 5. Effectively infinite thickness was found to be 21.6 mm (0.85 in), where the calibration coefficients are within 1% of the calibration coefficients for the assumed infinite dimension. See Table 1 for maximum differences in the compliance matrix diagonal when compared to the assumed infinite thickness.

The results to determine the dimension of the width for the plate to be assumed effectively infinite are shown in Figure 6. Infinite width was found to be 44.5 mm (1.75 in), where the calibration coefficients are within 1% of the calibration coefficients for the assumed infinite dimension. See Table 2 for maximum differences in the compliance matrix diagonal when compared to the assumed infinite width.

The results to determine the dimension of the height for the plate to be assumed effectively infinitely tall is shown in Figure 7. The infinite height was found to be 38.1 mm (1.5 in), where the calibration coefficients are within 1% of the calibration coefficients for the assumed infinite dimension. See Table 3

for maximum differences in the compliance matrix diagonal when compared to the assumed infinite height.

The results to determine the dimension of the slot length for the slot to be assumed infinitely long are shown in Figure 8, which shows the slot length behaves as if it has infinite length after it is 17.8 mm (0.7 in) long, where it is within 1% of the calibration coefficients for the assumed infinite slot length (after 0.1 in and 1.01% at the initial cut depth).

### 3.2. *Repeatability experiment*

The results from the repeatability experiment are shown in Figure 9 and Figure 10. The results from the 12 slotting measurements are shown in Figure 9a, which shows the stresses are highly compressive at the surface and rapidly decay to near zero stress. The stresses are -195 MPa at the surface, decrease to -290 MPa at 0.1 mm, decay to -30 MPa at 0.25 mm from the surface and remain low magnitude for the remainder of the depths. The repeatability standard deviation is shown in Figure 10b, which shows the repeatability standard deviation is largest at the surface (28 MPa) and decays rapidly (approximately 10 MPa at 0.3 mm from the surface).

### 3.3. *Comparison measurements*

The results from the comparison measurements using x-ray diffraction are shown in Figure 9 and Figure 10. The stresses are compressive at the surface (mean of -200 MPa) and rapidly decay to lower magnitude values away from the surface. The stresses are at -75 MPa at 0.25 mm from the surface and -50 MPa at 0.5 mm from the surface. The repeatability standard deviation is shown in Figure 10b, which shows the repeatability standard deviation is initially very small at the surface (6 MPa) and increases rapidly to 47 MPa at 0.18 mm from the surface and then decays to 12 MPa at 0.5 mm and remains consistent for the remainder of the measurement depths.

A comparison of the results from the two measurements techniques is shown in Figure 10a (with error bars showing the repeatability standard deviation). Both techniques show similar residual stress values over the first 0.15 mm (0.006 in). Beyond that, the x-ray results show higher levels of compression than slotting in the bulk material. The slotting measurements have significantly better overall repeatability than the x-ray diffraction with layer removal measurements (17 MPa average repeatability for x-ray diffraction with layer removal versus 10 MPa for slotting).

#### **4. DISCUSSION**

The results of the numerical experiments give slotting practitioners recommendations for when the measurement specimen can be assumed to have infinite geometry. Namely, that the specimen should have a thickness greater than or equal to 21.6 mm (0.85 in), a total specimen width (normal to the slot length, twice the distance from the slit width center to the specimen edge) greater than or equal to 44.5 mm (1.75 in), and total height (parallel to the slot, twice the distance from the slot length center to the edge of the specimen) greater than or equal to 38.1 mm (1.5 in). The change in strain response to slot length variations was found to be minimal after the slot is 17.8 mm (0.7 in) long. For conditions that do not meet these criteria a geometry specific compliance matrix should be used.

The 21.6 mm (0.85 in) infinite thickness dimension for a slotting measurement is significantly larger than 3.07 mm (0.121 in) infinite thickness dimension for a hole-drilling measurement according to ASTM E837 [1] (for a 2.0 mm (0.080 in) diameter hole). This may be driven by the fact that the slot is removing significantly more volume of material (surface areas of 31.68 mm<sup>2</sup> for slotting and 3.14 mm<sup>2</sup> for hole-drilling, which is a factor of 10 more material for slotting). Another consideration that could be contributing to the difference in the infinite thickness dimension between techniques is that the measured strain response is more constrained by the geometry of the hole in hole-drilling (i.e., all boundaries of the hole are near the strain gage) whereas in slotting, the ends of the slot are further from

the strain gage and the strain gage would be less sensitive to stress release there. Also, the specific criteria used to accept the infinite thickness dimension for a hole-drilling measurement is unknown and is likely significantly less restrictive than the criteria used here. If the limit was relaxed to 5% then the effective thickness would be somewhat less than 12.7 mm (0.5 in) as shown in Table 1.

The repeatability standard deviations found here are comparable to those found in previous research. A previous publication that determined the repeatability of the contour method [9] summarized relevant studies with published repeatability standard deviations using slitting, x-ray diffraction, and hole-drilling. They found the repeatability standard deviation for the contour method to be between 5 and 10 MPa over most of the measurement plane and about 20 MPa near the plane boundaries in measurements of an aluminum bar. Similarly, the repeatability standard deviation for a series of x-ray diffraction measurements [10] was 8 MPa for a spring steel block, 3 MPa for a quenched 7010 aluminum block, and 18 MPa for a ground piece of aluminum. It should be noted that the measurements were repeated on the same specimen at the surface (not as a function of depth) and the repeatability is expected to increase for depth profiling x-ray diffraction measurements as shown in Figure 10 (where the repeatability below the surface is many times the repeatability value at the surface). The repeatability standard deviation for a series of slitting measurements on blocks removed from a 316L stainless steel was found to be 15 MPa at the surface and decreased to less than 7 MPa with increasing measurement depth [11]. The maximum repeatability standard deviation for a hole drilling repeatability study using stress relieved AISI 1018 carbon-steel blocks was 14 MPa and 12 MPa for a study using stress relieved 304 stainless steel block. It should be noted that the repeatability standard deviation would be expected to be larger had the specimens not been stress-relieved (i.e., measuring near zero stresses). Considering these other repeatability studies, the repeatability standard deviations found here are consistent with previous research.

To further experimentally investigate the effect of slot length in the measurement process, a series of measurements were performed in a shot peened aluminum plate that was nominally identical to the one used for the repeatability study. Measurements using various slot lengths were performed, varying from 2.54 to 22.86 mm (0.1 to 0.9 in) in increments of 2.54 mm (0.1 in). Each measurement used a compliance matrix that was specific for the slot length used in the measurement. The results can be seen in Figure 11. The results show that the stress is consistent between the measurements if the slot length is properly accounted for in the analysis.

The measured strain from each of the measurements is shown in Figure 12a along with the strain from a hole only (i.e., like a hole drilling experiment). The strain response is nominally consistent for all the measurements, except for when the slot length is 2.54 mm (0.1 in) or for the case of the hole, where the strain has significantly lower magnitude than the other measurements. For the same residual stress state, the slotting measurement relieves about 4X the amount of strain, producing a more sensitive measurement than hole drilling. Furthermore, the expected strain was calculated using the mean of the measurements and each measurement specific compliance matrix using Eq. (3).

$$\boldsymbol{\varepsilon}_{\text{expected}} = \mathbf{G}\boldsymbol{\sigma}_{\text{mean}} \quad (3)$$

where  $\mathbf{G}$  is defined in Eq. (1) and  $\boldsymbol{\sigma}_{\text{mean}}$  is a vector of the mean stress values from the measurements with various slot lengths.

The expected strains are shown in Figure 12b. The expected strains show similar trends to those that were observed in the measurements, specifically where the expected strains are consistent for all the measurements, except for when the slot length is 2.54 mm (0.1 in), where the strain has significantly lower magnitude than the other measurements. The results show that for slot lengths larger than 5.08 mm (0.2 in) the strain response is similar (within ~30% of each other), and they all are approximately 3x larger than the strain response that would be measured for hole drilling. This result is

consistent with the results of the numerical experiment shown in Figure 8a, where the compliance matrix is very similar for all the slot lengths except for when the slot length is 2.54 mm (0.1 in).

## **5. CONCLUSIONS**

This work describes the experiment and analysis that is employed during a slotting method residual stress measurement and summarizes numerical experiments that were performed to determine when a test specimen undergoing a slotting measurement can be assumed to be infinitely large (and when corrections for finite-geometry are required). The numerical experiments determined that the specimen should have a thickness greater than or equal to 21.6 mm (0.85 in), a total specimen width greater than or equal to 44.5 mm (1.75 in), and total height greater than or equal to 38.1 mm (1.5 in) for the specimen to be assumed to be infinitely large. An additional numerical experiment determined that a slot length of 17.8 mm (0.7 in) is effectively infinitely long.

This work also determined slotting measurement repeatability by performing 12 slotting measurements in a shot peened aluminum plate. The maximum repeatability standard deviation was found to be 30 MPa at the surface and decayed rapidly to 5 MPa 0.3 mm from the surface (average of 11 MPa). In comparison, x-ray diffraction had a maximum repeatability standard deviation of 46 MPa and an average value of 17 MPa for this application, which is about 50% to 60% higher than the repeatability of the slotting measurements.

## **6. ETHICAL STATEMENT/CONFLICT OF INTEREST**

The authors have no conflicts of interest to disclose and did not involve human or animal participants nor was informed consent applicable.

## **7. ACKNOWLEDGEMENTS**

Portions of this work are protected by US Patent 10,900,768 and are patent pending for other international jurisdictions.

## 8. REFERENCES

- [1] ASTM Standard E837-20, Standard Test Method for Determining Residual Stresses by the Hole-Drilling Strain-Gage Method, 2020, ASTM International, West Conshohocken, PA
- [2] JD Lord, AT Fry, PV Grant, A UK Residual Stress Intercomparison Exercise - An Examination of the XRD and Hole Drilling Techniques, NPL Report MATC(A)98, 2002
- [3] MB Prime, Residual stress measurement by successive extension of a slot: The crack compliance method. *Applied Mechanics Reviews*. <https://doi.org/10.1115/1.3098926>, 1999
- [4] MR Hill, The Slitting Method. In GS Schajer (Ed.), *Practical Residual Stress Measurement Methods* pp. 89–108, John Wiley & Sons, 2013
- [5] MD Olson, AT DeWald, MR Hill, An Uncertainty Estimator for Slitting Method Residual Stress Measurements Including the Influence of Regularization. *Experimental Mechanics*. <https://doi.org/10.1007/s11340-019-00535-x>, 2019
- [6] GS Schajer, MB Prime, "Use of Inverse Solutions for Residual Stress Measurements", *Journal of Engineering Materials and Technology*, vol. 128, p. 375, 2006.
- [7] Student Manual for Strain Gage Technology (Bulletin 3090), Vishay Measurements Group, Malvern, PA, 1992
- [8] PS Prevey, X-ray diffraction residual stress techniques. ASM International, ASM Handbook., 10, 380-392, 1986
- [9] MR Hill, MD Olson, Repeatability of the Contour Method for Residual Stress Measurement. *Exp. Mech.*, 54(7), 1269–1277. <https://doi.org/10.1007/s11340-014-9867-1>, 2014
- [10] Fry AT, Evaluation of the Repeatability of Residual Stress Measurements Using X-Ray Diffraction, NPL Report MATC(MN)19, 2002
- [11] Lee MJ, Hill MR, Intralaboratory Repeatability of Residual Stress Determined by the Slitting Method, *Experimental Mechanics*, Vol. 47, 2007

10. FIGURES

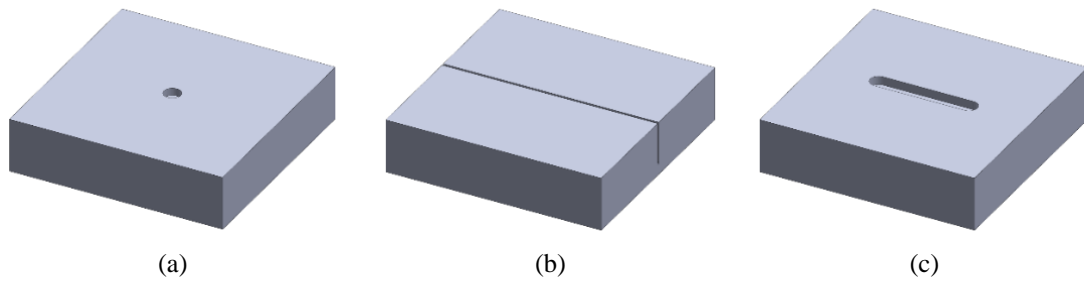

Figure 1 – Example material removal from a (a) hole-drilling, (b) slitting, and (c) slotting measurement

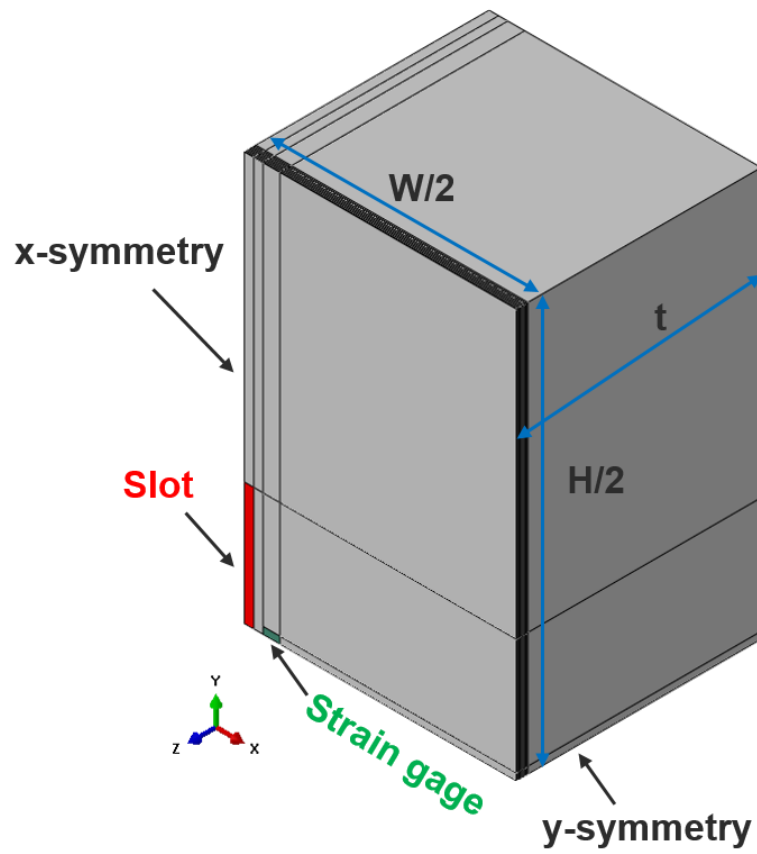

Figure 2 – Model used to determine compliance coefficients



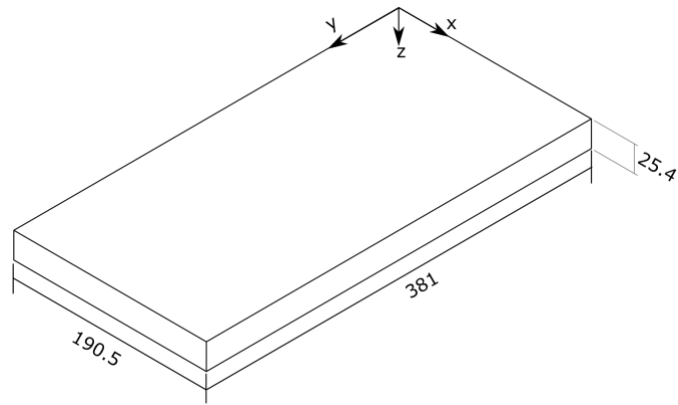

Figure 3 – Diagram of the aluminum shot peened plate used for the repeatability experiment. Dimensions in mm



Figure 4 – Solid model of the bespoke milling machine used for the slotting measurements

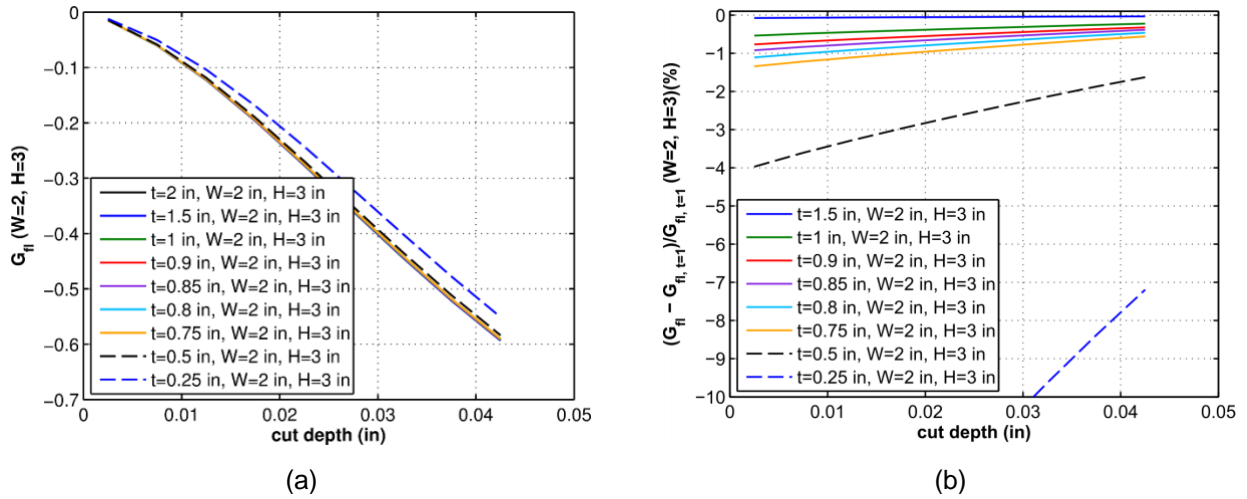

Figure 5 – (a) Compliance coefficients for various thicknesses to determine “infinite” thickness and (b) percentage difference between various thicknesses and a very large thickness

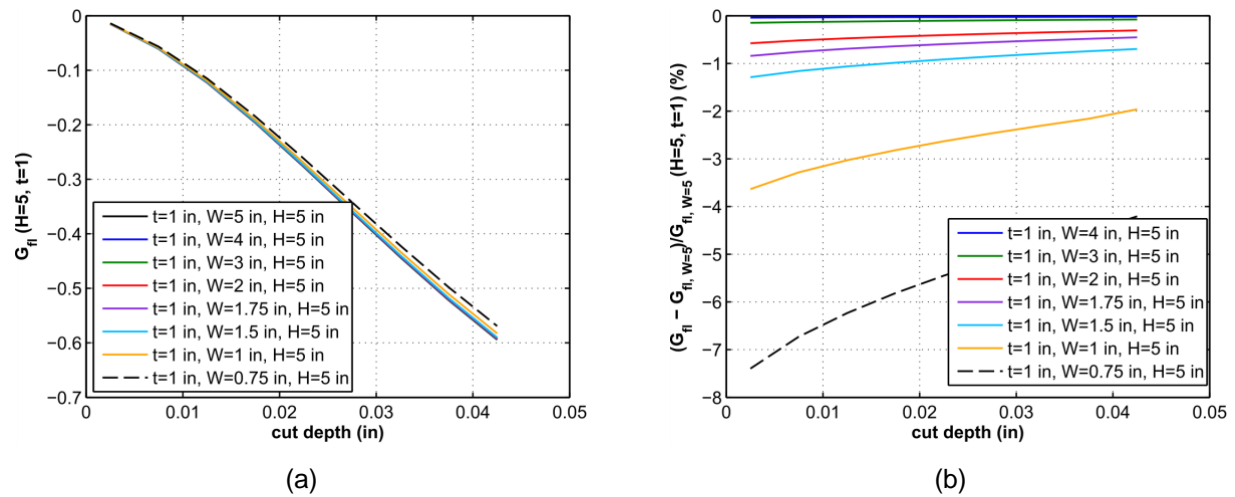
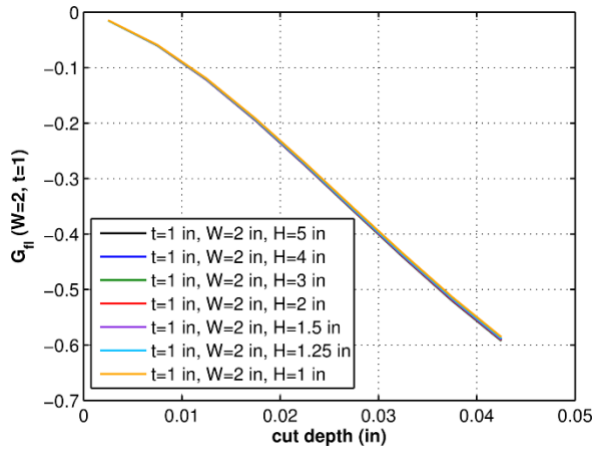
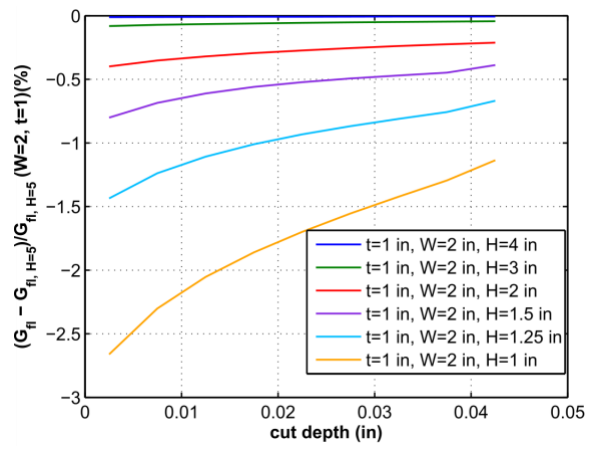

Figure 6 – (a) Compliance coefficients for various widths to determine “infinite” width and (b) percentage difference between various widths and a very large width



(a)



(b)

Figure 7 – (a) Compliance coefficients for various heights to determine “infinite” height and (b) percentage difference between various heights and a very large height

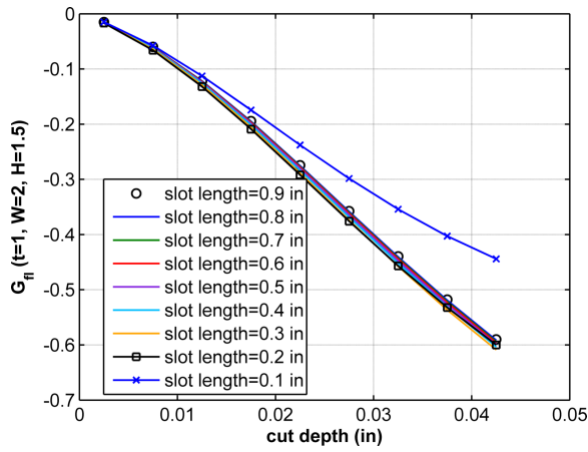

(a)

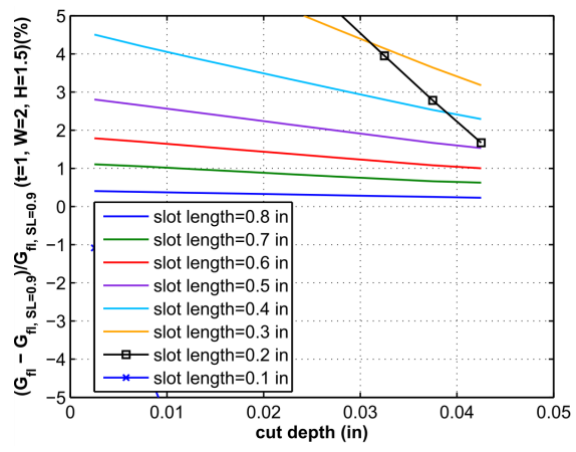

(b)

Figure 8 – (a) Compliance coefficients for various slot lengths to determine “infinite” slot length and (b) percentage difference between various slot lengths and a large slot length

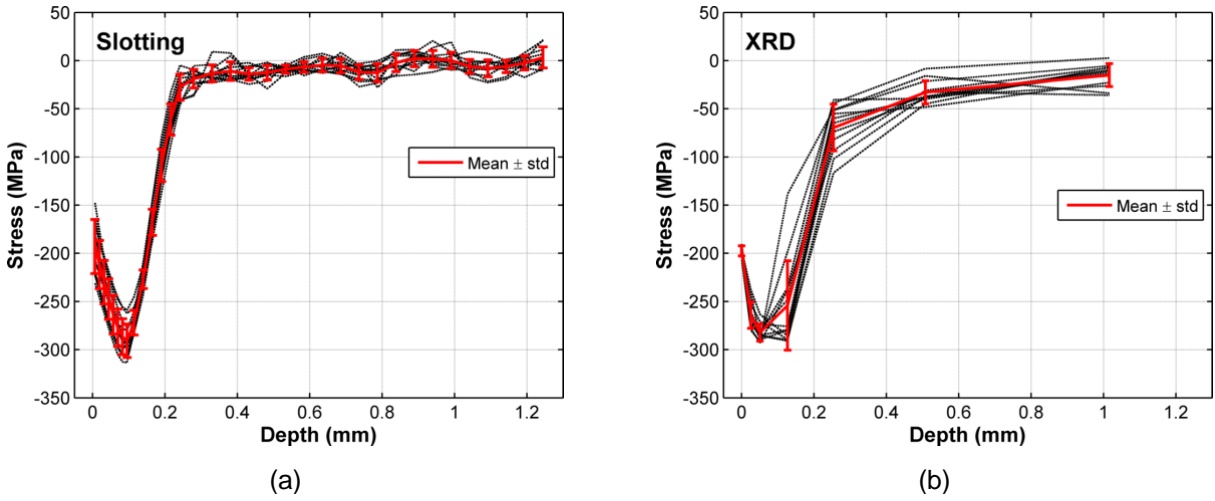

Figure 9 – Measurement results in the shot peened aluminum plate for (a) slotting and (b) x-ray diffraction. Thin dashed, black lines are individual measurements and the thick red line is the mean with error bars showing the repeatability standard deviation

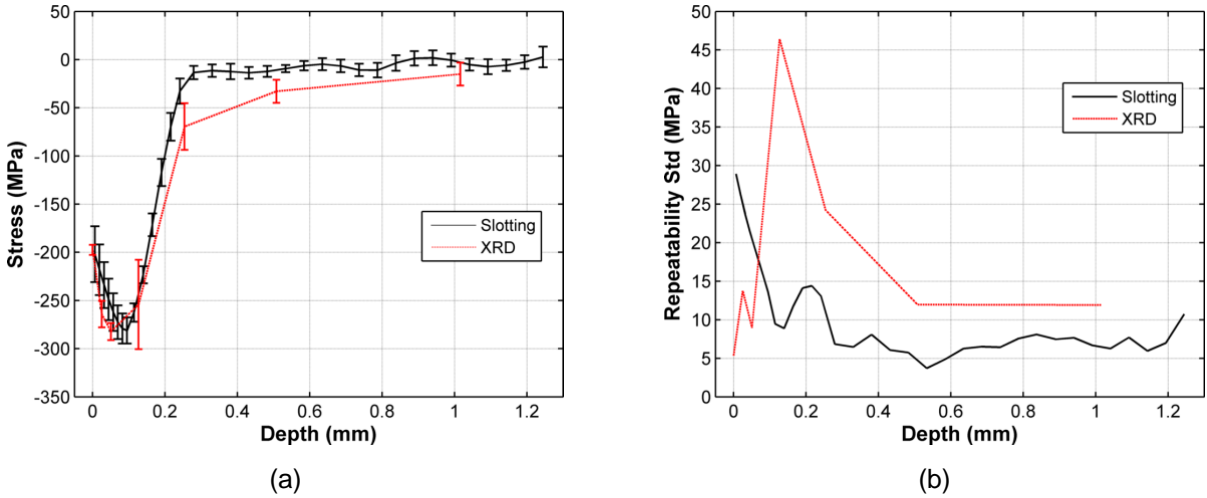

Figure 10 – Comparison of the measurements in the shot peened aluminum plate (a) stress and (b) repeatability standard deviation

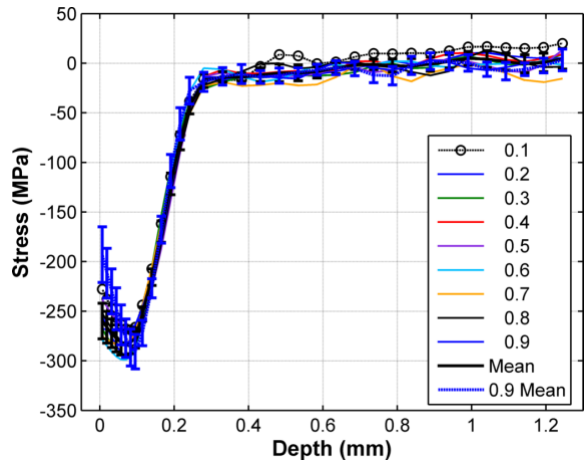
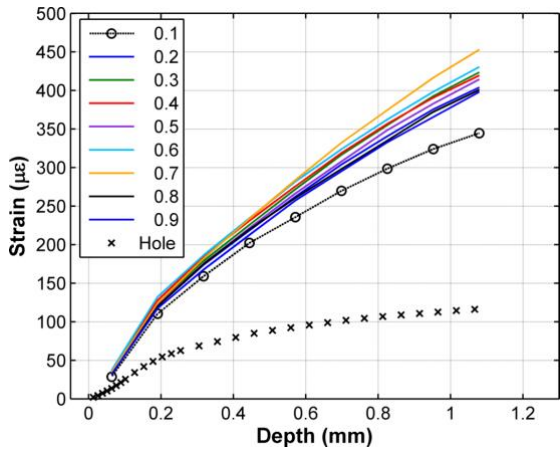
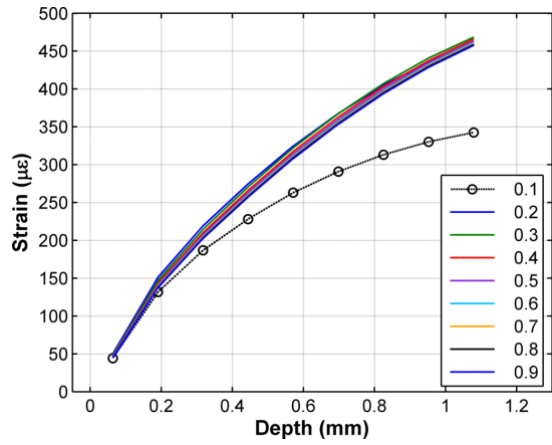

Figure 11 – Stress in the shot peened aluminum plate using a range of different slot lengths. Note: 0.9 Mean in the legend shows the mean from the previous repeatability study using a consistent slot length of 22.86 mm (0.9 in)



(a)



(b)

Figure 12 – Strain from measurements in the shot peened aluminum plate for difference slot lengths (a) measured and (b) computed using stresses in the repeatability experiment. Note: comparison strain when a hole is drilled is shown in

(a)

## TABLES

Thickness		Maximum Difference
(in)	(mm)	(%)
2.00	50.80	0.00
1.00	25.40	0.08
0.90	22.86	0.54
0.80	20.32	0.77
0.85	21.59	0.92
0.80	20.32	1.11
0.75	19.05	1.34
0.50	12.70	3.97
0.25	6.35	18.82

Table 1: Maximum difference between the compliance matrix diagonal when varying thickness. Note: width was a constant 50.8 mm (2 in) and height was a constant 76.2 mm (3 in)

Width		Maximum Difference
(in)	(mm)	(%)
5.00	127.00	0.00
4.00	101.60	0.04
3.00	76.20	0.15
2.00	50.80	0.58
1.75	44.45	0.84
1.50	38.10	1.29
1.00	25.40	3.63
0.75	19.05	7.40

Table 2: Maximum difference between the compliance matrix diagonal when varying width. Note: Thickness was a constant 25.4 mm (1 in) and height was a constant 127 mm (5 in)

Height		Maximum Difference
(in)	(mm)	(%)
5.00	127.00	0.00
4.00	101.60	0.01
3.00	76.20	0.08
2.00	50.80	0.40
1.50	38.10	0.80
1.25	31.75	1.44
1.00	25.40	2.66

Table 3: Maximum difference between the compliance matrix diagonal when varying height. Note: Thickness was a constant 25.4 mm (1 in) and width was a constant 50.8 mm (2 in)