

Lawrence Berkeley National Laboratory

Recent Work

Title

A CALIBRATED HOTBOX FOR TESTING WINDOW SYSTEMS?CONSTRUCTION, CALIBRATION, AND MEASUREMENTS ON PROTOTYPE HIGH-PERFORMANCE WINDOWS

Permalink

<https://escholarship.org/uc/item/76x4x231>

Author

Klems, J.H.

Publication Date

1979-10-01



Lawrence Berkeley Laboratory

UNIVERSITY OF CALIFORNIA

ENERGY & ENVIRONMENT DIVISION

Presented at the ASHRAE/DOE Conference on Thermal Performance
of the Exterior Envelopes of Buildings, Orlando, FL,
December 3-5, 1979

A CALIBRATED HOTBOX FOR TESTING WINDOW SYSTEMS--CONSTRUCTION,
CALIBRATION, AND MEASUREMENTS ON PROTOTYPE HIGH-PERFORMANCE
WINDOWS

J. H. Klems

October 1979

RECEIVED
LAWRENCE
BERKELEY LABORATORY

AUG 27 1980

LIBRARY
DOCUMENTS

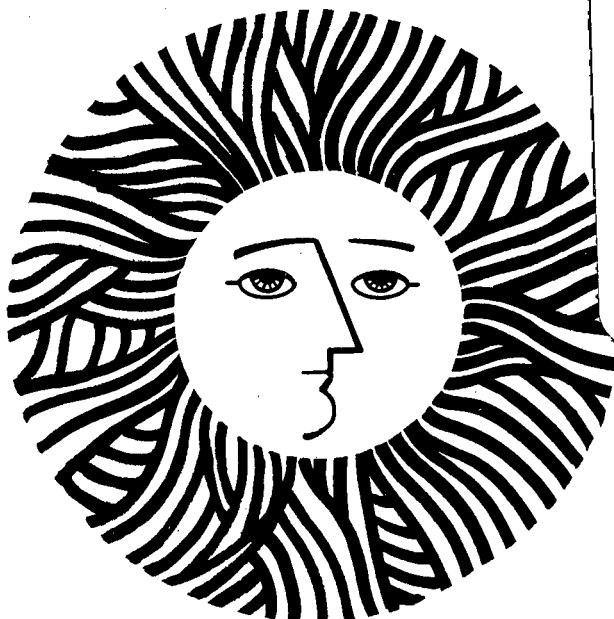

TWO-WEEK LOAN COPY

This is a Library Circulating Copy
which may be borrowed for two weeks.
For a personal retention copy, call
Tech. Info. Division, Ext. 6782

LBL-9803 c.2

DISCLAIMER

This document was prepared as an account of work sponsored by the United States Government. While this document is believed to contain correct information, neither the United States Government nor any agency thereof, nor the Regents of the University of California, nor any of their employees, makes any warranty, express or implied, or assumes any legal responsibility for the accuracy, completeness, or usefulness of any information, apparatus, product, or process disclosed, or represents that its use would not infringe privately owned rights. Reference herein to any specific commercial product, process, or service by its trade name, trademark, manufacturer, or otherwise, does not necessarily constitute or imply its endorsement, recommendation, or favoring by the United States Government or any agency thereof, or the Regents of the University of California. The views and opinions of authors expressed herein do not necessarily state or reflect those of the United States Government or any agency thereof or the Regents of the University of California.

W-44
EEB-W-79-18
LBL 9803

Presented at the ASHRAE/DOE Conference on the Thermal Performance
of the Exterior Envelopes of Buildings, December 3-5, 1979, Orlando,
Florida.

A CALIBRATED HOTBOX FOR TESTING WINDOW SYSTEMS --
CONSTRUCTION, CALIBRATION, AND MEASUREMENTS ON
PROTOTYPE HIGH-PERFORMANCE WINDOWS

By: J. H. Klems

October 15, 1979

The work described in this report was funded by the Office of Buildings
and Community Systems, Assistant Secretary for Conservation and Solar
Applications of the U.S. Department of Energy under contract
No. W-7405-ENG-48.

A Calibrated Hotbox for Testing Window Systems --
Construction, Calibration, and Measurements on
Prototype High-Performance Windows

J. H. Klems

INTRODUCTION

Windows have the highest thermal conductance (or U-value) of all the elements in a building envelope. Although the fact that windows also admit (beneficial or detrimental) solar heat gain and (generally beneficial) daylight makes U-value alone a poor predictor of the net seasonal energy performance of a window,¹ reducing the U-value remains an obvious first step in improving window performance.

A small (0.9m X 1.2m [3' X 4'] opening) calibrated hotbox has been built at the Building Technology Laboratory of the LBL/DOE Energy-Efficient Windows Program for studying methods of improving window thermal performance. We are particularly interested in comparing generic approaches to window thermal control, in identifying novel methods of improving window performance and in studying the mechanisms by which actual window performance may differ from theoretical. We first describe the construction and instrumentation of the hotbox. Next we discuss the methods by which the box has been calibrated and the limits on its accuracy. Finally we present the results of a study of prototype windows which serves the dual purpose of illustrating our methodology and presenting some interesting options for window improvement.

The thermal hotbox technique is well-known and has been described elsewhere.^{2,3} Since our interest is in research rather than product certification our emphasis in designing the hotbox was on flexibility and economy rather than extreme accuracy. Hence we chose the calibrated rather than the guarded hotbox technique. We have deferred installing fans to produce a moving air film on the cold side of the sample (simulating wind), choosing instead to correct our data from still air to 15 MPH conditions by the known difference in convective coefficient. We record the temperature at a large number of points on and around the window sample; most of these serve as diagnostic tools and are not directly used in measuring the U-value.

HOTBOX CONSTRUCTION AND INSTRUMENTATION

The hotbox facility is shown in Fig. 1. It consists of two boxes of 15cm (6") rigid polyurethane foam insulation with a plywood external skin. The rear of the cold box consists of a cooling unit capable of maintaining the box at 255 K with an accuracy of 0.5 K. The hotbox contains an electric heater which is accurately metered. The inside surfaces of the hotbox

J. H. Klems is a staff scientist at the Lawrence Berkeley Laboratory, Berkeley, California.

are covered with aluminum sheet (2mm thick) to insure uniform skin temperatures. The interiors of both boxes are painted black. A baffle prevents radiative transfer between the electric heater and the test specimen. The window under test is mounted in a specially constructed test frame consisting primarily of polyurethane foam insulation. Plywood facings necessary for rigidity are mounted on the cold box side of the frame.

The facility is normally operated with the hotbox approximately at the temperature of the surrounding room (295 K) and the cold box below room temperature (typically 255 K). Heat transfer is then primarily from the hotbox to the cold box. The amount of power applied to the heater and fan in order to maintain the hotbox at constant temperature gives the heat flow through the sample after a small correction for conduction through the test frame and losses through the skin.

Because the facility will be used to study window systems which may include interior drapes, shutters, venetian blinds, etc., it is important to maintain natural convection conditions at the window. On the other hand, for accurate measurement one needs a uniform air temperature in the box, and this requires more air circulation than natural convection provides. Our compromise between these conflicting requirements is the heater-fan combination shown in Fig. 1 (c). This unit provides sufficient air mixing to maintain a temperature uniformity of better than 1 K throughout the box.

Fig. 2 shows a diagram of the instrumentation. Temperatures are measured using calibrated thermistor probes, the outputs from which are multiplexed and plotted sequentially on the same chart. Five temperatures on each side of the sample are continuously monitored in this manner, in addition to the air temperatures in the hotbox, cold box, and room. The outputs of thermistors placed in the center of each exterior face of the hotbox are averaged and monitored also, as is the time-integrated heater power. The fan is maintained at constant voltage. Its power consumption as a function of voltage has been measured.

An SCR proportional temperature controller adjusts the heater power to maintain excellent temperature stability inside the hotbox; temperatures at a single location typically vary by less than 0.05 K. Some care is necessary to measure the power in the chopped-waveform output of the controller at the power level typical of measurements on high-performance windows (30W). We use a specially built watt-hour meter which directly multiplies the voltage and current waveforms and is therefore insensitive to waveform and phase angle. It is accurate to better than 1%.

HOTBOX CALIBRATION

In order to extract useful data from the hotbox the thermal loss rate through the hotbox skin must be determined. This was done by inserting a uniform piece of 15cm polyurethane foam in place of the sample and test frame. The average heater power P necessary to maintain the hotbox at constant temperature is then given by

$$P = UA(T_H - T_C) + S(T_H - T_R),$$

where

A = the area of the sample

U = sample thermal transmittance

T_H = hotbox temperature

T_C = cold box temperature

T_R = room temperature

S = skin loss coefficient.

The coefficients U and S are expected to be slowly-varying functions of the mean sample temperature and the mean skin temperature, respectively. The coefficient S is then determined by varying T_H while holding $(T_H - T_C)$ fixed. The power should then vary linearly with $(T_H - T_R)$ while variations in U and S will show up as systematic deviations from the straight line.

Figure 3 presents the results of one such test. The data are consistent with a straight line, indicating that assuming U and S are constants is an adequate approximation for this temperature range. The values of S and the product $UA(T_H - T_C)$ are given by the slope and intercept of the line. The value of S obtained turned out to be considerably larger than that expected from the insulation specifications. Subsequent investigations with an infrared camera revealed a thermal shunt where instrumentation cables penetrate the hotbox skin.

The skin loss coefficient was expected to vary with the heat flow through the sample, since a different heat flux requires a different convection pattern in the hotbox. Repeating the above tests for different samples and different temperature differences produced the curve plotted in Fig. 4. The measurements show that S is approximately constant at low heat flows but approximately doubles at a heat flow of 100 W. This is a larger increase than expected, and its cause is under investigation. All the measurements reported here have sample heat flows of less than 35 W, where the curve is quite flat.

The calibration was checked by measuring the heat transfer through each of 4 samples of fibreglass Standard Reference Material (SRM-1450) obtained from the National Bureau of Standards. Since these samples (0.61 m X 0.91 m) were smaller than the hotbox opening they were mounted in a special test frame built of polyurethane foam cut from sheets previously calibrated in the hotbox. The heat transmission of this frame was calculated to be $0.103 \pm .005$ W/K. Each sample was sandwiched between two sheets of aluminum to insure uniform surface temperatures and one-dimensional heat flow through the sample. The temperature of each aluminum sheet was measured using three thermistor probes on each side (mounted on the center and .3m above and below the center of the sheet). The conductance of each sample was then derived from the measured heat flux and the temperature difference between these aluminum plates.

The results of the measurement are shown in Table 1. As can be seen there is a tendency for our measurement to be high, but this is within our estimated experimental error for all samples except sample no. 3. Sample no. 3 had an anomalously low density compared to the expected range for the same lot of SRM-1450. It is currently being sent to NBS for checking in

their guarded hot plate.

The RMS deviation of our measurements from the NBS values is 7%. If sample no. 3 were excluded this would become 5%. Hence we conclude that our procedure is accurate at least to 7%, which is sufficient for our immediate purposes. Given the compromises necessary to mount the samples and derive their conductance it is doubtful whether a more accurate check by this method would be meaningful.

This test checks for overall systematic errors such as wattmeter or temperature probe mis-calibration. Our estimates of point-to-point errors are derived from measurements of time-variations in heater power and of time- and space-variations of the temperatures which enter the calculation of conductance. Point-to-point errors are generally 1 or 2%. Repeated measurements of samples 1 and 3 gave a reproducibility of considerably better than 1%, which may indicate that our point-to-point error estimates are conservative.

MEASUREMENTS OF PROTOTYPE WINDOWS

We next applied the hotbox to the study of some options for improving window performance. A standard test window was built consisting of a fixed pane of glass mounted in a polyurethane foam test frame with a minimum of wood framing and facing material. A second movable pane formed a double-glazed window of variable spacing. The edges of the movable pane were sealed to the frame with tape during measurement. A photograph of the test window appears in Fig. 5 and a section of the window in Fig. 6(a).

The window frame was first calibrated by removing the movable pane and covering the fixed pane with a piece of (15 cm) polyurethane foam of known conductance. The edges between the foam and frame were sealed with tape. A second measurement with a second piece of foam added to the other side checked that the conductance in the sample region decreases in the expected manner. The resulting frame correction obtained from these measurements (heat transferred per unit $[T_H - T_C]$) was 0.132 ± 0.026 W/K. This correction includes the heat conduction through the wood facing which supports the glass panes.

Six sets of measurements were performed. We first repeated the well-studied^{4,5} case of ordinary double glazing with different separations between the panes. We then separated out the effect of conduction-convection in the airspace by covering the inside of each glass pane (i.e., the side toward the air gap) with aluminum foil (emissivity 0.06) in good thermal contact with the glass.

Next we studied the effect of placing one or two stretched films of .005 cm polyester between the glass panes to create equal thickness air spaces as shown in Fig. 5 (b) and (c). This is in effect triple and quadruple glazing, but since the polyester film is partially transmitting in the thermal infrared the conductance will not be quite the same.

Finally we examined the effect of "heat mirror" selective coatings using a multiple-layer coating (emissivity 0.22) deposited on polyester film. This plastic film was first glued to the inside (gapward side) of the warm (movable) glass pane. In a second series of measurements it was suspended as in Fig. 6 (b) with the coated side toward the hotbox.

In these measurements the correction for skin loss was no more than 6% and the frame correction no more than 14%. The mean sample temperature was 284 K and the temperature difference across the sample was 21 K. The results of the measurements (corrected to 15 MPH wind speed) are shown in Fig. 7. The bars in this figure indicate point-to-point measurement errors. In the upper curve of Fig. 7 (a) the measurements for single glazing and conventional double glazing (solid points) are seen to be in excellent agreement with the values from the ASHRAE Data Book (dashed curve).⁶ In Fig. 7(b) one and two suspended plastic films are seen to provide respectively thermal transmittances of 0.35 and 0.25 that of single glazing (i.e., comparable to triple and quadruple glazing. Note that the ratio to single glazing is numerically equal to the U value in English units). These values are comparable to those for heat mirror coatings shown in Fig. 7(c), where a heat mirror on the glass pane is seen to result in a window with 0.32 of the thermal transmittance of single glazing (comparable to triple glazing) and one suspended between the panes, 0.20 (comparable to quadruple glazing). Thus a rough "rule-of-thumb" is that addition of a heat mirror coating is approximately equivalent to adding and extra layer of glazing.

CONCLUSIONS

The calibrated hotbox is reliable with known skin losses. Its reproducibility is better than 1%. Its point-to-point errors are estimable from the data recorded during operation and are generally 2% or better. It is free of systematic errors to at least the 7 % level.

Good thermal performance, ranging from 3 to 5 times lower conductivity than single glazed windows, can be obtained by introducing interior plastic films, heat mirror coatings, or combinations of the two into double-glazed windows.

These performances are comparable to triple and quadruple glazing but may be achieved in windows with substantially less weight and bulk. This may result in products with significantly different economics than conventional multiple glazing.

ACKNOWLEDGEMENT

This work was supported with funding from the U.S. Department of Energy provided by the Assistant Secretary for Conservation and Solar Applications, Office of Building and Community Systems.

REFERENCES

- [1] S.M. Berman and S.D. Silverstein, "Energy Conservation and Window Systems", Efficient Use of Energy, AIP Conference Proceedings 25, K.W. Ford, et. al., eds., American Institute of Physics, N.Y., pp. 245-304 (1975).
- [2] "Thermal Conductance and Transmittance of Built-Up Sections by Means of the Guarded Hot Box", ASTM-C236-66, Annual Book of ASTM Standards, American Society for Testing and Materials, Philadelphia, PA.

- [3] J.R. Murmaw, "Calibrated Hot Box: An Effective Means for Measuring Conductance in Large Wall Sections", ASTM-STP-544, American Society for Testing and Materials, Philadelphia, PA, pp. 193-214 (1973).

- [4] "The Thermal Insulating Value of Air Spaces," Housing and Home Finance Agency, Housing Research Paper no. 32, April, 1954.

- [5] G. Christensen, W.P. Brown and A.G. Wilson, "Thermal Performance of Idealized Double Windows, Unvented", ASHRAE Transactions, Paper no. 1903, vol. 70, 1964.

Table I. Comparison between Measured and Predicted Conductance
for Four Samples of SRM-1450

Sample	Conductance (W/m ² K)		Difference (W/m ² K)
	Measured	Calculated from NBS Specifications	
1	1.278 ± .025	1.215 ± .031	+0.063 ± .040
2	1.253 ± .020	1.208 ± .034	+0.045 ± .040
3	1.260 ± .022	1.129 ± .038	+0.131 ± .043
4	1.303 ± .072	1.226 ± .040	+0.077 ± .083

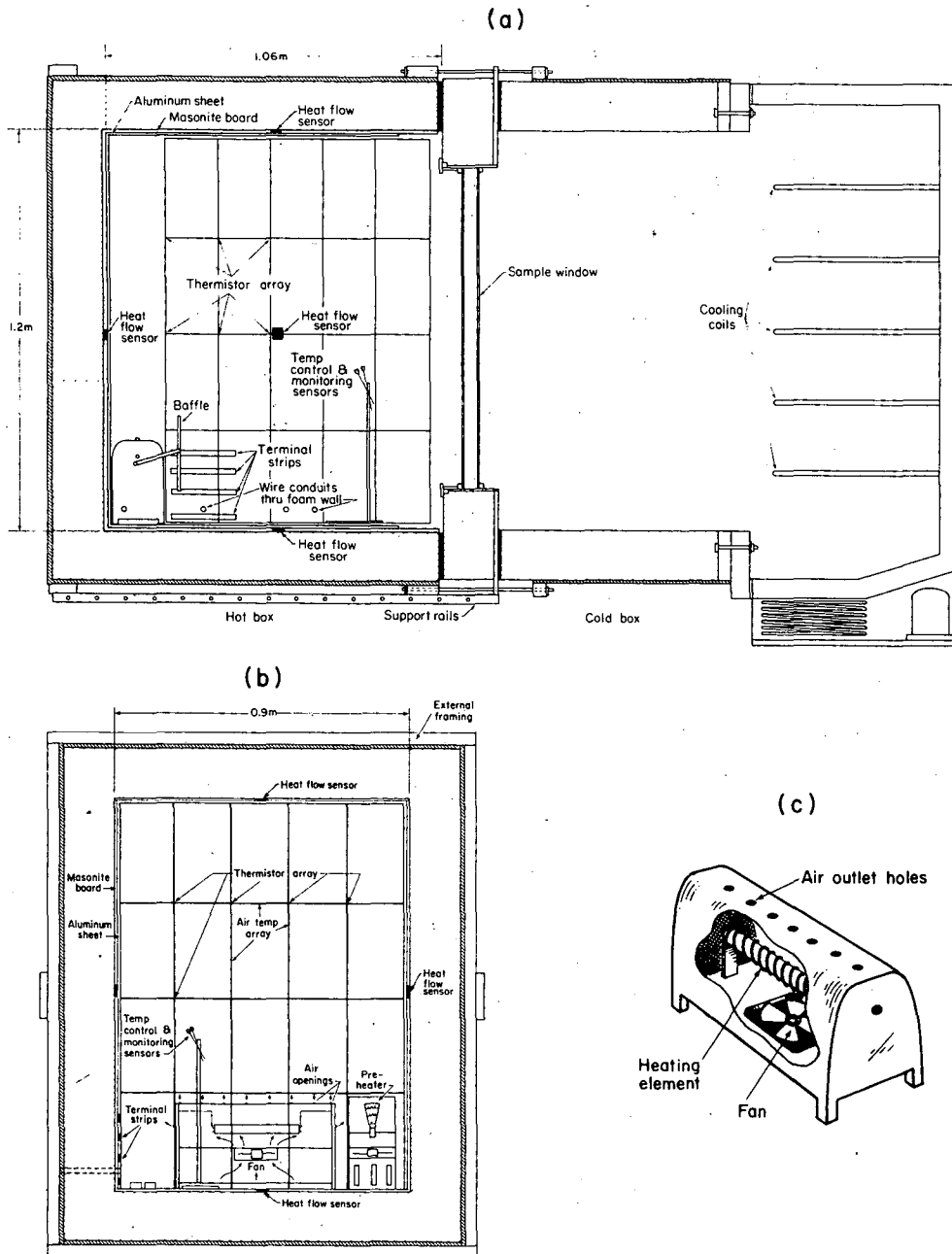

XBL 799-2921

Fig. 1. Diagram of the Hot Box Facility. (a) Vertical section through center line of facility. Locations of heat flow sensor and cable penetrations on the wall are also indicated. (b) View looking into hot box from sample with cutaway view of heater and pre-heater. (c) Detail of heater.

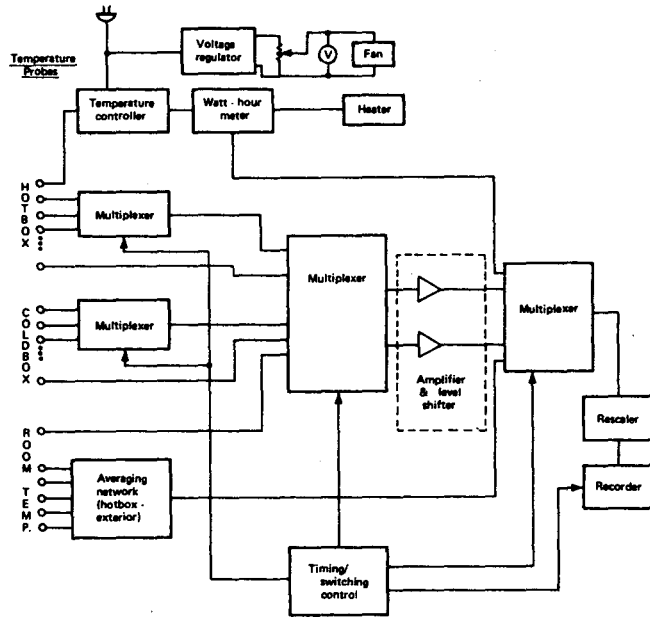

XBL 799-2918

Fig. 2. Hot box Instrumentation.

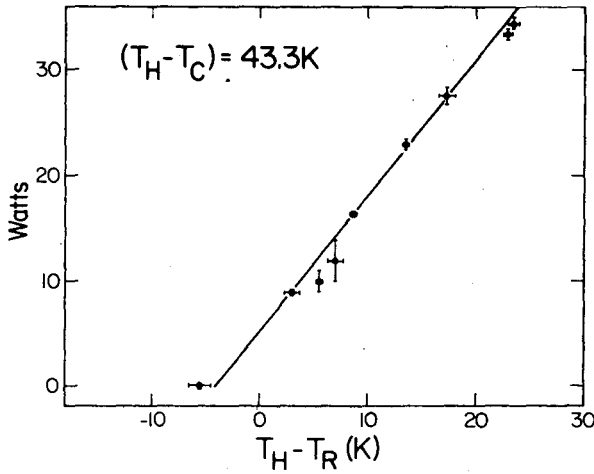

XBL 799-2915

Fig. 3. Determination of Hot Box Skin Loss. The total power into the hot box is plotted vs. $(T_H - T_R)$ for a fixed value of $(T_H - T_C)$ of 43.3 K. The straight line is a linear fit yielding a skin loss of $1.27 \pm .06$ W/K and a sample heat flow of 5 W. The sample is a large sheet of 15 cm rigid polyurethane foam.

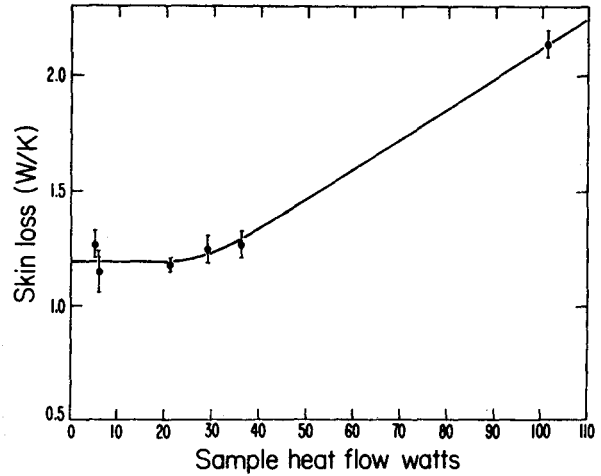

XBL 799-2913

Fig. 4. Variation of the Skin Loss Coefficient with Heat Flow through Sample.

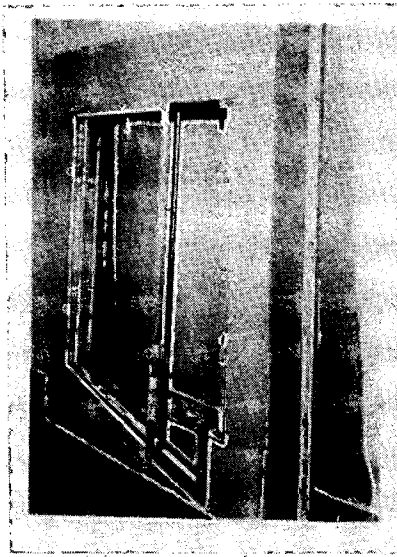

Fig. 5. The Prototype Window. Movable glass pane is swung out for visibility.

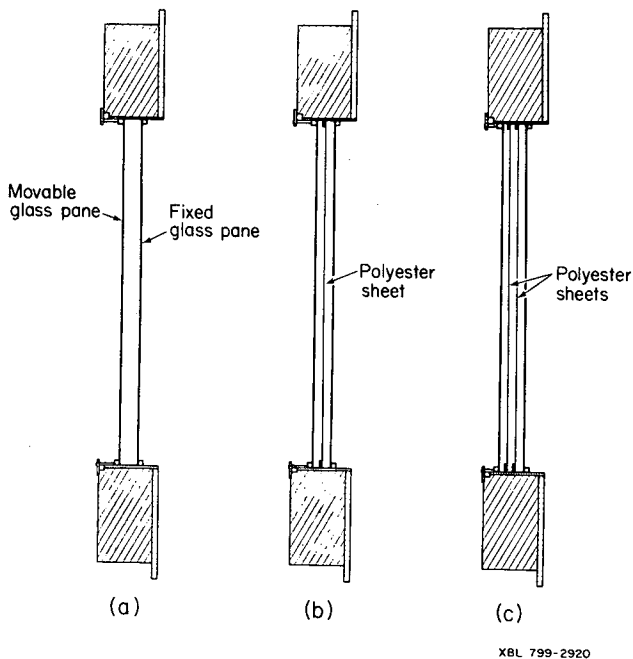

Fig. 6. Prototype Window Sections. (a) Double glazing with variable spacing. (b) With single plastic film. (c) With double plastic film. Equal air gaps were arranged for each spacing.

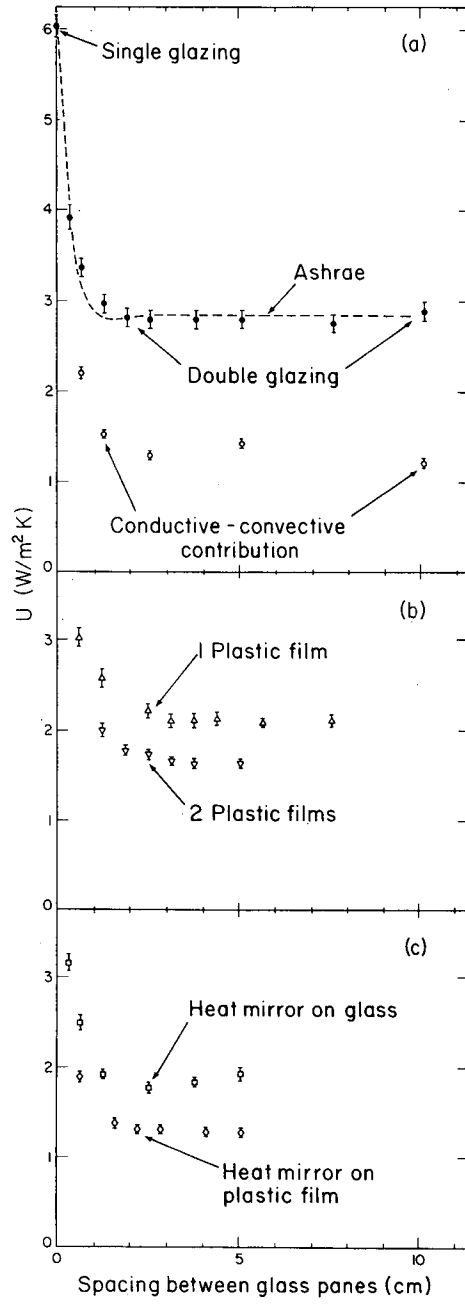

Fig. 7. Sample Thermal Transmittance vs. Glass Spacing for the Prototype Windows. (a) Ordinary double glazing (solid points) and double glazing with aluminum foil on inside of both glass panes (open circles). (b) Double glazing with one (triangles) or two (inverted triangles) plastic films. (c) Double glazing with heat mirror coating on plastic film, where the plastic film is mounted on the surface of one glass pane (squares) or suspended between panes (diamonds).

This report was done with support from the Department of Energy. Any conclusions or opinions expressed in this report represent solely those of the author(s) and not necessarily those of The Regents of the University of California, the Lawrence Berkeley Laboratory or the Department of Energy.

Reference to a company or product name does not imply approval or recommendation of the product by the University of California or the U.S. Department of Energy to the exclusion of others that may be suitable.

TECHNICAL INFORMATION DEPARTMENT
LAWRENCE BERKELEY LABORATORY
UNIVERSITY OF CALIFORNIA
BERKELEY, CALIFORNIA 94720