

UCLA

UCLA Previously Published Works

Title

A Flexible Implant for Multi-Day Monitoring of Colon Segment Activity.

Permalink

<https://escholarship.org/uc/item/7cp962bv>

Journal

IEEE Transactions on Biomedical Circuits and Systems, 17(5)

Authors

Majerus, Steve

Cabal, Dario

Hacohen, Yaneev

et al.

Publication Date

2023-10-01

DOI

10.1109/TBCAS.2023.3289768

Peer reviewed



HHS Public Access

Author manuscript

IEEE Trans Biomed Circuits Syst. Author manuscript; available in PMC 2024 November 21.

Published in final edited form as:

IEEE Trans Biomed Circuits Syst. 2023 October ; 17(5): 941–951. doi:10.1109/TBCAS.2023.3289768.

A Flexible Implant for Multi-Day Monitoring of Colon Segment Activity

Steve J.A Majerus [Senior Member, IEEE],

Dept. of Electrical, Computer, and Systems Engineering, Case Western Reserve University, OH, USA.

Louis Stokes Cleveland Veterans Affairs Medical Center, Cleveland, OH, USA.

Dario Cabal,

Dept. of Electrical, Computer, and Systems Engineering of Case Western Reserve University, Cleveland, USA.

Yaneev Hacoheh,

Dept. of Electrical, Computer, and Systems Engineering of Case Western Reserve University, Cleveland, USA.

Dept. of Biomedical Engineering of the Lerner Research Institute, Cleveland Clinic, Cleveland, OH, USA.

Brett Hanzlicek,

Louis Stokes Cleveland Veterans Affairs Medical Center, Cleveland, OH, USA.

Aref Smiley,

Louis Stokes Cleveland Veterans Affairs Medical Center, Cleveland, OH, USA

Yushan Wang,

Dept. of Bioengineering, California NanoSystems Institute, UCLA, Los Angeles, CA, USA.

Wentai Liu [Fellow, IEEE],

Dept. of Bioengineering, California NanoSystems Institute, UCLA, Los Angeles, CA, USA.

Muriel Larauche,

Vatche and Tamar Manoukian Division of Digestive Diseases, Department of Medicine, David Geffen School of Medicine, CURE: Digestive Diseases Research Center, Center for Neurobiology of Stress and Resilience, UCLA; Los Angeles, CA, USA.

Mulugeta Million,

Vatche and Tamar Manoukian Division of Digestive Diseases, Department of Medicine, David Geffen School of Medicine, CURE: Digestive Diseases Research Center, Center for Neurobiology of Stress and Resilience, UCLA; Los Angeles, CA, USA.

Margot S. Damaser [Senior Member, IEEE],

Louis Stokes Cleveland Veterans Affairs Medical Center, Cleveland, OH, USA.

Dept. of Biomedical Engineering of the Lerner Research Institute, Cleveland Clinic, Cleveland, OH, USA.

Dennis J. Bourbeau

MetroHealth Medical Center, Cleveland, OH, USA, and the Functional Electrical Stimulation Center, Louis Stokes Cleveland Veterans Affairs Medical Center, Cleveland, OH, USA.

Abstract

Monitoring of colon activity is currently limited to tethered systems like anorectal manometry. These systems have significant drawbacks, but fundamentally limit the observation time of colon activity, reducing the likelihood of detecting specific clinical events. While significant technological advancement has been directed to mobile sensor capsules, this work describes the development and feasibility of a stationary sensor for describing the coordinated activity between neighboring segments of the colon. Unlike wireless capsules, this device remains in position and measures propagating pressure waves and impedances between colon segments to describe activity and motility. This low-power, flexible, wireless sensor—the colon monitor to capture activity (ColoMOCA) was validated in situ and in vivo over seven days of implantation. The ColoMOCA diameter was similar to common endoscopes to allow for minimally invasive diagnostic placement. The ColoMOCA included two pressure sensors, and three impedance-sensing electrodes arranged to describe the differential pressures and motility between adjacent colon segments. To prevent damage after placement in the colon, the ColoMOCA was fabricated with a flexible polyimide circuit board and a silicone rubber housing. The resulting device was highly flexible and suitable for surgical attachment to the colon wall. In vivo testing performed in eleven animals demonstrated suitability of both short term (less than 3 hours) and 7-day implantations. Data collected wirelessly from animal experiments demonstrated the ColoMOCA described colon activity similarly to wired catheters and allowed untethered, conscious monitoring of organ behavior.

Keywords

Pressure sensor; implants; biomedical electrodes; biomedical electronics; wireless sensor; flexible electronics

I. Introduction

The mechanical and neurological mechanisms contributing to intractable chronic constipation and fecal incontinence are not yet fully understood, in part because of challenges in measuring the slow actions of the bowel. Because the bowel functions to move stools through the colon and is tightly coupled to autonomic nervous system functions, it is difficult to study in both animal and human models. Without versatile wireless systems, gut manometry measurement inevitably relies on either restraint of conscious animals or the use of anesthesia. Anesthetized animal research allows for precise instrumentation and nerve mapping studies, but the presence of anesthetics interferes with organ function, and the digestive-defecation process cannot be fully observed.

Continuous monitoring of colon activity during daily activities would be important for clinical diagnostics and for research studies that focus on understanding the mechanisms underlying bowel function or on evaluating interventions that alter bowel function [1], [2]. Colon manometry (Fig. 1A) monitors colon activity using a long catheter that is inserted into the colon and clipped in place. This tethered system remains in place for several hours and detects colonic pressure waves generated by adjoining segments of the colon.

Colon manometry, however, is poorly suited to measuring awake, continuous bowel activity during normal daily life. Clinically, colon manometry studies are typically performed after the colon is cleansed, and most manometry studies involve continuous fluid perfusion into the lumen. Both of these manipulations affect motility and function of the colon, and may obscure accurate measurements [3]–[5]. Further, colon catheter systems are typically tethered to a recording system, preventing normal movement, and limiting the monitoring duration to less than 24 hours in humans [2], [6] and preventing use in large animal research trials.

A similar approach to monitoring colon activity is by using endoscopically-placed sensors capable of multi-day monitoring from within the colon (Fig. 1B). Besides offering longer observation periods in the natural environment, wireless, flexible sensors residing within the colon could be placed without cleansing the organ and impacting the colonic milieu [7]. These sensors may be placed endoscopically (like colon manometry catheters) and provide useful information on colonic activity in both human and animal patients.

While this paper focuses on colonic activity monitoring (from a stationary location using a flexible device), much recent work has developed mobile sensor capsules which pass through the bowel. Sensor capsules, such as the Smart Pill, allow measurement of the transit time to various points in the GI tract using temperature, pH, and pressure sensors captured at a relatively low sample rate [8]. Imaging-based capsules wirelessly transmit low frame rate videos in addition to sensor data; both imaging and sensor-based approaches are currently used in clinical diagnosis [9]–[11]. Significant recent work in imaging capsule endoscopes has produced new form factors [12], [13] and incorporated non-optical imaging, like ultrasound, ultrasonic, fluorescent, and tactile sensing [14]–[16]. Further improvements to imaging capsule endoscopes have also added pH sensing [17].

Multi-sensor capsule examples have dual pressure sensors [18], [19] and/or a combination of single-channel sensors [20]–[22]. Wireless operation of sensor capsules relies on batteries, but recent work has demonstrated wireless powering [20], [23], [24] and even gastric acid battery powering [25]. Additionally, while wireless capsules in the bowel generally transit under colonic peristalsis, some recent developments suggest that untethered capsules could remain in the colon for extended periods by leveraging wireless battery recharge [26], and steerable designs [27].

For biology and neurophysiology research and clinical decision-making, however, colonic manometry is extremely useful, because it provides simultaneous pressure data from two regions of the colon with known location. This allows detection of propagative (peristalsis) vs. non-propagative contractions (non-propulsive segmentation contractions). Uncoordinated

activity in one region of the colon (as detected by pressure waves between sequential colon regions), is a common pathology [28]. Confirming which region of the colon truly has uncoordinated activity is important for deciding whether surgical removal of a section of colon is needed, or if other treatments are an option [1]. Mobile, capsule-based devices are not used for this purpose at present. The focus in this work was to develop a sensor which measured simultaneous pressure at two fixed locations, and which also could detect the changing local environment (stool volume, stool properties, etc).

The Colon Monitor to Capture Activity (ColoMOCA) was designed to provide colon activity data over several day from a fixed, known location in the colon (Fig 1). In this work, we demonstrated surgical implantation of the ColoMOCA and *in vivo* feasibility using suture attachment to the interior colon wall. However, because the device diameter is comparable to endoscopes, clinical use may be feasible with endoscopic fixation using mucosal clips.

II. Wireless Multi-Mode Colonic Activity Sensing

The ColoMOCA construction (Fig. 2) followed circuitry, experimental, and packaging constraints, which are discussed separately. To improve ambulatory monitoring, a wirelessly-rechargeable, battery-powered architecture was used. This enabled fully wireless monitoring on battery power, with the option for battery recharge during anesthetized or restrained session. To reduce implant diameter, relatively simple, low-power circuitry was developed to minimize the size of the implant battery, which was the largest single component. To improve biological and surgical outcomes, the ColoMOCA was designed to be flexible. Overall ColoMOCA length was selected to space the pressure sensors 63 mm apart to detect sequential regions of colonic activity and stool motility [29].

The ColoMOCA used a low-power microcontroller (Texas Instruments MSP430FR2433) to coordinate sensing and transmission. The implant was powered from a single 3-mAh battery (Seiko MS621FE) which was configured for wireless battery recharge. Circuitry was designed to either operate in sleep or active mode; in sleep mode, the microcontroller and all sensors were in a low-power state, while in active mode the device transmitted data every 100 ms (Table I).

A. Multi-sensor monitoring

We previously identified sensor modalities to measure colon fullness (volume), colon activity (contractions), and colon motility (movement of contents) [30], [31]. The ColoMOCA measured 8 values: pressure (from two adjacent colonic segments), impedance (from 3 overlapping regions), temperature (at the location of each pressure sensor) and device battery voltage. Temperature data were measured in order to correct for temperature-dependent pressure sensor offsets because sensors were calibrated at room temperature, and heated up after implantation *in vivo*. To save energy, temperature values were not transmitted (in the presented experiments) because the temperature variation at the fixed device location was expected to be minimal. However, research in microbiome composition may require temperature data, so a temperature transmission option was included for future work [32]. Data were transmitted simultaneously at 16-bit resolution at 10 Hz (Fig. 3A), i.e. each data transmission included the latest sample from all sensor channels.

Differential colonic segment pressures were measured with sensors (STMicro LPS33HWTR) placed 63 mm apart. Pressure data were sampled at 75 Hz, then filtered to 0.5-Hz bandwidth and truncated to 16-bit resolution. The large oversampling ratio of the pressure sensor performed two functions: it filtered rapid pressure changes caused by abdominal pressure activity (movement, vocalization) and it reduced the pressure sensor RMS noise. Data were filtered prior to transmission to enable a slower transmission rate or the need for pre-transmission compression. The filtered 0.5 Hz bandwidth was sufficient to detect segmental colon contractions, which occur over 7.5 – 30 seconds [33].

Stool impedance was measured along three paths (5, 15 and 20 mm) using active electrodes (E_1 - E_3) and a common anode (Fig. 2). Overlapping paths were used to ensure that the impedance measured from each electrode was relatively weighted against the others. Because stool is not homogeneous, this arrangement allowed detecting changing stool properties around the ColoMOCA, i.e. due to colonic motility.

Impedance was measured at 500 Hz [34] with each channel measured independently (Fig. 3B,C). In each measurement, one working electrode (E_1 - E_3) was driven by a 500-Hz square wave ($\phi_1 - \phi_3$) with amplitude V_{BAT} . Current flowed through the stool (Z_S), then into the AC-coupled common anode. A resistor divider biased the microcontroller ADC input at $V_{BAT}/2$ and was only enabled during electrode measurement so save power (ϕ_E). For each electrode, 16 cycles of the 500-Hz excitation were applied, and the peak-to-peak amplitude was calculated by sampling the signal at the peak/valley per cycle (ϕ_S). Amplitudes were accumulated over 16 cycles per electrode to produce a 16-bit measure of impedance using 12-bit ADC conversions.

Passive components (Fig. 3B) limited the stool-sensing test current and balanced the injected charge. Values used were $R_{1,2} = 2.6 \text{ k}\Omega$ and $C_1 = 10 \text{ }\mu\text{F}$ to limit the maximum current during measurement to 1.9 mA. Because stool composition and movement in the colon is slow, and to limit power consumption, impedance was measured only once every 6 seconds. Impedance sensing added about 30 μA current draw from the battery, under worst-case ($0 \text{ }\Omega$) stool impedance conditions.

B. Wireless activation and recharging

The ColoMOCA included a 9.5- μH coil resonating at 2.2 MHz for RF battery recharge. Energy was transferred to the implant from a power amplifier with a 16-cm diameter, 16- μH coil held near the skin surface. Received energy was rectified using a voltage doubler rectifier implemented with discrete diodes. While simple and inefficient, due to the low coupling coefficient of the inductive link due to implant depths greater than 10 cm, the additional loss in efficiency due to the simple charging circuit was negligible. An NMOS common-source amplifier sensed the rectified voltage and coupled it to the microcontroller, enabling detection of the RF envelope such that pulse-length coded commands could be transmitted to the implant. In the presented experiments, only a command to wirelessly wake up or go to sleep was implemented.

The ColoMOCA battery was trickle charged directly from the RF-DC rectifier output. Battery voltage was sensed every second using the internal microcontroller, by setting the

ADC reference to the battery voltage and measuring a fixed internal voltage reference. To protect from battery over-charge, the microcontroller shunted excess current by transmitting data continuously and by activating the DC bias pathway for electrode sensing (Fig. 3A). To protect over-discharge, the ColoMOCA went to sleep while the battery was below 2.0 V.

Between experiments, the ColoMOCA remained in a low-power, sleep state. Before each recording, the ColoMOCA was wirelessly activated by transmitting a 50-ms pulse of about 10 W peak power to activate the implanted ColoMOCA. After activation, the ColoMOCA continuously transmitted for 4 hours, or until receiving a sleep command. The sleep signal was transmitted to the ColoMOCA by activating the battery recharge field for at least 300 ms.

C. Wireless data transmission and reception

The ColoMOCA transmitted data using on-off-keying (OOK) modulation and a 4-MHz carrier. A 4-MHz radio channel was used because it has lower tissue absorption and loss compared to, e.g. 434 MHz, and allows for electrically small magnetic field antennas [35]. To reduce system power consumption and size, the 4 MHz carrier was derived by dividing the microcontroller internal clock, rather than relying on a frequency synthesizer or resonator. To avoid the need for a TX/RX switch and multiplexing, separate antennas were used for data transmission and wireless battery recharge.

The microcontroller directly drove the transmitting antennas, which were 2, 10- μ H inductors placed in series, along with one series and one parallel capacitor for resonant tuning. The dual antennas were oriented orthogonally to reduce directionality of the emitted magnetic field.

Data were transmitted in individual packets every 100 ms. Each packet consisted of a synchronization frame, an 8-bit header, and a 96-bit payload. The synchronization frame was a 136- μ s pulse of unmodulated carrier to prime the receiver for reception of the header and payload bits. The header included a '0101' feature used for reception-side clock synchronization. The payload consisted of 6, 16-bit values relaying pressure and impedance data from all sensors, along with battery voltage and device ID information. Data were transmitted as Manchester-encoded with an effective bit rate of 58 kbps.

D. Wireless data receiver radio

Data from the ColoMOCA were received by a small radio with an external magnetic antenna (Fig. 4). In preliminary animal studies, the radio and antenna were attached to a jacket or vest which the animal wore during data collection. The radio consisted of three circuit boards: a Main Board, BLE Board, and a Teensy 3.6 board (PJRC Electronics, Arduino). The Main Board (Fig. 4A) incorporated band selection filters, low-noise amplification, and a logarithmic amplifier to demodulate received signals. The BLE Board include a Bluetooth module (uBlox BMD-350) which forwarded received data to a remote laptop during experiments. Finally, the Teensy 3.6 board included an ARM Cortex M4F microprocessor. During data recording, the Teensy 3.6 decoded the transmitted Manchester-encoded data and parsed each sensor channel. All received data were timestamped and stored to a

microSD card. The packaged radio measured $44 \times 67 \times 25$ mm and used a rechargeable lithium-polymer battery for fully wireless data capture during animal studies.

III. Flexible Implant Fabrication

The bowel consists of smooth muscle which expands to accommodate contents, but also contracts to move stool, and is highly dynamic and flexible. Because the ColoMOCA is sutured to the organ, unlike mobile devices, it must flex and move with the tissue. To avoid damage to either the organ or the device, the ColoMOCA was developed to be soft and more flexible than stool, to move with the tissue similar to intestinal parasites. Without flexibility, colonic forces could perforate the organ, causing internal sepsis due to exfiltration of feces into the abdominal cavity.

A. ColoMOCA silicone packaging

The general structure of the ColoMOCA relied on a flexible polyimide (PI) circuit board encased in a silicone-gel and silicone package (Fig. 5). The overall sensor length was dictated by the need to place independent pressure sensors in separate colonic segments, requiring a spacing of at least 60 mm [8], and the use of solid silicone endcaps to hold sutures during implantation. As a result, the PI board was much longer than circuitry demanded; to improve flexibility and durability circuit sections were laid out in “islands” with spans of PI in between which acted as hinges. The islands were further rigidized by enclosing them in epoxy, preventing solder joint cracking when flexing after implant.

After solder assembly and function testing, encapsulation proceeded sequentially. Thixotropic epoxy (Loctite EA-121HP) was applied over all solder joints, encapsulating small, passive components (Fig. 5a). Stool sensing electrode wires were soldered to the board, and the board was loaded into a silicone tube with internal diameter of 6.35 mm and wall thickness of 0.8 mm. Holes in the tube aligned with pressure sensor chimneys (Fig. 5b). A solid silicone plug was formed at one end of the tube by injecting medical RTV silicone adhesive (Elkem MED-4300) into the tube and allowing it to cure.

The tube was then filled with silicone gel (Dow Corning Sylgard 527). Pressure sensors were also filled with silicone gel to the chimney top (Fig. 5c). Final encapsulation sealed the housing in a second solid silicone plug (Elkem MED-4300). Silicone membranes (Factor II A-103) were cast onto glass slides to a thickness of 50 μm . Circular membranes were punched out and adhered over each pressure sensor (Factor II A-103 silicone). The silicone membranes encapsulated the pressure sensors while introducing minimal damping and prevented damage from stool after implantation. The addition of silicone gel and silicone membrane encapsulation reduced pressure sensor sensitivity; sensor performance was therefore bench calibrated after encapsulation.

Pre-fabricated impedance-measuring ring electrodes were soldered in place (Fig. 6), and package feedthroughs were sealed with silicone (Factor II, A-103). Electrodes were formed from 316 stainless steel mesh (Alfa Aesar, 50 μm thick, with 36% open area). Sutures were placed through the solid endcaps during surgical implantation.

IV. Benchtop Performance Validation

A. Radio reception *in situ*

Radio bit error rate (BER) was validated by programming the ColoMOCA to transmit a simple sawtooth ramp in place of each of the 6 sensor channels. BER was calculated as the number of bits between received errors, and aggregated over 4 continuous hours. BER was characterized in both lab and animal facility settings, showing similar performance in either environment. Saline was used as a test media in the lab and swine cadavers were used in the animal facility. When transmitting through saline or tissue, data reception at 30 cm range showed a bit error rate (BER) of about 1.7×10^{-5} errors/bit transmitted. For 104 bits/transmission, and 10 transmissions/second, this BER produced an error approximately once per minute. BER increased when the antenna was placed in the worst magnetic orientation, showing a BER of 10^{-5} at 15 cm. Spurious data errors occurring due to BER in experiment recordings were corrected using a Hampel filter in Matlab.

B. ColoMOCA pressure validation

Prior to implantation, ColoMOCAs were tested on the bench in a water-filled pressure chamber. Reference pressure was recorded using a reference sensor (Deltran DPT-100) coupled to a data acquisition system (National Instruments CompactDAQ, NI-9218 module). ColoMOCA pressure data were wirelessly transmitted and received by the wearable radio system, which transferred data to a PC running National Instruments LabVIEW software. The LabVIEW software captured reference and ColoMOCA data simultaneously. Pressure ramps were generated by infusing and extracting water from the pressure chamber via a 60-cc syringe. The correlation coefficient and RMS error between reference pressure and ColoMOCA pressures was calculated and plotted in MATLAB (Fig. 7). ColoMOCA sensors showed excellent agreement with the reference pressure, with about 1.3 cmH₂O RMS error on a range of 0–200 cmH₂O.

C. ColoMOCA impedance validation

Similarly, ColoMOCAs were bench-tested for impedance sensing performance. Discrete resistances of 10 Ω – 10 M Ω were measured, along with open- and short-circuit conditions (Fig. 8). Optimal measurement sensitivity was in the 1 k Ω – 10 M Ω range, but resistance down to 10 Ω was still measurable under ideal bench conditions. *In vitro* testing was performed using artificial stool which was formulated to simulate a range of stool viscosities from liquid to solid. Solid artificial stool consisted of dehydrated potato flakes (25 wt%), oat bran (50 wt%), and 0.5% saline (25 wt%). Liquid artificial stool consisted of dehydrated potato flakes (20 wt%), oat bran (40 wt%), and 0.5% saline (40 wt%). Stools were applied around the ColoMOCA within a 60 cc syringe body to simulate the dimensions of the large colon (Fig. 8). Additionally, saline in concentrations of 0.5 – 3.5% was also added to demonstrate liquid detection. Sensing electrodes indicated detection of stool composition between solid (partial and full coverage) and liquid stool. Bench results suggested the impedance sensor could detect changing stool properties due to motility.

V. In Vivo Demonstration

A total of 11 ColoMOCAs were implanted, and 2 tested acutely (inserted and then removed) *in vivo*. Experiments were performed at two sites (University of California Los Angeles and Cleveland Clinic). All experimental procedures followed protocols approved by the Institutional Animal Care and Use Committee at each site. Survival implantations were done with 9 adult Yucatan minipigs (weight 20–25 kg). Two animals received dual ColoMOCAs placed 20 cm apart in the colon. For acute testing, ColoMOCAs were inserted via colon stoma alongside reference micro-tip catheters in 2 adult Yucatan minipigs (weight approximately 50 kg; Fig. 9A).

A. ColoMOCA survival implantations

For 7-day survival implantations, under isoflurane anesthesia, a laparotomy was performed to expose the large intestine. ColoMOCAs were fed through a 1-cm incision in the colon and sutured to the colon wall by passing a suture through the solid silicone endcaps of the device. The bowel, abdominal wall, and skin incisions were then closed in layers using sutures and dermal staples.

In vivo daily data recording sessions of up to 2 hours of colonic activity began the following day after implantation. Colonic pressures and electrode readings were made with animals fully conscious and untethered. Data were received by a wireless radio unit which was attached to a jacket worn by the animal. The radio recorded data to an onboard SD card and forwarded data over Bluetooth to a nearby computer that plotted data in real time. During data recording the animal was given food and able to walk, urinate, and defecate freely. Animals carried the ColoMOCA implant for seven days. ColoMOCAs were then explanted in a terminal surgery under isoflurane anesthesia. Imaging performed during the initial and terminal surgery validated device position, including functional bending to conform to the bowel structure.

B. ColoMOCA acute insertions

The primary objective in acute experiments was to demonstrate the *in vivo* correlation between wired, micro-tip catheter sensors (R_{PROX} and R_{DIST}) and ColoMOCA pressure sensors (C_{PROX} and C_{DIST}). To support acute insertions, animals were fitted with a cecal cannula/stoma under surgical anesthesia. After 2–4 weeks of recovery and continued acclimation to the cart and personnel, a ColoMOCA and manometric probes (4 probes, 2 of which were aligned with the ColoMOCA pressure sensors, R_{PROX} and R_{DIST} Fig. 9B) were inserted into the proximal colon through the cecal cannula. The most distal sensor was positioned at ~20 cm distal to the ceco-colic junction and tethered to stay in position for the recording period. The manometric probes used were flexible solid-state probes (Mikro-Cath, Millar Inc., Houston, TX) [36]. Each micro-tip catheter signal was acquired (Micro1401 Cambridge Electronic Design, Cambridge, UK) at 100 samples/s. The system was calibrated at the start of each experiment.

The ColoMOCA was tied to a bundle of micro-tip pressure catheters placed at 3-cm intervals along the length of the device. The instrumentation bundle was inserted into

the colon via the cecal stoma for recording. Data were transmitted wirelessly from the ColoMOCA after insertion for approximately 30–40 minutes in each session, and then the catheters and ColoMOCA were removed. Data recordings were performed in 3 sessions per animal.

C. In vivo data analysis

Acute recordings, which included reference micro-tip pressure sensors for comparison, were analyzed quantitatively in MATLAB r2020. Pressure data from reference catheters (R_{PROX} and R_{DIST}) and ColoMOCA (C_{PROX} and C_{DIST}) were analyzed independently. Pressure data were lowpass filtered at 5 Hz, then peaks were identified using the MATLAB *findpeaks* function. The amplitude, duration, and periods between rhythmic peaks in colonic pressure waveforms were calculated. Periods between peaks were used to evaluate contraction frequency. Contraction frequency from ColoMOCA and micro-tip catheters was compared to assess accuracy of wireless monitoring in the colon. Statistical analysis between extracted contraction information from all sensors was performed in JASP. Differences in outcomes measured by all sensors were compared using ANOVA with Kruskal-Wallis nonparametric test, and Tukey post-hoc group comparison.

Data from implanted animals were quantitatively summarized as above, and qualitatively compared to animal behavior. In all cases, due to the lack of reference sensors for measuring bowel contents, electrode data were qualitatively analyzed based on prior reports of colonic motility [6].

VI. In Vivo Characterization of Bowel Activity

A. Acute colonic activity in conscious animals

A total of 100 minutes of ColoMOCA data with concomitant micro-tip catheter measurements were obtained in the acute experiments. Four sensors were measured simultaneously: Micro-tip catheter sensors (R_{PROX} , R_{DIST}) and ColoMOCA sensors (C_{PROX} , C_{DIST}). Sensors were located proximally in the colon relative to sensors located approximately 6 cm distally.

A similar number of contractions were identified by all sensors (range 214–276). Median contraction periods and durations were similar for all sensors (Table II). Contraction amplitude differed by location, i.e., distally-measured pressures overall were lower, regardless of sensor type (Table II).

Contraction summary data from ColoMOCA and micro-tip catheters agreed (Table II). However, all pressure sensors showed time-domain differences, with low-to-moderate overall correlation ($r = [0.04 \ 0.57]$ and $r = [-0.02 \ 0.55]$ for proximal/distal sensor pairs, and $r = [0.01 \ 0.25]$ for micro-tip catheters and $r = [0.02 \ 0.26]$ for ColoMOCA sensors). This was unexpected within a single section of colon, and was possibly caused by the localized forces exerted by stool.

B. Multi-day, ambulatory, conscious colonic monitoring

In the 7-day study, all but one animal showed rapid recovery from surgery, returning to normal movement within 24 hours. One animal died in post-surgery recovery due to anesthetic reasons unrelated to ColoMOCA function. No animals showed signs of distress with the ColoMOCA implanted. All but one of the implanted ColoMOCAs remained patent and did not obstruct stool for 7 days of implantation; one device was evacuated between 3 and 5 days post-implant after the suture holding it in the colon snapped.

Implanted ColoMOCAs functioned for up to 7 days (Fig. 11). The average functional time was 4.2 days (range [1–7] days). Two devices failed to transmit data after one day of implant for unknown reasons. One device transmitted data with reduced range (possibly due to antenna damage), demonstrating function over 7 days, but did not produce useful data.

Over 60 hours of ambulatory, catheter-free colon pressure data from ColoMOCAs were collected (Fig. 12). To compare against the acute recordings, data were analyzed in aggregate from the 11 implanted devices, isolating over 44,000 recorded contractions. Freely-moving animals demonstrated regular colonic activity with similar median contraction period and duration compared to acutely-monitored animals in sling restraint (Table II) (data presented as median and [interquartile range]). As in the acute case, implanted sensors showed a significant difference in contraction amplitudes between proximal and distal sensors (Table II). A full analysis of data recorded in chronic animals is beyond the scope of this work, however, pooled contraction parameters (duration, period, and amplitude) agree with prior measures of peristaltic contractions obtained from animals using catheter-based tools [6], [28], [29]. This suggests that wireless ColoMOCA monitoring can provide useful measures of bowel physiology without restraint or anesthesia.

Impedance measurements in conscious animals were qualitatively analyzed due to both the novelty of this sensor modality and lack of reference sensor. All recordings demonstrated periods of rhythmic impedance changes, followed by irregular, larger amplitude changes in impedance (Fig. 12). Rhythmic slow waves had a period of approximately 1–3 minutes, which is consistent with previous reports on colonic propagating sequences [23]. This result suggested that the ColoMOCA impedance sensing electrodes can detect stool movement, however, further validation studies are needed.

VII. Discussion

The pig colon motility pattern is characterized by the presence of multiple phasic contraction frequencies and mixed motility patterns [8], [22]. In line with this, in the acute study, both ColoMOCA and the conventional manometry approach detected pig colon phasic contractions that varied in frequency and amplitude. Interestingly, the number of phasic contractions identified, the waveform of luminal pressure changes, and the median duration and interval of contraction detected at both proximal and distal sensor positions of the proximal colon were highly comparable between the reference and ColoMOCA devices, suggesting a strong validity of ColoMOCA in detecting colon phasic luminal pressure changes in pigs.

Electrode test current during impedance measurement used a 500-Hz waveform which is shown to have little neuromodulatory effect in colonic tissue or nearby nerves [37], [38]. The maximum electrode current of 1.9 mA was limited by resistors, and is below levels described in previous reports on colon research [38]. Stimulus current was charge-balanced to prevent generation of oxidative species or tissue degradation.

7-day ColoMOCA implantations were limited to 10 devices in 8 animals. In the chronic study, ColoMOCAs functioned normally, despite the changing colon environment due to feeding, diurnal variations in secretion and motility, in microbial population, bowel movement, etc. ColoMOCA has comparable physical features to an ideal healthy stool (type 4 stool [39]) because it is smooth, soft, and has a snake-like shape, which may have improved its functionality *in vivo*. As a result, animals with implanted ColoMOCAs passed stools and exhibited no behavioral changes with the device in place. Due to the limited implantation time, and use of animal model, we cannot determine if the presence of the device was felt or would be discomforting to humans.

The ColoMOCA packaging was both flexible and stretchable, but the PI circuit substrate and copper traces could not be strained more than about 4% [40]. Because the packaging used soft silicone gel, the PI circuit was not constrained to the neutral axis, which limited the ultimate radius of curvature for device flexibility. This likely also contributed to early device failures. Two devices failed after one day, possibly due to cracked traces in the circuit due to repeated bending during and after implant. All but one device remained implanted in the colon for 7 days, which suggests that multi-day monitoring is feasible with an indwelling, flexible, wireless sensor. Even three days of monitoring would greatly expand the window of observation compared to existing catheter systems.

Significant technical work in ingestible sensor capsules informed our strategy with the ColoMOCA device. Compared to existing devices with published *in vivo* data in Table III, the ColoMOCA is longer, thinner, flexible, and has roughly double the number of sensors. This is by design – because the ColoMOCA records from a fixed location, pressure sensors are spaced to reside in different segments of the colon. Simultaneous pressure measurements are also collected at a relatively high sample rate of 10 Hz to capture full contraction waveforms, such that the direction of pressure waves (ascending or descending) can be determined. Also, unlike mobile sensor capsules which use pH and temperature sensing to detect motility via movement along with stools, the ColoMOCA used overlapping regional impedance sensors to assess changing impedance in the relative environment. While not a focus of this study, this sensing method could be expanded, for example, to use cyclic voltammetry or dielectric impedance spectroscopy for chemical or protein detection.

Rather than swallowable capsules, the ColoMOCA was intended to be placed transrectally. Translation to human testing could use a colonoscope or similar device for placement of the sensor within the colon. Modern “ultraslim” colonoscopes measure 9.7 mm in diameter, compared with 8 mm for ColoMOCA [41]. In the presented non-human studies, the device did not occlude or damage the organ while implanted, however, this is a potential concern that will require careful testing when considering human use.

The ColoMOCA was 25% thinner than many mobile sensor capsules to enable endoscopic placement (Table III). The ColoMOCA may be placed within the bowel using mucosal clips, which allow for several days of attachment. To enhance insertion feasibility in human testing, the diameter of the ColoMOCA may be further reduced by using a smaller battery. While wireless charging was not used in presented animal studies, it is more feasible in human patients. Further power reduction can be achieved using a variable sample rate, monitoring for intermittent periods throughout the day, or by designing a custom integrated circuit for sensor interfacing and data communication.

VIII. Conclusion

Wireless sensors like ColoMOCA may be implanted in the colon to enable multi-day, multi-sensor monitoring for neurophysiology research. ColoMOCA not only supports multiple sensing modalities, it combines important features of manometry and ingestible capsule into one. Specifically, unlike ingestible pills, it enables simultaneous pressure sensing at different colon sites (2 sites, at 6 cm apart) and unlike standard stationary manometry, ColoMOCA can enable ambulatory monitoring in the natural environment. Initial feasibility demonstration suggested that ColoMOCA detected colon phasic luminal pressure changes in pigs comparably to wired, micro-tip catheters. Continuous monitoring of bowel activity during daily activities would improve clinical diagnostics and understanding the mechanisms underlying bowel function or help validate interventions that modulate bowel activity.

Acknowledgments

This work was funded by NIH grant numbers OT2OD023873 and OT2OD024899. The contents do not represent the views of the US Dept. of Veterans Affairs.

References

- [1]. Van Den Berg MM, Hogan M, Caniano DA, Di Lorenzo C, Benninga MA, and Mousa HM, "Colonic manometry as predictor of cecostomy success in children with defecation disorders," *J. Pediatr. Surg.*, vol. 41, no. 4, 2006, doi: 10.1016/j.jpedsurg.2005.12.018.
- [2]. Hagger R, Kumar D, Benson M, and Grundy A, "Periodic colonic motor activity identified by 24-h pancolonic ambulatory manometry in humans," *Neurogastroenterol. Motil.*, vol. 14, no. 3, 2002, doi: 10.1046/j.1365-2982.2002.00331.x.
- [3]. Sloots CEJ and Felt-Bersma RJF, "Effect of bowel cleansing on colonic transit in constipation due to slow transit or evacuation disorder," *Neurogastroenterol. Motil.*, vol. 14, no. 1, 2002, doi: 10.1046/j.1365-2982.2002.00304.x.
- [4]. Bampton PA, Dinning PG, Kennedy ML, Lubowski DZ, and Cook IJ, "Prolonged multi-point recording of colonic manometry in the unprepared human colon: providing insight into potentially relevant pressure wave parameters," *Am. J. Gastroenterol.*, vol. 96, no. 6, 2001, doi: 10.1111/j.1572-0241.2001.03924.x.
- [5]. Sarna SK, "Effect of fluid perfusion and cleansing on canine colonic motor activity," *Am. J. Physiol. - Gastrointest. Liver Physiol.*, vol. 262, no. 1 25-1, 1992, doi: 10.1152/ajpgi.1992.262.1.g62.
- [6]. Bampton PA and Dinning PG, "High Resolution Colonic Manometry-What Have We Learnt-a Review of the Literature 2012," *Curr. Gastroenterol. Rep.*, vol. 15, p. 328, 2013, doi: 10.1007/s11894-013-0328-2.

- [7]. Anitha M, Vijay-Kumar M, Sitaraman SV, Gewirtz AT, and Srinivasan S, “Gut microbial products regulate murine gastrointestinal motility via toll-like receptor 4 signaling,” *Gastroenterology*, vol. 143, no. 4, 2012, doi: 10.1053/j.gastro.2012.06.034.
- [8]. Maqbool S, Parkman HP, and FriedenberG FK, “Wireless capsule motility: Comparison of the smartPill® GI monitoring system with scintigraphy for measuring whole gut transit,” *Dig. Dis. Sci*, vol. 54, no. 10, 2009, doi: 10.1007/s10620-009-0899-9.
- [9]. Hasler WL, “The use of SmartPill for gastric monitoring,” *Expert Rev. Gastroenterol. Hepatol*, vol. 8, no. 6, 2014, doi: 10.1586/17474124.2014.922869.
- [10]. Xavier S, Monteiro S, Magalhães J, Rosa B, Moreira MJ, and Cotter J, “Capsule endoscopy with PillCamSB2 versus PillCamSB3: has the improvement in technology resulted in a step forward?,” *Rev. Espanola Enfermedades Dig. Organo Of. Soc. Espanola Patol. Dig*, vol. 110, no. 3, pp. 155–159, Mar. 2018, doi: 10.17235/reed.2017.5071/2017.
- [11]. Diaz Tartera HO et al. , “Validation of SmartPill® wireless motility capsule for gastrointestinal transit time: Intra-subject variability, software accuracy and comparison with video capsule endoscopy,” *Neurogastroenterol. Motil*, vol. 29, no. 10, 2017, doi: 10.1111/nmo.13107.
- [12]. Fontana R et al. , “An Innovative Wireless Endoscopic Capsule With Spherical Shape,” *IEEE Trans. Biomed. Circuits Syst*, vol. 11, no. 1, pp. 143–152, Feb. 2017, doi: 10.1109/TBCAS.2016.2560800. [PubMed: 27362990]
- [13]. Alsunaydih FN, Arefin MS, Redoute J-M, and Yuce MR, “A Navigation and Pressure Monitoring System Toward Autonomous Wireless Capsule Endoscopy,” *IEEE Sens. J*, vol. 20, no. 14, pp. 8098–8107, Jul. 2020, doi: 10.1109/JSEN.2020.2979513.
- [14]. Winstone B, Melhuish C, Pipe T, Callaway M, and Dogramadzi S, “Toward Bio-Inspired Tactile Sensing Capsule Endoscopy for Detection of Submucosal Tumors,” *IEEE Sens. J*, vol. 17, no. 3, pp. 848–857, Feb. 2017, doi: 10.1109/JSEN.2016.2627798.
- [15]. Demosthenous P, Pitris C, and Georgiou J, “Infrared Fluorescence-Based Cancer Screening Capsule for the Small Intestine,” *IEEE Trans. Biomed. Circuits Syst*, vol. 10, no. 2, pp. 467–476, Apr. 2016, doi: 10.1109/TBCAS.2015.2449277. [PubMed: 26302520]
- [16]. Wang X et al. , “Development of a mechanical scanning device with high-frequency ultrasound transducer for ultrasonic capsule endoscopy,” *IEEE Trans. Med. Imaging*, vol. 36, no. 9, pp. 1922–1929, Sep. 2017, doi: 10.1109/TMI.2017.2699973. [PubMed: 28475050]
- [17]. Karargyris A and Koulaouzidis A, “OdoCapsule: Next-Generation Wireless Capsule Endoscopy With Accurate Lesion Localization and Video Stabilization Capabilities,” *IEEE Trans. Biomed. Eng*, vol. 62, no. 1, pp. 352–360, Jan. 2015, doi: 10.1109/TBME.2014.2352493. [PubMed: 25167544]
- [18]. Li P, Kreikemeier-Bower C, Xie W, Kothari V, and Terry BS, “Design of a Wireless Medical Capsule for Measuring the Contact Pressure Between a Capsule and the Small Intestine,” *J. Biomech. Eng*, vol. 139, no. 5, Mar. 2017, doi: 10.1115/1.4036260.
- [19]. Li P, Kothari V, and Terry BS, “Design and Preliminary Experimental Investigation of a Capsule for Measuring the Small Intestine Contraction Pressure,” *IEEE Trans. Biomed. Eng*, vol. 62, no. 11, pp. 2702–2708, Nov. 2015, doi: 10.1109/TBME.2015.2444406. [PubMed: 26080374]
- [20]. Cao H et al. , “An Implantable, Batteryless, and Wireless Capsule With Integrated Impedance and pH Sensors for Gastroesophageal Reflux Monitoring,” *IEEE Trans. Biomed. Eng*, vol. 59, no. 11, pp. 3131–3139, Nov. 2012, doi: 10.1109/TBME.2012.2214773. [PubMed: 22922690]
- [21]. Lu L, Yan G, and Sun J, “A study of human colonic motility in healthy and constipated subjects using the wireless capsule,” *Comput. Biol. Med*, vol. 65, pp. 269–278, Oct. 2015, doi: 10.1016/j.compbiomed.2015.07.011. [PubMed: 26238703]
- [22]. Zhao K, Yan G, Lu L, and Xu F, “Low-Power Wireless Electronic Capsule for Long-Term Gastrointestinal Monitoring,” *J. Med. Syst*, vol. 39, no. 2, p. 9, Jan. 2015, doi: 10.1007/s10916-015-0211-9. [PubMed: 25631843]
- [23]. Iqbal A, Al-Hasan M, Mabrouk IB, and Denidni TA, “Wireless Powering and Telemetry of Deep-Body Ingestible Bioelectronic Capsule,” *IEEE Trans. Antennas Propag*, vol. 70, no. 10, pp. 9819–9830, Oct. 2022, doi: 10.1109/TAP.2022.3184549.

- [24]. Shao G and Guo Y-X, "Hybrid Wireless Positioning and Charging With Switched Field Helmholtz Coils for Wireless Capsule Endoscopy," *IEEE Trans. Microw. Theory Tech*, vol. 68, no. 3, pp. 904–913, Mar. 2020, doi: 10.1109/TMTT.2019.2959762.
- [25]. Yoshida S, Miyaguchi H, and Nakamura T, "Development of Ingestible Thermometer With Built-in Coil Antenna Charged by Gastric Acid Battery and Demonstration of Long-Time in Vivo Telemetry," *IEEE Access*, vol. 9, pp. 102368–102377, 2021, doi: 10.1109/ACCESS.2021.3098333.
- [26]. Chen W et al. , "Wireless powered capsule endoscopy for colon diagnosis and treatment," *Physiol. Meas.*, vol. 34, no. 11, pp. 1545–1561, Nov. 2013, doi: 10.1088/0967-3334/34/11/1545. [PubMed: 24149981]
- [27]. Woo SH, Kim TW, Mohy-Ud-Din Z, Park IY, and Cho J-H, "Small intestinal model for electrically propelled capsule endoscopy," *Biomed. Eng. OnLine*, vol. 10, no. 1, p. 108, Dec. 2011, doi: 10.1186/1475-925X-10-108. [PubMed: 22177218]
- [28]. Dinning PG, "Colonic Manometry: What Do the Squiggly Lines Really Tell Us?," in *New Advances in Gastrointestinal Motility Research*, Cheng LK, Pullan AJ, and Farrugia G, Eds., in *Lecture Notes in Computational Vision and Biomechanics*. Dordrecht: Springer Netherlands, 2013, pp. 197–217. doi: 10.1007/978-94-007-6561-0_11.
- [29]. Mcorrie J, Greenwood-Van Meerveld B, and Rudolph C, "Characterization of propagating contractions in proximal colon of ambulatory mini pigs," *Dig. Dis. Sci.*, vol. 43, no. 5, 1998, doi: 10.1023/A:1018810230010.
- [30]. Smiley A, Majerus SJA, McAdams IS, Hanzlicek B, Bourbeau D, and Damaser MS, "Sensors Selection for Continuous Monitoring of Bowel State and Activity," in *Proceedings of the Annual International Conference of the IEEE Engineering in Medicine and Biology Society, EMBS, 2018*, pp. 2997–3000. doi: 10.1109/EMBC.2018.8512948.
- [31]. Panda B et al. , "SPARC: Wireless, Continuous Monitoring of Bowel State and Function," *FASEB J*, vol. 34, no. S1, 2020, doi: 10.1096/fasebj.2020.34.s1.09200.
- [32]. Sepulveda J and Moeller AH, "The Effects of Temperature on Animal Gut Microbiomes," *Front. Microbiol.*, vol. 11, p. 384, Mar. 2020, doi: 10.3389/fmicb.2020.00384. [PubMed: 32210948]
- [33]. Li Y-W, Yu Y-J, Fei F, Zheng M-Y, and Zhang S-W, "High-resolution colonic manometry and its clinical application in patients with colonic dysmotility: A review," *World J. Clin. Cases*, vol. 7, no. 18, pp. 2675–2686, Sep. 2019, doi: 10.12998/wjcc.v7.i18.2675. [PubMed: 31616684]
- [34]. McAdams I, Kenyon H, Bourbeau D, Damaser MS, Zorman C, and Majerus SJA, "Low-cost, Implantable Wireless Sensor Platform for Neuromodulation Research," in *IEEE Biomedical Circuits and Systems Conference, 2018*. doi: 10.1109/BIOCAS.2018.8584729.
- [35]. Majerus S and Garveriek SL, "Telemetry platform for deeply implanted biomedical sensors," in *Proceedings of INSS 2008 – 5th International Conference on Networked Sensing Systems, 2008*, pp. 87–92. doi: 10.1109/INSS.2008.4610903.
- [36]. Larauche M et al. , "The effect of colonic tissue electrical stimulation and celiac branch of the abdominal vagus nerve neuromodulation on colonic motility in anesthetized pigs," *Neurogastroenterol. Motil.*, vol. 32, no. 11, 2020, doi: 10.1111/nmo.13925.
- [37]. Spencer NJ and Hu H, "Enteric nervous system: sensory transduction, neural circuits and gastrointestinal motility," *Nat. Rev. Gastroenterol. Hepatol.*, vol. 17, no. 6, pp. 338–351, Jun. 2020, doi: 10.1038/s41575-020-0271-2. [PubMed: 32152479]
- [38]. Huang Z, Li S, Foreman RD, Yin J, Dai N, and Chen JDZ, "Sacral nerve stimulation with appropriate parameters improves constipation in rats by enhancing colon motility mediated via the autonomic-cholinergic mechanisms," *Am. J. Physiol. - Gastrointest. Liver Physiol.*, vol. 317, no. 5, pp. G609–G617, Nov. 2019, doi: 10.1152/ajpgi.00150.2018. [PubMed: 31411502]
- [39]. Shokouhi N, Mohammadi S, Ghanbari Z, and Montazeri A, "Development of a new version of the Bristol Stool Form Scale: translation, content validity, face validity, and reliability of the Persian version," *BMJ Open Gastroenterol.*, vol. 9, no. 1, p. e001017, Dec. 2022, doi: 10.1136/bmjgast-2022-001017.
- [40]. Hsu PI, Huang M, Xi Z, Wagner S, Suo Z, and Sturm JC, "Spherical deformation of compliant substrates with semiconductor device islands," *J. Appl. Phys.*, vol. 95, no. 2, pp. 705–712, Jan. 2004, doi: 10.1063/1.1634370.

- [41]. Essrani R, Hickey P, and Shah H, "Initial Experience of a Community Gastroenterology Practice with Ultrasonography," *Cureus*, vol. 11, no. 5, p. e4663, doi: 10.7759/cureus.4663. [PubMed: 31316878]

Author Manuscript

Author Manuscript

Author Manuscript

Author Manuscript

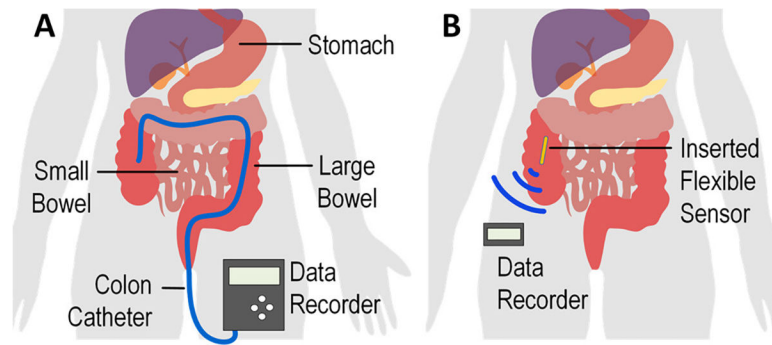

Fig. 1. Colonic manometry uses a long catheter inserted through the bowel to record correlated colonic pressure waves between segments (A). The catheter limits monitoring during daily activities, and only permits short observations of colon activity. Flexible, wireless sensors may be temporarily inserted with a similar approach (B) allowing for several days of monitoring.

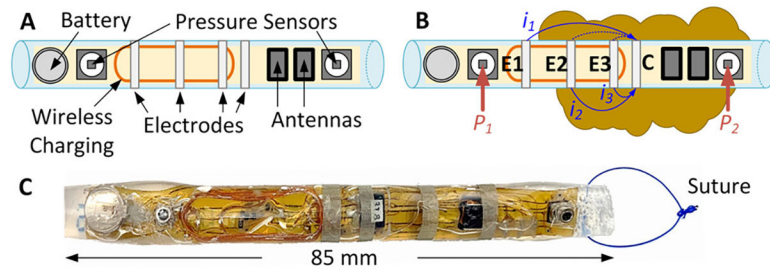

Fig. 2.

The ColoMOCA (A) included two pressure sensors ($P_{1,2}$) spaced to reside within separate colonic segments and conductance-measuring electrodes (E_{1-3}). (B) Sensed currents (i_1 , i_2 , and i_3) flowing from electrodes E_{1-3} revealed differences in stool impedance in different regions, enabling detection of stool motility and composition. (C) The ColoMOCA included solid silicone endcaps to hold sutures for implantation.

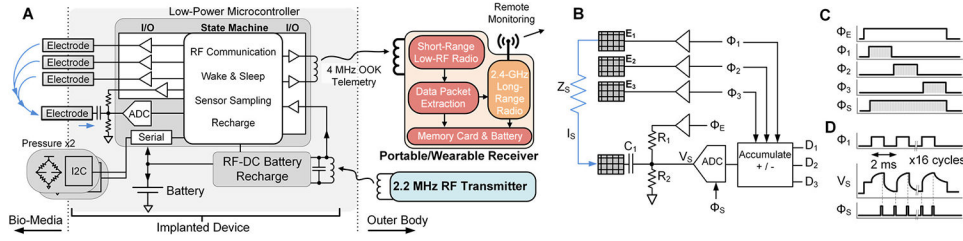

Fig. 3.

The ColoMOCA implant consisted of a low-power microcontroller communicating with external pressure sensors and stainless-steel electrodes (A). Stool impedance in overlapping regions was determined by energizing spaced electrodes with a common anode, and measuring the peak-to-peak current amplitude (B). During impedance sensing each electrode (E_1 - E_3) was separately driven by a 500-Hz square wave (C). The received voltage at the ADC (proportional to stool impedance, Z_S) was accumulated by ADC samples over 16 waveform cycles (D) to produce digitized values for each impedance segment (D_1 - D_3).

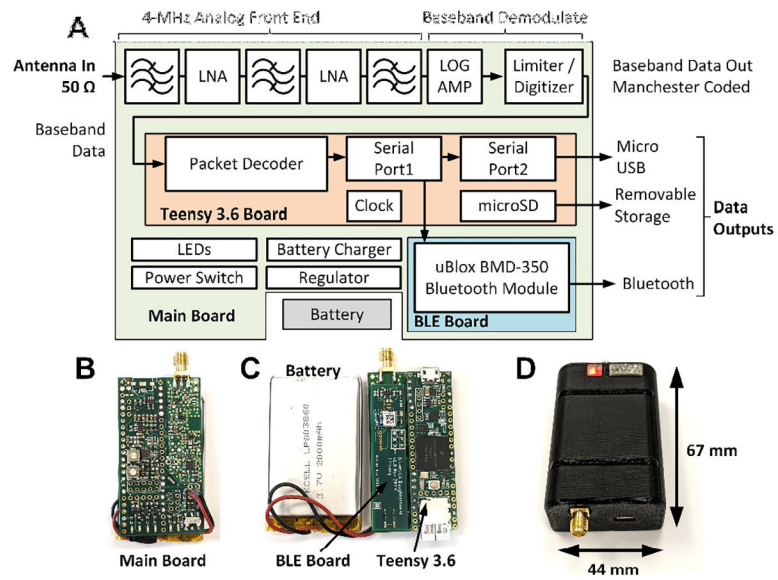

Fig. 4. The ColoMOCA data receiver used an analog OOK frontend with a digital backend for packet decoding, Teensy 3.6, and Bluetooth board (A-C). The radio used for *in vivo* recordings measured $44 \times 67 \times 23$ mm (D).

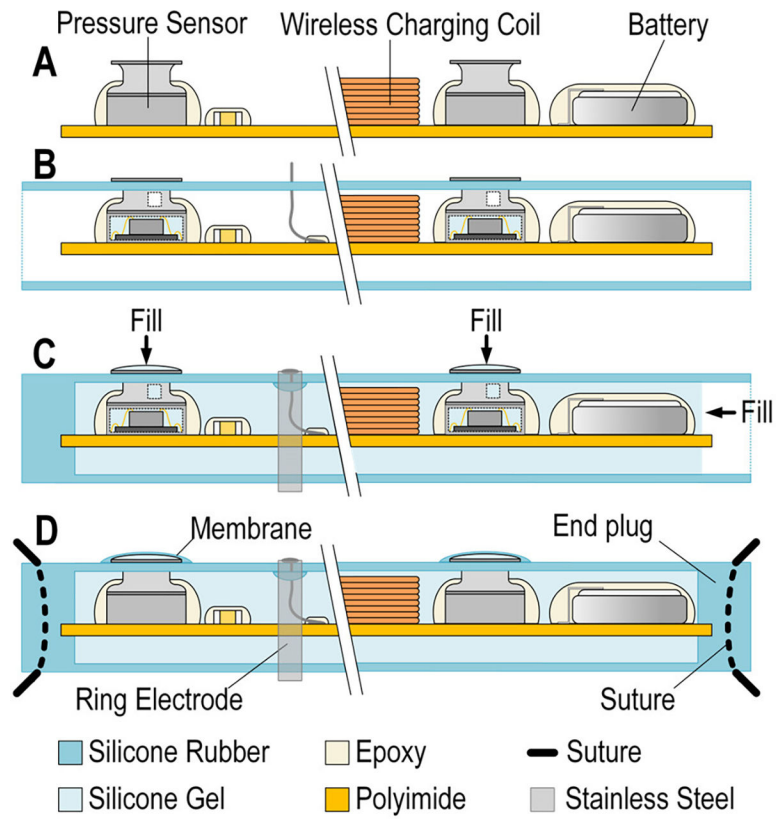

Fig. 5. ColoMOCA encapsulation: (A) epoxy coating of solder joints, (B) substrate placement within silicone tube, (C) silicone gel filling, and (D) final silicone encapsulation of exposed gel and silicone tube sealing.

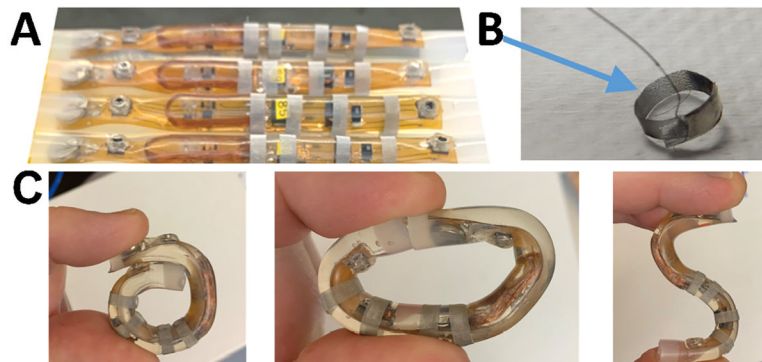

Fig. 6. Encapsulated ColoMOCAs (A) used pre-fabricated stainless-steel mesh electrode rings (B) sized to the nominal silicone housing diameter. Finished ColoMOCAs were flexible to move with the bowel after implantation (C).

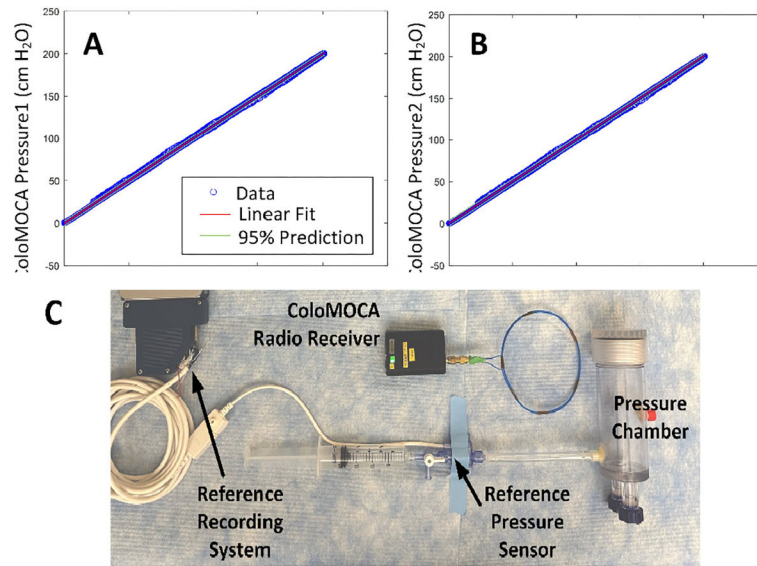

Fig. 7. Simultaneous bench calibration of ColoMOCA pressure sensors showed a nominal error of 1.3 cm H₂O RMS (A-B). Sensors were calibrated before implant in a pressure chamber with a connected reference sensor (C).

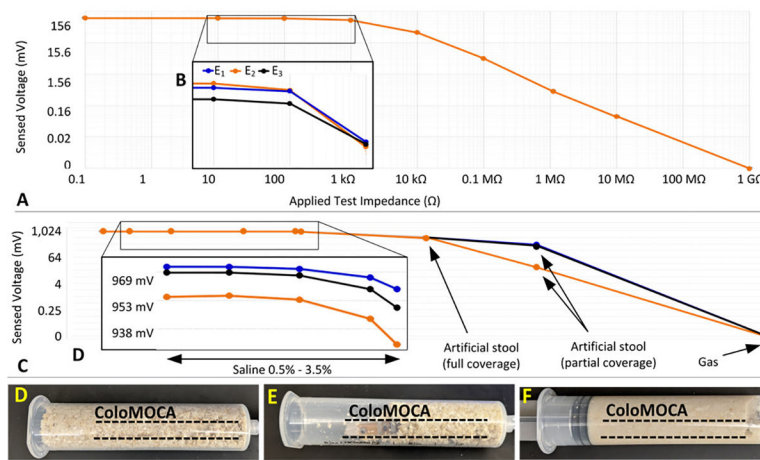

Fig. 8. ColoMOCA optimal sensitivity was between 1 k Ω – 10 M Ω (A) with reduced sensitivity down to 10 Ω (B). ColoMOCA detected stool composition (C) between gas (air), artificial stool, or liquid (saline 0.5 – 4.0%) (D). Artificial stool and saline testing used a 60-cc syringe filled with full artificial stool (D), partial artificial stool (E), or a liquid stool (F).

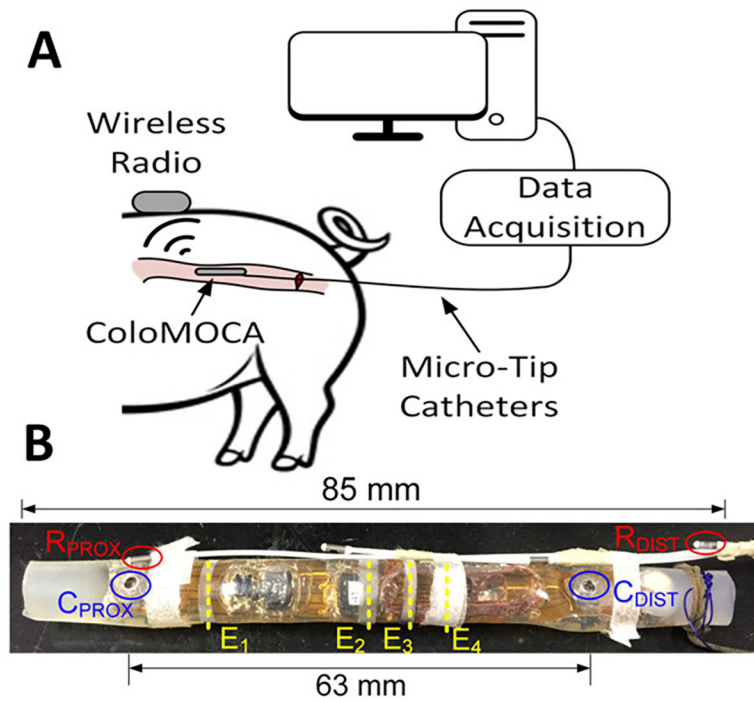

Fig. 9. Acute, awake recordings were made with the animal in a sling (A). Four micro-tip transducers were placed along the length of the ColoMOCA (B), with two sensors (R_{PROX} and R_{DIST}) placed near ColoMOCA sensors C_{PROX} and C_{DIST} .

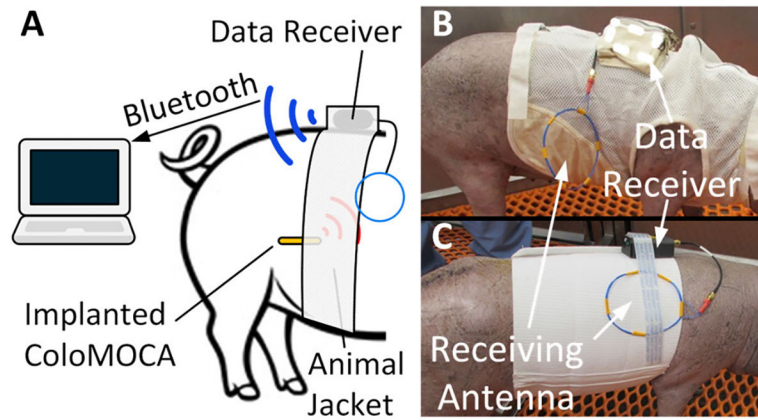

Fig. 10. Chronic data recordings were made with animals wearing a radio, which received transmissions from the implant and forwarded data using Bluetooth (A). Animals wore the radio either in a jacket (B) or strapped to an abdominal binder (C) during untethered recordings.

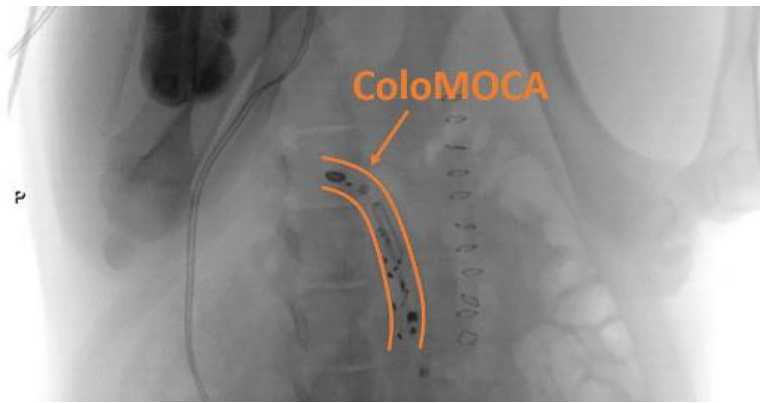

Fig. 11. Fluoroscopy imaging validated ColoMOCA position after implantation. In this example, the ColoMOCA is flexing to follow the curvature of the bowel.

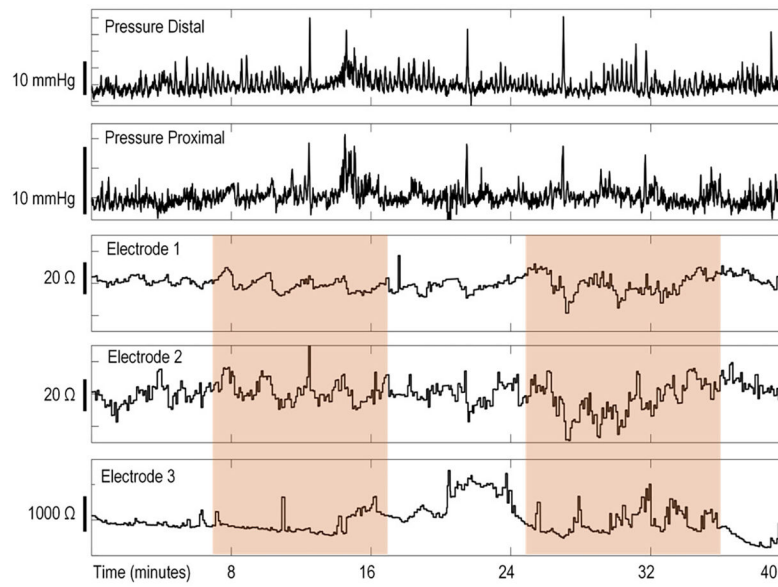

Fig. 12. Example chronic data recording from ColoMOCA showing simultaneous measurement of pressure sensors and impedance electrodes. Pressure data show rhythmic colonic activity, while periodic impedance changes suggest stool movement, indicated by shaded regions.

TABLE I.

ColoMOCA Electrical Specifications

	Measured/nominal value
ColoMOCA dimensions	8 mm diameter, 85 mm long
ColoMOCA sensors	Pressure (2 channels) Temperature (2 channels) Colon content impedance (3 channels)
Pressure sampling rate	75 Hz, 0.5 Hz filtered bandwidth
Pressure accuracy	1.3 cm H ₂ O RMS
Impedance sampling rate	0.17 Hz
Impedance range	>10 M Ω to 10 Ω
Radio transmission	4 MHz, OOK, 10 Hz packet rate
Transmission distance	30 cm, using 8-cm loop antenna
Wireless battery recharge	2.2 MHz inductive coupling 15-cm range with 21 W power
Current draw (measure)	142 μ A
Current draw (sleep)	2.4 μ A
Battery lifespan (measure)	38 hours
Battery lifespan (sleep)	95 days

Summarized In Vivo Contraction Measurements. Values reported as Median [Interquartile range].

TABLE II.

Recording Environment	Distal Catheter (R _{DIST})	Proximal Catheter (R _{DIST})	Distal ColoMOCA Sensor (C _{PROX})	Proximal ColoMOCA Sensor (C _{DIST})
	268	276	214	248
Animal in sling restraint (acute use)				
Contractions (recorded)	15.6 [8.2]	17.2 [6.8]	17.2 [7.1]	17.2 [6.0]
Period (s)	2.7* [3.9]	4.6 [#] [5.4]	3.0* [2.9]	4.9 [#] [5.8]
Amplitude (mmHg)	12.3 [11.0]	12.6 [8.6]	14.2 [9.8]	12.9 [7.7]
Duration (s)	-	-	22,396	22,520
Animal fully ambulatory (7-day implant)				
Contractions (recorded)	-	-	12.5 [7.1]	12.4 [7.0]
Period (s)	-	-	5.2 [#] [9.7]	5.9 [#] [13.9]
Amplitude (mmHg)	-	-	9.4 [9.8]	9.3 [9.7]
Duration (s)	-	-	-	-

* and [#] denote different groups with nonparametric Kruskal-Wallis p<0.05

PERFORMANCE SUMMARY AND COMPARISON TO RELATED RECENT WORKS DEMONSTRATED IN VIVO

TABLE III.

	This Work	[8]	[21]	[22]	[18]
Dimensions	8 mm cylinder 85 mm long	13 mm cylinder 26 mm long	11 mm cylinder 25 mm long	11 mm cylinder 22 mm long	12 mm cylinder 33 mm long
Device volume	4.3 cm ³	3.5 cm ³	2.4 cm ³	2.1 cm ³	3.7 cm ³
Sensor modalities	2 pressure sensors 2 temperature sensors* 3 impedance sensors	1 pressure sensor 1 temperature sensor 1 pH sensor	1 pressure sensor 1 temperature sensor 1 pH sensor	1 pressure sensor 1 temperature sensor 1 pH sensor	2 pressure sensors
Sample rate	Pressure and Temperature: 10 Hz Impedance: 0.17 Hz	Non-uniform, 0.025 – 0.05 Hz	-	0.8 Hz	4 Hz
Wireless communication	4 MHz OOK	434 MHz FSK	434 MHz FSK	434 MHz FSK	2.45 GHz
Average current draw (measurement mode)	142 μ A	-	490 μ A	32 μ A	~8,000 μ A
Battery lifetime	38 hrs	120 hr	136 hr	233 hr	15 hr
In-vivo recharge	YES	NO	NO	NO	NO
Measures colonic segment activity	YES	NO	NO	NO	NO
Flexible	YES	NO	NO	NO	NO

* measured but not transmitted in presented experiments