

# UC Berkeley

## UC Berkeley Previously Published Works

### Title

Fuel-economy testing of a three-vehicle truck platooning system

### Permalink

<https://escholarship.org/uc/item/7g37w4fb>

### Authors

McAuliffe, Brian

Croken, Mark

Ahmadi-Baloutaki, Mojtaba

et al.

### Publication Date

2017-04-22

## TECHNICAL REPORT DOCUMENTATION PAGE

*General instructions: To add text, click inside the form field below (will appear as a blue highlighted or outlined box) and begin typing. The instructions will be replaced by the new text. If no text will be added, remove the form field and its instructions by clicking inside the field, then pressing the Delete key twice.  
Please remove this field before completing form.*

<b>1. Report No.</b>	<b>2. Government Accession No.</b>	<b>3. Recipient's Catalog No.</b>	
<b>4. Title and Subtitle</b> Fuel-Economy Testing of a Three-Vehicle Truck Platooning System (Deliverable 2.6)		<b>5. Report Date</b> April 22, 2017	
		<b>6. Performing Organization Code</b>	
<b>7. Author(s)</b> Brian R. McAuliffe, Mark Croken, Mojtaba Ahmadi-Baloutaki, Arash Raeesi		<b>8. Performing Organization Report No.</b> LTR-AL-2017-0008	
<b>9. Performing Organization Name and Address</b> Aerodynamics Laboratory, National Research Council Canada		<b>10. Work Unit No.</b>	
		<b>11. Contract or Grant No.</b> Cooperative Agreement DTFH61-13-H-00012	
<b>12. Sponsoring Agency Name and Address</b> Federal Highway Administration, Turner-Fairbank Highway Research Center, Exploratory Advanced Research Program 6300 Georgetown Pike, McLean VA		<b>13. Type of Report and Period Covered</b> Final Report, April 2016-March 2017	
		<b>14. Sponsoring Agency Code</b>	
<b>15. Supplementary Notes</b> Conducted in cooperation with the U.S. Department of Transportation, Federal Highway Administration. This research was funded by Transport Canada, working in collaboration with the Partially Automated Truck Platooning (PATP) project sponsored by the FHWA EARP, with cost sharing from the California Department of Transportation, LA Metro, the University of California PATH Program and Volvo Group Technology.			
<b>16. Abstract</b> The fuel economy testing was conducted to determine the effects that the shorter than normal vehicle following distances enabled by coordinated automatic longitudinal control of the heavy duty tractor-trailer trucks would have on the fuel consumption of each of the trucks (the leader and two followers), based on their aerodynamic drafting. An additional dimension of the test program was to determine the interaction of the short following distances with aerodynamic improvements to the trailers (boat tails and side skirts). The test results showed that the effect of combining the short following distances with the aerodynamic improvements was synergistic, producing more energy savings than the sum of the savings from each of these strategies applied separately. The fuel savings were quite similar across the range of gaps that was tested, indicating the need to extend the testing to both shorter and longer gaps to understand the full range of impacts that truck platooning could have on fuel consumption.			
<b>17. Key Words</b> Truck platooning, cooperative adaptive cruise control, truck energy consumption, truck aerodynamics		<b>18. Distribution Statement</b> Distribution subject to approval by National Research Council Canada per statement in the attached report	
<b>19. Security Classif. (of this report)</b> Unclassified	<b>20. Security Classif. (of this page)</b> Unclassified	<b>21. No. of Pages</b> 83	<b>22. Price</b>

## Preface

This report was prepared by the staff of the National Research Council, Canada, working under the financial sponsorship of Transport Canada, in collaboration with the Partially Automated Truck Platooning (PATP) project sponsored by the FHWA EARP, with cost sharing from the California Department of Transportation, LA Metro, the University of California PATH Program and Volvo Group Technology. Under this collaboration, the PATP project developed and refined the control system that enables the trucks to drive under tight automatic longitudinal control, so that they can maintain the desired short separation distances or time gaps. In parallel, Transport Canada designed and funded the testing program, providing use of their test track and all the supporting facilities and staff to conduct the measurements of fuel consumption of the trucks under a wide range of conditions.

The fuel economy testing was conducted to determine the effects that the shorter than normal vehicle following distances enabled by coordinated automatic longitudinal control of the heavy duty tractor-trailer trucks would have on the fuel consumption of each of the trucks (the leader and two followers), based on their aerodynamic drafting. An additional dimension of the test program was to determine the interaction of the short following distances with aerodynamic improvements to the trailers (boat tails and side skirts). The test results showed that the effect of combining the short following distances with the aerodynamic improvements was synergistic, producing more energy savings than the sum of the savings from each of these strategies applied separately. The fuel savings were quite similar across the range of gaps that was tested, indicating the need to extend the testing to both shorter and longer gaps to understand the full range of impacts that truck platooning could have on fuel consumption.





## NRC Publications Archive Archives des publications du CNRC

### **Fuel-economy testing of a three-vehicle truck platooning system** McAuliffe, Brian R.; Croken, Mark; Ahmadi-Baloutaki, Mojtaba; Raeesi, Arash

For the publisher's version, please access the DOI link below./ Pour consulter la version de l'éditeur, utilisez le lien DOI ci-dessous.

#### **Publisher's version / Version de l'éditeur:**

<http://doi.org/10.4224/23001922>

*Laboratory Technical Report (National Research Council Canada. Aerospace. Aerodynamics Laboratory), 2017-04-22*

#### **NRC Publications Record / Notice d'Archives des publications de CNRC:**

<http://nparc.cisti-icist.nrc-cnrc.gc.ca/eng/view/object/?id=d21e1097-5d30-4a0f-b742-35ffad931c2f>

<http://nparc.cisti-icist.nrc-cnrc.gc.ca/fra/voir/objet/?id=d21e1097-5d30-4a0f-b742-35ffad931c2f>

Access and use of this website and the material on it are subject to the Terms and Conditions set forth at

<http://nparc.cisti-icist.nrc-cnrc.gc.ca/eng/copyright>

READ THESE TERMS AND CONDITIONS CAREFULLY BEFORE USING THIS WEBSITE.

L'accès à ce site Web et l'utilisation de son contenu sont assujettis aux conditions présentées dans le site

<http://nparc.cisti-icist.nrc-cnrc.gc.ca/fra/droits>

LISEZ CES CONDITIONS ATTENTIVEMENT AVANT D'UTILISER CE SITE WEB.

**Questions?** Contact the NRC Publications Archive team at

PublicationsArchive-ArchivesPublications@nrc-cnrc.gc.ca. If you wish to email the authors directly, please see the first page of the publication for their contact information.

**Vous avez des questions?** Nous pouvons vous aider. Pour communiquer directement avec un auteur, consultez la première page de la revue dans laquelle son article a été publié afin de trouver ses coordonnées. Si vous n'arrivez pas à les repérer, communiquez avec nous à PublicationsArchive-ArchivesPublications@nrc-cnrc.gc.ca.



**NRC-CNRC**

*AERODYNAMICS LABORATORY*

# *Fuel-Economy Testing of a Three-Vehicle Truck Platooning System*

Unclassified

Unlimited

LTR-AL-2017-0008

April 22, 2017

Brian R. McAuliffe, Mark Croken, Mojtaba Ahmadi-Baloutaki, Arash Raeesi



National Research  
Council Canada

Conseil national  
de recherches Canada

Canada



AERODYNAMICS LABORATORY

# *Fuel-Economy Testing of a Three-Vehicle Truck Platooning System*

Report No.: LTR-AL-2017-0008

Date: April 22, 2017

Authors: Brian R. McAuliffe, Mark Croken, Mojtaba Ahmadi-Baloutaki, Arash Raeesi

<b>Classification:</b>	Unclassified	<b>Distribution:</b>	Unlimited
<b>For:</b>	ecoTECHNOLOGY for Vehicles Stewardship and Sustainable Transportation Programs Transport Canada		
<b>Project #:</b>	A1-009253		
<b>Submitted by:</b>	Dr. Michael Benner, <b>Director R&amp;D, Aerodynamics Laboratory</b>		
<b>Approved by:</b>	Jerzy Komorowski, <b>General Manager, NRC Aerospace</b>		

<b>Pages:</b>	64	<b>Copy No:</b>	
<b>Figures:</b>	78	<b>Tables:</b>	6

*This report may not be published wholly or in part without the written consent of the National Research Council Canada*





## Disclaimer

*This report reflects the views of the authors only and does not reflect the views or policies of Transport Canada.*

*Neither Transport Canada, nor its employees, makes any warranty, express or implied, or assumes any legal liability or responsibility for the accuracy or completeness of any information contained in this report, or process described herein, and assumes no responsibility for anyone's use of the information. Transport Canada is not responsible for errors or omissions in this report and makes no representations as to the accuracy or completeness of the information.*

*Transport Canada does not endorse products or companies. Reference in this report to any specific commercial products, process, or service by trade name, trademark, manufacturer, or otherwise, does not constitute or imply its endorsement, recommendation, or favoring by Transport Canada and shall not be used for advertising or service endorsement purposes. Trade or company names appear in this report only because they are essential to the objectives of the report.*

*References and hyperlinks to external web sites do not constitute endorsement by Transport Canada of the linked web sites, or the information, products or services contained therein. Transport Canada does not exercise any editorial control over the information you may find at these locations.*



## Executive Summary

Vehicle-to-Vehicle (V2V)-based cooperative truck platooning systems are nearing commercialization. However, there is a knowledge gap in terms of the reliability and resiliency of these systems. Under a U.S. Federal Highway Administration (FHWA) Exploratory Advanced Research Project, the University of California (Berkeley) Partners for Advanced Transportation Technology (PATH) has been developing and testing three-truck platooning technology using cooperative adaptive cruise control (CACC), in collaboration with Volvo Trucks. Transport Canada has been successful in partnering with PATH to secure the PATH CACC system for testing and evaluation purposes at TC's Motor Vehicle Test Centre (MVTC). The National Research Council Canada (NRC) supported TC's effort to host the fuel-consumption testing campaign for the PATH truck-platooning technology demonstrations. The NRC, under direction from TC and with support from FPInnovations PIT Group, conducted a modified version of the SAE J1321 Type II fuel consumption test procedure to evaluate the fuel-savings benefits of platooning for various aerodynamic tractor-trailer configurations. Other project partners included the California Department of Transportation (Caltrans), PMG Technologies, Centre de Formation du Transport Routier de Saint-Jérôme (CFTR), and Environment and Climate Change Canada (ECCC).

Four tractor-trailer combinations were used as part of the fuel-economy tests: the three identical test vehicles with the CACC control systems, and a control vehicle. Auxiliary fuel tanks were installed on the vehicles to permit direct measurement of the fuel use during each measurement run using a gravimetric fuel-weighing procedure.

A test program was devised, through consensus by the project partners, to examine the influence of four parameters on the fuel-savings potential of the three-truck CACC-based platoon:

- Separation Distance/Time: 17 m (57 ft) to 43 m (142 ft), equivalent to 0.6 s to 1.5 s at 105 km/h (65 mph).
- Truck configuration: standard trailer vs. aerodynamic trailer.
- Vehicle speed: 89 km/h (55 mph) and 105 km/h (65 mph).
- Vehicle weight: 14,000 kg (31,000 lbs) and 29,400 kg (65,000 lbs).

For the range of test conditions examined, the net fuel savings for the full vehicle platoon was measured to be between 5.2% and 7.8%. The combined effect of platooning and aerodynamic trailer devices was measured to be up to 14.2% at the shortest separation distance of 17.4 m.

The major findings of the study include:

- At the shorter separation distances tested, a decrease in fuel savings was observed with increasing distance. Beyond about 22 m for the standard trailer, for which the platoon-averaged fuel savings was measured to be 5.2%, no significant change in fuel savings was observed. For the aerodynamic trailer configuration, no significant change was observed beyond 34 m for which the platoon-averaged fuel-savings was measured to be 5.7%.
- The lead vehicle showed no significant fuel savings for the tested separation distances of 26 m and greater. At the shortest separation distance tested (17 m), a small fuel savings on the order of 1% was observed for some of the test conditions.
- For the range of separation distances tested (17 m to 44 m), and for the standard and aerodynamic trailer configurations, the trailing vehicle experienced the highest fuel savings of the three vehicles (approximately 3% higher than the middle vehicle).
- The aerodynamic-trailer configuration experienced a greater percentage fuel savings from platooning than did the standard-trailer configuration (0.5% to 2% higher depending on separation distance).
- No significant effect of vehicle speed on the fuel savings from the CACC platooning system was observed based on the tested speeds of 89 km/h (55 mph) and 105 km/h (65 mph).
- An increased fuel savings of 1.6% associated with the vehicle CACC platooning system was observed for the empty trailer, compared to the loaded trailer.

The results of this study have demonstrated some of the potential fuel-savings benefits of vehicle platooning for a range of test conditions, and highlighted additional knowledge gaps. Recommendations are provided for follow-on testing.

## Table of Contents

Executive Summary . . . . .	vii
List of Figures . . . . .	x
List of Tables . . . . .	xiii
Nomenclature . . . . .	xiv
<b>1. Introduction</b>	<b>1</b>
1.1 Background . . . . .	1
1.2 Project Partners . . . . .	2
1.3 Objectives and Outcomes . . . . .	2
1.4 Approach . . . . .	3
1.5 Aerodynamic Benefits of Truck Platooning . . . . .	3
<b>2. Test Setup</b>	<b>7</b>
2.1 Cooperative Adaptive Cruise Control System . . . . .	7
2.2 Test Vehicles and Configurations . . . . .	7
2.3 Test Site . . . . .	8
2.4 Test Matrix . . . . .	11
2.5 Fuel Consumption Measurements . . . . .	12
2.5.1 Fuel System Modifications . . . . .	12
2.5.2 Fuel Tank Filling . . . . .	12
2.5.3 Fuel Measurement Instrumentation . . . . .	13
2.5.4 Fuel Measurement Procedure . . . . .	13
2.5.5 Regenerations . . . . .	16
2.5.6 Wind Measurements . . . . .	16
2.6 Test Procedure . . . . .	17
2.6.1 Daily Pre-Test Checks . . . . .	17
2.6.2 Specific Test Procedures . . . . .	17

<b>3. Results and Discussion</b>	<b>23</b>
3.1 Data Analysis . . . . .	23
3.2 Fuel-Savings Measurement Results . . . . .	25
3.3 Influence of Aerodynamic Treatments . . . . .	27
3.4 Influence of Separation Distance on Platooning Performance . . . . .	27
3.5 Influence of Vehicle Speed and Weight on Platooning Performance . . . . .	31
<b>4. Conclusions and Recommendations</b>	<b>35</b>
4.1 Conclusions . . . . .	35
4.2 Recommendations for Future Work . . . . .	36
<b>References</b>	<b>39</b>
<b>A. Test Vehicle Specification</b>	<b>41</b>
<b>B. Test Data</b>	<b>43</b>

## List of Figures

1.1 Schematic of a two-vehicle HDV platoon . . . . .	3
1.2 Schematic of a three-vehicle HDV platoon . . . . .	4
2.1 Photograph of Test Truck 1. . . . .	8
2.2 Photograph of the Control Truck. . . . .	8
2.3 Test trucks 1, 2, 3, and the control truck parked in position on Bravo track during refuelling and tank weighing. . . . .	9
2.4 Photograph of side-skirts and boat-tail installed for the aerodynamic-trailer test configuration. . . . .	9
2.5 Satellite photograph of the test track . . . . .	10
2.6 Fuel tank installed on frame rails behind the tractor cab . . . . .	13
2.7 Fuel system routing . . . . .	14
2.8 Photograph of auxiliary fuel-tank weighing procedure. . . . .	15
2.9 Test procedure for baseline test and independent-vehicle test segments. . . . .	18

Fuel-Economy Testing of a Three-Truck Platoon

2.10 Schematic representation of test procedure for baseline test and independent-vehicle test segments. . . . . 19

2.11 Test procedure for platooning test segments. . . . . 20

2.12 Schematic representation of test procedure for platooning test segments. . . . . 21

3.1 Variation in fuel-savings measurements with separation distance for each vehicle in the platoon, vehicle speed of 105 km/hr, vehicle mass of 29,400 kg (measurements referenced to respective vehicle configurations in non-platooned arrangement). . . . . 28

3.2 Variation in fuel-savings measurements with separation distance for the complete platoon, vehicle speed of 105 km/hr, vehicle mass of 29,400 kg (measurements referenced to respective vehicle configurations in non-platooned arrangement). . . . . 29

3.3 Variation in fuel-savings measurements with separation distance for each vehicle in the platoon, vehicle speed of 105 km/hr, vehicle mass of 29,400 kg (all measurements referenced to standard-trailer configuration in non-platooned arrangement). . . . . 30

3.4 Variation in fuel-savings measurements with separation distance for the complete platoon, vehicle speed of 105 km/hr, vehicle mass of 29,400 kg (measurements referenced to standard-trailer configuration in non-platooned arrangement). . . . . 31

3.5 Fuel-savings measurements at a separation distance of 17.4 m for different trailer configurations, vehicle speeds, and vehicles weights. . . . . 32

B.1 Wind Rose - 6 October 2016 Test A1.1 . . . . . 45

B.2 Wind Rose - 6 October 2016 Test A1.2 . . . . . 45

B.3 Wind Rose - 6 October 2016 Test A1.3 . . . . . 46

B.4 Wind Rose - 6 October 2016 Test A6.1 . . . . . 46

B.5 Wind Rose - 6 October 2016 Test A6.2 . . . . . 46

B.6 Wind Rose - 6 October 2016 Test A6.3 . . . . . 47

B.7 Wind Rose - 7 October 2016 Test A3.1 . . . . . 47

B.8 Wind Rose - 7 October 2016 Test A2.1 . . . . . 47

B.9 Wind Rose - 7 October 2016 Test A2.2 . . . . . 48

B.10 Wind Rose - 7 October 2016 Test A2.3 . . . . . 48

B.11 Wind Rose - 7 October 2016 Test A2.4 . . . . . 48

B.12 Wind Rose - 7 October 2016 Test A2.5 . . . . . 49



## Fuel-Economy Testing of a Three-Truck Platoon

B.13	Wind Rose - 11 October 2016 Test A3.2 . . . . .	49
B.14	Wind Rose - 11 October 2016 Test A3.3 . . . . .	49
B.15	Wind Rose - 11 October 2016 Test A3.4 . . . . .	50
B.16	Wind Rose - 11 October 2016 Test A4.1 . . . . .	50
B.17	Wind Rose - 11 October 2016 Test A4.2 . . . . .	50
B.18	Wind Rose - 11 October 2016 Test A4.3 . . . . .	51
B.19	Wind Rose - 11 October 2016 Test A2.6 . . . . .	51
B.20	Wind Rose - 12 October 2016 Test A5.1 . . . . .	51
B.21	Wind Rose - 12 October 2016 Test A5.2 . . . . .	52
B.22	Wind Rose - 12 October 2016 Test A5.3 . . . . .	52
B.23	Wind Rose - 12 October 2016 Test A5.4 . . . . .	52
B.24	Wind Rose - 12 October 2016 Test A6.4 . . . . .	53
B.25	Wind Rose - 12 October 2016 Test A1.4 . . . . .	53
B.26	Wind Rose - 15 October 2016 Test S1.1 . . . . .	53
B.27	Wind Rose - 15 October 2016 Test S1.2 . . . . .	54
B.28	Wind Rose - 15 October 2016 Test S1.3 . . . . .	54
B.29	Wind Rose - 15 October 2016 Test S6.1 . . . . .	54
B.30	Wind Rose - 15 October 2016 Test S6.2 . . . . .	55
B.31	Wind Rose - 16 October 2016 Test S6.3 . . . . .	55
B.32	Wind Rose - 17 October 2016 Test S2.1 . . . . .	55
B.33	Wind Rose - 17 October 2016 Test S2.2 . . . . .	56
B.34	Wind Rose - 17 October 2016 Test S2.3 . . . . .	56
B.35	Wind Rose - 17 October 2016 Test S3.1 . . . . .	56
B.36	Wind Rose - 17 October 2016 Test S3.2 . . . . .	57
B.37	Wind Rose - 17 October 2016 Test S3.3 . . . . .	57
B.38	Wind Rose - 17 October 2016 Test S3.4 . . . . .	57
B.39	Wind Rose - 18 October 2016 Test S4.1 . . . . .	58
B.40	Wind Rose - 18 October 2016 Test S4.2 . . . . .	58
B.41	Wind Rose - 18 October 2016 Test S4.3 . . . . .	58
B.42	Wind Rose - 18 October 2016 Test S5.1 . . . . .	59

Fuel-Economy Testing of a Three-Truck Platoon

B.43	Wind Rose - 19 October 2016 Test S5.2 . . . . .	59
B.44	Wind Rose - 19 October 2016 Test S5.3 . . . . .	59
B.45	Wind Rose - 19 October 2016 Test S7.1 . . . . .	60
B.46	Wind Rose - 19 October 2016 Test S7.2 . . . . .	60
B.47	Wind Rose - 20 October 2016 Test C1.1 . . . . .	60
B.48	Wind Rose - 20 October 2016 Test C1.2 . . . . .	61
B.49	Wind Rose - 20 October 2016 Test C1.3 . . . . .	61
B.50	Wind Rose - 23 October 2016 Test S8.1 E . . . . .	61
B.51	Wind Rose - 23 October 2016 Test S8.2 E . . . . .	62
B.52	Wind Rose - 23 October 2016 Test S8.3 E . . . . .	62
B.53	Wind Rose - 23 October 2016 Test S9.1 E . . . . .	62
B.54	Wind Rose - 23 October 2016 Test S9.2 E . . . . .	63
B.55	Wind Rose - 23 October 2016 Test S9.3 E . . . . .	63
B.56	Wind Rose - 24 October 2016 Test S9.4 E . . . . .	63
B.57	Wind Rose - 24 October 2016 Test S9.5 E . . . . .	64
B.58	Wind Rose - 24 October 2016 Test S8.4 E . . . . .	64
B.59	Wind Rose - 24 October 2016 Test S8.5 E . . . . .	64

**List of Tables**

2.1	Vehicle mass measurements. . . . .	7
2.2	Test matrix for three-truck-platoon fuel-economy tests. . . . .	11
3.1	Estimates of drag force, rolling resistance, and road load for an individual tractor-trailer at the ground speeds and weights tested. . . . .	25
3.2	Results from fuel consumption tests. . . . .	26
A.1	Control and test vehicle specifications. . . . .	41
B.1	Fuel consumption and atmospheric conditions measured during test campaign. . . . .	44

## Nomenclature

### Symbols:

$A$	Reference area
$C_D$	Drag coefficient
$\Delta F$	Fuel savings
$F_{Aero}$	Aerodynamic drag force
$F_{Grade}$	Grade force
$F_{RL}$	Road load
$F_{RR}$	Rolling resistance
$Q$	Dynamic pressure
$T/C$	Ratio of test-vehicle fuel consumption to control-vehicle fuel consumption
$U$	Speed
$W$	Vehicle weight
$\Delta W$	Weight of fuel consumed
$WAC_D$	Wind-averaged drag coefficient
$\mu$	Rolling resistance coefficient
$\psi$	Yaw angle of wind relative to the vehicle
$\rho$	Air density

### Acronyms:

CACC	Cooperative adaptive cruise control
CFD	Computational fluid dynamics
CFTR	Centre de Formation du Transport Routier de Saint-Jerome
DSRC	Dedicated short-range communication
DOT	U.S. Department of Transportation
DPF	Diesel particulate filter
ECCC	Environment and Climate Change Canada
FHWA	Federal Highway Administration
eTV	ecoTECHNOLOGY for Vehicles
GHG	Greenhouse gas
HDV	Heavy duty vehicle
ITS	Intelligent transportation systems
LDV	Light duty vehicle
MY	Model year

Fuel-Economy Testing of a Three-Truck Platoon

MVTC	Motor Vehicle Test Centre
NACFE	North American Council for Freight Efficiency
NRC	National Research Council Canada
PATH	Partners for Advanced Transportation Technology
RCC	Regulatory Cooperation Council
SAE	Society of Automotive Engineers
TC	Transport Canada
V2V	Vehicle-to-vehicle

Fuel-Economy Testing of a Three-Truck Platoon

# 1. Introduction

## 1.1 Background

Transport Canada (TC), through its ecoTECHNOLOGY for Vehicles (eTV) program, undertakes testing and evaluation of new and emerging vehicle technologies. The program helps inform various stakeholders that are engaged in the development of regulations, codes, standards, and products for the next generation of advanced light-duty vehicles (LDVs) and heavy-duty vehicles (HDVs). Results are helping to inform the development of environmental and safety regulations to ensure that new technologies can be introduced in Canada in a safe and timely manner.

There have been many efforts to reduce the aerodynamic drag of Heavy Duty Vehicles (HDVs). The majority of these efforts includes applying modifications to several aspects of the vehicle design which are costly (Bergenheim *et al.*, 2012). There are, however, other approaches that benefit from positive aerodynamic effects occurring naturally around a moving vehicle. Vehicle platooning is one of these methods which is defined as two or more vehicles traveling at the same speed with relatively small inter-vehicle spacing. It has been reported in the literature that vehicle platooning can result in aerodynamic drag reduction as well as improved safety and reduced traffic congestion (Watkins and Vino, 2008; Gaudet, 2014).

Vehicle-to-Vehicle (V2V)-based cooperative HDV truck platooning systems are nearing commercialization. However, there is a knowledge gap in terms of the reliability and resiliency of these systems. Further testing and evaluation is required to help qualify and quantify their overall operational, safety, and environmental performance. The University of California (Berkeley) Partners for Advanced Transportation Technology (PATH) has been a leader in Intelligent Transportation Systems (ITS) research since its founding in 1986. PATH has experimentally implemented automated truck platooning on two tractor-trailer trucks in 2003 (Browand *et al.*, 2004) and on three tractor-trailer trucks in 2010-11 (Tsugawa *et al.*, 2016). These trucks used V2V communication in addition to forward sensors to help maintain constant clearance for vehicles following at very short gaps (tested from 10 m down to 3 and 4 m gaps). Some tests have included measurements of energy savings at constant-speed-following as well as manoeuvres to join and split from the platoon, and travelling up and down grades. Under a new U.S. Federal Highway Administration (FHWA) Exploratory Advanced Research Project, PATH has been developing and testing a second-generation truck-platooning technology using cooperative adaptive cruise control (CACC), in collaboration with Volvo Trucks.

Transport Canada has been successful in partnering with PATH to secure the PATH CACC system for testing and evaluation purposes at TC's Motor Vehicle Test Centre (MVTC). The National Research Council Canada (NRC) has supported TC's effort to host the fuel-consumption testing campaign for the PATH truck-platooning technology demonstrations. The NRC, under direction from TC and with support from FPIInnovations PIT Group, conducted a modified version of the SAE J1321 Type II fuel consumption test procedure at the TC MVTC to evaluate the fuel-savings benefits of platooning for various aerodynamic tractor-trailer configurations.

Assistance from the FPInnovations PIT Group was provided to the NRC/TC for the coordination and execution of the test program.

## 1.2 Project Partners

The various Canadian and U.S. project partners, and their roles in the project, are as follows:

- Transport Canada (TC) - Canadian funding partner, through its ecoTECHNOLOGY for Vehicle program.
- U.S. Federal Highway Administration (FHWA) - U.S. funding partner, through its Exploratory Advanced Research Program.
- California Partners for Advanced Transportation Technology (PATH) at U.C. Berkeley - Principle research partner and system integrator.
- California Department of Transportation (Caltrans) - Project management and coordination for U.S. project partners.
- Volvo Trucks - Vehicle provider and technical support for system integration.
- National Research Council Canada (NRC) - Project management for Canadian component and principle test coordinator.
- FPInnovations PIT Group - On-site technical support and coordination.
- PMG Technologies - Track operator.
- Centre de Formation du Transport Routier de Saint-Jérôme (CFTR) - Supplier of drivers.
- Environment and Climate Change Canada (ECCC) - Supplier of control vehicle.

## 1.3 Objectives and Outcomes

The primary objective of the test program was to evaluate the fuel-savings potential of the three-vehicle cooperative truck platooning system over a range of vehicle separation times that are expected to be suitable for platooning operations from a driver-comfort perspective. The data are to supplement separate testing by PATH on driver response and comfort over the same range of separation times. Secondary objectives were to investigate the variability in fuel-savings potential for changes in vehicle speed and weight, and with the addition of fuel-saving aerodynamic technologies for the trailer.

Additionally, this test program will provide the following benefits and outcomes:

- The work will directly support the U.S.-Canada Regulatory Cooperation Council's (RCC) U.S. Department of Transportation / Transport Canada Connected Vehicles Working Group through the development and alignment of connected vehicle standards to promote interoperability of these technologies across North America.

- The results will directly support Environment and Climate Change Canada's (ECCC) HDV greenhouse gas (GHG) emissions regulations for model years 2018 and beyond.
- The work directly supports and complements both US Department of Transport (U.S. DOT) and private sector sponsored cooperative truck platooning demonstration projects that are currently happening in the U.S. including California and Texas.

## 1.4 Approach

Fuel-economy testing based on the SAE J1321 Type II procedure (SAE J1321, 2012) was undertaken in October 2016 at TC's Motor Vehicle Test Centre in Blainville, Québec. This approach was selected based on previous experiments on truck platooning systems (see literature survey in next section). The SAE procedure consists of a standard test approach that provides reliability in the resulting data, including appropriate estimates of measurement uncertainty.

The test plan was developed in consultation between NRC, PATH, TC, and FHWA to support the objectives of each primary project partner.

## 1.5 Aerodynamic Benefits of Truck Platooning

The majority of aerodynamic drag of a ground-vehicle consists of "form" or "pressure" drag generated by the pressure differential between the front (high pressure field) and the rear (low pressure field) surfaces of the vehicle (Patten *et al.*, 2012). The aerodynamic benefit of platooning is primarily the result of the change in the aerodynamic pressure fields over the front and rear surfaces of vehicles present in a platoon configuration. In platoon configuration, like that shown in Figure 1.1, the lead vehicle takes advantage of the increased pressure in the gap between vehicles, especially for small gap sizes. The pressure increase in the back of the lead vehicle, due to the following vehicle, results in less pressure differential between its front and rear surfaces which reduces its aerodynamic drag. The trailing vehicle also benefits from

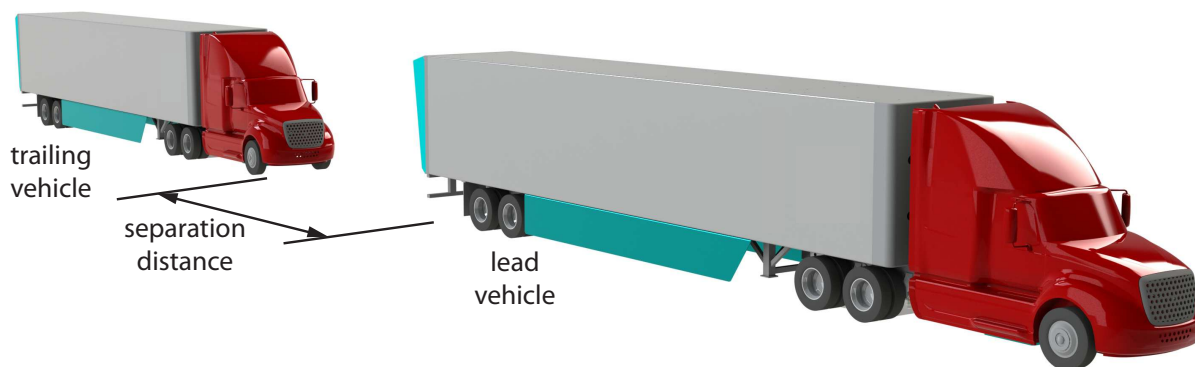
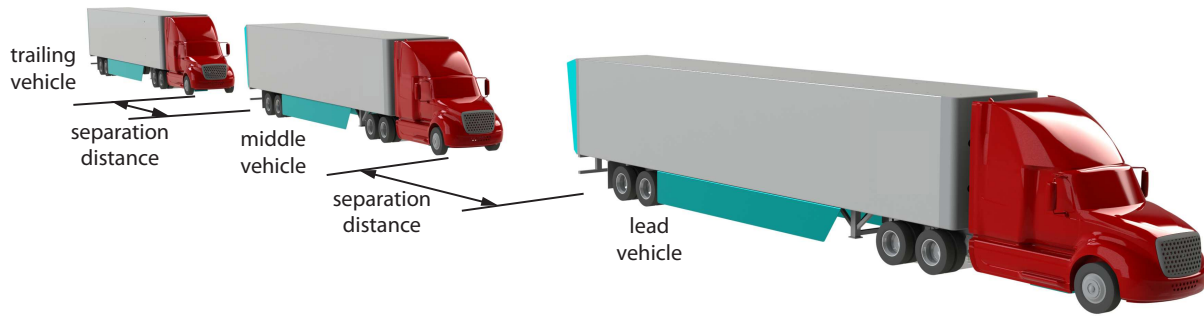

Figure 1.1: Schematic of a two-vehicle HDV platoon



## Fuel-Economy Testing of a Three-Truck Platoon



**Figure 1.2:** Schematic of a three-vehicle HDV platoon

the flow-field in the region between the two vehicles, which is dominated by the wake of the lead vehicle. The trailing vehicle is shielded from high-speed air resulting in the reduction of the high-pressure stagnation region at its front, thereby reducing its aerodynamic drag. In platoon configurations consisting of more than two vehicles, like that shown in Figure 1.2, the intermediate vehicles are believed to gain the most drag reduction among the other platoon members since they experience favourable changes in the pressure fields of both their front and rear surfaces. The reduced pressure at the front surface and the increased pressure at the rear surface lead to a reduction in the pressure differential between the front and rear surfaces of intermediate vehicles resulting in reduced aerodynamic drag. This, however, depends on many factors such as vehicle geometrical characteristics, platoon spacing, ambient wind, and traffic conditions (Tadakuma *et al.*, 2016).

Many studies have been performed on vehicle platooning but only a small portion focused on the aerodynamic effects. These studies have investigated the aerodynamic behavior of different vehicle sizes from small-size car models to HDVs via various analysis tools including full-scale road testing, wind tunnel measurements, and computational fluid dynamics (CFD). Many researchers have focused on the simplest platoon case consisting of two identical vehicles moving at the same speed with no lateral offset (Bonnet and Fritz, 2000; Hammache *et al.*, 2002; Browand *et al.*, 2004; Al Alam *et al.*, 2010; Roeth, 2013; Lammert *et al.*, 2014; Humphreys and Bevly, 2016; and Smith *et al.*, 2014). Recently, the North American Council for Freight Efficiency (NACFE) published a confidence report that summarizes many of the truck-platoon fuel-economy tests performed to date (Roberts *et al.*, 2016). Despite some discrepancies, there are several common trends reported in these studies that can be summarized as follows.

Both lead and trailing vehicles demonstrate reduced aerodynamic drag especially for gap sizes shorter than one vehicle length. In most cases, the downstream vehicle achieved higher drag reductions than the lead vehicle for moderate to long distances between vehicles ( $\gtrsim 10$  m). For very small inter-vehicle distances ( $\lesssim 10$  m), shorter than a half of a vehicle length, there are contradicting results in the literature where a few studies reported the lead vehicle achieves higher fuel savings while others showed greater fuel consumption improvement for the trailing vehicle. Furthermore, the gap size between the platooning vehicles influences each vehicle's drag behavior individually. In general, both lead and trailing vehicles achieve higher drag reductions when the gap decreases from long to moderate distances. For very small gaps,

shorter than a half of vehicle length, some studies (Bonnet and Fritz, 2000; Lammert *et al.*, 2014; Humphreys and Bevely, 2016; and Smith *et al.*, 2014) showed that the lead vehicle's drag reduction continues to improve while the trailing vehicle experiences a loss in its drag reduction by decreasing the vehicle gap. A couple of CFD studies (Smith *et al.*, 2014; and Gheysens and Van Raemdonck, 2016) investigated this discrepancy and found that the different geometrical features at the frontal surfaces of trucks have a significant impact on the aerodynamics of platooning vehicles with small gaps. They explained that the wake of the upstream vehicle influences the trailing vehicle in two ways. On one hand, it shields the trailing vehicle which results in reducing the stagnation pressure in front of the trailing vehicle. On the other hand, it reduces the suction or thrust force on the curved frontal surfaces of the trailing vehicle. The suction force is a function of the local Reynolds number (Wood, 2015) and is reduced at small inter-vehicle gaps due to the reduced local Reynolds number in the gap region. Smith *et al.* (2014) and Gheysens and Van Raemdonck (2016) found that for platooning vehicles with small gaps, the negative effect of suction-force reduction is dominant compared to the positive effect of stagnation-pressure reduction, and therefore the trailing vehicle loses the drag reduction benefits.

While most of the HDV platooning studies have focused on the fundamental scenario of a two-vehicle platoon, there are a handful of studies on multiple-vehicle HDV platoons. In a numerical-experimental study on a three-truck platoon, Tsugawa *et al.* (2011) examined the aerodynamic performance of three 25-ton heavy trucks driving at a speed of 80 km/h. They measured the fuel consumption of the platoon at several vehicle-separation distances ranging from 4.7 m to 20 m. The average fuel saving for the platoon unit was 18% at 4.7 m gap and decreased to 9% at 20 m gap. In all cases studied by Tsugawa *et al.* (2011) the lead truck showed the lowest amount of fuel saving. For shorter gap distances (<15 m), the middle truck achieved the largest amount of fuel saving while the trailing truck's fuel improvement was greater at larger gaps of 15 and beyond. They also used numerical simulations to determine the aerodynamic drag reduction associated with the fuel saving of the platoon unit for 80 km/h speed at a 4 m separation gap. They reported drag reductions of more than 20% for the lead and the trailing vehicles while the middle truck was shown to achieve 50% drag reduction.

Ellis *et al.* (2015) numerically studied three-vehicle platoons of Class 8 trailer-tractor configurations at two different vehicle spacings using high-fidelity CFD. They reported an averaged drag reduction in the range of 20% per vehicle at 9 m vehicle spacing while reducing the spacing to 5 m resulted in about 5% additional drag saving. They also investigated the effectiveness of adding improved aerodynamic devices such as trailer side-skirts and boat-tails on trucks in a platoon configuration. They found that platooning is more beneficial for the aerodynamically-treated vehicles. The effect of location within the platoon on each vehicle's drag saving was also investigated by Ellis *et al.* (2015). For 9 m vehicle spacing, the middle vehicle achieved the most drag reduction, followed by the trailing vehicle, and the lead vehicle had the lowest amount of drag saving. This pattern was changed by reducing the vehicle spacing to 5 m where the lead vehicle showed more drag reduction than the trailing vehicle while the middle vehicle still had the highest drag reduction.

Gheysens and Van Raemdonck (2016) studied the effect of crosswind on a platoon by exposing the platoon to an incoming flow at a yaw angle of 3°. Although the drag variation of the platooning vehicles was not significantly affected by the crosswind, the observed changes

depended on the frontal edge radius of the simplified vehicle shapes. The drag reduction of the platoon was improved under crosswind conditions for the vehicles having a small frontal edge radius while the crosswind had a negative effect on the platoon's drag saving for vehicles with large frontal edge radii. Gheysens and Van Raemdonck (2016) also reported that the side force was significantly reduced for the middle and trailing vehicles in the platoon due to the redirection of flow by the lead vehicle, while the lead vehicle experienced almost the same side force as its isolated case.

Since the number of studies on multiple-HDV platoons is fairly limited, additional insights could be gained from related studies on vans or vehicle models having similar shapes and aerodynamic characteristics to those of HDVs. In a CFD study on multiple-vehicle platoons (up to six vehicles), Schito and Braghin (2012) studied the effect of vehicle shape, number of vehicles and relative distance between the vehicles on the platoon's aerodynamic performance. They used different representative vehicle shapes including compact cars, sedans and vans. For platoons of identical vans, no additional drag reduction was observed for the platoon beyond 4 vehicles. Schito and Braghin (2012) also reported the highest drag saving occurred for middle vehicles followed by the last vehicle, and the lead vehicle had the least amount of drag reduction.

Tsuei and Savas (2001) studied the transient aerodynamic behaviour of two four-vehicle platoon configurations with 0.4 vehicle-length spacing in a series of wind tunnel tests. They used a sedan model and a rectangular box model representative of a mini-van or a bus. They studied the number of the vehicles in the platoon (from two to four) and reported that the platoon's averaged drag reduction increased with the number of vehicles in the platoon. They measured the highest drag saving for middle vehicles followed by the trailing and lead vehicles.

Marcu and Browand (1999) examined the effect of wind angularity on the aerodynamic performance of a three-vehicle platoon in a wind tunnel investigation. They used 1/8 scaled mini-vans at 10° crosswind with the vehicle spacing varying from 0 to 0.72 of a vehicle length. They measured an averaged drag reduction of 39% for three vehicles at a vehicle spacing of 0.2 vehicle lengths under crosswind conditions, while the platoon at zero yaw condition showed a slightly larger reduction (average of 42%). Under crosswind conditions, the vehicle platoon achieved a reduction in drag over the entire range of vehicle spacings examined, with the largest reductions at the shortest spacings. In this study, the middle vehicle showed the highest drag reduction, while the drag improvement of the lead vehicle was higher than that of the trailing vehicle for all vehicle spacings studied. Marcu and Browand (1999) also measured the side forces and yawing moments of platooning vehicles under crosswind conditions and reported that the side forces and yawing moments were significantly lower for the second and third vehicles while the lead vehicle experienced the largest side force and yawing moment. They attributed this to the redirection of the airflow by the lead vehicle as also observed by Gheysens and Van Raemdonck (2016).

## 2. Test Setup

### 2.1 Cooperative Adaptive Cruise Control System

The control system for maintaining vehicle spacing is based on Volvo’s adaptive cruise control (ACC) technology that uses radar and video to sense the distance to forward vehicles. The system has been supplemented with 5.9 GHz dedicated short-range communication (DSRC) radios for vehicle-to-vehicle (V2V) communication that enables implementation of a higher-performance control system with faster response to speed changes and a greater level of stability to the multi-vehicle system. Shladover *et al.* (2015) describe the concepts upon which this Cooperative ACC (CACC) system are based.

### 2.2 Test Vehicles and Configurations

Four tractor-trailer combinations were used as part of the fuel-economy tests. The control tractor was a 2013 International ProStar aerodynamic sleeper-cab, and the three identical test tractors were MY2015 Volvo model VNL 670 aerodynamic sleeper-cabs. The same model of 53 ft dry-van trailers, Utility model 4000D-X, was used for all four test vehicles. Figure 2.1 shows one of the test trucks and Figure 2.2 shows the control truck. The four trucks parked for refuelling and weighing are shown in Figure 2.3. The use of different tractor models for the test and control vehicles does not strictly conform to the SAE J1321 requirements, which specifies identical vehicles are to be used, although both are aerodynamically-treated tractors with similar engine specifications that were expected to behave similarly in the controlled conditions of the tests. The tractor and trailer specifications are provided in Appendix A. Investigation of the fuel-use data from the tests reveals that, for the non-platooning measurements, the test vehicles used approximately 3% more fuel than the control tractor for the drive cycles used in the test campaign (see data in Appendix B).

Fuel levels in the main tanks of the control vehicle were adjusted to match the vehicle weight to that of the test vehicles. The mass of the vehicles as-tested are provided in Table 2.1. The trailers were ballasted using concrete blocks aligned evenly along the centreline of the trailer.

**Table 2.1:** Vehicle mass measurements.

Tractor	Trailer #	Tractor Mass	Ballasted Trailer Mass	Total Vehicle Mass
1	160315	8,515 kg	20,880 kg	29,395 kg
2	160327	8,505 kg	20,880 kg	29,385 kg
3	160311	8,585 kg	20,870 kg	29,455 kg
Control	160325	8,650 kg	20,850 kg	29,500 kg



**Figure 2.1:** Photograph of Test Truck 1.



**Figure 2.2:** Photograph of the Control Truck.

For some of the tests, the trailers were outfitted with two aerodynamic technologies: side-skirts (Transtex Edge) and a boat-tail (Stemco TrailerTail Trident). These two aerodynamic devices are shown installed on the trailers in Figures 2.1 and 2.2, and photographs showing more details of the side-skirts and boat-tail are provided in Figure 2.4.

## 2.3 Test Site

Testing was performed at the Motor Vehicle Test Centre operated by PMG Technologies in Blainville, Quebec. The “Bravo” track was used for testing, which is a high-speed banked oval and the primary surface is rain-grooved concrete. The track is 6.5 km (4.0 miles) long with two straight 1.6 km (1.0 mile) sections, and two 1.6 km (1.0 mile) constant-curvature banked sections. An aerial view of the test track is shown in Figures 2.5.



Fuel-Economy Testing of a Three-Truck Platoon



**Figure 2.3:** Test trucks 1, 2, 3, and the control truck parked in position on Bravo track during refuelling and tank weighing.



**Figure 2.4:** Photograph of side-skirts and boat-tail installed for the aerodynamic-trailer test configuration.



**Figure 2.5:** Satellite photograph of the test track (top - vehicle configuration for independent-vehicle test runs, bottom - vehicle configuration for platooning test runs).

## 2.4 Test Matrix

A test program was devised to examine the influence of four parameters on the fuel-savings potential of the three-truck CACC-based platoon:

- Separation Distance/Time: 17 m (57 ft) to 43 m (142 ft), equivalent to 0.6 s to 1.5 s at 105 km/h.
- Truck configuration: standard trailer vs. aerodynamic trailer.
- Vehicle speed: 89 km/h (55 mph) and 105 km/h (65 mph).
- Vehicle weight: 14,000 kg (31,000 lbs) and 29,400 kg (65,000 lbs).

From this range of parameters, a test matrix was developed through consensus by the principle project partners (TC, PATH, NRC, FHWA) and is shown in Table 2.2. A decision was made to test the full range of separation distances for both trailer configurations (standard and aerodynamic), after which the influence of vehicle speed and weight were tested for the best-performing separation distance only, that being the shortest distance. For each change in

**Table 2.2:** Test matrix for three-truck-platoon fuel-economy tests.

Test Case	Vehicle Configuration	Vehicle Speed	Separation Time/Distance	Gross Vehicle Mass	Number of Valid Runs
A-1	aerodynamic	65 mph / 105 km/h	-	65,000 lb / 29,400 kg	4
A-2	aerodynamic	65 mph / 105 km/h	1.5 s / 44 m	65,000 lb / 29,400 kg	3
A-3	aerodynamic	65 mph / 105 km/h	1.2 s / 35 m	65,000 lb / 29,400 kg	3
A-4	aerodynamic	65 mph / 105 km/h	0.9 s / 26 m	65,000 lb / 29,400 kg	3
A-5	aerodynamic	65 mph / 105 km/h	0.6 s / 17 m	65,000 lb / 29,400 kg	4
S-1	standard	65 mph / 105 km/h	-	65,000 lb / 29,400 kg	3
S-2	standard	65 mph / 105 km/h	1.5 s / 44 m	65,000 lb / 29,400 kg	3
S-3	standard	65 mph / 105 km/h	1.2 s / 35 m	65,000 lb / 29,400 kg	3
S-4	standard	65 mph / 105 km/h	0.9 s / 26 m	65,000 lb / 29,400 kg	4
S-5	standard	65 mph / 105 km/h	0.6 s / 17 m	65,000 lb / 29,400 kg	3
S-6	standard	55 mph / 89 km/h	-	65,000 lb / 29,400 kg	3
S-7	standard	55 mph / 89 km/h	0.71 s / 17 m	65,000 lb / 29,400 kg	3
S-8	standard	65 mph / 105 km/h	-	31,000 lb / 14,000 kg	5
S-9	standard	65 mph / 105 km/h	0.6 s / 17 m	31,000 lb / 14,000 kg	5
C-1	combined*	65 mph / 105 km/h	-	65,000 lb / 29,400 kg	3

\*combined = aerodynamic(control vehicle) + standard (test vehicles)



vehicle shape, speed, or weight, a baseline test segment was first performed with the vehicles spaced a quarter track length (1.6 km / 1.0 mi) from each other to represent the undisturbed non-platoon scenario (test cases A-1, S-1, S-6, S-8). In addition, to provide a link between the standard-trailer data set and the aerodynamic-trailer data set, an independent-vehicle test segment was performed to characterize the influence of the aerodynamic devices applied to the trailer (test case C-1), separate from the influence of the platoon.

## 2.5 Fuel Consumption Measurements

### 2.5.1 Fuel System Modifications

Auxiliary fuel tanks were installed on each tractor to allow measurement of the fuel used during each run. These were mounted on the frame rails in the tractor-trailer gap (see Figure 2.6). To allow switching between the stock fuel tanks and the auxiliary fuel tank, the manufacturer-installed fuel line connected to the input of the truck fuel filter was removed, capped off, and replaced by a NRC-installed hose. This NRC-installed hose was run from the fuel filter to the auxiliary fuel tank. The new supply fuel hose was connected to the auxiliary tank using flat face double ended shutoff (quick couplers). Fuel-line routing for the stock tanks and for the auxiliary tank are shown in Figure 2.7.

Figure 2.7 (A) shows the stock fuel system routing where the fuel is supplied from the two manufacturer-installed side fuel tanks. Figure 2.7 (B) shows the modifications performed to the truck fuel system routing to allow the NRC installed tank to provide fuel to the truck engine. Figure 2.7 (C) shows the modifications performed to the truck fuel system hose routing to allow the NRC installed tank to be switched over to the manufacturer-installed side fuel tanks. This configuration allowed the truck to operate from the manufacturer side fuel tanks when in transit to and from the NRC Ottawa campus, where the fuel-system modifications were performed, and the PMG test track in Blainville.

### 2.5.2 Fuel Tank Filling

Diesel fuel was stored in a large above ground storage tank located directly beside the truck staging area on Bravo track. Fuel was transferred using an electric pump from the large track side storage fuel tank to two 40 gallon fuel drums housed in the bed of an NRC shop truck. When the test trucks required refueling the NRC shop truck was driven onto Bravo track beside each test truck and fuel was transferred from the 40 gallon fuel drums to the test truck auxiliary installed fuel tank. Figure 2.6 shows the maximum fuel fill level of the auxiliary tanks. A sight glass on the right side of the tanks was used to confirm the tank fill level.

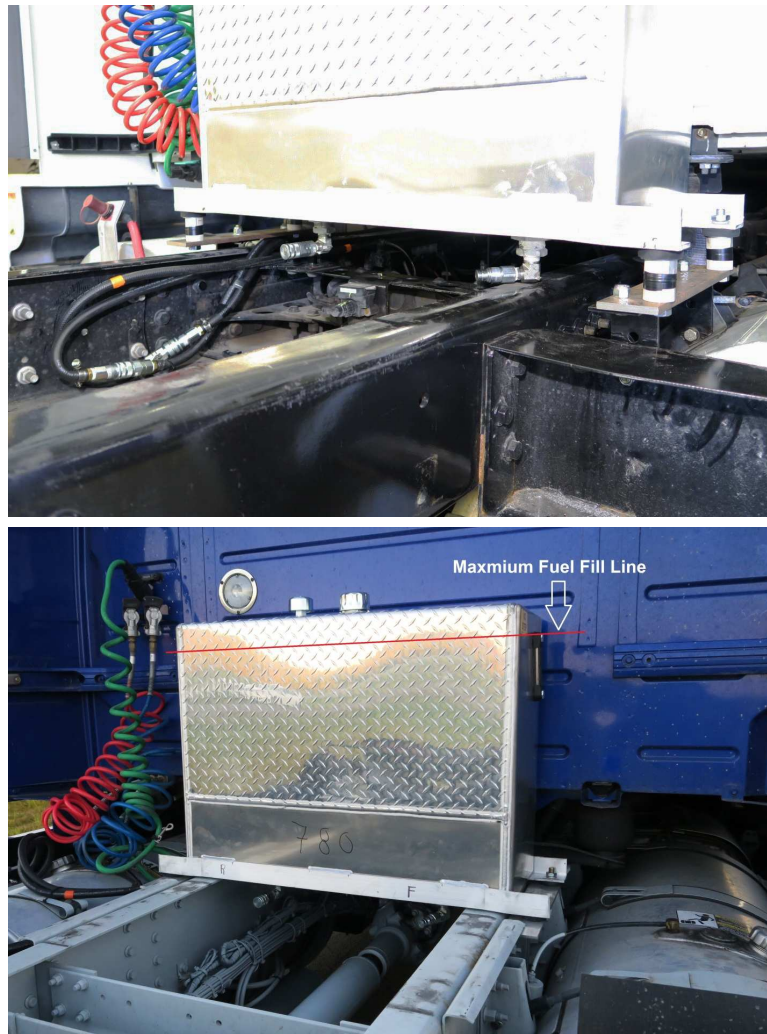

**Figure 2.6:** Fuel tank installed on frame rails behind the tractor cab (top - control truck, bottom - test truck).

### 2.5.3 Fuel Measurement Instrumentation

An LCCA-500 S-beam load cell (500 lb range) was used to weigh the fuel tanks before and after each run. Calibration verifications were performed throughout the test program. Calibrated 20 kg weights were used to perform verifications in increments of 20 kg from 20 kg to 120 kg. Deviations between the recorded and actual weight were no greater than 0.03%.

### 2.5.4 Fuel Measurement Procedure

Figure 2.3 (Page 9) shows the three test trucks and the control truck parked for the fuel-weighing procedure between runs. The truck cabs were parked with an articulation angle

## Fuel-Economy Testing of a Three-Truck Platoon

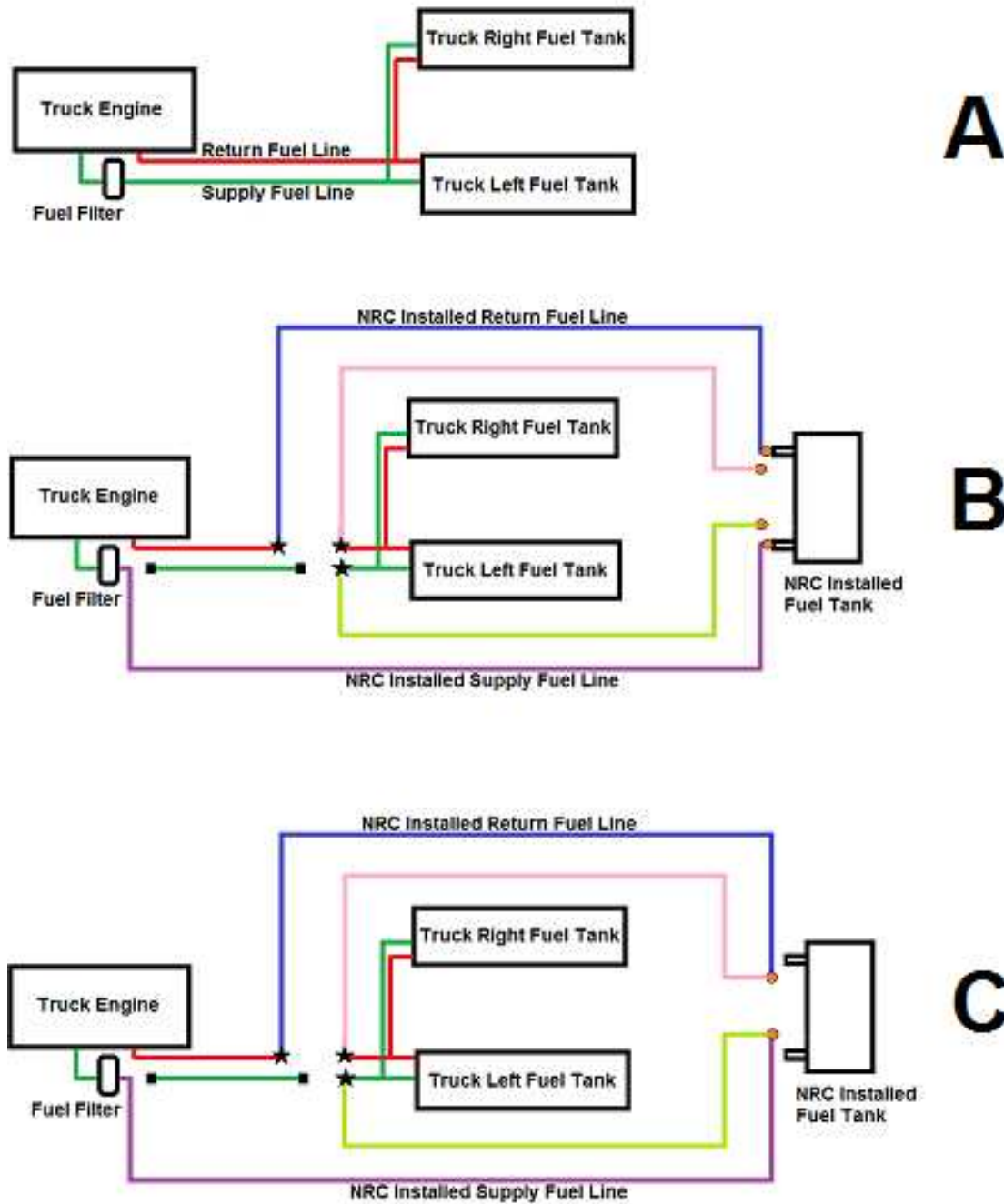

**Figure 2.7:** Fuel system routing (A - Truck 1, 2, 3 and Control stock fuel system routing, B - NRC modified fuel system routing configured to fuel engine from NRC installed fuel tank, C - NRC modified fuel system routing configured to fuel engine from truck main tanks).

## Fuel-Economy Testing of a Three-Truck Platoon

of approximate 15° in relation to the trailers, allowing easier forklift access to the auxiliary tank from the passenger side of the vehicle.

The fuel weighing procedure described below was repeated on Truck 1, Truck 2, Truck 3 and the Control Truck before and after each test run, and required 20 to 25 minutes to complete. Figure 2.8 shows a photograph taken during the weighing procedure.

1. A forklift was positioned with its forks raised and a boom attachment extended between the cab of the truck and its trailer.
2. The four nuts attaching the NRC installed fuel tank to the truck frame were removed using a cordless impact gun.
3. The fuel supply and return lines were disconnected, using the installed flat face double ended shut-off (quick couplers), from the fuel tank.
4. Data acquisition was started and the load cell was zeroed.
5. The load cell was raised into position by the forklift above a lifting sling which is wrapped vertically around the auxiliary fuel tank.



Figure 2.8: Photograph of auxiliary fuel-tank weighing procedure.

6. The lifting sling was attached to a hook connected below the load cell and raised until the auxiliary fuel tank was clear of its mounting position on the truck.
7. The tank was steadied to ensure minimal swaying and a visual check was performed to ensure the tank was not in contact with any part of the truck before a reading was captured by the data acquisition system.
8. The fuel tank remained raised until a minimum of 10 consecutive seconds of stable data were obtained before being lowered back onto its mounting location on the truck.
9. The four fuel tank mounting nuts were reinstalled and tightened with a cordless impact gun.
10. The quick coupler fuel supply and return lines were reconnected to the fuel tank, and a visual inspection was performed for any fuel leaks.

### 2.5.5 Regenerations

For both truck types used, once the manufacturer-predetermined diesel particulate filter (DPF) soot level is exceeded, a regeneration process will occur while the truck is in operation. A regeneration cycle may last between 30-45 minutes. Additional fuel is used during this process compromising the accuracy for SAE J1321 fuel economy testing. The occurrence and timing intervals of the process is not obvious to the driver.

During official testing, only one unscheduled regeneration cycle was experienced on October 7<sup>th</sup> for the control truck. An additional test run was added to the test matrix as a replacement. The test trucks did not experience any unscheduled regeneration cycles during official testing. This was ensured by monitoring the vehicle-reported DPF soot levels after each run. If the soot level reading was close to the predetermined trigger level set by the truck manufacturer, a regeneration cycle was initiated manually.

### 2.5.6 Wind Measurements

Site and track-side wind measurements were performed during the test campaign. An on-site weather station, positioned at 10 m height and approximately 50 m from the track provides the wind speed and direction, along with the temperature and barometric pressure. For segments of the test, 10-minute mean data were available from this anemometer, with hourly means available at all other times. To collect wind data closer to the track and at vehicle mid-height, an ultrasonic anemometer was placed adjacent to the south-side straight segment of the track, 8 m from the track centreline, with the sensor 2 m above track surface. This track-side ultrasonic anemometer was used as the primary reference to gauge the wind speeds experienced by the truck, with the weather-station data used as a secondary reference. The wind-data measured during the test runs, including the minima, means, and maxima and the wind roses for each run, are provided in Appendix B.

## 2.6 Test Procedure

### 2.6.1 Daily Pre-Test Checks

Test staff arrived at the test track daily between 6:00 and 7:00 AM. Tire pressure and vehicle visual inspections were performed by PIT and NRC personnel. CFTR drivers performed an industry standard pre-trip inspection on their designated truck and trailer noting any deficiencies. The drivers also thoroughly cleaned the truck wind shields and mirrors.

### 2.6.2 Specific Test Procedures

Three types of test runs were completed during the test campaign. For each, the vehicles travelled 103 km (64 miles, 16 laps).

1. Baseline test segment - Vehicle fuel consumption is measured simultaneously for all the vehicles (control and test) spaced approximately 1.6 km from each other, forming the reference measurements against which the test segments will be compared (vehicle configuration shown in top image of Figure 2.5). This procedure is listed in Figure 2.9 and shown schematically in Figure 2.10.
2. Independent vehicle test segment - Vehicle fuel consumption is measured in the same manner as the Baseline Segment, but with changes made to the test vehicles (vehicle configuration in top image of Figure 2.5). This procedure is listed in Figure 2.9 and shown schematically in Figure 2.10.
3. Platooning test segment - Vehicle fuel consumption is measured with the three test trucks in a platoon formation spaced approximately 3.2 km from the control vehicle (vehicle configuration shown in bottom image of Figure 2.5). This procedure is listed in Figure 2.11 and shown schematically in Figure 2.12.

## Fuel-Economy Testing of a Three-Truck Platoon

Baseline and Independent-Vehicle Test Procedure	
Truck 1	Key on and wait 15 seconds for systems to run diagnostic check
Truck 1	Engine start and idle for 10 seconds
Truck 1	Driver receives radio count down from 5 seconds to 0
Truck 1	Departure
Wait 65 seconds	
Truck 2	Key on and wait 15 seconds for systems to run diagnostic check
Truck 2	Engine start and idle for 10 seconds
Truck 2	Driver receives radio count down from 5 seconds to 0
Truck 2	Departure
Wait 65 seconds	
Truck 3	Key on and wait 15 seconds for systems to run diagnostic check
Truck 3	Engine start and idle for 10 seconds
Truck 3	Driver receives radio count down from 5 seconds to 0
Truck 3	Departure
Wait 65 seconds	
Truck 4	Key on and wait 15 seconds for systems to run diagnostic check
Truck 4	Engine start and idle for 10 seconds
Truck 4	Driver receives radio count down from 5 seconds to 0
Truck 4	Departure
Truck 1, 2, 3 and Control complete 16 laps of Bravo track	
Radio confirmation with all drivers of final lap	
Truck 1	
Truck 1	Truck stopped at designated stop area (pylon marker)
Truck 1	Truck shifted to neutral and supply and service brakes engaged
Truck 1	Driver receives radio count down from 5 seconds to 0 before engine shut down
Truck 1	Engine shut down
Truck 2	
Truck 2	Truck stopped at designated stop area (pylon marker)
Truck 2	Truck shifted to neutral and supply and service brakes engaged
Truck 2	Driver receives radio count down from 5 seconds to 0 before engine shut down
Truck 2	Engine shut down
Truck 3	
Truck 3	Truck stopped at designated stop area (pylon marker)
Truck 3	Truck shifted to neutral and supply and service brakes engaged
Truck 3	Driver receives radio count down from 5 seconds to 0 before engine shut down
Truck 3	Engine shut down
Truck 4	
Truck 4	Truck stopped at designated stop area (pylon marker)
Truck 4	Truck shifted to neutral and supply and service brakes engaged
Truck 4	Driver receives radio count down from 5 seconds to 0 before engine shut down
Truck 4	Engine shut down

**Figure 2.9:** Test procedure for baseline test and independent-vehicle test segments.



Fuel-Economy Testing of a Three-Truck Platoon

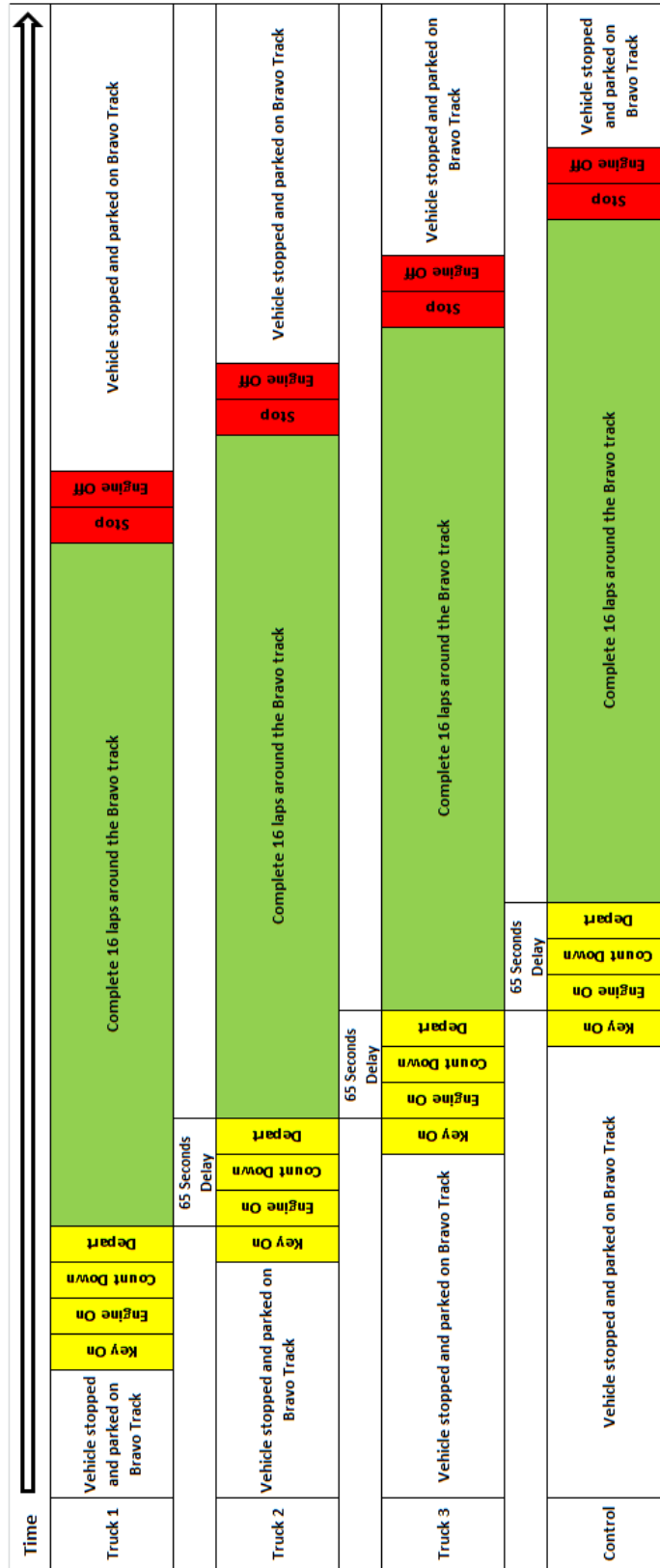

Figure 2.10: Schematic representation of test procedure for baseline test and independent-vehicle test segments.



## Fuel-Economy Testing of a Three-Truck Platoon

<b>Platooning Test Procedure</b>	
Truck 1 /2 /3	Key on and wait 15 seconds for systems to run diagnostic check
Truck 1 /2 /3	Engine start and idle for 10 seconds
Truck 1 /2 /3	Driver receives radio count down from 5 seconds to 0
Truck 1 /2 /3	Departure from staging area on Bravo track
Control	Held at start staging area on Bravo track
Trucks 1, 2, and 3 radio confirmation received indicating successful linking (platooning)	
Trucks 1, 2, and 3 complete 1/3 of first lap around Bravo track	
Control	Key on and wait 15 seconds for systems to run diagnostic check
Control	Engine start and idle for 10 seconds
Control	Driver receives radio count down from 5 seconds to 0
Control	Departure from staging area on Bravo track
Truck 1, 2, 3 and Control complete 16 laps of Bravo track	
Radio confirmation with all drivers of final lap	
Truck 1 /2 /3	Truck stopped at designated stop area (pylon marker)
Truck 1 /2 /3	Truck shifted to neutral and supply and service brakes engaged
Truck 1 /2 /3	Driver receives radio count down from 5 seconds to 0 before engine shut down
Truck 1 /2 /3	Engine shut down
Control	Truck stopped at designated stop area (pylon marker)
Control	Truck shifted to neutral and supply and service brakes engaged
Control	Driver receives radio count down from 5 seconds to 0 before engine shut down
Control	Engine shut down

**Figure 2.11:** Test procedure for platooning test segments.

Fuel-Economy Testing of a Three-Truck Platoon

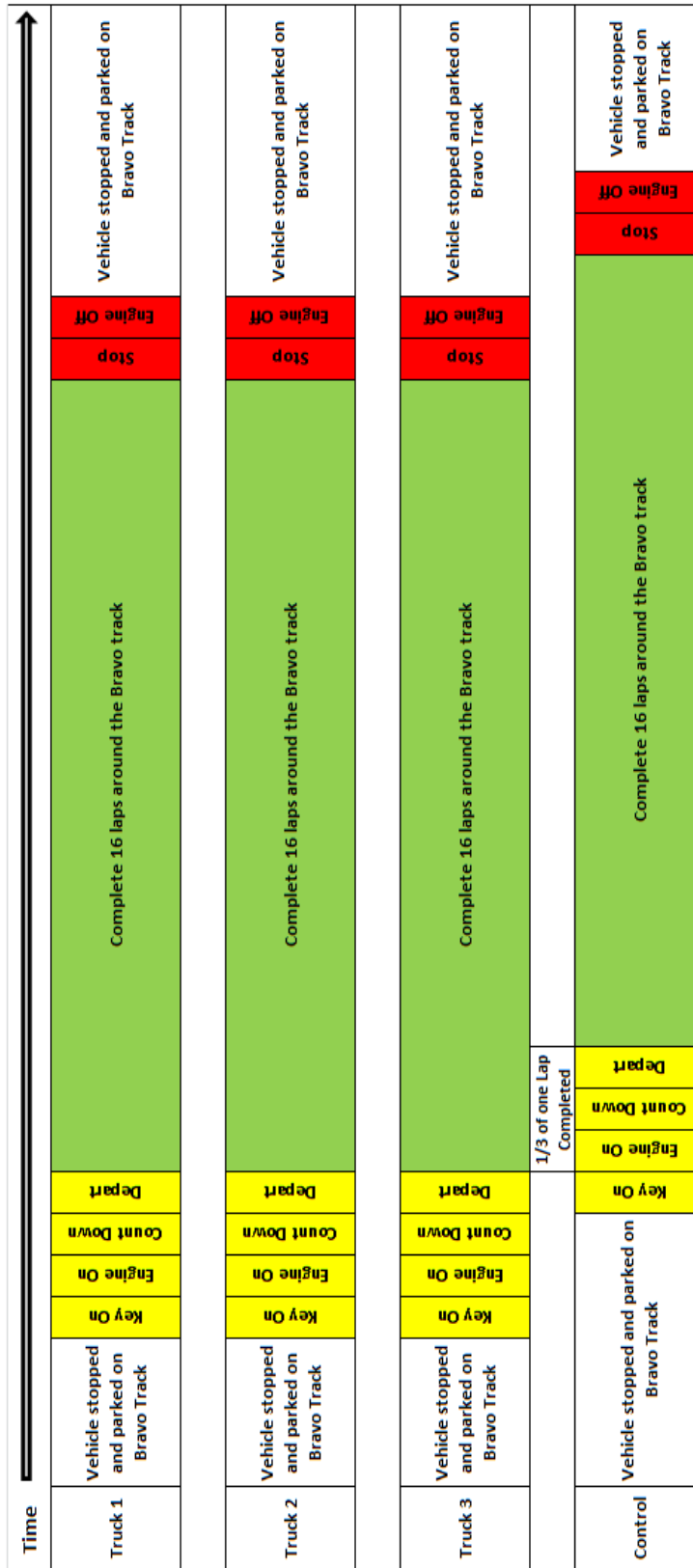

Figure 2.12: Schematic representation of test procedure for platooning test segments.



## 3. Results and Discussion

### 3.1 Data Analysis

The fuel-consumption data have been analysed using the method described in the SAE J1321 Type II procedure (SAE J1321, 2012). The method was devised to minimize the influence of environmental and external factors that may change from run to run or from day to day. It makes use of fuel-use ratios between the test vehicles and the control vehicle, and relies on an assumption that the change in external factors affects the control vehicle in the same manner as the test vehicles. The ratio of test-vehicle (T) fuel use to the control-vehicle (C) fuel use is defined as:

$$T/C = \frac{\Delta W_{F,test}}{\Delta W_{F,control}} \quad (3.1)$$

where  $\Delta W$  represents the weight of the fuel consumed for the respective vehicle during a measurement run. The fuel-savings measure is based on averages of the T/C ratios from the respective baseline runs and test runs and calculated according to:

$$\Delta F = \frac{\overline{(T/C)_{baseline}} - \overline{(T/C)_{test}}}{\overline{(T/C)_{baseline}}} \quad (3.2)$$

SAE J1321 (2012) includes a spreadsheet that performs the above calculation along with an estimate of the measurement uncertainty. Data quality checks, described in SAE J1321 (2012), are performed by means of a comparative statistical analysis to define the validity of a measured  $\Delta F$  value and assign an uncertainty value associated with a 95% confidence interval.

The test matrix was shown in Figure 2.2 on Page 11. To evaluate the combined influence of aerodynamic technologies and the CACC platooning system, the C-1 test case was performed to provide a link between standard-trailer test cases (S-1 to S-5) and the aerodynamic-trailer test cases (A-1 to A-5). In addition, when using case A-1 as a baseline, test case C-1 provides a measure of the fuel increase associated with removing the aerodynamic technologies from the trailers. Equation 3.2 can be used, with the “test” and “baseline” terms interchanged to provide the fuel savings associated with adding the aerodynamic devices to the standard trailer.

To calculate the fuel savings associated with the combination of aerodynamic devices and the CACC system for a given separation distance, the following equation relates the aerodynamic-trailer platooning test results to the standard-trailer independent-vehicle test results:

$$\Delta F_{PA/S} = \frac{\Delta F_{PA/A} - \Delta F_{S/A}}{1 - \Delta F_{S/A}} \quad (3.3)$$

where subscript *PA/S* represents the fuel savings of the Platoon and Aerodynamic trailer relative to the Standard trailer, where *PA/A* represents the fuel savings of the Platoon and Aerodynamic trailer relative to the Aerodynamic trailer, and *S/A* represents the fuel savings of the Standard trailer relative to the Aerodynamic trailer. Combining results in this manner does not provide a direct method to calculate the associated measurement uncertainty, as is done

for the SAE J1321 procedure. To provide an estimate of the uncertainty, it has been assumed that the uncertainties of the two independent parameters ( $\delta\Delta F_{PA/A}$  and  $\delta\Delta F_{S/A}$ ) are independent, and as such, a combined uncertainty on  $\Delta F_{PA/S}$  can be defined as

$$\delta\Delta F_{PA/S} = \sqrt{\delta\Delta F_{PA/A}^2 + \delta\Delta F_{S/A}^2}. \quad (3.4)$$

To gauge the influence of vehicle speed or weight on the fuel-savings potential of platooning systems, it is important to understand the manner in which the fuel use is expected to differ for changes in speed and weight of an independent vehicle. This can be estimated by evaluating the road load experienced by a vehicle under constant-speed conditions:

$$F_{RL} = F_{Aero} + F_{RR} + F_{Grade} \quad (3.5)$$

For the current test program undertaken on a track, the grade influence is negligible because the vehicle does not attain a net increase in elevation over the test, hence  $F_{Grade} = 0$ .

The aerodynamic drag force is the parameter of most interest for the current investigation. The drag force for a vehicle can be defined as

$$F_{Aero} = Q C_D(\psi) A \quad (3.6)$$

where  $Q$  is the dynamic pressure,  $C_D(\psi)$  is the drag coefficient and assumed to be a function of the wind yaw angle relative to the vehicle  $\psi$ , and  $A$  is the vehicle reference area (typically the frontal area). The dynamic pressure of the wind ( $Q$ ) is dependent on the air density ( $\rho$ ) and wind speed relative to the vehicle ( $U$ ):

$$Q = \frac{1}{2} \rho U^2 \quad (3.7)$$

As a first-order approximation for long-distance testing, the yaw-variability of the drag coefficient can be averaged and represented by a wind-averaged-drag coefficient  $WAC_D$ , with the reference wind speed equivalent to the vehicle ground speed  $U_g$ . Therefore

$$F_{Aero} = \frac{1}{2} \rho U_g^2 WAC_D A \quad (3.8)$$

No significant change in  $WAC_D$  is expected for the vehicle speed changes evaluated during the test program.

The rolling resistance ( $F_{RR}$ ) associated with the tire contact with the road is caused primarily by deformation of the tire material while in motion and is most influenced by the weight supported by the wheels. As a first-order approximation, the net rolling resistance for the vehicle can be assumed a function of the vehicle weight ( $W$ ) and a rolling resistance coefficient ( $\mu$ ):

$$F_{RR} = \mu W \quad (3.9)$$

No significant change in the rolling-resistance coefficient would be expected for the changes in vehicle weight and speed evaluated during the test program.

Combining the assumptions above, the vehicle road load is approximated by

$$F_{RL} = \frac{1}{2} \rho U_g^2 WAC_D A + \mu W \quad (3.10)$$

**Table 3.1:** Estimates of drag force, rolling resistance, and road load for an individual tractor-trailer at the ground speeds and weights tested.

Vehicle Speed $U_g$	Vehicle Weight $W$	Drag Force $F_{Aero}$	Rolling Resistance $F_{RR}$	Road Load $F_{RL}$
105 km/h (65 mph)	29,400 kg (65 klb)	3,090 N (690 lbf)	1,740 N (390 lbf)	4,830 N (1,090 lbf)
89 km/h (55 mph)	29,400 kg (65 klb)	2,210 N (500 lbf)	1,740 N (390 lbf)	3,950 N (890 lbf)
105 km/h (65 mph)	14,000 kg (31 klb)	3,090 N (690 lbf)	780 N (180 lbf)	3,870 N (870 lbf)

In the subsequent discussions of this report, the speed-change and weight-change results are evaluated in the context of what might be estimated as a change due to the aerodynamic drag reduction associated with vehicle platooning. The following assumptions are used for these estimates:

- $\rho = 1.2 \text{ kg/m}^3$
- $WAC_D = 0.57$
- $A = 10.7 \text{ m}^2$
- $\mu = 0.006$

from which the road-load has been estimated and is provided in Table 3.1 for the combination of vehicle speed and weight tested.

## 3.2 Fuel-Savings Measurement Results

The test results from the SAE J1321-based fuel consumption tests are provided in Table 3.2. The calculated fuel-savings values are associated with either the addition of aerodynamic devices to the trailers under isolated driving conditions (*Test Variable* = aero dev.), the platooning effect from use of the CACC system (*Test Variable* = CACC), or the combination of aerodynamic devices and platooning (*Test Variable* = CACC+aero). The “aero dev.” and “CACC” effects have been evaluated from the respective *Test Case* and *Ref. Case* runs using Equation 3.2. The “CACC+aero” results make use of Equation 3.3 to combine individual results to evaluate the combined effects.

The fuel consumed by the vehicles during each measurement run is documented in Table B.1 of Appendix B. The run-to-run variability of the fuel consumed by the control truck demonstrates the necessity for its use as part of the J1321 test procedure. For example, the fuel consumed by the aerodynamically-treated control truck varied between 27.8 kg (61.1 lbs) and 30.0 kg (66.1 lbs) during the 105 km/h (65 mph) test runs. These run-to-run differences (>7%) are of the same magnitude as the fuel-savings associated with the aerodynamic devices applied to the trailer or from the platooning effect, the results of which are discussed in the remaining sections of this chapter. This variability is largely a result of the changing environmental conditions. For these runs the mean winds varied between 1 km/h and 14 km/h and the mean

Table 3.2: Results from fuel consumption tests.

Test Variable	Separation Distance/Time	Trailer Configuration	Vehicle Speed	Vehicle Weight	Test Case	Ref. Case	Lead Truck Fuel Savings	Middle Truck Fuel Savings	Trailing Truck Fuel Savings	Platoon Fuel Savings
aero dev.	-	combined	105 km/h	29,400 kg	C-1	A-1	7.6% ±1.9%	7.5% ±1.8%	6.3% ± 1.4%	7.1% ± 1.1%
CACC	43.6 m / 1.5 s	aerodynamic	105 km/h	29,400 kg	A-2	A-1	0.3% ±1.2%	6.7% ±1.9%	10.4% ±1.4%	5.8% ±1.0%
CACC	34.9 m / 1.2 s	aerodynamic	105 km/h	29,400 kg	A-3	A-1	-0.4% ±0.7%	7.2% ±1.9%	10.4% ±1.5%	5.7% ±0.8%
CACC	26.2 m / 0.9 s	aerodynamic	105 km/h	29,400 kg	A-4	A-1	0.3% ±1.0%	8.4% ±1.9%	11.7% ±1.4%	6.8% ±0.9%
CACC	17.4 m / 0.6 s	aerodynamic	105 km/h	29,400 kg	A-5	A-1	1.0% ±0.7%	9.4% ±1.5%	12.3% ±1.3%	7.6% ±0.8%
CACC	43.6 m / 1.5 s	standard	105 km/h	29,400 kg	S-2	S-1	0.0% ±1.1%	6.2% ±1.5%	9.5% ±1.8%	5.2% ±1.4%
CACC	34.9 m / 1.2 s	standard	105 km/h	29,400 kg	S-3	S-1	-0.4% ±1.2%	6.1% ±1.1%	9.8% ±1.3%	5.2% ±1.2%
CACC	26.2 m / 0.9 s	standard	105 km/h	29,400 kg	S-4	S-1	-0.7% ±0.4%	6.3% ±0.6%	9.9% ±0.9%	5.2% ±0.6%
CACC	17.4 m / 0.6 s	standard	105 km/h	29,400 kg	S-5	S-1	0.3% ±1.1%	7.4% ±1.1%	11.0% ±1.2%	6.2% ±1.1%
CACC+aero	43.6 m / 1.5 s	aerodynamic	105 km/h	29,400 kg	A-2	A-1/C-1	7.9% ±2.4%	13.7% ±2.7%	16.0% ±2.0%	12.5% ±1.5%
CACC+aero	34.9 m / 1.2 s	aerodynamic	105 km/h	29,400 kg	A-3	A-1/C-1	7.2% ±2.2%	14.2% ±2.7%	16.1% ±2.1%	12.5% ±1.4%
CACC+aero	26.2 m / 0.9 s	aerodynamic	105 km/h	29,400 kg	A-4	A-1/C-1	7.9% ±2.3%	15.3% ±2.7%	17.3% ±2.0%	13.5% ±1.5%
CACC+aero	17.4 m / 0.6 s	aerodynamic	105 km/h	29,400 kg	A-5	A-1/C-1	8.5% ±2.2%	16.2% ±2.5%	17.9% ±2.0%	14.2% ±1.4%
CACC	17.4 m / 0.71 s	standard	89 km/h	29,400 kg	S-7	S-6	1.6% ±0.8%	7.6% ±1.1%	10.5% ±1.4%	6.6% ±1.0%
CACC	17.4 m / 0.6 s	standard	105 km/h	14,000 kg	S-9	S-8	1.4% ±1.6%	9.6% ±1.8%	12.1% ±1.1%	7.8% ±1.5%

temperature varied between 8°C and 24°C. For each test condition (combination of speed, trailer configuration, and weight), the fuel-consumption measurements for the control vehicle also demonstrate a general trend towards increased fuel use with ambient wind speed (not shown here).

### 3.3 Influence of Aerodynamic Treatments

Combining test cases A-1 and C-1 provides a measure of the potential fuel-savings associated with the side-skirts and boat-tail devices applied to the trailer. The first row of Table 3.2 provides the individual fuel-savings measurements associated with this aerodynamic device-package for the trailer, for each of the three trucks as well as the combined fuel savings for the three-vehicle fleet. Trucks 1 and 2 experienced nearly the same fuel savings from the aerodynamic devices, however Truck 3 experiences a fuel savings more than a percent lower than the other two vehicles, although the differences are within the statistical uncertainty of the measurements. These results, which represent the same technologies applied to identical vehicles, highlight the variability of fuel-economy testing for aerodynamic technologies. This variability may be the result of differences in vehicle performance, sensitivity to installation, or driver technique.

### 3.4 Influence of Separation Distance on Platooning Performance

The effect of vehicle separation distance on fuel consumption was investigated for the two trailer configurations (standard and aerodynamic), for which the fuel-savings measurements for the individual vehicles are presented in Figure 3.1. For this vehicle speed of 105 km/h (65 mph), the corresponding time-gap axis is shown on the upper edge of the plot.

The data in Figure 3.1 show that, for each respective trailer configuration, the middle and trailing vehicles experience fuel savings in excess of 6%, with a general trend of decreasing fuel savings with increasing separation distance. The trailing vehicle experiences the greatest fuel savings. This observation is also apparent in the three-truck platoon data of Tsugawa *et al.* (2011) for longer separation distances, and contrasts the trends at separation distances shorter than those tested here for which the middle vehicle was shown by Tsugawa *et al.* (2011) to experience the greater fuel savings.

The lead vehicle for both trailer configurations is shown to experience little to no change in fuel use for the range of separation distances tested here. The data summary presented by NACFE (Roberts *et al.*, 2016) for two-truck platoons shows that the majority of road/track-test campaigns have observed a consistent trend in fuel savings for the lead vehicle at separation distances below approximately 15 m to 18 m (50 ft to 60 ft), beyond which no significant fuel savings have been observed. With the shortest distance of 17.4 m in the current study, the negligible fuel savings measured for the lead vehicle is therefore consistent with other studies.

The negligible change in fuel savings for the lead vehicle provides some evidence to explain the differences between the middle and trailing vehicles. If the lead vehicle does not experi-



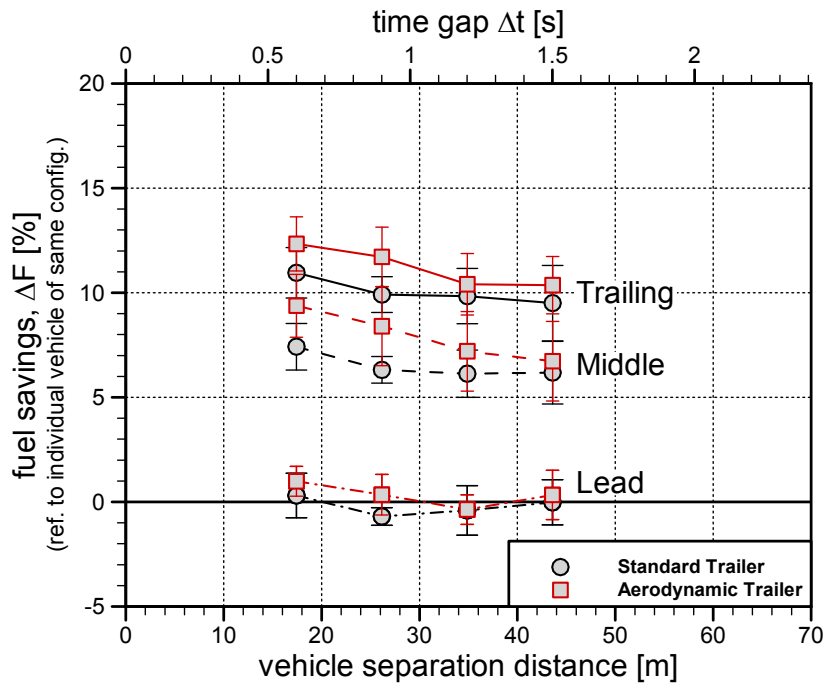

**Figure 3.1:** Variation in fuel-savings measurements with separation distance for each vehicle in the platoon, vehicle speed of 105 km/hr, vehicle mass of 29,400 kg (measurements referenced to respective vehicle configurations in non-platooned arrangement).

ence a measurable fuel savings at the shortest separation distance, it would therefore not be expected that the middle vehicle experience any influence of the trailing vehicle. The middle-vehicle fuel savings is therefore dominated by the low-speed air-wake of the lead vehicle. The trailing vehicle experiences a greater fuel savings than the middle vehicle likely due to a compounding effect of the low-speed air-wakes of the lead and middle vehicles, producing an air-wake with a greater wind-speed deficit (relative to the moving vehicles) than the air-wake of an individual vehicle.

The data in Figure 3.1 shows that, for the middle and trailing vehicles specifically, a greater fuel savings was measured for the aerodynamic-trailer tests, compared to the standard trailer. The aerodynamic-trailer configuration shows a fuel-savings higher by 0.5% to 2%, with the largest differences at shorter separation distances. Part of this difference is due to the fact that the aerodynamic-trailer configuration has a lower starting drag, and hence lower road load, than the standard trailer. If the reduction in absolute aerodynamic drag associated with platooning were the same for each configuration, the aerodynamic-trailer configuration will demonstrate a larger percentage-based fuel savings as a result of its lower starting value. However, this effect is estimated to provide a difference on the order of 0.5%. Therefore, the results here provide a strong indication that a greater fuel savings, from an absolute sense (litres/km), will be experienced by platoons outfitted with aerodynamic trailers.

At the shortest separation distance examined (17.4 m), the standard-trailer configuration experiences a 7.4% and 11.0% fuel savings for the middle and trailing vehicles, respectively,

whereas the aerodynamic-trailer configuration experiences 9.4% and 12.3% fuel savings, respectively. At the longest separation distance of 43.6 m, the middle and trailing vehicles for the standard trailers experience 6.2% and 9.5%, with the aerodynamic-trailer configurations experiencing 6.7% and 10.4% fuel savings. The results of Figure 3.1 also show nearly-constant fuel savings for separation gaps beyond 22 m for the standard-trailer configuration. These results provide an indication that fuel savings are achieved for vehicles in moderately-close proximity, and do not necessarily require small separation distances to achieve measurable fuel savings. These results do not provide an indication of the distance at which the effect of vehicle platooning no longer yields a beneficial influence. Smith *et al.* (2014) discuss the scenario whereby vehicles are likely already experiencing a fuel savings when travelling in moderate to heavy traffic conditions. It is, therefore, important to understand the true potential of vehicle platooning on fuel savings compared to what is already being experienced in general traffic conditions on the road.

The results of Figure 3.1 show that each vehicle in the platoon experiences a different level of fuel savings. The change in fuel savings with separation distance of the full platoon, assuming it behaves as a system, are presented in Figure 3.2. These values could also represent an average fuel savings per vehicle, if the vehicles changed positions sufficiently often to achieve the same savings for each vehicle. The results show that a fuel-savings of at least 5% for the full platoon is achievable for the range of separation distances examined, with up to 7.6% fuel savings at 17.4 m for the aerodynamic-trailer platoon. Both the standard-trailer and aerodynamic

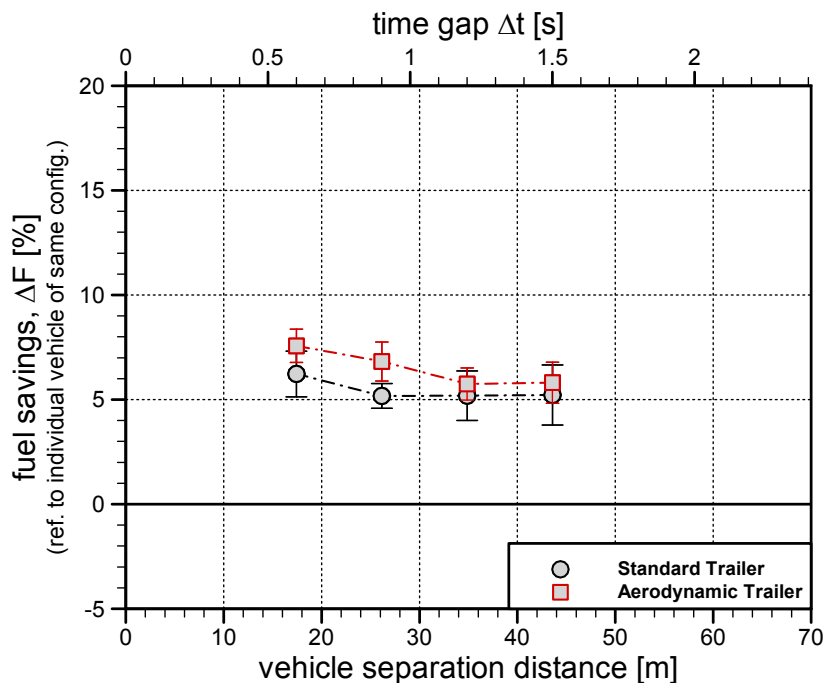
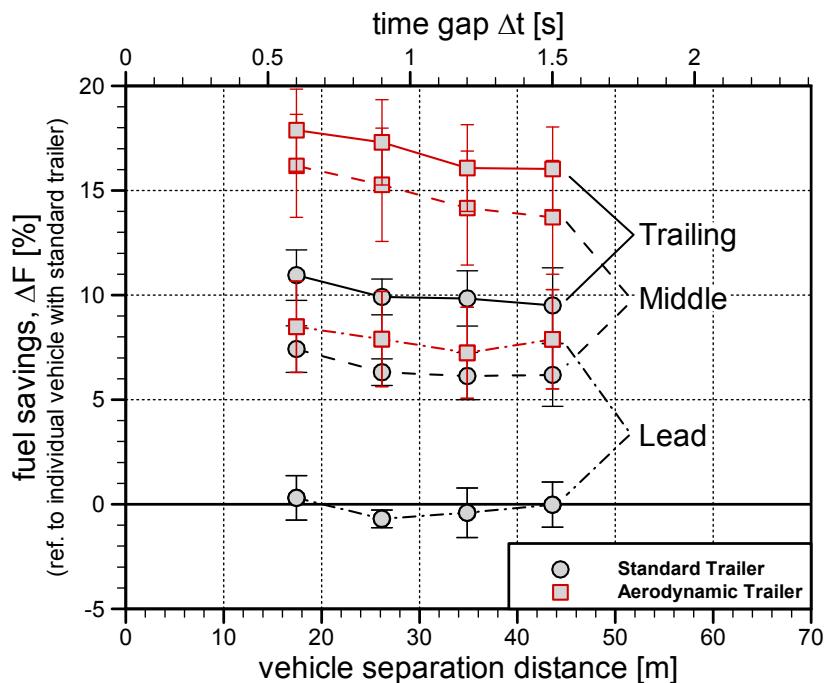

**Figure 3.2:** Variation in fuel-savings measurements with separation distance for the complete platoon, vehicle speed of 105 km/hr, vehicle mass of 29,400 kg (measurements referenced to respective vehicle configurations in non-platooned arrangement).

trailer configurations show a plateau in the fuel savings at the two largest separation distances tested, further indicating the need to understand the fuel savings achieved in general traffic conditions.

In addition to investigating the platoon influence alone, or the aerodynamic devices alone as described in the previous section, the combined effects of side-skirts, a boat-tail, and the CACC platooning system were also calculated from the data set, using Equation 3.3. Figure 3.3 shows these results. The format of the figure is similar to Figure 3.1 except that the data for both configurations (standard and aerodynamic trailers) are referenced to the standard-trailer tests. Here, the compounded effect of the CACC system with the aerodynamic trailer technologies results in individual-vehicle fuel savings of the trailing vehicle up to 17.9% at the shortest separation distance and 16.0% at the longest distance tested.

The full-platoon fuel-savings measurements for both trailer configurations, referenced to the non-platooned standard-trailer, are presented in Figure 3.4. These data show that the full platoon experiences a fuel savings associated with the CACC system and the aerodynamic trailer technologies, up to 14.2% at the shortest separation distance and 12.5% at the longest distance tested.



**Figure 3.3:** Variation in fuel-savings measurements with separation distance for each vehicle in the platoon, vehicle speed of 105 km/hr, vehicle mass of 29,400 kg (all measurements referenced to standard-trailer configuration in non-platooned arrangement).

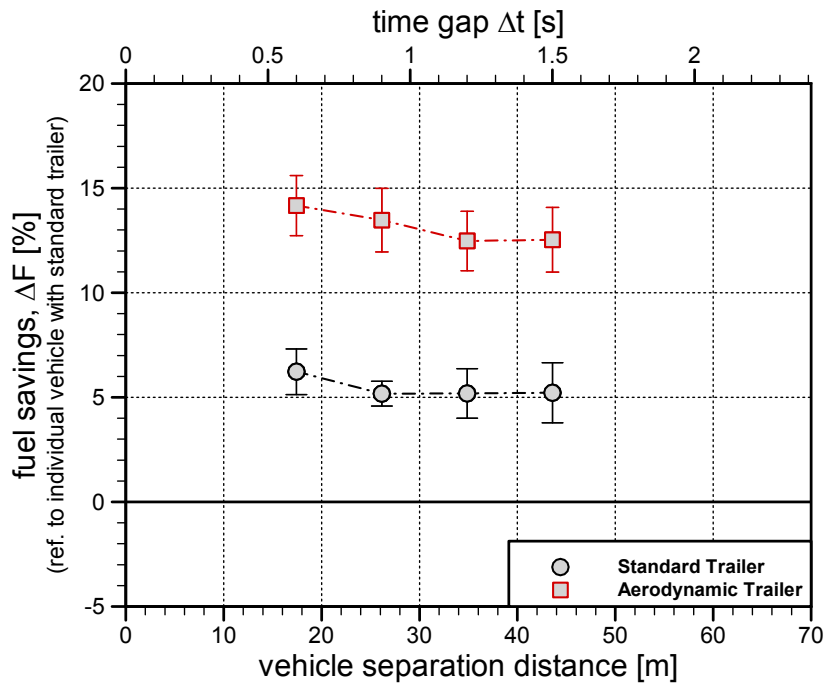
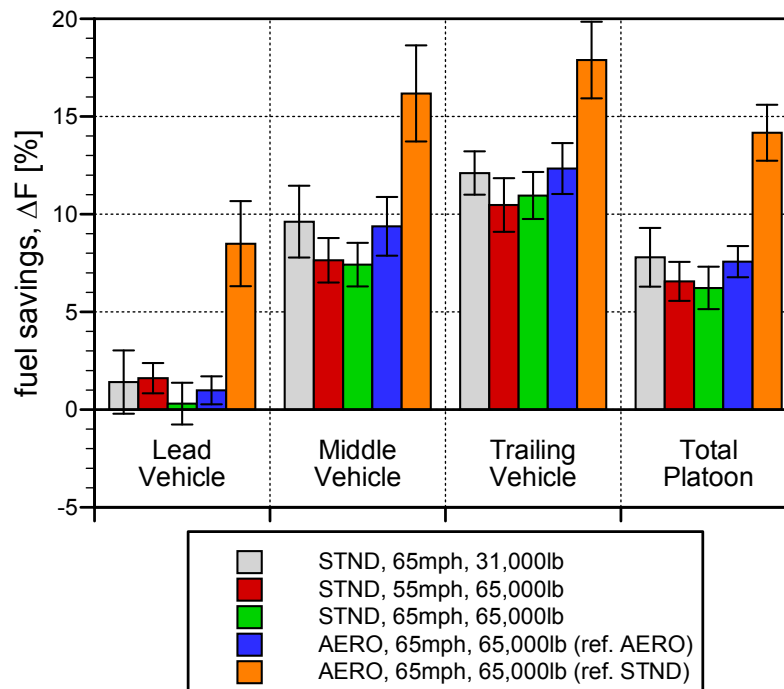

**Figure 3.4:** Variation in fuel-savings measurements with separation distance for the complete platoon, vehicle speed of 105 km/hr, vehicle mass of 29,400 kg (measurements referenced to standard-trailer configuration in non-platooned arrangement).

### 3.5 Influence of Vehicle Speed and Weight on Platooning Performance

After completion of the separation-distance tests with both trailer configurations, additional tests to evaluate the influence of vehicle speed and weight were performed at the shortest separation gap of 17.4 m using the standard-trailer configuration. For Test Cases S-6 and S-7, the vehicle mass/weight was retained (29,400 kg / 65,000 lb) and the speed was reduced to 89 km/h (55 mph). This resulted in a different separation time between the vehicles (0.7 s instead of 0.6 s). For Test Cases S-8 and S-9, the vehicle speed was retained (105 km/h / 65 mph) and the weight was reduced by unloading the trailers (14,000 kg / 31,000 lb). For each, baseline segment tests were first conducted such that the results represent the fuel savings associated with the platooning arrangement. These data are shown in Figure 3.5. Each set of bar graphs represents a vehicle in the platoon (first three sets), or the full platoon (fourth set), and each of the sets shows the fuel-savings measurements representing five test conditions. The weight-change and speed-change results (1<sup>st</sup>/grey and 2<sup>nd</sup>/red bars, respectively), are contrasted against the test data at 17.4 m distance discussed in the previous section. These previously-discussed data include the platooning influence on the standard- and aerodynamic-trailer configurations at their initial speed and weight (3<sup>rd</sup>/green and 4<sup>th</sup>/blue bars, respectively), as well as the combined effects of the platooning arrangement and the aerodynamic trailer devices, relative to the standard trailer (5<sup>th</sup>/orange bars).

## Fuel-Economy Testing of a Three-Truck Platoon



**Figure 3.5:** Fuel-savings measurements at a separation distance of 17.4 m for different trailer configurations, vehicle speeds, and vehicles weights.

The data of Figure 3.5 show that the vehicle position in the platoon has a much greater influence than does the trailer configuration, the vehicle speed, or the vehicle weight, within the range of these parameters tested. The lead vehicle shows the lowest fuel savings, with positive values on order of 1% for three of the four test conditions for which only the influence of the CACC system is represented in the measurements (first four bars). Although the uncertainty in the measurements does not show a statistically-representative fuel savings for all the conditions, the consistency in the trend indicates that the first vehicle is likely experiencing a small effect at this separation distance. As was noted previously, and is now shown for all conditions tested, the trailing vehicle experiences a higher fuel savings than the middle vehicle or lead vehicle.

The reduction in speed (2<sup>nd</sup> / red vs. 3<sup>rd</sup> / green bars of Figure 3.5) showed no significant change in the percentage fuel-savings from the platoon arrangement. As described in Section 3.1, aerodynamic drag scales with the square of the apparent wind speed ( $D \propto U^2$ , see Equations 3.6 and 3.7), so it is expected that a smaller fuel savings associated with the aerodynamic benefits of platooning would still be realized for a moderate speed reduction. Using the road load estimates of Table 3.1 combined with the % fuel savings measured at the higher vehicle speed, and assuming fuel savings is solely due to a change in aerodynamic drag, it can be estimated that this change in vehicle speed will result in a reduction in fuel savings on the order or 1% or less. Although this trend is not observed in the measurements, this estimated difference is within the uncertainty level of the current measurements and may be masked by the experimental error.

Changing the vehicle weight (1<sup>st</sup>/grey vs. 3<sup>rd</sup>/green bars of Figure 3.5) had a greater effect on the fuel-savings performance from the platoon arrangement than the speed change, demonstrating a 1% to 2% higher fuel savings for the unloaded trailer tests compared to the loaded trailer tests. This higher fuel savings for the lighter vehicle is realized because the aerodynamic drag comprises a greater proportion of the the road load, due to reduced rolling resistance, and therefore a given change in drag provides a greater percentage change in the fuel use. Again, using the road load estimates of Table 3.1 combined with the % fuel savings measured at the higher vehicle weight, and assuming that the change in absolute aerodynamic drag is the same for both cases, it can be estimated that this change in vehicle weight will result in an increase in fuel savings on the order of 2%, consistent with the measurements. The measured fuel-savings associated with reduced vehicle weight is also of similar magnitude to that associated with platooning of the aerodynamic-trailer configuration (4<sup>th</sup>/blue bars).

The total platoon fuel-savings data (fourth set of bars in Figure 3.5) shows a variation in the effect of the CACC system between about 6% and 8%, at a separation distance of 17.4 m, for the range of speed, weight, and trailer configurations tested. At this shortest separation distance, the combined effect of aerodynamic trailer devices and the CACC system results in a full-platoon fuel savings of about 14%. To gauge the true potential for fuel savings from vehicle platooning systems, consideration will need to be given to the duty cycle associated with how often such vehicles will link in a platoon formation, and contrast those savings with the fuel savings already being realized by vehicles as a result of driving with other traffic on the road.



## 4. Conclusions and Recommendations

### 4.1 Conclusions

Track-based fuel-economy testing was undertaken to investigate the fuel-savings potential of a three-truck Cooperative Adaptive Cruise Control (CACC) platooning system. Tests were undertaken at Transport Canada's Motor Vehicle Test Centre in October 2016 to investigate the CACC system performance and the fuel-savings potential of the system at different vehicle separation distances, speeds, weights, and trailer configurations. The SAE J1321 Type II fuel consumption test procedure was used as a basis to provide reliable estimates of the fuel-savings potential of the platooning system.

For highway driving speeds investigated in this test program, the dominant factor affecting fuel-savings potential of the truck platoon system is the aerodynamic interactions amongst the three vehicles. The test program was devised to investigate the sensitivity of the potential fuel savings to separation distance (17.4 m to 43.6 m), vehicle speed (89 km/h and 105 km/h), vehicle mass/weight (14,000 kg and 29,400 kg) and the addition of aerodynamic trailer devices (side-skirts and boat-tail).

For the range of test conditions examined, the net fuel savings for the full vehicle platoon was measured to be between 5.2% and 7.8% compared to three vehicles travelling independently, and in isolation, from of each other. The combined effect of platooning and aerodynamic trailer devices was measured to be up to 14.2% at the shortest separation distance of 17.4 m.

The major findings of the study include:

- At the shorter separation distances tested, a decrease in fuel savings was observed with increasing distance. Beyond about 22 m for the standard trailer, for which the platoon-averaged fuel savings was measured to be 5.2%, no significant change in fuel savings was observed. For the aerodynamic trailer configuration, no significant change was observed beyond 34 m for which the platoon-averaged fuel-savings was measured to be 5.7%.
- The lead vehicle showed no significant fuel savings for the tested separation distances of 26 m and greater. At the shortest separation distance tested (17 m), a small fuel savings on the order of 1% was observed for some of the test conditions.
- For the range of separation distances tested (17 m to 44 m), and for the standard and aerodynamic trailer configurations, the trailing vehicle experienced the highest fuel savings of the three vehicles (approximately 3% higher than the middle vehicle).
- The aerodynamic-trailer configuration experienced a greater percentage fuel savings from platooning than did the standard-trailer configuration (0.5% to 2% higher depending on separation distance).
- No significant effect of vehicle speed on the fuel savings from the CACC platooning system was observed based on the tested speeds of 89 and 105 km/h (55 and 65 mph).



- An increased fuel savings of 1.6% associated with the vehicle CACC platooning system was observed for the empty trailer, compared to the loaded trailer.

## 4.2 Recommendations for Future Work

The results of this study have highlighted some of the potential fuel-savings benefits of vehicle platooning for a range of test conditions. Discussions have begun between TC, NRC and PATH for a second phase to the current study. To gain a better appreciation for the true benefits of a truck platooning system, the following extensions and additional studies are recommended to fill the remaining knowledge gaps:

1. *Shorter Separation Distances*: Based on the data presented in this report, as well as other truck platooning studies described in the literature, the vehicles are likely to experience greater levels of fuel savings at shorter distances than were tested (minimum tested was 17.4 m). In particular, shorter distances are likely required to observe measurable fuel savings of the lead truck. Shorter separation distances on the order of 9 m or less (separation times of 0.3 s or less at 105 km/h) are recommended, for which a 4-6% fuel savings is expected for the lead vehicle based on other test programs.
2. *Longer Separation Distances*: The longest separations in this report showed significant fuel savings for the middle and trailing vehicles (6-10%), with a low decay rate with distance indicating the potential for measurable fuel savings at much larger distances representative of typical non-platoon highway traffic conditions. Separation distances of 58 m and 87 m (separation times of 2.0 s and 3.0 s at 105 km/h) are recommended to characterize common highway conditions. These distances may provide a measure of the true baseline conditions against which vehicle platooning systems should be compared from a fuel-economy perspective.
3. *Two-Truck Platoon Performance*: The NACFE report (Roberts *et al.*, 2016) summarized several fuel-economy studies of predominantly two-truck platoons. The variability in vehicles and test conditions across the various test campaigns does not permit an assessment of the differences in benefits between a two-truck versus three-truck platoon. To understand these potential differences, and provide a link to these large data sets, one or two tests conditions/configurations should be repeated with only two trucks in the platoon.
4. *Lateral Offset*: Recent two-truck platooning studies on a track and in a wind tunnel have noted changes in the platoon performance when the trucks are not aligned axially (one offset laterally to the other). This is a scenario that may be encountered by non-steer-controlled platooning systems, especially with drivers that are not comfortable with the separation distances and veer to the side to have better forward visibility. To assess this influence, it is recommended to perform a test run with the middle truck purposely driving with an offset relative to the other trucks and the lane markers. This can provide an indication of changes to the fuel savings potential of such system and the possible necessity for steering control to provide maximum fuel savings benefits.

5. *Mismatched Trailers*: Recent wind-tunnel tests performed at NRC (McAuliffe and Ahmadi-Baloutaki, 2017) highlighted the differences in platoon drag reduction depending on whether the forward truck or the aft truck is outfitted with aerodynamic trailer devices. The differences between dry-vans and another trailer type (tanker, flatbed, grain-hauler, etc.) may also highlight such differences. It is recommended to perform mismatched-trailer tests with the middle truck differing from the lead and trailing trucks.
6. *Contrast Platooning to Long Combination Vehicles (LCV)*: LCVs consisting of tandem 53 ft dry-van trailers have been touted as having greater benefits in regards to freight efficiency. It is recommended to perform fuel-economy tests of an LCV with the same cargo volume and cargo weight as a two-truck platoon configuration. A different test procedure such as the more general SAE J1526 fuel consumption test procedure (SAE J1526, 2015) is recommended. An extension to this can be to add an additional vehicle to this scenario to test a three-truck platoon against a two-truck LCV platoon (single leading and LCV trailing).
7. *Drive-Cycle Changes and Platoon Interruptions*: The response rate of the CACC control system, and hence the power control of the engine, to changes in speed and platoon formation may also have an influence on the fuel savings potential of such systems. This can be evaluated by periodically changing the speed of the platoon during a test run. It can also be evaluated by creating a consistent set of cut-in events during the runs whereby a smaller vehicle purposely moves into the gap between vehicles and the CACC control system adjusts the platoon formation to increase the gap until such time as the target formation can be re-established. These types of tests are recommended to assess the fuel savings potential of the platooning system in representative operational conditions.
8. *Additional Measurements and Analysis*: In addition to the SAE J1321 Type II fuel consumption measurements, and the J1526 procedure noted in Item 6 above, other measurements may prove useful in characterizing the differences between platoon configurations and test results. The following additional measurements and analyses can be included in the next set of tests:
  - Wind measurements can be used to understand the changes to the aerodynamic performance and subsequently the fuel use of the vehicles during the measurement runs. This will allow a distinction between the effect of changes in the terrestrial winds from one run to the next, in contrast to the changes to the wind patterns experienced by the middle and trailing vehicles. It is recommended to outfit all four trucks (control + platoon) with fast-response pressure probes that will measure the transient winds the vehicles experience. Several track-side sonic anemometers are also required to calibrate each pressure probe for the vehicle flow-field perturbation.
  - Drive-shaft torque meters can be used to estimate aerodynamic drag of each vehicle using the “constant-speed” test methodology for road-load measurements. These measurements, in concert with on-board wind measurements, can provide an assessment of the changes in aerodynamic drag on the vehicle due to the platooning effect. These measurements can also allow delineation in the responsiveness of the CACC system for each of the three test vehicles, that can be used for further refine-

Fuel-Economy Testing of a Three-Truck Platoon

ments to the control systems. It is recommended to install and acquire data from driveshaft torque meters on all four test vehicles.

- Greater analysis and calibration of the vehicle CAN bus data for each vehicle. If calibrated appropriately against the fuel-consumption data and the environmental conditions (air temperature, air density and atmospheric pressure), the differences in vehicle performance and platoon performance between the straight and banked sections of the track can be distinguished. It is recommended that a detailed analysis of the CAN bus data be performed to provide additional characterization of the aerodynamic and control-system performance of the vehicle platoon.

## References

- Al Alam, A., Gattami, A. and Johansson, K. (2010), "An Experimental Study on the Fuel Reduction Potential of Heavy Duty Vehicle Platooning," *13th International IEEE Annual Conference on Intelligent Transportation Systems*, Madeira Island, Portugal.
- Bergenheim, C., Shladover, S. and Coelingh, E. (2012), "Overview of Platooning Systems," *19th ITS World Congress*, Vienna, Austria.
- Bonnet, C. and Fritz, H. (2000), "Fuel Consumption Reduction in a Platoon: Experimental Results with Two Electronically Coupled Trucks at Close Spacing," SAE Paper No. 2013-01-0767.
- Browand, F., McArthur, J. and Radovich, C. (2004), "Fuel Saving Achieved in the Field Test of Two Tandem Trucks," California PATH Research Report No. UCB-ITS-PRR-2004-20.
- Ellis, M., Gargoloff, J. and Sengupta, R. (2015), "Aerodynamic Drag and Engine Cooling Effects on Class 8 Trucks in Platooning Configurations," *SAE Int. J. Commer. Veh.*, **8(2)**, doi: 10.4271/2015-01-2896.
- Gaudet, B. (2014), "Review of Cooperative Truck Platooning Systems," Report No. ST-GV-TR-0011, *National Research Council Canada*.
- Gheysens, T. and Van Raemdonck, G. (2016), "Effect of the Frontal Edge Radius in a Platoon of Bluff Bodies," *SAE Int. J. Commer. Veh.*, **9(2)**, doi: 10.4271/2016-01-8149.
- Hammache, M., Michaelian, M. and Browand, F. (2002), "Aerodynamic Forces on Truck Models, Including Two Trucks in Tandem," SAE Paper No. 2002-01-0530.
- Humphreys, H. and Bevly, D. (2016), "Computational Fluid Dynamic Analysis of a Generic 2 Truck Platoon," SAE Paper No. 2013-01-0767.
- Lammert, M., Duran, A., Diez, J., Burton, K. and Nicholson, A. (2014), "Effect of Platooning on Fuel Consumption of Class 8 Vehicles Over a Range of Speeds, Following Distances, and Mass," *SAE Int. J. Commer. Veh.*, **7(2)**, doi: 10.4271/2014-01-2438.
- Marcu, B. and Browand, F. (1999), "Aerodynamic Forces Experienced by a 3-Vehicle Platoon in a Crosswind," SAE Paper No. 1999-01-1324.
- McAuliffe, B. R. and Ahmadi-Baloutaki, M. (2017), "A Wind-Tunnel Study of the Aerodynamic Performance of Two Heavy-Duty Vehicles in Platooning Configurations," NRC Report No. LTR-AL-2017-0025, *National Research Council Canada*.
- Patten, J., McAuliffe, B. R., Mayda, W. and Tanguay, B. (2012), "Review of Aerodynamic Drag Reduction Devices for Heavy Trucks and Buses," Report No. CSTT-HVC-TR-205, *National*

*Research Council Canada.*

- Roberts, J., Mihelic, R., Roeth, M. and Rondini, D. (2016), "Confidence Report on Two-Truck Platooning," , *North American Council for Freight Efficiency*.
- Roeth, M. (2013), "CR England Peloton Technology Platooning Test Nov. 2013," North American Council for Freight Efficiency (NACFE), Peloton .
- SAE J1321 (2012), "Fuel Consumption Test Procedure - Type II," Surface Vehicle Recommended Practice No. J1321.
- SAE J1526 (2015), "Fuel Consumption Test Procedure (Engineering Method)," Surface Vehicle Recommended Practice No. J1321.
- Schito, P. and Braghin, F. (2012), "Numerical and Experimental Investigation on Vehicles in Platoon," *SAE Int. J. Commer. Veh.*, **5(1)**, doi: 10.4271/2012-01-0175.
- Shladover, S. E., Nowakowski, C., Lu, X. and Ferlis, R. (2015), "Cooperative Adaptive Cruise Control - Definitions and Operating Concepts," *Transportation Research Record: Journal of the Transportation Research Board*, **2489**.
- Smith, J., Mihelic, R., Gifford, B. and Ellis, M. (2014), "Aerodynamic Impact of Tractor-Trailer in Drafting Configuration," *SAE Int. J. Commer. Veh.*, **7(2)**, doi: 10.4271/2014-01-2436.
- Tadakuma, K., Doi, T., Shida, M. and Maeda, K. (2016), "Prediction formula of Aerodynamic Drag Reduction in Multiple-Vehicle Platooning Based on Wake Analysis and On-Road Experiments," *SAE Int. J. Passeng. Cars - Mech. Syst.*, **9(2)**, doi: 10.4271/2016-01-1596.
- Tsuei, L. and Savas, O. (2001), "Transient Aerodynamics of Vehicle Platoons during in-line Oscillations," *Journal of Wind Engineering and Industrial Aerodynamics*, **89**, pp. 1085–1111.
- Tsugawa, S., Jeschke, S. and Shladover, S. E. (2016), "A Review of Truck Platooning Projects for Energy Savings," *IEEE Transactions on Intelligent Vehicles*, **1(1)**, pp. 68–77.
- Tsugawa, S., Kato, S. and Aoki, K. (2011), "An Automated Truck Platoon for Energy Saving," *IEEE/RSJ International Conference on Intelligent Robots and Systems*, San Francisco, CA, USA.
- Watkins, S. and Vino, G. (2008), "The Effect of Vehicle Spacing on the Aerodynamics of a Representative Car Shape," *Journal of Wind Engineering and Industrial Aerodynamics*, **96**, pp. 1232–1239.
- Wood, R. (2015), "Reynolds Number Impact on Commercial Vehicle Aerodynamics and Performance," *SAE Int. J. Commer. Veh.*, **8(2)**, doi: 10.4271/2015-01-2859.

## A. Test Vehicle Specification

The tractor and trailer specifications for the control vehicle and the three test vehicles are provided in Table A.1.

**Table A.1:** Control and test vehicle specifications.

Truck				
<b>Truck #</b>	1	2	3	Control (Environment Canada)
<b>Registered</b>	California, USA	California, USA	California, USA	Ontario, Canada
<b>License Plate</b>	1301788	1301779	1301780	AF 76324
<b>Year</b>	2015			2013
<b>Make</b>	Volvo			International
<b>Model</b>	VNL 670			ProStar AR+
<b>Configuration</b>	61" High-Roof Sleeper			73" Sky-Rise Sleeper
Engine				
<b>Model</b>	Volvo D-13			Navistar N13, A450 MT
<b>Ratings</b>	500 HP@ 1800RPM, 1750 LB-FT			450 HP@1700
Transmission				
<b>Make</b>	Volvo			Eaton
<b>Model</b>	I-Shift, AT2621D, Direct Drive			UltraShift Plus, LSE
<b>Speed</b>	12			10
Axles				
<b>Axles Configuration</b>	6x4			6x4
<b>Front Axle</b>	Volvo VF12 12,500 LB Front Springs			Dana Spicer, E-1202I, Rated 12K
<b>Rear Axle</b>	Meritor, MT-40-14X3C Amboid, 40,000 LB Capacity			Meritor, MT-40-14X-4CFR, 40,000 LB Capacity
<b>Rear Axle Ratio</b>	2.64			-
Tires				
<b>Tire Front</b>	Bridgestone, R283 Ecopia 295/75R22.5G			Hancock, AL11 295/75R22.5
<b>Tire Rear</b>	Bridgestone, M710 Ecopia 295/75R22.5G			Bridgestone, M710 Ecopia 295/75R22.5G
Trailer				
<b>Make</b>	Utility			Utility
<b>Model</b>	4000D-X, 53 ft Dry Van			4000D-X, 53 ft Dry Van
<b>Trailer Number</b>	160315	160327	160311	160325
<b>Tires</b>	Duals	Duals	Duals	Duals

Fuel-Economy Testing of a Three-Truck Platoon

## B. Test Data

A summary of the fuel consumption and mean environmental conditions measured at the test track are provided in Table B.1 for each measurement run. Wind roses defined for each run are provided in Figures B.1 to B.60. Wind rose are shown for the track-side anemometer and/or the weather-station, depending on availability of data.



Fuel-Economy Testing of a Three-Truck Platoon

Table B.1: Fuel consumption and atmospheric conditions measured during test campaign.

Test Date	Test Start Time	Trailer Ballasted	Test Number	Test Speed [mph]	Fuel Consumed - Truck 1 [lbs]	Fuel Consumed - Truck 2 [lbs]	Fuel Consumed - Truck 3 [lbs]	Fuel Consumed - Control Truck [lbs]	Mean Wind Speed [km/h]	Max Wind Speed [km/h]	Min Wind Speed [km/h]	Mean Wind Direction [deg]	Max Wind Direction [deg]	Min Wind Direction [deg]	Anemometer Temperature [°C]	Station Temperature [°C]	Station Relative Humidity [%]	Station Barometric Pressure [milli bar]
6-Oct-16	8:54:00	Yes	A1.1	65	66.416	66.329	66.946	64.121	8.0	21.1	0.1	243.6	328.8	83.4	15.9	9.9	99.2	1026.7
6-Oct-16	10:22:00	Yes	A1.2	65	64.662	64.820	64.616	62.821	11.1	18.5	5.2	249.0	314.4	201.0	19.5	16.3	79.3	1026.1
6-Oct-16	12:08:00	Yes	A1.3	65	63.386	62.162	64.294	61.634	13.8	23.0	6.4	241.0	310.5	201.2	21.8	19.7	63.3	1025.8
6-Oct-16	13:46:00	Yes	A6.1	55	53.684	54.310	53.591	51.711	13.5	22.3	5.2	248.3	287.7	199.4	23.0	21.5	53.0	1025.5
6-Oct-16	15:35:00	Yes	A6.2	55	53.348	52.746	51.635	52.838	6.5	19.3	1.3	227.9	262.3	181.2	22.6	22.4	51.6	1025.3
6-Oct-16	17:12:00	Yes	A6.3	55	52.660	52.234	52.480	50.545	1.9	5.2	0.3	132.7	359.6	0.1	15.1	16.8	71.7	1026.2
7-Oct-16	9:03:00	Yes	A3.1	65	62.898	57.949	56.507	67.313	5.3	9.6	0.5	76.4	359.8	0.5	13.4	12.0	99.5	1027.1
7-Oct-16	9:48:00	Yes	A2.1	65	64.800	60.650	58.949	62.981	4.9	8.8	0.8	59.9	358.6	0.8	16.3	15.6	95.8	1026.6
7-Oct-16	11:14:00	Yes	A2.2	65	63.689	59.055	57.197	61.327	4.6	10.3	0.3	33.2	359.0	0.5	20.9	20.5	64.2	1025.7
7-Oct-16	12:43:00	Yes	A2.3	65	63.097	58.696	57.046	61.647	5.6	16.1	0.2	312.3	358.8	15.1	23.2	22.8	50.3	1024.7
7-Oct-16	14:04:00	Yes	A2.4	65	62.036	57.373	55.776	61.055	5.3	14.1	0.2	318.0	356.4	2.8	24.6	24.0	42.9	1023.2
7-Oct-16	16:15:00	Yes	A2.5	65	62.895	58.247	56.532	64.468	5.3	15.2	0.6	296.9	314.5	8.0	24.4	24.0	36.4	1021.6
11-Oct-16	8:45:00	Yes	A3.2	65	68.585	63.377	61.109	66.089	11.3	18.2	6.1	220.1	256.0	183.0	9.7	7.2	78.0	1021.0
11-Oct-16	10:20:00	Yes	A3.3	65	66.781	61.249	59.708	64.542	14.0	20.9	6.2	218.3	248.7	167.7	13.2	10.2	68.0	1021.0
11-Oct-16	11:47:00	Yes	A3.4	65	66.146	60.572	59.615	63.774	12.1	20.9	3.7	233.8	292.1	179.7	15.1	14.0	51.0	1020.0
11-Oct-16	13:11:00	Yes	A4.1	65	65.191	59.466	57.965	63.020	12.9	21.0	6.0	223.8	267.2	181.5	16.2	15.2	46.0	1020.0
11-Oct-16	14:41:00	Yes	A4.2	65	64.976	59.458	57.633	63.071	8.7	15.4	0.6	237.8	340.4	189.8	17.0	16.2	44.0	1018.0
11-Oct-16	15:57:00	Yes	A4.3	65	64.293	58.729	57.203	62.846	3.6	9.8	0.3	250.1	340.6	77.6	15.5	15.9	46.0	1018.0
11-Oct-16	17:26:00	Yes	A2.6	65	65.112	60.755	58.885	63.465	1.1	2.5	0.0	104.9	358.1	0.3	8.0	12.3	62.0	1018.0
12-Oct-16	8:57:00	Yes	A5.1	65	66.548	60.629	59.214	65.061	3.0	5.7	0.1	82.5	359.8	0.3	11.3	9.1	81.0	1014.0
12-Oct-16	10:13:00	Yes	A5.2	65	64.856	59.050	57.705	63.322	4.3	14.5	0.2	264.3	354.5	1.4	15.4	11.8	59.0	1014.0
12-Oct-16	11:39:00	Yes	A5.3	65	64.167	58.262	57.070	62.527	8.9	18.3	1.1	256.8	328.9	90.2	17.8	17.0	47.0	1012.0
12-Oct-16	13:08:00	Yes	A5.4	65	63.776	57.978	56.340	62.704	7.3	17.2	0.4	279.7	359.9	65.1	19.5	18.1	44.0	1011.0
12-Oct-16	14:39:00	Yes	A6.4	55	53.898	53.403	53.204	51.769	4.5	11.4	0.2	359.9	0.1	17.6	20.2	19.3	40.0	1009.0
12-Oct-16	16:05:00	Yes	A1.4	65	63.585	63.189	62.997	61.279	1.9	6.5	0.1	53.5	359.9	0.4	14.0	18.8	44.0	1009.0
15-Oct-16	11:42:00	Yes	S1.1	65	70.185	70.375	70.175	68.552	6.4	13.2	0.3	294.3	359.9	0.1	13.8	14.3	46.0	1015.0
15-Oct-16	13:01:00	Yes	S1.2	65	69.688	69.655	69.772	67.915	7.1	15.8	0.2	300.6	359.9	0.1	15.0	14.9	43.0	1014.0
15-Oct-16	14:26:00	Yes	S1.3	65	69.577	69.478	69.300	68.164	5.6	12.8	0.6	311.6	359.9	0.1	15.7	15.4	44.0	1014.0
15-Oct-16	15:44:00	Yes	S6.1	55	58.203	57.928	57.719	56.102	2.8	8.6	0.3	282.8	359.9	0.1	14.3	10.6	65.0	1012.0
15-Oct-16	17:24:00	Yes	S6.2	55	58.180	57.907	58.004	55.966	6.5	263.0	0.1	311.7	359.9	0.1	9.8	10.4	63.0	1012.0
16-Oct-16	9:29:00	Yes	S6.3	55	58.766	58.164	58.222	56.576	4.1	12.3	1.3	247.1	315.6	179.2	13.5	12.5	85.0	1004.0
17-Oct-16	8:44:00	Yes	S2.1	65	71.809	67.616	65.317	69.714	10.3	17.4	3.3	72.4	118.0	14.4	9.8	10.1	73.0	1006.0
17-Oct-16	10:01:00	Yes	S2.2	65	71.156	66.651	64.024	69.501	9.1	15.8	1.6	58.9	359.3	0.1	10.7	10.7	64.0	1006.0
17-Oct-16	11:28:00	Yes	S2.3	65	70.375	65.905	63.499	69.173	5.9	13.6	0.1	50.8	359.9	0.5	11.9	11.5	65.0	1005.0
17-Oct-16	12:43:00	Yes	S3.1	65	69.630	64.977	62.352	67.820	5.5	12.8	0.2	48.3	359.9	0.1	13.0	12.9	57.0	1004.0
17-Oct-16	14:13:00	Yes	S3.2	65	69.545	64.819	62.103	67.894	3.9	10.7	0.3	28.8	359.9	0.1	13.5	12.2	56.0	1004.0
17-Oct-16	15:32:00	Yes	S3.3	65	68.882	64.409	61.835	66.540	3.8	9.9	0.1	42.4	359.9	0.1	12.4	11.0	62.0	1003.0
17-Oct-16	16:56:00	Yes	S3.4	65	69.255	64.904	62.199	67.816	6.4	304.6	0.1	94.9	359.9	0.1	9.4	10.1	68.0	1003.0
18-Oct-16	10:19:00	Yes	S4.1	65	71.581	66.468	63.870	69.560	8.1	13.7	3.4	72.4	135.7	27.5	10.5	8.5	98.0	994.0
18-Oct-16	11:36:00	Yes	S4.2	65	70.248	65.231	62.943	68.045	7.6	13.0	2.5	68.5	110.7	14.3	11.5	10.1	98.0	991.0
18-Oct-16	13:07:00	Yes	S4.3	65	69.853	65.107	62.512	67.679	4.7	10.0	0.2	75.6	359.8	0.7	15.8	12.8	91.0	991.0
18-Oct-16	14:24:00	Yes	S5.1	65	67.464	62.747	60.336	66.540	2.5	8.5	0.0	89.7	360.0	0.1	16.3	13.3	91.0	990.0
19-Oct-16	8:05:00	Yes	S5.2	65	69.832	64.939	62.376	68.040	9.5	24.4	2.8	223.8	258.9	145.8	14.1	11.6	85.6	1015.0
19-Oct-16	9:25:00	Yes	S5.3	65	69.473	64.380	61.793	68.043	9.9	20.9	1.0	198.5	248.6	106.6	15.0	13.9	69.9	1016.0
19-Oct-16	10:48:00	Yes	S7.1	55	58.300	54.209	52.598	57.438	9.1	23.4	0.9	183.9	304.8	84.2	14.9	14.4	61.3	1016.4
19-Oct-16	13:19:00	Yes	S7.2	55	58.303	54.698	53.106	57.035	8.1	18.9	0.3	187.6	359.8	5.2	17.0	15.8	46.9	1018.0
19-Oct-16	14:46:00	Yes	S7.3	55	57.115	53.141	51.433	56.170	x	x	x	x	x	x	16.0	16.7	44.0	1018.0
19-Oct-16	16:24:00	Yes	S7.4	55	57.239	53.182	51.492	55.757	x	x	x	x	x	x	17.0	17.1	43.0	1019.0
19-Oct-16	17:47:00	Yes	S4.4	65	68.492	63.933	61.093	66.552	x	x	x	x	x	x	15.9	12.7	63.0	1021.0
20-Oct-16	8:20:00	No	C1.1	65	72.916	71.300	71.143	64.219	5.5	9.8	0.3	90.6	360.0	0.1	8.1	6.0	100.0	1023.8
20-Oct-16	9:36:00	No	C1.2	65	70.790	70.985	70.639	63.612	4.5	9.6	0.8	85.0	359.6	0.2	9.2	7.4	97.9	1023.9
20-Oct-16	11:06:00	No	C1.3	65	71.072	71.003	70.778	64.371	11.2	39.4	2.1	143.1	267.7	54.4	8.0	6.5	88.3	1014.3
23-Oct-16	9:45:00	No	S8.1 E	65	66.303	66.020	66.296	64.240	20.1	37.8	5.6	222.4	269.9	164.3	6.1	4.6	73.2	999.4
23-Oct-16	11:07:00	No	S8.2 E	65	66.635	66.274	65.888	64.825	21.1	40.4	8.2	220.6	256.3	162.0	7.3	5.6	66.2	1000.3
23-Oct-16	12:35:00	No	S8.3 E	65	65.521	65.789	65.600	63.894	17.5	33.9	4.0	219.2	267.3	169.2	9.6	7.4	55.8	1000.7
23-Oct-16	13:55:00	No	S9.1 E	65	63.899	58.597	56.488	62.291	18.3	33.9	5.3	226.5	259.9	174.0	10.8	9.6	44.5	1001.1
23-Oct-16	15:19:00	No	S9.2 E	65	62.864	57.383	55.521	63.198	22.2	42.0	10.2	233.4	253.9	199.3	10.2	10.6	40.2	1002.0
23-Oct-16	16:37:00	No	S9.3 E	65	64.317	59.021	56.787	62.411	21.7	271.3	7.8	236.9	258.0	16.7	6.3	7.6	50.4	1005.1
24-Oct-16	9:13:00	No	S9.4 E	65	64.233	58.700	56.802	63.283	15.6	35.6	5.1	220.6	255.4	162.9	6.7	5.3	69.1	1010.5
24-Oct-16	10:33:00	No	S9.5 E	65	64.258	58.752	56.755	63.284	18.1	34.5	4.3	220.9	260.4	170.4	6.6	6.0	59.5	1010.9
24-Oct-16	12:03:00	No	S8.4 E	65	65.644	65.916	65.221	64.077	14.4	29.0	1.7	213.7	275.3	156.7	7.0	5.9	60.4	1011.5
24-Oct-16	13:37:00	No	S8.5 E	65	64.941	64.395	64.258	62.131	12.1	28.2	1.7	212.3	264.8	122.7	7.1	6.3	52.1	1012.0

  Invalid run (due to CACC de-linking, or CACC control issues, or regeneration, or moose on the track)  
  Anemometer data not available until the end of last run of the day. Values obtained from the partially available data  
  Only hourly mean station data available  
  Anemometer data not available until the end of last run of the day. No calculations performed

Fuel-Economy Testing of a Three-Truck Platoon

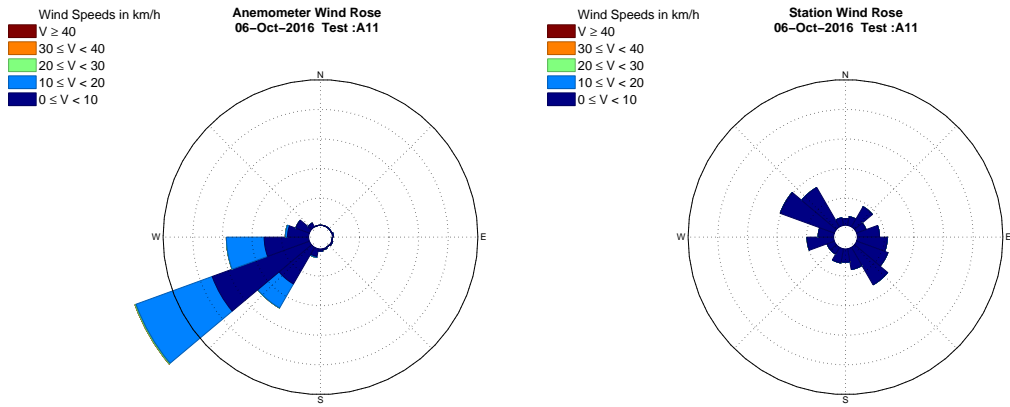

Figure B.1: Wind Rose - 6 October 2016 Test A1.1

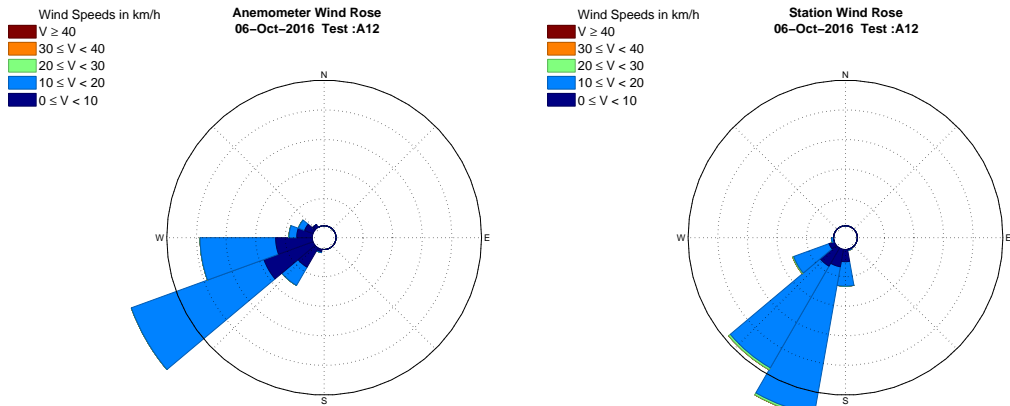

Figure B.2: Wind Rose - 6 October 2016 Test A1.2

Fuel-Economy Testing of a Three-Truck Platoon

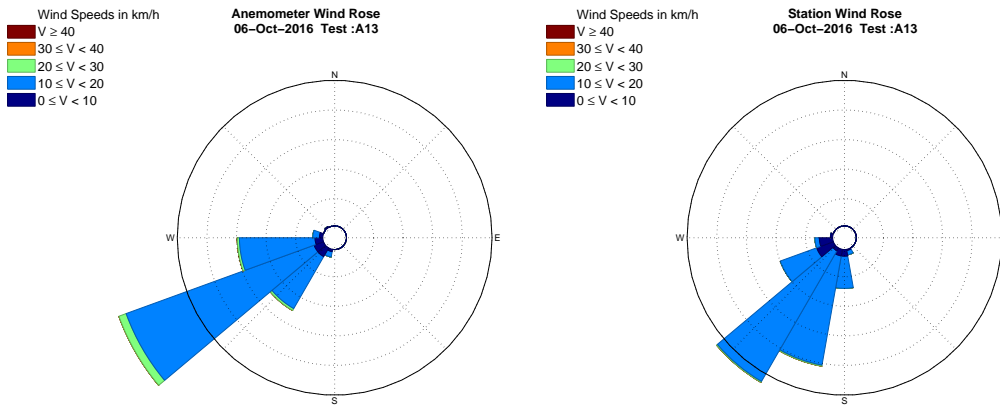

Figure B.3: Wind Rose - 6 October 2016 Test A1.3

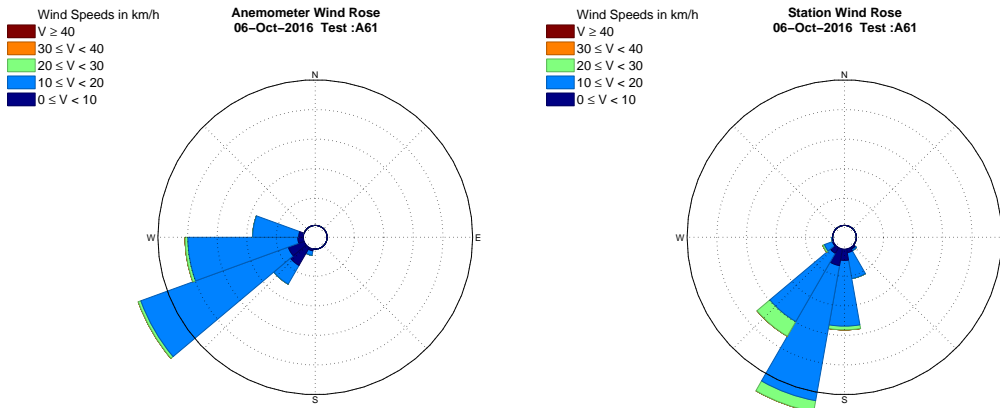

Figure B.4: Wind Rose - 6 October 2016 Test A6.1

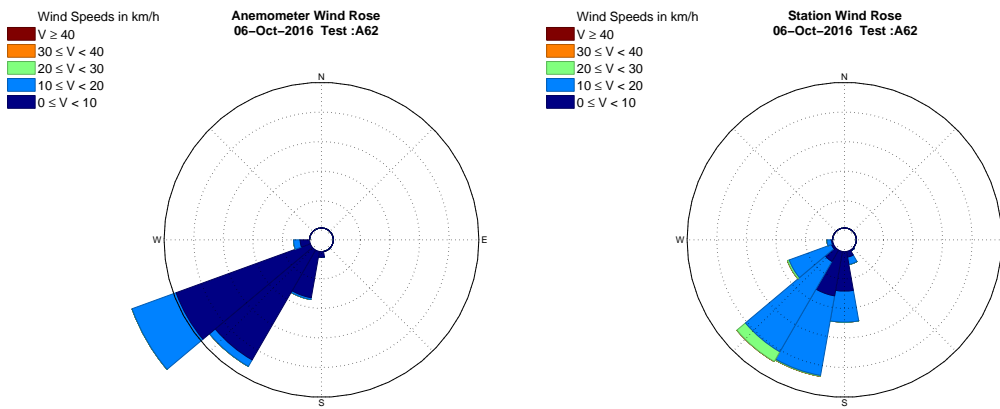

Figure B.5: Wind Rose - 6 October 2016 Test A6.2

Fuel-Economy Testing of a Three-Truck Platoon

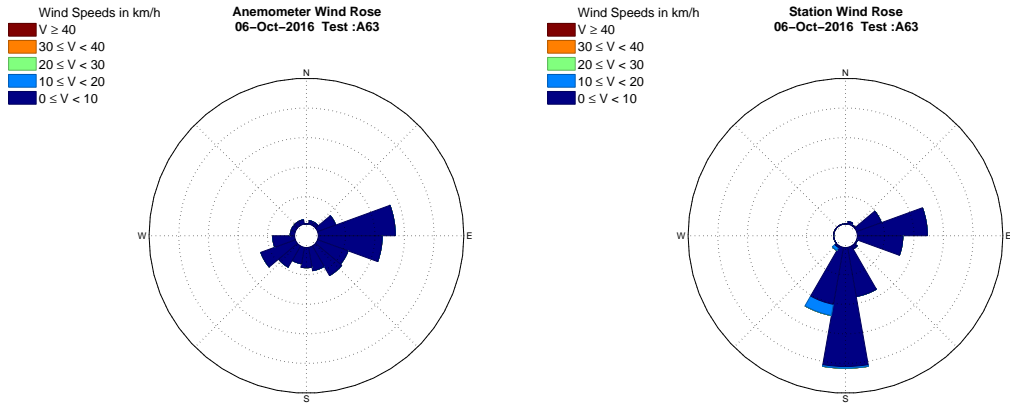

Figure B.6: Wind Rose - 6 October 2016 Test A6.3

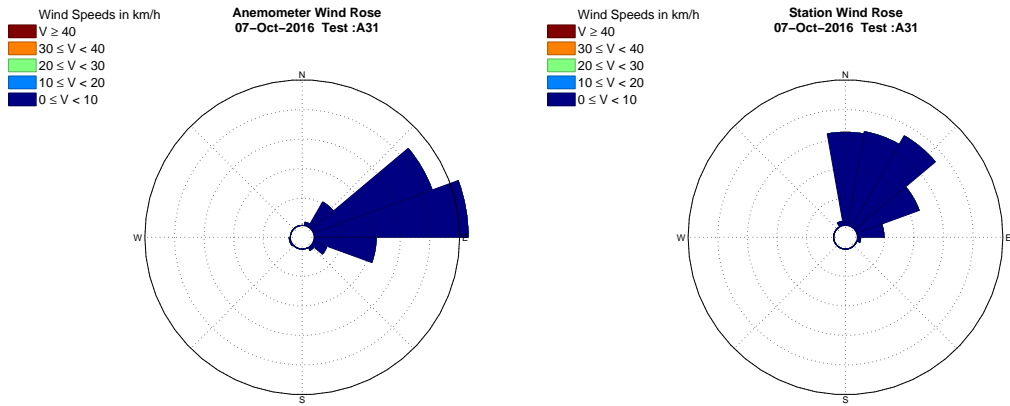

Figure B.7: Wind Rose - 7 October 2016 Test A3.1

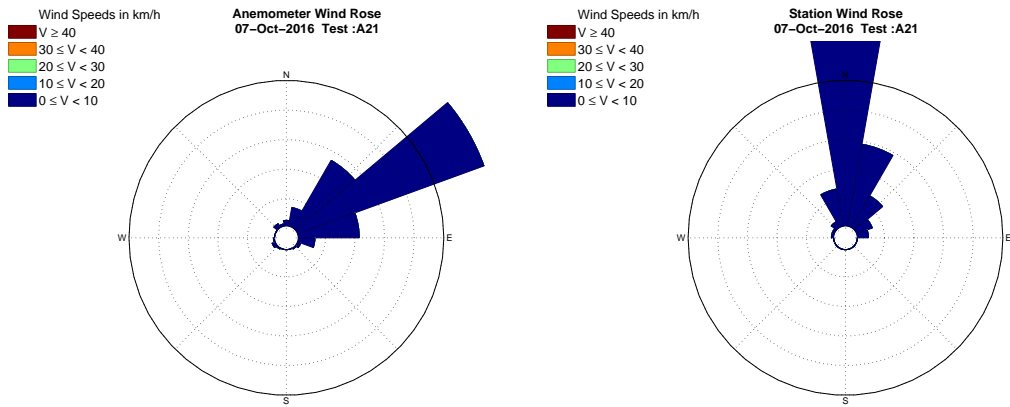

Figure B.8: Wind Rose - 7 October 2016 Test A2.1

Fuel-Economy Testing of a Three-Truck Platoon

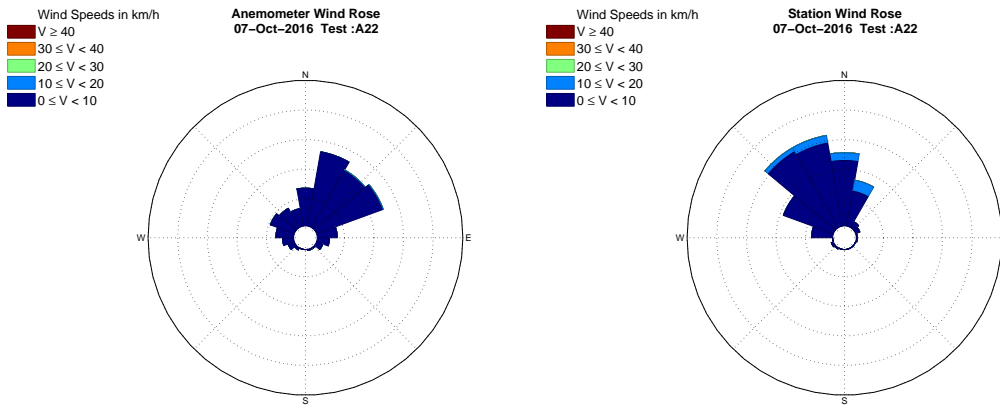

Figure B.9: Wind Rose - 7 October 2016 Test A2.2

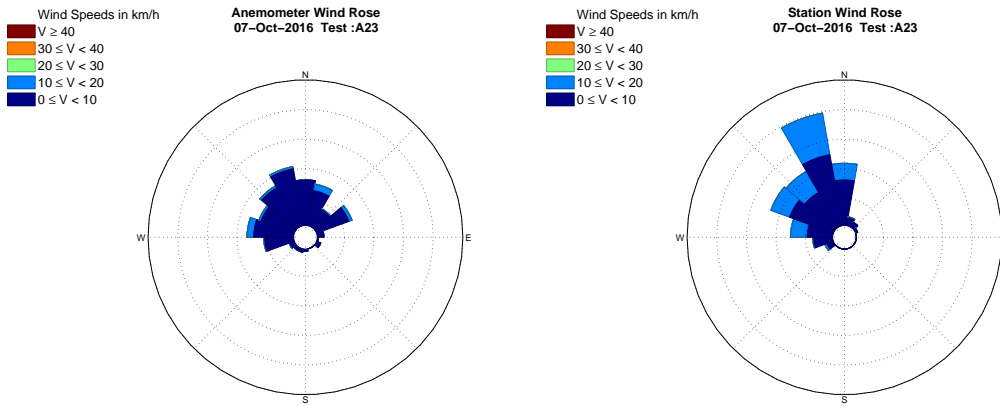

Figure B.10: Wind Rose - 7 October 2016 Test A2.3

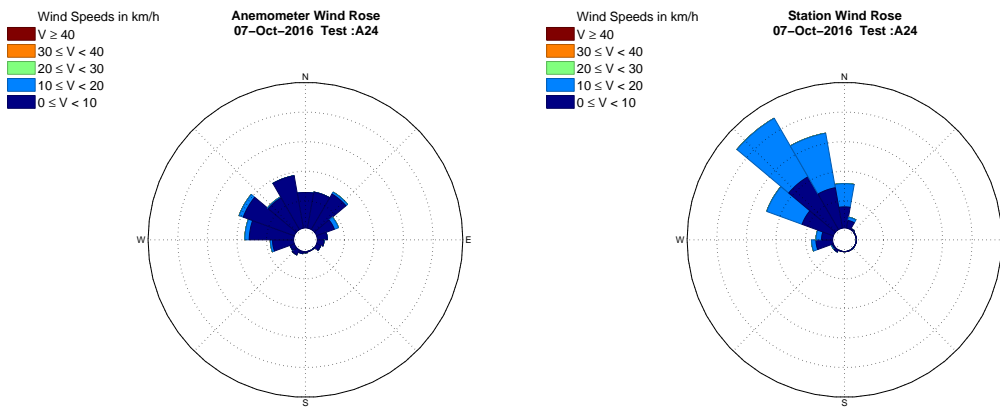

Figure B.11: Wind Rose - 7 October 2016 Test A2.4

Fuel-Economy Testing of a Three-Truck Platoon

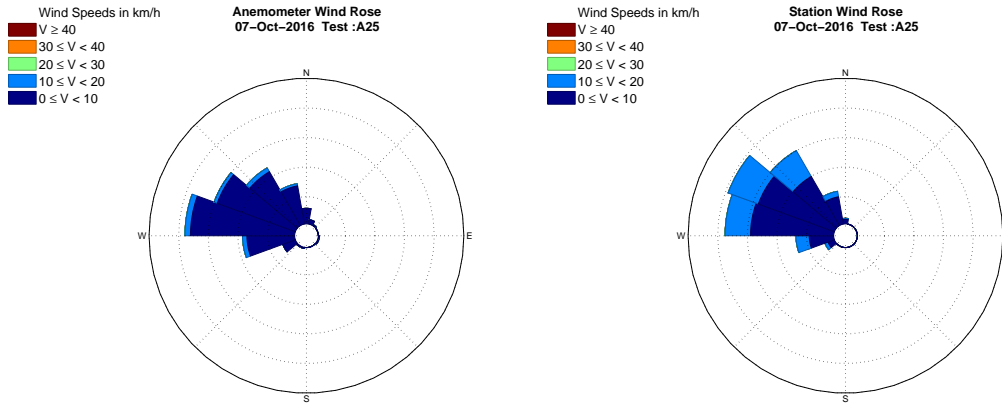

Figure B.12: Wind Rose - 7 October 2016 Test A2.5

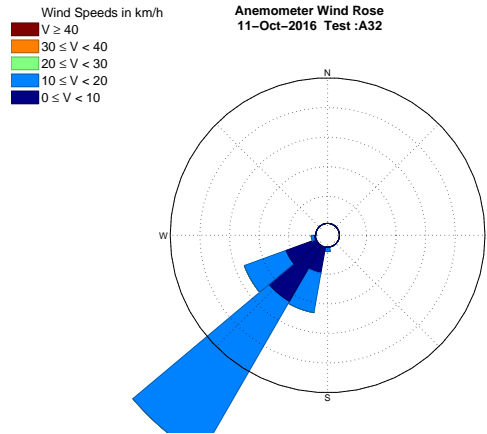

Figure B.13: Wind Rose - 11 October 2016 Test A3.2

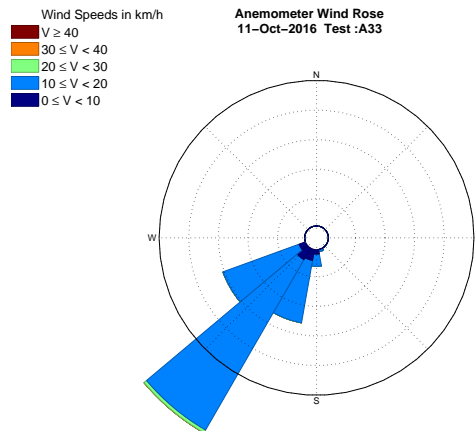

Figure B.14: Wind Rose - 11 October 2016 Test A3.3

Fuel-Economy Testing of a Three-Truck Platoon

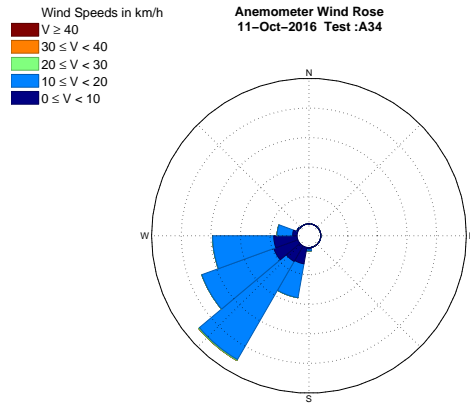

Figure B.15: Wind Rose - 11 October 2016 Test A3.4

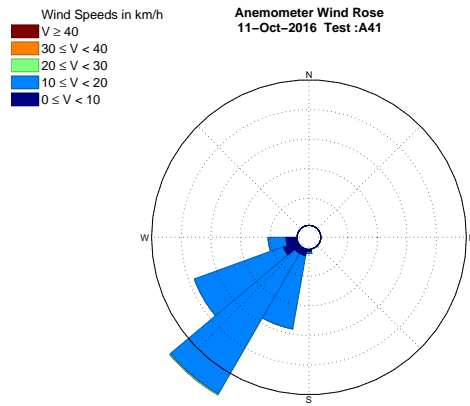

Figure B.16: Wind Rose - 11 October 2016 Test A4.1

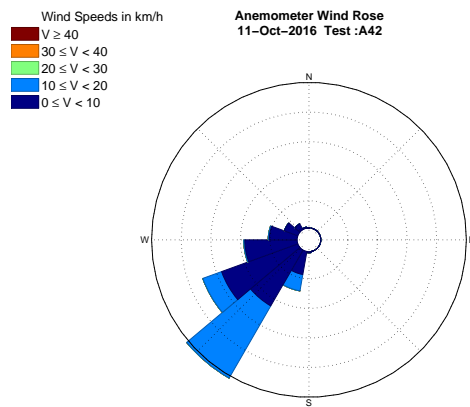

Figure B.17: Wind Rose - 11 October 2016 Test A4.2

Fuel-Economy Testing of a Three-Truck Platoon

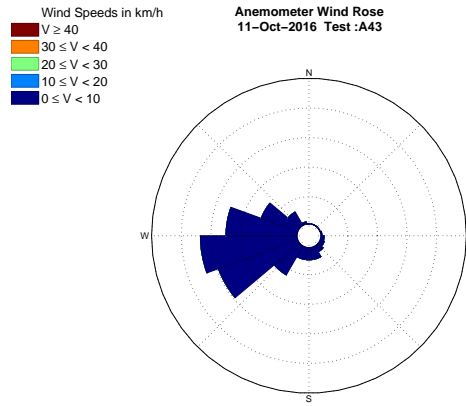

Figure B.18: Wind Rose - 11 October 2016 Test A4.3

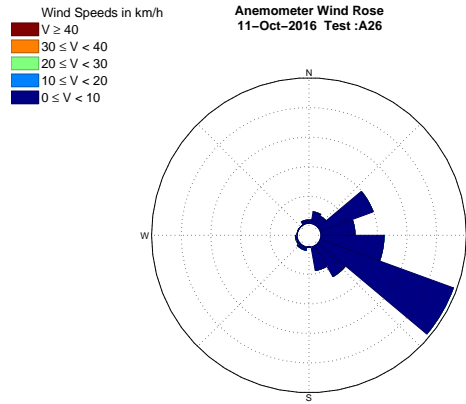

Figure B.19: Wind Rose - 11 October 2016 Test A2.6

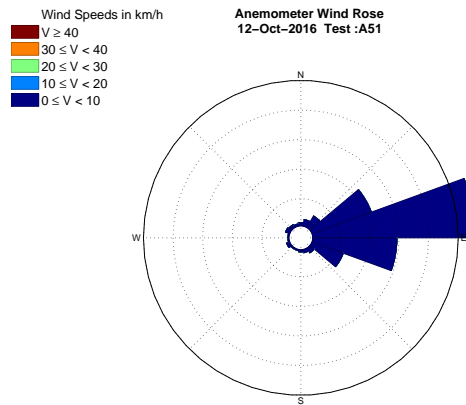

Figure B.20: Wind Rose - 12 October 2016 Test A5.1



Fuel-Economy Testing of a Three-Truck Platoon

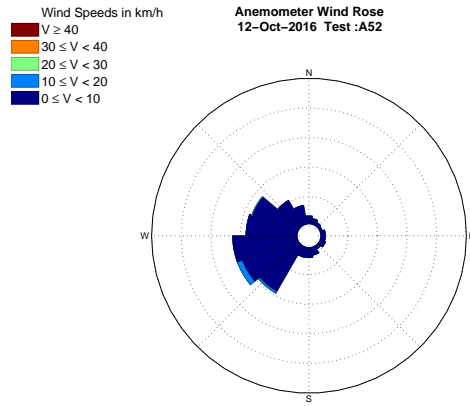

Figure B.21: Wind Rose - 12 October 2016 Test A5.2

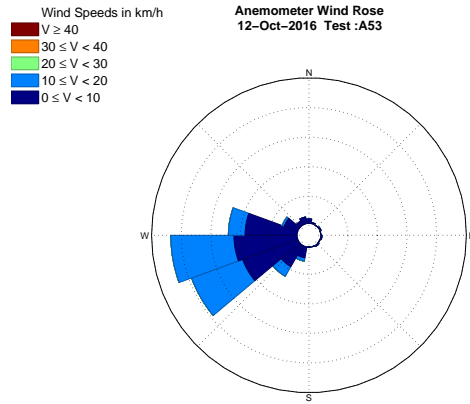

Figure B.22: Wind Rose - 12 October 2016 Test A5.3

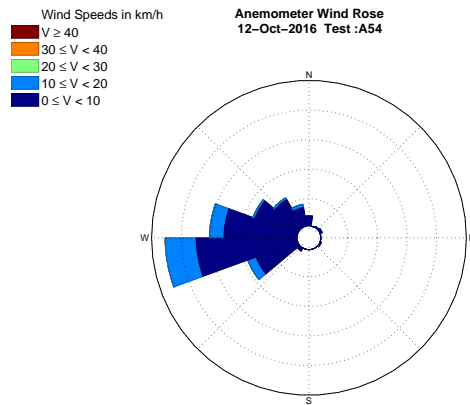

Figure B.23: Wind Rose - 12 October 2016 Test A5.4

Fuel-Economy Testing of a Three-Truck Platoon

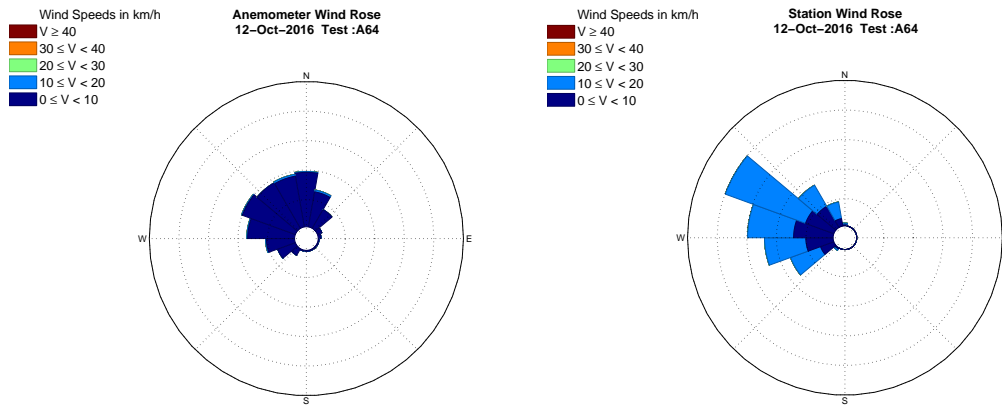

Figure B.24: Wind Rose - 12 October 2016 Test A6.4

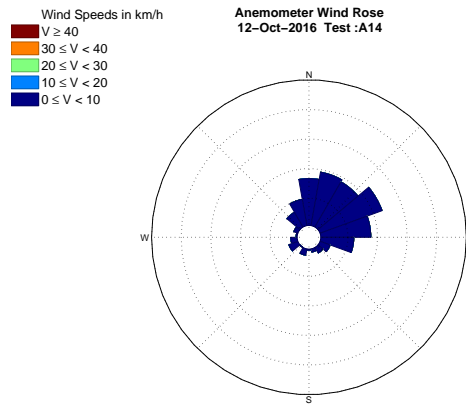

Figure B.25: Wind Rose - 12 October 2016 Test A1.4

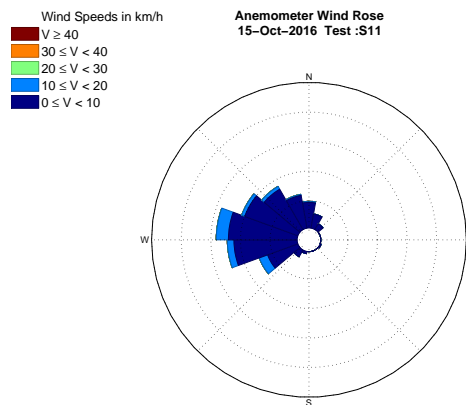

Figure B.26: Wind Rose - 15 October 2016 Test S1.1

Fuel-Economy Testing of a Three-Truck Platoon

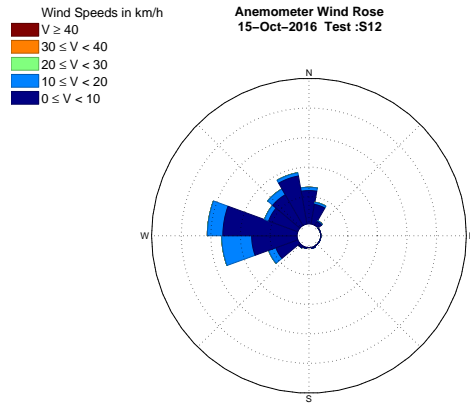

Figure B.27: Wind Rose - 15 October 2016 Test S1.2

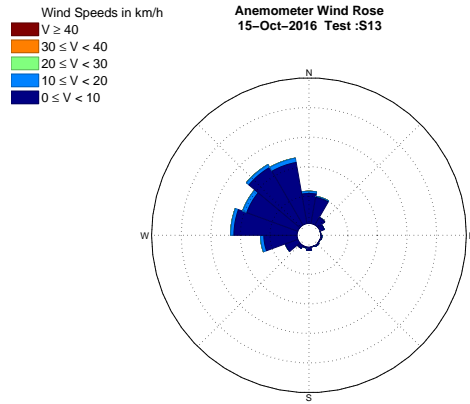

Figure B.28: Wind Rose - 15 October 2016 Test S1.3

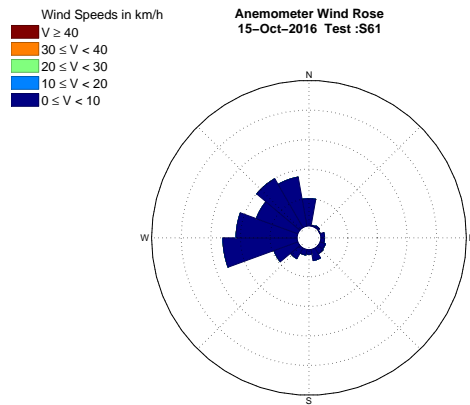

Figure B.29: Wind Rose - 15 October 2016 Test S6.1

Fuel-Economy Testing of a Three-Truck Platoon

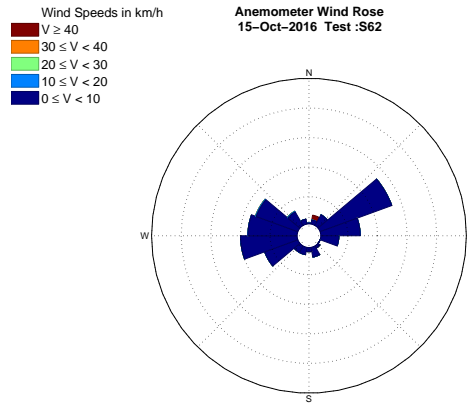

Figure B.30: Wind Rose - 15 October 2016 Test S6.2

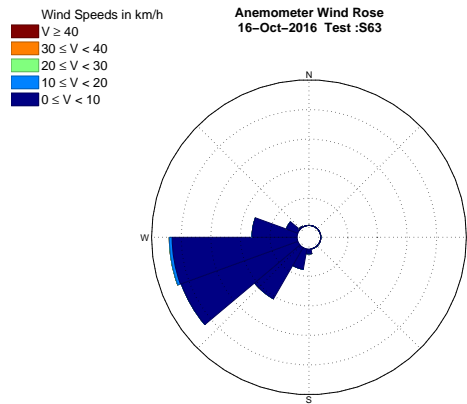

Figure B.31: Wind Rose - 16 October 2016 Test S6.3

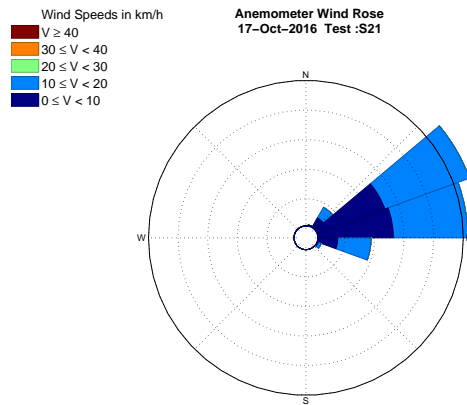

Figure B.32: Wind Rose - 17 October 2016 Test S2.1

Fuel-Economy Testing of a Three-Truck Platoon

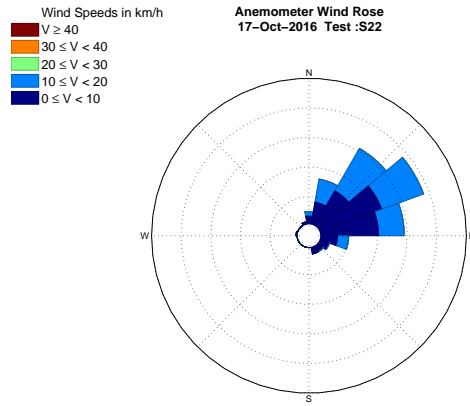

Figure B.33: Wind Rose - 17 October 2016 Test S2.2

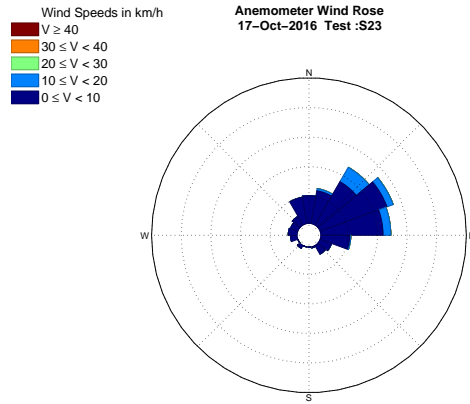

Figure B.34: Wind Rose - 17 October 2016 Test S2.3

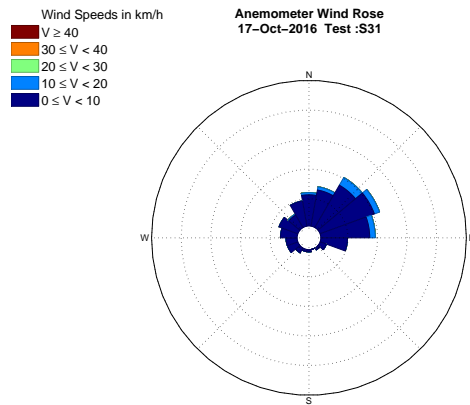

Figure B.35: Wind Rose - 17 October 2016 Test S3.1

Fuel-Economy Testing of a Three-Truck Platoon

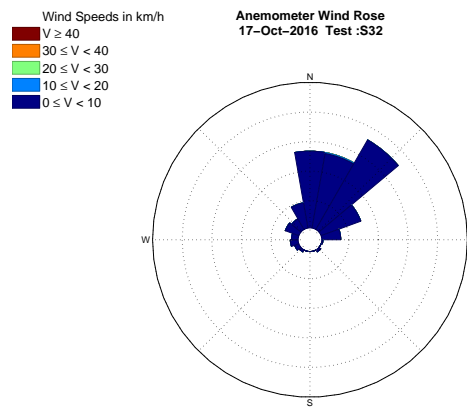

Figure B.36: Wind Rose - 17 October 2016 Test S3.2

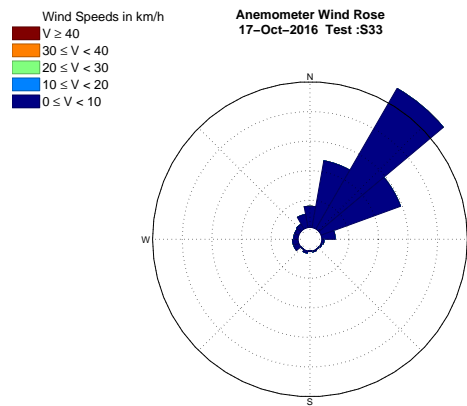

Figure B.37: Wind Rose - 17 October 2016 Test S3.3

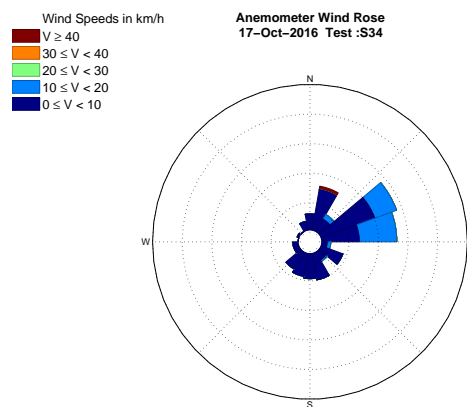

Figure B.38: Wind Rose - 17 October 2016 Test S3.4

Fuel-Economy Testing of a Three-Truck Platoon

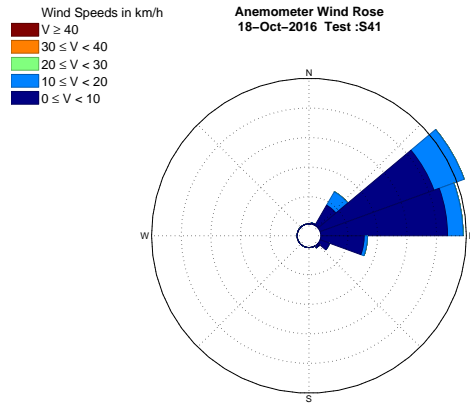

Figure B.39: Wind Rose - 18 October 2016 Test S4.1

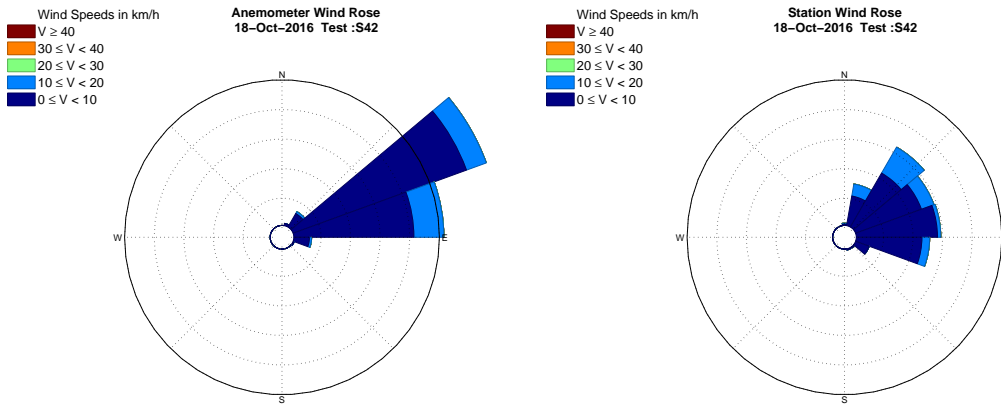

Figure B.40: Wind Rose - 18 October 2016 Test S4.2

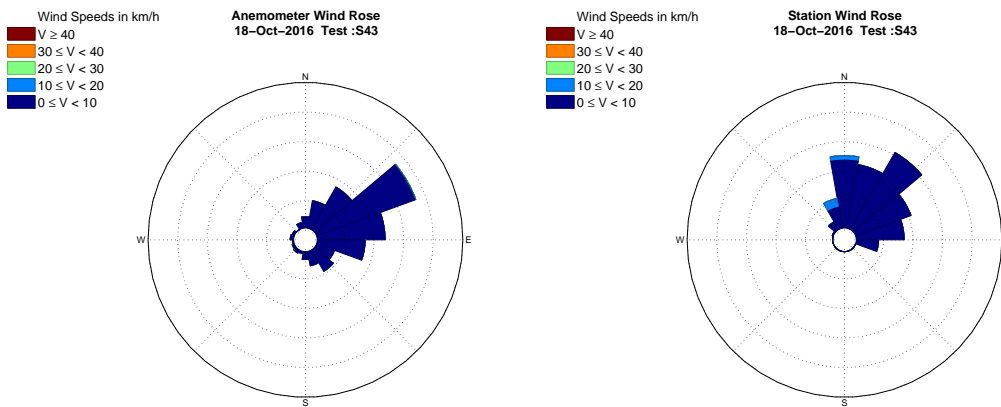

Figure B.41: Wind Rose - 18 October 2016 Test S4.3

Fuel-Economy Testing of a Three-Truck Platoon

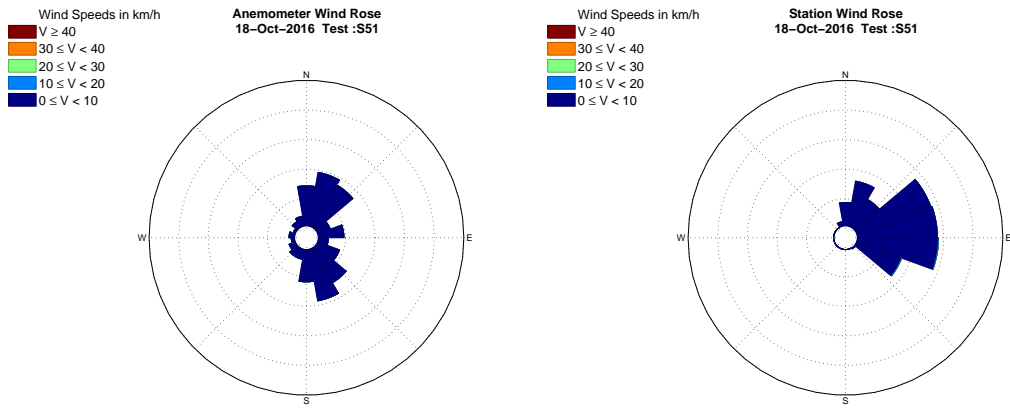

Figure B.42: Wind Rose - 18 October 2016 Test S5.1

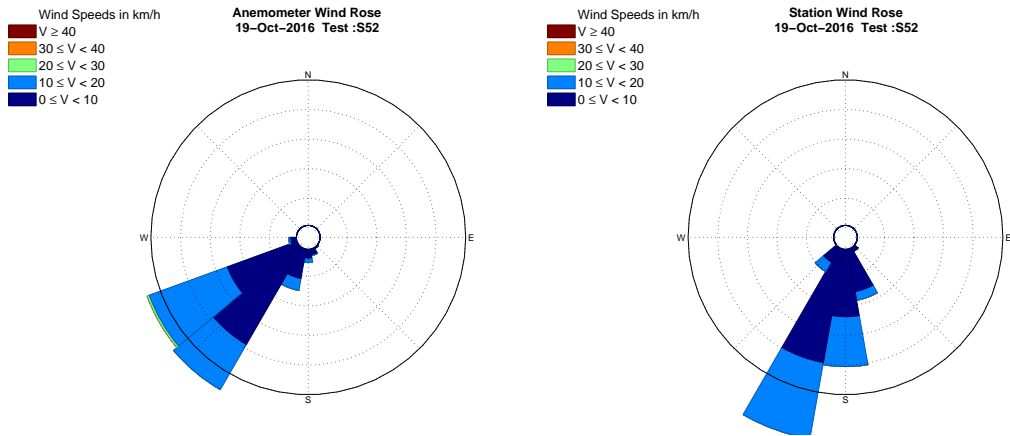

Figure B.43: Wind Rose - 19 October 2016 Test S5.2

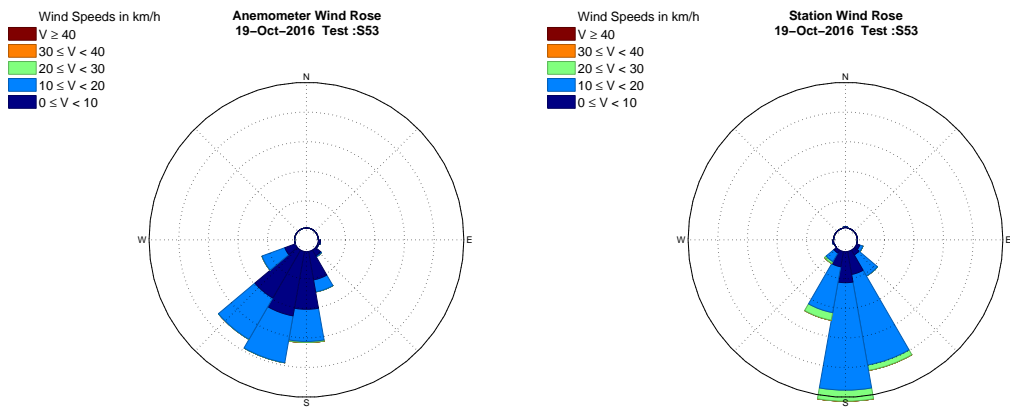

Figure B.44: Wind Rose - 19 October 2016 Test S5.3



Fuel-Economy Testing of a Three-Truck Platoon

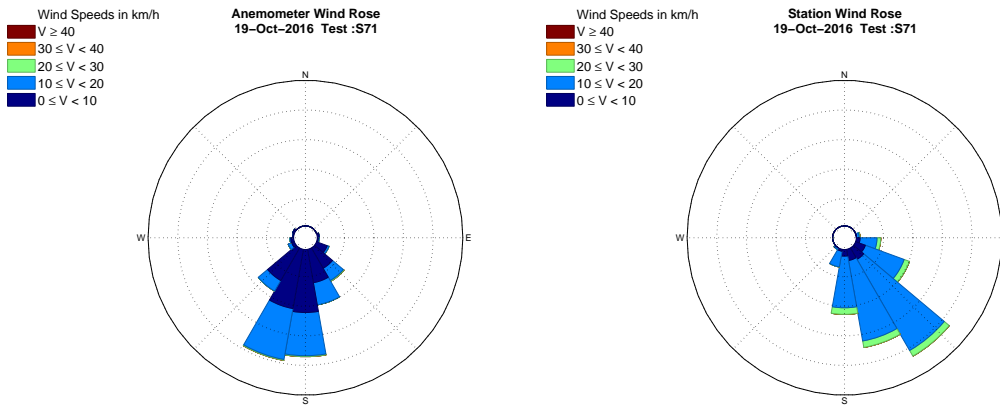

Figure B.45: Wind Rose - 19 October 2016 Test S7.1

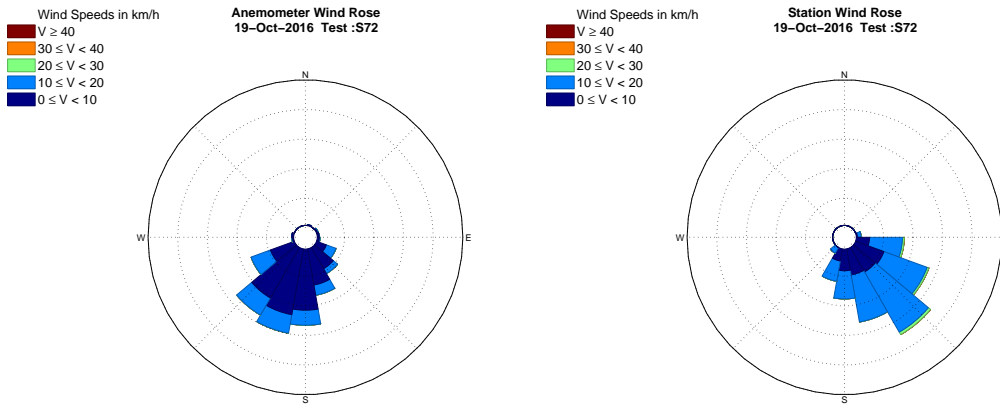

Figure B.46: Wind Rose - 19 October 2016 Test S7.2

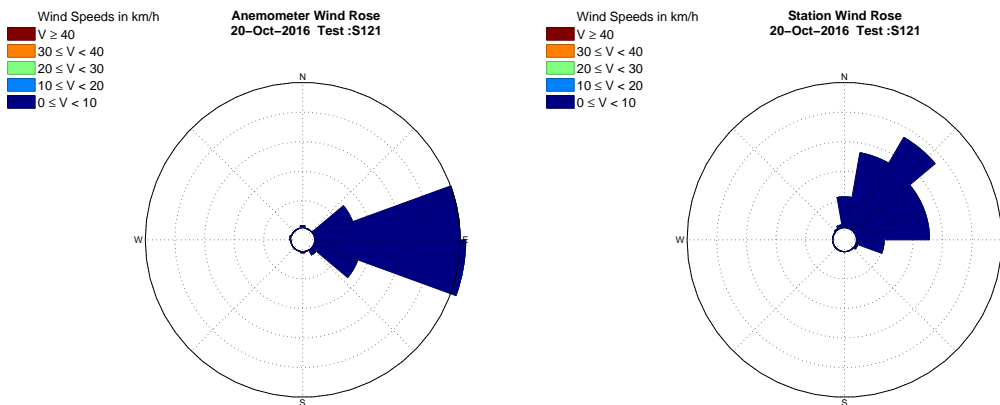

Figure B.47: Wind Rose - 20 October 2016 Test C1.1

Fuel-Economy Testing of a Three-Truck Platoon

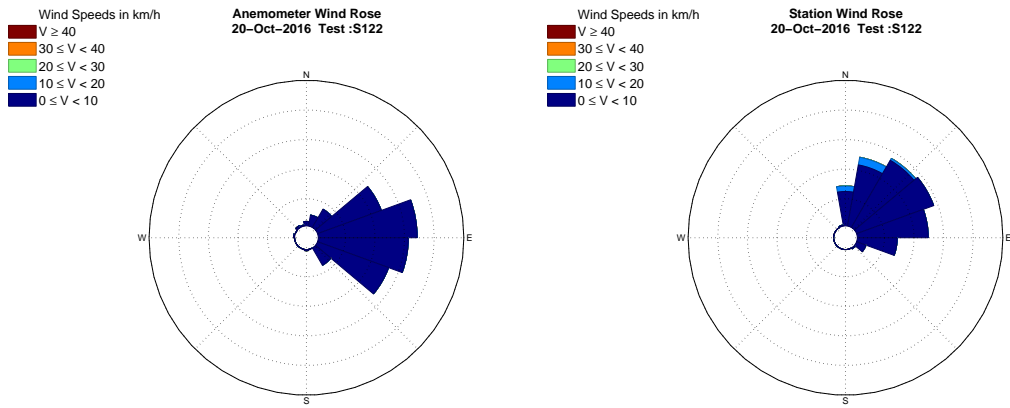

Figure B.48: Wind Rose - 20 October 2016 Test C1.2

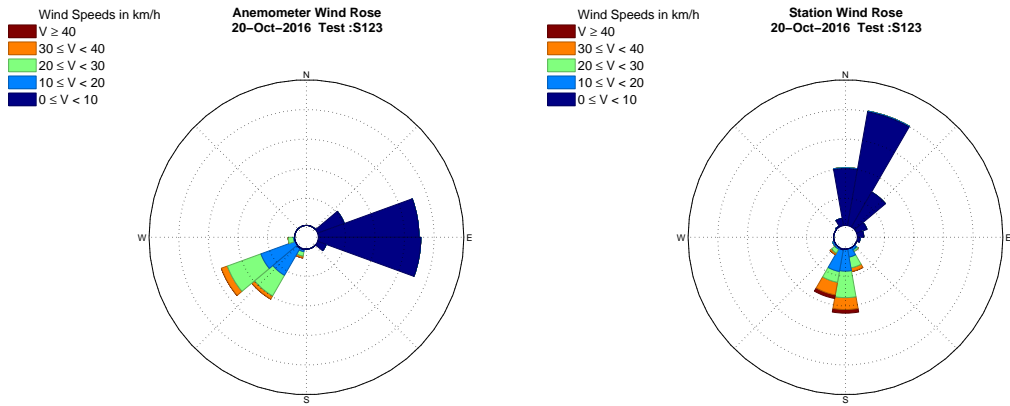

Figure B.49: Wind Rose - 20 October 2016 Test C1.3

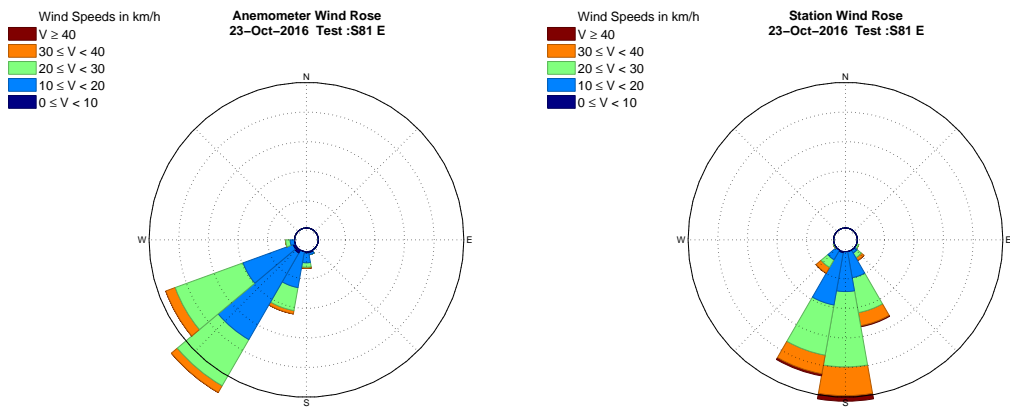

Figure B.50: Wind Rose - 23 October 2016 Test S8.1 E

Fuel-Economy Testing of a Three-Truck Platoon

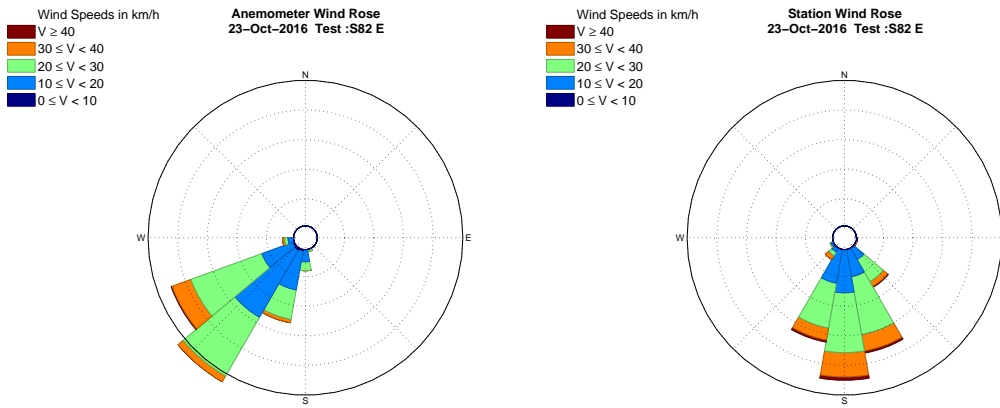

Figure B.51: Wind Rose - 23 October 2016 Test S8.2 E

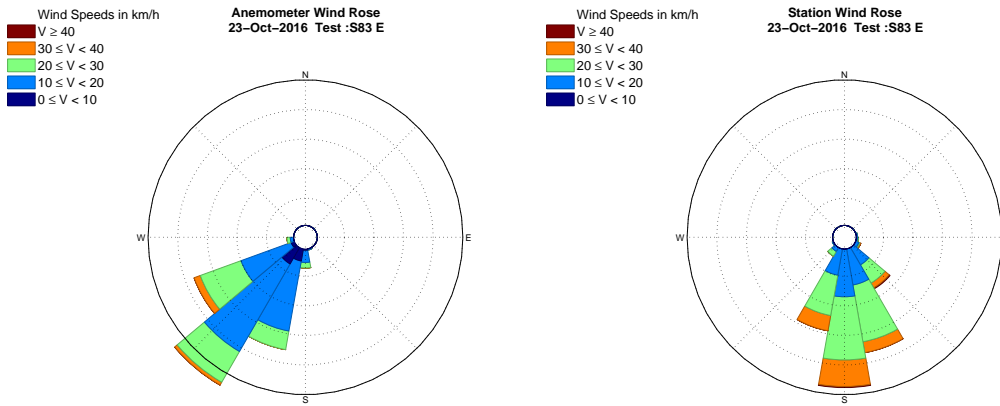

Figure B.52: Wind Rose - 23 October 2016 Test S8.3 E

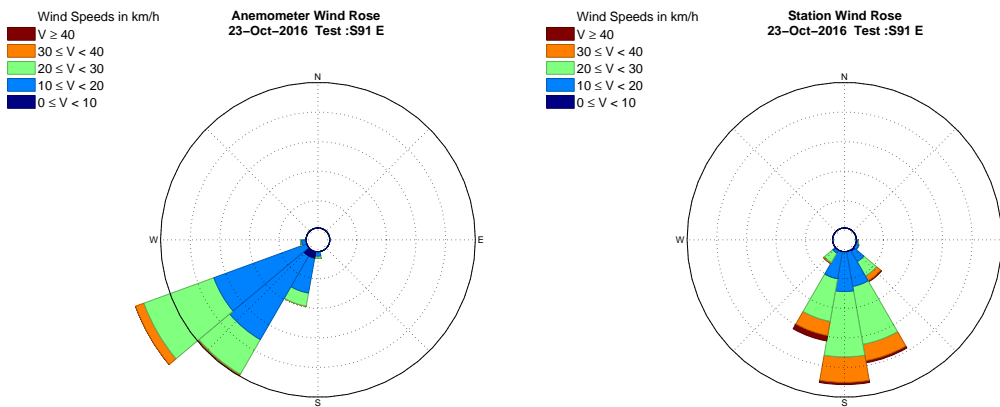

Figure B.53: Wind Rose - 23 October 2016 Test S9.1 E

Fuel-Economy Testing of a Three-Truck Platoon

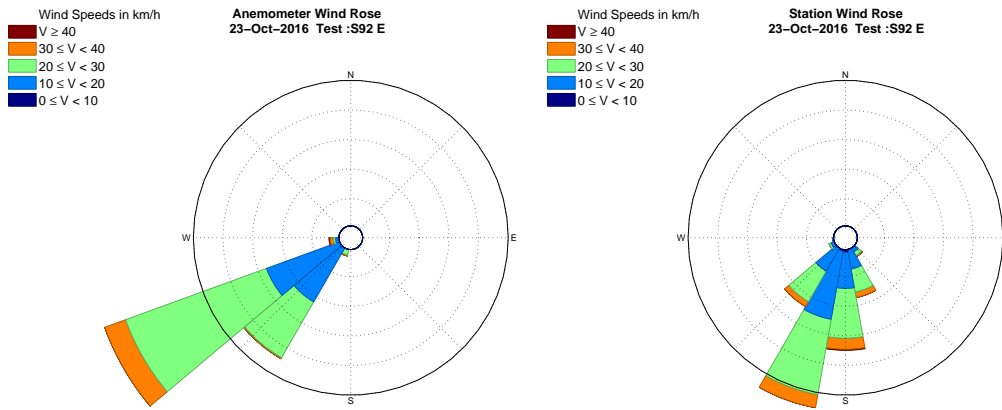

Figure B.54: Wind Rose - 23 October 2016 Test S9.2 E

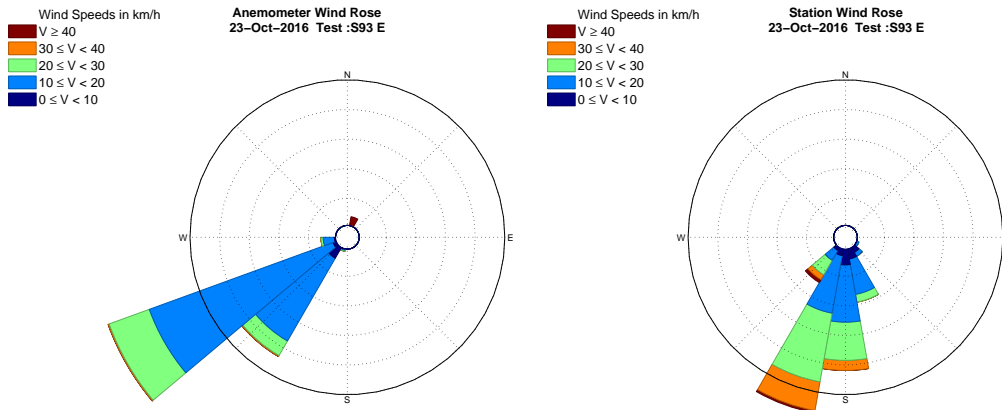

Figure B.55: Wind Rose - 23 October 2016 Test S9.3 E

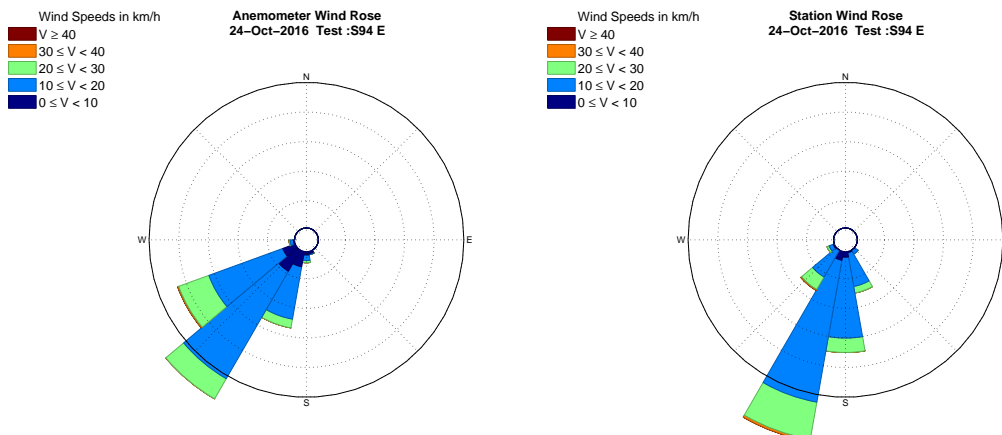

Figure B.56: Wind Rose - 24 October 2016 Test S9.4 E

Fuel-Economy Testing of a Three-Truck Platoon

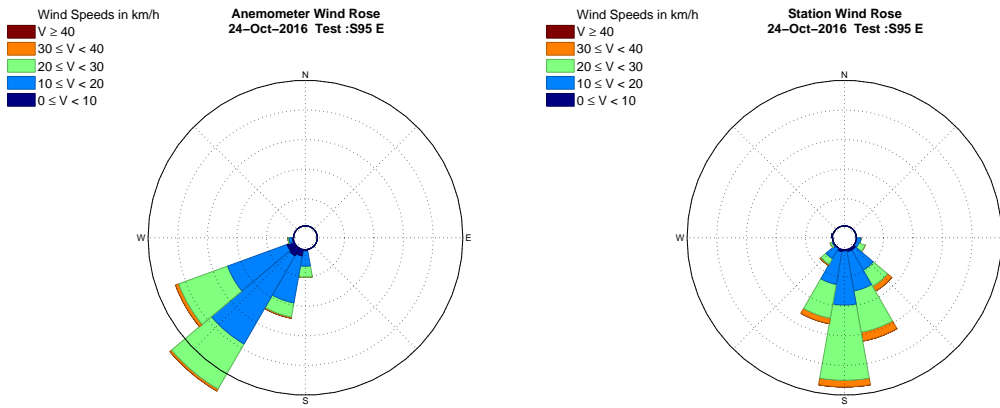

Figure B.57: Wind Rose - 24 October 2016 Test S9.5 E

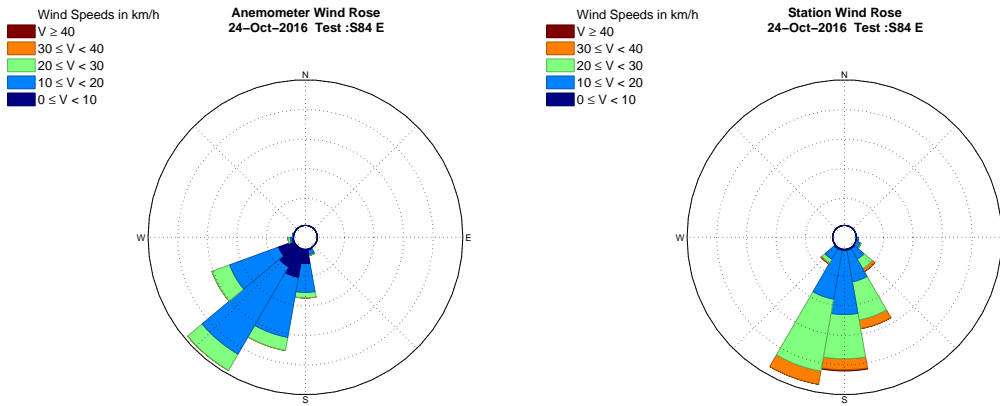

Figure B.58: Wind Rose - 24 October 2016 Test S8.4 E

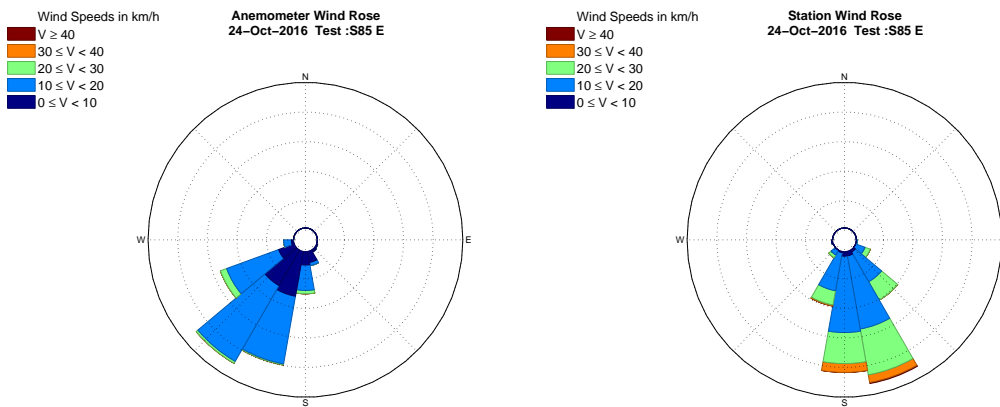

Figure B.59: Wind Rose - 24 October 2016 Test S8.5 E