

# Advancing Cutting Technology

G. Byrne<sup>1</sup> (1), D. Dornfeld<sup>2</sup> (1), B. Denkena<sup>3</sup>

1 University College Dublin, Ireland

2 University of California, Berkeley, USA

3 University of Hannover, Germany

## Abstract

This paper reviews some of the main developments in cutting technology since the foundation of CIRP over fifty years ago. Material removal processes can take place at considerably higher performance levels in the range up to  $Q_w = 150 - 1500 \text{ cm}^3/\text{min}$  for most workpiece materials at cutting speeds up to some 8.000 m/min. Dry or near dry cutting is finding widespread application. The superhard cutting tool materials embody hardness levels in the range 3000 – 9000 HV with toughness levels exceeding 1000 MPa. Coated tool materials offer the opportunity to fine tune the cutting tool to the material being machined. Machining accuracies down to 10  $\mu\text{m}$  can now be achieved for conventional cutting processes with CNC machine tools, whilst ultraprecision cutting can operate in the range  $< 0.1\mu\text{m}$ . The main technological developments associated with the cutting tool and tool materials, the workpiece materials, the machine tool, the process conditions and the manufacturing environment which have led to this advancement are given detailed consideration in this paper. The basis for a roadmap of future development of cutting technology is provided.

## Keywords:

Cutting, Material Removal, Process Development

## ACKNOWLEDGEMENTS

The authors are grateful to the following persons for their contributions to the preparation of this paper:

Professor Taylan Altan, The Ohio State University, USA, Professor Ekkart Brinksmeier, University of Bremen, Germany, Professor John Corbett, Cranfield University, UK, Professor Fritz Klocke WZL, Aachen University, Germany, Professor T. Moriwaki, Kobe University, Japan, Professor John Sutherland, University of Michigan, USA, Professor Rafi Wertheim, Iscar Ltd., Israel, Professor Scott Smith, University of North Carolina at Charlotte, USA, Professor Matt Davies, University of North Carolina at Charlotte, USA, Professor Kees van Luttervelt, Delft University of Technology, Holland, Alex Corcoran and Garret O'Donnell, University College Dublin, Ireland, Professor Eckart Uhlmann, Technical University Berlin, Germany, Professor Klaus Weinert, University of Dortmund, Germany.

## 1 BACKGROUND

Since the foundation of CIRP in 1950, the Scientific Technical Committee for Cutting [STC "C"] has been highly active in pioneering the development of all aspects of the cutting process [1]. Central to the work has been the complete analysis of the tool/workpiece engagement including the chip formation mechanisms, the investigation of the fundamental wear mechanisms and life of the cutting tool and the analysis and characterisation of the machined surface and surface layer. This analysis has not just been performed from a materials science perspective, but also from the perspectives of the energy balance and dynamic behaviour.

It is most interesting to review the first available Annals of CIRP Volume I, 1952 which reports on the Assemblée Générale De Louvain, 1952 [2] organised by PETERS. NICOLAU presented on the subject "Position du problème de la qualification des aberrations microgéométriques des surfaces de pièces mécaniques". OPITZ presented on "Eine Zusammenfassung über die Deformation des Spanes und den Verschleiss der Werkzeuge" and KIENZLE on "Bemerkung zu den Grundbegriffen der Oberflächen-

geometrie". In a further presentation by OPITZ, the doctoral work of SALJÉ was presented on external cylindrical grinding. Wheel speeds of  $v_s = 32 \text{ m/s}$  and depths of cut as low as 6  $\mu\text{m}$  were utilised. At that time considerable work was in progress on the development of dynamometers for force measurement arising in machining processes and this paper reports on a state of the art grinding dynamometer. BICKEL (ETH Zürich) addressed the issue of two dimensional heat flow in the vicinity of the cutting edge while EUGÈNE presented micrographs of chip roots at magnifications of x70 and x60. Clearly, the heritage of the Scientific Committee "Cutting" [STC"C"] within the CIRP community is very strong.

Having achieved strong technical competence during 50 years of remarkable technological development, it is now appropriate to consider the future needs of production engineering from the perspective of cutting technologies. There is a need to re-examine the spectrum of cutting technologies so as to ensure that the balance of CIRP activities is attuned to the real needs of modern manufacturing industry. It is deemed to be very important that manufacturing engineering and then by implication cutting technologies be considered from the holistic perspective. Cutting technology is multidisciplinary with economics playing an increasingly important role. Recent studies [1] came to the conclusion that there should be a strong integration of technologies and management using information technologies (IT), for example, integration of the process planning and production planning, simulation of manufacturing systems, agile manufacturing, fast redesign of new products, modelling of manufacturing equipment performance, including the human operator, functional product analysis, virtual machining and inspection algorithms etc. The key change drivers in the case of cutting technology include: diminishing component size, enhanced surface quality, tighter tolerances and manufacturing accuracies, reduced costs, diminished component weight and reduced batch sizes (Figure 1).

These change drivers have a direct influence on the primary inputs to the cutting process namely the cutting tool and tool material, the workpiece material and the cutting

fluid. Each of these inputs are given detailed treatment in the paper (sections 2, 3 and 4 respectively).

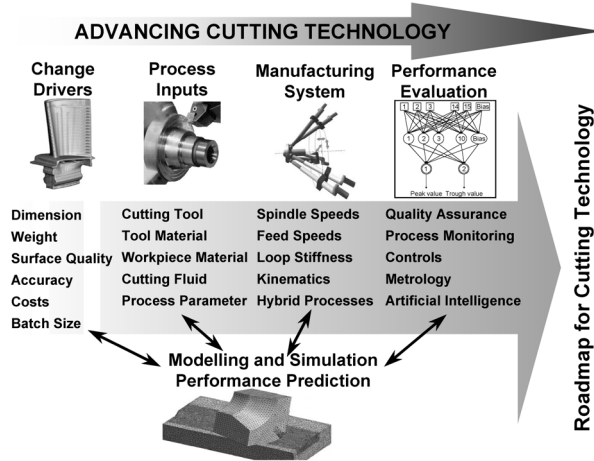

Figure 1: Primary aspects associated with advancing cutting technology.

These inputs go to the machine tool, which in parallel with cutting technology has also been the subject of enormous development since the early days of CIRP (summarised in section 5). SPUR [1] notes that the foundation of CIRP concurred with the early development of NC control for machine tools. Central to the whole issue of cutting technology is the performance capability and control of the manufacturing system. The ability to predict and evaluate cutting performance is addressed in section 6 of the paper.

The curves presented by [3] and updated recently by McKeown [4] in Figure 2 (in simplified form) trace the development in manufacturing capability in terms of achievable machining accuracy since the 1940's. Today, ultra-precision machine tools under computer control can position the tool relative to the workpiece to a resolution and positioning accuracy in the order of 1nm. Figure 2 shows that the achievable machining accuracy includes the use of not only cutting tools and abrasive techniques but also energy beam processes such as ion beam and electron beam machining, plus scanning probe techniques for surface measurement and molecular manipulation [4]. Figure 3 shows the capability of micromachining relative to other processes such as laser machining, EDM, grinding and the LIGA process. It can be seen that Ra values in the range down to almost 5 nm can be attained for features down to 1µm. For the case of "normal machining" e.g. CNC turning and milling machines, accuracies of 10 to 100 µm can be achieved (Figure 2).

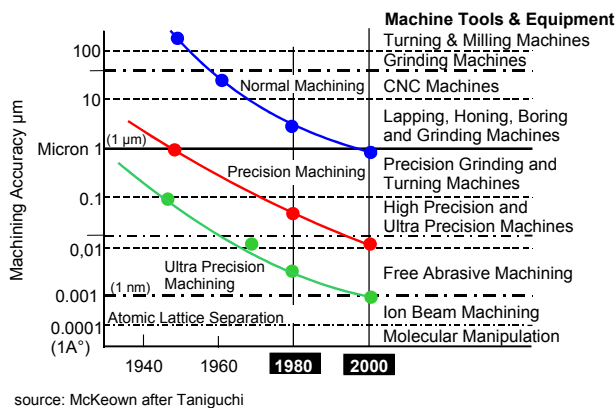

Figure 2: Taniguchi equivalent for cutting processes [modified by the authors].

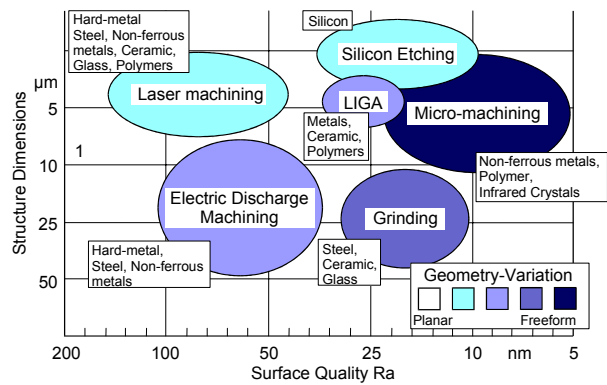

Figure 3: Micromachining relative to other machining processes [IPT-Aachen].

In parallel with the achievement of increased manufacturing accuracy there has been significant development in the reduction of the size of engineering components. Figure 4 shows the historical development in the weight reduction of the ABS system for automotive application. In the period 1989 to 2001, the weight has reduced from 6.2 kg to 1.8 kg. One of the important issues associated with miniature components is that the surface area to volume ratio increases. This being the case, the surface and its integrity takes on increasing importance.

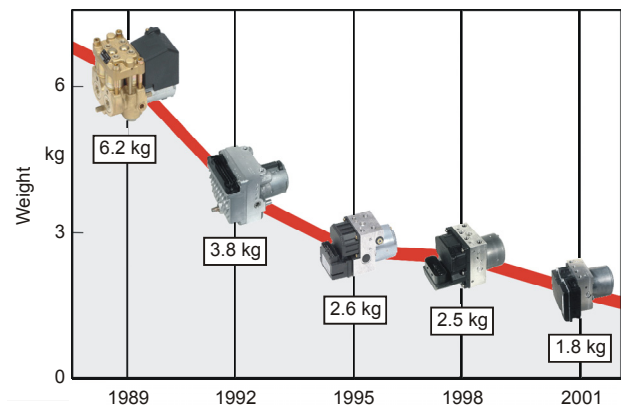

Figure 4: Weight reduction of the ABS system [Source: Bosch].

One of the key inputs to the cutting process is the cutting tool. When CIRP was founded, the range of cutting tool materials available was restricted primarily to: tool steels, high speed steel, stellite and tungsten carbide with ceramic materials coming on stream. For economic manufacture, the throughput time is the critical issue and the development of cutting tool materials has permitted a significant increase not just of cutting speed but also of feedrates.

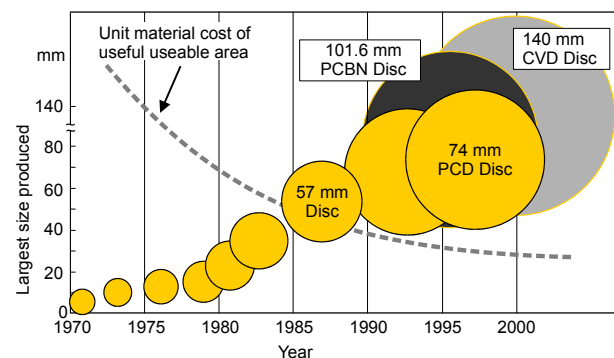

Figure 5: Cost reduction of superhard tool materials [source: Element 6].

Central to the economics of the cutting process is the cost of the cutting tool materials. Figure 5 shows the size evolution and cost advantage for PCD and PCBN since the 1970's. Diameters up to 140 mm can be reliably produced today for the CVD discs, 101.6 mm for PCBN and 74 mm for PCD. The unit materials cost of useable area of the discs is also shown. The dramatic reduction since the 1970's is clearly evident.

The workpiece material has also been the subject of extensive development in recent years. Figure 6 shows an overview of the hard turning process as related to the ISO standard and the Rz values achievable. The development is towards reduced Rz values and towards tighter ISO classes. Under controlled conditions IT 3 is now achievable at Rz values of below 1µm.

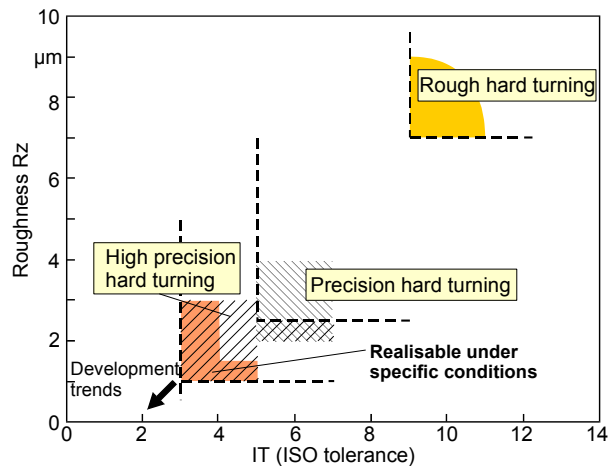

Figure 6: Roughness versus IT Tolerances for Hard Turning.

In the last 2 years emphasis has been placed on High Performance Cutting (HPC) and some fundamental issues are being addressed by the CIRP Working Group on High Performance Cutting (HPC) which was established in 2002 [5]. The working group identified the following aspects of cutting as being of particular significance in the quest for high performance cutting at high levels of productivity:

- Non Productive Times (NPT) in cutting processes,
- Dry and Near Dry Cutting (usage of minimal quantities of cutting fluids),
- Chip formation and chip handling processes and
- Strategies for burr minimisation.

The economic efficiency of production facilities is a central issue for cutting technology. In-plant, adding of value to products and workpieces only takes place during essential operating time. Conventional processes such as grinding and turning have come under close scrutiny from a productivity perspective and process chains have been analysed and redesigned to minimise throughput times. The trend in recent years has been towards integrated processes. For example, by replacing grinding with hard turning, process steps can be eliminated [6]. The requirement for integrated processes place new and demanding challenges on the design and technology of the cutting processes.

In parallel, it is also necessary to consider the technological and economic developments associated with the machine tool which have taken place in order to achieve these cutting speeds and the high level of productivity demanded. Figure 7 demonstrates how the cycle time for machining one model workpiece can be reduced by about 50% in five systematic optimisation steps [7].

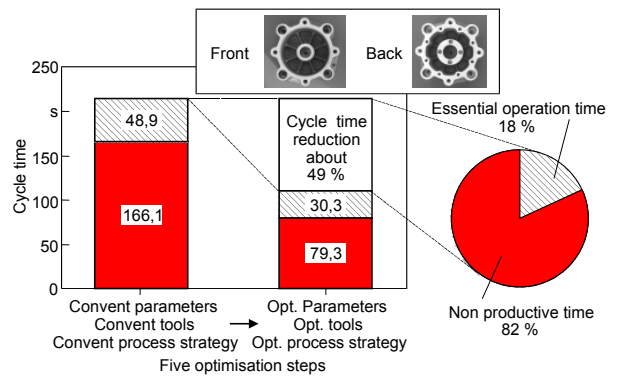

Figure 7: Reduction of the cycle time for machining a model workpiece [ISF].

On recognising that the prediction of process behaviour is taking on an increasingly important role, a CIRP Working Group on "Modelling of Machining Operations" was established in 1995 within the Scientific Technical Committee for Cutting [STC C]. The aim of this group was to stimulate the development of models capable of quantitatively predicting the performance of metal cutting operations better adapted to the needs of the metal cutting industry in the future [8].

## 2 CUTTING TOOL AND CUTTING MATERIAL DEVELOPMENTS

Cutting tools are subjected to high stresses by modern machining technologies, like dry machining, high-speed machining or high-performance machining. The development of new processes demands adapted cutting tools.

An ideal cutting material combines high hardness with good toughness and chemical stability. In particular hardness and toughness represent opposing properties and there is no single cutting material, which achieves all three conditions simultaneously. In order to merge the characteristics mentioned, wear resistant coatings with a tough substrate material are combined. A total coating thickness between 3-10 µm is appropriate, whereby the combinations and sequences depend on the application.

Especially in dry machining with coated tools, variations of the interface quality cause distinct differences in tool life. The substrate-layer compound fails due to thermal and mechanical loads in dry machining. Failures occur in particular if the substrate itself reaches a critical load. The failures of the compound are strongly influenced by the surface and subsurface characteristics of the ground tool. The surface and the subsurface characteristics of the tool are a direct result of the grinding operations used during the tool manufacture [9].

### 2.1 Cutting Materials

Materials utilised in cutting tools have to meet a different set of requirements than those used in general engineering construction applications. Important criteria, in addition to the dimensional quality in terms of size and shape, are the mechanical properties of the cutting material, for example high hardness and toughness at elevated temperatures. The toughness is indicated by the critical stress intensity factor, which describes the stress concentration required at the end of a crack to extend that crack. In choosing the materials for cutting applications the mechanical characteristics may not only be regarded at ambient temperature. Their behaviour must be considered as a function of the temperature (Figure 8). Good thermal shock resistance is an important characteristic of suitable cutting materials [10].

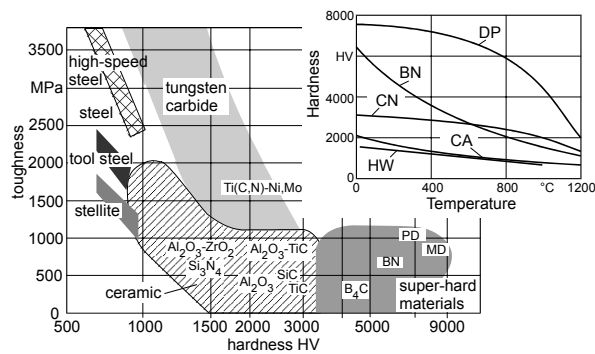

Figure 8: Toughness and hardness of cutting materials.

### Carbides

Carbides are made by powder metallurgy methods using metallic hard materials (primarily carbides) and tough metals of the iron group (binders). The most common hard metal is tungsten carbide (WC), which is made by sintering (at high temperature) a combination of tungsten carbide powder with powdered cobalt (Co). Two parameters, namely the ratio of Co to WC and the WC particle size, control the material properties [11].

Specifying a large WC particle size and a high percentage of Cobalt yields a high shock resistance and high impact strength. The finer the WC grain size (and therefore the more WC surface area that has to be coated with Cobalt), the less Cobalt is used and the harder and more wear-resistant the material becomes. The most significant new development to increase hardness in the case of the WC-Co carbides are the submicron and ultra-fine grained alloys with WC grain sizes of 0.5 - 0.8  $\mu\text{m}$  and 0.2 - 0.5  $\mu\text{m}$ , with a respective cobalt content of 6 - 16% by mass. Unlike standard materials, all the fine powder particles have more or less a round shape which has a favourable influence not only on uniformity of the as-sintered microstructure but also on compactability.

One of the latest developments in the field of carbides is a functional gradient in near-surface areas of cutting tools leading to functional gradient carbides. Such a functional gradient is a specific smoothly varying distribution of phases and/or element composition to provide a highly resistant surface region which withstands the cutting tool and workpiece interaction at high temperatures and which smoothly attains the microstructure of the carbide [11].

### Cermets

The growing importance of dry machining has given new impetus to the development of cermets. In principle cermets have a similar microstructure to conventional carbides. They contain various hard material particles in a binder matrix of cobalt and nickel. The hard material components do not consist of WC and (Ti,Ta,W)C but of carbonitrides of titanium (Ti) with different proportions of tantalum (Ta), tungsten (W) and sometimes molybdenum (Mo) [1, 12].

In the microstructure of conventional carbides the mixed carbides of titanium are rounded and the tungsten carbides angular. The cermet microstructure displays exclusively rounded carbonitrides of titanium, and these hard material particles have characteristic core-rim structure. The toughness of nitrogen-containing cermets is comparable with that of conventional carbides. The oxidation resistance is outstanding [12, 13].

The advantages of cermets are the high hardness values at elevated temperatures that enable high cutting speeds and the chemical stability which effects high wear resistance as well as good surface quality of the workpiece. As cermets are less tough than WC-based cemented car-

bides, limitations concerning the feed rate are evident. Due to their properties, cermets are the link between the hard brittle ceramic cutting tools and the tough, but less wear resistant, cemented carbides [14, 15, 16].

### Ceramics

For cutting tools, two kinds of ceramic composite materials are used, which can be differentiated according to the matrix materials. Aluminum oxide, commonly referred to as alumina, possesses strong ionic interatomic bonding giving rise to its desirable material characteristics. It can exist in several crystalline phases which all revert to the most stable hexagonal alpha phase at elevated temperatures. It can be combined with hard materials like carbides, in order to change the mechanical properties of the matrix [17].

On the other hand, silicon nitride is used. Silicon nitride has good high temperature strength, creep resistance and oxidation resistance. In addition, its low thermal expansion coefficient gives good thermal shock resistance compared with most ceramic materials. Silicon nitride is produced in three main types: Reaction Bonded Silicon Nitride (RBSN), Hot Pressed Silicon Nitride (HPSN) and Sintered Silicon Nitride (SSN) [18].

Precursor ceramics are monomers or polymers containing all the elements to be present in the final materials. The idea behind this approach is to carry out changes at the atomic level, which in turn, change the properties of the material. In contrast with conventional ceramic processing, ceramic precursors can be processed at low temperatures [19].

SiC whisker-reinforced ceramic composites are an innovation that have come into prominence for potential structural applications because of the significant improvements in the mechanical properties of these materials. SiC whiskers used for reinforcement are discontinuous, rod- or needle-shaped fibres in the size range of 0.1 to 1  $\mu\text{m}$  in diameter and 5 to 100  $\mu\text{m}$  in length. For example the incorporation of SiC whiskers into alumina ceramics results in an increasing strength, fracture toughness, thermal conductivity, thermal shock resistance and high temperature creep resistance. Because they are nearly single crystals, the whiskers typically have very high tensile strengths (up to 7 GPa) and elastic modulus values (up to 550 GPa).

### Boron Nitride

There exist different crystal forms of boron nitride: Graphite-like, more commonly referred to as hexagonal boron nitride is known for its soft and lubricating qualities, contrasted to the cubic structure (CBN) which is hard and abrasive and used for cutting tools. CBN has the same structure as diamond and its properties mirror those of diamond. Indeed CBN is the second hardest material next to diamond. CBN, a synthetic material that is composed of cubic boron nitride grain and special ceramic binder, has excellent features such as high hardness and less chemical wear resistance up to temperatures of 1400  $^{\circ}\text{C}$  [20]. It shows great performance for high-speed finish turning of hardened material and grey cast iron.

### Diamond

Natural diamonds consist of carbon. The different colours originate by inclusions of pigments. Monocrystalline Diamond (MCD) is the hardest material. This hardness is caused by the specific atomic grid structure in the crystal.

Diamond can be manufactured by a synthesis under extreme high pressure and temperature. Because of their higher toughness polycrystalline diamond (PCD) tools are preferred to monocrystalline diamond tools for cutting applications [21].

Diamond provides an impressive combination of chemical, physical and mechanical properties; e.g. low coefficient of friction and thermal expansion, high strength and resistance to chemical corrosion. But diamond also has limitations. It is meta stable at room temperature and pressure, forming a black coat when heated to above 600°C in oxygen. Due to the chemical affinity of carbon and iron, the machining of ferrous materials by diamond results in high wear rates.

## 2.2 Cutting Tool Manufacture

The quality of coated tools is influenced by various factors. These factors themselves are influenced by the method of manufacture of the tool substrate. In order to understand the mechanisms by which the coating is applied, the entire manufacturing process must be considered.

Between the single process steps, technological interactions determine the output-values of one step and the input-values of the following step. The sintered material passes through many different processes up to the finished tool. During the grinding process the geometry and the surface characteristics are determined. Likewise the grinding process affects the subsurface characteristics such as the residual stress state. Figure 9 illustrates the relative costs of each of the powder metallurgical tool processing stages. It is obvious, that both the grinding and coating processes incur the highest costs [10].

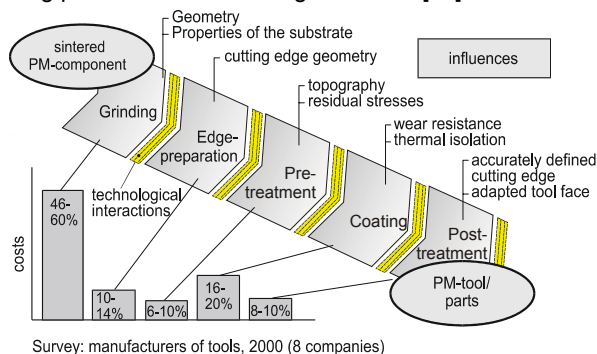

Figure 9: Manufacturing process of powder metallurgical tools.

Thermal and mechanical loads in grinding during tool manufacturing influence the roughness, the topography as well as the surface integrity of the substrate. By the measurement of the residual stresses in the substrate, these influences of the grinding process can be detected. Generally high compressive residual stress is induced by the mechanical effect of the grinding process. The thermal load caused by friction in the grinding operation leads to tensile residual stress and counteracts the compressive residual stress in the substrate. The residual stress distribution is an important factor in the following coating process [22].

The coating adhesion investigations are undertaken by turning tests with coated tools. Turning tests with a cutting time of  $T = 10$  min are undertaken. Improved coating adhesion of samples ground with the D25 grinding wheel indicates the positive effect of varying grinding parameters. Furthermore the tools ground with the D25 grinding wheel exhibited very low wear levels, see Figure 10. The tools ground with oil show a smaller wear land, than the tools ground with emulsion. Compressive residual stresses that are induced into the substrate by the grinding process are slightly reduced by the residual stresses inherent in the PVD (physical vapour deposition) coating. When using the cutting tools in turning applications, the compressive stress in the subsurface of the substrate is reduced by tensile stresses induced in the process. A failure in the substrate itself is the consequence [23].

Micro blasting can minimise this effect by loading high compressive stresses in the substrate before coating.

The application of fine grinding wheels produces smoother surfaces that minimise the amount of smeared bond material required. On the other hand, the application of coarse grinding wheels leads to high compressive stress in the subsurface. Both contribute to an increase of the adhesive strength of the coating (Figure 10) [24].

The poor machinability of WC-carbides influences the surface quality attained by the grinding processes during the tool manufacturing process. In particular, the interface strength of PVD-coatings depends on the surface properties of the substrate. The residual stress state and the surface roughness has been taken into account. Whereas in wet machining the interface strength of PVD-coated carbide tools are sufficient, in dry machining variations of interface quality cause distinct differences in tool life. Because of high interface loads in dry cutting processes, deposited PVD-coatings chip off (including the adhered binder phase). Superior wear behaviour in dry machining was observed as a result of using adapted grinding conditions in the tool manufacturing process.

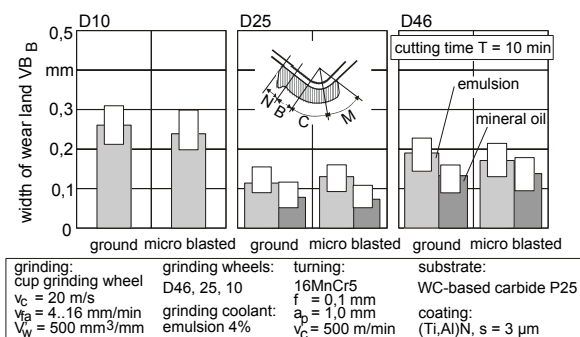

Figure 10: Influence of tool grinding on the cutting performance in turning.

The market share of coated tools is increasing continuously, since the metal working industry is constantly calling for more effective machining processes [25]. For operations with a geometrically defined cutting edge, this means higher cutting speeds, high removal rates, dry cutting wherever possible and a high process reliability. Also, new materials with great design potential often cause machining problems. This means increasing demands on tools regarding mechanical, thermal and chemical resistance. The advancement of the coating technology leads to the fact that in particular the market share of new improved and also complex coatings will strongly increase in the coming years. Special attention, however, must be given to the cutting edge radius, which is dependent on the coating thickness [26]. A thin coating thickness, leads to strongly negative face angles. In Figure 11 the basic structures of different coating concepts are represented.

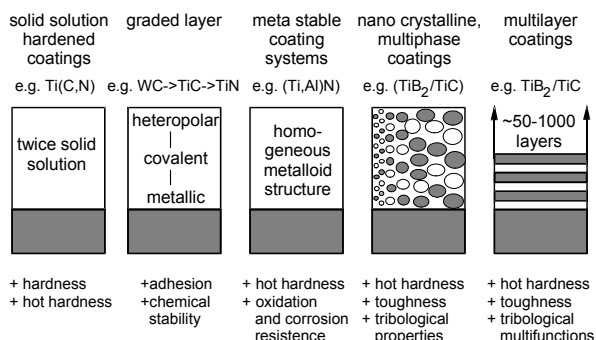

Figure 11: Structure of Coatings.

Coated carbides are proven for machining of non-ferrous metals, nickel based alloys and for austenitic and ferritic stainless steels. The number of the possible layer combinations is almost unlimited. The importance of titanium based tool coatings in machining has also been documented [27].

Multi-layer coatings enable the generation of more favourable characteristic combinations. For example, TiC can be applied with good adhesion on a tough tungsten carbide. It reduces abrasive wear because of its high hardness. Ti(C,N)-coatings can be structured on TiC with uniform transition of the proportions up to pure TiN. The nitride is chemically slow-acting and prevents diffusion and oxidation wear. Furthermore, its inclination to adhere is relatively small and this lowers the adhesion wear. (Ti, Al)N shows advantages at high process temperatures and forms a thin passive layer at the tool surface, which prevents a fast progressing diffusion or oxidation wear. The hardness of (Ti, Al)N at elevated temperatures is much higher than any other common hard coatings [27]. High ionisation pulsing processes currently allow the coating of non-conducting nitrides with a high content of oxidelayer forming elements, for example (Al, Ti)N supernitride coatings with more than 65 mol% AlN.

Intermediate ceramic layers can furthermore modify substantially the tool-chip interface behaviour and thus the dissipation of frictional heat between sliding materials [28]. CVD-diamond (chemical vapour deposition) thick layer coatings have yielded very good results in recent time for the machining of non-ferrous materials. They show an excellent resistance against abrasive wear and thermal loads and boron doping improves the thermal resistance. The fundamental problem of the CVD-diamond thin layer coatings is the coating adhesion process. Furthermore the coating surface roughness is high. A main effort to improve the performance of CVD-diamond coatings nowadays concentrates on the improvement of the coating adhesion [21]. Also, smooth diamond coatings are in development and show good results. [29]

Tool wear results from friction and thermal loads in the contact zone between chip and tool. By applying a hard coating, the frictional behaviour between chip and tool is influenced. The friction is reduced by the coating, which has the consequence that the chip can glide faster over the tool. Thereby a smaller contact zone between chip and work piece develops. This has as the consequence that the smaller contact length reduces the thermal loading on the tool.

#### Requirements and influences on properties of coated tools

Several properties of the layer-substrate system are required to achieve a high wear resistance as well as a high process safety in cutting. The substrate determines geometry and toughness of the tool whereas the tribological properties depend on the layer characteristics. The intermediate zone between coating and substrate, called interface, determines the film adhesion.

The requirements on coatings for wear protection in cutting are a high hardness and a sufficient toughness. Furthermore, reduced tribological interactions to the workpiece material have to be achieved at the surface of the coating. Several coating technologies offer the possibility to deposit various coating compositions as well as coating structures. Nowadays it is mainly CVD-processes that are used for deposition of tool coatings. Disadvantages of the CVD-technology are high thermal loads imparted to the substrate as well as the thermal stresses in the interface due to high temperatures during deposition ( $T > 800^{\circ}\text{C}$ ).

Characteristics of PVD-processes are low substrate temperatures during deposition ( $300^{\circ}\text{C} < T < 500^{\circ}\text{C}$ ) as well as a great flexibility of possible target materials. Due to

these advantages PVD-processes gained more importance in coating of cutting tools in the last 15 years.

#### Self-lubricating coatings

In many cases, self-lubricating coatings (soft coatings) are applied to tools for dry machining operations nowadays. Friction and process heat can be reduced [30]. Soft coatings on MoS<sub>2</sub>-base as well as on diamond like carbon (DLC) show good results. Figure 12 shows the wear behaviour of the cutting edge of (Ti,Al)N-coated and (Ti,Al)N+ a-C-coated drills. a-C-coatings belong to the class of diamond-like carbons. The matrix consists of carbon, which is the reason for the good tribological properties. The metallic component consists of at most 5 – 15 at % W, Ta or Nb.

The development of the tool wear can be divided into two phases. In the first phase, the running in period, the drills show a rapidly increasing tool wear. In the second phase, the wear rate declines but is continuously increasing over the tool path  $l_f$ .

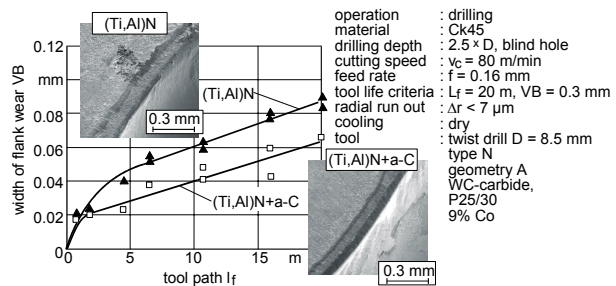

Figure 12: Wear performance of soft coated drills.

The (Ti,Al)N-coating shows the highest wear rate in the first phase. After a tool path of  $l_f = 4$  m the width of flank wear if using (Ti,Al)N-coated tools is  $40 \mu\text{m}$  compared to  $25 \mu\text{m}$  if using (Ti,Al)N+WC/C-coated tools. The soft coating shows a measurable relief of the tool in the first phase. In the second phase, both tools show a similar increase of the width of the flank wear. Here, the soft coating shows no further influence on the wear behaviour. For drills, further advantages of soft coatings can be found in a better chip removal, since the reduced friction in the chip flutes prevent a stacking of the chips. The effect of an improved performance of the tool during the running in period is also reported with a PFPE layer on a TiN coating [31].

Now it is possible by CVD and PCVD techniques to synthesise new multi-component and multi-phase coatings for cemented carbide inserts and tools. These coatings include carbonitrides, nitrides and oxides of titanium, zirconium, hafnium and aluminium [25].

### 2.3 Cutting tool design

The improvement of cutting tools was mainly achieved in the past by an optimisation of macro geometry and an increased performance of cutting tool material and coatings. Modern tool design considers detailed and specialized geometries for each cutting application. A trend is to realise different cutting processes with a single tool (e.g. stepdrills, drilling-hoist-mill, etc.).

In addition to defining the tool macro geometry, it is necessary to adapt the cutting tool material and coating system for each special application. Thus, the trend toward customised tooling is underway. The optimisation of cutting tools regarding the macro geometry is advanced to a considerable degree. Due to the expanding know-how, the geometry of the tools is varied within very close tolerances. The conflicting aims for optimising the tool geometry consists essentially of a rigid tool design that enables the removal of large sized chips. Substantial

increases of the performance of cutting tools can be only achieved by the sensible manipulation of the defined cutting edge geometry. In the past, the cutting edge geometry was defined by presence of an arc or the size of the radius. Further investigations show that it is absolutely necessary to give a more detailed view of the cutting edge geometry [32].

The aim of optimising cutting edge geometry is to improve the surface quality of sharp edges. These are very susceptible to wear. The cutting edge is prepared by an additional production process (brushing, blasting, etc.) after grinding to improve the quality of the surface and the tool life. Beside the improvement of the surface quality a purposefully designed cutting edge enables the possibility to affect the chip formation thereby achieving reduced cutting forces and a better workpiece quality.

A systematic investigation requires a characterisation of the defined shapes of the cutting edge geometry. Former characterisation took place by defining only the cutting edge radius  $r_\beta$ . This description of the cutting edge geometry is not sufficient, because the shape does not resemble an arc of a circle. Moreover, the same radii can be measured with apparently different forms. So far there are no standardised instructions, how the cutting edge radius should be measured in case of different shapes. Four new characterisation parameters are introduced:  $\Delta r$ ,  $\varphi$ ,  $S_\gamma$ ,  $S_\alpha$  [32] (Figure 13). These parameters enable a better characterisation of uneven shapes of the cutting edge.

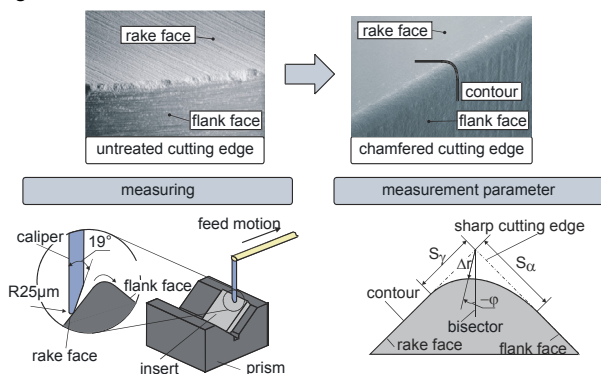

Figure 13: Characterisation of the cutting edge geometry.

The value  $\Delta r$  describes the size of the chamfer shape, the angle  $\varphi$  the shift of the cut point either to the rake face - or to the flank face, the parameter  $S_\gamma$  and  $S_\alpha$  the sharp or obtuse run of the curve to the rake- or the flank-face respectively. These parameters can be automatically determined with the help of a measurement program.

It should be considered that the ray-tracer possesses a sufficiently small nose angle, in order to be able to flawlessly scan different chamfer geometries with different wedge angles. For the measurement the cutting edge is aligned on a prism, and the chamfer is scanned with the calliper. Primary investigations in cutting tests in orthogonal turning show strong dependencies of these parameters (Figure 14).

For these cutting tests, different chamfer geometries are prepared and tested in orthogonal turning. The results show that in spite of a constant parameter  $\Delta r$  there is no linear run of the curve. In each case an even chamfer geometry with  $\varphi = 0$  causes the highest cutting forces. It is shown that for all the uneven chamfer geometries - whether in a positive or negative direction - smaller cutting forces result. The deviation of the machining forces with varying angles is larger for smaller feed rates than for higher ones. It should be considered that there is an increased influence of the cutting edge geometry with

smaller feed rates especially for the finishing operations. The machining forces can be reduced with an unevenly chamfered cutting edge. Thus increased quality of the workpiece surface can be obtained and the tool life can be increased. The investigations show that a characterisation of the cutting edge geometry using only the chamfer radius  $r_\beta$  is not sufficient.

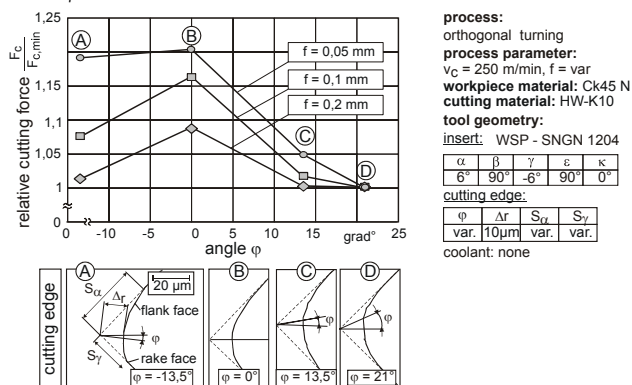

Figure 14: Cutting edge geometry and cutting forces.

The new introduced parameters enable a practical characterisation of the cutting edge geometries. A defined cutting edge geometry is necessary for an effective machining process with reduced tool wear and improved surface quality of the workpiece.

### 3 WORKPIECE MATERIALS AND CUTTING PROCESSES

The individual industrial branches drive the specific demands for new innovations using the differing engineering materials. In particular in the automotive and the aerospace sectors, the use of light weight, energy saving materials play a vital role for structural components, housings and drive system components. The continuing generation of new material types feeds the demand for low-density materials with high strength and easy manufacturability. Material removal rates for different processes and workpiece materials are summarised in double logarithmic form in Figure 15.

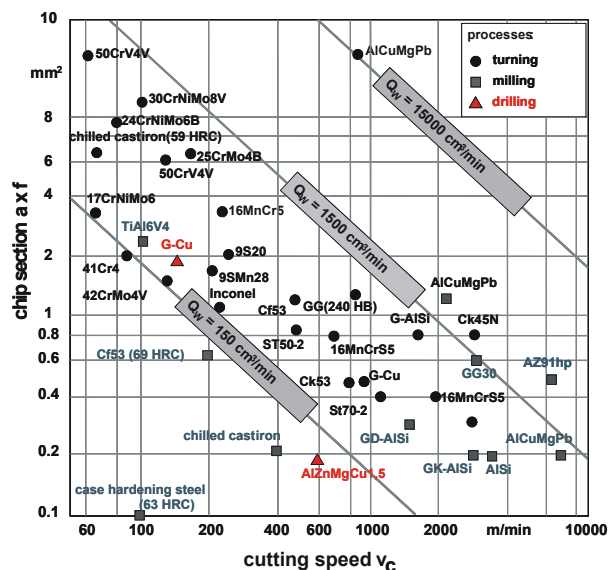

Figure 15: Material removal rates for a range of materials and cutting processes [33].

The material removal rate which is the main target for optimisation of a high performance cutting process is calculated by the chip section and the cutting speed. The possibility of adjusting these variables is strongly depend-

ent on the combination of cutting technology and machining task. The rates lie primarily in the range  $Q_w = 150$  to  $1500 \text{ cm}^3/\text{min}$  for the majority of materials. As can be expected, modern manufacturing research seeks to push this trend toward higher material removal rates.

The increase of the material removal rate is a function of both the specific characteristic of the cutting technology and the work-piece material properties. Figure 16 gives an indication of achievable cutting speeds.

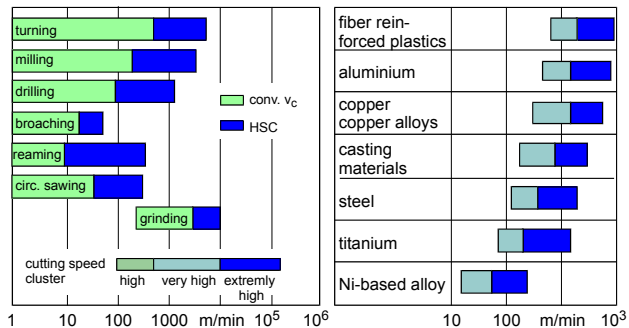

Figure 16: Achievable cutting speeds [34].

Today the HSC process is mainly realised in the area of aluminium and manganese machining. These work-piece materials cause relatively low mechanical and thermal load on the cutting tool. For example, front milling of manganese is performed dry with a cutting speed up to  $v_c = 4000 \text{ m/min}$  and a feed to  $v_f = 60 \text{ m/min}$ . The further tool development made it possible to increase cutting speed and feed rate for drilling and reaming operations up to  $v_c = 500 \text{ m/min}$  (drilling) /  $v_c = 1500 \text{ m/min}$  (reaming) and feed rate to  $f = 0,9 \text{ mm}$ .

In the case of grinding processes typically a  $Q_w$  of the order of 200 up to  $2500 \text{ cm}^3/\text{min}$  can be achieved. With respect to the cutting speed  $v_c$ , the process window in grinding is pushed toward comparably higher speeds of between 1200 up to  $15000 \text{ m/min}$ . However, in grinding the material removal rate  $Q_w$  depends to a large extent on the active width of the grinding wheel and, hence, on the geometry of the component.

Some of the important developments for a range of different workpiece materials are now given detailed consideration. These include hardened steels, leaded and calcium treated steels, cast materials, lightweight materials, and aerospace materials. The ultra-precision machining of ductile and brittle materials is not addressed in this paper.

### 3.1 Cutting of Hardened Steels

The functional behaviour of machined parts is strongly influenced by the fine finishing processes which represent the final step in many process chains [6, 35, 36]. High flexibility and the ability to manufacture complex work-piece geometries in a single set-up are among the main advantages of hard turning over grinding. The residual stress values on the subsurface of the workpiece are mainly influenced by the friction between the workpiece material and the tool tip. With an increasing flank wear friction and consequently thermal load to the part surface is rising – a new tool cutting edge induces compressive residual stresses to the part subsurface, whereas a progressively worn tool tip causes tensile residual stresses and the appearance of a ‘white layer’ with an extremely fine microstructure (Figure 17).

High hydrostatic pressure is found to be the most important physical quantity for the plastic deformation of hardened ferrous materials which is essential for manufacturing technical surfaces [37, 38]. Localised shearing occurs and results in segmented chip formation. Local thermal softness, crack initiation in the free surface and micro-

cracks in the shear zone represent the most important phenomena initiating localised shearing [39]. In the literature different theories exist concerning crack growth. Crack initiation and crack growth are subject to temperature distribution, stress distribution, strain and strain rate in the work area as well being dependent on time and location. Crack initiation and crack growth are influenced by the location dependent thermo-mechanical loads [6].

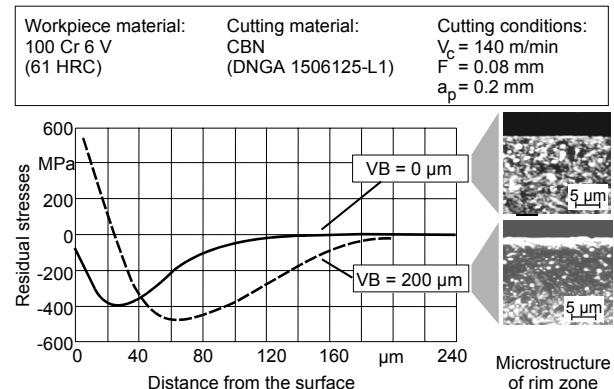

Figure 17: Residual stress and surface layer effects after hard turning [40].

A more recent development is the application of the burnishing process following hard turning, which can be implemented on the same machine tool as that used for the turning process. In this process a hydrostatically supported ceramic ball is pressed against the machined surface. The feed of the ball permits the burnishing of the entire surface. The pressure applied by the hydrostatic bearing system dictates the force with which the operation takes place. High contact stresses can be obtained through this plastic deformation process which smooths the roughness peaks, increases the hardness of the surface layer and induces high compressive residual stresses (Figure 18). All effects improve component life [40].

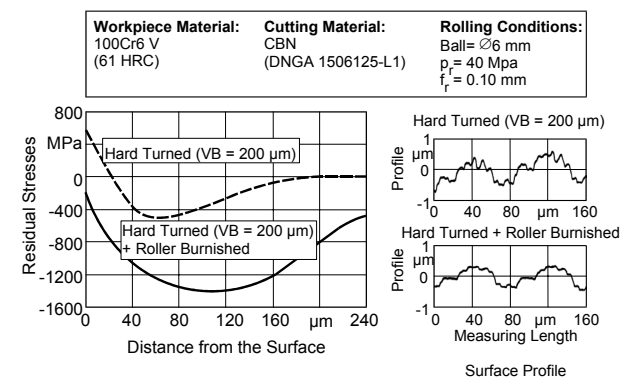

Figure 18: Surface layer effects due to roller burnishing [40].

### 3.2 Cutting of Leaded and Calcium Treated Steels

For decades, low levels of lead have been added to free cutting and engineering steels with the objective of improving their machinability. In recent years the use of lead has become undesirable for environmental reasons. Hence, there is considerable interest in the development of materials with alternative machinability enhancers. Accordingly, there are many demands on the new additives as they must not diminish the machining performance. Lead is not soluble in steel and is distributed in a fine dispersive manner in the material. In low carbon free cutting steels, lead accumulates at the manganese sulphides. König [41] studied the influence of non-metallic inclusions on the machinability of steels. The small lead inclusions cause an embrittlement of the workpiece mate-



rial at the local cutting temperatures and they are believed to act as an internal lubricant [42]. The friction in the contact zone between work piece and tool is lowered, which leads to reduced heat generation during cutting (Figure 179).

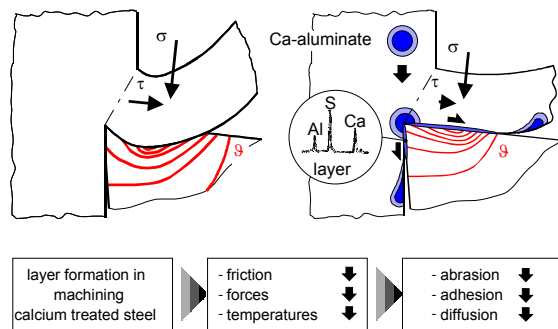

Figure 19: Layer formation in machining calcium treated steels [43].

A reduction of cutting temperatures up to 30% compared to unleaded steel can be achieved [44]. Cutting forces are reduced, and tool life is enhanced (Figure 1720). Further, additions of lead improve surface quality and chip breakage. Latest investigations regarding the substitution of lead deal with the comparison of tin, bismuth and sulphur additions and the resulting machinability. Both the plain and the leaded steels act as a benchmark in this case. Admittedly, not only the machining performance has to be evaluated but also the component behaviour needs to be taken into account. Furthermore, metallurgy plays a distinct role, as only an optimised desoxidation methodology can guarantee the desired sulphide types and soft oxide inclusions [45].

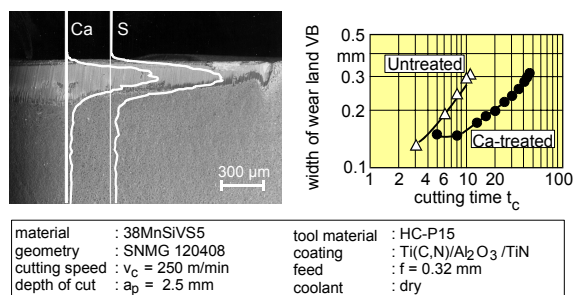

Figure 20: Influence of calcium treatment on tool life in turning with coated carbides [45].

### 3.3 Cutting of Cast Materials

In recent years the development of new cast iron materials has been seen to offer greater competition to other materials and make cast iron a contender for components not traditionally manufactured from this material. Two newer materials that form a major part of these recent developments are Compacted Graphite Iron (CGI) and Austempered Ductile Iron (ADI) whereby CGI and ADI offer significantly higher strengths in the fields of cast irons possessing lamellar graphite and globular graphite structures respectively.

Compacted Graphite Iron is a suitable material for engine blocks in high performance diesel engines. In addition to the higher machining power requirements, the machining of CGI requires further development of the machining strategies used for conventional laminar cast irons. Typical HSC processes such as the drilling of engine cylinders using a single edge CBN tool are no longer feasible due to the dramatically reduced tool life. Changes in the wear

characteristics result not only from the altered graphite form, but in particular due to the reduced sulphur content and the incorporated hard metal particles such as TiC. In this regard, the wear minimising MnS layers are no longer formed. Also, the utilisation of other hard metal cutting materials bring no clear advantage. For this reason, current transfer scenarios utilise only conventional cutting speeds. Tools with multiple cutting edges must be utilised in order to reach the required process cycle times [47, 48].

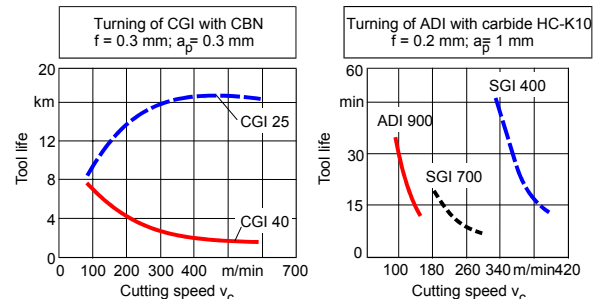

Figure 21: Demands on the cutting process in the turning of CGI and ADI [46, 47].

Austempered Ductile Iron is a further development of conventional globular cast iron. The unusual combination of high strength, high ductility and high toughness results from a special heat treatment mechanism, entitled Austempering. The primary reason for the excellent mechanical properties of ADI is its fine structured austenite-ferrite basis grain structure – also known as Ausferrite. The austenite present in this grain structure is stabilised by the typical high carbon content of cast irons. It is also free of the carbides that are present in steels which undergo the same heat treatment. As a result, the improved mechanical properties of ADI require machining development. High strength, high abrasive wear characteristics and a high ductility lead to significantly increased mechanical and thermal loading close to the cutting edge of the machining tool. In the case of dry turning with K10-hardmetal tools, this leads to explicit crater wear. Typical cutting speeds used in the case of conventional globular cast irons (e.g. over 200 m/min) must as a result be reduced to approximately 140 – 180 m/min. Significant process tuning must also be undertaken in the case of drilling, tapping and gun drilling. The increased material load associated with ADI leads to reduced tool life (Figure 17). In the case of drilling, for example, drill geometry must be optimised. Conventional drills achieve only 10% of the tool life of these optimised drills [47].

### 3.4 Cutting of Lightweight Materials

#### Aluminium

Aluminium materials, in the form of cast and wrought alloys, have a wide variety of applications both in small-to-medium volume production and mass production. Due to its low density and excellent recycling potential, the demand for aluminium in the transport industry is increasing [49].

Technically, the most important alloying elements are silicon, magnesium, zinc and copper. A silicon alloy content of 12.5% defines the Eutectic point in this material system. Due to the bandwidth of the utilised alloying elements, the machinability of the aluminium alloy depends on the alloy composition and the associated grain structure (e.g. heat treatment) of the material. The various material categories such as wrought alloys, hypo-eutectic and hyper-eutectic cast alloys differ significantly in their mechanical properties. The extremely high tendency of aluminium to adhere during cutting presents a significant risk that can lead to tool breakage [50]. Long, ductile chips, that complicate the machining process, are formed

regardless of the cutting tool geometry chosen. The use of cutting fluids is unavoidable in the case of these materials.

The influence of workpiece material on the chip formation under high speed cutting conditions (HSC) when turning pure aluminium Al99.5 and the aluminium alloy AlZnMgCu1.5 was investigated by Brinksmeier et al. [51].

### Magnesium

Magnesium has been rediscovered as a material for light-weight construction, mainly driven by the automotive industry. Typical applications are gear housings, steering wheel cores, seat frames, lock housings, cross car beams and other parts produced by die-casting. It is predicted that the number of magnesium die castings will double between 1998 and 2008 [52]. Magnesium die-castings exhibit good machinability. Magnesium materials such as alloy AZ91hp, are practically free of abrasive particles and possess very little susceptibility to adhesion with the cutting tool surfaces. The result is low cutting tool wear. High cutting speed,  $v_c = 4000$  to  $6000$  m/min and feeds per tooth up to  $f_z = 0.6$  mm in face milling can be applied, provided the thin walled castings have sufficient rigidity. In drilling, cutting speeds up to  $v_c = 1000$  m/min and feeds as high as  $f = 0.8$  mm are possible. Finishing operations like reaming can also be performed at very high cutting speeds greater than  $v_c = 1500$  m/min, provided the stability of the components and the reamers allow for such conditions. The cutting forces in machining magnesium are about 30% smaller as compared with hypo-eutectic aluminium alloys. All cutting operations produce short breaking chips. The reason for this is the HCP lattice structure of the magnesium crystal, which only offers the base plane for slip under shear stress at room temperature. At temperatures greater than  $220$  °C twelve additional planes are activated. This intrinsic material behaviour results in the formation of chips with pronounced lamella structure on the upper side and a coherent film on the bottom side.

The first choice cutting material for magnesium is polycrystalline diamond, PCD, not because of wear, but rather because of the extremely long tool life attainable and the accompanying consistent surface- and dimensional quality of the machined components. For complicated shaped tools like end mills, twist drills, taps or thread milling cutters fine grained cemented carbide grades, K10F-20F, are used. Dry cutting of magnesium is under development. Two main items are to be addressed, safety and thermal control of the processes [53].

### Composite Materials

The cutting of composite materials was given specific treatment in the CIRP keynote paper 2002 [54]. Cutting of composites differs in many respects from the cutting of conventional material and their alloys. In cutting composites, the material behaviour is not only non-homogenous, but it depends on the diverse properties of the reinforcement and matrix materials. The tool encounters continuously alternate matrix and reinforcement materials whose response to the cutting process can be entirely different. The fibre type, the reinforcement architecture and the matrix content are the most important factors governing tool selection and the cutting parameters that can be adopted. In the case of glass fibre reinforced plastics (GFRP) and carbon fibre reinforced plastics (CFRP), it is the cutting tool materials that dominate the tool selection. In the case of aramid fibre reinforced plastics it is the tool geometry that is the most significant factor in the choice of cutting tool. The hardness of the glass and more especially, of the carbon fibres results in a high rate of tool wear [54].

Fibre- and particle-reinforced aluminiums (Al-MMC, Aluminium-Metal Matrix Composite materials) play a special role due to the method of manufacture. It is possible in the case of numerous aluminium alloys to improve the material strength and thermal properties significantly by the introduction of ceramic particles (e.g. SiC or Al<sub>2</sub>O<sub>3</sub>-fibres) [55]. Technically these materials are characterised not as aluminium alloys but rather as aluminium based composite materials. In this regard, it is the method in which the reinforcement is introduced, the respective material type and the form that have the greatest influence on the machinability. In addition to the mixing of reinforcement material with the aluminium alloy, there exists the possibility to produce these composite materials using a powder metal approach. The result is a considerable difference in the machinability of these materials that is dependent on the hardness and the distribution of the reinforcement in the material matrix [56].

Due to the intensity of the two main wear mechanisms, wear and adhesion (Figure 1722), diamond based cutting materials are the only economical cutting alternatives for the machining of these materials. Tool wear resulting from chemical or tribological mechanisms is relatively low in this case. The reason for this is the low temperatures generated in the machining process (melt-temperature of AlSi7Mg

$v = 557...613$  °C) [57]. Similarly in the case of machining high content silicon alloys, CVD diamond coated tools present a potentially high tool life due to the missing binding phase.

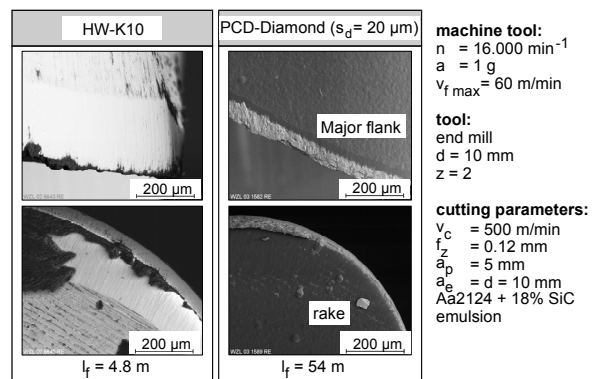

Figure 22: Tool wear in the end milling of particle reinforced wrought alloys [58].

### 3.5 Cutting of Aerospace Materials

For the classical turbine materials titanium and nickel alloys, the high performance cutting tool materials fine grained tungsten carbides, whisker reinforced ceramics, SiAlON, polycrystalline diamond (PCD) and polycrystalline cubic boron nitride allow an enormous increase in the material removal rates and in productivity [59]. Figure 23 shows the range of materials in modern turbine manufacture. The titanium-aluminides and the titanium metal matrix composites place new demands on the cutting processes. The cutting of these materials is difficult due to the low thermal conductivity, the brittle nature of the material and the high chemical affinity to all known cutting tool materials [60]. Drilling tests using HSS have exhibited rapid blunting of the cutting edges resulting in extremely low cutting distances to reach tool life (in the millimetre range). Using tungsten carbide drills (ISO HW-K10/K20) optimal cutting distances to reach the tool life could be obtained with a feed of  $f = 0.033$  mm and a cutting speed of  $v_c = 7 - 10$  m/min. With increasing drill diameter the cutting distance diminishes when using the same cutting parameters. Material removal rates in the range  $0.3 \text{ cm}^3/\text{min}$  for a drill diameter of 3 mm and  $2 \text{ cm}^3/\text{min}$  for a drill of 20 mm diameter can be achieved [61].

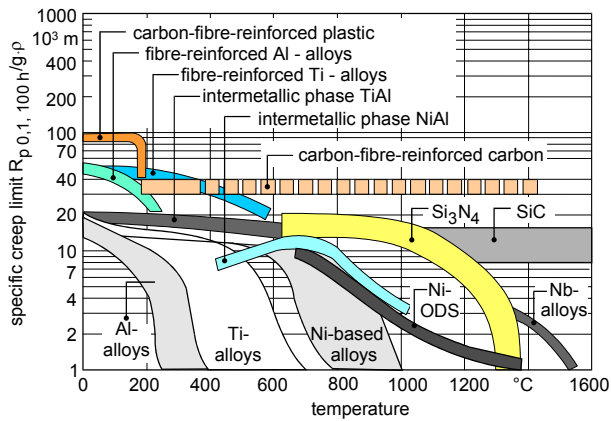

Figure 23: Materials for turbine manufacture [source: MTU].

For the case of turning, fine grain tungsten carbides or uncoated conventional KW-K10 or HW-K20 tungsten carbides are used. Depending on the workpiece material properties, the cutting speeds and feeds lie in the range  $V_c < 50$  m/min and  $f = 0.12$  mm. To date, ceramic, PCD and CBN tool materials do not represent an economic alternative to the tungsten carbides [62].

One of the significant features of the titanium-aluminide materials is their brittle behaviour. For this reason not only the issues of suitable tool materials and cutting conditions arise, but also surface condition after machining is of central importance. The TiAl machined surface produced by turning exhibits micro-cracks and particle break-away which occur normal to the feed-mark direction. These defects deteriorate with increasing tool wear. The surface defects arise due to the degree of brittleness of the material, which possesses very low or virtually no resistance to plastic deformation. Micro-particle breakaway at the machined surface can be accounted for through the fracture and disengagement of the surface crystals or the intermetallic phases. Similar phenomenon occur in the high speed milling of these materials. The machining of titanium-aluminides thus presents a dual challenge. On the one hand the poor tool life and the low permissible cutting speeds and on the other hand the inadequate quality of the machined surface present new challenges for high performance cutting.

### 3.6 Burr Formation in Cutting

Burr formation affects workpiece accuracy and quality in several ways; dimensional distortion on part edge, challenges to assembly and handling caused by burrs in sensitive locations on the workpiece and damage done to the work subsurface from the deformation associated with burr formation. A typical burr formed on a metal component due to the exit of a cutting edge is seen in Figure 24 [63].

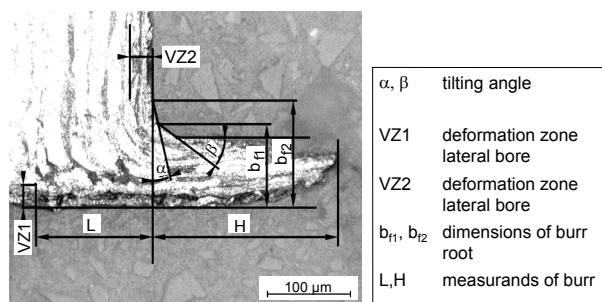

Figure 24: Typical burr and proposed measuring nomenclature [63].

A number of things are clear from this image – there is substantial subsurface damage and deformation associated with a burr, the shape is quite complex and, hence, the description of a burr can be quite complex, and presence of a burr can cause problems in manufacturing. In fact, this burr shown in the cross-section in Figure 24 gives the appearance of a rather simple phenomenon. The range of burrs found in machining practice is quite wide, especially when the full range of processes from drilling to grinding is considered. To emphasize the point, Figure 25 shows typical drilling burrs and their classification in stainless steel as an indication of the potential variation [64]. Burrs in milling and turning exhibit wide variation as well.

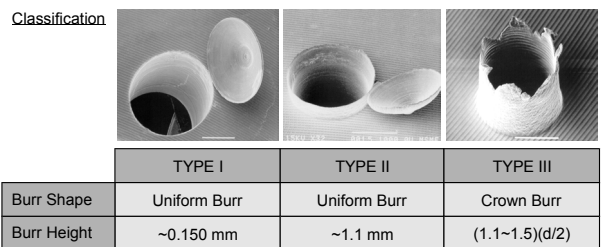

Figure 25: Three typical burrs in drilling stainless steel [64].

The cost associated with removing these burrs is substantial. The typical costs as a percentage of manufacturing cost varies up to 30% for high precision components such as aircraft engines, etc. In automotive components, the total amount of deburring cost for a part of medium complexity is approximately 14% of manufacturing expenses [65].

To minimise or prevent burr formation requires that all stages of manufacturing from the design of the component through process planning and production be integrated so that the potential part features and material constraints, tooling and process sequences and process variables be considered from a perspective of the potential for creation of burrs on the workpiece. That is, the inputs (process, material, tools, workpiece geometry, fixturing, etc.) must be considered along with the part functionality (part performance, fit and assembly requirements) as well as any expected or required deburring processes. This is most successful when clear standards and classifications are available, edge tolerances can be specified and the relationship between the edge quality and part functionality is clearly understood. This is not generally the case.

The future development in this regard is seen to depend on the following:

- the development of predictive models with competent databases, including “expert data bases” for process specification
- simulation models of burr formation capable of indicating the interaction and dependencies of key process parameters (finite element models, for example)
- strategies for burr reduction linked to computer aided design (CAD) systems for product design and process planning
- inspection strategies for burr detection and characterisation including specialised burr sensors.

One could also add here the development of specialised tooling for deburring although that is an area well covered commercially today.

There are substantial differences between burr formation in drilling and milling for example. In drilling, infeed can play an important role in the development of drilling burrs [66]. In addition, the drill geometry can affect the size and

shape of the burr formed as well as prevent burr formation in some cases. Analytical models are increasingly supplemented with finite element method (FEM) models of the drilling process to predict effects of drill geometry, process parameters and workpiece characteristics on size and shape of the burr [67]. Applications to aerospace component manufacturing, in particular multi-layer structures, is a primary area of focus for FEM drilling process modelling. This is also applicable to milling but less so to date due to the complexity of the milling process.

Since milling (especially face milling) features so prominently in the manufacture of so many parts, for example, automotive engines and transmission components, it has been a major focus for burr reduction and prevention for many years. In milling, the kinematics of tool exits from the workpiece are a dominant factor in burr formation and as a result substantial success has been realised by adjusting the tool path over the workpiece. The principal criteria in tool path determination have been:

- avoiding exits of inserts (or always machining on to the part edge)
- sequencing of process steps to create any burrs on a last, less significant edge
- control of exit order sequence (EOS) by tool geometry and path variation
- maintaining uniform tool chip loads over critical features
- lift and re-contact of milling cutter for some features where manoeuvrability is limited
- avoiding "push exits" (those with long cutter path/edge contact lengths).

While these criteria are often difficult to apply in all situations they have shown dramatic reductions in burr formation with the corresponding increases in tool life (tools are often changed when burr size reaches a specification limit) and reductions in deburring costs. In all circumstances cycle time constraints must be met with any re-designed tool paths.

#### 4 CUTTING FLUIDS AND DRY OR NEAR DRY CUTTING

When considering environmental issues in cutting, one of the most fundamental concerns is the use of cutting fluids. Cutting fluids have a direct influence on the environment and in recent times are being questioned in the light of ecological and economic manufacture. Expertise in relation to cutting fluids is currently divided amongst the disciplines: chemistry, process technology, manufacturing technology, environmental conservation, medicine and tribology. Losses of cutting fluids from the manufacturing system occur through vapourisation, loss with chips and workpiece as they leave the machine tool, loss with machine components such as handling/manipulation devices, as well as through vacuum and air pressure systems and through droplet formation and ensuing leakage. Leakage of fluid is a critical factor contributing both to loss and in some cases has a negative influence on the hydraulic systems of the machine tool. Wet and dirty workpieces, chips and particles leave the machine tool and enter the cleaning and drying system. Taking into account that up to 30% of the annual total cutting fluid consumption can be lost through removal from the system by the above means, it becomes clear that effective methods to combat such losses are being continually sought. The following points have to be observed in consideration of the question of cutting fluids for environmentally clean manufacturing:

- The constituents of the cutting fluid must not have negative effects on the health of the production worker or on the environment.
- During their use cutting fluids should not produce contaminants nor have negative effects on machine tool components or seals.
- The zone of cutting should not be flooded but rather cooling and lubrication should take place in a defined manner thereby minimising the volume of fluid necessary, for example internal supply to within the tooling and specifically designed nozzles for external supply.
- Continuous monitoring of the cutting fluid and the machine tool environment with online sensors is desirable.
- Through separate care and maintenance of cutting fluids, the total amount of oil and water required for emulsion can be reduced leading to cost savings.

The problem of cutting fluid disposal in manufacturing is one of the most important aspects in relation to environmental protection and one objective of research work is the improvement of the life of the cutting fluid by the fluid manufacturers and by high quality maintenance and monitoring. Surveys carried out in the German Automotive industry show that workpiece related manufacturing costs incurred with the deployment of cutting fluids range from 7–17%. As compared with this, the tooling costs can account for approximately 2 to 4% [68]. The wide range within which cutting fluid costs fall is due to the varying boundary conditions. The level of workpiece related cutting fluid costs depends to a large extent on the manufacturing operation, the component, required part quality, cutting fluid drag, and vapourisation, the lubricating medium involved, the type of machine, the size of the facility, the situation regarding the building, cutting fluid processing and disposal and other factors [68].

The introduction of dry cutting requires suitable measures to compensate for the primary functions of the fluid. This requires a thorough understanding of the complex interrelationships which link the process, tool, part and machine tool. The CIRP Keynote Paper in 1997 addressed the issue of dry cutting of cast iron, steel, aluminium and even superalloys and titanium [68]. In some cases it is not possible to achieve dry cutting e.g. where there is strong adhesion between the cutting tool and the chip underside, where the tool wear is excessive under dry conditions or where the thermal deformation of the workpiece cannot be controlled. Tight dimensional and form tolerances may present a significant restriction for dry machining and call for special countermeasures. Examples where dry cutting is applied include turning, milling and drilling ( $l/D < 3$ ) of cast and steel materials. Tools for dry machining must incorporate specially designed features relating to the substrate, the coating and the geometry. Low friction in the tool-workpiece contact zone and a high thermal resistance are required [9]. A dry cutting process must be designed to minimise the amount of heat flowing into the workpiece. This may be achieved by minimising the cutting forces and also by influencing the heat distribution. Cutting forces can be reduced by positive cutting edge geometries, while heat distribution towards the workpiece may be positively influenced by increasing the cutting speed [68]. The introduction of dry machining necessitates measures to compensate for the primary functions of the fluid, cooling, lubricating and chip transport. Table 1 shows a summary of the situation in relation to the use of dry cutting and Minimum Quantity Lubrication (MQL) for a range of materials aluminium, steel and cast iron. In some cases, as for example in the milling and drilling of aluminium, very small quantities of fluid may be applied. Those processes in which the friction and adhesion play a domi-

nant role generally require the usage of minimal quantities of fluid. Examples here include thread cutting and forming, fine drilling, and drilling of steels with I/D ratios > 3. Although somewhat misleading the term Minimum Quantity Lubrication (MQL) is commonly used. MQL was applied in the American aerospace industry with a view to cutting difficult materials in the 1970's.

material	aluminium		steel		cast iron
	cast alloys	wrought alloys	High alloyed steels bearing steels	Free cutting steels quench and tempering steels	GG20-GGG70
processes					
drilling	MQL	MQL	MQL	dry/MQL	dry/MQL
reaming	MQL	MQL	MQL	MQL	MQL
tapping	MQL	MQL	MQL	MQL	MQL
treat forming	MQL	MQL	MQL	MQL	MQL
deep hole drilling	MQL	MQL		MQL	MQL
milling	MQL/dry	MQL	dry	dry	dry
turning	MQL/dry	MQL/dry	dry	dry	dry
gear milling			dry	dry	dry
sawing	MQL	MQL	MQL	MQL	MQL
broaching			MQL	MQL/dry	dry

Table 1: Dry Cutting and MQL [69].

MQL or Near Dry Machining (NDM) is defined as the dispensing of cutting fluids at optimal (generally very low) flow rates, tiny quantities of cutting fluid are sprayed to the cutting zone directly [68]. Papers relating to MQL and NDM are limited and have appeared in technical literature only recently.

For manufacturing organisations that perform machining or cutting operations, cutting fluids represent an issue of growing interest owing to environmental, health, economic and safety concerns. These fluids include such chemical constituents as hydrocarbons, sulphur, phosphorus, chlorine, surfactants/emulsifiers, and biocides. The handling of used cutting fluids presents a number of environmental issues. Fluid splashing, spillage, and improper disposal can contaminate lakes, rivers, and groundwater sources. Pre-treatment and treatment of cutting fluids serves to reduce the environmentally damaging influence of the fluid, but does not completely eliminate the potential hazard. In addition to the environmental concerns associated with cutting fluids, several studies have shown that humans exposed to cutting fluids through dermal and inhalation pathways often develop health problems [70]. Motivated by health problems related to cutting fluid mist inhalation, several recent research efforts have focused on investigating the mechanisms associated with cutting fluid mist formation [71]. A final potential hazard associated with cutting fluid mist is safety-related; mist with a high oil concentration can be flammable. Finally, it should be noted that significant expenses associated with the purchase, maintenance, treatment, mist handling, recirculation, and disposal of cutting fluids represent yet additional motivation for manufacturing industry to carefully examine cutting fluid usage decisions.

Dry machining eliminates the environmental problems associated with cutting fluids. While there remains potential health hazards (dermal irritation and inhalation) and flammability issues from machining dust, these are far less of a worry than for fluid mist. While switching from wet machining to dry machining may provide environmental, health, safety, and generally cost benefits, there are concerns about other process performance measures. MQL represents an intermediate alternative between copious fluid application and dry machining. It attenuates many of the negative aspects associated with flood application and is still able to provide some of the process benefits not available with dry machining. MQL offers the following advantages: decreased use of metal working fluids, reduced costs as compared to flood applications, reduced

industrial hygiene hazard, opportunity to employ more benign fluids (e.g., vegetable oils) and improved process performance as compared to dry machining. Widespread use of MQL is still inhibited by concerns related to unknown costs, chip flushing problems, potential flammability issues associated with airborne metal dust, and system reliability/repeatability.

#### 4.1 Drilling and Milling under Dry or Near Dry Conditions

Drilling is a critical operation: chip evacuation, chip adhesion to the drill, and drill wear are major issues tied to cutting fluid application. Some efforts have been reported associated with MQL applications in drilling. [72] reported that MQL (0.000167 litres/min of mineral oil in a flow of 4.5 bar of compressed air) could be used successfully in the drilling process of aluminum-silicon alloys (SAE 323) where dry cutting is especially difficult. The holes produced with an external MQL system presented either similar or better quality than those obtained with a water soluble oil flood application. The flank wear was also similar for the two fluid applications.

Tests carried out on the evaluation of MQL milling concluded that in end milling, 30-40% longer tool life and 20-30% lower resultant force could be obtained with MQL (external system with straight oil, 0.00183 litres/min) compared to flood application (6.44 litres/min). Rahman et al. [73] conducted an end-milling test with an external MQL system (with BP CILORA 128 cutting oil, 0.000142 litres/min). Cutting force components, surface finish, burr height, burr length and tool wear were all better compared to those obtained by flood application (42 litres/min) or dry cutting.

Brinksmeier [74] conducted experiments on the machining of a range of advanced materials, e.g. titanium alloys and extreme low sulphur steels under MQL conditions. The focus was on cutting tool performance and wear mechanisms at high cutting speeds. MQL was shown to be successful from the perspectives of tool life, surface finish and avoidance of tensile residual stresses.

#### 4.2 Turning under Dry or Near Dry Conditions

Um et al. [75] used a water spray (sprayed at the flow rate of 0.067 litres/min with the air pressure at 560 kPa) in turning 416 stainless-steel cylindrical bar stock and concluded that spray cooling (and resulting phase change from liquid to vapour) lowers the temperature at the tool/chip interface and results in smoother surface finish, better chip breakability, and longer tool-life compared to dry cutting. Machado et al. [76] carried out tests on turning medium carbon steel (AISI 1040) using very low flow rate (0.0033 litres/min for the soluble oil and 0.0049 litres/min for water) of cutting fluid mixed with compressed air (2 bar). The results revealed that surface finish, chip thickness, and force variation are all affected beneficially with a low fluid volume compared to a copious fluid application of 5.2 litres/min. Wakabayshi et al. [77] applied an oil-air supply lubrication unit (normally used to lubricate a high-speed bearing) to a turning operation. Air containing an extremely low concentration (0.00001-0.00016 litres/min) of cutting oil was discharged on the rake and flank faces of a turning tool at a pressure of 0.6 MPa. Results showed that the proposed supply system provides better lubrication between the chip and the tool, and better cooling compared to dry cutting. The MQL system provided comparable performance in terms of tool wear, surface finish, and built-up edge formation to a flood application.

## 5 MACHINE TOOL AND CUTTING PROCESS DEVELOPMENTS

Production is facing the need for higher productivity, flexibility and quality due to the on-going progress of customisation and global competitive markets. Over the last decade, new manufacturing strategies like high speed and high performance cutting, hard and dry machining, process-integration, complete machining and new tool materials influenced machine tool developments, or have been made possible by it [78]. In consequence, productive as well as non-productive times could be drastically reduced. Key machine tool innovations are:

- powerful high frequency work spindles
- innovative drive systems
- roller or ball type linear guideways
- light weight materials and constructions
- innovative kinematic concepts
- sensors and actuators providing process stability

In addition, multiple manufacturing technologies have been integrated into machine tools to avoid time consuming and inaccurate handling and transportation of work-pieces. Complete manufacturing strategies have been introduced into industry. As a result, handling systems could be eliminated, which reduces system costs and required floorspace and maximises flexibility of facilities. Finally, minimisation of pollution and power consumption is a challenge for the future.

### 5.1 Machine Tool Performance

Manufacturing speeds together with minimised secondary times, process stability and machining quality continuously increase production efficiency [79]. Major innovation steps result from higher dynamics achieved with linear direct drives. For example, world production of machining centers reached appr. 25.000 units in 2000. About 1.100 of them applied linear motors. Compared to 1999 (320) an increase of 250% can be noticed [80, 81]. Overall, in 2001 over 3.000 machine tool axes were equipped with linear direct drives [82]. Besides high dynamics, the success of direct drives is based on a higher stiffness due to the absence of mechanical force transmission [83].

However, linear motors have not been able to totally replace conventional techniques. Modern ball screw drives with improved performance (up to 120 m/min and 1.4 g) are still dominant [84, 85]. Fast direct driven machines show feed rates of 120 m/min, vectorial accelerations of 3.2 g and chip-to-chip times of 2.4 sec. On the other hand, 90 m/min, 1.2 g per axis and 1.8 sec chip-to-chip time can be achieved with ball screws.

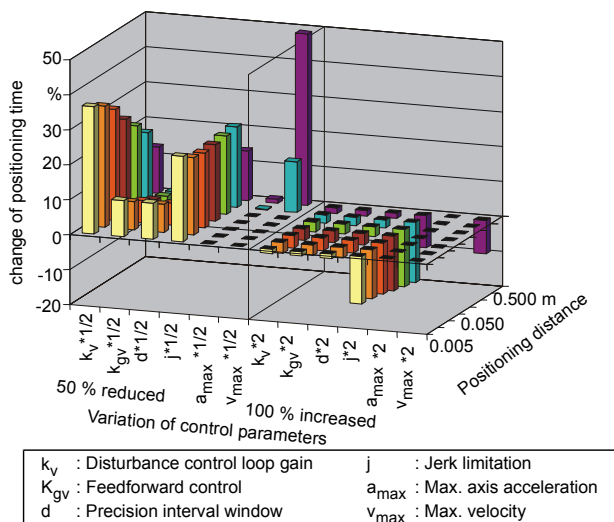

Figure 26: Positioning time of a machining center.

Drive dynamics are not the only limiting factor regarding machining performance. Taking the required accuracy and surface quality into account, process stability is most important. Therefore, the structural dynamic stiffness of the machine tool mainly influences the machining results. To avoid unduly excitation of the machine structure due to high speed movements of parts and components, the allowed jerk – the derivative of the acceleration – is restricted by the machine controls [86]. Consequently, the control parameters are also limiting positioning speeds and process times [87]. In Figure 26 the dependency between positioning times and the dynamic control parameters are shown. The left hand side shows the effect of a reduction of control parameters whereas the right hand side shows an increased parameter set. Especially at small positioning distances it can be seen, that besides the jerk, the gain value ( $k_v$ ) is a limiting factor. This parameter also depends on the structural stiffness of the machine tool. Serious research and development work has been carried out, to achieve light but stiff machines and components [88, 89, 90, 91].

Modern drive systems and controls are able to monitor process forces and vibrations without additional sensors. Information can be gathered directly from the motor current [92].

A new approach combines direct drive technology with non-contact magnetic guideways. Beside highest dynamics, the absence of friction forces allows adaptronic applications of drive and bearing system. Today, the compliance of linear magnetic guides reaches about 0.06  $\mu\text{m}/\text{N}$  (Figure 27) [93].

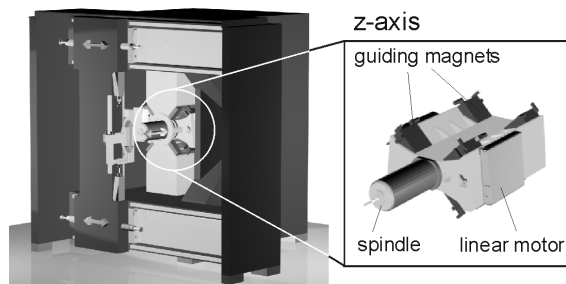

Figure 27: Machine tool with direct drives and magnetic guided z-axis.

Current accuracy demands are met by using direct measuring systems for linear or rotary axes. Furthermore, strategies for compensation of additional machining errors

are investigated. Newest approaches to counteract tool deflection and chatter are based on adaptive actuators [30]. Offline methods include prediction of process forces with the aim of optimised process design [94].

In the future, machine tool developers are expected to not mainly concentrate on maximum speeds and acceleration of machine axes, but to concentrate on other non-productive time aspects, like set-up time of machines. Very likely, work will also be done in the area of machine accuracy and flexibility. In the latter case not only of the machine but in most cases of complete systems including part, tool and information handling.

## 5.2 Process Integration and Complete Machining

The following process strategies have innovated the classical process chains with sequential and dedicated machine applications in one clamping or at least in one machine, often called complete machining :

- Integration of various machining processes into one machine tool (e.g. turning, milling, drilling, grinding, deburring).
- Six side machining.

In addition, process designs have been further optimised regarding productivity by introducing:

- Parallel processing: 2 or more processes are utilised independently on a single machine (e.g. 4 axes turning).
- Hybrid processes: 2 or more processes are coupled to achieve a specific workpiece alteration, also called assisted machining (e.g. laser aided turning).
- Integrated processes: New processes based on 2 or more conventional processes (e.g. grind hardening).

All these approaches have one main goal: To reduce non-value adding processing times due to transportation and part handling. Furthermore, inventory can be reduced because the number of unfinished parts within the process chain is widely eliminated. Usually, this goes along with an elimination of re-clamping operations which has positive effects on the part accuracy [95].

Examples: The problem of high centrifugal forces on part chucking systems due to high cutting speeds used to restrict the application of HSC in turning. Nowadays these forces can be reduced by turn-milling. Besides lower processing times, surface finish can be expected to be about 10 times higher than that of pure turning [96, 97] . One additional tool spindle has to be integrated into the turning machine. Technologies that have been realised with mill-turn centers are listed in Figure 28.

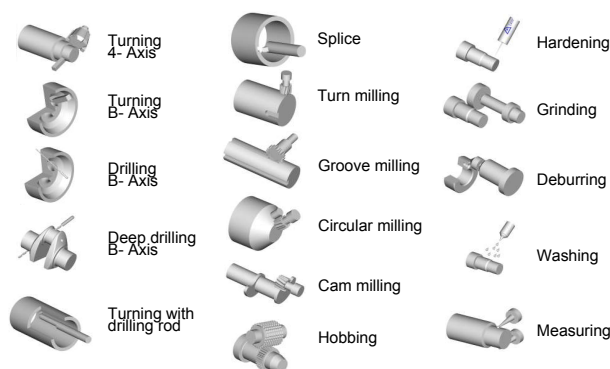

Figure 28: Technologies integrated into mill-turn-centers.

Modern mill-turn-centers do not only provide powerful driven tools but complete high speed tool spindle heads mounted on X/Y/Z-axis units with 240°-B-axis. 100 or more tools are supplied by fast automatic tool changers.

With counter workpiece spindle, for 6-side machining is possible with rapid speeds of up to 75 m/s [98]. Siegwart [99] describes a manufacturing solution in which eight separate conventional machines were replaced by a single mill-turn-center. The integration of multiple cutting technologies in combination with in-situ part measurement not only allowed more efficient and accurate machining, but also shortened the overall process chain by eliminating certain processes. This is due to the reduced number of clampings, in the described case from eight to two, combined with accurate workpiece measurement which enabled the required dimensional tolerances to be achieved using geometrically defined cutting instead of grinding.

Vertical turning centers with pick-up-spindle have been introduced more than 10 years ago. Their advantage is the use of machine axes for part loading and unloading. Costly peripheral equipment, like robots or gantry loaders are eliminated. This machine class has also been extended as multiple process machining centers, see Figure 29. Such integration enables further reduction of the required floorspace and logistics expenditure for given process chains. Feinauer et al. [100] quote an example in which hard turning, measuring and grinding of HSK tool holders are carried out in a stand alone vertical turning center. The resulting primary processing time was reduced by 50-70% depending on the workpiece geometry. Furthermore, other complete machining solutions show process savings in the order of 30%. In [101] a flexible manufacturing center with pick-up technique is introduced, which contains two tool holding fixtures for hard machining, a high speed spindle for internal grinding and another motor spindle for external grinding. Especially in hard turning, pick-up systems show advantages regarding the system stiffness [102, 103, 104]. Some vertical turning centers also allow six side machining [105].

Hybrid machine tool examples are quoted in [106]: Combined end milling (roughing) and laser machining (finishing);

- Incorporation of a laser on a grinding machine for wheel conditioning;
- Integration of creep feed grinding on a high speed machining centre.

Examples of hybrid (assisted) machining processes include:

- Plasma/laser assisted turning;
- Ultrasonic assisted turning and milling.

Due to its modular and flexible nature, the laser is a popular candidate for integration into machine tools. Laser systems can be configured to carry out fine cutting, drilling, welding and surface treatment processes. Surface treatment includes case-hardening, surface melting and coating (cladding). Müller [107] quotes an example in which a laser integrated solution was transferred for the manufacture of magnetic bushings. The integrated turning centre carried out a turning operation followed by a laser welding operation. The pick-up spindle also enabled the assembly of the machined and welded part with its mating component.

Furthermore, the laser can be utilised to assist the machining of difficult to machine materials. Work carried out by Weck and Hermanns [108] concentrated on the laser assisted machining of materials such as Si<sub>3</sub>N<sub>4</sub> (silicon nitride) ceramics, Inconel Nickel superalloys, Titanium alloys and high-strength steel using both CO<sub>2</sub> and Nd:YAG laser integrated turning centers.

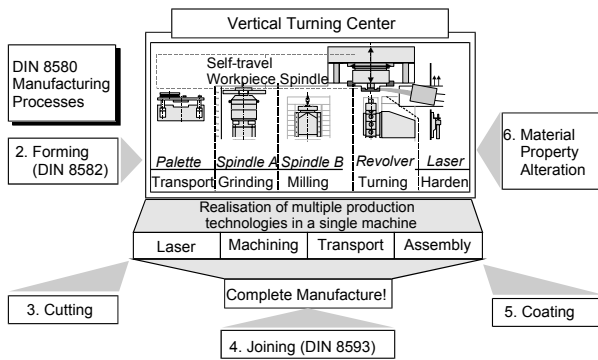

Figure 29: Integration of multiple processing technologies into vertical turning centers.

In addition to productivity, there is a growing demand on high and ultra precision machines. These machines have to provide exceptional static, dynamic and thermal stability. Active approaches to compensate static and thermal deformations have already been investigated [109]. With piezo based devices workpieces and tools can be aligned according to measured deviations. Piezo actuators can also be used to perform active damping in lathes, milling and grinding machines. First approaches with adaptive algorithms show good damping abilities for chatter vibrations. Altintas et al. presented a piezo actuator based fast tool servo, which is used to achieve tool positioning resolutions of  $\pm 10$  nm. High surface finish qualities were obtained for hard turning of AISI 4340 and AISI 4320 steels [110]. A tool holder with integrated piezo actuator in combination with predictive algorithms is presented in [111]. A reduction of machined surface roughness  $R_a$  by 50 % was achieved.

Future trends in the area of cutting processes will be determined by two main manufacturing trends: First of all, other traditional manufacturing processes, like casting or forming, will be able to produce higher accuracies and therefore, the overall amount of cutting will be reduced. New technologies, like laser sintering, or the substitution of metal by polymeric parts, will support this trend. It is expected that the remaining metal cutting will mainly concentrate on the generation of precision and ultra-precision surfaces, whereas the overall manufacturing process chain as well as the part characteristics will be designed using extensive simulation tools. Secondly, the ongoing trend for mass-customisation will accelerate the need for highly flexible cutting processes and manufacturing equipment. New, more efficient methods for machine set-up and programming, change-over, clamping and transportation, etc. will be needed.

### 5.3 Parallel and Hybrid Kinematic Machines

Parallel (PKM) and hybrid (HKM) kinematic machine tools have been intensively investigated over the last decade. Only a few of them have found so far their way into industrial applications yet. The development goal was to optimise cutting conditions, productivity and system costs with these new machine structures. Higher stiffness due to the elimination of bending moments to the structure and thus reduced masses and excellent resulting dynamics were quoted to be the main advantages of this new machine class [112].

An example for a 3 axes parallel kinematic turning machine which is established on the market is introduced in [113] (see Figure 30). The machine combines the advantages of a light and stiff parallel kinematic structure with a pick-up-spindle. Small parts (chuck size up to 130 mm) are picked up from a conveyor inside the workspace. Accelerations up to  $8 \text{ m/s}^2$  and velocities up to  $50 \text{ m/min}$  lead to minimised workpiece changing times of 7 s. The structure shows no eigenfrequencies with a phase twist

beneath  $-90^\circ$  in x- and y- direction below 600 Hz and thus no chatter addition. Turning results of a ball geometry by interpolation in bronze alloy show shape accuracies of  $\pm 3 \mu\text{m}$ .

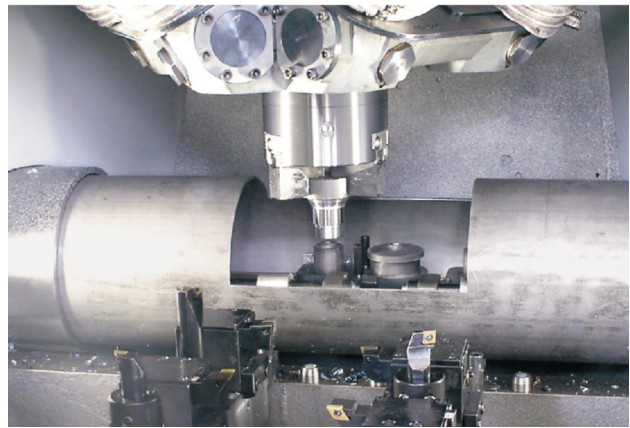

Figure 30: Parallel kinematic pick-up machine.

Pure parallel kinematics, like Hexapod or Tripod structures have been supplemented with hybrid kinematics, the combination of parallel and serial kinematics. Despite a great number of machines and prototypes being introduced on machine tool shows, the principal design methodology is still a research topic regarding workspace, stiffness or maximum load [114, 115, 116].

The coupled structure of PKMs and hybrid kinematics, non-linear system behavior and the need for highest positioning accuracies require adapted control systems and strategies. New dynamic modeling approaches were presented during the last years. A dynamic model approach for PKMs which leads to a model that is linear with respect to a minimal parameter set is introduced in [117]. The feedforward control gives the perspective of large reductions of tracking errors as rigid-body dynamics strongly influence the whole system behavior [117].

Parallel and hybrid kinematic machine tools have, except for very few examples, not yet found its way into manufacturing plants. Problems, i.e. with accuracy, have been underestimated. It is expected that these problems will be solved in the near future and that new concepts will come up based on latest scientific results. This class of machine will find its place within the manufacturing landscape, but not generally replace conventional serial machine tools.

### 5.4 Health and Safety

The request for safe cutting processes and equipment with low environmental pollution has an overall impact on the design of machine tools and cutting processes.

A system that supports the latest European Safety Standards regarding protection of operators is presented in [118]. It uses an integrated FEM calculation to determine the impact strength of safeguard components. The calculation simulates standardised test conditions to reduce time and cost intensive experimental effort for safety measures. The state of the art in safety integration in machine tools is given in [119]. The use of software agents for planning of cutting processes for CNC machining can minimise their environmental impact [120].

Due to the increasing application of dry machining demands on safety and hygiene devices have been adapted. Especially in dry grinding large amounts of dust is produced as chips and grinding particles cannot be bounded and transported by cooling lubricants. An emission analysis based on the rules of VDI 2066 and DIN 689 was carried out by comparing the dry grinding process without suction to grinding with point and chamber suction. The investigations revealed that only in grinding with suction



the registered emissions were uncritical for the environment [121]. An experimental comparison of air quality in wet and dry turning of cast iron shows that wet turning generates 12-80 times more cutting fluid mist compared to dust in dry turning [122].

High speed and high performance cutting on the other hand requires new precautions due to high kinetic energies of tools or parts. Safety glasses and armoured machine tool guarding are used to protect the worker from released parts in case of failures. An analysis of the impact of released parts during HSC-milling and turning to different protection devices is presented in [123]. The achieved results together with theoretical investigations led to construction rules for safe separating protection devices. Focussing on the fatigue of tool bodies during high speed milling processes, in [124] a calculation method for the fatigue life based on the nominal stress concept was developed.

Health and safety measures have always been determined by the progress being made in the area of cutting processes and production machinery and by the relevant environmental and safety regulations. It is expected that future work will have to concentrate also on energy consumption and on the specialised requirements of new hybrid or integrated processes.

## 6 CUTTING PERFORMANCE

The term "Cutting Performance" is used here in the context established by the High Performance Cutting working group in CIRP and a longstanding working group in Germany. The working group has focused on the optimisation of the machining of prismatic parts and includes the influences of the chain of production including upstream and downstream processes and their relationship. In that sense, then, cutting performance is an indication of the degree to which a set of production operations is optimised with respect to each single operation but also for the set of operations so that there is no negative influence of one operation on another. This is to be done with the objective of shortening value added chains (for example, merging operations) and with minimisation of measurement activities by ensuring process quality control.

A number of performance measures are commonly associated with cutting performance. These can be illustrated as shown in Figure 31, from [125] and, for the purposes of this discussion we can include burr formation and similar effects as included in part accuracy.

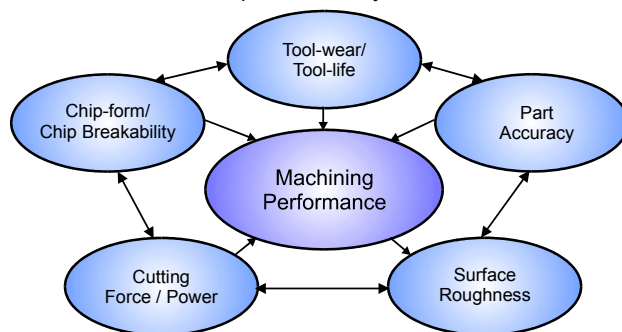

Figure 31: Representation of the factors influencing machining performance for turning [125].

### 6.1 Predictive performance

We generally use the terms modelling and simulation interchangeably in manufacturing research literature. In the case of cutting, there are many phenomenon that are not easily observed or not subject to direct experimentation so the models are developed (e.g. burr formation at the interface between two plates during drilling) so that the influence of a number of process parameters can be simu-

lated using this model. Common models used are based on Eulerian or Lagrangian finite element techniques. Four primary categories of methodologies for modelling of cutting are evident over the past several decades [126].

- analytical modelling (determining the relationship between the forces in cutting based on cutting geometry and including experimentally determined values of shear angle, friction conditions and chip flow angle; for example, Ernst and Merchant's early work, [127])
- slip-line modelling (predicts mechanical response and temperature distributions based on assumptions about slip line field geometry in the shear zone and around the tool; for example, Oxley's work, [128])
- mechanistic modelling (predicts cutting forces for a wide range of complex machining processes based on the assumption that cutting forces are the product of the uncut chip area and specific cutting energy where specific cutting energy is empirically derived from workpiece material, cutting parameters, and cutting geometry; for example the work of Tlustý, [129])
- finite element modelling (FEM techniques use small mesh representations of the material and tooling as the basis for determining material stress and strain conditions and, ultimately, flow of material based on assumptions of continuity between adjacent elements)

The application of these modelling techniques covers the range of cutting processes and interests including cutting forces (static and dynamic), power, tool wear and life, chip flow angle/curl/form, built up edge, temperatures, workpiece surface conditions and integrity, tool geometry, coating and design influences, burr formation, part distortion and accuracy, tool deflection, dynamic stability limits and thermal damage. Processes modelled range from orthogonal cutting to multi-tooth milling, hard-turning and drilling. The predominance of the work, as evidenced by research publications, is in turning (plane face tools), face milling, drilling (twist drills) and end milling and slotting [126].

A number of application areas are described here that have been motivated by increasing cutting performance where modelling has been shown to be effective (cutting hard materials, burr formation, chip formation, temperature and tool wear in cutting).

Cutting hard materials – the state of the art in cutting of hardened steel was presented in the 2000 keynote paper of STC "C" by Tönshoff [6]. In this review cutting and grinding were compared. Surprisingly, little modelling in the sense discussed here was reported in this very challenging application area for cutting. There has been a tremendous experimental effort to understand the fundamentals of hard cutting and successful implementations in practice. Understanding the mechanisms of chip formation combined with the thermo-mechanical influence of the work-tool zone is critical to controlling the generation of a machined surface by pure plastic deformation required in this application. Models describing elements of this are based on "mechanics of plasticity" analyses and, in particular, the work of Recht as early as 1964 [130] is cited as useful in describing segmentation of chips found in this type of cutting. Poulachon et al. [131] also relied on Recht's early work in their attempts to model flow stress in machining of hardened alloy steels. Guo and Liu use FEM analysis for analyzing the machinability of AISI 52100 steel [132, 133]. They report on the use of 3D turning simulations using a commercial finite element code to estimate cutting forces and chip geometry. The simulation is based on flow stress data extrapolated from tensile test data using a velocity modified temperature. The cutting

simulation includes realistic tool materials and a developed friction model to account for both sticking and sliding conditions. Chip flow, chip morphology, cutting forces, residual stresses, and cutting temperatures are predicted. Reasonable validation of chip morphology and forces is obtained.

**Burr formation** – Understanding the mechanics of burr formation has been greatly enhanced by modelling of the burr formation process analytically, mechanistically and with finite element techniques. Early work by Ko and Dornfeld [133] established a basic analytical model of exit roll over burr formation in orthogonal cutting. Although useful, analytical models are limited in their abilities to accommodate the important process variables associated with the tool geometry and exit conditions critical in burr formation. This is specially true in the case of drilling where drill geometry effects can substantially encourage or hinder burr formation.

In drill burr formation modelling there are two primary influences: tool geometry, and feedrate. Realistic tool types (split point, for example) must be able to be included in the analysis which requires that their geometries be converted in to meshed shapes. Feedrate effects in drilling burr formation will determine whether the burr formed is of uniform shape (with or without a “cap”) or crown shape (generally undesirable due to excessive size and rough shape). Software for generating meshed drill structures for use in FEM analysis has been developed [134] and allows for variation in critical geometry parameters. This ability, combined with the work on drilling burr modelling, has allowed reasonable modelling of exit surface burr formation in drilling of ductile materials such as stainless steel. Burr formation is also affected by tool geometry and interfacial frictional conditions. The influence and accurate modelling of friction in cutting in general has been a long-standing challenge. Recent work on FEM analysis of the influence of tool coatings on burr formation was reported by Leopold [135]. The thermoconductivity differences of different coatings along with differences in coefficient of friction were seen to influence chip formation and cutting forces as well as burr formation. In this study element sizes less than 5 microns were used, Figure 32, yielding the better resolution required.

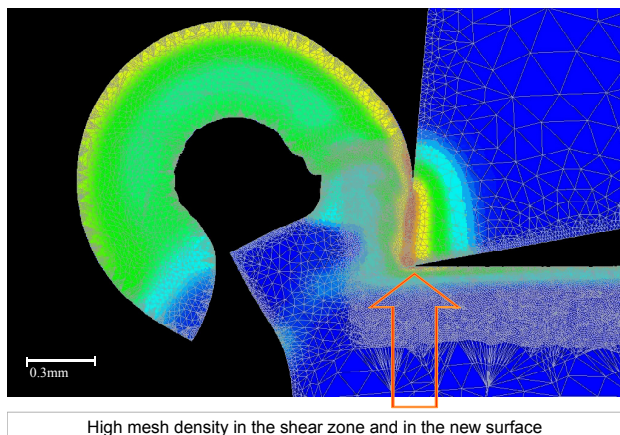

Figure 32: FEM simulation of burr formation in orthogonal cutting utilising different mesh densities [135].

**Chip formation** – Much attention has been paid to understanding the mechanisms of chip formation and the role of influential parameters. Traditionally, studies have relied on the collection of extensive sets of experimental data. The modelling of chip formation using any of the techniques outlined above has been challenging. However, much progress is being made and models, specially finite element, are having an impact on the ability to understand this complex aspect of cutting. Jawahir reported that sig-

nificant progress has been made in modelling chip at the 2D-level but that there has been very little success in “operation-based” modelling [136]. This is due to the wide variety of cutting tool geometries, coatings, and tool materials and the inadequacy of current modelling techniques for fully predictive models. A goal is to predict chip form and breakability for a given tool geometry/work material combination. An explicit dynamic thermo-mechanically coupled finite element modelling technique was evaluated for chip breakage simulation in 2-D [137]. Low and high speed compression test data for AISI 4130 material was used to characterise the workpiece and cutting force and chip thickness results were validated in orthogonal tube turning. A number of commercial chip breaker geometries were also evaluated. The increasing use of high speed machining has encouraged modelling of chip formation as well since the optimisation of cutting at high speeds (for example, up to 2000 m/min cutting speed) with exotic materials is not straightforward. As with lower speed cutting, the objectives are to understand the dependency of chip formation on parameters such as cutting forces, chip/tool/workpiece interface temperature, stress and strain distribution.

**Temperature and tool wear in cutting** – Beside burr formation, cutting forces and chip formation quality of the cutting process is determined by the tool wear behaviour and thermal load on the tool and workpiece [138, 139, 140].

#### *Molecular dynamics-based simulation*

A newer class of modelling of cutting, at the nanometer level, is referred to as molecular dynamics modelling and is distinguished from the other techniques discussed above. Suited best for simulating processes with chip sizes and surface features well below those capable of simulation with more “traditional” techniques as classical mechanics and finite element methods, molecular dynamics was first applied to ultraprecision in the early 90’s. Molecular dynamics theory is well based in physics and is comprised of descriptions of the interactions between atoms at the atomic level instead of the electronic level thus allowing atomic level simulation of behavior of materials [141]. To improve the correlation of experimental results with theoretical prediction, empirical elements have been added from material science. Time dependent processes such as surface generation and roughness development in cutting can be studied at this atomic level. Since this offers insight into the subsurface region of the work surface, effects such as dislocation formation and stress relief can be simulated and observed in both two and three dimensional machining configurations, Figure 33. The figure illustrates the nano-machining of copper with specific crystallographic orientation in both 2D and 3D. Evidence of burr formation at the grain boundary due to dislocation movement and plastic deformation with accompanying storage of atoms at the boundary and pile-up on the surface (burr) can be clearly seen. Experiments in cutting at nanometric levels, for example by Lucca [142] on Ge, suggest that there are means to validate molecular dynamics experiments with physical setups. With the increase in micromachining to create molds and other features for a variety of components, it is interesting to see the “scale-ability” of larger scale phenomena to the nano-scale and, thus, the ability to control the quality of these components.

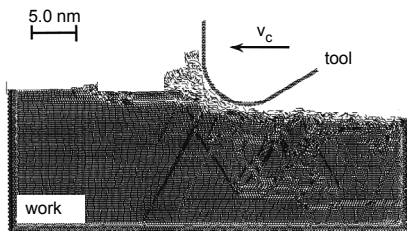

Calculation:	System parameter	Tool/work	Work	Cutting parameter:
total time	4.4 ns	diamond (Cu)	copper	speed
time steps	2 200 000	$\sigma$ min	2.05 Å	2.56 Å
cut length	22.0 nm	time step/cut-off	2.0 fs	1.87 $\sigma$
		atoms	400	12.000
				depth
				2.0 nm
				edge radius
				5.0 nm
				wedge
				60°

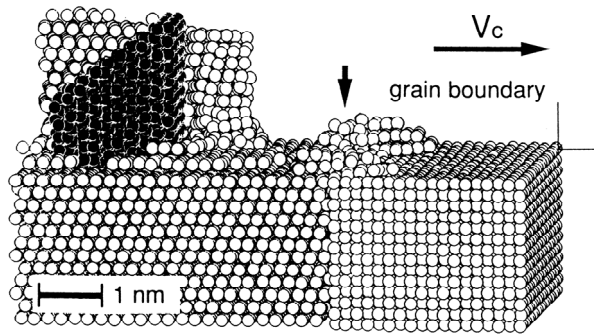

Figure 33: 2D and 3D molecular dynamics simulation of burr and chip formation in copper [141].

#### New Directions in Improving Process Understanding

The improvement in modelling capability from macro to nano scale processes consistently encourages developments in process simulation and increased process understanding. This improvement is expected to be dependent upon the following developments:

- transition from 2D to true 3D capability for “real” processes
- increased ease of changing tooling parameters (geometry, coatings/friction, material properties, mechanical characteristics (stiffness, etc.))
- improved material properties for model inputs
- accommodation of multiple materials/layers
- increased complexity of workpiece shapes and features
- resolution at level of micro or nano-scale variables (grains, inclusions, etc.)
- capability of simulating more realistic process elements (chips, burr, residual stresses, part distortion/form errors, etc.)

The real challenges to the effective utilisation of process models to improve cutting performance include (i.) how to integrate with CAD systems for product and process design functions, (ii.) model validation (NIST data base development, <http://nist.gov/amm>, is an important step), (iii.) enhanced set of material property data, and (iv.) enhanced user interface (ease of implementation).

Application areas that are expected to offer the greatest potential for cutting performance enhancement are: hard turning, dry machining, high speed cutting, burr formation and minimisation, chip formation and control, and overall process simulation from the point of view of reduced non-productive time.

## 6.2 Monitoring of cutting operations

The complex interactions between machines, tools, workpieces, fluids, measurement systems, material handling systems, humans and the environment in cutting operations requires that sensors be employed to insure efficient

production, protect investment, indicate needs for maintenance, and protect workers and the environment. Inasaki and Tönshoff outline the trends and roles of monitoring systems in [143].

Early developments have proven, that process monitoring is essential for economic production. Most significant for availability and quality are tool wear and tool breakage. An excellent overview of monitoring of machining for tool condition monitoring (until now a principal concern in cutting) can be found in [144]. Standard approaches on process monitoring are the measurement or identification of the interaction between process and machine structure. Particularly the vibrational behavior plays an important role, since it significantly affects the workpiece accuracy as shown by simulation and experiment e.g. in [145].

An indication of the evolution of monitoring systems in manufacturing was presented by Tönshoff [146]. An updated table from [146] illustrating this evolution is shown in Figure 34 and indicates the stage of development or implementation of the application area.

Frankly, there has not been much advancement from the state outlined by Tönshoff. But now there are additional requirements for increased flexibility. Specifically, sensor systems must be able to be interfaced with open system architecture controllers for machines and systems must be designed to accommodate needs of so called “reconfigurable” systems. Activity in both of these areas is still predominately in the research stage with few industrial applications.

To achieve the “intelligent machine tool,” which has as its objective to be able to maintain an optimised cutting performance, requires sensor along with control systems with the knowledge accumulation capability to store the acquired “experience” for use in future production.

	Basic research	Industrial implementation
workpiece monitoring	██████████	██████████
tool condition monitoring	██████████	██████████
process diagnosis	██████████	██████████
process monitoring	██████████	██████████
machine monitoring		██████████
open system	██████████	██████████
reconfigurable systems	██████████	

Figure 34: Monitoring systems evolution in manufacturing (updated) [146].

Further, given the development of reconfigurable systems, monitoring strategies must be flexible enough to accommodate different machine configurations and processes. This would be logically tied in with machine control hardware and software in an “open” environment. In that sense, this would be an example of the “intelligent sensor”.

Recent developments aim at different directions. Some are based on new fields of production, other use new sensor concepts. Most process monitoring systems are designed for processes of limited complexity like drilling, thread cutting or straight pass milling. Whereas solutions for sculptured surface milling, especially ball end finishing operations, are still not available on the market. These have a great significance in die and mould finishing with only small process forces. New approaches use special sensors to measure force [147, 148] or accelerations [149] for process monitoring in milling of sculptured surfaces.

The standard fixed threshold method has been adapted to be more universal. Dynamic boundaries combined with neural networks are presented in [150]. Neural networks have proven to be effective for small size productions. Especially flank wear of tools in milling can be monitored with neural networks [151].

It seems to be an obvious solution to use dynamic systems for the supervision of a dynamic process like a cutting process. Probably due to stability problems, the output of pure dynamic networks is limited. A promising approach is a model in which a static and a dynamic networks are combined hierarchically as a "state space representation" of the cutting process. A recent development has been mapped on tool condition monitoring for hard turning [152].

Another approach is the usage of a disturbance observer for reconstruction of process forces [153].

The field of high speed cutting (HSC) introduces new dynamic effects to the process monitoring. In [154] an approach applying time series analysis is introduced. The standard analysis methods dominated by the Fast Fourier Transformation (FFT) are extended by Wavelet Transforms [148, 155] and Cepstrum Analysis, the later proven to be especially sufficient for machine and process monitoring.

### 6.3 Integrated sensors

Considering the range of sensors and applications in the cutting process, the machine tool requires a large number of sensors [156]. Integrated sensor systems can today accomplish several tasks and cooperate to insure process optimisation. Cutting performance overall requires reduction in process and non-productive times, verification and maintenance of process capability, while reducing direct production costs and ensuring environmentally-friendly production.

Inasaki discussed the concepts of *replicated* sensor systems and *disparate* sensor systems referring to similar sensors integrated to provide greater reliability and different types of sensors integrated to provide flexibility in sensor system application, respectively [157]. Perhaps the best review of some of the individual sensing systems, application potential and limitations as well as identification, decision making and fusion methodologies can be found in [144, 158].

### 6.4 Integrated workpiece quality evaluation

Finally, we look at the ability to integrate evaluation of the workpiece quality into cutting performance. This remains an illusive goal due to many challenges. The first challenge is defining workpiece quality quantitatively over the range of processes and parts manufactured (for example, subsurface damage in machining, or surface roughness). Second, measuring or somehow assessing the quality elements of the workpiece as part of the production environment (for example, surface roughness that is dependent on so many independent variables in the process such as tool condition). Finally, it is not clear how to incorporate this information in some way into the machine and process control scheme.

If we refer again to Figure 34 reviewing the state of the art of monitoring systems in manufacturing, the closest system relating to workpiece quality evaluation is the "workpiece monitoring" bar which, as can be seen in the figure, is hardly seen in practice in industry. But, this important piece is needed for much of the advancements in cutting performance reviewed above (open architecture adaptive control and reconfigurable systems, for example). This is one area where modelling is not easily applied. The challenge is integration of independent, reliable and capable sub-systems with the goal of assessing the product quality. Unfortunately, most of the needed pieces are far from

practical and, to a great extent, research on this topic has not yet become popular. Modelling techniques such as molecular dynamics modelling offer some good potential.

## 7 CONCLUSIONS AND OUTLOOK

This paper demonstrates that cutting technology has made remarkable progress in the last 50 years since the foundation of CIRP. The thrust towards the application of higher performance workpiece and cutting tool materials, towards usage of minimal quantities of cutting fluid, to higher precision and to the application of micro-systems will continue. The technological capabilities of our cutting systems will continue to develop and higher performance with enhanced safety standards and environmental cleanliness and lower manufacturing costs will result.

This review shows that up to now we have been primarily involved in the cutting of metallic and polymeric materials for engineering applications and that work in the field of the life sciences has received little attention from the cutting technology perspective. Workpiece materials for the telecommunications sector has likewise received little attention by the research community dealing with cutting tools of defined macro-geometry. In setting out a roadmap for cutting technology the newer biological and microelectronic materials need incorporation.

Clearly an essential element of the roadmap for cutting technology is the integration of manufacturing processes. In the past, simple process elements have been optimised. Progress will be made by focussing on technology interfaces and on the complete process chain. Our manufacturing systems for cutting technology will be hybrid in nature and will encompass modularity features for ease of reconfigurability and for minimisation of non-productive times. Reconfigurable manufacturing systems, when implemented with open architecture control systems for basic machine tool control as well as adaptive control of machining performance can offer substantial improvements in cutting performance by assuring economic flexible systems responsive to changing demands and shorter product cycles. Disparate sensor systems as part of open architecture control will contribute to the development of "intelligent" machining systems with learning ability. Substantial research work is needed to integrate methods of assessment of part quality with operating machining systems.

Specific cutting process and process effects will benefit from continued modelling research including cutting hard materials, burr formation, and chip formation. Molecular dynamics modelling offers potential for coupling micro and nano scale process features with macro scale processes. The improvement in modelling capability from macro to nano scale processes drives improved process simulation and process understanding.

## 8 REFERENCES

- [1] Fifty Years of CIRP: "Its Origins, Its Objectives, Its Achievements", 51<sup>st</sup> CIRP General Assembly, Nancy, France, August 2001
- [2] Les Annales du College International Pour L'Etude Scientifique des Techniques de Production Mechanique (CIRP), Volume 1, 1952, Lausanne, Suisse, Microtechnic Edition Scriptor S.A.
- [3] Taniguchi, N., 1983, Current Status in and Future Trends of Ultraprecision Machining and Ultrafine Materials Processing, Annals of the CIRP, 32/2:573 - 582

- [4] Corbett, J., McKeown, P.A., Peggs, G.N., Whatmore, R., 2000, Nanotechnology: International Developments and Emerging Products, *Annals of the CIRP*, 49/2: 523-545
- [5] Byrne, G.; Ahearne, E., 2002/3, First, Second and Third International CIRP Workshops on High Performance Cutting, Paris, January 2002, San Sebastian, August 2002 and Paris, January 2003 coordinated by CIRP Scientific Technical Committee "Cutting".
- [6] Tönshoff, H. K., Arendt, C., Ben Amor, R., 2000, Cutting of Hardened Steel, *Annals of the CIRP*, 49/2:547-566.
- [7] Weinert, K., 2002, Second International CIRP Workshop on High Performance Cutting, San Sebastian, August 2002 coordinated by the CIRP Scientific Technical Committee "Cutting".
- [8] Van Luttervelt, C.A., Childs, T.H.C., Jawahir, I.S., Klocke, F., Venuvinod, P.K., 1998, Present Situation and Future Trends in Modelling of Machining Operations – Progress Report of the CIRP Working Group "Modelling of Machining Operations", *Annals of the CIRP*, 47/2:587–626.
- [9] Mohlfeld, A., 2000, Trockenbohren mit PVD-beschichteten Hartmetallwerkzeugen. Dr.-Ing. Dissertation, Universität Hannover
- [10] Friemuth, T., 2002, Herstellung spanender Werkzeuge, Habilitationsschrift, Universität Hannover
- [11] Dreyer, K., Westphal, H., Sottke, V., Tabersky, R., 1999, New Developments for Hardmetals, Cermets and Coatings in Experiment and Practice, VDI-Seminar "High Performance Processes in Cutting Operations", Oct. 26.-27., Dortmund
- [12] Ettmayer, P., Kolaska, H., Lengauer, W., Dreyer, K., 1995, Ti(C,N) cermets – Metallurgy and properties, *International Journal of Refractory Metals and Hard Materials*, 13/6:343-351
- [13] Porat, R., Ber, A., 1990, New approach of cutting tool materials - Cermets, *Annals of the CIRP*, 39/1
- [14] Cassel, C., 1994, Einsatzverhalten von Cermet-Schneidstoffen bei der Drehbearbeitung, Dr.-Ing. Dissertation, Universität Hannover
- [15] Gerschwiler, K., 1998, Untersuchungen zum Verschleißverhalten von Cermets beim Drehen und Fräsen, Dr.-Ing. Dissertation, Universität Aachen
- [16] Tönshoff, H.K., Wobker, H.-G., Cassel, C., 1994, Wear Characteristics of Cermet Cutting Tools, *Annals of the CIRP*, 43/1:89-92
- [17] Whitney, E.D., 1994, Ceramic cutting tools - materials, development and performance, Noyes Publications, Park Ridge, New Jersey, U.S.A.
- [18] N.N., 2003, Praxis-Report No. 17: "SL 800 / SL 550 C: A new generation of uncoated and coated silicon nitride ceramics", CeramTec AG, Plochingen
- [19] Narula, C.K., 1995, Ceramic Precursor Technology and its Applications, Marcel Dekker Inc., New York, Basel, Hong Kong
- [20] Tönshoff, H.K., Wobker, H.-G., Brunner, G., 1995, CBN grinding with small wheels, *Annals of the CIRP*, 44/1:311-316
- [21] Brücher, M., 2003, CVD-Diamant als Schneidstoff, Dr.-Ing. Dissertation, Universität Berlin
- [22] Denkena, B., Tönshoff, H. K., Spengler, C., 2002, Schleifen von Hartmetall-Werkzeugen, *Diamond Business*, 2:62-65
- [23] Weinert, K., Thamke, D., 1998, Wirtschaftlichkeit der Trockenbearbeitung, *Werkstattstechnik - wt*, Band 88, 9/10:392-396
- [24] Tönshoff, H.K., Denkena, B., Friemuth, T., Spengler, Chr., 2002, Influence of different grinding processes on coating adhesion on cutting tools, 3rd International Conference "THE coatings", Nov. 28.-29., Thessaloniki, Greece
- [25] Van den Berg, H., Westphal, H., Tabersky, R., Sottke, V., König, U., 2002, Development and Applications of New Composite and Multilayer Composite Coatings, Euro PM02 Conference, Oct. 7-9, Lausanne
- [26] Bouzakis, K.-D., Michailidis, N., Skordaris, G., Kombogiannis, S., Hadjiyiannis, S., Efsthathiou, K., Erkens, G., Rambadt, S., Wirth, I., 2002, Effect of the Cutting Edge Radius and its Manufacturing Procedure on the Milling Performance of PVD Coated Cemented Carbide Inserts, *Annals of the CIRP*, 51/1:61-64
- [27] Leyendecker, T., 1985, Neuartige Schneidwerkstoffbeschichtungen auf Titan- und Aluminiumbasis, Dr.-Ing. Dissertation, RWTH Aachen
- [28] Grzesik, W., 2001, An Investigation of the Thermal Effects in Orthogonal Cutting Associated with Multilayer Coatings, *Annals of the CIRP*, 50/1:53-56
- [29] Denkena, B., Tönshoff, H.K., Friemuth, T., Gey, C., Podolsky, C., Frank, M., 2002, Safe Machining of Magnesium with CVD-DP and Smooth CVD-DP Coated Tools, Society of Manufacturing Engineers SME, Technical Paper FC02-264
- [30] Renevier, N.M., Oosterling, H., König, U., Dautzenberg, H., Kim, B.J., Geppert, L., Koopmans, F.G.M., Leopold, J., 2003, Performance and limitation of hybrid PECVD (hard coating) - PVD magnetron sputtering (MoS<sub>2</sub>/Ti composite) coated inserts tested for dry high speed milling of steel and grey cast iron, *Surface and Coatings Technology* 163-164: 659-667
- [31] Fox-Rabinovich, G.S., Kovalev, A.I., Wainstein, D.L., Shuster, L.Sh., Dosbaeva, G.K., 2002, Improvement of duplex PVD coatings for HSS cutting tools by PFPE (perfluoropolyether Z-DOL), *Surface and Coatings Technology*, 160:99-107
- [32] Denkena, B., Friemuth, T., Fedorenko, S., Groppe, M., 2002, An der Schneide wird das Geld verdient. *Werkzeugtechnik+Verfahren*: 30/12:24-26
- [33] Lung, D., in: Weck, M., 1993, Konstruktion von Spindel-Lager-Systemen für die Hochgeschwindigkeits-Materialbearbeitung
- [34] Schulz, H., et al., 1981, 20 Jahre HSC, Sonderheft Werkstatt und Betrieb
- [35] Brandt, D., 1995, Randzonenbeeinflussung beim Hartdrehen, Dr.-Ing. Dissertation, Universität Hannover
- [36] Koch, K.-F., 1996, Technologie des Hochpräzisions-Hartdrehens, Dr.-Ing. Dissertation, Fakultät für Maschinenwesen der RWTH Aachen
- [37] Schmidt J., 1999, Mechanische und thermische Wirkung beim Drehen gehärteter Stähle, Dr.-Ing. Dissertation, Universität Hannover
- [38] Wobker H.-G., 1997, Hartbearbeitung, Habilitationsschrift, Universität Hannover
- [39] Komanduri, R., Brown, R. H., 1981, On the Mechanics of Chip Segmentation in Machining, *Journal of Engineering for Industry, Trans. ASME* 103:33-51

- [40] Röttger K., 2003, Hartwalzen hartgedrehter Oberflächen, Dr.-Ing. Dissertation, RWTH Aachen, Shaker Verlag, Aachen
- [41] König, W., 1965, Über den Einfluss nichtmetallischer Einschlüsse auf die Zerspanbarkeit von unlegierten Baustählen, Habilitation, Technische Hochschule Aachen
- [42] Jiang, L., Hänninen, H., 1994, Machinability of steel, A Review, Helsinki University of Technology, Laboratory of Engineering Materials
- [43] Zinkann, V., 1999, Der Spanbildungsvorgang als Acoustic-Emission-Quelle, Dr.-Ing. Dissertation, RWTH Aachen, Shaker Verlag, Aachen
- [44] Dreßler, H. W., 1964, Einflußgrößen auf die Zerspanbarkeit von Automatenstahl, Dr.-Ing. Dissertation, RWTH Aachen
- [45] Bernsmann, G., Bleyemehl, M., Hassler, A., Ehl, R., 2001, The making of free cutting steels with additions of lead, bismuth, tellurium, selenium and tin, Stahl und Eisen, 121/2:87-91
- [46] Klocke, F., Klöpffer, C., 2002, Machinability characteristics of Austempered Ductile Iron (ADI). World Conference on ADI, Louisville, Kentucky, USA, Sep 26-27. Hrsg. American Foundry Society, Des Plaines, Illinois, USA, 2002, pp. 73 – 82
- [47] Klocke, F., 2002, Perspektiven der Zerspantechnik – Entwicklung und Integration der Fertigungsprozesse von morgen. Conference 29<sup>th</sup> – 30<sup>th</sup> October 2002, Aachen Germany
- [48] Reuter, U., 2002, Verschleißmechanismen bei der Bearbeitung von Gusseisen mit PCBN-Schneidstoffen, Dr.-Ing. Dissertation Universität Darmstadt
- [49] Pape, L.-P., 1995, Untersuchungen zur Optimierung des Aluminiumkreislaufs, Dr.-Ing. Dissertation, Technische Universität Berlin.
- [50] Eisenblaetter, G., 2000, Trockenbearbeitung mit Vollhartmetallwerkzeugen, WZL-RWTH Aachen. Berichte aus der Produktionstechnik, Band 5/2000, Shaker Verlag, Aachen.
- [51] Brinksmeier, E., Sölter, J., Walter, A., 2003, Machinability of Aluminium Alloys under High Speed Cutting Conditions, 4<sup>th</sup> International Conference on Metal Cutting and High Speed Machining, March, Darmstadt, Germany
- [52] Bolstad, J. A., 2000, Alloy development for intelligent magnesium designs, Proc. 1<sup>st</sup> Int. Magnesium Conference, 14<sup>th</sup> April, Brescia, Italy
- [53] Marpert, M., 2000, Sicherheitsaspekte bei der spanenden Bearbeitung von Magnesium, Magnesium Taschenbuch, Aluminium-Verlag Düsseldorf: 605-615.
- [54] Teti, R., 2002, Machining of Composite Materials, Annals of the CIRP 51/2:611–634.
- [55] Biermann, D., 1995, Untersuchungen zum Drehen von Aluminiummatrixwerkstoffen, Dr.-Ing. Dissertation, Universität Dortmund
- [56] Weinert, K., Kempmann, C., Lange, M., 2002, Bearbeitung von Werkstoffverbunden und Verbundwerkstoffen, Tagungsband, Seminar, Perspektiven der Zerspantechnik – Entwicklung und Integration der Fertigungsprozesse von morgen, Aachen
- [57] Jörgensen, G., 2000, Methoden zur Haffestigkeitsprüfung diamantbeschichteter Hartmetall-Wendeschneidplatten, Dr.-Ing. Dissertation, Technische Universität Braunschweig
- [58] Klocke F., Grams, J., 2003, Unpublished project results, WZL, RWTH Aachen
- [59] Klocke, F., Gerschwiler, K., 2002, Drehen und Fräsen von Nickelbasislegierungen, Perspektiven der Zerspantechnik, Lehrstuhl für Technologie der Fertigungsverfahren, WZL der RWTH Aachen
- [60] Sharman, A.R.C., Aspinwall, D.K., Dewes, R.C., Bowen, P., 2001, Workpiece surface integrity considerations when finish turning gamma titanium aluminide, Wear, 249, 5/6:473-481
- [61] Aust, E., Niemann, H.-R., 1999, Machining of  $\gamma$ -TiAl. Advanced Engineering Materials, 1: 53-57.
- [62] Uhlmann, E.; Schauerte, O. S.; Brücher, M.; Herter, S., 2001.: Tool wear during turning of titanium aluminide intermetallics. Production Engineering, 8/2:13-16
- [63] Beier H., 2002, Burr Reduction Investment - Production Costs – Prediction of Burrs, Presentation at HBC Workshop, CIRP, Paris
- [64] Kim, J., Dornfeld, D., 2001, Cost Estimation of Drilling Operation by a Drilling Burr Control Chart and Bayesian Statistics, SME J. Manufacturing Systems, 20/2: 89-97
- [65] Hockauf, W., 2002, Burr Reduction Investment – Production Costs - Burr Reduction – Prediction of Burrs, Presentation at HPC Workshop, 23 Jan., CIRP Paris
- [66] Gillespie, L., 1975, Burrs Produced by Drilling, Bendix Corporation, Unclassified Topical Report, BDx-613-1248
- [67] Min, S., Dornfeld, D., Kim, J., Shyu, B., 2001, Finite element modelling of burr formation in metal cutting, Proc. 4<sup>th</sup> CIRP Int'l Workshop on Modelling of Machining Operations, Aug., Delft: 97-104.
- [68] Klocke, F., Eisenblaetter, G., 1997, Dry Cutting, Annals of the CIRP-Manufacturing Technology, 46/2:519-526
- [69] Klocke, F., Gerschwiler, K., 2003, VDI Arbeitskreis Produktionstechnik (ADB) Stuttgart, Seminar: Trockenbearbeitung von Metallen, Minimalmengenschmierung – Ökonomische Aspekte der Trockenbearbeitung, WIV Weiterbildungszentrum Stuttgart
- [70] Hands, D.M., Sheehan J., Wong B., Lick, H. B., 1996, Comparison of Metalworking Fluid Mist Exposures from Machining with Different Levels of Machine Enclosure, American Industrial Hygiene Association Journal, 57/12:173-1178
- [71] Gunter, K.L., Sutherland, J.W., 1999, An Experimental Investigation into The Effect of Process Conditions on the Mass Concentration of Cutting Fluid Mist in Turning, Journal of Cleaner Production, 7/5:341-350
- [72] Braga, D.U., Diniz, A.E., Miranda, G.W.A., Coppini, N.L., 2002, Using a Minimum Quantity of Lubricant (MQL) and a Diamond Coated Tool in The Drilling of Aluminium-silicon Alloys, Journal of Materials Pro-cessing Technology, 122/1:127-138.
- [73] Rahman, M., Kumar, A.S., Salam, M.U., 2002, Experimental Evaluation on the Effect of Minimal Quantities of Lubricant in Milling, International Journal of Machine Tools and Manufacture, 42/5:539-547.
- [74] Brinksmeier, E., Walter, A., Janssen R., Diersen P., 1999, Aspects of Cooling Lubrication Reduction in Machining Advanced Materials, Proceedings of the Institution of Mechanical Engineers, 2/3 Part B:769-778

- [75] Um, J.Y., Chow, L.C., Jawahir, I.S., 1995, Experimental Investigation of the Application of the Spray Cooling Method in Stainless Steel Machining, American Society of Mechanical Engineers, Manufacturing Engineering Division, MED, Manufacturing Science and Engineering, 2/1:165-178
- [76] Machado, A.R., Wallbank, J., 1997, The Effect of Extremely Low Lubricant Volumes in Machining, Wear, 210:76-82.
- [77] Wakabayashi, T., Sato, H., Inasaki, I., 1998, Turning Using Extremely Small Amount of Cutting Fluids, JSME, International Journal, Series C, 41/1:143-148
- [78] Weck, M., et al., 2002, Werkzeugmaschinen für die Produktion von morgen im Spannungsfeld, Proceedings of the Aachener Werkzeugmaschinen Kolloquium 2002, pp. 373-409
- [79] Die Deutsche Werkzeugmaschinenindustrie im Jahr 2001. VDW, Frankfurt/Main, Januar 2002.
- [80] Eberlein, W., Schleider, U., 2001, Linearantriebe senken Kosten, WB Werkstatt und Betrieb, 134/1\2:68-71.
- [81] NN, 2002, Bearbeitungszentren mit Linearmotoren. Marktübersicht. Fertigung, Landsberg, 30/8:20-21.
- [82] Firmenbroschüre Motion Control. Siemens, Erlangen-Nürnberg, Mai 2002, Nr.2.
- [83] Abele, E., Bork, B., 2001, Vorteile beim Einsatz von Linearmotormaschinen im Werkzeug- und Formenbau, Konferenz-Einzelbericht: 3D-Erfahrungsform Werkzeug- und Formbau, Begleitband, 1-2 März, Darmstadt, pp.315-332
- [84] Pritschow, G., 1998, A Comparison of Linear and Conventional Electromechanical Drives, Annals of the CIRP 47/2.
- [85] Weule, H., Dambacher, U., Mussa, S., 2001, Neue Gewindegeometrie für den Kugelgewindtrieb. Einfluss hoher Lastwinkel auf die Belastung von Kugelgewindtrieben, Werkstattstechnik, Vol. 91/8, pp. 519-522.
- [86] Tönshoff, H. K., et. al., 1999, Fräsen ohne Tempolimit, wt Werkstattstechnik 89, 7/8:365-368.
- [87] Heller, Berndt, 2003, Zerspanung – Potenziale noch lange nicht ausgereizt. 4<sup>th</sup> International Conference on Metal Cutting and High Speed Machining
- [88] Heisel, U., Ziegler, F., 2000, Sheet metal lightweight design for direct driven machine tools, Production Engineering. Research and Development, 7/1:73-76.
- [89] Suh, J-D, Lee, D-G, 2002, Composite machine tool structure for high speed milling machines, Annals of the CIRP 51/1:285-288.
- [90] Tönshoff, H.K., Lapp, C., Grendel, H., 2001, Produktivitätssteigerung von Werkzeugmaschinen, Zeitschrift für wirtschaftlichen Fabrikbetrieb, 96/9:481-486.
- [91] Weck, M., Börner, U., 2001, Hochdynamische Drehmaschine zur Unrundbearbeitung, Unrunde Bauteile schnell und flexibel fertigen, Zeitschrift für wirtschaftlichen Fabrikbetrieb, 98/9:451-452.
- [92] Lapp, C., 2002, Indirekte Erfassung und Regelung von Bearbeitungskräften an direkt getriebenen Vorschubeinheiten, Dissertation, Universität Hannover.
- [93] Ruskowski, M., Reicke, L., Popp, K., 2002, Enhanced Steady State Stiffness for a Magnetic Guide Using Smart Disturbance Compensation, Proceedings of the 6<sup>th</sup> International Conference on Motion and Vibration Control MOVIC'02, Saitama.
- [94] Pritschow, G.; Schweiker, A.; Selle, J.; Ströhle, H.; Tönshoff, H. K., 2000, Preventive Error Compensation Circuit for Multi-Axis Machining. Production Engineering [WGP-Annals], 7/2:31-34.
- [95] Grundler, E., 2002, Weg vom einfachen Drehteil – hin zur Komplettbearbeitung, VDI-Z Integrierte Produktion, 144/11-12:29-31.
- [96] Choudhury, S.-K., Mangrulkar, K.-S., 2000, Investigation of orthogonal turn-milling for the machining of rotationally symmetrical work pieces, Journal of Materials Processing Technology, 99/1-3:120-128.
- [97] Pogacnik, M., Kopac, J., 2000, Dynamic stabilization of the turn-milling process by parameter optimization, Proc. Of the Institution of Mechanical Engineers, Part B, 214/2:127-135.
- [98] Denkena, B., 2001, Komplettbearbeitung von 6 Seiten, WB Werkstatt und Betrieb, 134/9:50,52,54,57.
- [99] Siegwart, R., 2000, Komplettbearbeitung im Werkzeugbau, Werkstatt und Betrieb, pp. 42-46
- [100] Feinauer, A., Friedrich, W., Haferkorn, W., Hennes, N., Hork, M., Krell, M., Lilla, A., Paepenmüller, F., Stave, H., Walker, B., Weck, M., Winkler, H-H., 2002, Werkzeugmaschinen für die Produktion von morgen im Spannungsfeld: flexibel und einfach, schnell und genau, AWK Aachener Werkzeugmaschinen-Kolloquium, pp. 373-409
- [101] Weinert, K., Finke, M., Johlen, G., 2001, Flexible Hartbearbeitung von Futterteilen durch Hartdrehen und Schleifen, ZWF Zeitschrift für wirtschaftlichen Fabrikbetrieb, 96/9:463-467.
- [102] Denkena, B. 2001, Pfeilschnelle Vertikaldrehmaschine für die Zulieferindustrie. Maschine + Werkzeug 7/8:110-114
- [103] Beyer, R., 2001, Vertikale Pick-up-Drehmaschine: Maschinenkonzepte des Jahrzehnts. Mav, 3:46.
- [104] Hartdrehen und Schleifen: Konzepte im Vergleich. Produktion (2002), 7:12.
- [105] Marktübersicht: Vertikale Pick-up-Drehmaschinen. Mav (2002), Nr. 3, S. 46.
- [106] Aspinwall, D.K., Dewes, R.C. Burrows, J.M., Paul, M.A., 2001, Hybrid High Speed Machining(HSM): System Design and Experimental Results for Grinding/HSM and EDM/HSM, Annals of the CIRP, 50/1:145-148
- [107] Müller, M.G., 2000, Laserintegrierte Komplettbearbeitung – Laserintegration und lasergestützte Verfahren, Laser Magazin 4, pp. 20-21
- [108] Weck, M., Hermanns, C., 1993, Laserintegration in Werkzeugmaschinen, VDI-Z, 135/5:38-41
- [109] Mussa, S.; Kirchhoff, M., 2002, Teilprojekt Drehmaschine, ACCOMAT – Die Genauigkeitsgeregelte Maschine, 2:189-213.
- [110] Altintas, Y.; Woronko, A., 2002, A piezo tool actuator for precision turning of hardened shafts, Annals of the CIRP, 51/1:303-306.
- [111] Weck, M.; Hilbing, R., 1998, Active compensation of dynamic vibrations in precision machining, Production Engineering, 5/1:51-54.
- [112] Weck, M., Staimer, D. 2002, Parallelkinematic Machine Tools- Current State and Future Potentials, Annals of the CIRP, 51/2:671-683.
- [113] Walker, T., Haberkern, A., 2001, Anwendererfahrungen für Drehteile mit PKM V100, 1. Internationale Fachtagung über Parallelkinematische Werkzeugmaschinen, 21.-22.6.2001, Messe Stuttgart
- [114] <http://www.ifw.uni-hannover.de/robotool/>

- [115] Merlet J.-P., 2000, Parallel Robots. Kluwer Academic Publishers, Dordrecht, Netherlands.
- [116] Pritschow, G., Wurst, K.-H., 1997, Systematic Design of Hexapods and other Parallel Link Systems, *Annals of the CIRP*, 46/1:291-295.
- [117] Tönshoff, H.K.; Grendel, H.; Grotjahn, M., 2002, Modelling and Control of a Linear Direct Driven Hexapod, 3rd Chemnitz Parallel Kinematics Seminar, April 23-25, Verlag Wissenschaftliche Scripten, Zwickau, pp. 335-350.
- [118] Spur, G., Uhlmann, E., Ising, M., 1999, Computer.
- [119] Bernard, A., Hasan, R., 2002, Working situation model for safety integration during design phase, *Annals of the CIRP*, 51/1:119.
- [120] Krishnan, N., Sheng, P.S., 2000, Environmental versus conventional planning for machined components, *Annals of the CIRP*, 49/1:363.
- [121] Tönshoff, H.K., Karpuschewski, B., Glatzel, T., 1997, Particle emission and immission in dry grinding, *Annals of the CIRP*, 46/2:693.
- [122] Sutherland, J.W., Kulur, V.N., King, N.C., 2000, An Experimental Investigation of Air Quality in Wet and Dry Turning, *Annals of the CIRP*, 49/1:61.
- [123] Spur, G., Bold, J., 1997, Anforderungen an trendende Schutzeinrichtungen für die HSC.
- [124] Schulz, H., Würz, T., Huerkamp, W., Leopold, J., 1997, Safety concepts for tools for high.
- [125] Jawahir, I., 2002, Prediction of chip forms and breakability in turning operations, Presentation at HPC Workshop, CIRP, August 22, San Sebastian
- [126] Armarego, E., Arsecularatne, J., Mathew, P., Verezub, S., 2001, A CIRP survey on the available predictive performance models of machining operations – report on preliminary findings, Proc. 4<sup>th</sup> CIRP International Workshop on Modelling of Machining Operations, August 2001, Delft: 71-83
- [127] Ernst, H., Merchant, M., 1941, Chip formation, friction and high quality machined surfaces, *Surface Treatment of Metals*, 29:299
- [128] Palmer, W., Oxley, P., 1959, Mechanics of metal cutting, *Proc. Institute of Mechanical Engineers*, 173:623
- [129] Smith, S., Tlustý, J., 1988, Modelling and simulation of the milling process, ASME, Proceedings of the Winter Annual Meeting, PED- 33:17-26
- [130] Recht, R., 1964, Catastrophic thermoplastic shear, *Trans. ASME*, 86: 189-193
- [131] Poulachon, G., Moisan, A., Jawahir, I., 2001, On modelling the influence of thermo-mechanical behaviour in chip formation during hard turning of 100Cr6 bearing steel, *Annals of the CIRP*, 50/1:31-36
- [132] Guo, Y.B., Liu, C.R., 2002, 3D FEA Modeling of Hard Turning, *ASME J. Manufac. Sci. Eng.*, 124:189-199.
- [133] Ko, S., Dornfeld, D.A., 1991, A Study on Burr Formation Mechanism, *Trans. ASME, J. Eng. Mats. Tech.*, 113/1:75-87
- [134] Choi, J., 2003, Modelling of inter-layer gap formation in drilling of a multi-layer material, CODEF Annual Meeting, February 28<sup>th</sup>, University of California, Berkeley
- [135] Leopold, J., 2002, Burr formation influenced by tool coatings, Presentation at HPC Workshop, CIRP, January 23<sup>rd</sup>, Paris
- [136] Jawahir, I., 2002, Chip form mechanisms: experimental observations and predictive models for turning, Presentation at HPC Workshop, CIRP, January 23<sup>rd</sup>, Paris
- [137] Marusich, T., Brand, C., Thiele, J., 2002, A methodology for simulation of chip breakage in turning processes using an orthogonal finite element method, Proc. 5<sup>th</sup> CIRP International Workshop on Modelling of Machining Operations, May 20-21, West Lafayette, IN: 139-148
- [138] Klocke, F.; Raedt, H.W.; Hoppe, S., 2002, 2D-FEM Simulation of the orthogonal High Speed Cutting Process. *Machining Science and Technology*, 5/3:323-340
- [139] Yen, E.; Söhner, J.; Altan, T.; Weule, H., 2002, Estimation of tool wear in metal cutting with the finite element method. Proceedings of the 5th CIRP International Workshop on Modeling of Machining Operations, Purdue/USA, 20.-21.05.2002, pp. 149-160
- [140] Klocke, F.; Hoppe, S., 2001, FEM Modelling of the HSC Process and its Experimental Verification. , Proceedings of the 3rd International Conference on Metal Cutting and High Speed Machining, Metz 27.-29.06.2001, pp. 65-72
- [141] Rentsch, R., Inasaki, I., Brinskmeier, E., Preuß, W., Riemer, O., 1996, Influence of material characteristics on the micromachining process, *Materials Issues in Machining III and the Physics of Machining Processes III*, ed. D. Stephenson and R. Stevenson, TMMS: 65-86
- [142] Lucca, D., Chou, P., Hocken, R., 1998, Effect of tool edge geometry on the nanometric cutting of Ge, *Annals of the CIRP*, 47/1:475-478
- [143] Tönshoff, H., Inasaki, I., 2001, Sensors in Manufacturing, Wiley-VCH: 4-5
- [144] Byrne, G., Dornfeld, D., Inasaki, I., König, W., Teti, R., 1995, Tool Condition Monitoring (TCM) - The Status of Research and Industrial Application, *Annals of the CIRP*, 44/2:541-567
- [145] Heisel, U., Feinauer, A., 1999, Dynamic influence on workpiece quality in high speed milling, *Annals of the CIRP*, 48/1:321-324
- [146] Tönshoff, H., Wobker, H., Hartmann, P., Kilsmark, P., 1995, The future of monitoring, Überwachung von Zerspan- und Umformprozessen, Proc. of CIRP/VDI Conference, March 1995, Düsseldorf: 347-360
- [147] Klocke, F., Reuber, M., 2000, Process monitoring in sculptured surface milling, *Production Engineering, Research and Development*, 7/1:1-4
- [148] Reuber, M., 2000, Prozessüberwachung beim Schlichtfräsen von Freiformflächen, Dr.-Ing. Dissertation, RWTH Aachen, Shaker Verlag, Aachen
- [149] Klocke, F., Kratz H.H., 2001, Process monitoring in mould and die milling with accelerometer signals, *Production Engineering, Research and Development*, 8/2:45-48
- [150] Rehse, M., 1999, Flexible Prozessüberwachung bei der Bohr- und Fräsbearbeitung in einer autonomen Produktionszelle, Berichte aus der Produktionstechnik, Dr.-Ing. Dissertation, RWTH Aachen, Shaker Verlag, Aachen
- [151] Uhlmann, E., Fries, E., 1999, Intelligent process monitoring, *Production Engineering, Research and Development*, 6/2:25-28



- [152] Scheffer, C., Kratz, H. , Heyns, P.S., Klocke, F., 2003, Development of a Tool Wear Monitoring System for Hard Turning, Int. J. Machine Tools & Manufacture, (accepted for publishing)
- [153] Pritschow, G., Bretschneider, J., Fritz, S., 1999, Reconstruction of process forces within digital servodrives systems, Production Engineering, Research and Development, 6/1:73-78
- [154] Weinert, K., Mehnen, J., Kalveram, M., Schwefel, H.-P., Naujoks, B., 1999, On the analysis of the dynamics of high-speed milling by means of time series analysis methods, Production Engineering, Research and Development, 6/2:21-24
- [155] Kasashima, N. et al., 1994, Diagnosing cutting tool conditions in milling using wavelet transform, JSPE Publ. Series, 1:339-344
- [156] Karpuschewski, B., 2001, Sensoren zur Prozeßüberwachung beim Spanen, Fortschritt-Berichte VDI
- [157] Sakura, M., Inasaki, I., 1993, Intelligent data base for grinding operations, Annals of the CIRP, 42/1:379-382
- [158] Moriwaki, T., 2001, Sensors in Mechanical Manufacturing – Requirements, Demands, Boundary Conditions, Signal Processing, Communications Techniques and Man-Machine Interfaces, Sensors in Manufacturing, eds. Tönshoff, H.K., Inasaki, I., Wiley-VCH: 24-45