

Advanced Integrated Systems Tools Development and Performance Testing
Final Deliverable

Submitted by

**Fred Bauman, Tom Webster, David Lehrer, Edward Arens, Hui Zhang,
John Goins, Darryl Dickerhoff, Stefano Schiavon, Sabine Hoffmann, Tiefeng Yu,
David Fannon, Mark Perepelitza, and Krystyna Zelenay**
Center for the Built Environment
University of California
Berkeley, California 94720-1829

Submitted to

UC Office of the President/CIEE
Basic Ordering Agreement
Contract Number: 500-99-013
Work Authorization Number: BOA-99-225-P

February 16, 2011

Project overview

The purpose of this project is to create tools and information sources that encourage the adoption of improved techniques and technologies for the planning, design, and operation of buildings. The tools will be applied to selected buildings with advanced integrated systems to assess energy and indoor environmental quality (IEQ) performance.

Background

The State of California is calling for radical improvements in building energy efficiency. The goals will *not* be met without an integrated approach involving new designs, new technologies, new ways of operating buildings, new tools for design, commissioning and monitoring, and new understanding of what comprises a comfortable and productive indoor environment. Many of these new developments are being worked on at the Center for the Built Environment and elsewhere, but the pace is not adequate to support the great changes rightfully being demanded of the building industry.

These new systems – natural-ventilation and mixed-mode building conditioning, underfloor air distribution, displacement ventilation, radiant heating/cooling, high performance/integrated facades, personal environmental control – have the potential to dramatically improve traditional levels of energy efficiency without compromising, and possibly increasing, occupant satisfaction and thermal comfort, and increase the flexibility and useful life of the conditioning systems. All of them function by producing thermally asymmetric environments, which require new approaches to operation, and a reexamination of how comfort performance is quantified in standards and design tools. They also require a higher level of sensing and feedback to produce the efficiency gains they are capable of. Finally, the building professions need training to be aware of and proficient in these new developments.

Task #1 – Energy Case Study of Advanced Integrated System

Objective

The objectives of this task are to:

- Identify and install necessary energy monitoring instrumentation and trending capabilities in the David Brower Center to enable detailed monitoring study of energy performance.
- Collect and analyze energy use data for both the summer 2010 and winter 2010-11.

Deliverable: Case study report: David Brower Center

Background

The David Brower Center (DBC) is a 4-story 45,000-ft² office building located in downtown Berkeley, California (Figure 1.1). The building was completed and first occupied in May 2009. It contains lobby and public meeting space on the first floor and open plan office spaces on the 2nd-4th floors, which primarily house non-profit environmental activist organizations. Integral Group (formerly Rumsey Engineers) was the mechanical design engineer on the project and, working with the architect (Solomon E.T.C. – WRT) and other design specialists, put together a design promoting low energy consumption. The goal of a low energy building was achieved through an integrated design process that combined thermal mass, shading, and insulation into an efficient building envelope, implemented daylighting and efficient lighting control strategies, and used a low energy HVAC system. The primary space conditioning subsystem is hydronic in-slab radiant cooling and heating, which is installed in the exposed ceiling slab of the 2nd – 4th floors of the building. Due to their larger surface area and high thermal mass, slab integrated radiant systems use relatively warmer chilled water temperatures, making them well-matched with non-compressor-based cooling, such as cooling towers. In addition to the improved efficiency of transporting thermal energy with water vs. air (about 1/7), the building cooling energy savings are attained through the utilization of a cooling tower, instead of a chiller, to make cooling supply water.

CBE has been conducting a field study of the Brower Center since it opened in May 2009. Previously, results were reported for the occupant satisfaction survey and Energy Star calculation [Bauman et al. 2011]. The David Brower Center achieved a preliminary Energy Star rating of 99, demonstrating exceptional energy performance and well above the threshold of 75 to qualify for an “Energy Star Label.” The results are based on one year's worth of utility bill data (including total PV generation, i.e., not including utility buy-back) for the period ending June 30, 2010. When buy-back is accounted for, the Energy Star rating may increase to 100. The weather normalized site energy utilization intensity (EUI) was 47 kBtu-sf/yr.¹ The focus of the current phase of research at DBC is to go beyond the building total energy use metric used by Energy Star by conducting a more detailed energy study based on sub-metering end uses in the building. This case study report describes our progress and results from this effort.

Installation of power meters

During the past year, CBE completed an installation of power monitoring equipment that allows a detailed end use breakdown of energy by HVAC system components (e.g., air handlers, cooling tower, water pumps, water source heat pumps), and building loads (e.g., lighting, plug

¹ Based on total PV generation, once over-generation is determined, the EUI will be even lower.



Figure 1.1: David Brower Center, Berkeley, CA

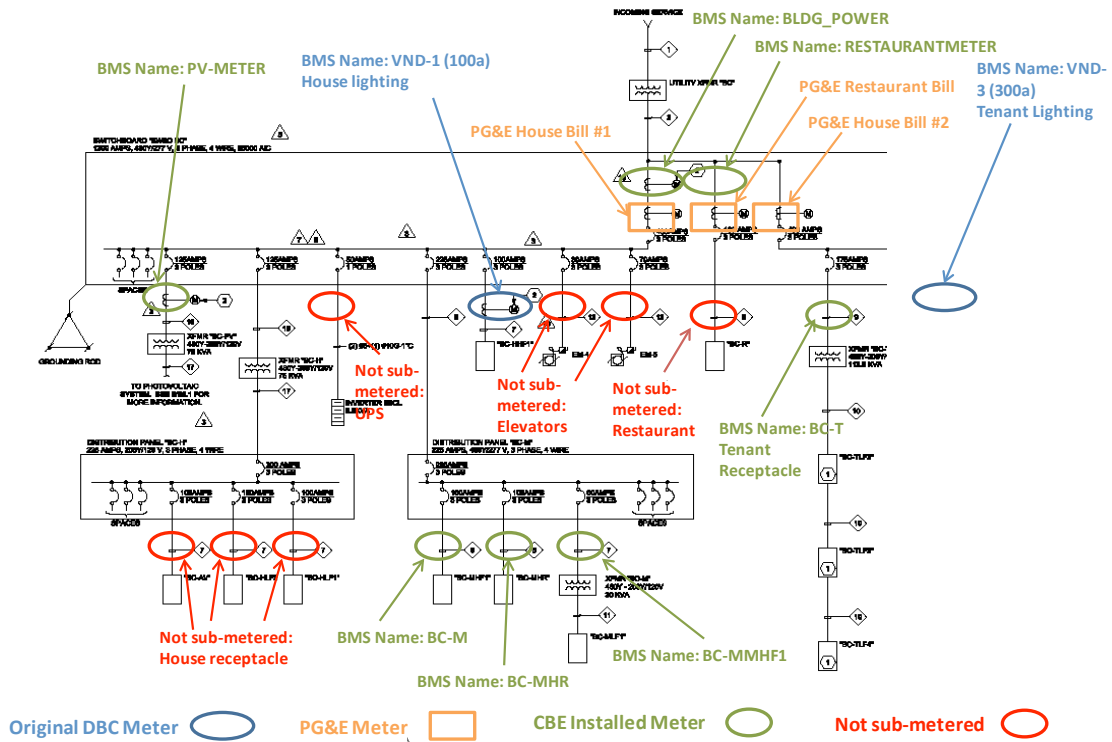

Figure 1.2: Single-line electrical diagram of David Brower Center showing installed meters

loads, auxiliaries). Figure 1.2 presents an annotated single-line electrical diagram of DBC highlighting the original (building) meters, PG&E meters, and the newly installed meters supported by this grant. Table 1.1 summarizes the monitored panels and HVAC equipment.

Table 1.1: Summary of monitored electrical panels and HVAC components at DBC

Metered Panel Name	Sub-Panel Name (*metered)	Summary Loads	Metered HVAC Component Name	Detailed Loads
VND-3		Tenant lighting		Tenant lighting (floors 2-4)
	BC-THF2	Tenant lighting		2 nd floor tenant lighting
	BC-THF3	Tenant lighting		3 rd floor tenant lighting
	BC-THF4	Tenant lighting		4 th floor tenant lighting
BC-T		Tenant plug loads		Tenant plug loads (floors 2-4)
	BC-TLF2	Tenant plug loads		2 nd floor tenant plug loads
	BC-TLF3	Tenant plug loads		3 rd floor tenant plug loads
	BC-TLF4	Tenant plug loads		4 th floor tenant plug loads
RESTAURANT METER		Restaurant		Restaurant
BLDG_POWER		All building power except tenant loads and restaurant		Net building power, including impact of PV generation, except tenant lighting and plug loads, and restaurant
	PV_METER*	PV power		Power produced by PV array
	VND-1*	House lighting		1 st floor lights, lobby, courtyard
	BC-MMHF1*	Heat pumps		HP1-1 – HP1-6, HP1-8, HP2-2
	BC-M*	Miscellaneous		HP1-7, exhaust fans, misc.
	BC-MHR*	HVAC		Water pumps (P1-P8), cooling tower (CT-1), air handling units (AHU1, AHU2)
			cw_pump_1	Cooling tower chilled water pump #1
			cw_pump_2	Cooling tower chilled water pump #2
			rad_pump_3	Radiant slab pump #3
			rad_pump_4	Radiant slab pump #4
			hw_pump_5	Boiler hot water pump #5
			hw_pump_6	Boiler hot water pump #6
			cw_pump_7	Condenser chilled water pump #7
			cw_pump_8	Condenser chilled water pump #8
			ct_fan	Cooling tower fan
			ahu1	Air handling unit #1
			ahu2	Air handling unit #2
	BC-HLF2	Miscellaneous		House plug loads (staff offices, conf. rooms, etc.)
	BC-HLF3	Miscellaneous		House plug loads (lobby, restrooms, conf. rooms, etc.)
	BC-AV	Theater AV		House plug loads (theater)
	EM-4	Elevator		Elevator
	EM-5	Elevator		Elevator
	UPS	Back-up power		Uninterruptable power supply

When viewed in color, Figure 1.2 identifies the two original DBC meters, the three PG&E meters, and the seven meters installed by CBE. Included is a third original uni-directional DBC meter that was moved to the restaurant meter and replaced by a bi-directional meter (BLDG_POWER). Table 1.2 indicates that the total power used by the building can be found by summing the four meters in the left-hand column: VND-3, BC-T, RESTAURANTMETER, and BLDG-POWER. For purposes of analyzing energy use in the David Brower Center as an office building, we exclude the restaurant, and therefore focus on the other three main meters, along with all sub-meters and HVAC components, as listed in the table. The BLDG_POWER meter records all building power except tenant lighting and plug loads, and the restaurant. This bi-directional meter also includes the contribution from the PV array on the roof and will report a positive net value when power is purchased from PG&E and a negative net value when the PV array produces more power than that used by all other building loads on the BLDG_POWER meter and is sold back to PG&E. In addition to the contribution from the PV_METER, there are four sub-metered panels included under BLDG_POWER. Among these is the BC-MHR meter that monitors all major HVAC equipment. By utilizing the power reporting capabilities of the variable frequency drives (vfds) that control each of these HVAC components, we are also able to record the power usage of each individual component. The six sub-panels listed at the bottom of Table 1.1 are not metered; the total power used by these miscellaneous loads can be determined by subtracting the power consumed by all other sub-meters from the total reported by the BLDG_POWER meter. All metered panels shown are being trended through the building management system (BMS).

Results

The installation of all power monitoring instrumentation was completed in December 2010. Power data have been collected and analyzed for the month of January 2011. Figure 1.3 shows average weekday power consumption profiles for the major panels and meters based on all non-holiday weekdays during January. The results show that on average, the BLDG_POWER (which does not include the tenant power) is selling power back to PG&E for a few mid-day hours due to the PV generation. The total building power usage is still positive at all hours because it also includes the two tenant meters (their sum is shown as "tenant power"). The non-tenant power profile is shown as the sum of the bi-directional BLDG_POWER meter and the PV generation.

Figure 1.4 presents average weekday power consumption profiles for all sub-metered panels underneath the BLDG_POWER (or BC PG&E Meter) meter. The highest profile (non-tenant power) is identical to that shown in Figure 1.3. The four sub-panels (VND-1, BC-MMHF1, BC-M, and BC-MHR) all exhibit fairly typical and steady day-time use profiles that never exceed 8.6 kW on any given hour. The sum of these four sub-panels is shown as the dotted blue profile. The difference between the non-tenant power and the total for these four sub-panels is shown as the green profile, which represents a variety of miscellaneous loads. Surprisingly, this miscellaneous profile reaches a maximum value around 20 kW (considerably higher than all individual sub-meters shown) during the morning hours before gradually decreasing to around zero by late afternoon. We are investigating the possible causes of this use profile. It seems likely to include lighting because the profile increases again in the evening, coinciding with nighttime hours during January.

Figure 1.5 presents average weekday power consumption profiles for all HVAC equipment underneath the BC-MHR meter. With the exception of the AHUs (dashed dark blue line), all pumps and the cooling tower fan show low power usage for all hours of the day (mostly less than 1 kW). During January the cooling tower fan is turned off most of the time. The top two dotted profiles represent a comparison between the power measured at the HVAC panel (BC-MHR) and the sum of all HVAC components. We are investigating the cause of the difference.

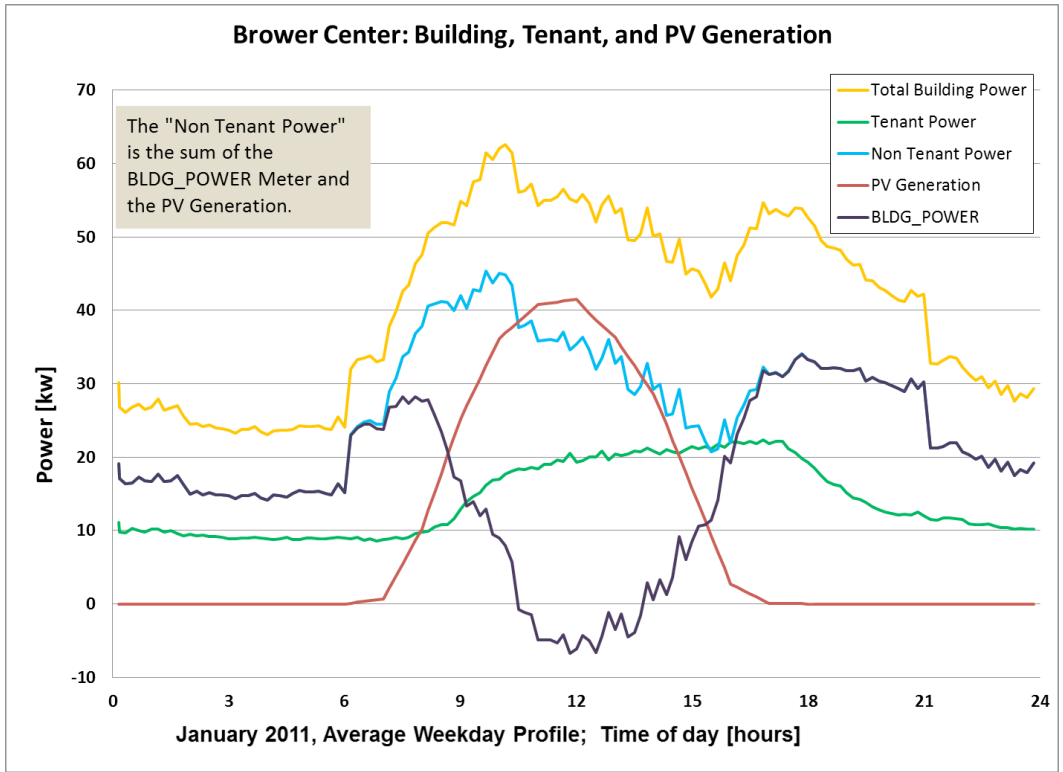

Figure 1.3: Average weekday power profiles, main panels, David Brower Center

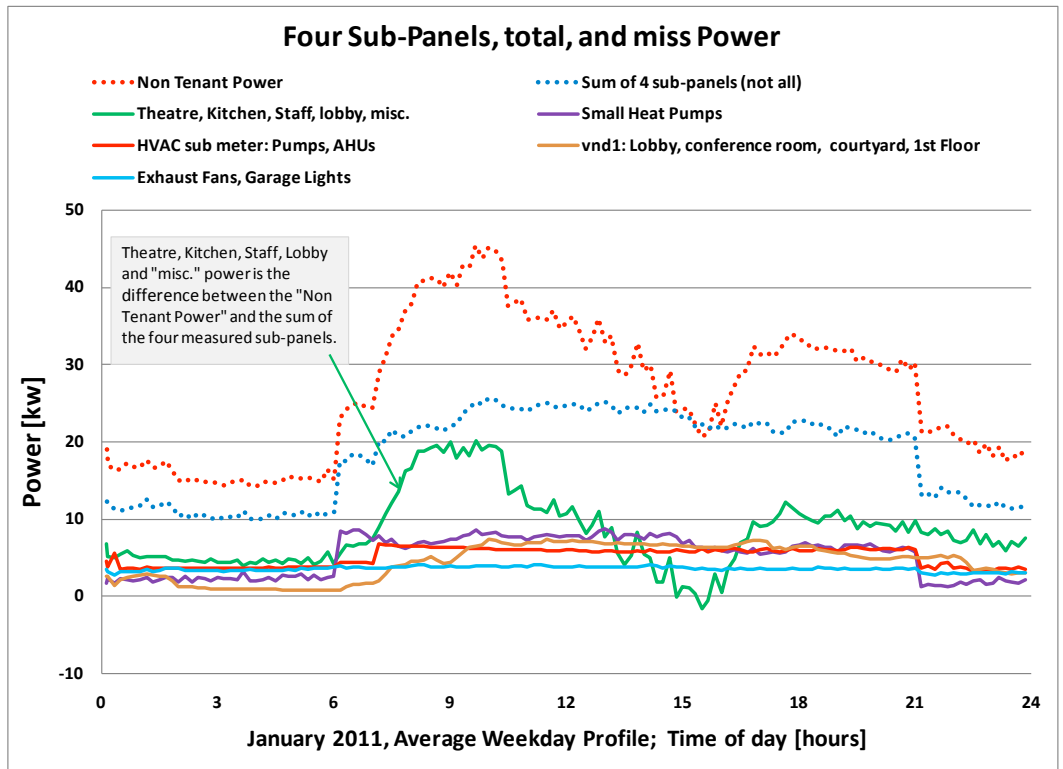

Figure 1.4: Average weekday power profiles, sub-panels, David Brower Center

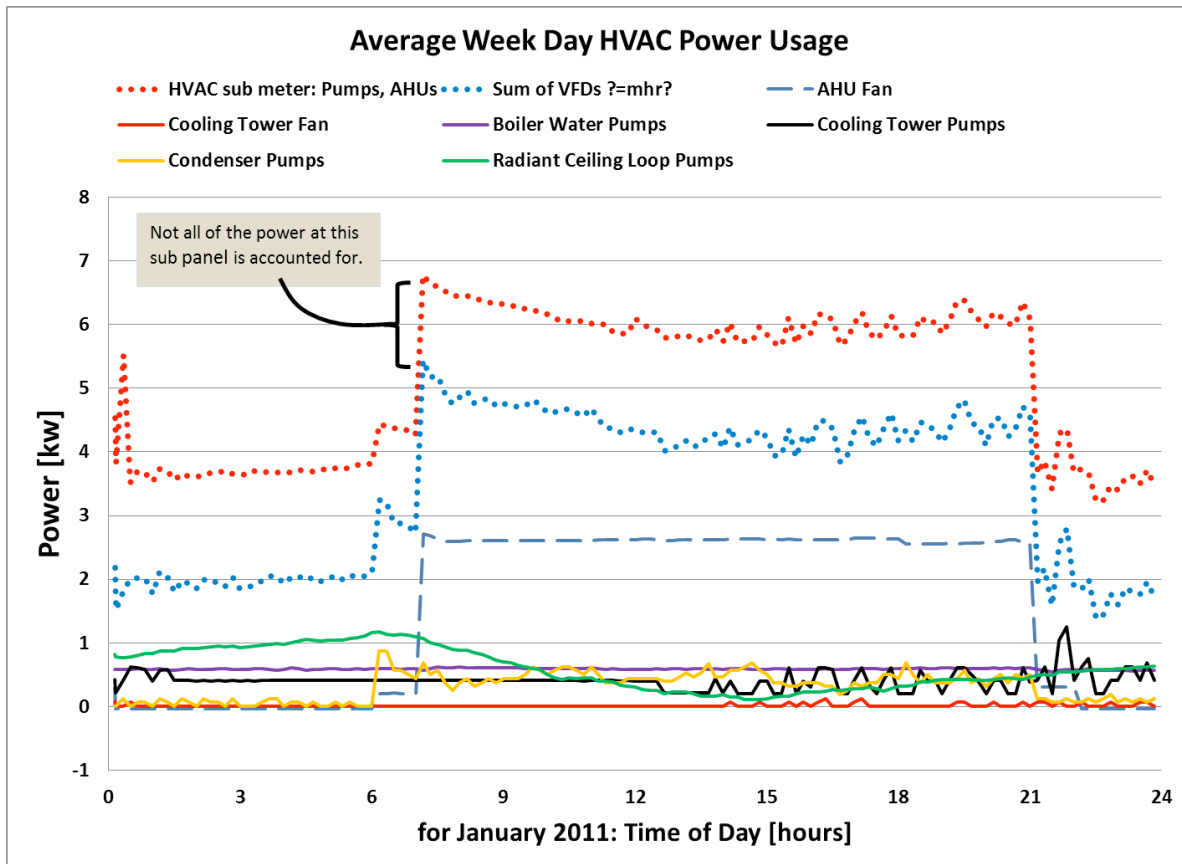

Figure 1.5: Average weekday HVAC equipment power profiles, David Brower Center

Next steps

CBE's field study of the David Brower Center is continuing under funding from CEC/PIER (Contract 500-08-044) and CBE Industry Partners. Although the completion of the power monitoring installation was delayed due to circumstances beyond our control, we now have an excellent sub-metering capability moving forward. CBE will be studying the controls and operation of the David Brower Center and identifying strategies for improving system performance in terms of energy use and comfort. The upcoming work will focus on key elements of the advanced system design of the building, including slab-integrated radiant cooling and heating, and underfloor air distribution. Heating operation will be studied over the next few months before switching to cooling performance during the spring and summer months.

References

Bauman, F., Webster, T., Lee, K.H., Schiavon, S., Dickerhoff, D, Arens, E., Zhang, H., and Moore, T. 2011 (In press). "Advanced Design and Commissioning Tools for Energy-Efficient Building Technologies." Final report to California Energy Commission (CEC) Public Interest Energy Research (PIER) Program, Contract 500-06-049. Center for the Built Environment, University of California, Berkeley.

Task 2 – Monitoring and Commissioning Tools Development

Background

This work extends previous development work to expand the wireless capabilities of our UFAD commissioning (Cx) cart. This expansion is occurring in steps with the ultimate goal to create an “all wireless” monitoring system capable of supporting performance assessment of a diverse set of building conditioning technologies. Previously we identified an information system architecture, determined functional requirements for the system, and investigated various wireless networking products. We conducted a field test of the Archrock system in comparison to the Dust Networks system embodied in Federspiel Controls products. We found significantly faster setup and more robust and reliable networking with the Dust Networks system in side-by-side testing in the David Brower Center. We decided to continue working with Federspiel Controls products for our networking solution.

Objectives

The objective of this task is to design a new “universal” wireless sensing platform to support the development of the “all wireless” second generation data acquisition and analysis system.

Deliverable: Final results and discussion

Two tasks were completed that are critical steps toward our goal of creating supporting infrastructure for the all wireless system illustrated in the Figure 2.1 below. Prior to the software upgrades discussed below we purchased the latest generation wireless system from Federspiel controls that consisted of 15 newly designed motes, master station network controller, and database/server PC.

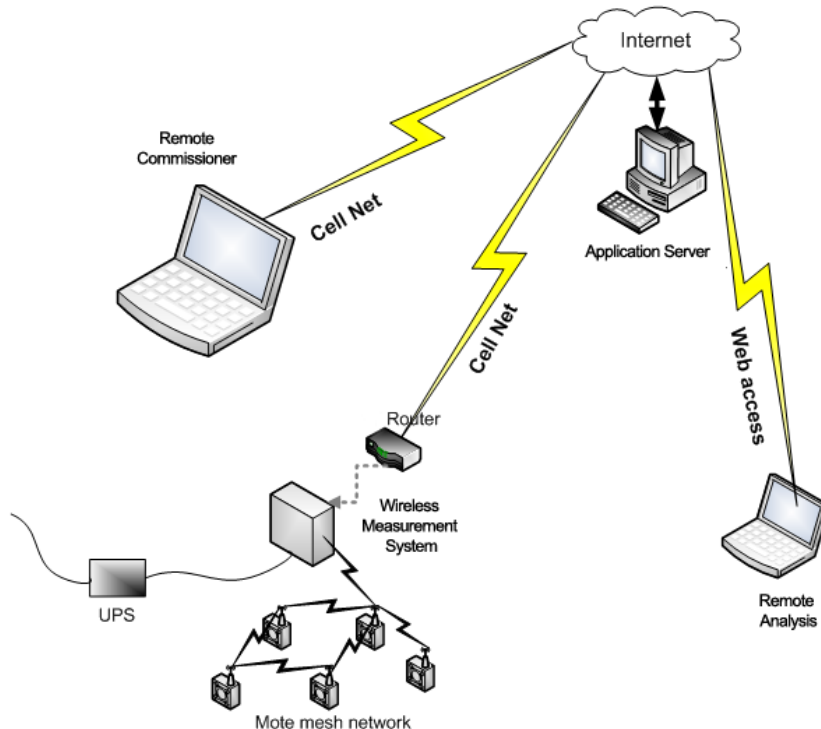

Figure 2.1: Information architecture for all wireless measurement system

Sub-task A: Upgrade current UFAD cart software

In this task we created an OCBD interface to the base station (Wireless measurement system (WMS) shown in Figure 2.1) data logging database to standardize and improve access to the base station FireBird database. We upgraded the UFAD Cx cart LabView software to the latest 2009 version and upgraded the software to fetch data from the base station. Finally, we modified the LabView software to create a vertical stratification display using mote data instead of hardwired sensors on the UFAD Cx cart.

Sub-task B: Modified Current CART for Remote Server

In this task the base station WMS server was configured to allow data transmission over cellnet modems. This allows collected data to be transmitted directly to the remote application server instead of a local PC as was the case for the UFAD Cx cart. An initial database was developed for the remote server to accept the data and allow development of trial applications for data presentation and analysis.

This finalized pilot system was field tested in two projects; Kresge Foundation Headquarters in Troy, MI (February 2010 and August 2010), and the CALSTRS headquarters in Sacramento, CA, in July 2010. Data was successfully uploaded to the application server and stratification profiles created there could be viewed in the building on a laptop PC.

Task #3 – Integration of Energy Data into CBE Survey Database

Objective

The objectives of this task are to:

- Gather energy data from utilities and governmental organizations for buildings in Occupant Satisfaction Database.
- Expand database structure to permit energy information datamining.
- Compile findings into cross-cutting datamining report based on comparisons of satisfaction data, market outcomes and newly integrated energy performance data.

Deliverable: Integration of Energy Data into CBE Survey Database

1. Introduction

California's commercial sector accounts for 19% of our state's energy use [1] and 36% of electricity use. In fact, California's commercial sector accounts for more electricity use than any other sector [2]. Achieving progress toward this resource efficient future requires rigorous analysis of energy use and identifying opportunities for reductions.

Two methods for quantifying and identifying energy reduction opportunities have emerged as frontrunners: energy simulation and energy benchmarking. ASHRAE's Advanced Energy Design Guides are examples of the former. These guides provide climate-specific recommendations that may support up to 30% reductions in energy use from ASHRAE standard 90.1 levels [3]. The Energy IQ interface, developed by Lawrence Berkeley National Lab, is an example of the benchmarking approach. With this tool, you can identify energy saving opportunities by comparing your building's measured energy performance against a set of measured energy data from similar projects [4].

Both energy simulation and benchmarking are still emerging methods. Yet in both cases, it can be challenging to produce real-world results that match the performance of simulation or benchmarking studies. Energy simulations, for example are difficult to validate [5]. Further, differences between projects may render simulated results idealized rather than achievable goals. At the same time, benchmarking data sets often do not include enough detail to understand the effect of changes at the system level. It is difficult to suggest specific system-level interventions without this information. The Energy IQ interface is lacking in this regard. Its national dataset includes little information about building systems. These limitations do not allow designers to understand actual energy impacts; only hypothetical impacts can be known. Further, neither method routinely includes the occupants' perspective.

Despite these flaws, both methods offer ways to guide designers' intuition, and for this reason are useful. This report describes the integration of actual energy use data for 39 buildings recently surveyed into the CBE survey database. We characterize the energy use data in terms of occupant satisfaction, climate, square footage, and year of construction.

2.1. CBE's Occupant Satisfaction and Building Characteristics Data

The Center for the Built Environment (CBE) developed and operates a survey that records occupant satisfaction about indoor environmental quality as well as information about location, building elements and energy use, among other items. In most cases, the survey data is the

focus of the analysis. This paper differs from CBE's usual reports in that its focus is the building characteristics data.

The building characteristics data are gathered from building staff and design team representatives during the survey implementation process. These persons are the best source for such data as they are most knowledgeable about their building's design, operations and management. The data is entered via a web-based interface by these third parties (as is true of CBECS and CEUS) and is maintained in a SQL database. Using online reporting tools, CBE industry partners, affiliates and researchers can compare buildings across some of the characteristics in the data.

The building characteristics data can include over 100 characteristics for each building. On average, information for 32 elements is entered for each building. CBE is actively seeking to fill in missing elements; yet, the current state of the database permits useful analysis. Over 800 buildings are represented in the database. Of these 800 buildings, 60 include energy use information. All of this energy information is observed; none is simulated.

The CBE database is smaller than other often used sets of measured energy data. Energy data was added to CBE's building characteristics data in 2008; thus, most buildings added to the database before that point do not include energy data. However, due to CBE's data gathering efforts, a good base set of data is extant.

2.2. Analyzed CBE Data

The data for analysis includes 39 buildings that are a subset of the larger CBE building characteristics database. We will refer to these buildings as the 'sample set.' We arrived at this set after investigating areas that might act as intervening factors affecting energy use, and then removing outliers. Buildings were selected if the following data elements were present in their respective database entries.

1. Site Energy Use Intensity (kBtu/(ft² yr))
2. Gross Square Footage (GSF)
3. Year of Construction
4. Completion of the "Design Feature" section of the building characteristics form (later defined as a passive or advanced technology feature)
5. Located in the United States
6. Primarily composed of offices

Fifty three buildings met these criteria. The final set of 39 was achieved after removing 14 buildings with incomplete data or outlier buildings with abnormally high or low EUIs. These buildings were removed due to concerns with the reliability of the data.

The final sample set has an EUI range of 31 to 193 kBtu/(ft² yr). The standard deviation of the sample set is 39.8. The median is 76.9. *Figure 1* shows the summary EUI data and the frequency distribution for the analyzed sample.

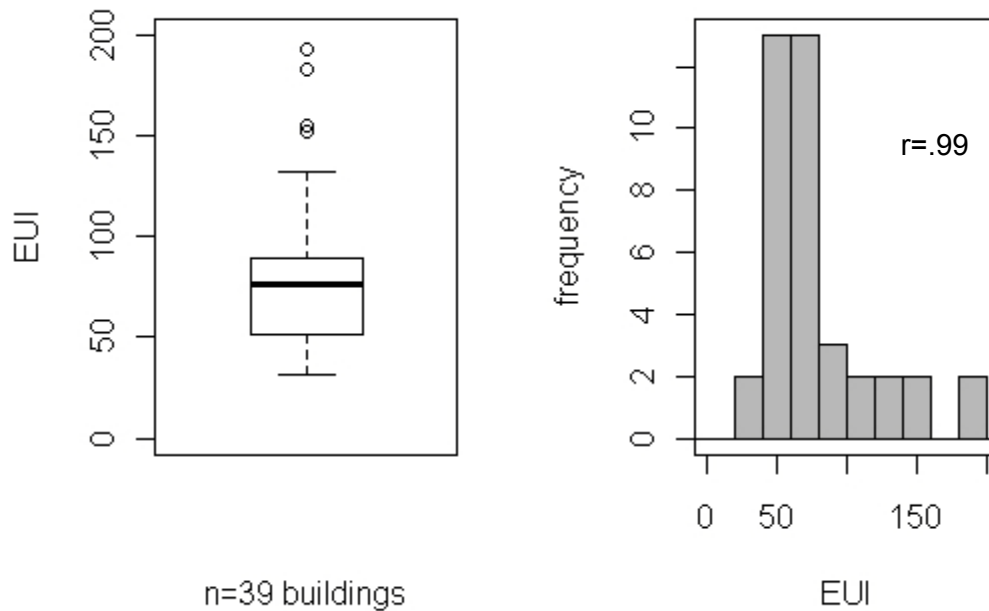

Figure 1: EUI summary data and frequency distribution for the analyzed sample.

2.3. Sample Buildings Satisfaction Scores vs CBE's Benchmarked Database

In this section the satisfaction scores of the sample set are compared to CBE's benchmark (Table 1). The sample buildings IEQ scores are higher than the CBE benchmark set. It is important to note that the energy use characteristics we describe in the results section are not achieved at the expense of occupants.

Table 1: Average Satisfaction Scores of the sample set vs. the CBE Benchmark

	Satisfaction with:				
	Acoustics	IAQ	Lighting	Temperature	Overall Building
Sample set (n=39)	0.55	0.98	1.37	0.2	1.28
CBE benchmark (n=475)	-0.027	0.31	1.1	-0.13	0.94

2.4. Geography

To investigate whether climate has a direct effect on energy use, the climate zones were determined for each building in the sample set using the U.S. Department of Energy Building America Program, which divides the United States into eight climate regions; Hot-Humid, Mixed-Humid, Hot Dry, Mixed Dry, Marine, Cold, Very Cold and Arctic. These zones are defined by heating degree days, average temperatures and precipitation [9]. As shown in Table 2, over 50% of buildings in the analyzed data are in the cold climate zone. Since our sample may potentially include too many buildings in this zone however, we have broken out the data in the results section by climate zone when useful.

Zone	Count	Percentage
Hot-Humid	1	3%
Mixed-Humid	4	10%
Hot Dry	6	15%
Mixed Dry	1	3%
Marine	6	15%
Cold	20	51%
Very Cold	1	3%

Table 2: Distribution of climate zones among sample set buildings.

2.5. Gross Square Footage (GSF)

Building sizes in the sample set range from 3,320 to 1,431,998 ft² with a median value of 191,705 ft². The data are strongly skewed. We examined the relationship between building size and EUI. *Figure 2* shows the relationship between building size and EUI.

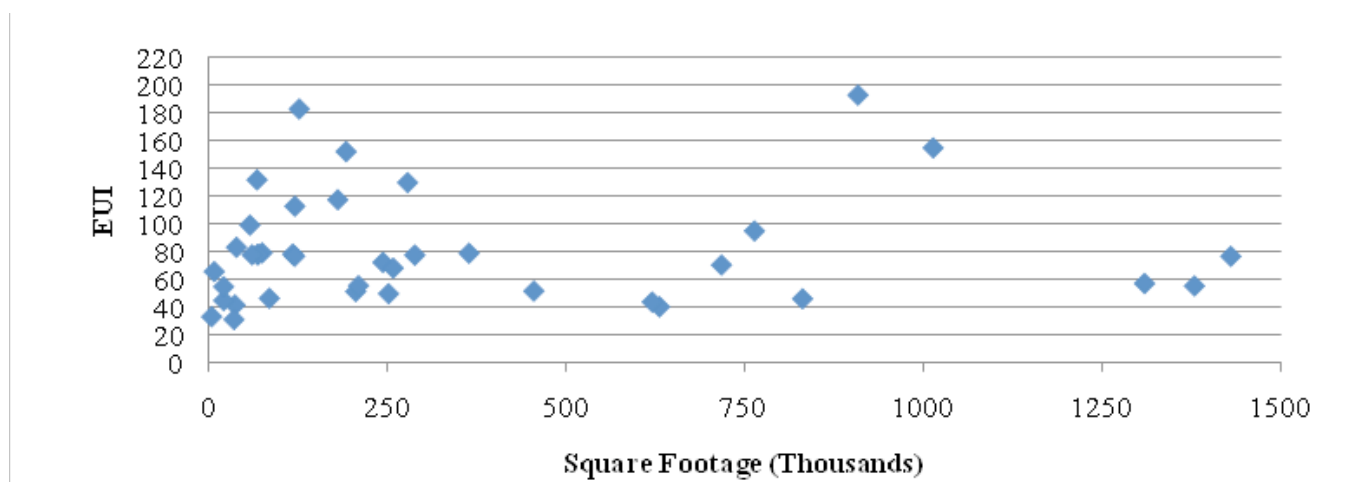

Figure 2: Building Size vs. EUI

2.6. Year of Construction and Renovation

CBE's database tends to have more recently constructed buildings than older ones. To determine whether there are differing energy use patterns amongst different eras of buildings, we analyzed the relationship between building age and EUI. We found that the data are strongly skewed.

Related to the years of construction and renovation, it is interesting to note if the introduction of sustainable building practices is noticeable in the data. To investigate this issue the data was segregated into two groups, one of buildings constructed or renovated before 1995 and the other after 1995. This is approximately the year LEED was introduced. We did not specifically compare LEED rated buildings or other buildings with sustainability designations as it is possible that any building may have incorporated sustainability elements without having sought the designation. Of the 39 sample buildings, 15 of the buildings were constructed prior to 1995 and 24 were constructed post-1995. Among these two age groups, we have segmented the buildings into three EUI ranges: low, medium and high. The low group is approximately one standard deviation below the median of EUIs, at 40 kBtu/(ft² yr).. The high group is

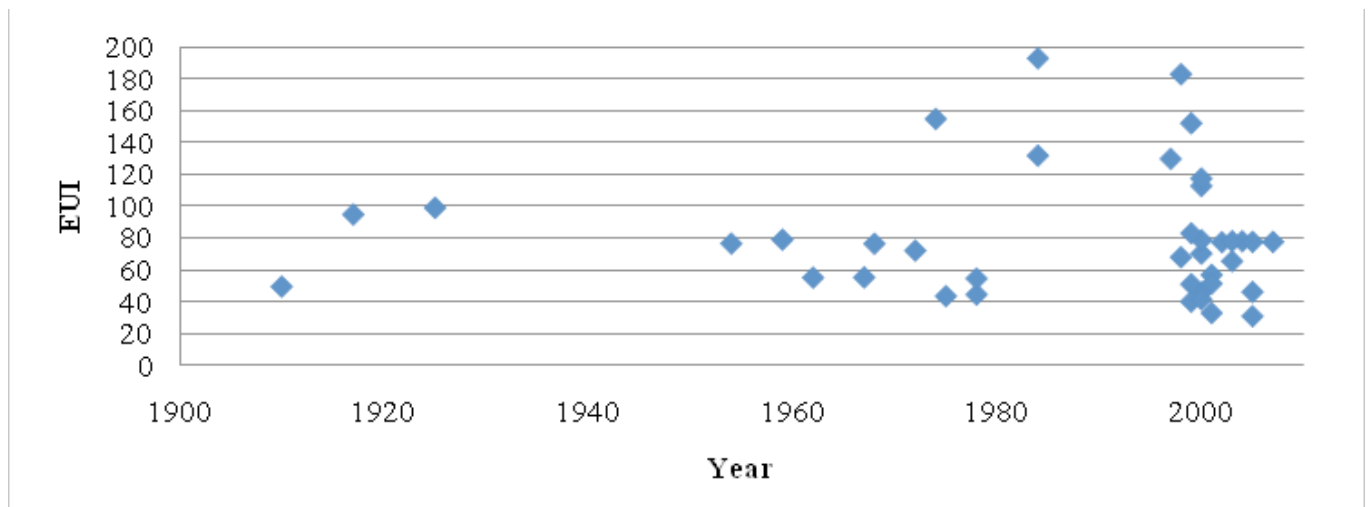

Figure 3: Year of construction vs EUI.

approximately one standard deviation above the median at 120 kBtu/(ft² yr).² Figure 4 shows the results.

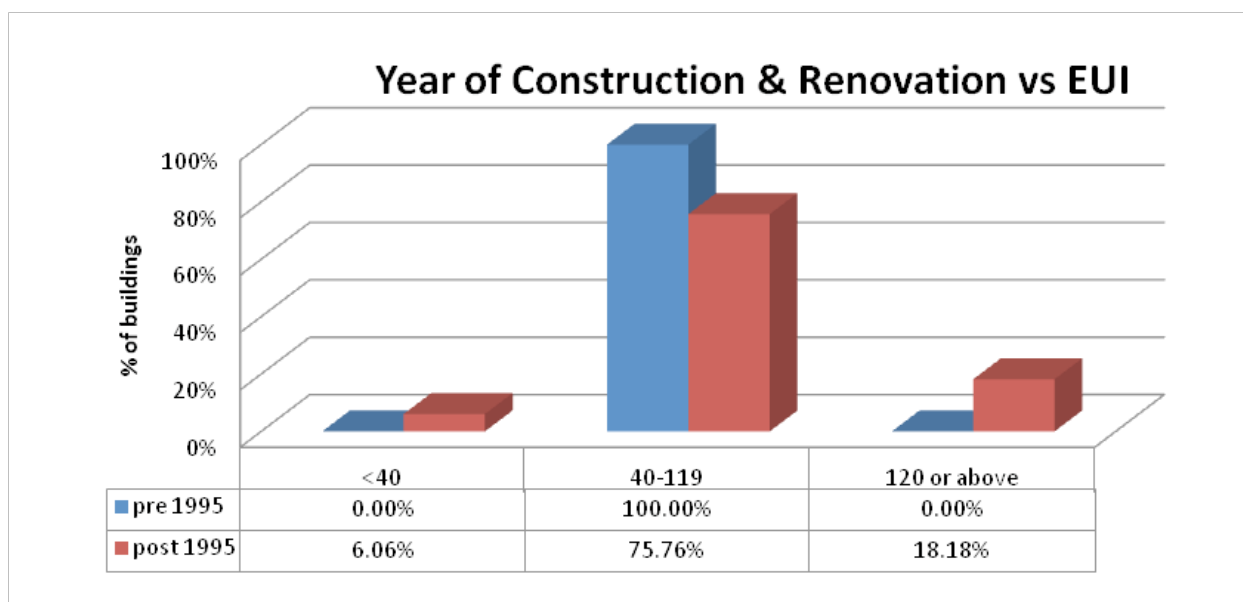

Figure 4: Samples buildings were segmented into three EUI ranges as well as into two age groups.

In these data, newer buildings exhibit a wider range of energy use than do older ones. It is noteworthy that no building constructed *before* 1995 has a EUI greater than 120 kBtu/(ft² yr) while 18%, or 5 buildings constructed or renovated *after* 1995 exceed 120 kBtu/(ft² yr). Three of these five newer buildings were renovations and two were new construction. At the same time, it should be noted that none of the pre-1995 buildings had EUIs lower than 40 kBtu/(ft² yr). These are mixed results. Yet, it is notable that lower EUIs are seen after 1995; that is to say that very low EUIs were reached after the advent of sustainability thinking.

² For conceptual ease we have used the 40-120 range although the precise range is 37.10 to 166.7. This small shift does not affect the results or their implications.

3. Summary

In this task, we have incorporated measured building energy use data in the form of site energy use intensity (EUI) into the CBE benchmark database for 39 recently surveyed buildings. The energy use data were characterized in terms of occupant satisfaction, climate, square footage, and year of construction. Efforts to analyze the data further based on different building features described in the CBE buildings characteristics data proved unsuccessful due to the limited amount of data available. As more building energy use data are added in the future, we will continue to look for opportunities to extend this study.

4. References

[1] Energy Information Administration. "State Energy Data 2007: Consumption." Short-Term Energy Outlook. Jan. 2009. 4 Feb. 2010

http://www.eia.doe.gov/emeu/states/sep_sum/html/pdf/rank_use.pdf

[2] Brown, R. and J.G. Koomey. 2002. *Electricity use in California: past trends and present usage patterns*. LBNL-47992. May. Berkeley, Calif.: Lawrence Berkeley National Laboratory.

[3] "Advanced Energy Design Guides." *The American Society of Heating, Refrigerating and Air-Conditioning Engineers*. N.p., n.d. Web. 10 Mar 2010.

<<http://www.ashrae.org/technology/page/938>>.

[4] Matthew, Paul, Evan Mills, Norman Bourassa, and Martha Brook. "Action-oriented Benchmarking: Using the CEUS Database to Benchmark Commercial Buildings in California ." *Energy Engineering*. 105.5 (2008): 6-18.

[5] Crawley, Drury, Jon Hand, Michael Kummert, and Brent Griffith. United States. *Contrasting the Capabilities of Building Energy Performance Simulation Programs*. Washington, DC: , 2005.

Task #4 – Facade Design and Performance

Objective

The objectives of this task are to:

- Identify and document case study buildings with high-performance, integrated facades.
- Conduct interviews with design professionals and façade system manufacturers to document current practices for façade design analysis for energy, glare and daylighting.
- Document the use of fixed and/or dynamic exterior shading features in terms of benefits (energy savings, glare reduction) and barriers to implementation (cost, maintenance).
- Develop and test a new module for CBE's Occupant Indoor Environmental Quality (IEQ) Survey to study the effects of façade design in terms of occupants' visual and thermal comfort

Deliverables

Task 4.1 Case Studies and Report on High Performance Facades.

A number of buildings built in central and northern Europe over the last two decades utilize a range of more advanced facade design solutions than those typically implemented on U.S. buildings – a trend that has been driven in part by higher energy prices, stricter building codes, and higher expectations regarding the quality of the built environment in Europe than in North America.

We conducted a critical analysis of select North American buildings, and interviews with building professionals in northern Europe and North America, CBE's report identifies both simple and advanced facade technologies that enable the development of commercial buildings that minimize the need for HVAC and lighting energy use, while enhancing occupant well-being.

Challenges and lessons learned from detailed North American case study buildings are discussed in hope that these can serve as a guide for the successful implementation and accelerate the adoption of advanced facade design solutions in the U.S. building stock. Findings from discussions with design teams and building managers reveal that many of the fundamental principles driving facade design in European buildings can and are already being applied in North American buildings. One exception to this trend is that automated facade technologies are only slowly beginning to penetrate the market, accompanied by a moderate learning curve on the projects on which they have been installed. Regular system maintenance, occupant education, and assessment of occupant satisfaction during the building operation phase are critical for ensuring that facade systems are meeting energy and occupant comfort requirements.

Citation:

Zelenay, K., M. Perepelitza, and D. Lehrer, 2010. High-Performance Facades: Design Strategies and Applications in North America and Northern Europe, Draft Report to California Energy Commission PIER Program, December, 76 pp.

This report is attached as Appendix 4-1 of this report.

Task 4.2. Occupant IEQ Survey Module for Facade Evaluation, and Pilot Tests of Module.

CBE began developing a web-based indoor environmental quality (IEQ) survey and accompanying online reporting tools in 2000. The IEQ survey includes a standard set of unchanging “core” questions that are useful for benchmarking, identifying trends, and better understanding the implications of raw survey scores. This core survey has now been implemented in over 600 buildings, and the results of these surveys provide a unique research resource.

In addition to the core survey questions, CBE research staff have also developed additional survey “modules” that allow detailed investigation of specific building features or design strategies, in many cases in support of ongoing CBE research. For example, survey modules have been developed to investigate the IEQ impacts of underfloor air distribution (UFAD) systems, safety and security, operable windows, and accessibility. The objective of this research project was to develop a specialized survey module that would allow researchers, designers, and building operators to focus on the aspects of facade design that may impact the comfort and satisfaction of building occupants.

We developed the facade survey module over the summer of 2009. We received input on the development of the module from CBE Industry Partners at CBE’s Industry Advisory Board meeting in October of 2009. (In conjunction with this survey development work, we also created an Operations & Maintenance survey, with input and funding from Nysan, a manufacturer of window shading systems, and from McClintock Facades, a facade consultancy.)

The development of the new facade module brought up several interesting challenges. To insure that the survey benchmarking capability was maintained, the core survey questions could not be altered. Therefore all facade-specific questions had to be included on separate pages within the survey, and/or relegated to “branching” question pages. Also, it was important for the survey instrument be appropriate in buildings that potentially could have a wide range of facade features, including various combinations of interior and/or exterior shades, operable windows or other user-controlled elements, and manual and/or automated control systems. To provide for this adaptability the survey module includes a branching structure. Survey takers are asked what facade features their building includes (for example, ‘what kind of shades are included in your building’) to you and the questions that follow are selected based on this input.

The final survey module includes questions about daylight, manual and automatic operation of shades, satisfaction with shades and controls, and view. A concerted effort was made to include questions that will inform researchers and building designers about the ways in which building occupants interact with operable shaded, and how this impacts their satisfaction in terms of daylight, lighting, and view.

After the survey questions were finalized, they were programmed into the survey instrument database. The survey with the facade module was then piloted in three buildings that have interesting facade features: (1) the Orinda City Hall, in Orinda, CA, in October 2009; (2) the David Brower Center, in Berkeley, CA, in April 2010; and (3) Alley 24 in Seattle WA, in July 2010.

Results from these pilot surveys already provide interesting into occupant use of blinds, and satisfaction related to facade designs. For example, in one building respondents noted that blinds and shades are generally closed less than 50 percent of the time, and 45 percent of respondents stated that they adjust the shades one or more times per day. Out of those who adjust the shades at least one or more times per month, the reasons cited for closing shades was to reduce reflections and glare (75%), to stay cool (20%), to darken room (20%), and to

save energy (5%). The reasons cited for opening shades was to let in more daylight (100%), see the view outside (55%), warm up (10%), to open or close the window (9%), and to save energy (5%). Interestingly, few occupants are thinking of shades as an energy-conserving action, which may inform how researchers and building designers simulate the impacts of shades in energy simulations. These results of these surveys indicate that this survey module will be a valuable addition to the capability of the CBE IEQ survey, and as it is implemented in additional buildings, will provide researchers, designers, and operators with greater understanding of how occupants interact with facade features, and how facade design impacts occupant comfort and satisfaction.

The survey module is attached as Appendix 4-2 of this report.

Task #5 – Thermal Comfort Model

Background

Over 15 years, CBE developed a multiple-segment human thermal physiology and comfort model. The model divides the human body into 16 body segments (such as head, chest, back, pelvis, left and right upper arms, hands, feet etc., as shown in Figure 1). The model predicts thermal physiology (skin temperature, skin wettedness, heat loss) and comfort (warm or cool sensation and comfort, see Figure 1) for each of the 16 body segments as well for the whole body.

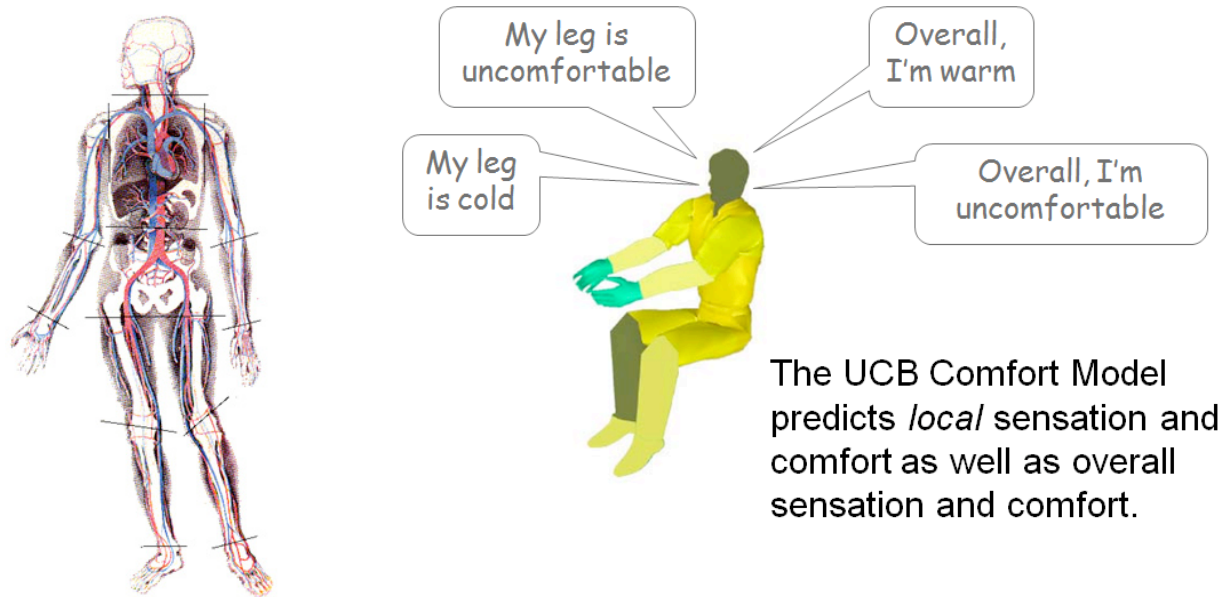

Figure 5-1: 16 body segments and comfort predictions

Objective

The objectives of this task are to:

- Develop an improved head model allowing air movement cooling effects to be more accurately simulated. The head model will be subdivided into face, hair, and neck regions. This is in response to new Std 55 air movement provisions—allowing detailed design of fan-based ventilation systems. Also for the modeling of new personally-controlled environmental control systems.

Deliverables: Task #5

- In the comfort model, the head is now able to be divided into 4 parts, allowing the neck, hair, and faces on both sides to be modeled separately. This feature enables users to account for fan or solar effects when they impact the front or sides of the face.
- The following paper has been submitted and is currently undergoing peer review: Shitzer, A., E. Arens, H. Zhang, and S. Hoffmann. In press. “Basal metabolic and blood perfusion rates in various multi-compartment, whole body thermoregulation models.” Submitted to *International Journal of Biometeorology*.

Task #6 – Prototyping Personal Environmental Control (PEC) Systems

Background

The CBE has been testing the comfort effect of PEC systems on people for more than 10 years. The PECs are proved to be very effective at providing comfort, focusing on targeted local body parts. Through the laboratory and field studies, we found that to cool head in warm environments and to warm feet in cool environments are effective ways to provide comfort.

Objective

The objectives of this task are to:

- Develop energy-efficient local heating and cooling units suitable for incorporation in office furniture, quantify and publish their performance, and find industrial sponsors to develop the systems. Incorporate wireless energy-monitoring systems. We have filed UCB intellectual property claims for the fundamental bases of these systems in order to encourage industry adoption.

Deliverables: Task #6

- Over the period of grant performance we prototyped over a dozen unique fan designs, as well as several sub-versions. Early prototypes allowed us to garner user feedback, evaluate the aerodynamics and acoustics. Later prototypes refined the design to prepare for the manufacturer of systems under Task #7. A few prototypes are displayed in Figure 6-1. They are low wattage (around 1.5 Watt), and the final version is acoustically silent. They have occupancy sensors, temperature sensors, and continuous fan speed control. Together with the foot warmer described below, the user-selected fan speed and foot warmer heating levels are transferred to a computer through a USB connection for monitoring, along with the air temperature measured upstream of the fan. This information is periodically uploaded to a database maintained by the UCB research team. The PEC units are therefore research instruments as well as personal control devices.



Version 1

Version 2

Version 3

Version 4

Figure 6-1: Various versions of the PEC fans

- Over the period of the grant, we also tested four radiant foot-warmer designs, developing a version that optimizes energy efficiency while fitting in any conventional desk kneehole. The heating level is adjusted continuously by a controller knob on the fan base. Occupancy is detected by a pressure sensitive footplate. Software provides delayed-off to avoid annoyance, and also turns off the power if it detects that occupants have artificially weighted the footpad. Figure 6-2 shows a mockup and the final metal shell, and the student who is testing different choices of the control system. The detailed drawings of the foot warmer are provided in Appendix 6-1.



Figure 6-2: Foot warmer: mockup, metal shell, strength test, control of heating level.

- Over the period of grant performance we also designed and constructed three desktop-integrated metal work surfaces to provide both heating and cooling by conduction from the hands and wrists. Figure 6-4 shows two of the the three PEC tables as displayed in the spring 2010 CBE meeting. The sandblasted aluminum surface of the table has resistance heating wire bonded beneath it to warm it in the heating season. In the cooling season, with the heating turned off, the surface quickly conducts heat from the hands to heat exchange fins on the underside of the plate, which are convectively cooled off by two little underdesk fans (1.8 W each). Similar effects can be achieved with melamine and veneered wood.

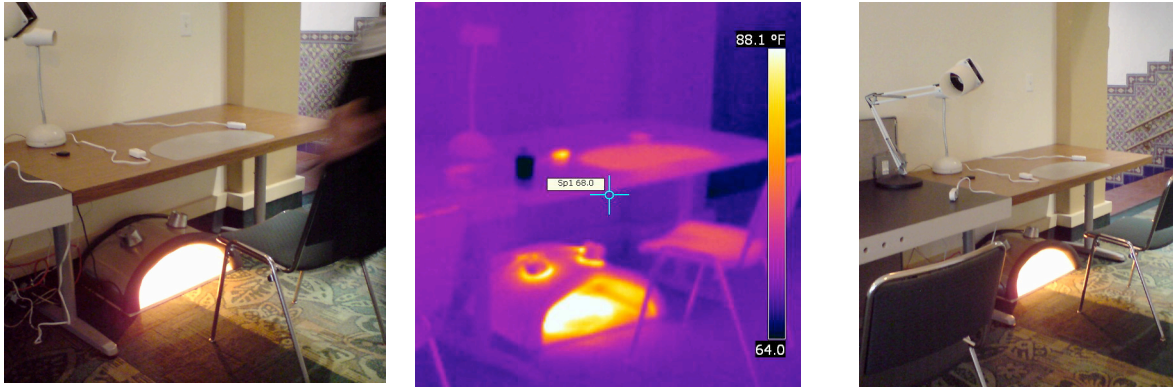

Conductive surface table and a foot warmer

IR image of the warm surface of the table and the foot warmer

Convective surface table (left)

Figure 6-3: Conductive and convective surface tables (together with a foot warmer)

- We conducted manikin tests to evaluate the cooling effect of the PEC fans.

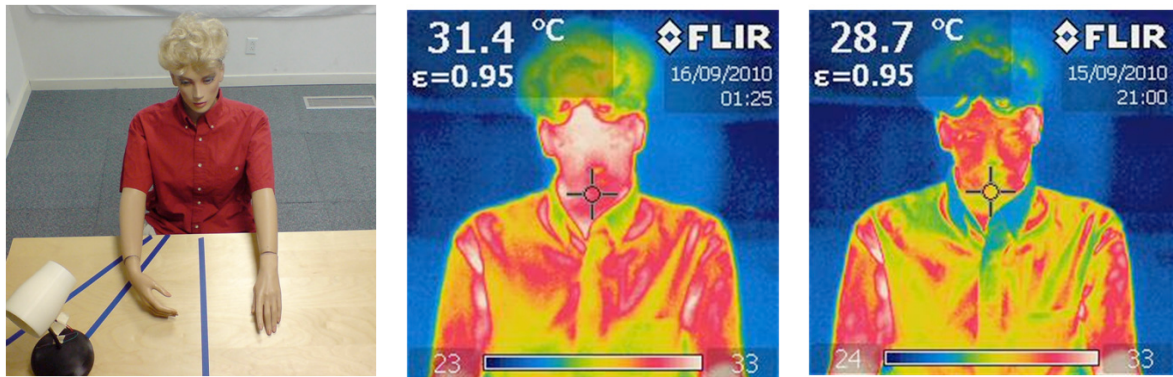

Manikin test with a PEC fan

Without PEC fan, face warmer

With PEC fan, face cooler

Figure 6-4: manikin test with a PEC fan

- We presented the development of our prototype fan units, desktop conductive and ventilative systems, and foot warmers at the spring and autumn 2010 CBE meetings. We also presented the concepts to several building owners and designers planning new construction and retrofits. These were the US General Services Administration, two private owner/operators of large California office buildings, and to numerous architects and engineers.
- We also shared our prototype designs with major furniture and office-interiors companies, giving Powerpoint presentations to four furniture companies: Steelcase, Haworth, Technion, and Knoll.
- We have filed detailed UCB intellectual property claims with the UC Office of Technology and Licensing covering the fundamental characteristics of both the fan and footwarmer systems. This action is intended to encourage industry adoption by protecting early adopters. However, the OTL is understaffed and at this point no patents have been filed.
- A paper describing the comfort and perceived air quality effects of PEC fans in a human subject laboratory study carried out at CBE chamber has been accepted by Indoor Air conference in June 2011 (see Appendix 6-2).

Task #7 – Perform Detailed Industrial Design of Personal Environmental Control Systems and Manufacture Them for Evaluation and Demonstration Projects in Actual Office Spaces

Introduction

A large effort was put into the design and development of the production versions of the fan and foot warmer: preparing shop drawings, designing control systems, finding manufacturers to produce them, and finally producing 110 sets for use in real buildings.

Each PEC system includes a fan unit made of injection molded glass fiber reinforced nylon, a foot warmer fabricated from 20 gauge sheet steel, a microcontroller to control and monitor fan and foot warmer levels, onboard sensors for the levels of controls and the ambient temperature, occupancy sensors, and a data logging ability. The PEC unit is connected to a computer by a USB connection, and the monitored data can be remotely accessed by CBE. These units can be used for research purpose so we can understand under which ambient conditions, how people are using these units. The information will be useful for the future refinement of PEC system designs.

Objective

The objectives of this task are to:

- Design systems, prepare drawings and specifications of the devices' casings, control electronics, fans, heaters, and current transformers, suitable for manufacturing molds and acquiring system parts.
- Identify manufacturers and suppliers for each type of component.
- Contract with manufacturers and suppliers.
- Inspect products and take possession of them for use in subsequent field research and demonstration projects.

Deliverables: Task #7

- During the period of performance, we completed the industrial design and specification of components for the fan and foot warmer.
- We developed a performance-based generic specification for quiet and energy efficient personal fans, which can be used by manufacturers, designers and building owners to guide the future development and use of PEC systems. The PEC specifications are included in Appendix 7-1.
- We sourced the components necessary to construct 110 PEC systems. Drawing on over two-dozen suppliers and fabricators, we commissioned, purchased and fabricated the necessary components, and monitored vendor progress to assure quality. In the case of major items, we conducted a bidding process including review of qualifications, invitations to bid and awarding the contract to the lowest qualified bidder.



Laser-cut foot warmer pieces in the factory.



Pressure plates being powder-coated in the paint factory



Foot warmers arriving in Berkeley

Figure 7-1: 125 foot warmers manufactured and delivered to UC Berkeley

- The two components of the PEC unit are shown in Figure 7-2..

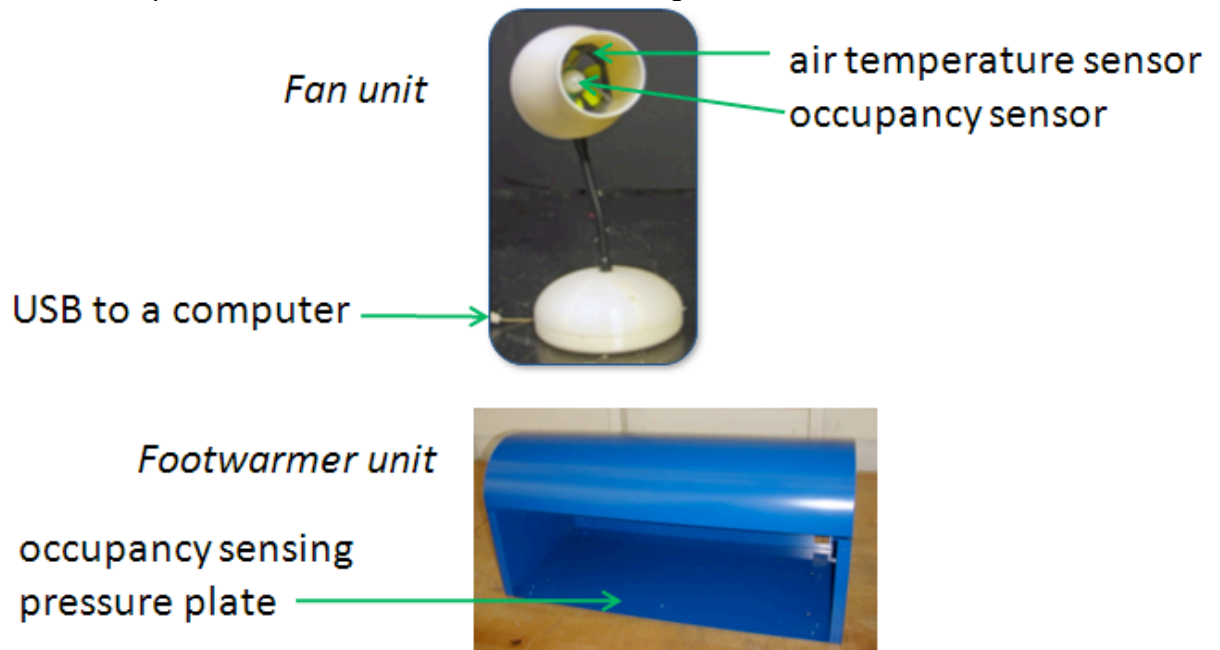

Figure 7-2: The PEC system including fan and foot warmer, occupancy and air temperature sensors.

- We have located several offices in which to install and test our PEC systems. Many of our CBE industry partners have asked to borrow the systems and to participate in the testing.