

Lawrence Berkeley National Laboratory

Lawrence Berkeley National Laboratory

Title

Behavior of two capstone 30kW microturbines operating in parallel with impedance between them

Permalink

<https://escholarship.org/uc/item/7sp52570>

Author

Yinger, Robert J.

Publication Date

2004-07-01

ERNEST ORLANDO LAWRENCE BERKELEY NATIONAL LABORATORY

Behavior of Two Capstone 30kW Microturbines Operating in Parallel with Impedance Between Them

Prepared by

Robert J. Yinger
Southern California Edison
Rosemead, California
For
CERTS

Energy Analysis Department
Ernest Orlando Lawrence Berkeley National Laboratory
University of California Berkeley
Berkeley, California 94720

Environmental Energy
Technologies Division

July 2004

**Funded by the California Energy Commission, Public Interest Energy Research
Program**

http://eetd.lbl.gov/ea/EMS/EMS_pubs.html

The work described in this report was coordinated by the Consortium for Electric Reliability Technology Solutions and funded by the California Energy Commission, Public Interest Energy Research Program, under Work for Others Contract No. 150-99-003 and by the U.S. Department of Energy under Contract No. DE-AC03-76SF00098.

Disclaimer

This document was prepared as an account of work sponsored by the United States Government. While this document is believed to contain correct information, neither the United States Government nor any agency thereof, nor The Regents of the University of California, nor any of their employees, makes any warranty, express or implied, or assumes any legal responsibility for the accuracy, completeness, or usefulness of any information, apparatus, product, or process disclosed, or represents that its use would not infringe privately owned rights. Reference herein to any specific commercial product, process, or service by its trade name, trademark, manufacturer, or otherwise, does not necessarily constitute or imply its endorsement, recommendation, or favoring by the United States Government or any agency thereof, or The Regents of the University of California. The views and opinions of authors expressed herein do not necessarily state or reflect those of the United States Government or any agency thereof, or The Regents of the University of California.

Ernest Orlando Lawrence Berkeley National Laboratory is an equal opportunity employer.

LBNL-55907

Behavior of Two Capstone 30 kW Microturbines Operating in Parallel with Impedance Between Them

Prepared by
Robert J. Yinger
Southern California Edison
Rosemead, California
For
CERTS

July 2004

The work described in this report was coordinated by the Consortium for Electric Reliability Technology Solutions and funded by the California Energy Commission, Public Interest Energy Research Program, under Work for Others Contract No. 150-99-003 and by U.S. Department of Energy under Contract No. DE-AC03-76SF00098.

Table of Contents

List of Tables & Figures	iii
Executive Summary	iv
1. Introduction	1
2. Test Setup and Procedures	1
2.1 Test Site and Layout	1
2.2 Test Equipment and Data Collection	3
2.3 Test Sequence #1 – Operation of Microturbines and Load Banks with Impedance Between Them	4
2.4 Test Sequence #2 – Operation of Microturbines and Load Banks with Impedance Between Them in Load Following Mode	5
2.5 Data Reduction.....	7
3. Data Analysis for each test	7
3.1 Parallel Tests Without Use of Load Following Mode	7
3.2 Parallel Tests With Use of Load Following Mode	8
4. Discussion and Conclusions	13
Appendix A – Capstone-Capstone Tests without Load Following – 3/23/2004	14
Appendix B – Capstone-Capstone Tests with Load Following – 3/25/2004	20

List of Figures

Figure 1 - Capstone - Capstone Parallel Test Equipment Layout.....	2
Figure 2 - Test Site Pictures (Capstone microturbines and Avtron load banks).....	2
Figure 3 - Test Site Pictures (Landis+Gyr meter; cable for impedance)	3
Figure 4 - Natural Gas Fuel Pod	3
Figure 5 - Load Changes from 5 to 10 kW and 10 to 15 kW with Meter Setpoint at 5 kW.....	11
Figure 6 - Meter Setpoint Changes from 10 to 15 kW and 15 to 19 kW with Constant Load	11
Figure 7 - Changes from 19 to 15 kW and 15 to 10 kW with Meter Setpoint at 15 kW	12
Figure 8 – Set-point Changes from 10 to 5 kW and Load Change from 15 to 10 kW	12

List of Tables

Table 1 – Power Quality Monitor Setup (BMI 7100 and Dranetz-BMI Power Platform 4300)	4
Table 2 - Test Settings for Load Banks and Microturbines without Load Following	5
Table 3 - Load Following Settings for Grid-connect Microturbine.....	6
Table 4 - Test Settings for Load Banks and Microturbines with Load Following	7
Table 5 - Voltage Drop between SA Microturbine Terminals and GC Microturbine Terminals at Highest Loadings without Load Following	7
Table 6 - Observed Harmonics During Testing without Load Following	8
Table 7 - Voltage Drop between SA Microturbine Terminals and GC Microturbine Terminals at Highest Loadings with Load Following	9
Table 8 - Observed Harmonics During Testing with Load Following	9
Table 9 - Variation of Power Meter Reading as Reported by the Grid-connect Microturbine in Load Following Mode.....	10

Executive Summary

Project Overview

This report describes the tests conducted to determine the behavior of two Capstone 30 kW microturbines connected in parallel with some impedance between them. This test was meant to simulate the operation of two microturbines at nearby customer facilities. This arrangement also constitutes a simple microgrid. The goal of this test was to investigate if any voltage and power instabilities exist between the two microturbines.

Approach

Two test sequences were conducted. The first test sequence operated two microturbine/ load bank pairs using manual control of the microturbine and load bank setpoints. The second test sequence used the Capstone Load Following mode of operation to control generation levels of one of the microturbines. The two microturbine/ load bank sets were connected together through a 300 foot long, four conductor, #12 cable so that the impedance between them would cause up to a 5% voltage drop (depending on the load balance between the two sets). Data was collected from both Capstone microturbines, two power quality instruments and a power monitor.

Results

The tests showed there were no instabilities in the microturbines' voltage or power output as long as care was taken not to overload either unit. A voltage drop of almost 5% was observed between the two microturbines at the highest loadings. This "soft" connection between the two microturbines did not cause problems. Basic protective functions of the microturbines avoided unintentional islanded operation, but probably would not be sufficient or desirable for normal microgrid operations.

Some simple automatic load sharing could be accomplished by using the Load Following mode of operation of the microturbine. This ability was demonstrated during the second set of tests. Load sharing works as long as all loads are kept within operating limits of the two microturbines. Use of the load following mode of the microturbine seemed to work fairly well. To improve the responsiveness of the load following, a faster pulse rate would need to be obtained from the kilowatt-hour meter for the expected loads. The faster pulse rate would allow a shorter averaging period in the microturbine which would make it respond more quickly.

Revision of the microturbine operating software would be desirable so that both microturbines could share load and voltage regulation duties in the microgrid. Once these abilities were integrated into the microturbines, the functions would need to be verified in a set of lab tests and then checked in actual field operations. Additional protection functions would also need to be integrated into the microgrid so that a fault on the microgrid would not drop all load and generation.

1. Introduction

Tests to determine the behavior of two microturbines running in parallel were performed under CERTS (Consortium for Electricity Reliability Technology Solutions) funding in 2001. A report describing the results of these tests “Behavior of Capstone and Honeywell Microturbine Generators during Load Changes” was published by Lawrence Berkeley National Laboratory (LBNL-49095) in July 2001 for CERTS. In these tests, two microturbines were run in parallel with very little impedance between them. The test was first performed for two Capstone 30 kW microturbines in parallel and then one Capstone 30 kW microturbine and one Honeywell 75 kW microturbine running in parallel. No unstable operations were observed as part of any of these tests.

This report describes a second set of tests to look at parallel operation of two microturbines when there was sufficient impedance between them to give a 4% - 5% voltage drop at full load operation. This is to simulate the behavior of microturbines being operated by neighboring customers at the same time. Two tests were conducted for this report. The first test operated two microturbine/ load bank pairs using manual control of the microturbine and load bank setpoints. The second test used the Capstone Load Following mode of operation to control the generation level of one microturbine.

2. Test Setup and Procedures

2.1 Test Site and Layout

The testing was conducted at the Southern California Edison Electric Vehicle Technology Center located in Pomona, CA. This facility is used by Edison to perform research and maintenance of electric vehicles and batteries. The site was chosen because of available space, personnel to help with testing, and access to electrical test equipment. The actual testing was conducted on March 23 – 25, 2004.

Both tests were conducted using two Capstone 30 kW microturbines, one operating in stand-alone (SA) mode and the other operating in grid-connect (GC) mode. These tests were conducted completely isolated from the electrical grid so that voltage would only be controlled by the microturbine. The SA microturbine was used to control frequency and voltage. The GC microturbine injected current into the test system and followed the frequency and voltage established by the SA microturbine. Two sets of Avtron load banks were used to simulate customer loads. Each microturbine had one 55 kW and one 42.5 kVAR load bank attached directly to it. The two microturbine/ load bank sets were connected together through a 300 foot long, four conductor, #12 cable so that the impedance between them would cause up to a 5% voltage drop (depending on the load balance between the two sets). A 16S Landis+Gyr AXRS4 electronic kilowatt-hour meter was used to generate pulse outputs for the load following tests. The meter pulse output was connected to the GC microturbine for Load Following tests. See Figure 1, 2 and 3, below, for the test equipment layout and pictures.

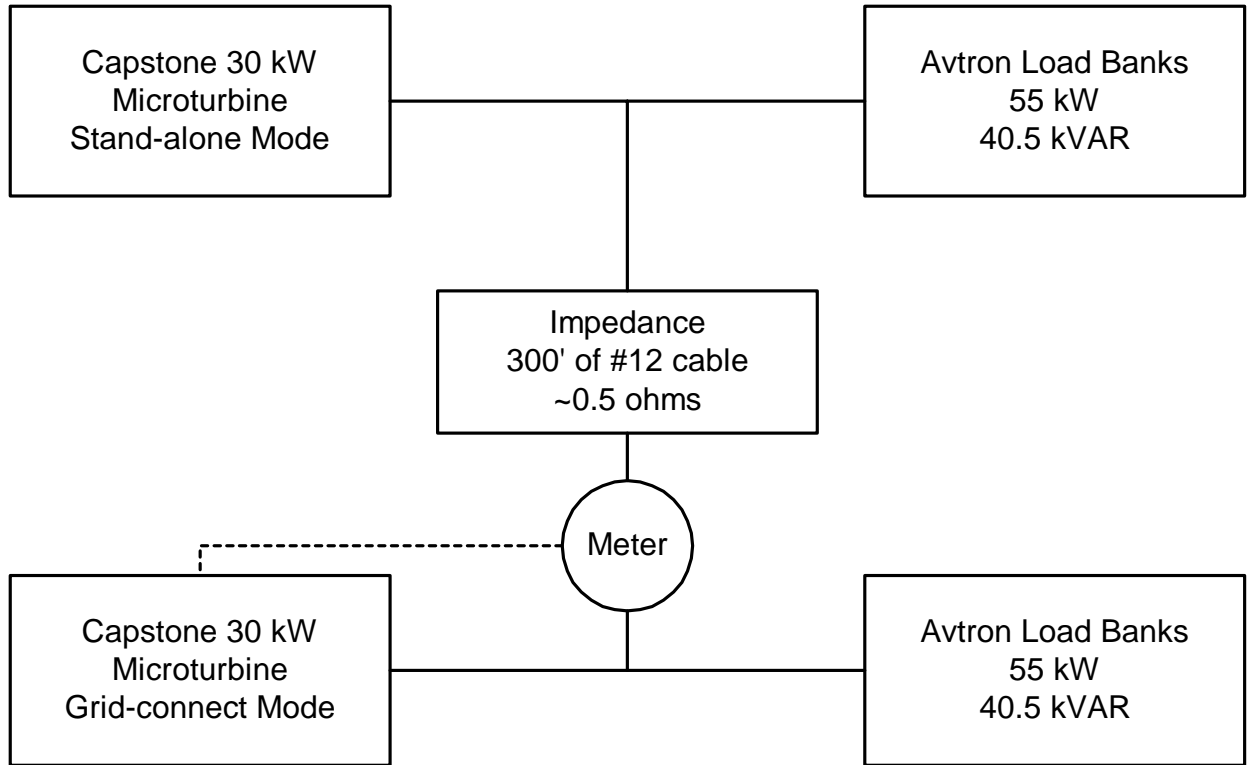

Figure 1 - Capstone - Capstone Parallel Test Equipment Layout



Figure 2 - Test Site Pictures (Capstone microturbines and Avtron load banks)



Figure 3 - Test Site Pictures (Landis+Gyr meter; cable for impedance)

Since the Electric Vehicle Technology Center does not have a permanent supply of natural gas, a natural gas fuel pod was obtained from the local gas company and its pressures were regulated down as required by the microturbines (Figure 4). This fuel pod was capable of operating the pair of microturbines at full load for about 7 hours.

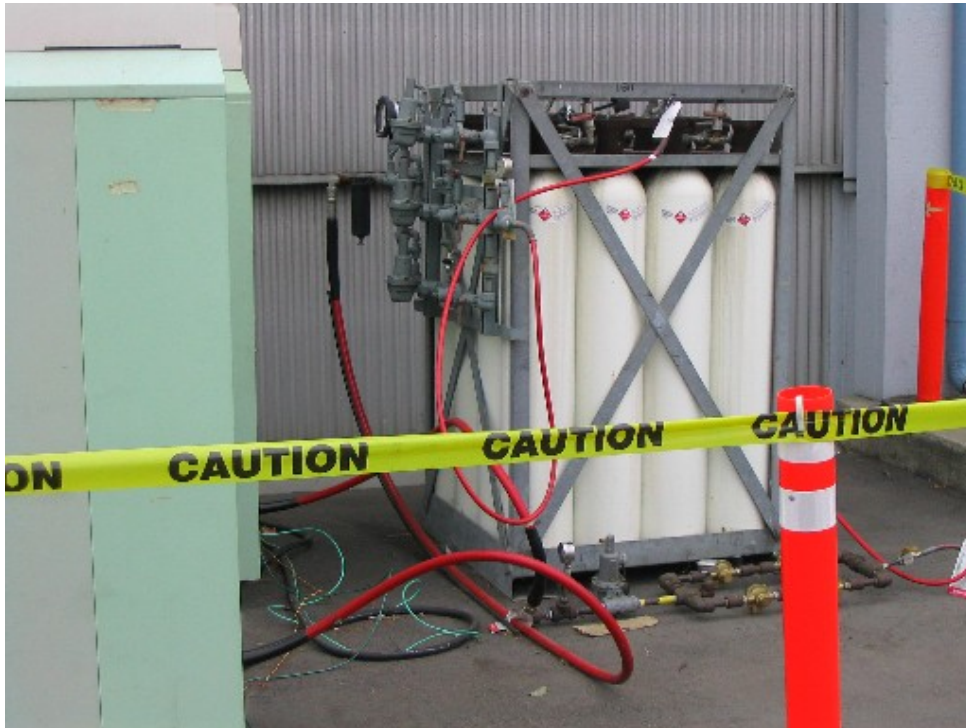

Figure 4 - Natural Gas Fuel Pod

2.2 Test Equipment and Data Collection

Electrical and performance data was collected from several sources during the course of the two tests. Capstone microturbine data was collected from each unit through the use of the Capstone

CRMS software running on laptop computers. The Capstone software is capable of recording data every 2 seconds and includes both electrical and machine operations data. In addition to this internal data from each microturbine, power quality data was also collected at each microturbine through the use of a BMI 7100 (at the GC microturbine) and a Dranetz-BMI Power Platform 4300 power quality monitor (at the SA microturbine). The BMI 7100 was capable of collecting data once every minute and the Dranetz-BMI Power Platform 4300 was set to collect data every 20 seconds. This power quality data consisted of harmonics, voltage, current, power and reactive power. These instruments were also programmed to look for electrical disturbance on the voltage and current waveforms. The settings used for disturbance detection are listed in Table 1.

Parameter	Limits	Other Setup Information
RMS Disturbance	+5% (291 volts L-N) -5% (263 volts L-N)	Sample interval – 1 cycle Sample duration – 200 cycles 5 cycles to trigger 5 cycles to end
Waveshape Fault	5 volt deviation for 50% of the cycle	Store 1 cycle before fault and 1 cycle after fault
Impulse Fault	+10% (305 volts L-N)	Store 1 cycle before fault and 1 cycle after fault

Table 1 – Power Quality Monitor Setup (BMI 7100 and Dranetz-BMI Power Platform 4300)

One additional piece of monitoring equipment, an Amprobe DMII, was installed in the impedance link between the two sets of microturbine/ load banks. This instrument is capable of recording 1 second electrical data (voltage, current, power, and reactive power). It was located at the end of the link closest to the GC microturbine and served as an additional voltage monitoring check point for the GC turbine data.

2.3 Test Sequence #1 – Operation of Microturbines and Load Banks with Impedance Between Them

The SA microturbine was started and allowed to proceed through warmup. Initial loading on this microturbine was set to 10 kW at the load banks. Once this turbine was online and feeding the load banks, a second 10 kW was added. Then the GC microturbine was started and also allowed to proceed through warm-up and ramp generation to a 10 kW set-point. Various combinations of load and generation set-points were tested and data recorded at least 3 minutes for each setpoint/ load combination. Once at maximum loads, the process was reversed until the turbines were shutdown. When testing was finished, data was downloaded from the Amprobe, BMI, Dranetz-BMI, and data collection stopped at each Capstone microturbine. For the combinations tested, see Table 2 below.

Actual Step Start Time PST (hh:mm:ss)	Stand-alone MTG (kW/ kVAR)	Stand-alone Load Banks (kW/ kVAR)	Grid-connect MTG (kW/ kVAR)	Grid-connect Load Banks (kW/ kVAR)	Predicted Voltage Drop (percent)
	Start to 10/0	10/0	0/0	0/0	0
11:28:31	20/0	10/0	0/0	10/0	2.2
11:31:00	10/0	10/0	Start to 10/0	10/0	0
11:34:00	20/0	10/0	10/0	20/0	2.2
11:37:28	10/0	10/0	20/0	20/0	0
11:40:50	20/0	10/0	20/0	30/0	2.2
11:44:05	15/0	5/0	20/0	30/0	2.2
11:47:30	20/0	5/0	20/0	35/0	3.2
11:51:00	25/0	5/0	20/0	40/0	4.3
11:54:15	20/0	5/0	20/0	35/0	3.2
11:58:00	20/6	5/0	20/0	35/6	3.5
12:02:30	20/9	5/0	20/0	35/9	3.8
12:06:00	20/15	5/0	20/0	35/15	4.6
12:09:30	20/21	5/6	20/0	35/15	4.6
12:14:30	20/15	5/0	20/0	35/15	4.6
12:18:00	20/0	5/0	20/0	35/0	3.2
12:21:30	15/0	5/0	20/0	30/0	2.2
12:25:00	20/0	10/0	20/0	30/0	2.2
12:28:30	10/0	10/0	20/0	20/0	0
12:32:00	20/0	10/0	10/0	20/0	2.2
12:35:00	10/0	10/0	10/0	10/0	0
12:38:00	20/0	10/0	10/0 to Shutdown	10/0	2.2
12:48:00	20/0 to Shutdown	10/0	0/0	10/0	2.2

Table 2 - Test Settings for Load Banks and Microturbines without Load Following

2.4 Test Sequence #2 – Operation of Microturbines and Load Banks with Impedance Between Them in Load Following Mode

Before any testing in the Load Following mode using the kilowatt-hour meter was initiated, configuration of this mode needed to be done in the GC microturbine. Following the instructions from the Capstone manual for the Load Following mode, values were chosen for the test (see Table 3). The microturbines were then started and a few simple tests of the Load Following mode were done. During these tests it was discovered that the pulse rate input to the turbine was giving a reading of twice the value expected to the microturbine. The watt-hour per pulse constant was changed from the original 7.2 to 3.6. It appears that the microturbine, which used a 2 wire pulse input, counts both the rising and falling edges of each pulse rather than only the rising pulse as expected. Once this change was made, the correct load reading was observed at the microturbine. When the GC microturbine was put in Load Following mode, it proceeded to

ramp up to full load and then trip on overload. After some investigation, it was learned that the averaging interval for the meter needed to be changed to a shorter interval (10 seconds). It was also discovered that the Load Following mode did not work when the Utility Power Setting was set to zero. When these changes were completed, the Load Following mode began to work as expected as long as load step changes were limited to 5 kW steps.

Load Management Menu Parameter	Initial Setting	Final Setting
Mode	Load Following	Load Following
Reverse Power Settings	Disabled/ 120 seconds	Disabled/ 120 seconds
Utility Power Setting	Varied during tests	Varied during tests
Meter Averaging Response	30 seconds	10 seconds
Minimum Power Shutoff	N/A	N/A
Meter Scaling Constant	7.2 watt-hour/ pulse	3.6 watt-hour/ pulse

Table 3 - Load Following Settings for Grid-connect Microturbine

Once the Load Following mode was properly setup, everything was ready for the actual test. The SA microturbine was started and allowed to proceed through warmup. The initial load bank setting was 10 kW with a second 10 kW added after warmup. The GC microturbine was next started and also allowed to proceed through warmup and ramp generation to the Load Following setpoint of 5 kW. Various combinations of load and Load Following setpoints were tested and data recorded at least 3 minutes for each setpoint/ load combination. Once at maximum loads, the process was reversed until the turbines were shutdown. When testing was finished, data was downloaded from the Amprobe, BMI, Dranetz-BMI, and data collection stopped at each Capstone microturbine. For the combinations tested, see Table 4 below.

Actual Step Start Time PST (hh:mm:ss)	Stand-alone MTG (kW/ kVAR)	SA Load Banks (kW/ kVAR)	Grid-connect MTG (kW/ kVAR)	GC Load Banks (kW/ kVAR)	Load Following Meter Setpoint (kW)	Predicted Voltage Drop (percent)
9:47:46	Start to 20/0	10/0	N/A	10/0	N/A	2.2
9:50:00	15/0	10/0	Start to 5/0	10/0	5	0
9:58:00	15/0	10/0	10/0	15/0	5	1.1
10:02:00	15/0	10/0	15/0	20/0	5	1.1
10:06:00	20/0	10/0	10/0	20/0	10	2.2
10:10:30	20/0	10/0	15/0	25/0	10	2.2
10:15:00	20/0	10/0	20/0	30/0	10	2.2
10:20:00	15/0	5/0	20/0	30/0	10	2.2
10:23:00	20/0	5/0	15/0	30/0	15	3.2
10:27:00	24/0	5/0	10/0	30/0	19	4.3
10:31:00	20/0	5/0	15/0	30/0	15	3.2
10:35:30	20/0	5/0	20/0	35/0	15	3.2
10:39:00	20/6	5/0	20/0	35/6	15	3.5
10:42:00	20/15	5/0	20/0	35/15	15	4.6

10:45:00	20/0	5/0	20/0	35/0	15	3.2
10:48:00	20/0	5/0	15/0	30/0	15	3.2
10:51:00	20/0	5/0	10/0	25/0	15	3.2
10:54:00	15/0	5/0	15/0	25/0	10	2.2
10:57:00	15/0	5/0	10/0	20/0	10	2.2
11:00:00	20/0	10/0	10/0	20/0	10	2.2
11:03:00	15/0	10/0	15/0	20/0	5	1.1
11:06:00	15/0	10/0	10/0	15/0	5	1.1
11:09:00	15/0	10/0	5/0	10/0	5	1.1
11:13:00	20/0	10/0	5/0 to Shutdown	10/0	5	2.2
11:23:00	20/0 to Shutdown	10/0	N/A	10/0	N/A	2.2

Table 4 - Test Settings for Load Banks and Microturbines with Load Following

2.5 Data Reduction

Since the data was collected from several types of instrumentation, the data reduction process needed to align the times from all the data streams. The finest data resolution was 1 second from the Amprobe DMII. All other data streams were matched with the Amprobe with spaces inserted where there were no data values. At the beginning of the tests, all data recording instrument clocks were aligned as best as possible. Some minor time shifting of the data (1 to 4 seconds) was still required during the final analyses. These modified spreadsheets were used for the analysis and generation of graphs.

3. Data Analysis for each test

3.1 Parallel Tests Without Use of Load Following Mode

The voltage data from the test was examined to determine the extent of the voltage drop between the SA microturbine (used to establish voltage and frequency) and the GC microturbine. The highest voltage drop (4.6% at 265.2 volts) between the microturbines was when the link power was at 17.9 kW and -2.0 kVAR (see Table 5). The other high load point was with 13.1 kW and 12.4 kVAR passing through the link. This produced similar low voltage at the GC microturbine (265.6 volts) but with a lower percent voltage drop (3.7%). This difference in percent voltage drop is due to voltage droop at the SA microturbine when reactive loads were applied.

Link kW/kVAR	Link Current (A)	Stand-alone MTG Voltage	Grid-connect MTG Voltage	Voltage Drop	Percent Voltage Drop
17.9/-2.0	23.7	278.0	265.2	12.8	4.6
13.1/12.4	23.2	275.7	265.6	10.1	3.7

Table 5 - Voltage Drop between SA Microturbine Terminals and GC Microturbine Terminals at Highest Loadings without Load Following

There was a 7 volt difference between the phase A voltage reading taken from the GC microturbine and the voltage reading taken from the PQ monitor connected to the microturbine output terminals. Since the other two microturbine phase voltages agreed well with the PQ monitor and the Amprobe DMII, it was assumed there was a voltage calibration problem with phase A voltage from the microturbine. It was also noted that the voltage readings from the SA microturbine agreed well with the PQ monitor connected to its output terminals while its output power factor was near unity. When the SA microturbine was called upon to produce reactive power, its terminal voltage dropped according to data from the PQ monitor. This voltage drop was not reported by the SA microturbine internal monitoring.

Harmonic snapshots were taken at both microturbines throughout the testing (Table 6). Examination of the voltage and current power quality readings taken at the SA microturbine agreed with others taken in the past. The harmonics at the GC microturbine were higher than had been observed in the past. These higher harmonics seemed to be caused by the presence of high neutral-to-ground voltages and currents at the microturbines. Since the ground-neutral connection was made close to the SA microturbine, the impedance between the two microturbines could have caused a voltage difference between the ground and neutral at the GC microturbine. Detailed harmonics graphs are included in Appendix A.

SA Microturbine		GC Microturbine	
$V_{THD}\%$	$I_{TDD}\%$ at peak load	$V_{THD}\%$	$I_{TDD}\%$ at peak load
1.67	3.44	3.56	19.9

Table 6 - Observed Harmonics During Testing without Load Following

Observations of the voltage, current and power at these high voltage drop conditions and at lower voltage drop conditions did not show any instabilities at either microturbine. Load changes by the SA microturbine took place in under 1 second. Load changes at the GC microturbine took place in 25 to 30 seconds which is consistent with other tests in the past. Detailed graphs showing voltage, current, real power and reactive power are included as Appendix A.

3.2 Parallel Tests With Use of Load Following Mode

The Load Following mode allowed the operation of the microturbine pair without the need to control the GC microturbine set-point. Tests similar to the ones performed without the load following meter were done. The voltage data from the test was examined to determine the extent of the voltage drop between the SA microturbine (used to establish voltage and frequency) and the GC microturbine. The highest voltage drop (4.9% at 264.7 volts) between the microturbines was when the link power was at 18.3 kW and -1.8 kVAR (see Table 7). The other high load point was with 14.4 kW and 12.4 kVAR passing through the link. This produced similar low voltage at the GC microturbine (265.2 volts) but with a lower percent voltage drop (4.1%). This difference in percent voltage drop is due to voltage droop at the SA microturbine when reactive loads were applied.

Link kW/kVAR	Link Current (A)	Stand-alone MTG Voltage	Grid-connect MTG Voltage	Voltage Drop	Percent Voltage Drop
18.3/-1.8	23.9	278.2	264.7	13.5	4.9
14.4/12.4	24.4	276.5	265.2	11.3	4.1

Table 7 - Voltage Drop between SA Microturbine Terminals and GC Microturbine Terminals at Highest Loadings with Load Following

Again, there was a 7 volt difference between the phase A voltage reading taken from the GC microturbine and the voltage reading taken from the PQ monitor connected to the microturbine output terminals. This was attributed to a calibration problem with the phase A voltage reading in the GC microturbine. As noted in the previous tests, the voltage readings from the SA microturbine agreed well with the data from the PQ monitor connected to its output terminals while its output power factor was near unity. When the microturbine was called upon to produce reactive power, its terminal voltage dropped according to the PQ monitor. This voltage drop was not reported by the SA microturbine internal monitoring though.

Harmonic snapshots were taken at both microturbines throughout the testing (Table 8). Examination of the voltage and current power quality readings taken at the SA microturbine agreed with others taken in the past. However, the harmonics at the GC microturbine were higher than had been observed in the past. These higher harmonics seemed to be caused by the presence of high neutral-to-ground voltages and currents at the microturbines. Since the ground-neutral connection was made close to the SA microturbine, the impedance between the two microturbines could have caused a voltage difference between the ground and neutral at the GC microturbine. Detailed harmonics graphs are included in Appendix A.

Stand-alone Microturbine		Grid-connect Microturbine	
$V_{THD}\%$	$I_{TDD}\%$ at peak load	$V_{THD}\%$	$I_{TDD}\%$ at peak load
1.69	3.40	3.51	23.5

Table 8 - Observed Harmonics During Testing with Load Following

Observations of the voltage, current and power at these high voltage drop conditions and at lower voltage drop conditions did not show any instabilities at either microturbine. Load changes by the SA microturbine took place in under 1 second. Load changes at the GC microturbine took place in 25 to 30 seconds which is consistent with other tests in the past. Detailed graphs showing voltage, current, real power and reactive power are included as Appendix A.

It was interesting to observe the behavior of the Load Following mode of operation on the GC microturbine. The response of the kilowatt-hour meter readings as computed by the GC microturbine seemed to vary up and down about 1 kilowatt around the actual value as reported by the DMII power monitor. The period of this variation varied with the load flowing through the meter. Table 9 shows the power reading variation as well as its period of variation. The averaging interval programmed into the microturbine was 10 seconds. It appears that the microturbine looks at the spacing between the pulses or uses a moving average to determine the power level since the reading changed every 2 seconds.

Load Following Setpoint (kW)	Power Reading Variation at Microturbine (kW)	Period of Power Reading Variation (sec)
5	1.2	10
10	1.2	10 – 18
15	0.8 – 1.0	6
20	1.1	38 – 40

Table 9 - Variation of Power Meter Reading as Reported by the Grid-connect Microturbine in Load Following Mode

Figures 5 through 8 show the meter power readings as reported by the GC microturbine as well as the actual values recorded by the DMII power monitor during 4 snapshots from the test. Note that the meter is in the location shown in Figure 1. Also note that the meter is used with the GC microturbine in Load Following mode to allow a set power flow into the meter. This set power flow is achieved by the meter sending a pulse string to the GC microturbine. The GC microturbine measures this pulse stream and alters its output to result in the commanded power flowing through the meter. It can be noted that while the meter reading varies up and down, the turbine demand set-point and actual turbine output vary smoothly. As long as the meter reading averaging interval is small as compared to the microturbine power output change rate, there seems to be no problem with operations in the Load Following mode.

As shown in Figures 5, 7, and right part of 8, when a step load change is applied to the GC microturbine/ load bank combination the initial power change is provided by the SA microturbine. The GC microturbine then picks up the load as the kilowatt-hour meter reacts to the load change. It settles out at the new operating point based on the set-point specified in the microturbine Load Following setup. This new operating point is established in about 1.5 to 2 minutes. For changes in the Load Following meter set-point with no load bank changes (Figures 6 and left part of 8), power is gradually shifted between the microturbines. This process takes about 1.5 minutes with less overshoot than observed with the changes in load bank settings.

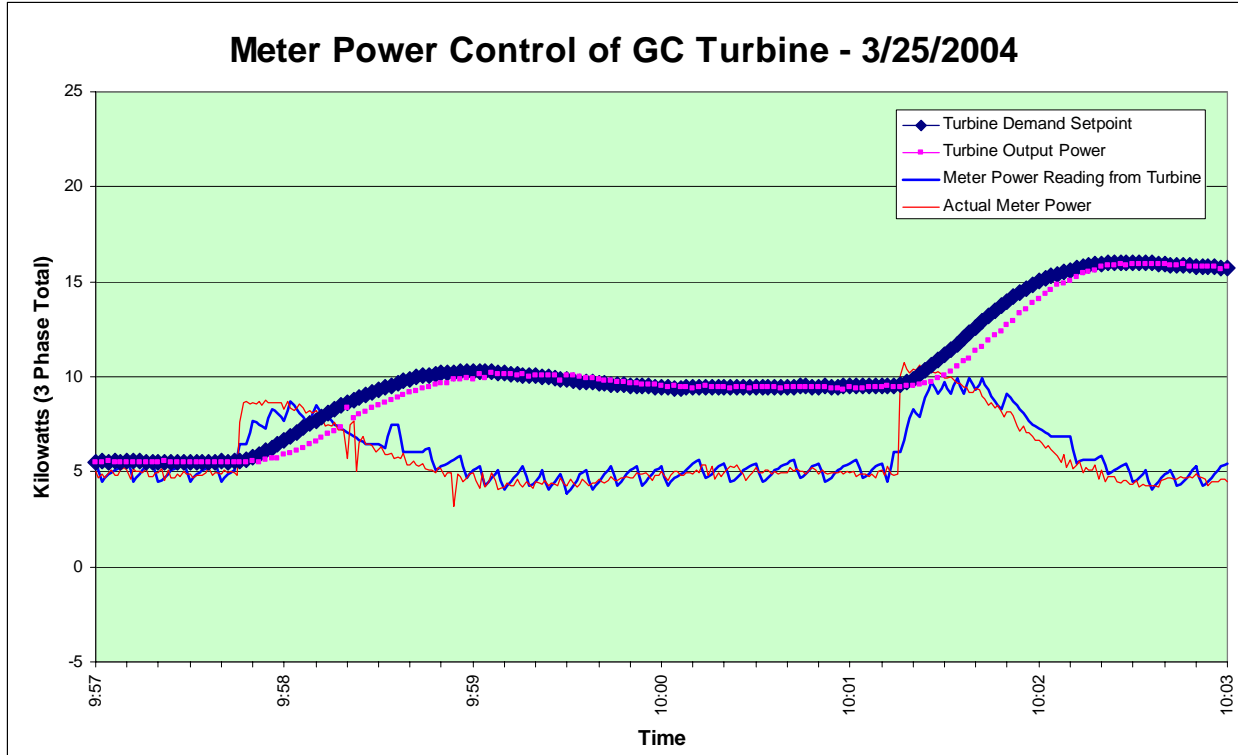

Figure 5 - Load Changes from 5 to 10 kW and 10 to 15 kW with Meter Setpoint at 5 kW

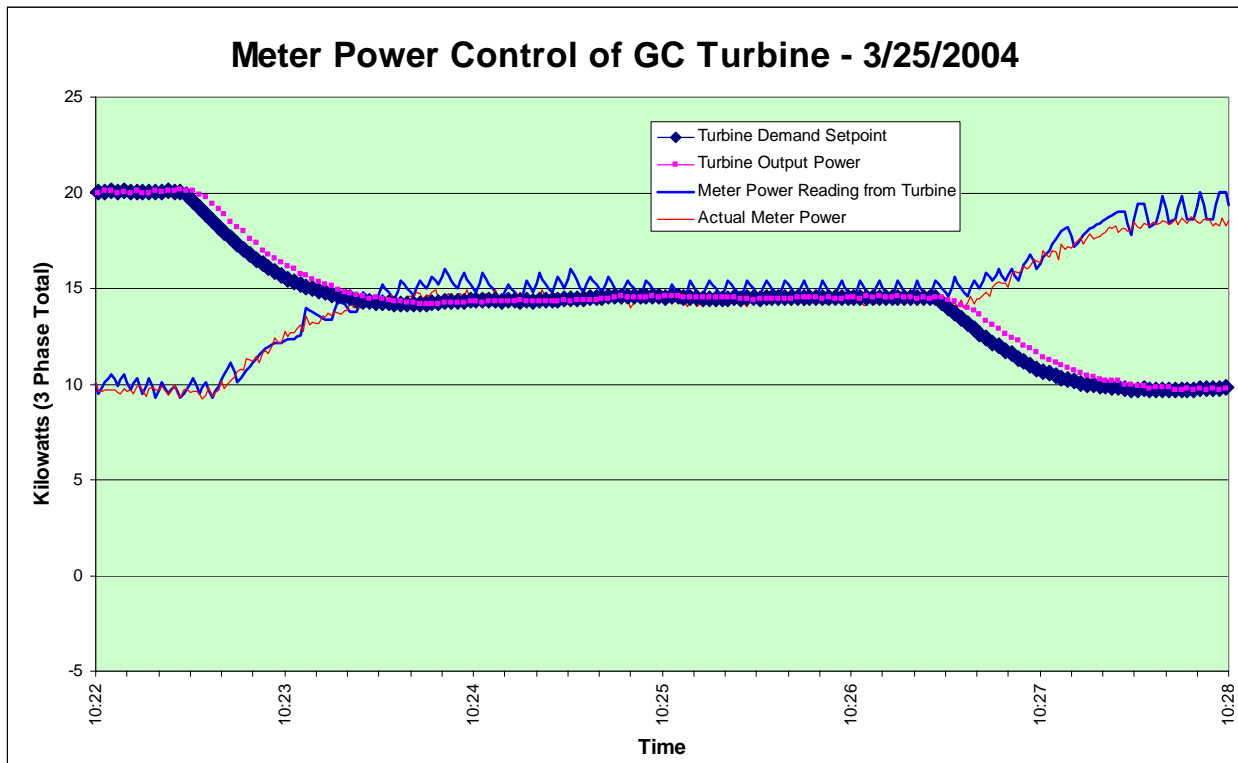

Figure 6 - Meter Set-point Changes from 10 to 15 kW and 15 to 19 kW with Constant Load

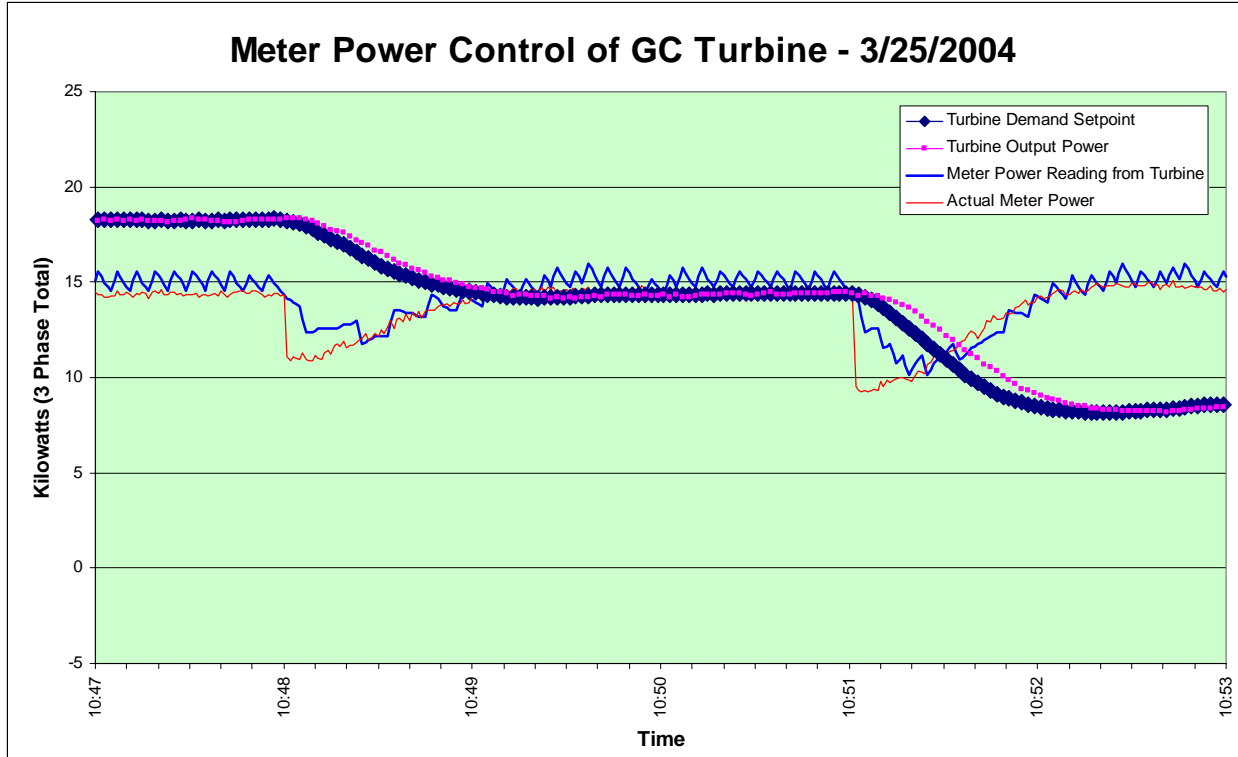

Figure 7 - Changes from 19 to 15 kW and 15 to 10 kW with Meter Set-point at 15 kW

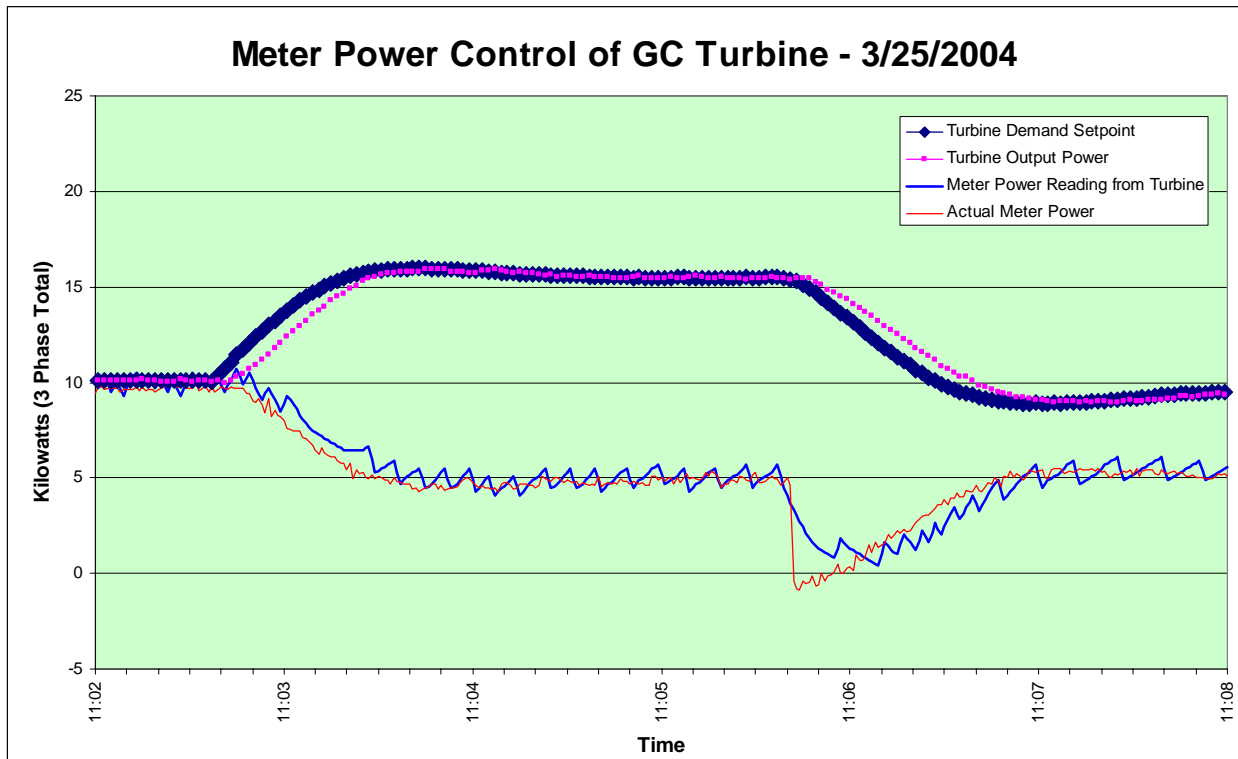

Figure 8 – Set-point Changes from 10 to 5 kW and Load Change from 15 to 10 kW

As with the earlier tests, no instabilities were observed in either microturbine for light or heavy loads.

4. Discussion and Conclusions

This sequence of tests was designed to simulate the operation of a simple microgrid made up of two microturbines with variable loads operating disconnected from the distribution utility grid. Impedance was inserted between the two microturbines to simulate a “soft” connection. These tests looked for instabilities between the two microturbines with a voltage drop of up to almost 5%. These tests, as well as the previous tests done without impedance between the sets of microturbines did not show any problem with stability of voltage or power output. This indicates there probably would not be any problems with the parallel operation of these microturbines in an actual microgrid when it was operating separate from the utility distribution system.

The tests were performed with production software running in the microturbines. This software requires that only one microturbine control voltage and frequency. Any other microturbine that is connected to the microgrid is required to operate in GC mode (feeding current only). This does not allow tests of voltage regulation from the GC microturbine. The microturbines also do not share load automatically. Any load not served by the GC microturbine must be picked up by the SA microturbine. Care needs to be taken not to overload the SA microturbine or it will trip.

Some simple automatic load sharing could be accomplished by using the Load Following mode of operation of the GC microturbine. This ability was demonstrated during the second set of tests. Load sharing works as long as all loads are kept within operating limits of the two microturbines. Use of the Load Following mode of the GC microturbine seemed to work fairly well. To improve the responsiveness of the load following, a faster pulse rate would need to be obtained from the kilowatt-hour meter. The faster pulse rate would allow a shorter averaging period in the microturbine which would make it respond more quickly.

During one of the pre-test runs, the SA microturbine was accidentally tripped. When this happened, the GC microturbine immediately tripped also. This indicates there was no problem with islanding of this microturbine under the test conditions. The under/ over voltage and frequency protections seem to be sufficient for operation with this test. The test did not experiment with faults on the parallel microturbines. Smarter protection would be needed for faults to be cleared without dropping all the generation on the microgrid.

Revision of the microturbine operating software would be desirable so that both microturbines could share load and voltage regulation duties in the microgrid. Once these abilities would be integrated into microturbines, the functions would need to be verified in a set of lab tests and then checked in actual field operations. Additional protection functions would also need to be integrated into the microgrid so that a fault on the microgrid would not drop all load and generation.

Appendix A – Capstone-Capstone Tests without Load Following – 3/23/2004

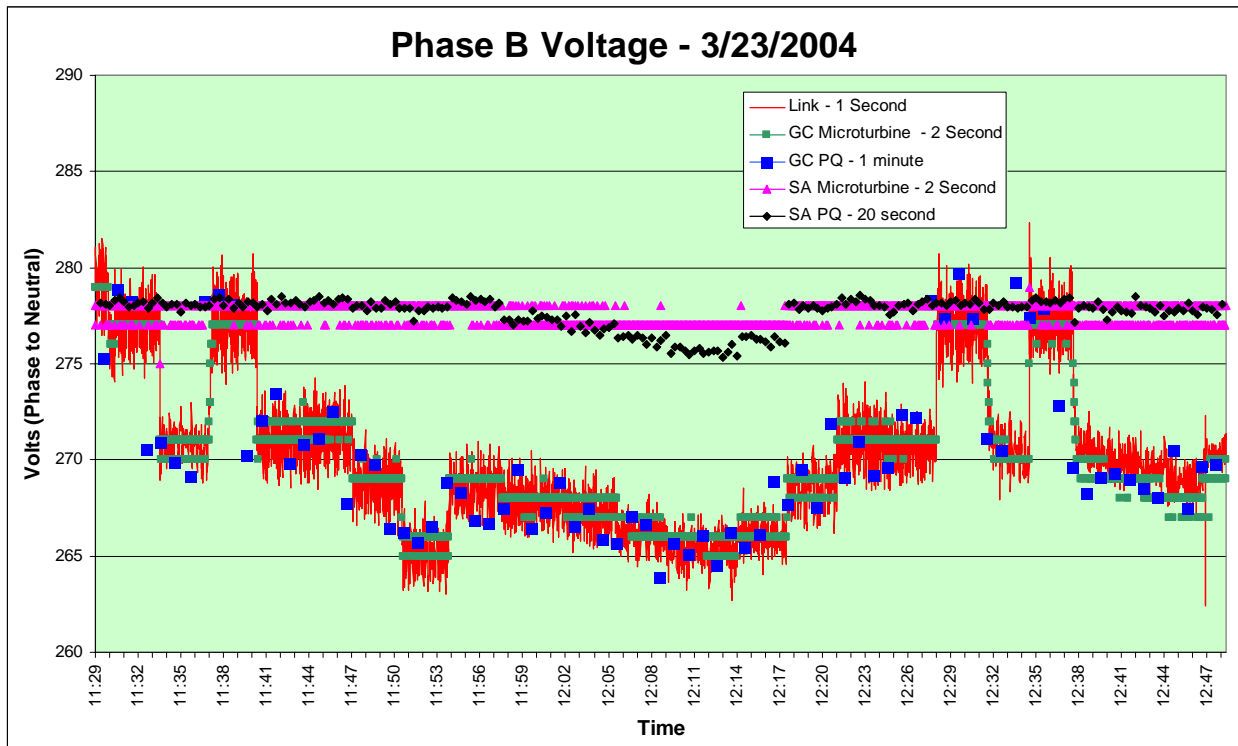
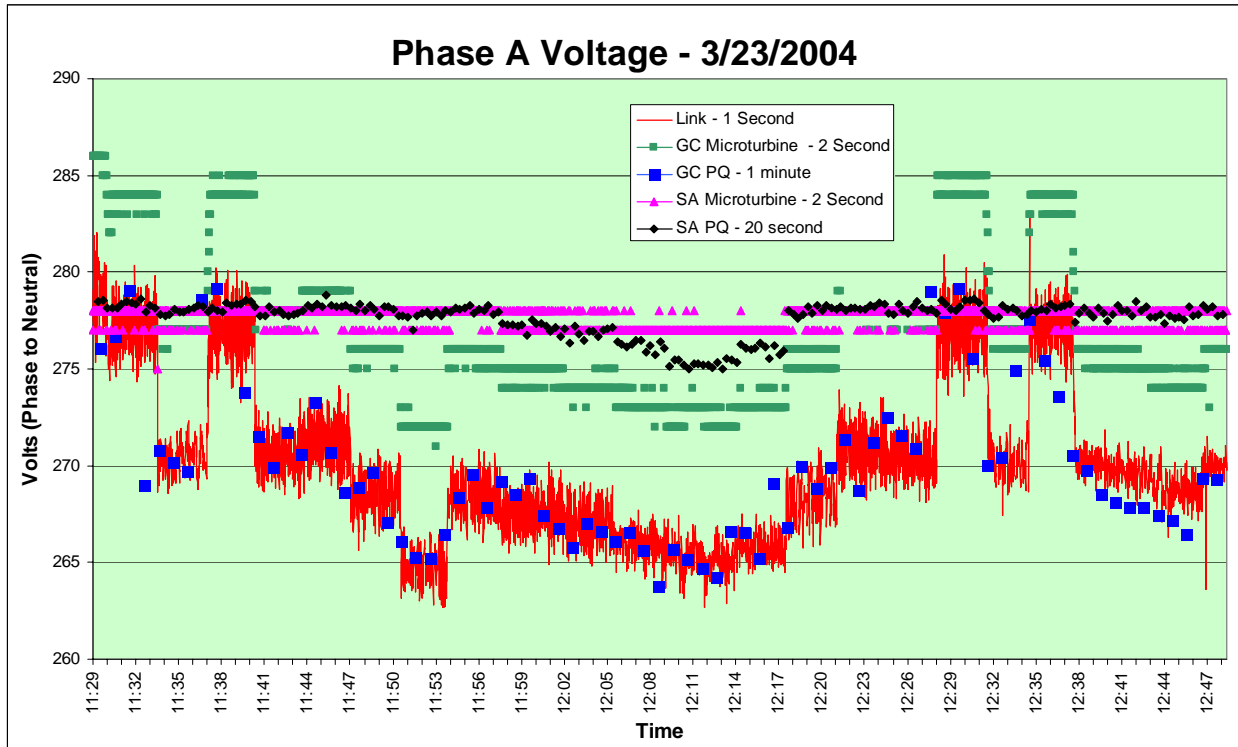

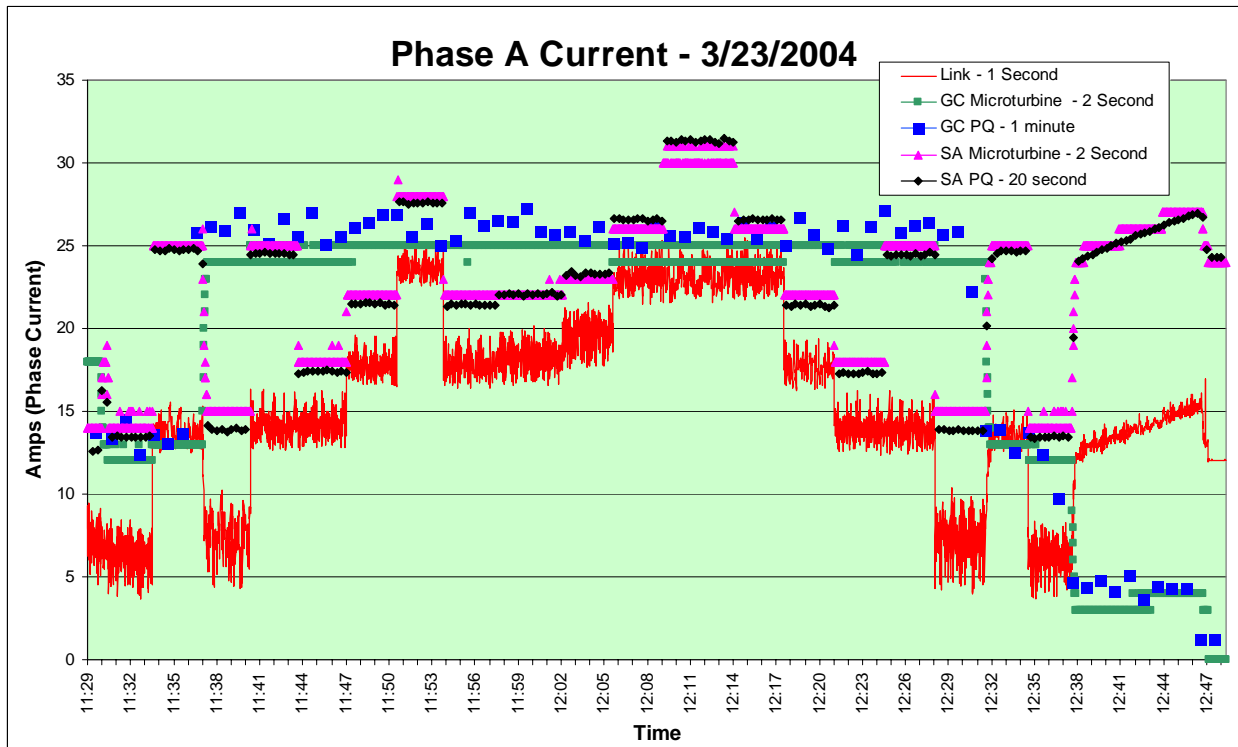
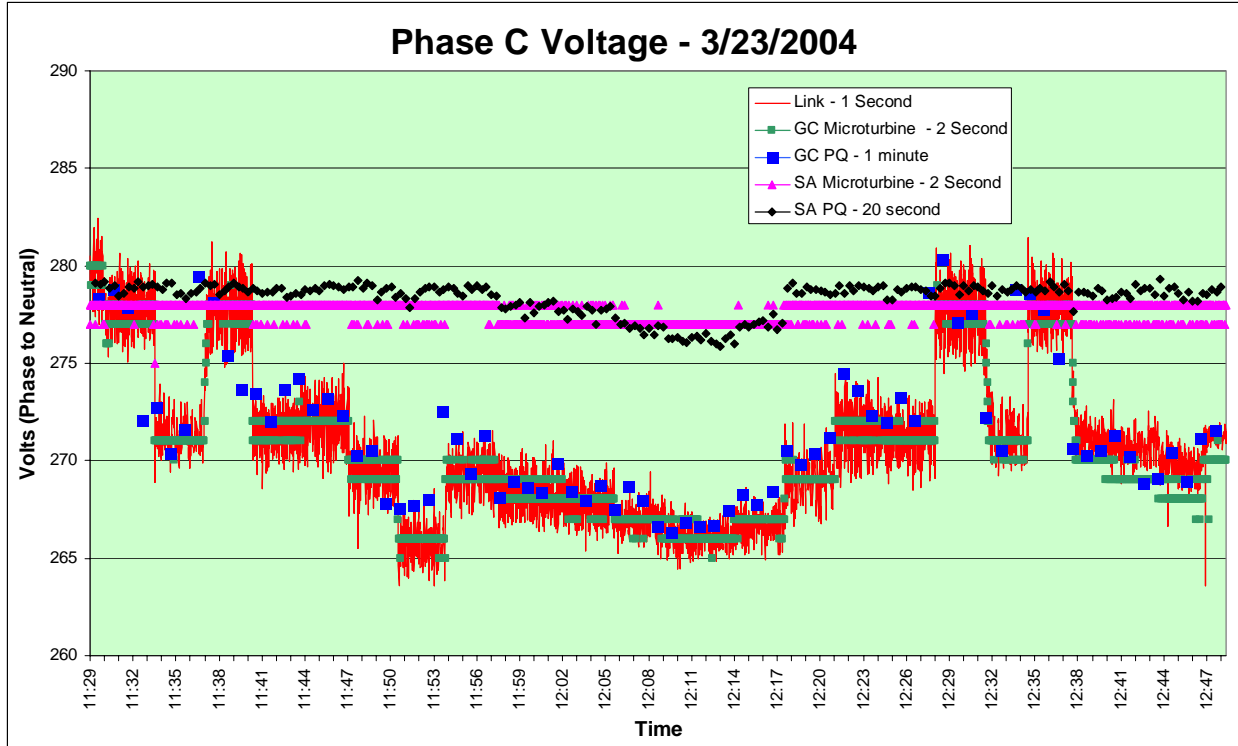

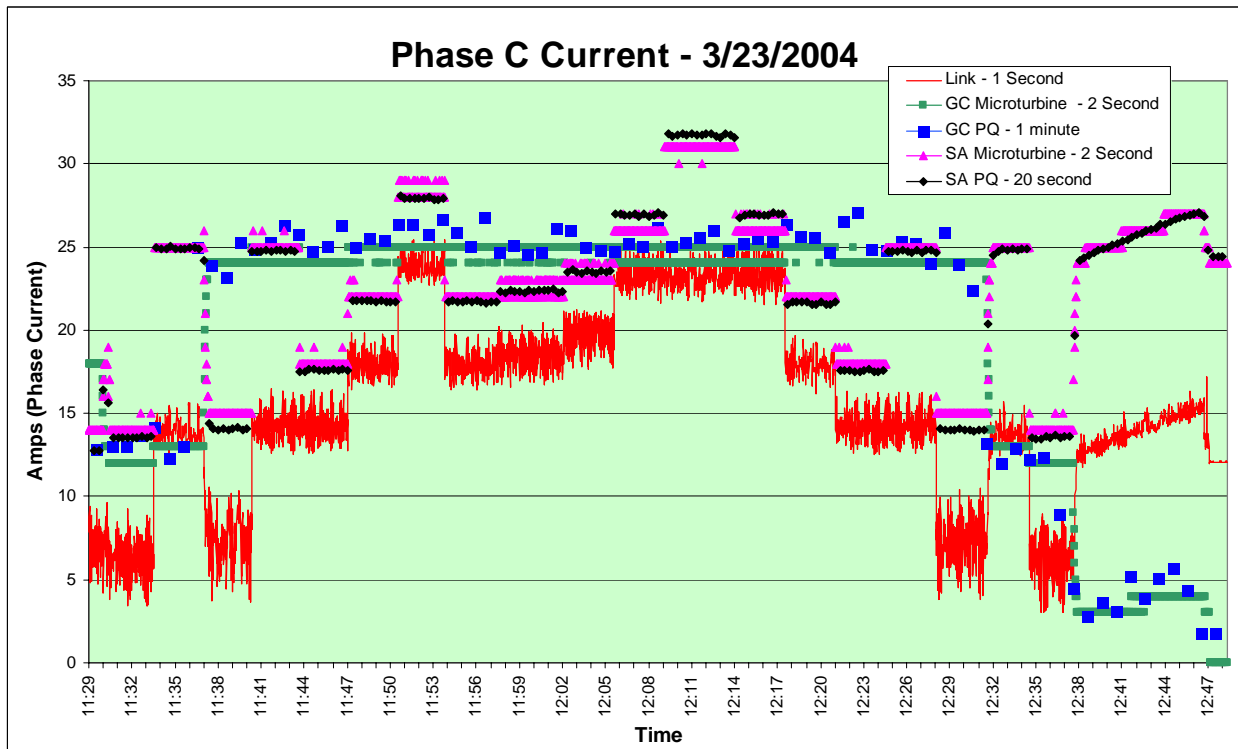
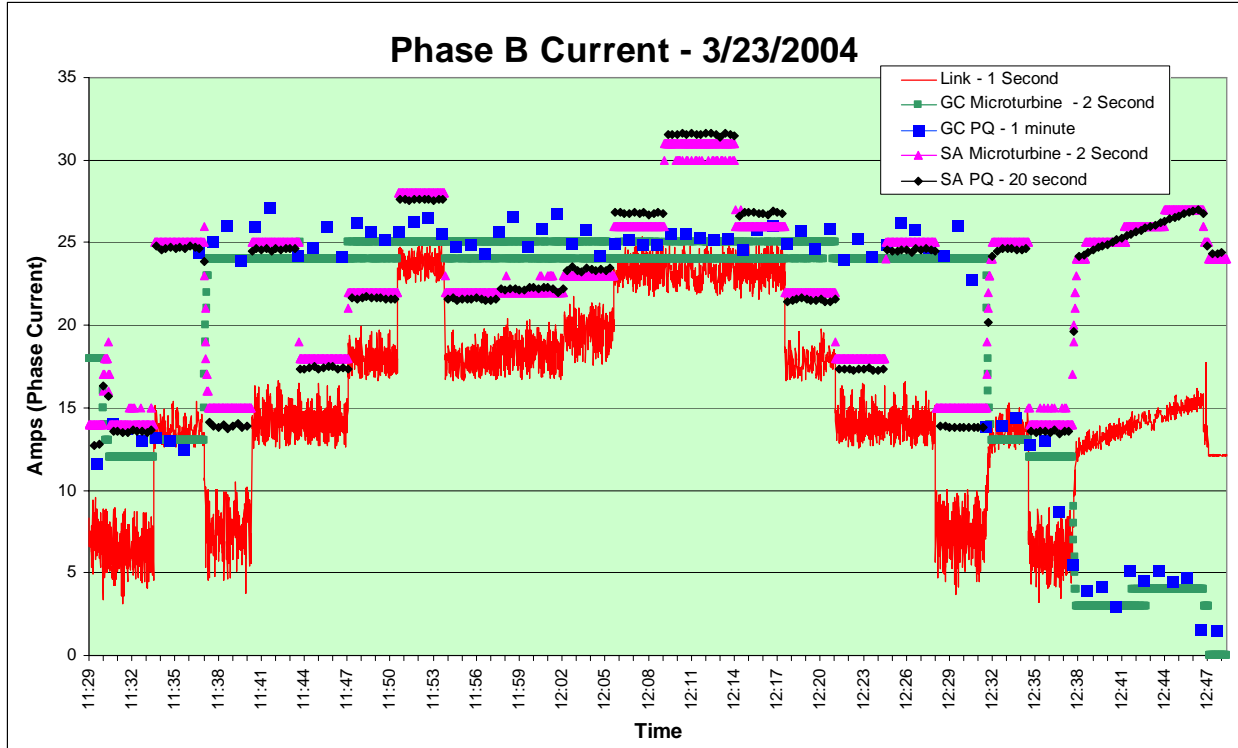

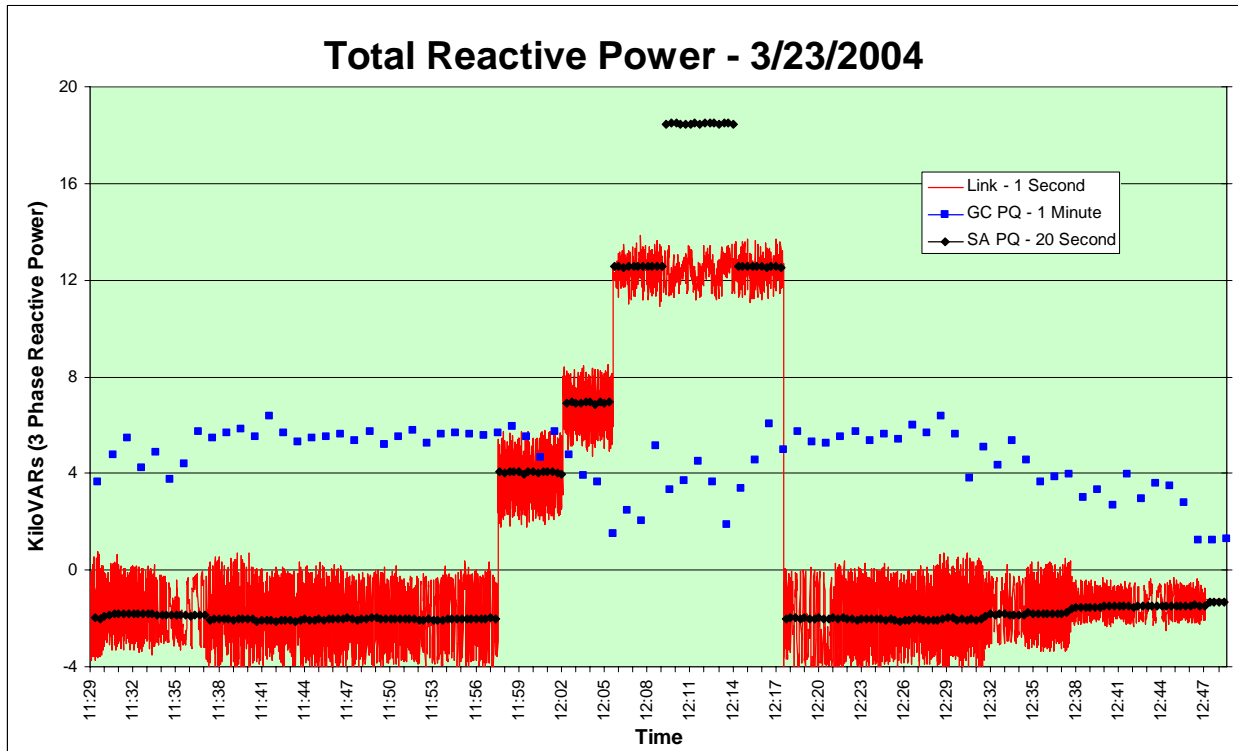
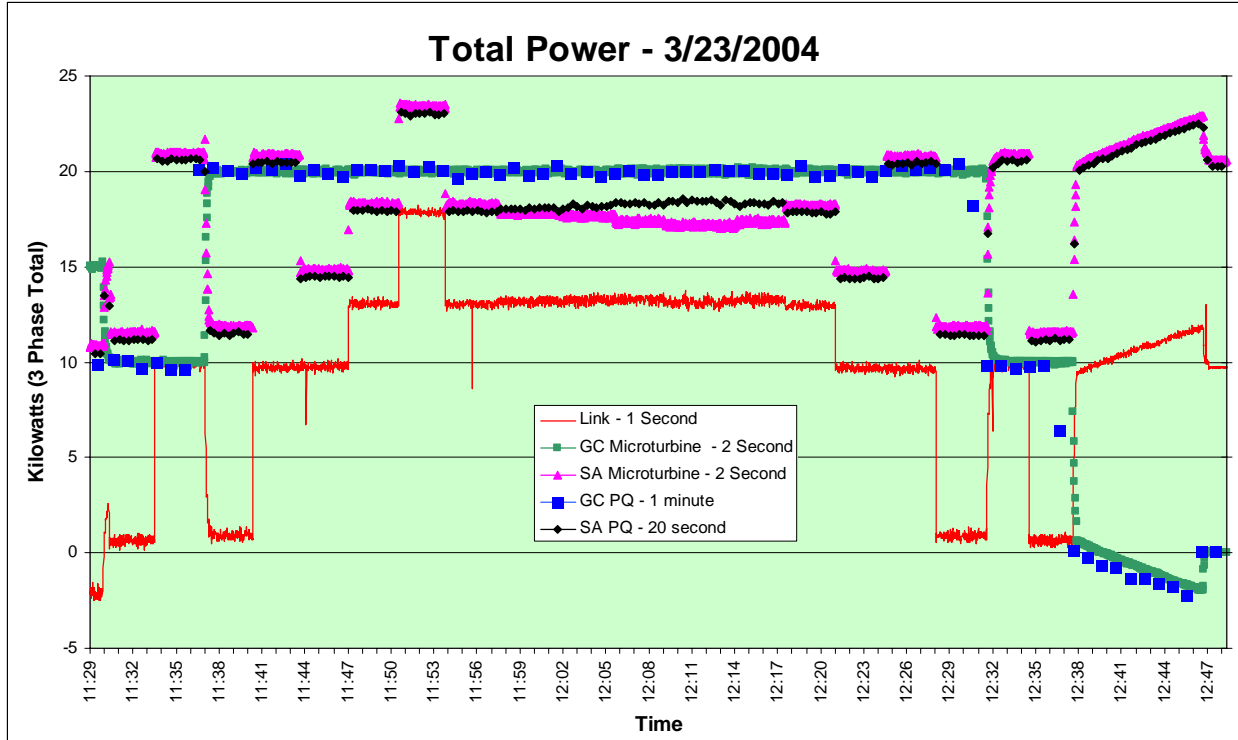

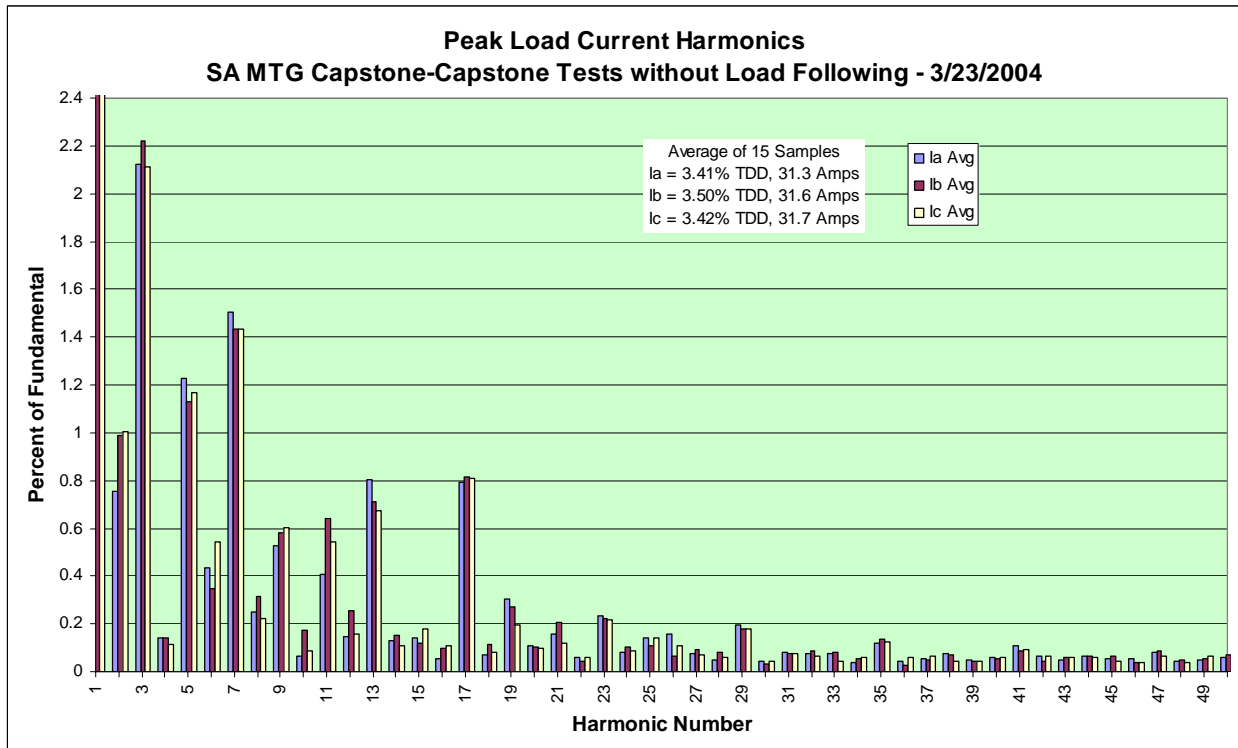
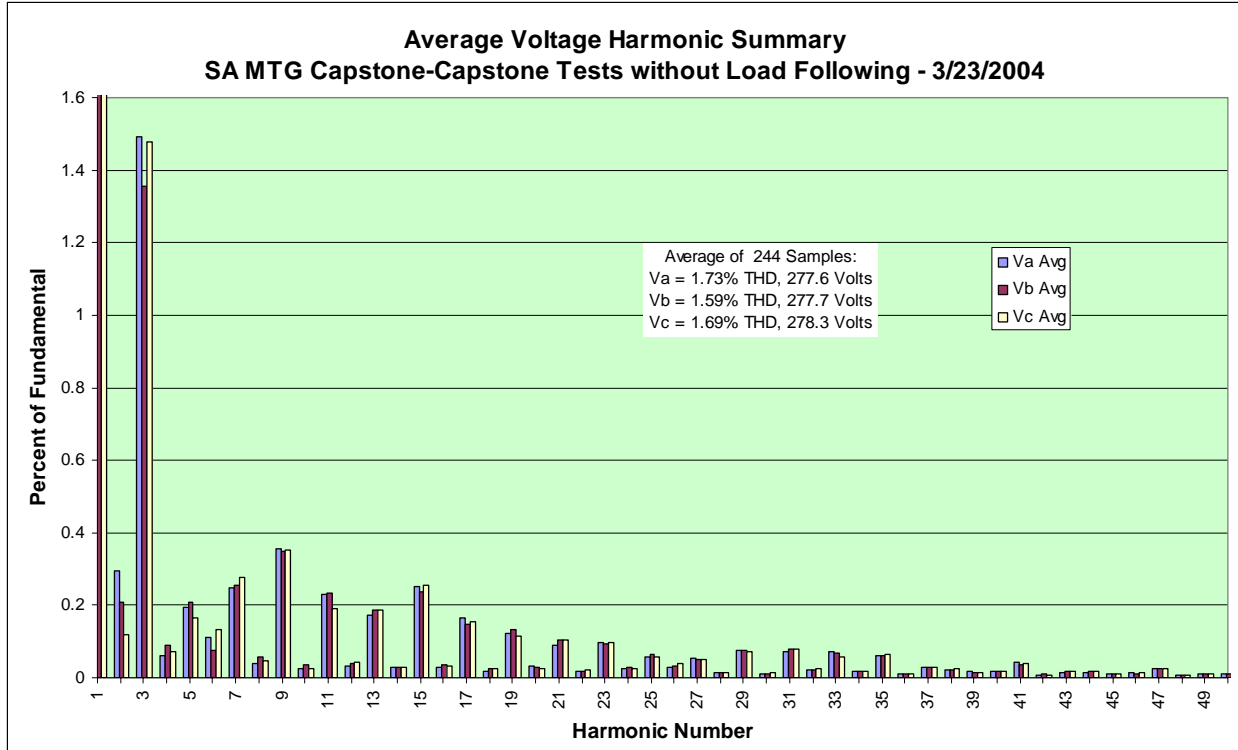

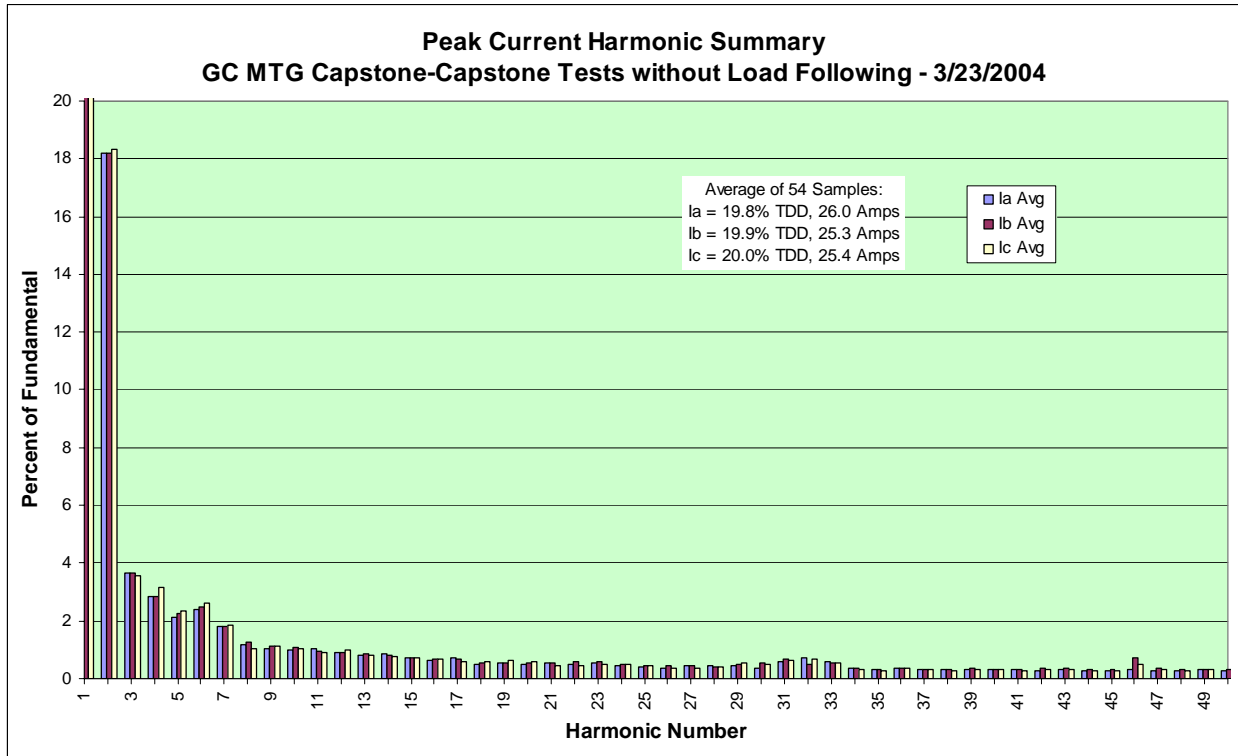
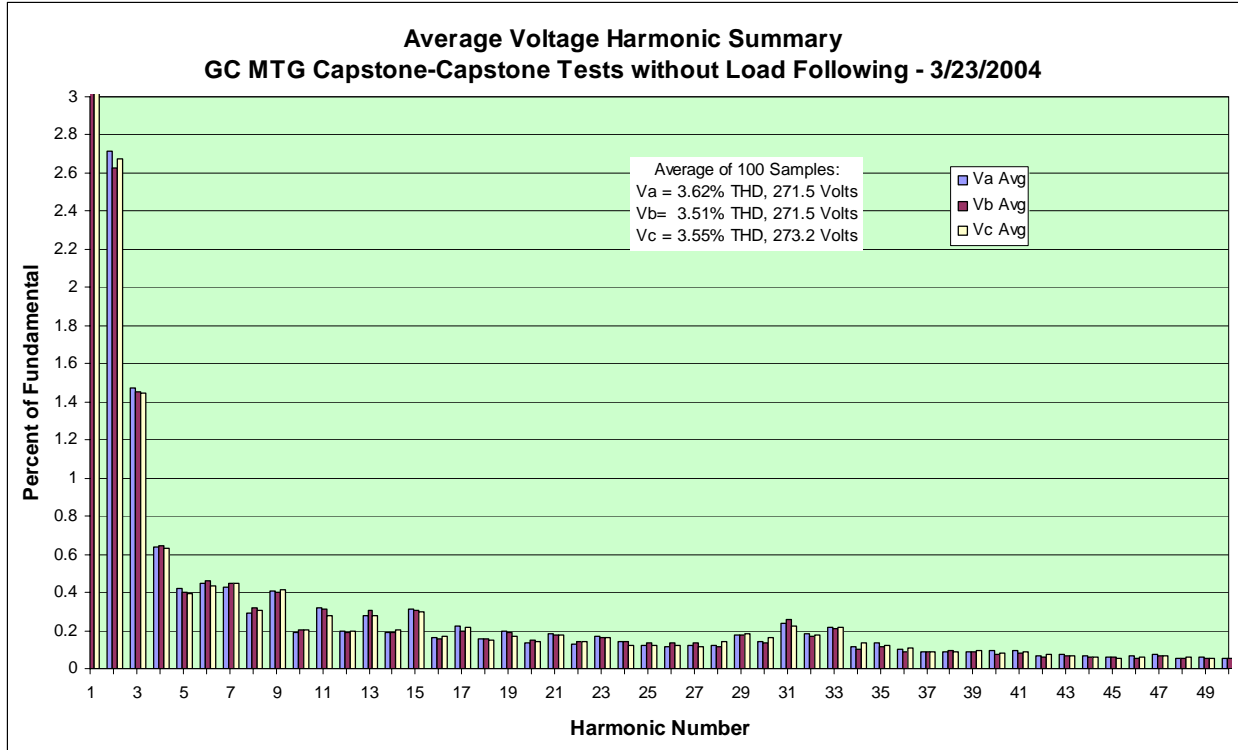

Appendix B – Capstone-Capstone Tests with Load Following – 3/25/2004

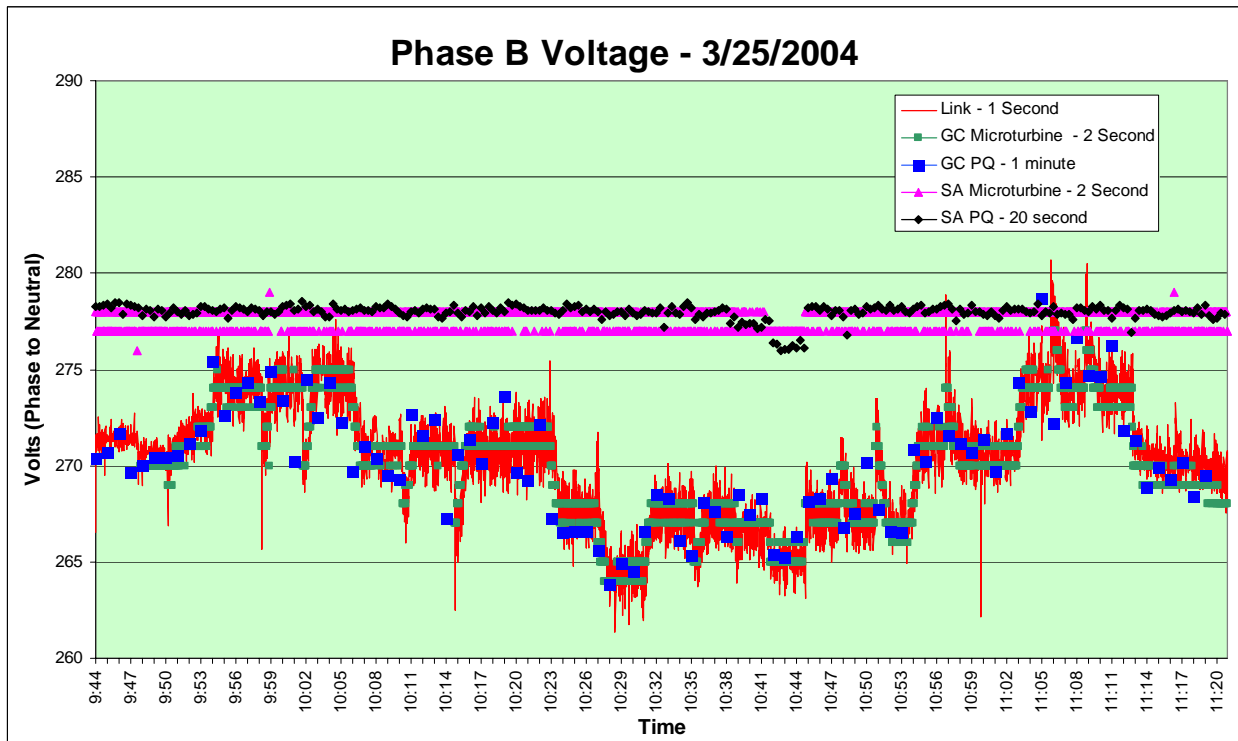
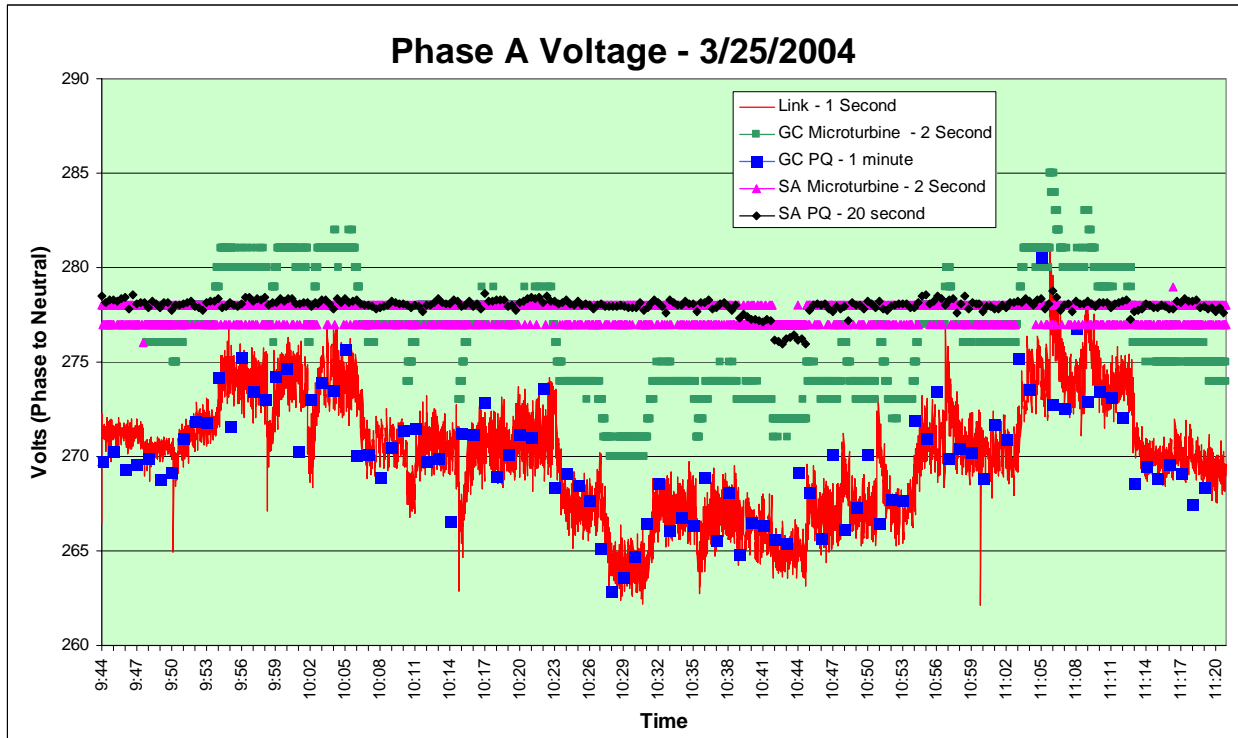

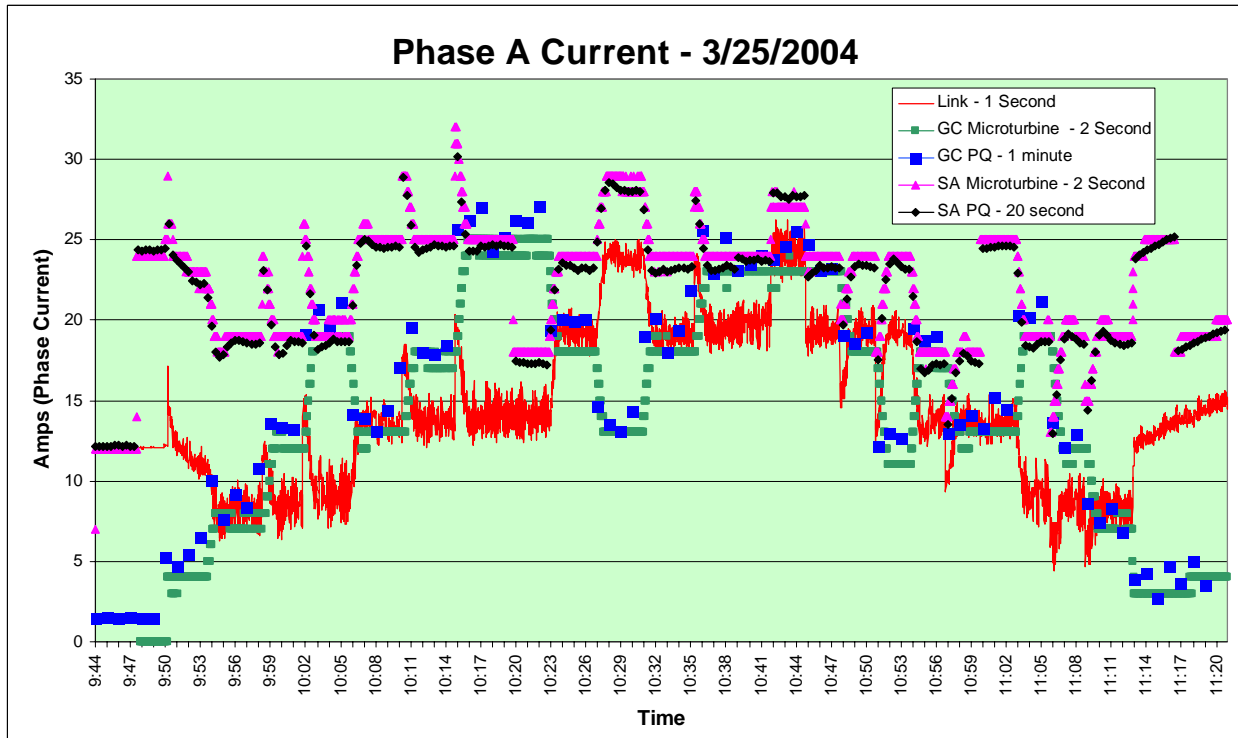
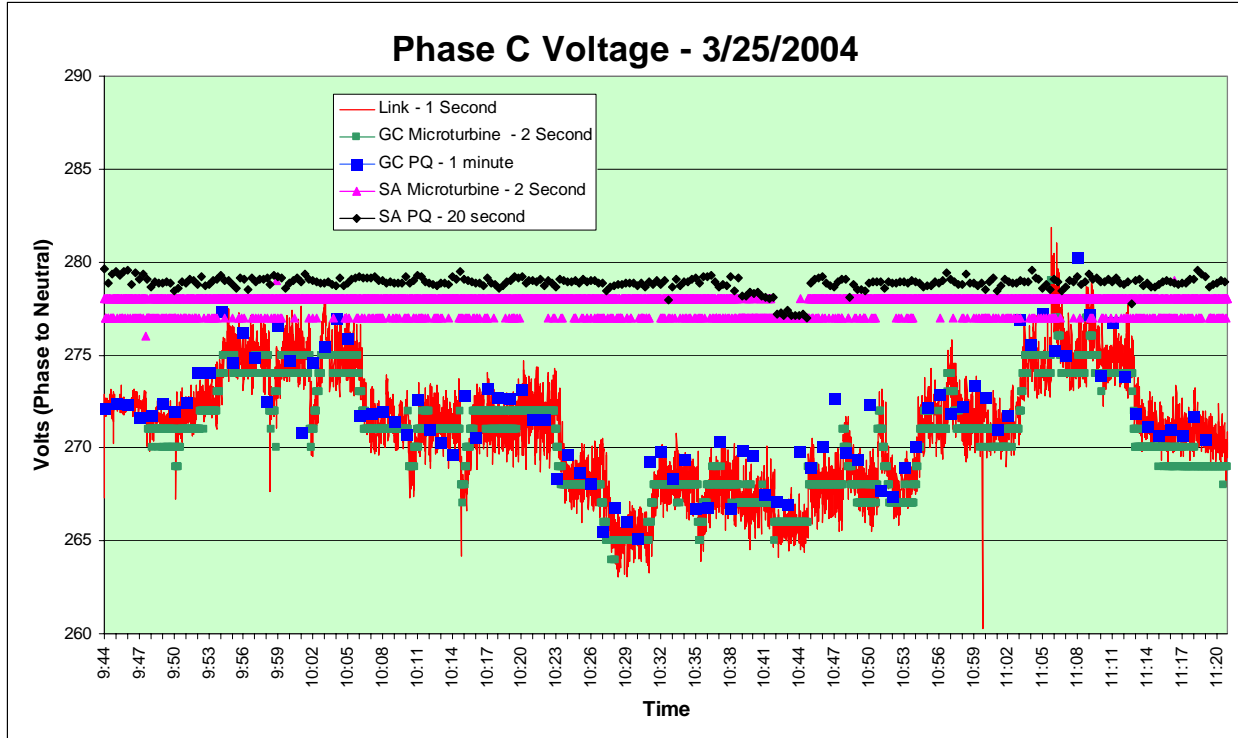

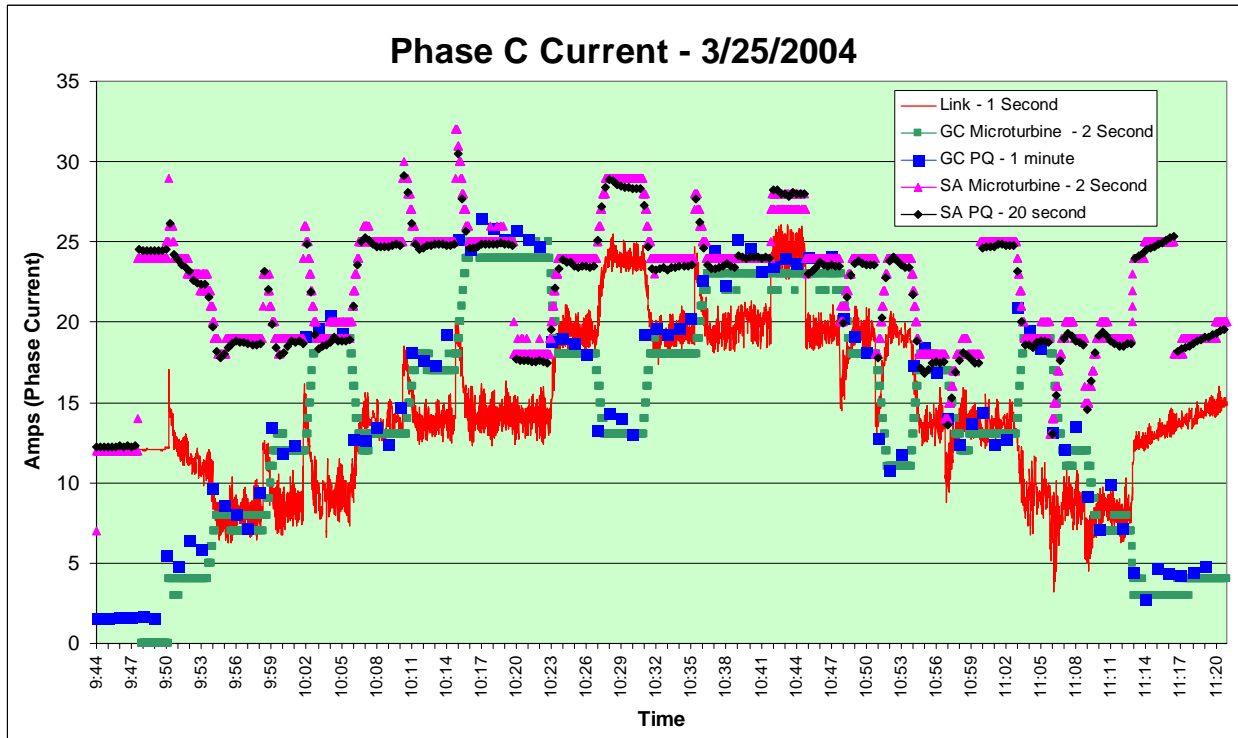
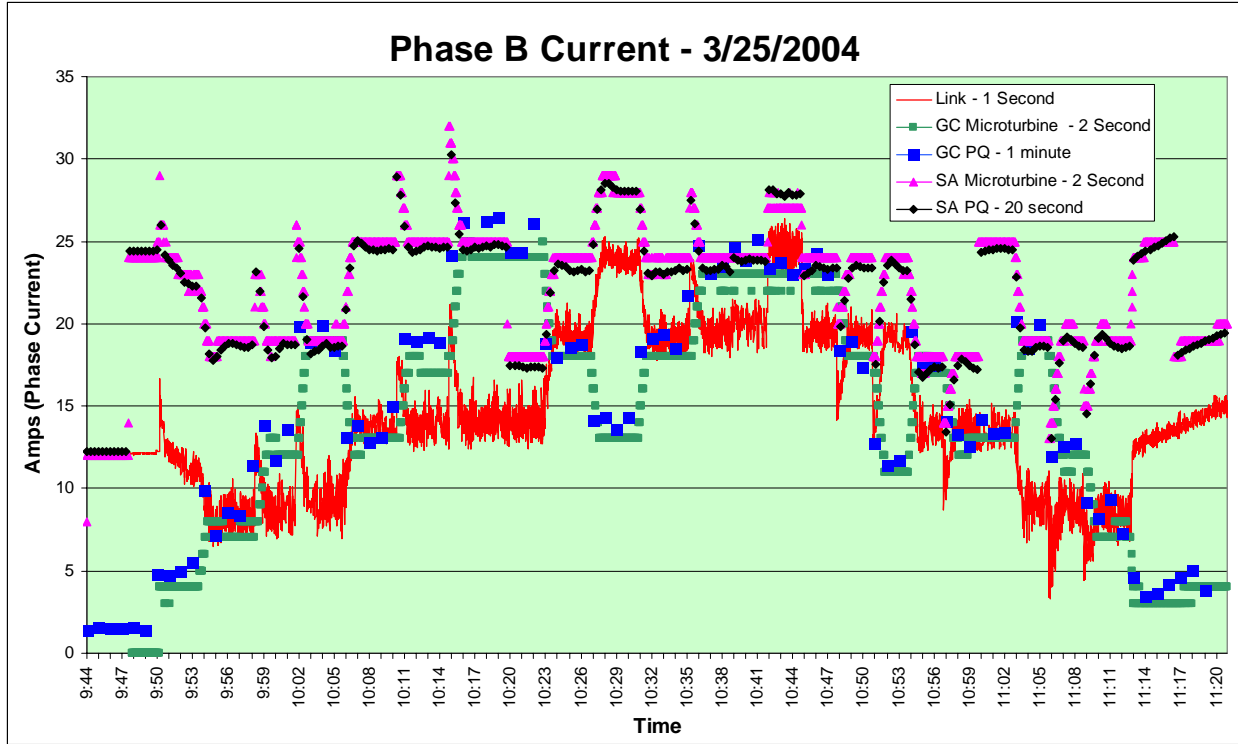

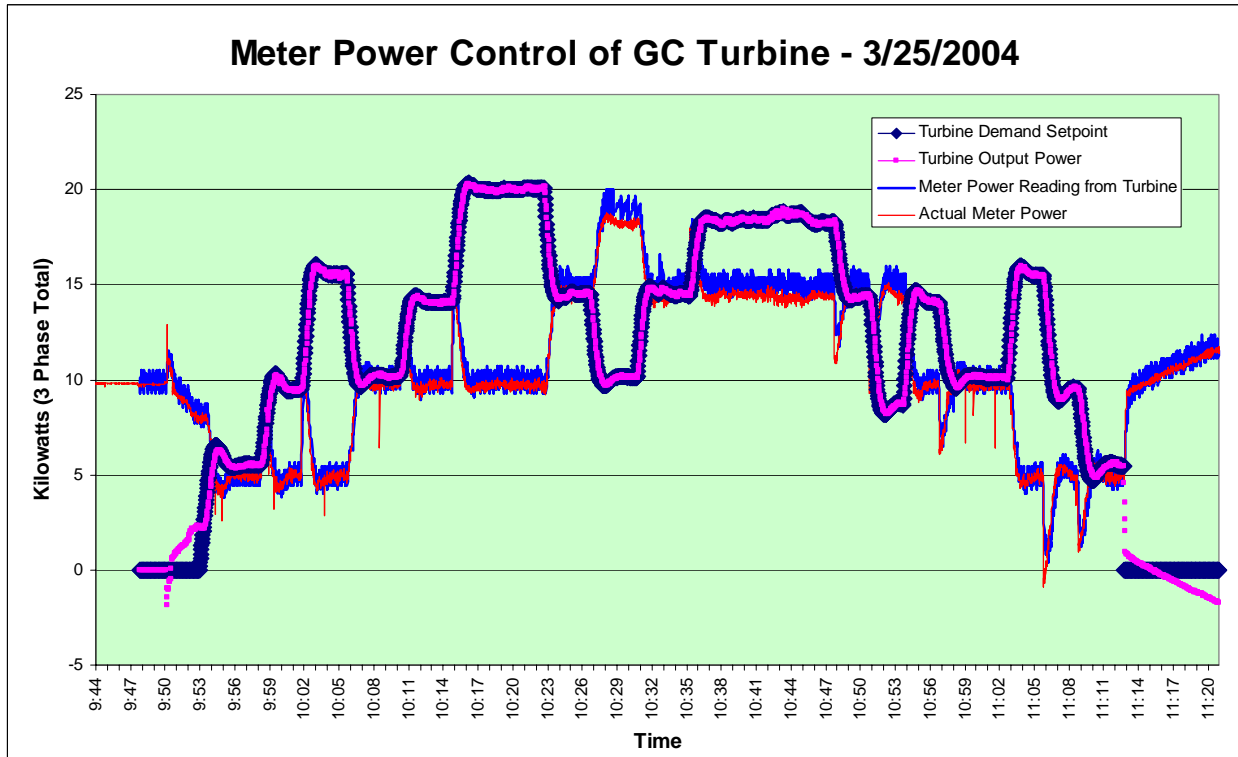
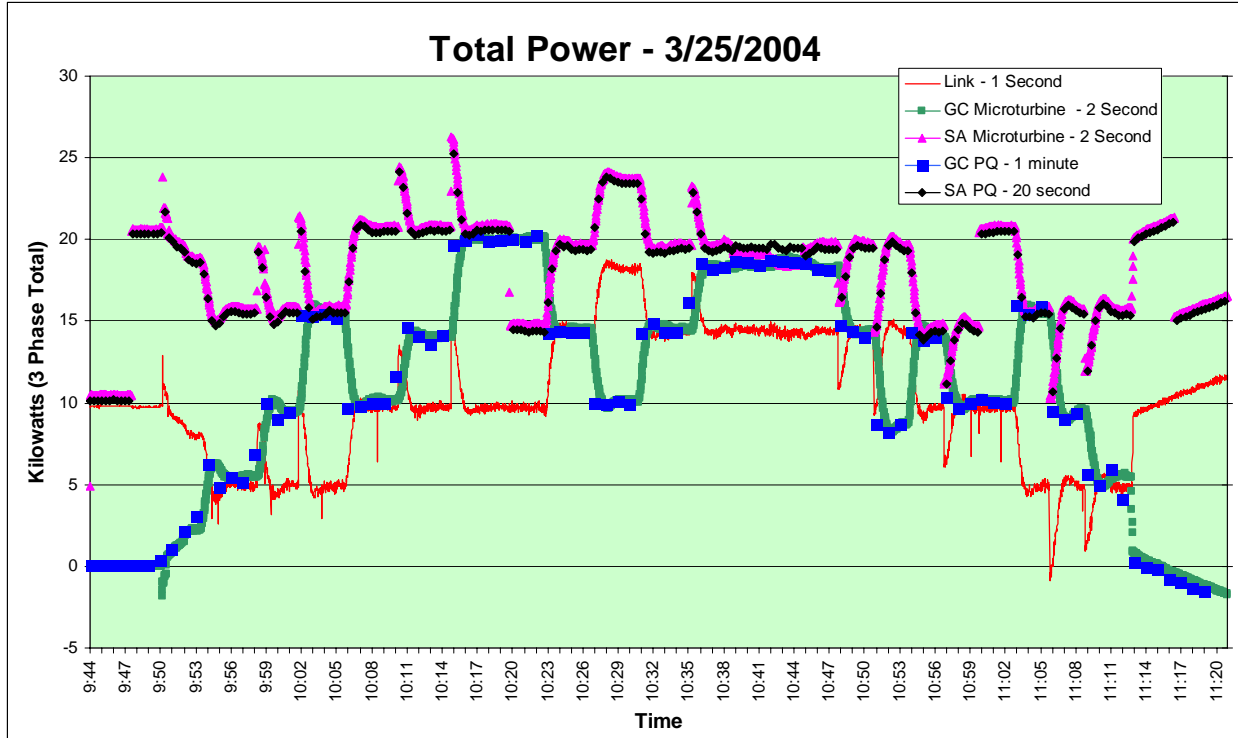

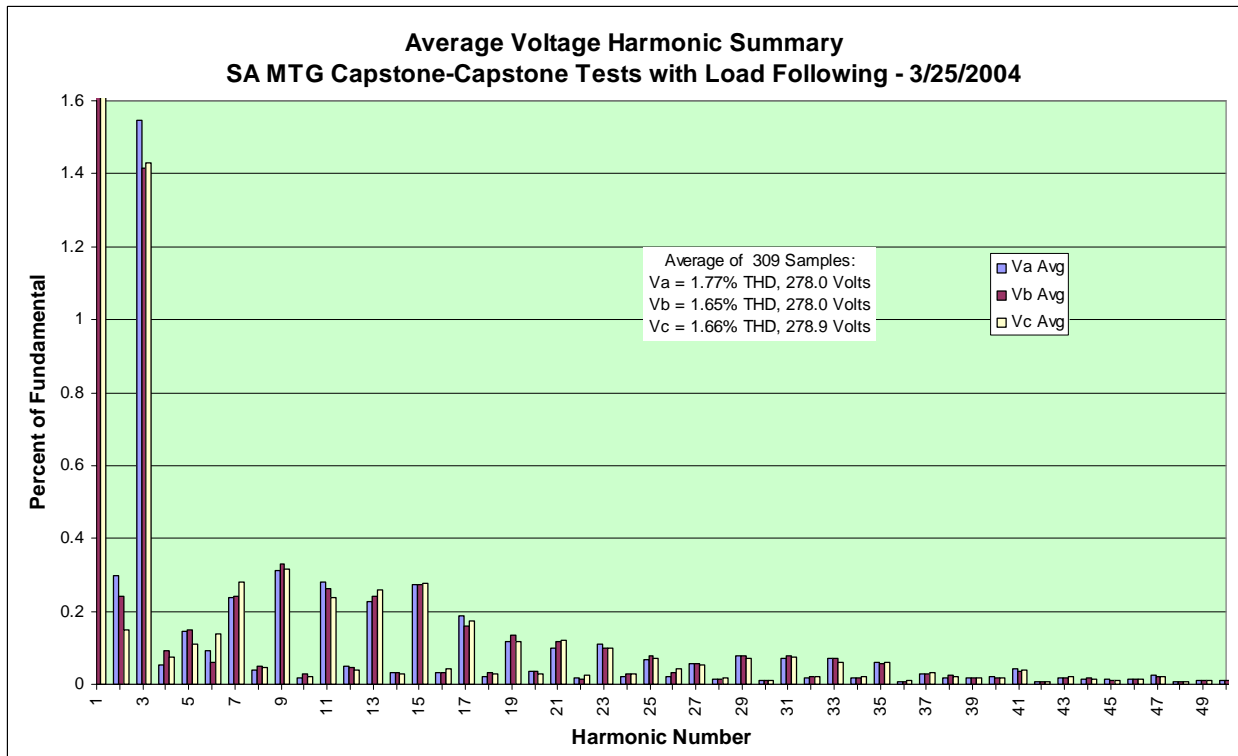
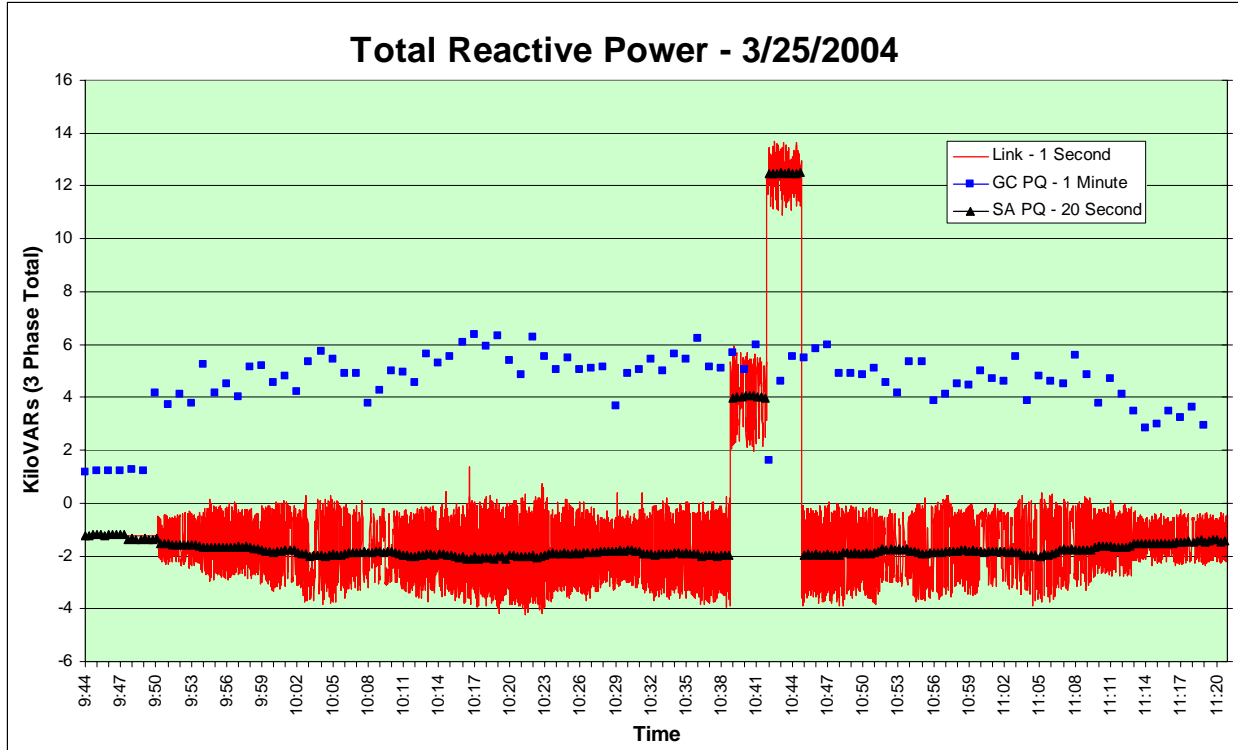

Peak Current Harmonic Summary
SA MTG Capstone-Capstone Tests with Load Following - 3/25/2004

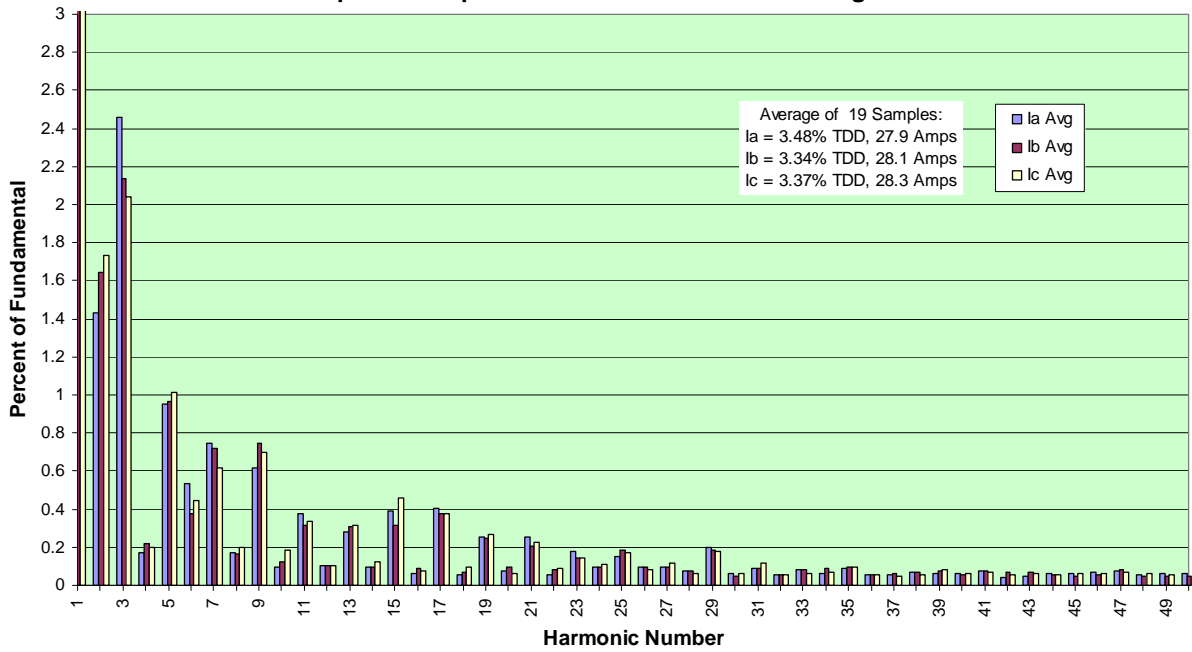

Average Voltage Harmonic Summary
GC MTG Capstone-Capstone Tests with Load Following - 3/25/2004

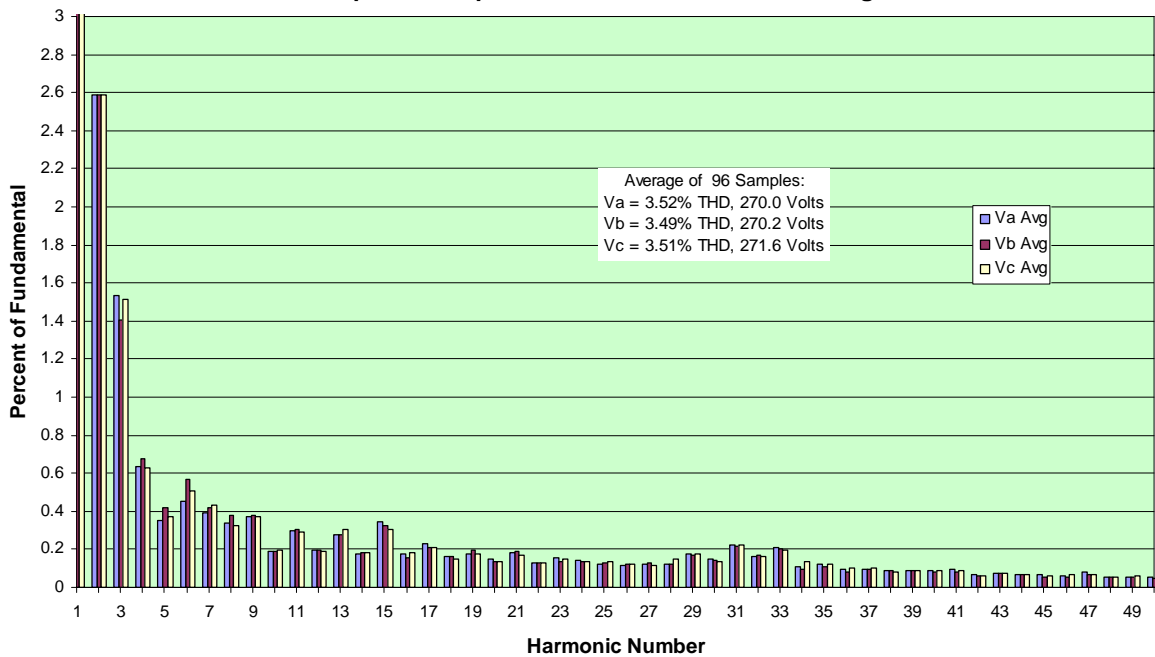

Peak Current Harmonic Summary
GC MTG Capstone-Capstone Tests with Load Following - 3/25/2004

