

Lawrence Berkeley National Laboratory

Lawrence Berkeley National Laboratory

Title

Hindered Diphenquinones: Diradicals of Oxygen

Permalink

<https://escholarship.org/uc/item/887784g2>

Authors

Bourdon, Jean
Calvin, Melvin

Publication Date

1956-07-10

UNIVERSITY OF
CALIFORNIA

*Radiation
Laboratory*

HINDERED DIPHENOQUINONES:
DIRADICALS OF OXYGEN

TWO-WEEK LOAN COPY

*This is a Library Circulating Copy
which may be borrowed for two weeks.
For a personal retention copy, call
Tech. Info. Division, Ext. 5545*

UCRL-3466
Chemistry Distribution

UNIVERSITY OF CALIFORNIA
Radiation Laboratory
Berkeley, California
Contract No. W-7405-eng-48

HINDERED DIPHENOQUINONES: DIRADICALS OF OXYGEN

Jean Bourdon and Melvin Calvin

July 10, 1956

HINDERED DIPHENOQUINONES: DIRADICALS OF OXYGEN

Contents

Abstract	4
Introduction	5
Experiments and Discussion	9
Oxidation of the Tetrachloro 2,2', 6,6'-biphenol	12
Oxidation of the 2,2', 3,3', 5,5', 6,6'-octachlorobiphenol	13
Oxidation of the 2,2'-dimethyl-p,p'-biphenol	17
Oxidation of the 2,2'-dimethyl-5,5'-di-t-butylbiphenol	18
Hindered diphenoquinone (dilute solutions)	21
Polymerization products (concentrated solutions)	24
Free-Radical Content	28
Decay of the Compounds	28
Attempts to Isolate Quinones as Solids	32
Procedures	
Preparation of 3,5-dichloro-4-iodonitrobenzene	34
Preparation of 2,2', 6,6'-tetrachloro-4,4'-dinitrodiphenyl	34
Preparation of 2,2', 6,6'-tetrachloro benzidine	34
Preparation of 2,2', 6,6'-tetrachloro-4,4'-biphenol	35
Preparation of 2,2', 3,3', 5,5', 6,6'-octachloro-4,4'-biphenol	35
Preparation of 2,2', 3,3', 5,5', 6,6'-decachloro-3,3', 4,4'- tetrahydro-4,4'-diketodiphenyl	36
Reduction of the decachloro compound	36
Action of silver on the decachloro compound	36
Attempts to Prepare the 3,3'-dibromo-2,2', 3,3', 5,5', 6,6'-octachloro-4,4'-diketo-3,3', 4,4'-tetrahydrodiphenyl	37
Preparation of 2,2', 6,6'-tetrachloro-3,3', 5,5'-tetrabromo- 4,4'-biphenol	37
Attempts to Prepare the 3,3', 5,5'-tetrabromo-2,2', 3,3', 6,6'- hexachloro-4,4'-diketo-3,3', 4,4'-tetrahydrodiphenyl	37
Preparation of 2,2'-dimethyl-4,4'-dinitrodiphenyl	37
Preparation of 2,2'-dimethylbenzidine hydrochloride	38
Preparation of 2,2'-dimethyl-4,4'-biphenol	38
Preparation of 2,2'-dimethyl-5,5'-di-t-butylphenol	38
Oxidation of Biphenols	40
Oxidation of 2,2'-dimethyl-5,5'-d-t-butylphenol	40
Spectral and ESR Studies on Solutions	
At 3×10^{-5} mol/liter	40
At 10^{-3} mol/liter	40
At more than 10^{-3} mol/liter	40
Titration of the solution (10^{-3} to 10^{-2} mol/liter)	42

Action of p,p'-biphenol on the Hindered Diphenoquinone LI 42
Action of p,p'-biphenol on the Polymeric Diphenoquinones 42
Action of Hindered Biphenol XLIX on the Hindered Quinone LI 42
Temperature-Dependency Study 42
Red Glass	
Oxidation with lead dioxide 43
Oxidation with potassium ferricyanide 43
Preparation of 3,3'-dimethyldiphenoquinone 43
Diphenoquinone 46
References 47

HINDERED DIPHENOQUINONES: DIRADICALS OF OXYGEN

Jean Bourdon and Melvin Calvin

Radiation Laboratory and Department of Chemistry
University of California, Berkeley, California

July 10, 1956

ABSTRACT

Attempts were made to prepare a diphenoquinone having substituents in 2,2'-positions in order to prevent the planarity of the molecule and get a diradical of oxygen. The 2,2'-dimethyl-5,5'-di-t-butyl-diphenoquinone was prepared and was shown to be in equilibrium with a small amount of diradical. This compound slowly polymerizes.

HINDERED DIPHENOQUINONES: DIRADICALS OF OXYGEN

Jean Bourdon* and Melvin Calvin

Radiation Laboratory and Department of Chemistry
University of California, Berkeley, California

July 10, 1956

INTRODUCTION

It seems clear that the two rings of the diphenquinone (I) are coplanar and that the existence of the central double bond is responsible for this coplanarity. If this coplanarity is destroyed, the central double bond cannot exist and a diradical of oxygen may be expected. The coplanarity of the two benzene rings can be destroyed if one introduces in the 2,2' positions any substituent which, by steric hindrance, obliges the rings to rotate from a common plane, thus allowing the existence of only a single bond between them.

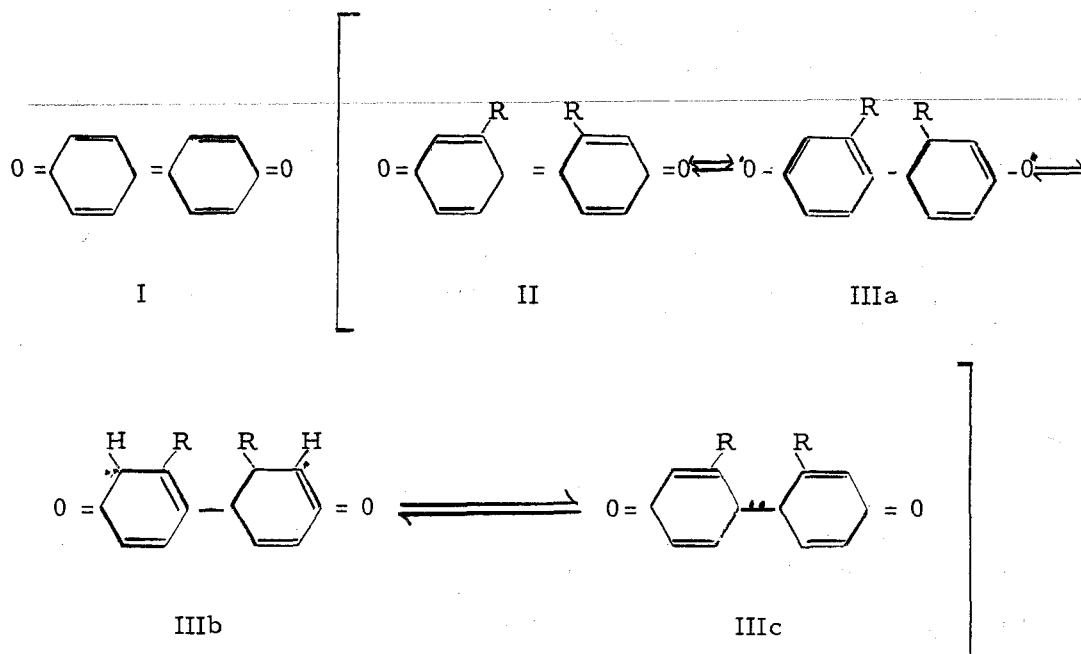

The diradical III would be stabilized by resonance of the different limit forms IIIa, IIIb. In fact, such structures exist: the p,p'-diradical derived from Tchitchibabin's molecule in which are introduced in the 2,2', 6,6'-positions substituents such as methyl or chlorine, IV and V. These compounds -- isolated in the solid state by Theilacker¹ and Muller,² respectively -- give good examples of diradicals resulting from non-coplanarity of the diphenyl skeleton.

* Fulbright Fellow, 1954-1956.

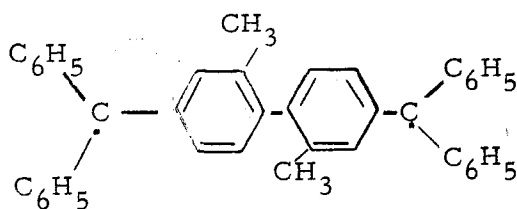

IV

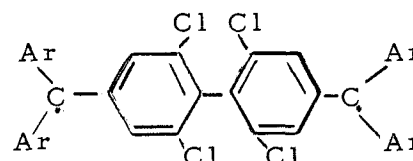

V

These products, almost colorless in the solid state, are deeply colored in solution (red, blue, or green); this phenomenon corresponds to an equilibrium between the dimer (colorless), the quinoid, and the diradical (colored), the proportion of diradical increasing by dilution or by heating.

The existence of free radicals of oxygen has been definitely established in the mechanism of oxidation of phenols; therefore the different free radicals VI, VII, VIII, IX, X have been supposed to be intermediates in oxidation of corresponding phenols, oxidation giving usually a dimer as final result, for instance XI or XI'.⁴

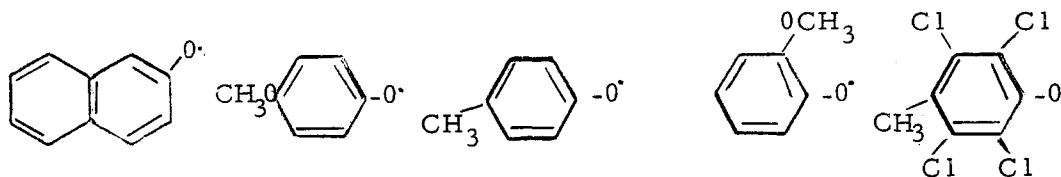

VI

VII

VIII

IX

X

Some of these free radicals (VII, VIII, IX, for example) made their appearance as a fugitive coloration during the reaction. Some others exist in solution in a state of equilibrium with the dimer; for example, the phenanthryl XII (R = OEt, Cl...), which exists in the solid state as a dimer XIII, dissociates partially in solution into a free radical (green).³

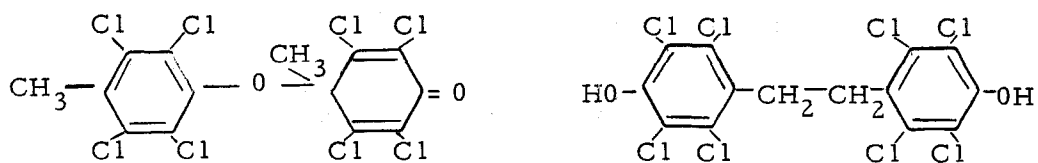

XI

XI'

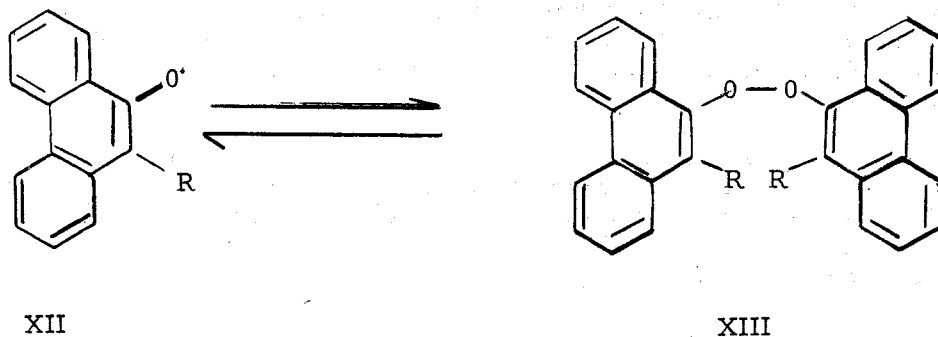

And recently, Muller⁵ isolated a real free radical of oxygen in the solid state: The tri-*t*-butylphenoxy XVI was obtained by oxidation of the corresponding phenol or by removal by silver of a halogen (chlorine or bromine) from the halogenated compound XV.

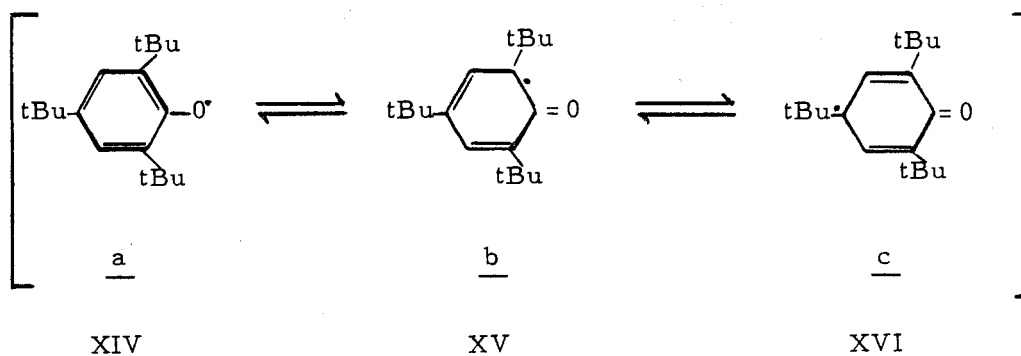
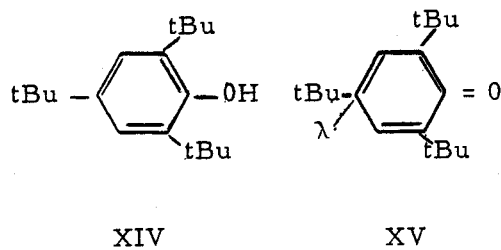

Muller explained the relative stability of this free radical by the steric hindrance introduced by the t-butyl groups, which prevents the approach of reagents to the molecule. In fact, this free radical, deeply blue in the solid state, decolorized rapidly in the presence of air by formation of peroxide XVII.

Cook⁶ prepared, in the same way, some similar stable free radicals (XIX), and showed that these free radicals could exist when the o- and p-positions were substituted to prevent dimerization and when there was no hydrogen on the α-carbon. Thus, with a, H present, the 2,6-di-t-butyl-4-methyl-phenoxy gives the dimer XVIII.

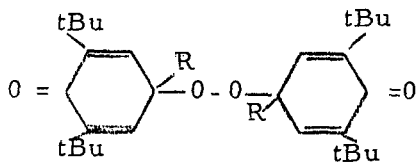

XVII

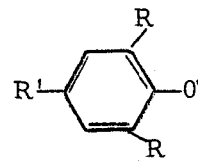

XIX

R	R'
Tri-t-amyl bi-t-butyl bi-t-butyl bi-t-butyl	tri-t-amyl methoxy butoxy ethoxy

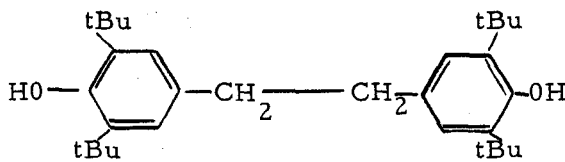

XVIII

EXPERIMENTS AND DISCUSSION

All these observations encouraged the presumption that it should be possible to obtain a diradical such as III. As a matter of fact, the dianthrone XXa, which gives a yellow solution at room temperature, gives green solutions when heated to 265°. Some authors⁷ explained this behavior by the existence of the diradical form b, and LCAO-MO calculation⁸ suggests that bianthrone would exist in a triplet state by rotation of one of the anthracene rings. On the other hand, some other compounds (XXI, XXII, XXIII, XXIV, XXV)⁷ derived from 2,2'-disubstituted diphenoquinone have been reported and described as having a quinoid structure, but no real proofs of structure were given and no studies on the properties of these products have been done.

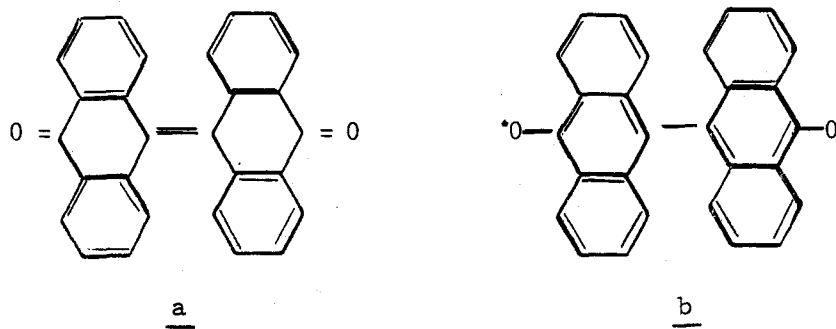

XX

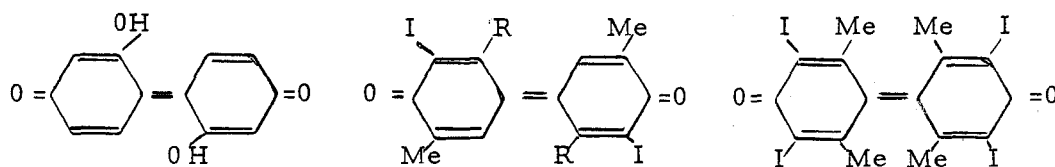

XXI

XXII

XXIII

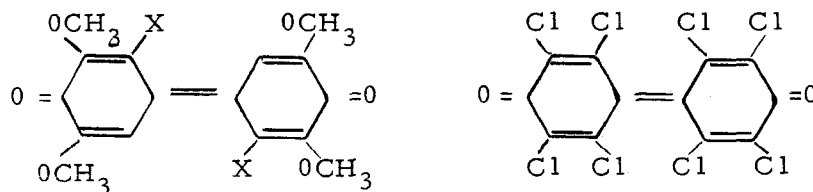
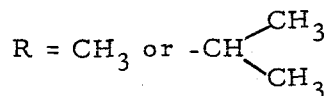

XXIV

XXV

X = Br or Cl

Therefore we proceeded to the synthesis of a biphenol, 2,2', 6,6' - substituted, without ambiguity in its constitution and potentially able to give by oxidation the expected diradical of oxygen.

The diradical whose preparation was first attempted was the tetrachloro 2,2', 6,6'-diphenoxy XXVIIa, which could be obtained by oxidation of the corresponding biphenol XXVI:

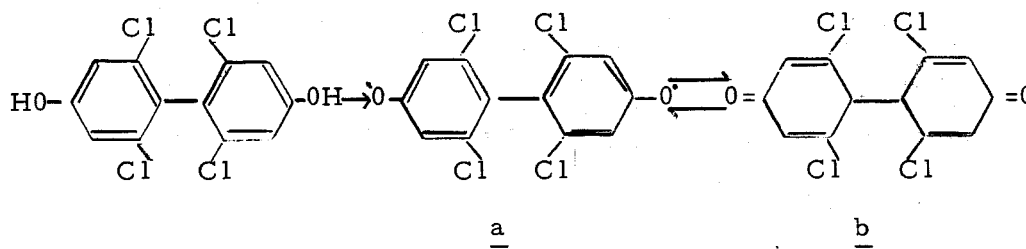

XXVI

XXVII

The method chosen for the synthesis of the biphenol is the following:

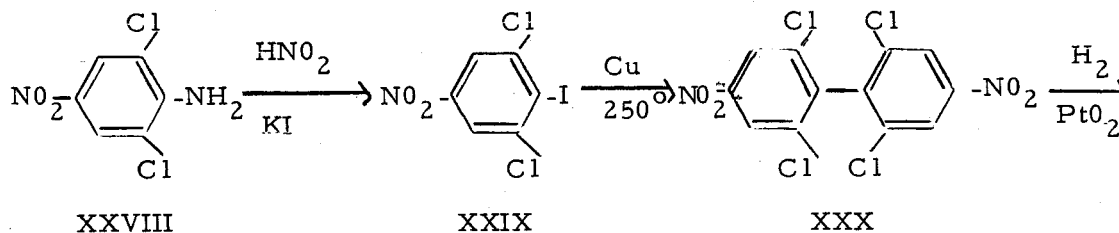

XXVIII

XXIX

XXX

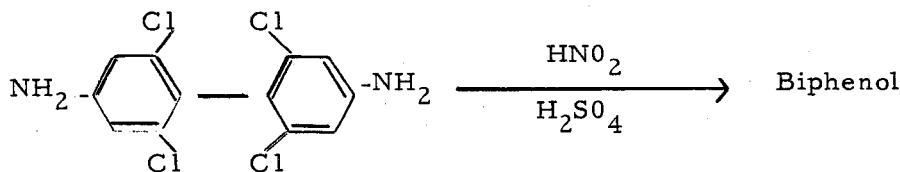

XXXI

The compounds XXIX, XXX, and XXXI had been prepared by other authors using different methods, but the process used here gave better yields and the products obtained were much easier to purify than with the previous methods.

The structure of the biphenol was further established by its spectrum (Fig. 1), similar to the spectrum of the pentachlorophenol and differing from that of biphenol and 3,3' -dimethylbiphenol.

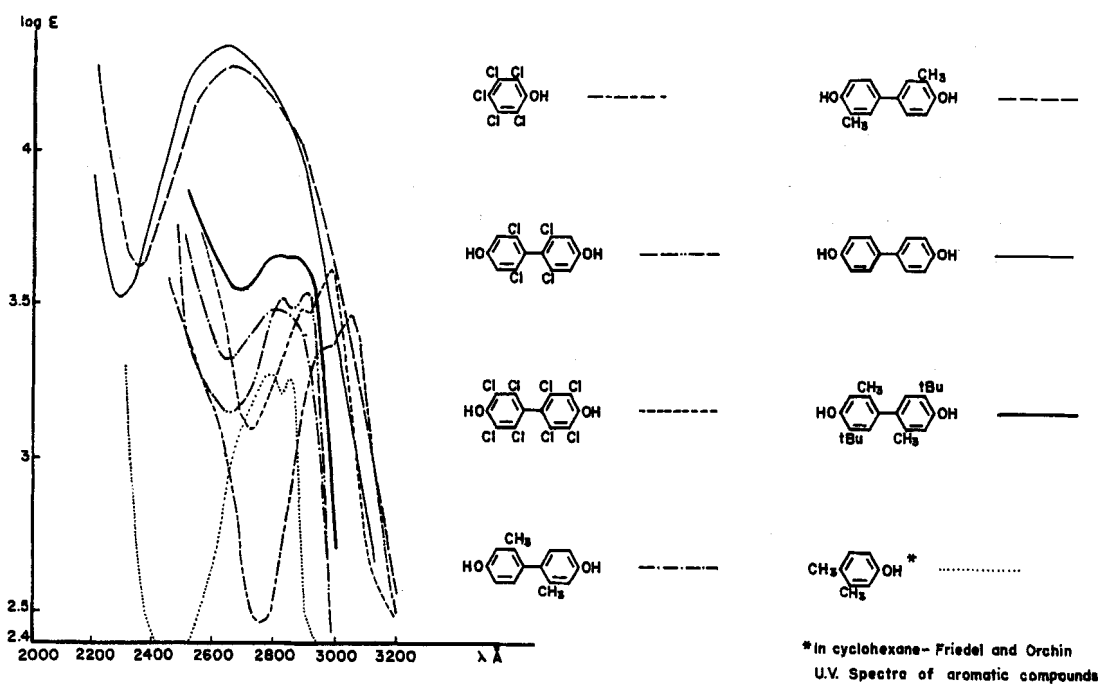

MU-11583

Fig. 1. Ultraviolet spectra in alcohol

Oxidation of the Tetrachloro 2,2', 6,6'-biphenol

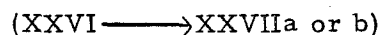

The usual oxidizing agents were tried, but without success; the biphenol remaining unchanged (silver oxide¹⁰ or lead dioxide in anhydrous ether or benzene, lead dioxide in moist ether,³ ferric chloride in acetic acid, potassium permanganate in alkaline solution). Potassium permanganate in acid solution completely destroyed the molecule, as was shown by uv spectrum.

Then the action of chlorine was tried, in the expectation of the formation of the octachlorobiphenol XXXII, which, by further oxidation, might give the diradical XXXV. Chlorine in chloroform gave the expected octachlorobiphenol XXXII.

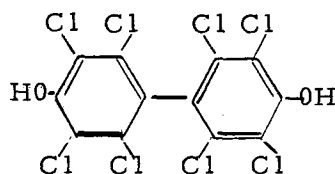

XXXII

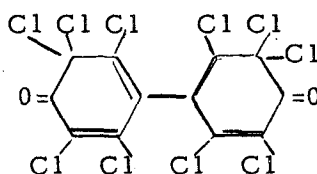

XXXIII

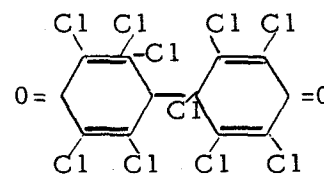

XXXIV

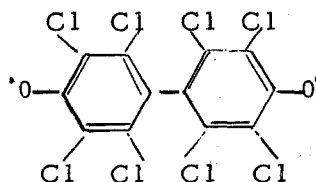

XXXV

The structure of octachlorobiphenol XXXII was confirmed by its uv spectrum (Fig. 1), similar to the spectrum of the pentachlorophenol. Chlorination of either tetrachloro- or octachlorobiphenol in acetic acid solution gave a decachlorinated compound for which two structures were possible: XXXIII and XXXIV. Reaction with zinc and acid gave the octachlorobiphenol, showing that the dephenyl skeleton had been preserved.

The *o*-quinoid structure XXXIII was established by uv spectrum (Fig. 2). The spectrum of the decachloro- is effectively very similar to the spectrum of *o*-benzoquinone and quite different from the spectra of hexachlorophenol XXXVII and *p*-benzoquinone. In fact, the *o*-quinoid structure is more probable, according to the steric hindrance in the *p*-quinoid structure XXXIV.

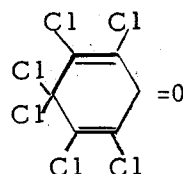

XXXIII

It should be noted that the decachloro compound XXXIII is slowly reduced to octachlorobiphenol by alcohol at room temperature (complete reaction in approximately 24 hours), showing the same behavior as the hexachlorophenol XXXVII toward this solvent. This reduction is approximately ten times as fast with the diphenyl compound.

Oxidation of the 2,2', 3,3', 5,5', 6,6'-octachlorobiphenol



Several methods were used. This biphenol seems even less sensitive toward oxidizing agents than the tetrachloro.

None of the following reagents gave any coloration of the solution--that is to say, formation of a radical--lead dioxide in moist ether or in benzene, alkaline potassium ferricyanide in benzene under nitrogen, potassium dichromate in boiling acetic acid with traces of sulfuric acid, potassium permanganate with sulfuric acid. Most of the time, the biphenol was left unchanged. The action of aqua regia for one month at room temperature according to the method used by Smith⁹ to prepare the same product, was here completely unsuccessful; the starting material was recovered unchanged.

Thus neither the diradical XXXV nor the dibenzoquinone XXV could be obtained because of the strong resistance of this biphenol toward the oxidizing agent.

After these failures, another completely different method was tried. This method consisted in the removal of two extra atoms of chlorine from the decachloro compound XXXIII by action of silver in benzene solution. For this reaction we refer to the reaction used by Muller⁵ to prepare the tri-t-butylphenoxy compound. Here after 18 hours of agitation of the solution with active silver under pure nitrogen, the decachloro compound XXXIII was recovered unchanged.

Since the two chlorine atoms seemed to be too tightly bound to the molecule, we tried to replace them by two bromine atoms, as in XXXVIII. This compound might be obtained by bromination of the octachlorobiphenol. Several methods were used, all unsuccessful, the only product obtained being a substance with the properties of a polymer.

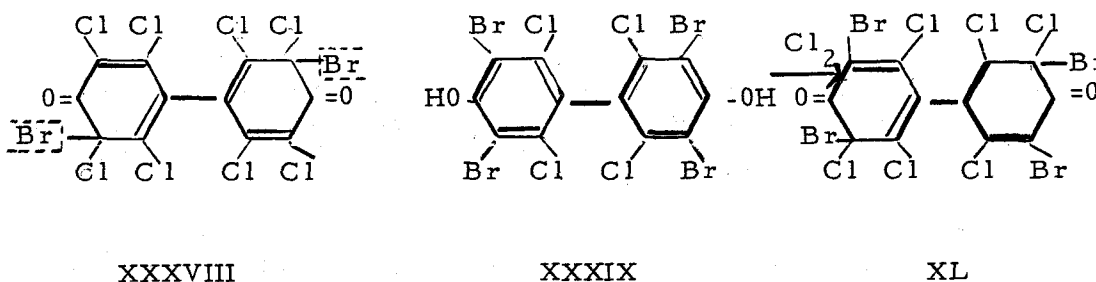

Next we tried bromination of the tetrachlorobiphenol to get XXXIX, followed by chlorination giving XL, which possesses the desired chlorine and bromine on the same carbon atom. The tetrabromo compound XXXIX was obtained by action of bromine on tetrachlorobiphenol. Then the chlorine was allowed to react in MeOH-AcOH,⁵ and even at -20° the bromine was replaced by the chlorine with production of the decachloro compound XXXIII previously described.

From all the foregoing observations arises the idea that perhaps the presence of the electronegative chlorine prevents the oxidation of the biphenol and the formation of the diradical.

For comparison, the oxidation of pentachlorophenol was studied in the literature and some experiments were done:

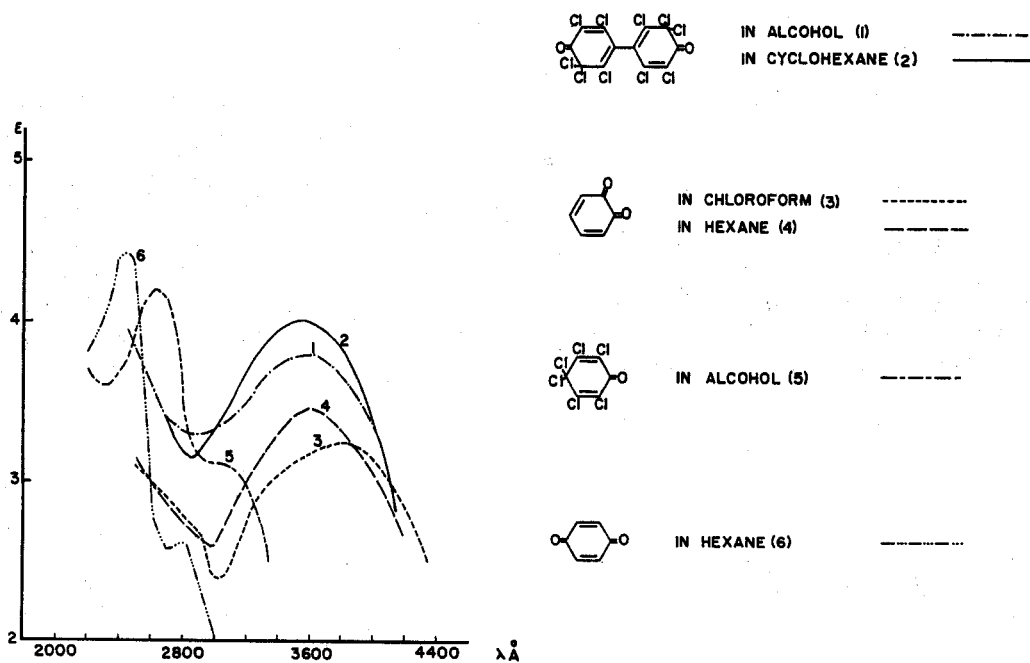

MJ-11584

Fig. 2. Ultraviolet spectra of decachloro compound and analogues
(See Friedel and Orchin, "Ultraviolet Spectra of Aromatic Compounds,"
John Wiley and Sons, p. 77; Goldschmidt. Ber. 61, 1868 (1928)).

Most of the strong oxidizing agents¹¹ transform pentachlorophenol into chloranil by removal of p-chlorine. The same result is observed with sym-trichlorophenol.¹² Such results could not be expected for the octachlorobiphenol. On the other hand, we did make some attempts to see if it was possible to get the free radical XLI by oxidation of pentachlorophenol.

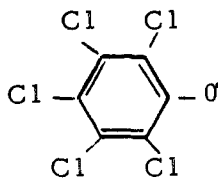

XLI

The lead dioxide in moist ether at 0° gave no coloration, and neither did potassium ferricyanide in alkaline solution, differing in this way from tri-t-butylphenol. Pummerer reports that the dehydrotetrachloro-p-cresol, X-XI, a strong oxidizing agent, was without action on pentachlorophenol.⁴

So we tried to prepare a diradical free from chlorine and for this purpose the 2,2'-dimethyl-p-biphenol XLII was prepared. The angle between the two phenyl rings ought to be smaller than with four chlorine atoms, and it could be expected that some stabilization of the diradical XLIII by the methyl groups might be apparent.

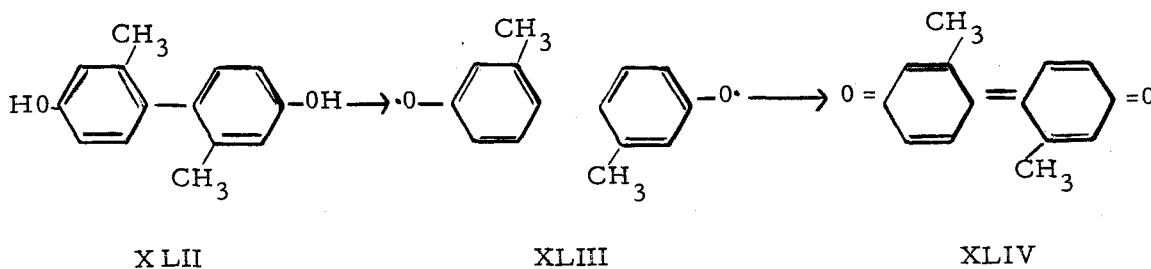

XLII

XLIII

XLIV

The 2,2'-dimethylbiphenol was prepared in the following way:

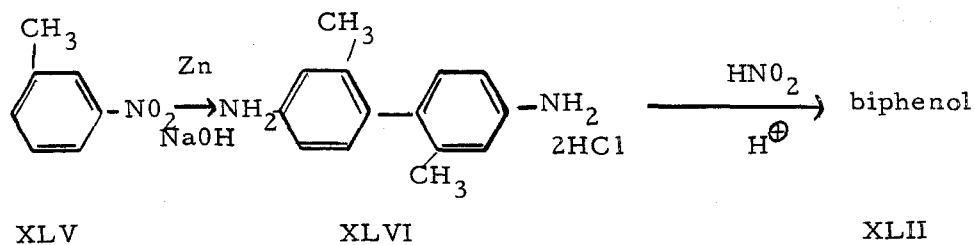

XLV

XLVI

XLII

The alkaline reduction of *m*-nitrotoluene by zinc and alcohol gives, directly after acidification, a very good yield in the diamine, which is trans-formed in biphenol in the usual way.

The diamine XLVI has been prepared in another way:

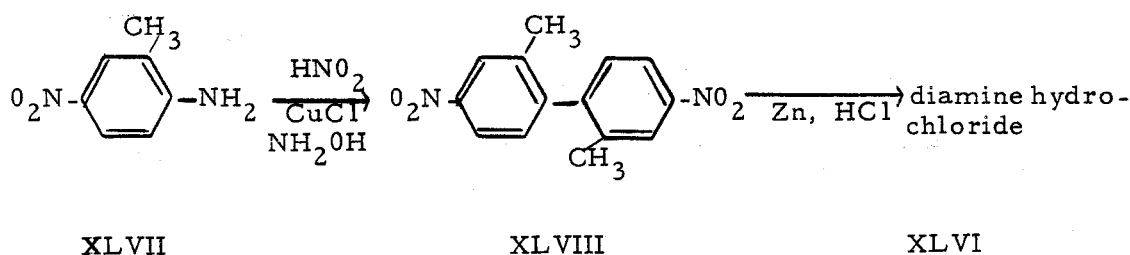

Oxidation of the 2,2'-dimethyl-*p,p'*-biphenol

(XLII)

In contrast with other biphenols, a reaction occurred, although it was not possible to see any color of a diradical. An insoluble brown polymer was formed by action of potassium ferricyanide. This polymer was mostly adsorbed by lead dioxide when this reagent was used. The same result was observed even at low temperature (-80°) under pure nitrogen.

From these observations we were led to believe that the biphenol XLII was oxidized, presumably with formation of the diradical, but this latter product, too reactive, could not even be seen and reacts rapidly to give dimers or polymers.

As suggested by Muller,⁵ two *t*-butyl groups in positions ortho to the hydroxyl increase the stability of the corresponding free radical by steric hindrance, in preventing the approach of the reagents to the molecule.

Therefore, in order to stabilize the diradical (XLIII) we tried to introduce four *t*-butyl groups in the 3,5, 3',5'-positions of the 2,2'-dimethylbiphenol (XLII). According to the method of alkylation of the phenol,¹³ isobutylene was allowed to react with the dimethylbiphenol at 70° in benzene solution with a trace of sulfuric acid. But under these conditions, only two *t*-butyl groups could be introduced in the 5,5'-positions because of the hindrance of the two methyl groups preventing the substitution on the 3,3'-positions.¹⁴

The 2,2'-dimethyl-5,5'-di-*t*-butylbiphenol, in accordance with the observation by Stillson¹³ for similar hindered phenols, is not soluble in dilute alkali and could be purified from other phenols by use of this property. Its spectrum (Fig. 1) is similar to the spectrum of the 2,2'-dimethylbiphenol, showing that the two benzene rings are not coplanar.

Oxidation of the 2,2'-dimethyl-5,5'-di-t-butylbiphenol

In contrast to the other biphenols prepared above, this one gives deeply colored solutions with oxidizing agents. Thus, with lead dioxide in moist ether or in benzene, we readily got a deep red solution stable for several hours. The same result was obtained with alkaline potassium ferricyanide.

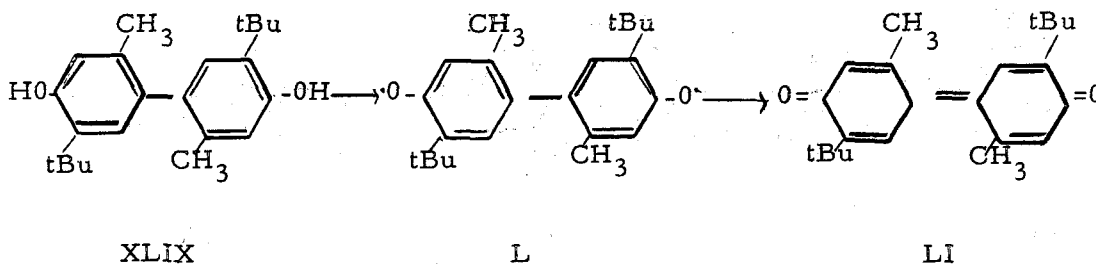

According to our hypothesis, these solutions could contain the diradical (L) or the quinone (LI) or a mixture of the two products in equilibrium $L \rightleftharpoons LI$ or products of polymerization.

In fact, studies of electronic-spin resonance (ESR) and of optical spectra of these solutions showed that the reaction of oxidation was a complex phenomenon involving several steps. Most of this study was done in benzene solution with lead dioxide as oxidizing agent. The solutions obtained were somewhat more stable when free from oxygen; therefore, many experiments were carried out under nitrogen or under vacuum.

A solution of biphenol in benzene was shaken with lead dioxide until the reaction was complete. This was indicated when the principal absorption band of the spectrum reached an apparent maximum (about 15 minutes). Results, shown in Fig. 3, are quite different according to whether the reaction is done in dilute or in concentrated solution.

In dilute solutions (3×10^{-5} mol/liter) the absorption spectrum of the reaction solution exhibits one band (Fig. 3: $\lambda_{\max} = 4440 \text{ \AA}$, Σ_{\max} approximately 49,000), indicating that there is only one compound in the solution, which is --as will be shown later--the hindered diphenoquinone LI. When the concentration of the solution is increased (Figs. 3 and 4), λ_{\max} of this band is shifted toward the longer wave length (4830 \AA) and Σ_{\max} decreases considerably and settles, for a saturated solution, to a value of 16,000 (Fig. 4). A new maximum becomes apparent at 5000 \AA , producing a broadening of the entire absorption (Curve 5, Fig. 3). It is apparent that a polymerization of the hindered quinone LI occurred with the increase of the concentration.

This study will, therefore, be divided in two parts: (1) Study of the hindered diphenoquinone (produced in dilute solution), and (2) study of the polymerization products (in concentrated solution).

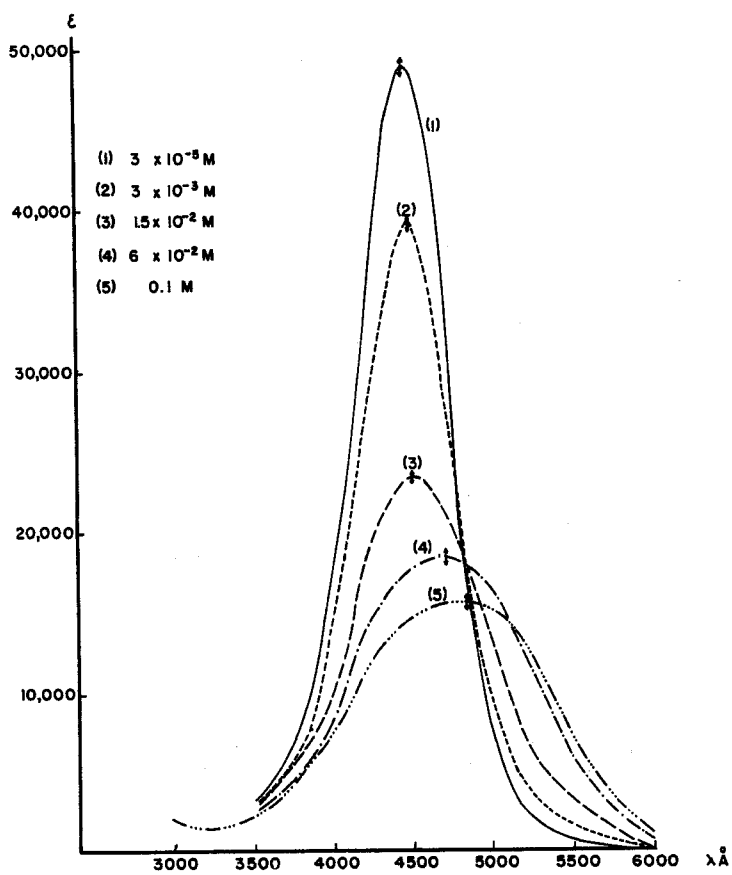

MU-11585

Fig. 3. Spectra obtained by oxidation with lead dioxide under vacuum at different concentrations in benzene.

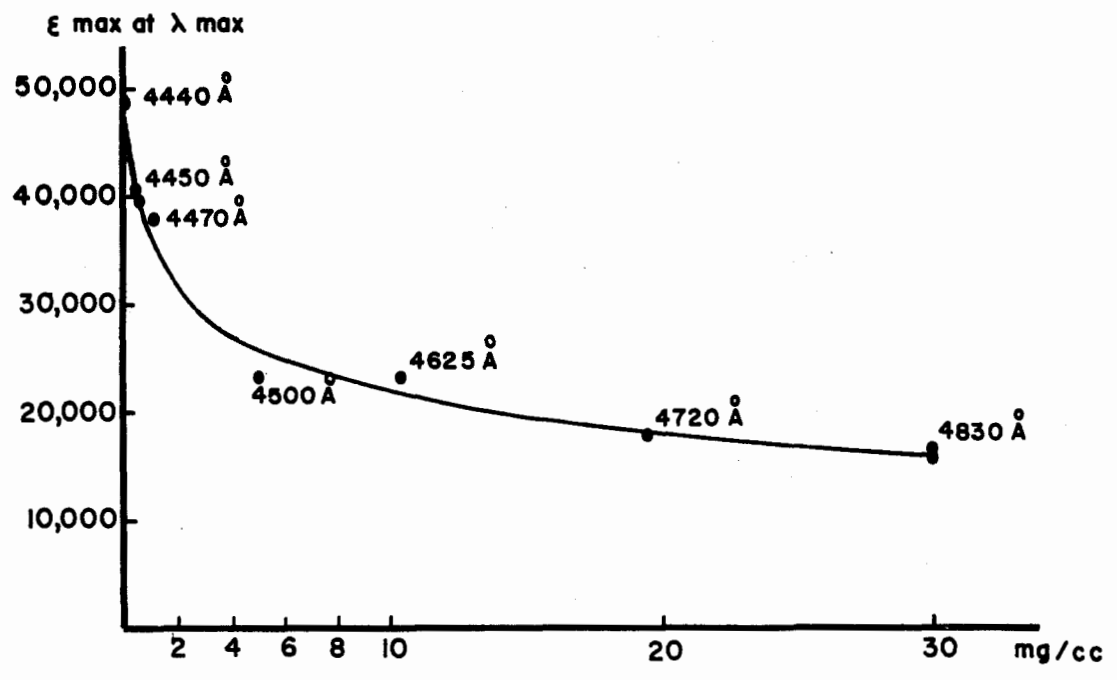

MU-11586

Fig. 4. Apparent ϵ_{\max} as a function of concentration of the reaction; values corresponding to curves of Fig. 3.

(1) Hindered diphenoquinone (dilute solutions)

Several lines of evidence were used in establishing the structure of this compound.

(a) In Fig. 5 optical spectra of this quinone LI, diphenoquinone I, 3,3'-dimethyldiphenoquinone, Tchitchibabin's hydrocarbon, and hindered Tchitchibabin's hydrocarbon IV are compared. From the behavior of the spectra we can be confident that dilute solutions (3×10^{-5} M) contain almost exclusively the quinone LI.

Such a hindered diphenoquinone should have a higher oxidation potential than the one of diphenoquinone itself. This was established by the reaction of biphenol with the hindered quinone:

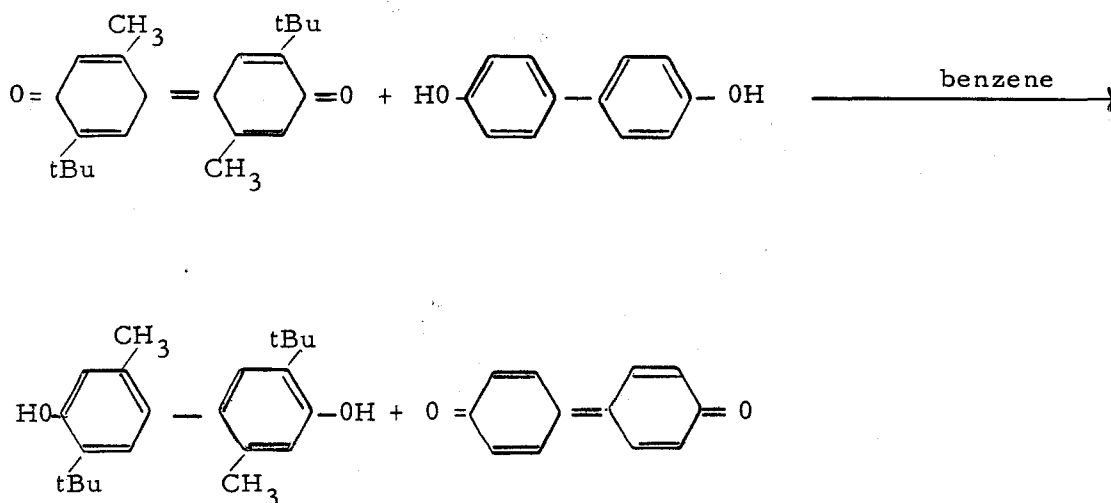

The exchange between the two compounds takes place in a few hours in benzene-ether solution with production (according to the spectrum, Fig. 6a) of 0.86 molecule of diphenoquinone per molecule of oxidized hindered phenol (or 0.95 per molecule of apparent hindered quinone formed).

The hindered diphenoquinone LI, according to our hypothesis, is supposed to be in equilibrium ($LI \rightleftharpoons L$) with the diradical L. This radical could be observed directly only in a more concentrated solution (10^{-3} mol/liter, Curve 2, Fig. 3, $\Sigma_{\max} = 39,600$) by ESR studies. A weak signal ($G = 2$) was obtained corresponding to a content of about 1 free electron for 1000 to 2000 molecules.

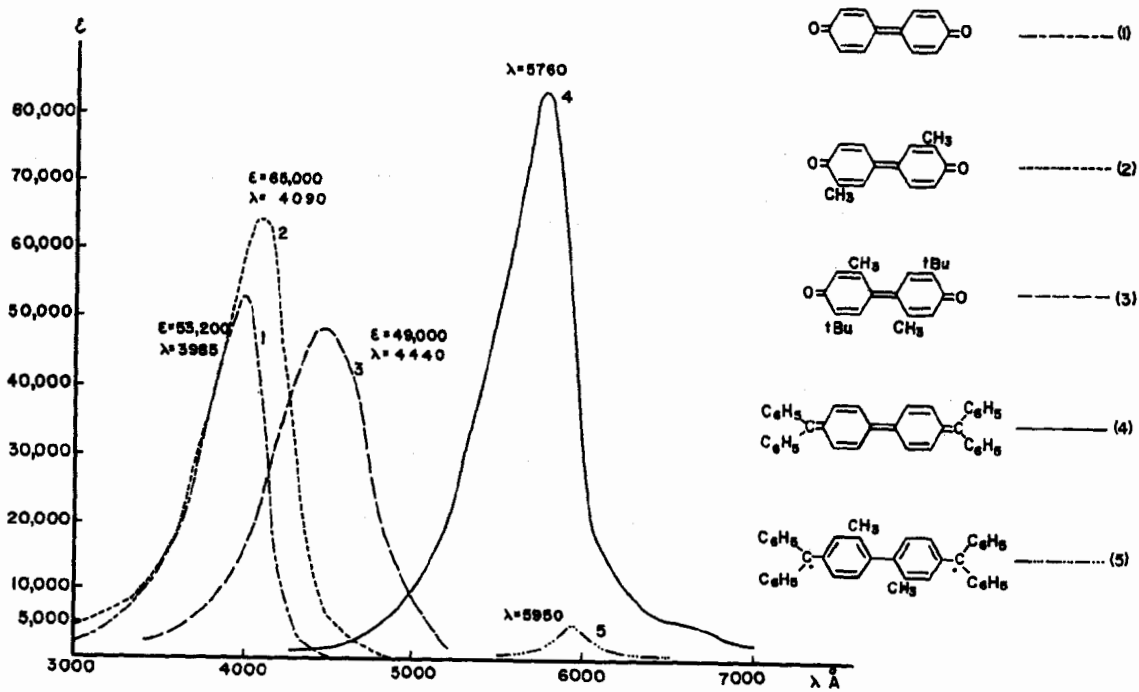

MU-11587

Fig. 5. Spectra in benzene of hindered diphenoquinone and analogues.

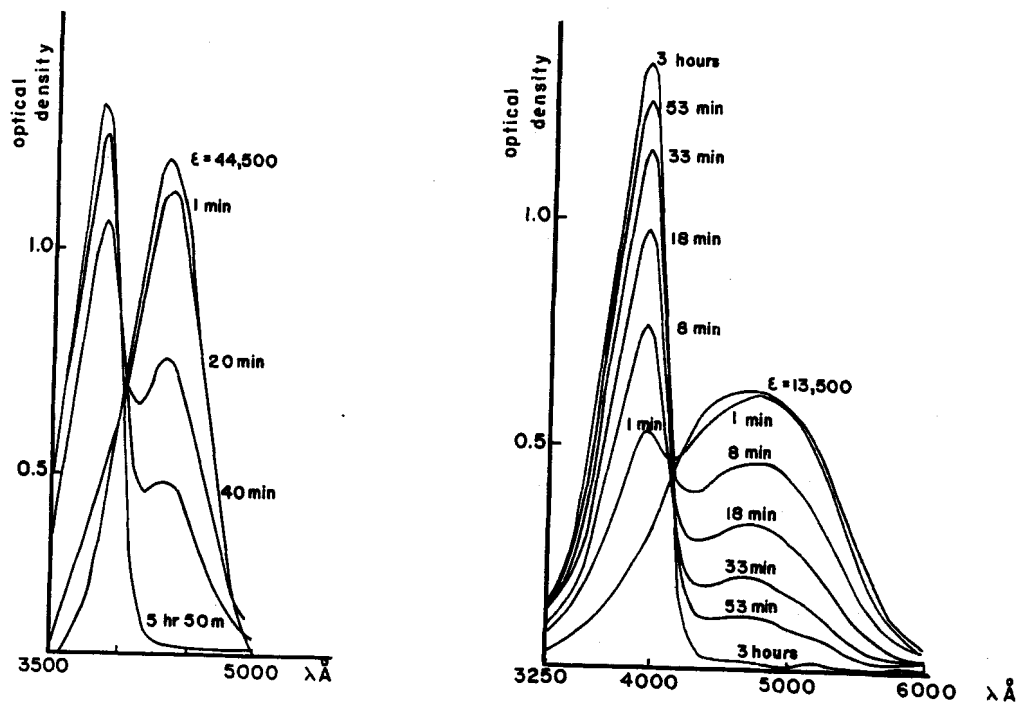

MU-11588

Fig. 6. (a) Action of biphenol (3 mol) on the hindered diphenoquinone (1 mol) in benzene. Quinone prepared in dilute solution.
(b) Action of biphenol (7 mol) on the so-called trimer quinone (1 mol monomeric unit) in benzene. Trimer prepared in concentrated solution.

(2) Polymerization products (concentrated solutions)

We have mentioned above the possibility of a polymerization in concentrated solutions. The molecule of diphenoquinone LI is able to react with itself or with biphenol XLIX, giving dimers LIII and trimers LV, LVII with a quinoid structure. Several facts support this hypothesis:

(a) The absorption band is shifted 390 \AA toward the red and the corresponding Σ_{max} value is decreased by two-thirds.

(b) The titration of oxidation equivalents by sodium iodide and thio-sulfate gave a value of 0.24 to 0.52 per molecule of starting biphenol. The diphenoquinone LI would give 2 equivalents per molecule and the trimer LIV should give 0.66.

(c) The products of the iodide reduction are weakly colored, possess a spectrum very similar to the starting biphenol, have a very low solubility, and cannot be sublimed, thus differing from starting biphenol.

(d) The action of biphenol in benzene, as it was done above for the diphenoquinone LI, gave a similar result (Fig. 6b); that is reduction of the quinoid polymers with simultaneous formation of diphenoquinone. The reaction established the diphenoquinoid structure of these polymeric compounds; 0.32 to 0.53 molecule of diphenoquinone was formed per molecule of starting hindered biphenol (0.64 to 1.06 oxidation equivalent).

The discrepancy between these values and the one found in experiment (b) can be explained by the presence of varying amounts of peroxides due to varying conditions in the two experiments.

(e) The successive polymerization reactions which occur during the oxidation of the hindered biphenol could be realized in several separated steps with production of some of the hypothesized intermediate compounds (Figs. 7, 8, and 9).

To a dilute solution of monomeric quinone LI ($\lambda_{\text{max}} 4440$, $\Sigma_{\text{max}} 44,000$, Curve 1, Fig. 8) was added a solution of hindered biphenol (1 mol for 1 mol). The solution was slowly decolorized at room temperature and after 6.30 h (Curve 2, Fig. 7) 85% of the quinone had disappeared. (The reaction could be accelerated by heating at 50° to 70° .) At the same time, a solution of quinone LI alone (at the same total molar concentration) decayed by only 22% (Curve 1, Fig. 7).

The resulting decolorized solution, supposed to contain the dimer LII, (Fig. 9) was shaken two minutes with lead dioxide, resulting in formation of an orange solution ($\lambda_{\text{max}} 4470$, $\Sigma_{\text{max}} = 25,000$, Curve 2, Fig. 8), corresponding to the dimer quinone LIII.

Then to this solution was added, once more, the hindered biphenol (1 mol for 1 mol of dimer), resulting in the fading of the solution. The reaction was slower (Curve 4, Fig. 7) than the first one (about one half) owing to the hindrance of one of the functions of the diphenoquinone in the compound LIII.

- 1. Decay of the hindered monomeric diphenoquinone (LI) -----
- 2. Action of 1 mol. of hindered biphenol on 1 mol. of hindered biphenoquinone _____
- 3. Decay of the so called dimer diphenoquinone (LII) -----
- 4. Action of 1 mol. of hindered biphenol on 1 mol. of dimer diphenoquinone -----

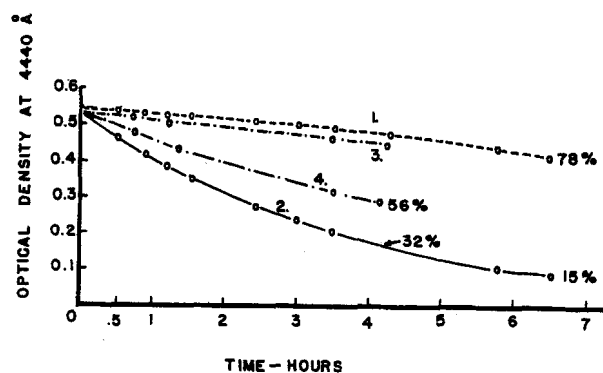

MU-11589

Fig. 7. Optical density at $\lambda = 4440 \text{ \AA}$ as a function of time in benzene at room temperature.

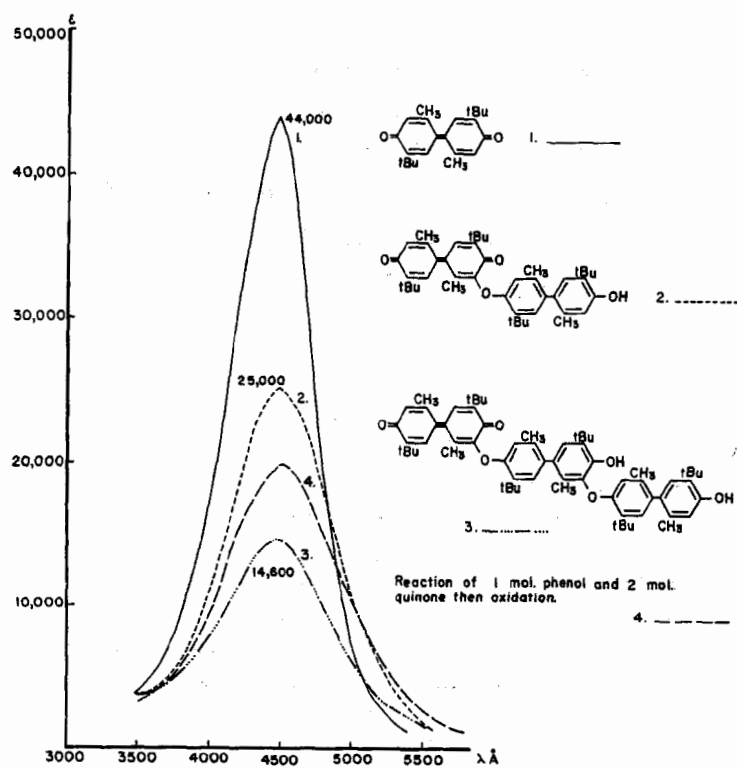

MU-11590

Fig. 8. Spectra in benzene of the hindered quinones, calculated with $M = 326$.

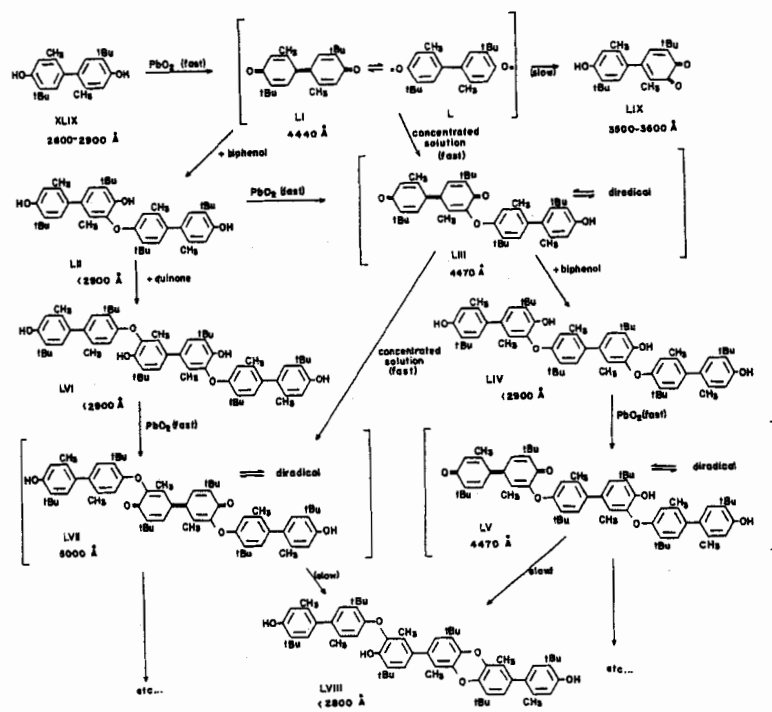

WD-11591

Fig. 9. Oxidation of hindered phenol.

Then this solution, supposed to contain the trimer LIV, was shaken two minutes with lead dioxide and gave an orange solution ($\lambda_{\max} = 4470$, $\Sigma_{\max} = 14,600$, Curve 3, Fig. 8). The three successive values of Σ_{\max} (44,000, 25,000 and 14,600) are in fairly good agreement with the formation of the monomer LI, dimer LIII, and trimer LV quinones.

The absorption observed at 5000 \AA in very concentrated solutions (Curve 5, Fig. 3) should be attributed to a trimer quinone such as LVII, which can be produced when an excess of quinone LI is present in the solution (Fig. 9, $\text{LI} \rightarrow \text{LIII} \rightarrow \text{LVII}$ or $\text{LI} \rightarrow \text{LII} \rightarrow \text{LVI} \rightarrow \text{LVII}$).

This was partially accomplished in dilute solution by allowing 1 molecule of hindered biphenol to react on 2 molecules of quinone LI. After almost complete decolorization of the solution, corresponding to the formation of LVI and LIV, the oxidation as above gave an orange solution. This solution ($\lambda_{\max} = 4500$, $\Sigma_{\max} = 19,800$, Curve 4, Fig. 8) exhibits a definite increase of absorption at 5000 \AA .

Free-Radical Content

The presence of free radicals in solutions containing these quinoid compounds (LIII, LV, LVII) was shown, as for the monomeric quinone, by ESR studies. A signal ($G = 2$) was found, indicating a content of about one free electron for 800 monomeric units, a value somewhat higher than for the monomer. This would correspond to one electron for approximately 270 molecules of trimer LVII.

Compounds with such a quinoid structure should be in equilibrium with the corresponding diradical and therefore the ESR signal should show a dependency on temperature--that is to say, in increase of content of diradical by heating and decrease by cooling (Nielsen and Fraenkel). Such a reversible increase of ESR signal between 30° and 100° was found (Fig. 10) until the quinone was completely transformed by polymerization and cyclization (LVIII). This transformation takes place faster than at room temperature.

Unfortunately, such an effect could be studied only on the polymers (LIII, LV, LVII) and not on the quinone (LI) in the very dilute solution, because of the weakness of the signal.

Decay of the Compounds

According to the ESR signal, the proportion of the free radical is higher in concentrated solution (Fig. 11) and reaches a value of about 1 free electron for 600 to 1000 monomeric units (average 800). When the concentrated solution is freshly oxidized, the signal is even higher (1 electron for 200 units), but decays in less than half an hour and drops to the rather stable value of 1 electron for 800. During the same time the Σ_{\max} of the optical spectrum is decreasing more slowly (Fig. 12). This discrepancy between the behavior as a function of time of the ESR signal and optical absorption would indicate the initial presence of some unstable free radical produced during the reaction (probably a monoradical). After decay, the signal of this radical can be regenerated by addition of lead dioxide.

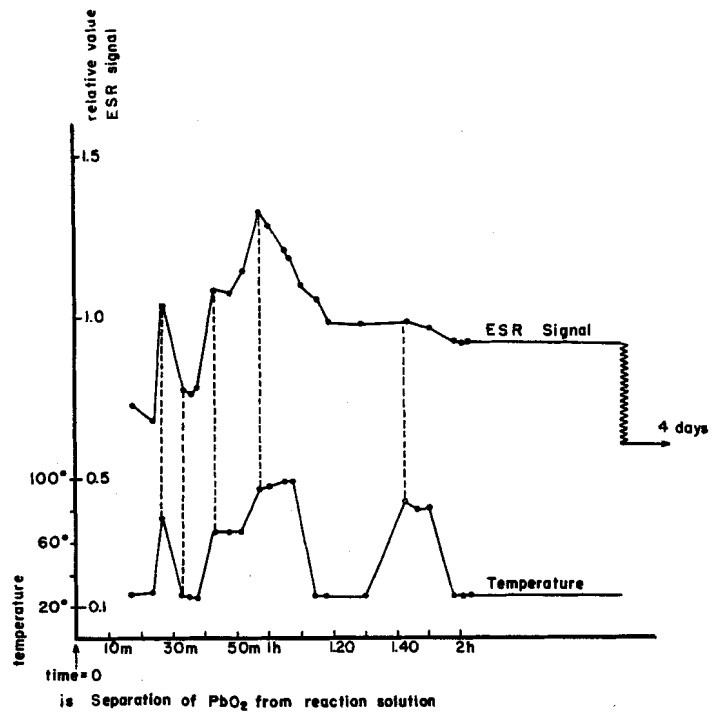

MU-11592

Fig. 10. Influence of temperature on the intensity of the ESR signal of the hindered quinone.

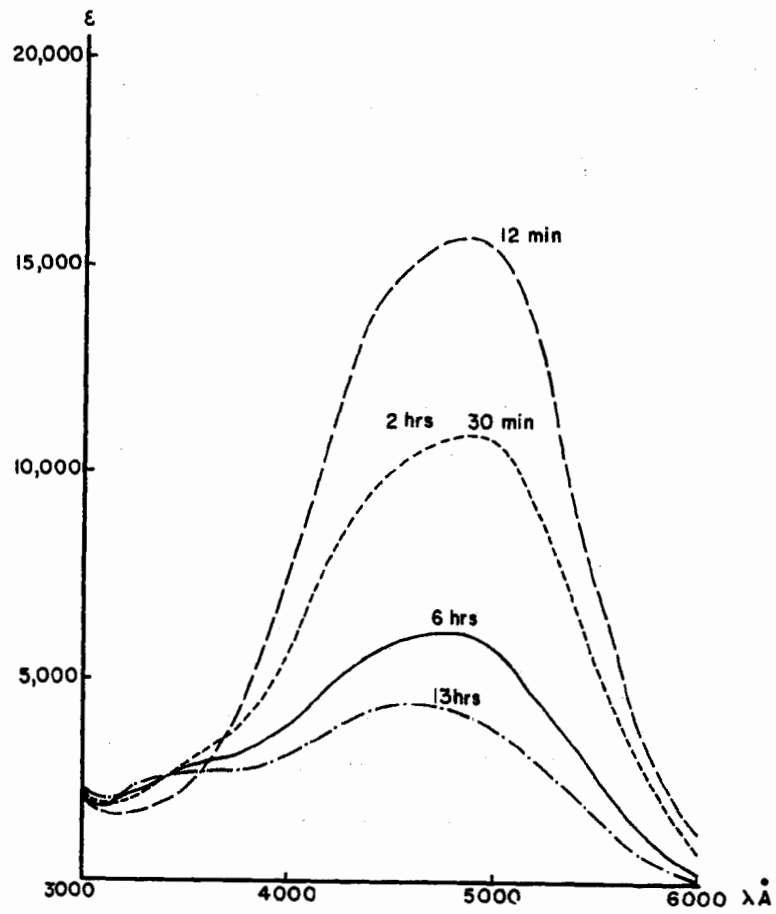

MU-11593

Fig. 11. Decay of the hindered quinone in a concentrated benzene solution (0.1 mol/liter) under vacuum as a function of time (spectra in benzene).

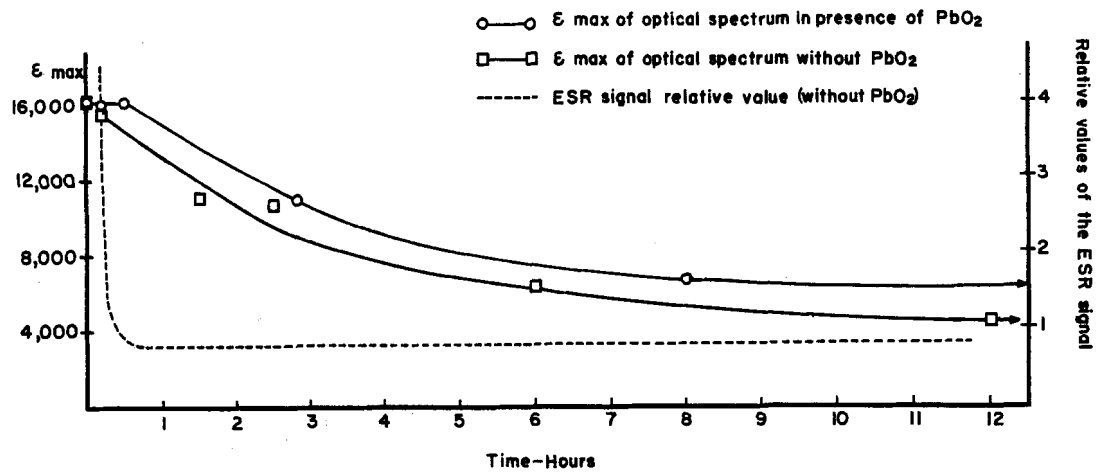

MU-11594

Fig. 12. Decay of quinone and radical as a function of time (0.1 mol/liter).

All these solutions are decolorized after one or two days. This fading corresponds to the disappearance of the main band (4440 to 5000 Å, Fig. 11).

The spectra shown in Fig. 13 (Curves 3, 4 and 5) correspond to transformation products from various sources and show the absorption band of phenol (2800 to 2900) and a general increase of absorption below 2800 as compared to the absorption of the quinone (Curve 1) and of the biphenol (Curve 2). Sometimes a peak (Figs. 11 and 13) is found around 3400 to 3600 Å, which could indicate formation of an ortho-quinone LIX by oxidation.

Attempts to Isolate Quinones as Solids

All the above experiments were carried out in solutions. Some attempts were made to prepare a solid sample from 0.01 M solution.

One obtains, in all cases, a red glass, giving, in chloroform, a spectrum similar to the one of Curve 5, Fig. 3, corresponding to the structure LVII. This red glass has a somewhat higher content of free radical (1/100, $G=2.0$). It decays rapidly in the presence of air, more slowly in vacuum, giving a yellow powder. The ESR signal can still be observed, approximately 1/800, in the almost completely transformed material (Curve 3, Fig. 13), indicating the trapping of free electrons in the polymer, which would have a structure derived from LVIII. The analysis of the red glass is in agreement with the theory.

Figure 9 gives a proposal for the complete scheme of oxidation and polymerization. It is an hypothesis that fits quite satisfactorily all of our various observations. The results demonstrate that as few as two ortho-methyl groups in diphenoquinone provide sufficient steric hindrance to coplanarity to raise the energy of the quinone to the point where there is an appreciable amount of oxygen diradical in equilibrium with it at room temperature. Presumably if the reactivity of the oxygen diradical could be further reduced by two additional ortho-*t*-butyl groups it should be possible to obtain the diradical in appreciable amounts. In fact, such a diradical should exceed in stability the phenoxy mono radicals of Muller and Cook.

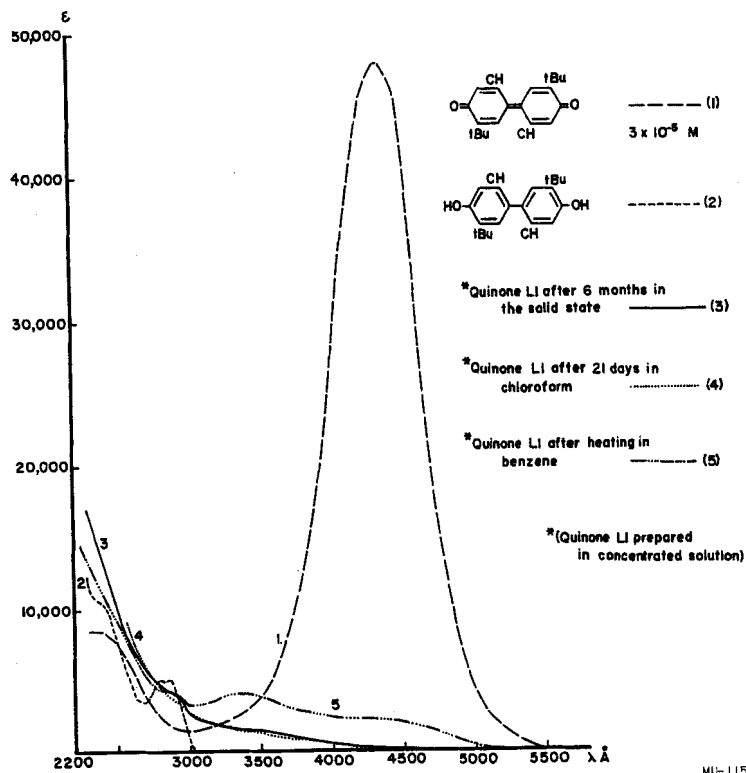

Fig. 13. Spectra in ether. Compounds of transformation of hindered quinone, compared with hindered quinone and hindered biphenol.

PROCEDURES

Preparation of 3,5-dichloro-4-iodonitrobenzene

According to the method described by Schoutissen,¹⁵ a solution of 50 g of 2,6-dichloro-4-nitroaniline (Kodak) in 165 cc concentrated sulfuric acid was cooled to 0°C. To another 165 cc of concentrated sulfuric acid was slowly added 17.5 g NaNO₂, care being taken to keep the temperature below 40°, and the resulting solution of nitrosylsulfuric acid was cooled to 0°C. The two solutions were mixed and allowed to stand 1/2 hr. Then, 600 cc of H₃PO₄ (85%) was added at such a rate as to keep the temperature below 5°C (1.5 hr). The yellow solution was allowed to stand 1/2 hr at 0°, 1 g of urea was added, and the solution was poured into 1 liter of ice water containing 42 g of potassium iodide. The decomposition of the diazo compound produced much foam, and the iodo compound precipitated as a light brown product. After 1 hour the precipitate was filtered, washed with water, and recrystallized from alcohol. Yield: 63 g (82%), mp 151–153°.

Preparation of 2,2', 6,6'-tetrachloro-4,4'-dinitrodiphenyl

This compound had previously been prepared by Ridge¹⁶ by deamination of 2,6-dichloro-4-nitroaniline, but with poor yields. A different procedure was used: 40 g of 3,5-dichloro-4-iodo-nitrobenzene was melted in a large test tube at 240–250°, and 0.5 g of bronze copper was added. The reaction caused the mixture to boil and it was sometimes necessary to cool it. The rest of the copper (15 g) was slowly added over a period of 1/2 hr, the temperature being kept at 250–260°. The mixture was extracted, while still hot, with boiling benzene. The solution was chromatographed on alumina to eliminate the tars. The product obtained was contaminated with a yellow oil and was recrystallized from AcOH, yielding 9.5 g of yellow crystals (37%), mp 181–182°.

Preparation of 2,2', 6,6'-tetrachlorobenzidine

This compound had been previously prepared by benzidine rearrangement^{17, 18} of 3,3', 5,5'-tetrachlorohydrazobenzene with H₂SO₄ in very poor yield. An attempt to prepare this compound by the reduction of the 2,2', 6,6'-trichloro-4,4'-dinitrodiphenyl by zinc and acid (AcOH, HCl) in various solvents (AcOH, EtOH) gave a product that was impossible to crystallize. However, catalytic hydrogenation (PtO₂) of this product gave a pure crystalline benzidine in good yield. The hydrogenation was carried out by using 390 mg PtO₂, 600 mg dry Na₂SO₄, 200 cc cyclohexane, and 2 g of the dinitro compound. The theoretical quantity of hydrogen was taken up in 2 hr., giving a light-yellow solution. The catalyst was filtered off and washed several times with ether, and then the combined solutions were concentrated; 1.37 g of tetrachlorobenzidine (light yellow needles) was obtained. Yield: 81%, mp ca 207°. After purification, the melting point was raised to 212–213°. The benzidine gives a dihydrochloride and a diacetyl derivative (acetylation with acetic anhydride and pyridine on a steam bath, crystallization from AcOH), mp 314°. Titration of the diamine was done by acetylation.¹⁹ Result: 1.98 amino groups.

Anal. Calcd. for $C_{12}H_8N_2Cl_4$: C, 44.75; H, 2.5; N, 8.69; Cl, 44.04.
Found: C, 45.03; H, 2.74; N, 8.97; Cl, 42.64.

Diacetylated derivative. Calcd. for $C_{16}H_{12}N_2Cl_4$: C, 47.31; H, 2.97; N, 6.89; Cl, 34.92. Found: C, 47.52; H, 2.95; N, 7.03; Cl, 34.70.

Preparation of 2,2', 6,6'-tetrachloro-4,4'-biphenol

The diamine (1 g) was dissolved in concentrated H_2SO_4 (20 cc) and cooled to $0^\circ C$. $NaNO_2$ (450 mg) was slowly dissolved in concentrated H_2SO_4 (20 cc) at a temperature below $40^\circ C$. The two solutions were mixed at $0^\circ C$ and 35 cc H_3PO_4 (85%) was added slowly so that the temperature remained below $5^\circ C$. After 1 hour, this solution was poured into aqueous H_2SO_4 (110 cc acid for 140 cc water) and the acidic solution was boiled 12 min and then poured onto ice. A precipitate was obtained and the product was extracted from the suspension with ether; the ether solution was then extracted several times with 5 N NaOH, and the product was precipitated from the reddish alkaline solution by the addition of dilute HCl. The product obtained was extracted with ether, the resulting ether solution was washed with water and dried, and the ether was removed under vacuum. A yellow oil was obtained which crystallized slowly. The crude product was purified by sublimation ($160^\circ/1$ mm). Yield: 760 mg (76%); mp $185-186^\circ$; after resublimation, 186° . Diacetyl derivative (pyridine, acetic anhydride, purification in acetic acid), mp $164-165^\circ$.

Anal. of tetrachlorobiphenol: Calcd. for $C_{12}H_6O_2Cl_4$: C, 44.48; H, 1.86; Cl, 43.77. Found: C, 44.55; H, 2.01; Cl, 43.75. The titration of the tetrachlorophenol by alkali gave 1.98 phenolic hydroxyl groups.

Preparation of 2,2', 3,3', 5,5', 6,6'-octachloro-4,4'-biphenol

This compound (XXV) has been described by Smith,⁹ but it is believed to be a mixture of different octachlorobiphenols. Here, a different method of preparation was used. The tetrachlorobiphenol (0.5 g) was dissolved in $CHCl_3$ (30 cc). A rapid current of chlorine was passed through the solution for 10 min. The excess chlorine and chloroform were removed under vacuum. The crystalline residue was purified by sublimation ($200^\circ/1$ mm), to give 660 mg. Yield: 95% mp $237-237.5^\circ$; pure product, mp 238° .

Anal. Calcd. for $C_{12}H_2O_2Cl_8$: C, 31.2; H, 0.43; Cl, 61.4. Found: C, 31.07; H, 0.69; Cl, 61.42.

The diacetyl derivative was prepared with hot acetic anhydride and a drop of H_2SO_4 and recrystallized from acetic acid, mp 195° .

Anal. Calcd. for $C_{16}H_6O_4Cl_8$: C, 35.2; H, 1.1; Cl, 51.96. Found: C, 35.36; H, 1.27; Cl, 51.84.

Preparation of 2,2',3,3',3',3',5,5',6,6'-decachloro-3,3',4,4'-
tetrahydro-4,4'-diketodiphenyl

The tetrachlorobiphenol (250 mg) was dissolved in acetic acid (25 cc) and a rapid current of chlorine was passed through the hot solution until saturated (1/2 hr). Then 7 cc of water was added and a crystalline product precipitated on cooling. The product was washed with water and dried. Yield: 390 mg (96%), mp 190–191°. It was recrystallized from boiling acetic acid–water, mp 191.5–192°. It is soluble in AcOH, ether, CHCl₃; less soluble in alcohol.

Anal. Calcd. for C₁₂H₂Cl₁₀: C, 27.15; H, 0; Cl, 66.81. Found: C, 27.27; H, 0.45; Cl, 66.46.

This product could be obtained also by action of the same reagent (chlorine in AcOH) on the octachlorobiphenol with a yield of 92%.

Reduction of the Decachloro Compound (XXXIII)

1. By Zn and AcOH: 24 mg of the compound was dissolved in 1 cc acetic acid. The solution was decolorized by boiling for 2 min in the presence of zinc powder, then 2 cc of water was added to precipitate the product. Yield: 91%, mp 234°.

2. By alcohol: This reaction has been studied by uv as a function of time. The decachloro compound (4.8 mg) was dissolved in 50 cc of alcohol and the uv spectrum was taken from time to time. The reaction was complete after 24 hr. The same behavior toward alcohol has been observed with the hexachlorophenol, but the reaction was much slower (about 280 hr).

Action of Silver on the Decachloro Compound (XXXIII)

The active silver was prepared by reduction of AgCl in alkaline solution of hydroxylamine.⁵ The reaction was carried out under nitrogen free from oxygen in anhydrous benzene, which had been dried by distillation from metal cetyl of benzophenone. The nitrogen was purified by passing through Fieser's solution, through an aqueous solution of lead acetate, through concentrated H₂SO₄, and finally through a solution of metal cetyl of benzophenone in ether. The blue color of the ether solution indicated the absence of oxygen and water.

In a two-armed flask was placed a solution of 50 mg of the decachloro compound in 25 cc of benzene and 500 mg of active silver. Nitrogen was bubbled through the suspension for 1/2 hr. Then the flask was cooled at -80°C, the two arms were sealed, and the flask was shaken for 16 hr at room temperature. No reaction seemed to have occurred. The silver was filtered off and washed with ether, and the solvents were removed to give a yellow crystalline substance. The uv spectrum showed that this compound was the unchanged starting material. Heating a mixture of the decachloro compound with active silver under vacuum (200°/1 mm) resulted only in sublimation of the starting material.

Attempts to Prepare the 3,3'-dibromo-2,2', 3,3', 5,5', 6,6'-
octachloro-4,4'-diketo-3,3'-4,4'-tetrahydrodiphenyl

1. The addition of bromine to a boiling methanol solution left the octachloro-biphenol unchanged.
2. The addition of bromine to a cold or boiling acetic acid solution of biphenol gave no reaction.
3. The addition of bromine to an acetic acid solution of biphenol in the presence of a 15% excess of sodium acetate at 10° for 12 hr gave no crystalline products.
4. Reaction (3) was carried out with twice the quantity of sodium acetate for 8 days. A yellow precipitate, insoluble in alcohol, chloroform, benzene, boiling acetic acid, or water, was slowly formed. This product did not melt at 310° and could not be sublimed. It was probably polymeric.

Preparation of 2,2', 6,6'-tetrachloro-3,3', 5,5'-tetrabromo-4,4'-biphenol

Fifty mg of tetrachlorobiphenol was dissolved in 5 cc N NaOH. To this solution 100 mg of bromine in 10 cc N NaOH was added. The yellow solution was rapidly decolorized. After half an hour it was neutralized and extracted with ether. After removal of the ether, the residual oil crystallized slowly and was sublimed at 200°/1 mm mp 251-252°. The product was recrystallized from aqueous alcohol (50%), mp 257-258° with decomposition.

Anal. Calcd. for C₁₂H₂O₂Cl₄Br₄: C, 22.4; H, 0.32; Cl, 22.18; Br, 49.80.
Found: C, 22.75; H, 0.49; Cl, 21.5; Br, 48.2.

(Bromine was calculated assuming that the molecule contained four chlorines.)

Attempts to Prepare the 3,3', 5,5'-tetrabromo-2,2', 3,3', 6,6'-
hexachloro-4,4'-diketo-3,3', 4,4'-tetrahydrodiphenyl

1. Action of an excess of chlorine on the biphenol in an acetic acid solution at room temperature gave the decachloro compound previously described.
2. The technique of Muller,⁵ i. e., action of chlorine in a solution of biphenol in MeOH, AcOH at -20°C, yielded 99% of the decachloro compound.

Preparation of 2,2'-dimethyl-4,4'-dinitrodiphenyl

This compound was prepared according to the procedure of Sherwood and Calvin.²⁰ The product was recrystallized from ethanol in the presence of charcoal. Yield: 30%, mp 170°.

Preparation of 2,2'-dimethylbenzidine hydrochloride

This product was prepared by two methods:

1. By reduction of 2,2'-dimethyl-4,4'-dinitrodiphenyl. Nine hundred mg of dinitro compound was dissolved in 25 cc ethanol. Then HCl and Zn were added to the boiling solution until the reduction was complete (1.5 hr). The solution was neutralized with Na_2CO_3 and extracted with ether, which was evaporated to dryness. The residue from the ether extract was dissolved in dilute HCl and the hydrochloride was precipitated by the addition of concentrated HCl. Yield: 60%.
2. Preparation according to the method of Schultz and Rohde²¹ and purification as above. Yield: 80%.

Anal. Calcd. for $\text{C}_{14}\text{H}_{16}\text{N}_2\text{Cl}_2$: C, 58.95; H, 6.36; N, 9.82; Cl, 24.86.
Found: C, 59.11; H, 6.27; N, 9.75; Cl, 24.66.

Preparation of 2, 2'dimethyl-4,4'-biphenol

This compound was prepared according to the method of Brockmann and Dolars²² and recrystallized from benzene. Yield: 90%, mp 116°.

Preparation of 2,2'-dimethyl-5,5'-di-t-butylbiphenol

According to the method of Stillson, Sawyer, and Hunt,¹³ 2g of dimethyl-2,2'-biphenol was dissolved in 70 cc benzene at 60–70°, then 0.1 cc of concentrated sulfuric acid was added and isobutylene passed through the solution by means of a sintered glass bubbler for 6 hr.

The solution was washed three times with 2 N NaOH, dried and concentrated. The resulting crystalline colorless product was contaminated with an oil which was absorbed by pressing the product between filter paper. The white crystals (1.75 g) obtained were sublimed at 170–200° under 1 mm. Yield: 1.3 g (41%), mp 213–214°.

Anal. Calcd. for $\text{C}_{22}\text{H}_{30}\text{O}_2$: C, 80.9; H, 9.26. Found: C, 81.05 and 81.09; H, 9.65 and 9.04.

This biphenol is soluble in benzene or ether, and insoluble in 2 N NaOH.

Oxidation of Biphenols

Solvents used: benzene, purified as indicated above; ether; anhydrous Merck, dried over sodium, then distilled and kept over sodium; water, distilled; acetic acid, analytical reagent. Nitrogen was free from oxygen (see above).

1. Oxidation by active lead dioxide in moist ether at 0°. ³ The lead dioxide used here and in the following experiments was prepared according to the technique of Kuhn and Hammer²³ by hydrolysis of lead tetraacetate.

Technique of oxidation and results: 10 to 15 mg of phenol was dissolved in 25 cc of moist ether, cooled at 0°, then shaken at 0° with 1 g lead dioxide for 5 min. The following results were obtained.

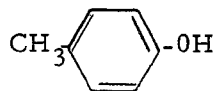

- weak violet coloration, disappearing in a few minutes.

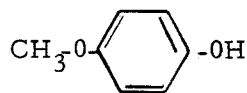

- strong blue coloration, disappearing in 20 to 25 min.

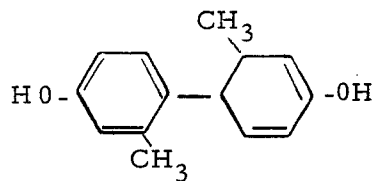

- no coloration, but polymers.

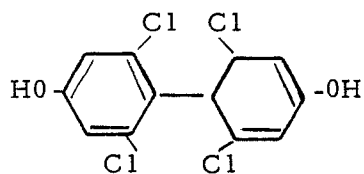

- no coloration.

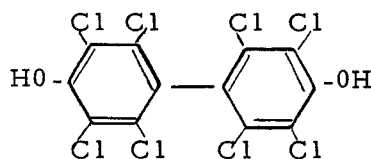

- no coloration.

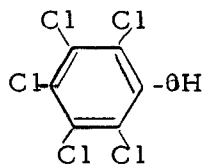

-no coloration.

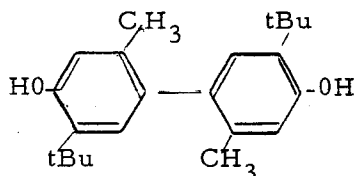

- deep red coloration, stable several hours.

2. Oxidation by silver oxide, prepared according to Willstatter¹⁰ in anhydrous ether with dry sodium sulfate.
3. Oxidation by lead dioxide, prepared as above, in anhydrous ether or benzene, in air or under nitrogen.
4. Oxidation with potassium ferricyanide in alkaline solution.⁵ The reaction was carried out in a 100-cc two-necked flask with 100 mg biphenol in 15 cc benzene. The flask was cooled to -80° and then a solution of 1 g potassium ferricyanide in 5 cc 2 N KOH was added under nitrogen. Nitrogen was passed through the flask for 15 min, then the flask was sealed and shaken at room temperature. Results of the reaction were observed by uv spectrum.

Oxidation of 2,2'-dimethyl-5,5'-di-t-butylbiphenol

In all the experiments a large excess of lead dioxide (5 to 10 times) was used.

Spectral and ESR Studies on Solutions

1. Concentration 3×10^{-5} mol/liter. A solution of biphenol in benzene or ether (Curve 1, Fig. 3 and Curve 1, Fig. 13) was shaken with lead dioxide directly in the quartz cell of the spectrophotometer for 2 to 30 min. Then the cell was centrifuged for a few minutes and the optical spectrum was taken immediately. The reaction was complete after 2 min. The same results were obtained when the experiment was carried out in an atmosphere of nitrogen.
2. Concentration 10^{-3} mol/liter. (Curve 2, Fig. 3) A special apparatus (Fig. 14a) was designed which made it possible to use the same sample of solution for optical and ESR spectra. The solution was free of lead dioxide and oxygen. The thickness of the pyrex optical cell was 0.25 mm. After the solution of biphenol was introduced into the flask, the apparatus was sealed at (a) under high vacuum and the solution was frozen in liquid nitrogen. Then the apparatus was tilted in such a way as to allow the iron weight (d) to break the thin wall (c). The liberated lead dioxide was poured onto the frozen solution, the flask was sealed at (b), and the solution was heated up to room temperature. After the solution was shaken 2 min to lead dioxide was centrifuged, and when the apparatus was turned upside down the solution filled the optical cell (e) and the side arm (f), making it possible to take the optical spectrum through (e) and the magnetic signal on (f). Result: $\lambda_{\max} = 4450 \text{ \AA}$, $\Sigma_{\max} = 39,600$. ESR signal: 1 electron for 1000 to 2000 molecules. After longer shaking (5, 10, 30 min) a decrease of Σ_{\max} was observed, but there was no appreciable change in the ESR signal, indicating that the reaction was complete in less than 2 min.
3. Concentration greater than 10^{-3} mol/liter. Reactions were carried out under vacuum in the apparatus shown in Fig. 14b. After 15 min of shaking (enough time to insure a complete reaction in all cases) the apparatus was centrifuged at 1000 rpm for 1 min and the red solution decanted into the side arm where the ESR measurement could be taken directly. To take the optical spectrum the apparatus was opened at (a) and an aliquot of the solution was rapidly diluted with the adequate amount of benzene previously placed in the cell of the spectrophotometer (Curves 3, 4, 5, Fig. 3, Fig. 4, Fig. 11, Fig. 12).

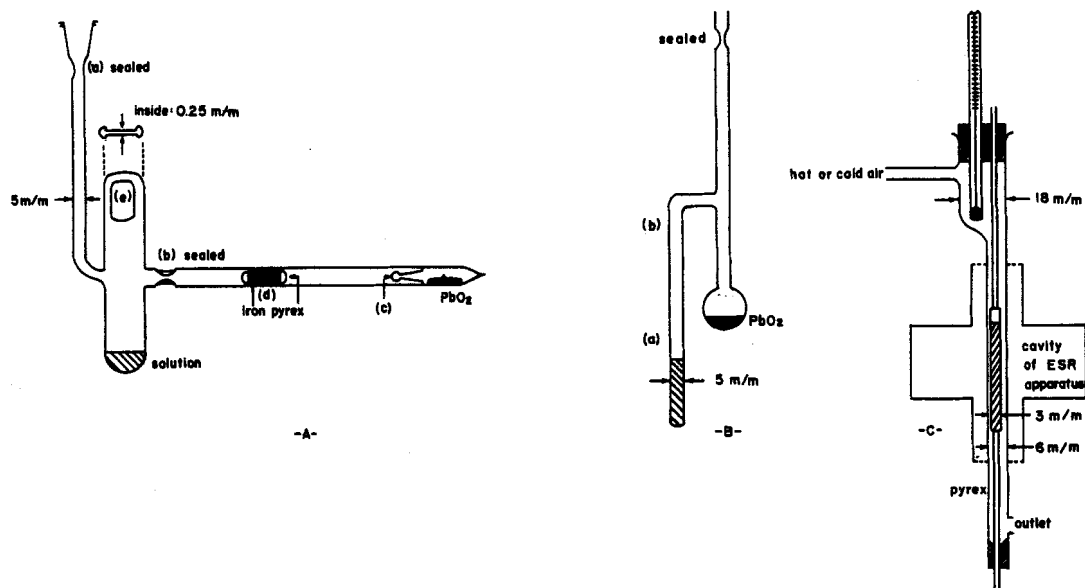

MU-11598

Fig. 14. (a) Apparatus to study ESR signal and optical spectrum of the quinone LI in dilute solution under vacuum.

(b) Apparatus to study ESR signal of quinone LI in concentrated solution.

(c) Equipment for temperature-dependency study of the hindered polymeric quinones.

4. Titration of the solution (10^{-3} to 10^{-2} mol/liter). The oxidation was carried out by shaking the benzene solution with potassium ferricyanide and 2 N sodium hydroxide for 15 to 30 min. The solution was washed with water and an aliquot was added to sodium iodide in acetic acid, whereupon the color of the solution changed from red to orange. This solution was titrated with 0.10 N sodium thiosulfate. Results: 0.24, 0.4, 0.44, 0.42 oxidation equivalents per molecule. The first measurement was made under pure nitrogen. Theory for the quinone LI: 2 equivalents; for the dimer, 1 equivalent; for the trimer, 0.66 equivalent.

Action of p,p'-biphenol on the Hindered Diphenoquinone LI

The diphenoquinone LI was prepared by shaking a benzene solution of the hindered biphenol (3×10^{-5} M) with lead dioxide for 4 min. The orange solution ($\Sigma_{\max} = 44,500$) was added to an ether solution of biphenol (3 mol for 1 mol). The spectrum of the resulting solution was taken from time to time (Fig. 6a) until the completion of the reaction.

The concentration of quinone LI was calculated from the initial amounts of hindered biphenol. The amount of the diphenoquinone produced was calculated from the Σ of the absorption band.

Action of p,p'-biphenol on the Polymeric Diphenoquinones

The quinones were prepared by shaking under vacuum for 15 min a benzene solution of hindered biphenol (0.01 M) with lead dioxide (Fig. 6b). An aliquot of the resulting solution was diluted 1000 times and added to the same volume of an ether solution of biphenol (7 mol per mol of initial hindered biphenol). The reaction was followed by uv spectrum as above. Calculations were made on the same basis.

Action of Hindered Biphenol XLIX on the Hindered Quinone LI

The quinone LI was prepared in dilute solution as above (Curve 1, Fig. 8). Its decay in benzene (Curve 1, Fig. 7) was followed by the decrease of the Σ_{\max} at 4440 Å. (Curve 4, Fig. 8): 20 cc of a solution of diphenoquinone LI ($c = 3.07 \times 10^{-5}$) was mixed with 10 cc of a solution of the hindered biphenol (same concentration). When the reaction mixture was heated at about 60° for 40 min there was a 90% decrease in the absorption band, then the solution was shaken for 2 min with lead dioxide and the spectrum was taken again.

Temperature-Dependency Study

The reaction was performed in an apparatus similar to B (Fig. 14) having a side arm of 3 mm diameter. The side arm was sealed off and placed in the apparatus (C) as is shown in Fig. 14. The apparatus was previously standardized with a thermocouple. The heating system consisted of a hot stream of air at various temperatures. The intensity of the ESR signal and the corresponding temperatures were recorded. (Fig. 10).

Red Glass

1. Oxidation with lead dioxide: One hundred mg of biphenol was dissolved in 30 cc of benzene and the mixture was shaken in the presence of 2 g of lead dioxide for 15 to 30 min. After centrifugation the solvent was removed under vacuum at room temperature ($10-20^{\circ}$), giving a red glass, which was left 2 hr under 1 mm pressure before analysis.

Oxidation under nitrogen: The apparatus was composed of two flasks connected by a piece of sintered glass to filter the lead dioxide (Fig. 15). After the apparatus had been filled with pure nitrogen and sealed at (a), the reaction was performed in Flask A, the solvent was filtered into Flask B by pressure of the nitrogen; B was kept at 10° and A was frozen at -80° , under vacuum, and the benzene was distilled in to A. A red glass was obtained in B and dried under 1 mm pressure.

2. Oxidation with potassium ferricyanide: The same solutions of biphenol were used. The oxidant was a solution of 2 g of potassium ferricyanide in 20 cc of 2 N sodium hydroxide. The two solutions were shaken together for 15 to 30 min and the layers were separated. The benzene layer was washed with water, dried over sodium sulfate, and evaporated at room temperature under vacuum, giving a red glass.

Oxidation under nitrogen (pure nitrogen was bubbled through all solutions and solvents before they were used): The reaction was carried out in a special separatory funnel (Fig. 16) filled with nitrogen and kept at 10° . After being shaken in the separatory funnel for 30 min the layers were separated; the red benzene layer was washed with boiled water, then dried over sodium sulfate in an apparatus (Fig. 15) filled with nitrogen; it was then filtered and evaporated as indicated above, giving the same red glass.

Anal. Calcd. for $C_{22}H_{28}O_2$: C, 81.43; H, 8.69. Found: (I) C, 80.05; H, 8.67. (II) C, 81.67; H, 8.72. (III) C, 80.20; H, 8.93. (IV) C, 80.39; H, 8.93.

(I) was prepared by oxidation with lead dioxide in the presence of air and dried at room temperature. (II) was prepared by oxidation with potassium ferricyanide under nitrogen and dried at 35° . (III) was prepared by oxidation with potassium ferricyanide under nitrogen and dried at room temperature. (IV) was prepared by oxidation with lead dioxide under nitrogen and dried at room temperature.

Preparation of 3,3'-dimethyldiphenquinone

This compound was prepared by boiling a solution of 3,3'-dimethylbiphenol (34 mg) in 2 cc of benzene with lead dioxide (700 mg) for 5 min. The lead dioxide was separated and extracted several times with boiling benzene. The resulting orange solution was concentrated to 5 cc yielding 15 mg of quinone (dark red needles); $\lambda_{\max} = 4090 \text{ \AA}$ $\Sigma_{\max} = 65,000$ (Benzene).

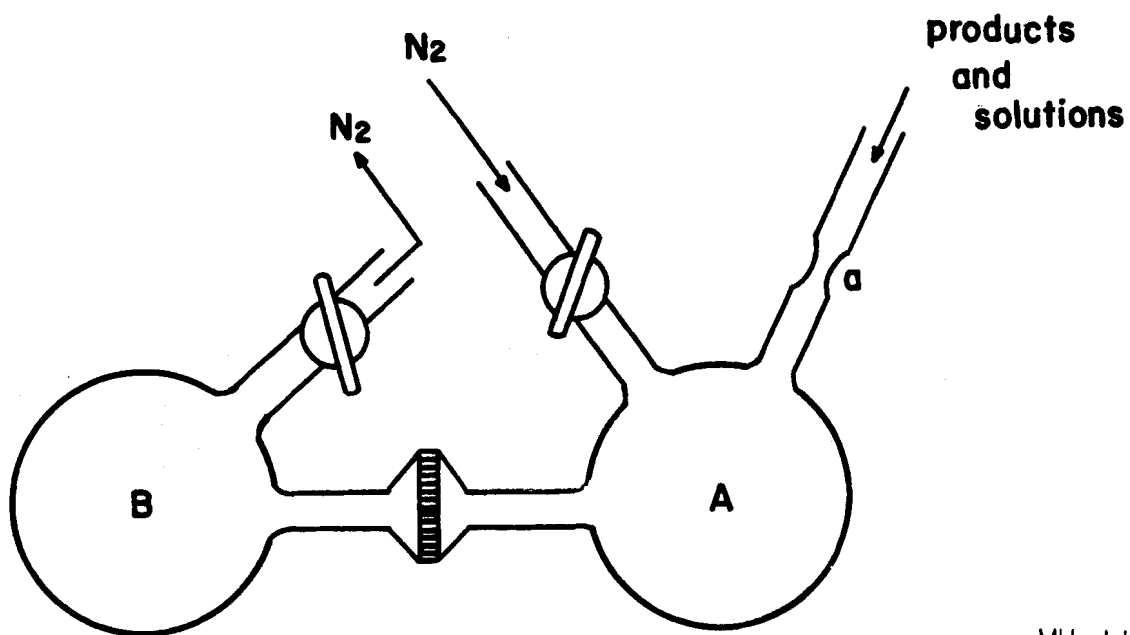

MU-11597

Fig. 15. Apparatus to prepare the hindered diphenoquinone in the solid state by oxidation with lead dioxide.

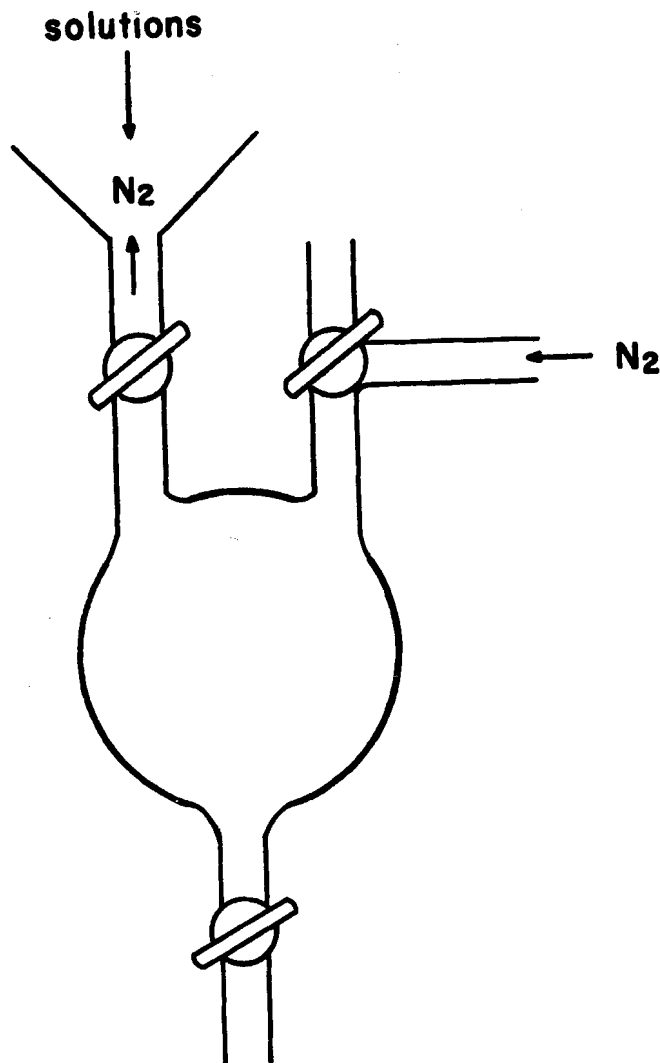

MU-11598

Fig. 16. Apparatus to prepare the hindered diphenoquinone in the solid state by oxidation with ferricyanide.

Preparation of Diphenoquinone

This compound was prepared from p,p'-biphenol by the procedure described above. Dark orange needles resulted; $\lambda_{\text{max}} = 3985 \text{ \AA}$; $\Sigma_{\text{max}} = 53,200$ (benzene).

All spectra were taken with a Cary recording spectrophotometer (Model 11 or 14) at a concentration of approximately 10^{-4} M. Electronic spin resonance absorption measurements (ESR) were performed with equipment built by Dr. Power B. Sogo of the Radiation Laboratory. Analyses were performed by Dr. Charles Koch of the Microanalytical Laboratory of the Department of Chemistry.

This work was performed under the auspices of the U.S. Atomic Energy Commission.

REFERENCES

1. Theilacker and Ozegowski, Ber. 73, 33 (1940); Ber. 73 898 (1940).
2. Muller and Neuhoff, Ber. 72, 2063 (1939); Ber. 74, 807 (1941).
3. Goldschmidt, Ber. 55, 3194 (1922).
4. Pummerer, Schmidutz, and Seifert, Ber. 85, 535 (1952).
5. Muller and co-worker, Ber. 87, 922 (1954); Ber. 87 1605 (1954).
6. Cook and co-workers, J. Org. Chem. 18, 261 (1953); J. Am. Chem. Soc. 75, 6242 (1953); J. Am. Chem. Soc. 77, 1783 (1955); J. Am. Chem. Soc. 78, 2002 (1956).
7. Grubb and Kistiakowsky, J. Am. Chem. Soc. 72, 419 (1950); Nielsen and Fraenkel, J. Chem. Phys. 21, 1619 (1953); Theilacker, Kortum, and Friedheim, Ber. 83, 508 (1950).
8. Matlow, J. Chem. Phys. 23, 152 (1955).
9. Valyashko and Scherlak, J. Gen. Chem. U.S.S.R. 8, 1597 (1938);
XXI: Henrich, Ber. 71, 2049 (1938); Henrich, Sitzber. physik. med. Sozietat Erlangen 71, 199 (1939) (ACA 33, 165).
XXII: Bordeianu and Jassy, Universite Ann. Scient. 23, 240 (1937), (ACA 5803, 1933).
XXIII: Sanna and Zucca, Cagliari Univ. Sc. Seminario Rendiconti 19, 155 (1939) (ACA 7087, 1952).
XXIV: Levine, J. Am. Chem. Soc. 48, 797 2719 (1926).
XXV: Smith and Groves, Monsanto U.S. Patent 2.449.008, Sept. 14, 1948 (ACA 813c, 1949).
10. Willstatter and Muller, Ber. 41, 2580 (1908).
11. Beilstein, VI, 194.
12. Hunter and Morse, J. Am. Chem. Soc. 48, 1615 (1926).
13. Stillson, Sawyer, and Hunt, J. Am. Chem. Soc. 67, 303 (1945).
14. Schlatter and Clark, J. Am. Chem. Soc. 75, 361 (1953); Burgoyne, Close and Watson, J. Org. Chem. 20, 1508 (1955).
15. Schoutissen, J. Am. Chem. Soc. 55, 4531 (1933).
16. Ridge, J. Chem. Soc. 1947, 734.
17. Van Roosmalen, Rec. trav. chim. 53, 375 (1934).
18. Carlin and Forshey, J. Am. Chem. Soc. 72, 793 (1950).
19. Siggia, "Quantitative Organic Analysis Via Functional Groups," Wiley New York, 1949, p.5.
20. Sherwood and Calvin, J. Am. Chem. Soc. 64, 1350 (1942).
21. Schultz and Rohde, Chem. Zeit. II, 1447 (1902).
22. Brockmann and Dolars, Ber. 85, 1180 (1952).
23. Kuhn and Hammer, Ber. 83, 413 (1950).