

# Lawrence Berkeley National Laboratory

## LBL Publications

### Title

Resilient buildings for fire-adapted landscapes: EE and flexible loads integrated with solar and storage microgrids

### Permalink

<https://escholarship.org/uc/item/88c869vt>

### Authors

Alstone, Peter  
Brown, Richard  
Zoellick, Jim  
et al.

### Publication Date

2020-08-01

Peer reviewed



# Lawrence Berkeley National Laboratory

## Resilient buildings for fire-adapted landscapes: EE and flexible loads integrated with solar and storage microgrids

Peter Alstone<sup>1,2</sup>, Rich Brown<sup>2</sup>, Jim Zoellick<sup>1</sup>, Marco Pritoni<sup>2</sup>, David Blum<sup>2</sup>, Kristen Radecsky<sup>1</sup>, Kun Zhang<sup>2</sup>, Anand Prakash<sup>2</sup>, and Pol Perez<sup>2</sup>

<sup>1</sup>Schatz Energy Research Center / Humboldt State University, and <sup>2</sup>Lawrence Berkeley National Laboratory

Energy Technologies Area  
August 2020

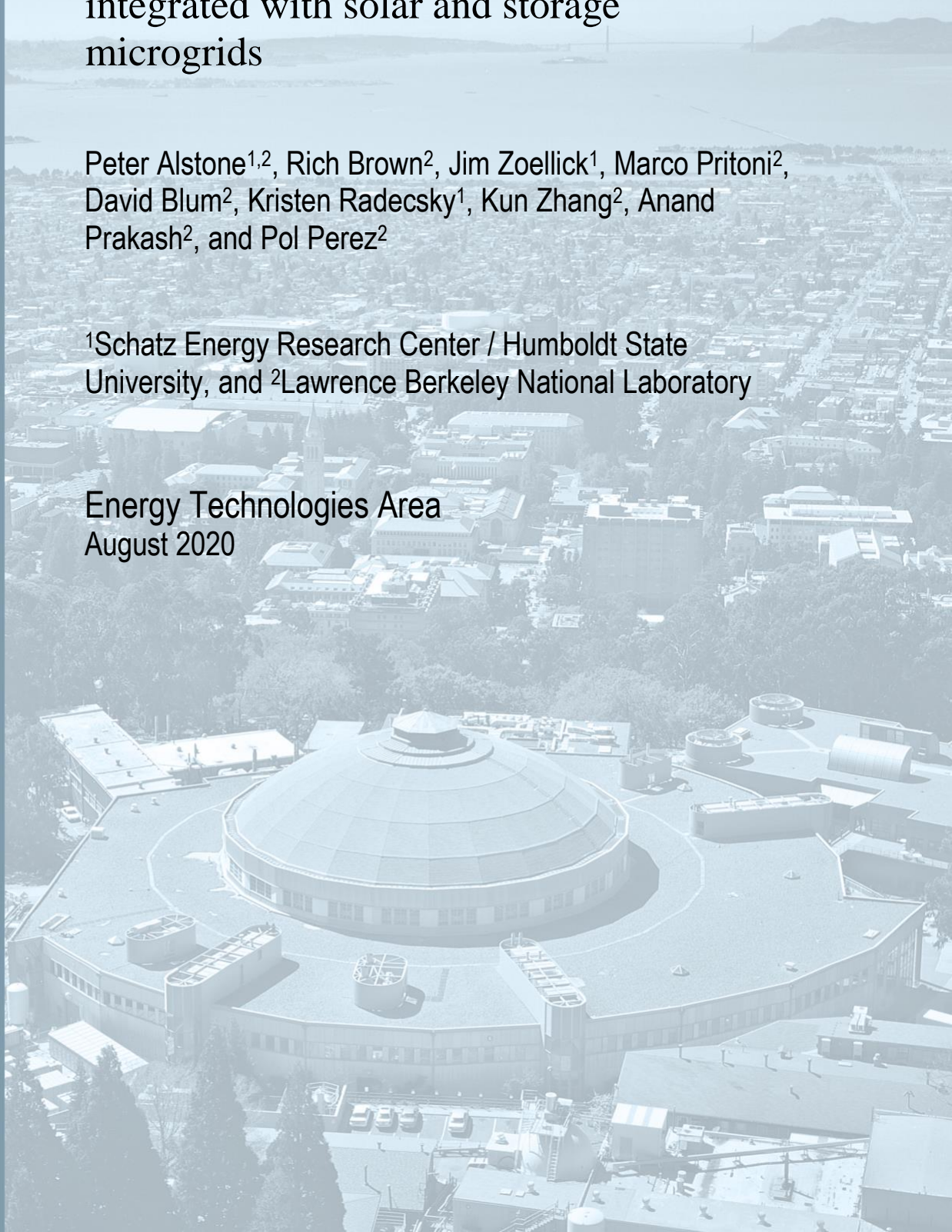

Disclaimer:

This document was prepared as an account of work sponsored by the United States Government. While this document is believed to contain correct information, neither the United States Government nor any agency thereof, nor the Regents of the University of California, nor any of their employees, makes any warranty, express or implied, or assumes any legal responsibility for the accuracy, completeness, or usefulness of any information, apparatus, product, or process disclosed, or represents that its use would not infringe privately owned rights. Reference herein to any specific commercial product, process, or service by its trade name, trademark, manufacturer, or otherwise, does not necessarily constitute or imply its endorsement, recommendation, or favoring by the United States Government or any agency thereof, or the Regents of the University of California. The views and opinions of authors expressed herein do not necessarily state or reflect those of the United States Government or any agency thereof or the Regents of the University of California.

# **Resilient buildings for fire-adapted landscapes: EE and flexible loads integrated with solar and storage microgrids**

*Peter Alstone<sup>1,2</sup>, Rich Brown<sup>2</sup>, Jim Zoellick<sup>1</sup>, Marco Pritoni<sup>2</sup>, David Blum<sup>2</sup>, Kristen Radecky<sup>1</sup>, Kun Zhang<sup>2</sup>, Anand Prakash<sup>2</sup>, Pol Perez<sup>2</sup>*

*<sup>1</sup>Schatz Energy Research Center / Humboldt State University,  
<sup>2</sup>Lawrence Berkeley National Laboratory*

## **ABSTRACT**

Energy efficiency (EE) and flexible loads can be part of a resilient buildings package when they are combined with solar and storage in a clean energy microgrid to reduce the carbon footprint of buildings and enable resilience to extreme events. Recent large wildfires and an emerging understanding of the fire-adapted landscapes in the American West underscore the urgency of work towards scaling and commercializing these systems. For example, a recent power shutoff in Northern California (October 9-12, 2019) resulted in 738k customers disconnected at the peak of the outage and is emblematic of challenges to come.

Our paper reports on insights from a clean energy microgrid deployment pilot that integrates a 50 kW<sub>AC</sub> PV array, a 109 kW / 174 kWh battery system, switchgear to safely isolate from the regional power system, and communicating controllers for HVAC and refrigeration. The project will be commissioned in May 2020 and is sited at a critical infrastructure site in rural Northern California – in this case a gasoline station with convenience store. Our experience and results shed light on capabilities of integrated microgrids to provide value to customers during blue sky conditions and resilience during black sky days with high fire risk, and what opportunities and barriers exist for scaling these integrated microgrid systems in the near term. We use a simulation model to estimate how EE and flexibility can extend the run time of solar and storage, improving the reliability of power at critical sites.

## Introduction

Wildfire, hurricanes, earthquakes, and other natural disasters put stress on every segment of society. During disaster response, the continued performance and resilience of the built environment is of paramount importance, including critical buildings like homes, grocery stores, fueling stations, hospitals, and others that serve the response and recovery effort. However, in many extreme events the electric power system is unable to stay operational. Conventionally, this has meant critical facilities need to invest in fossil fuel backup generators to maintain continuity of service. With the emergence of low-cost solar photovoltaic (PV) generators and battery storage, microgrids offer a clean energy alternative to backup generators. This paper explores how energy efficiency and load flexibility can be part of a *resilient critical buildings package* that incorporates solar photovoltaic generation, battery storage, switchgear for safe isolation from the regional power system, and building energy systems.

Our study describes a portion of the outcomes from our work to design, deploy, and test a clean energy microgrid at a fueling station in rural Northern California.<sup>1</sup> While the risk of wildfire was one of many threats facing the region at the start of the project in 2017, recent events have brought wildfire resilience to the forefront. Over the last five years in California, 5 million acres have been burned in wildfire and 150 human lives have been lost (CAL FIRE 2020), with countless others exposed to hazardous smoke. Many of these have been ignited by contact and faults on the electric power system, and in an effort to reduce these ignitions electric utilities in California have begun programs of “Public Safety Power Shutoffs.” These PSPS events are planned outages of wide areas during times of heightened fire risk. Between the effects of wildfires themselves and the approach of PSPS, the availability of reliable electric power for preparation, response, and recovery from wildfire is significantly degraded. Microgrids like the one we have deployed could be part of a community resilience strategy to maintain lifeline services before, during, and after wildfires.

There are two aims of this paper: First, we describe the broad opportunity to deploy microgrids in response to the increasing threat of wildfire and how these microgrids can be designed to provide reliable power in the context of the environmental conditions associated with high fire risk (seasonal patterns) and active fire nearby (smoky skies). Second, we describe the potential for demand-side factors like energy efficiency and flexible loads to improve the resilience of microgrids by stretching the runtime during grid outages. Our inquiry and analysis is driven by the example provided through our pilot project.

## Background

Microgrids and wildfire are convergent trends in the age of climate change mitigation and adaptation. Bundling together renewable generation, storage, and advanced demand-side controls in a microgrid combines several technology systems that are beneficial for decarbonization and emissions reduction. Increasing risks to infrastructure from climate change like wildfire drive the value proposition for resilience as well.

---

<sup>1</sup> This project is a partnership between the Schatz Energy Research Center at Humboldt State University, the Blue Lake Rancheria Tribe, and Lawrence Berkeley National Laboratory. The work is funded through support from the California Energy Commission under agreement EPC-17-002.

## Wildfires in California

Wildfire has long been a feature of healthy lands in California and many other regions with “fire-adapted” ecosystems (Van Wagtenonk 2018), but forests stressed by over a century of fire exclusion are burning at an alarming rate. Compounding these forest management problems, the effects of climate change have amplified the risk of fire as well and is fueling an increased incidence of wildfire (Williams et al. 2019). Where we stand today is a state where forests are thick and often primed to burn by hot and dry conditions.

The deadliest and most damaging wildfire in California history was ignited on November 8, 2018 by an electrical transmission fault. The “Camp Fire” ultimately burned over 150,000 acres and claimed 85 lives (CAL FIRE 2020). Electric system faults are a common source of ignition for wildland fire. In response to the increasing risk from status quo operation of the power system in light of forest conditions and aging infrastructure, utilities in California now use public safety power shutoffs (PSPS) to mitigate the risk; in a PSPS there are managed blackouts from de-energizing transmission and distribution lines that run through areas of high risk. Figure 1 is from a post-event summary presentation by Pacific Gas and Electric Company (PG&E) describing a PSPS from October 9-12, 2019 that involved 700,000 customers in Northern California. The threat to reliable power from wildfires is one of several factors that drive the need for resilient power systems at the point of use.

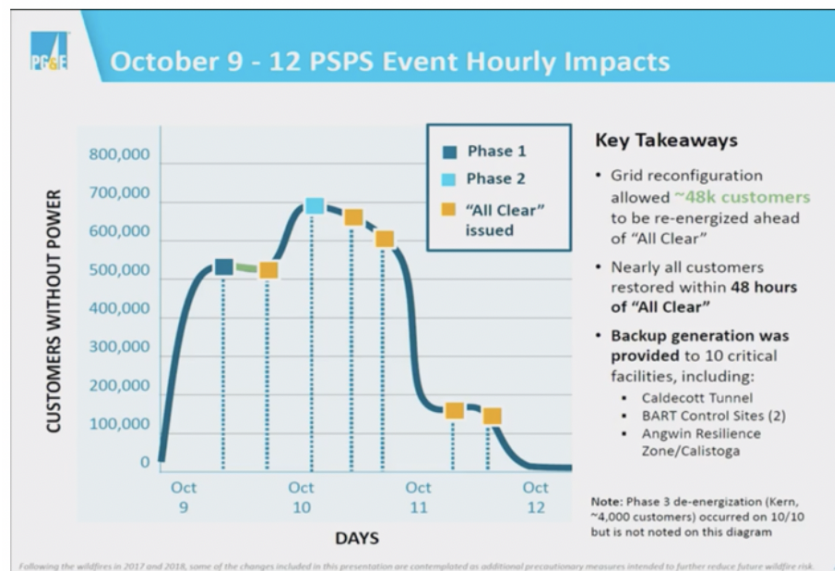

Figure 1: Impacts of Public Safety Power shutoff from October 9-12, 2019, as presented by PG&E on October 18, 2019. From: [http://www.adminmonitor.com/ca/cpuc/voting\\_meeting/20191018/](http://www.adminmonitor.com/ca/cpuc/voting_meeting/20191018/)

## Microgrids

The conventional pathway to resilient power has been to install fossil fuel backup generators with an automatic transfer switch at critical facilities, sometimes in combination with battery-based uninterruptible power supplies (UPS) on particularly critical equipment. While these systems can improve reliability, they are costly and polluting. These fossil fuel backup

systems are also not fully reliable themselves. Threats to the fuel supply chain or generator maintenance issues both introduce risks of failure.

Microgrids are an emerging approach to integrating distributed energy systems. A microgrid is “a low voltage distribution network comprising various distributed generation, storage devices and controllable loads that can operate interconnected or isolated from the main distribution grids” (Lasseter et al. 2002; Dimeas and Hatziargyriou 2005). With their characteristics such as flexible operation modes (grid-connected and islanded mode), more interactions with customers and self-adequacy, microgrids are a promising, reliable and efficient solution for boosting the resilience of distribution power systems (IEEE 2011).

Energy resilience is a key benefit of microgrids. Beyond improving *reliability* by riding through routine “nuisance” blackouts, appropriately designed microgrids also provide *resilience* by sustaining electricity service during disasters and attendant widespread grid outages. Disaster response is when resilient power systems provide their most significant value by enabling continuity of service when it is critically needed.

Thus, sites that are critical for lifeline sectors and continuity of social services are particularly important candidates for microgrids. These include hospitals, first responder stations, grocery stores, and others. At these sites with high values for reliable power in all circumstances and particularly during disaster response, the additional cost of the hardware, software, and integration engineering required for microgrids is balanced by benefits from resilience and reliability.

### **Case Study: Blue Lake Rancheria Playstation 777 Fueling Station**

Our research team is currently developing a microgrid suited for a critical facility in Blue Lake, California: the *Playstation 777* Fueling Station. The site is a fueling station with a convenience store, and is owned and operated by the Blue Lake Rancheria tribe. The microgrid features are illustrated in Figure 2 and summarized in Table 1. The existing site included a typical fueling station and convenience store, with a diesel backup generator behind the store to maintain service through blackouts. Our “Solar+” project will add a microgrid system to the site that includes: a 50 kW<sub>AC</sub> solar PV array, a 109 kW / 174 kWh battery storage system, protective switchgear, and model-predictive control software that dispatches the battery and the HVAC-R systems at the site. At the time we are writing this paper, we are in the final stages of deployment and commissioning of the system.

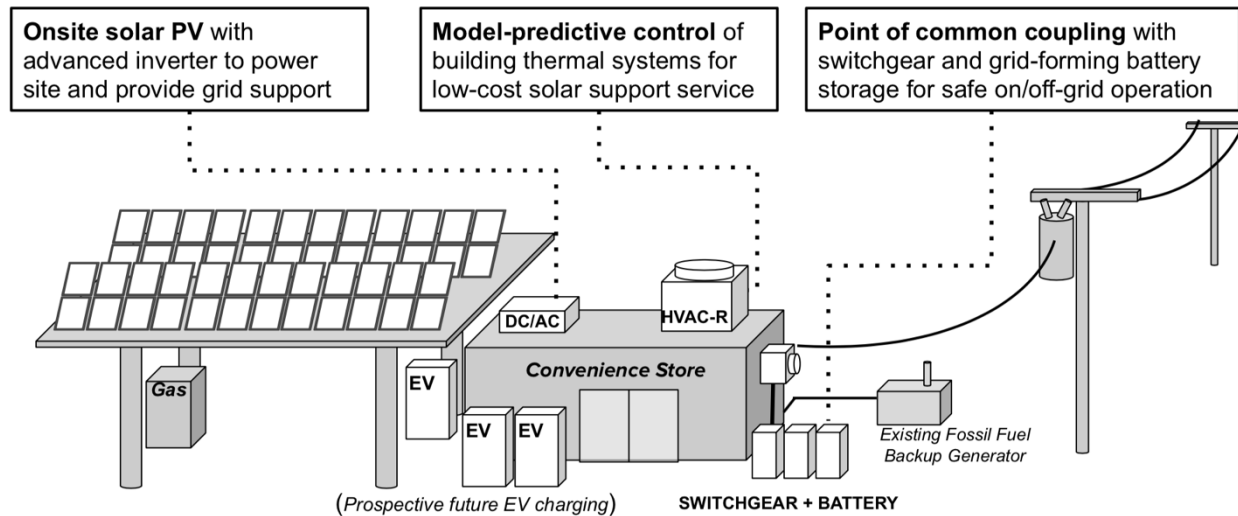

Figure 2: Conceptual diagram of pilot Solar+ microgrid including notes on key features. Existing site components are shaded and new components are white.

**Table 1:** Summary of case study site parameters

System Feature	Case Study Value(s) / Description
Location and Building Type	Blue Lake, California. Fueling station with convenience store Coordinates: 40.884 N, -123.998 W
Baseline Site Demand**	Total: 140,000 kWh / year Peak: 25-45 kW depending on the month
HVAC+R Demand	HVAC: 2x ~9 ton Rooftop A/C Units with Natural Gas Heating. SEER 11 Refrigeration: 330 ft <sup>2</sup> walk-in refrigerator with pass-through display case doors. Freezer: 170 ft <sup>2</sup> walk-in freezer with pass-through display case doors
PV System	DC capacity: 60 kW <sub>DC</sub> ; AC capacity: 50 kW <sub>AC</sub> ; 8° Tilt, 217° Azimuth with essentially unobstructed sky view. Sunpower X22-360-COM PV modules x167 Sunny Tripower STP50-US-40 inverter x1
Battery System	Power Stage: 109 kW; Energy Capacity: 174 kWh Tesla Powerpack v.2; Lithium-ion chemistry

\*\*The loads presented in this analysis are adjusted to remove ~20 slot machines with an approximate 16 kW continuous load since these would not be present in typical sites of this type.



## Designing Microgrids for Wildfire Resilience

The general design principle for a microgrid integrates principles from demand-side management, renewable generation, backup power for reliability, and electrical switchgear. The goal of a microgrid is to provide a system that enables long-term operation of a site without a connection to the electrical grid (resilience) and optimizes operation during times when the grid is available. In the context of resilience to blackouts related to wildfire, the core principles of microgrid design remain in place, with some minor modifications for the case of wildfire response (described more below). Figure 3 below illustrates the main components of a microgrid system, with more details on the subsystems below.

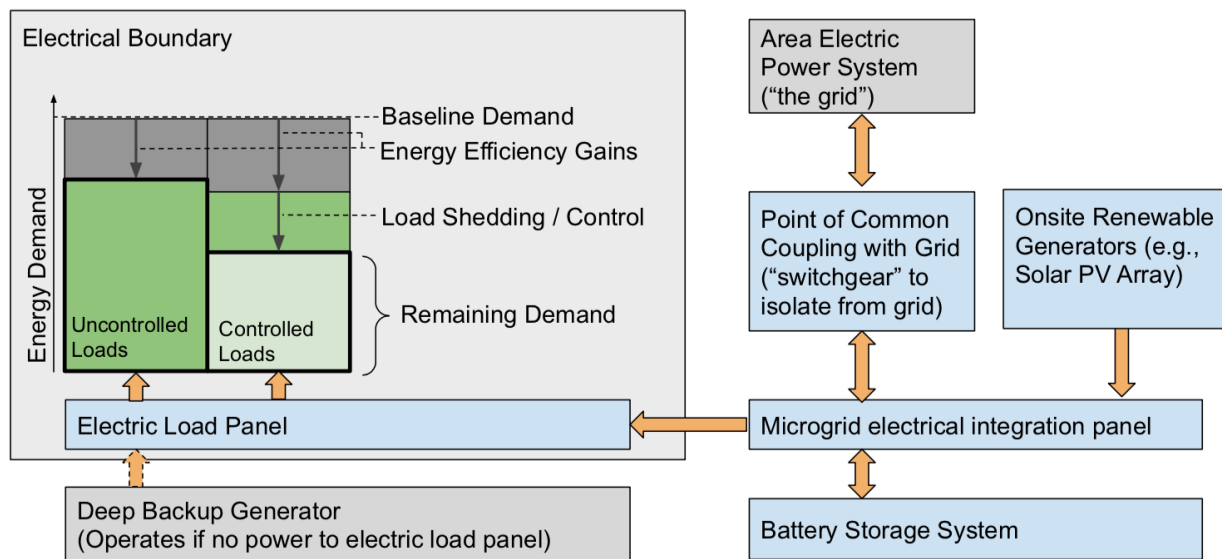

Figure 3: Conceptual diagram showing energy flows between major elements of a microgrid system.

The general design considerations for each of the subsystems of the microgrid is presented below, with comments on the way these systems are considered in the context of a microgrid and *financial considerations* based on our experience in deployment.

- Demand-side management and control:** Define the electrical boundary of the site (typically based on existing wiring configurations and utility connections). Within the boundary, consider if there are cost-effective energy efficiency measures that could reduce the load. Also consider if new loads are likely to be installed (e.g. electric vehicle chargers) that should be powered by the microgrid. Large equipment (e.g., HVAC and refrigeration) should be controlled by a supervisory controller that can manage these loads in an optimal way. In the context of wildfire response, it is important to consider how loads may change during or after a wildfire response. For example, grocery and convenience stores may experience higher demand from increased sales and need for ice making. Air filtration may be required to maintain healthy indoor air during smoke events. *These energy efficiency and demand response investments may be cost-effective even before considering any benefits related to their operation in the context of a microgrid.*

- **Onsite generation:** Identify the potential for onsite renewable energy generation. In many cases this involves assessment for solar PV, since this is a technology that is widely applicable and continues to rapidly fall in cost, with typical installed costs in small to medium commercial projects of \$3/watt circa 2019 (Barbose et al. 2019). In our experience, the maximum possible PV generation is favorable for maximizing the resilience of a microgrid. In many places, this maximum limit is set by utilities to be equivalent to “net zero PV” -- the scale of PV generation that will exactly offset the total demand of the site on an annual basis. In the context of wildfire response, the sizing of the PV system and related sub-systems should consider the typical available solar resource during “wildfire season” (often in late summer and early fall), and possible reduction in the solar resource due to smoke, which is discussed and analyzed in more detail below. *The investment in PV generation may be cost-effective even without the added benefit of the microgrid, depending on the utility tariff, climate, and the cost of installing solar PV.*
- **Backup power for reliability:** Identify and specify a battery backup system with sufficient power and energy capabilities to power the site. The power stage of the battery typically will need to be sized to match protection needs for the circuits in the building; the battery needs to have capacity to source sufficient current to clear faults (“pop circuit breakers”) in the building(s) being powered. The energy capacity of the battery should be sized to balance the available generation and demand. Many sites also incorporate a fossil fuel generator as a “deep backup” that can operate if the microgrid fails to carry the site load, or may be integrated to operate in a hybrid mode. *The investment in batteries is still relatively costly compared to benefits from grid-connected operation (which mainly come from using the battery system to reduce peak demand charges at commercial sites). Higher energy capacity will result in higher uptime but at a significant cost. The current average cost of batteries for small commercial buildings is ~\$250/kW for the power stage and \$500/kWh for the energy storage elements (Lazard 2019).*
- **Electrical switchgear and point of common coupling:** In consultation with the electric utility, design and install appropriate switchgear to manage a “point of common coupling” (PCC) between the area electric power system and the microgrid. The control settings for the switchgear will define how the system isolates and reconnects with the grid. *Our experience has shown that the custom engineering and fabrication required for microgrid switchgear and PCC are high (~\$100k/site) and can represent a significant fraction of the project cost for microgrids at small commercial sites. Reducing these costs through standardization and experience are one of the broader goals of our research project.*

## Wildfire Weather and Microgrids

One of the design considerations for any renewable energy system is the climate and weather patterns that are associated with the availability of energy resources. For solar microgrids that are designed for wildfire response, this means considering the typical weather patterns in times of the year that are associated with wildfire.

Typical weather conditions associated with wildfire risk in California occur during the fall season (September to December), prior to the winter rains. When an inland high pressure

system and an offshore low pressure system combine, high offshore winds with low humidity and heated air mass can cause extreme wind-driven wildfire events (Miller and Schlegel 2006; Werth et al. 2011), Given the strong link between fire and weather, the National Weather Service (NWS) produces fire weather forecasts and “red flag criteria” based mainly on two weather conditions: First, a relative humidity of 15% or less combined with temperatures above 15.6 °C and sustained surface winds, or frequent gusts, of 25 mph (11 m/s) or greater. Second, the presence of widely scattered dry thunderstorms (producing less than 0.10 inch rainfall) with 15% coverage (NWS 2020). Hot, windy conditions in late summer and fall are the exemplars of wildfire weather. In California, these times of year are associated with sunny days with a reasonably high solar resource, but not the peak days of summer generation.

The presence of wildfire introduces smoke, which can affect the available solar energy. The phenomenon of smoke blocking light is widely observed, and an observational study in the Canberra region of Australia found the impact of a small nearby fire reduced irradiance overall by 6.5% over a two hour period with a peak reduction of about 30% (Perry and Troccoli 2015). We used data from a pyranometer in Berkeley, CA (on Flexlab at Lawrence Berkeley National Laboratory) to assess the reduction in solar resource during a period of smoke inundation from the Camp Fire (from November 8-12, 2018). Figure 4 shows daily average irradiance during one clear sky week prior to the event vs daily average irradiance during five sunny days when smoke was the most present in Berkeley (November 14th–18th). During those days, the average particulate matter (PM<sub>2.5</sub>) concentration in the atmosphere was 75-125 micrograms per cubic meter. In addition to the significant hazard this poses to health, the smoke also resulted in a reduction in available solar energy by approximately 17%. In the context of solar energy and energy management, this is far lower than the variability due to clouds but could be a factor worth considering for microgrids intended for wildfire response. Based on this reduction in available solar energy and depending on the requirements for reliability at the site and ability to curtail non-critical loads, it may be appropriate to increase the size of PV and storage for microgrids intended to serve critical loads during wildfire events.

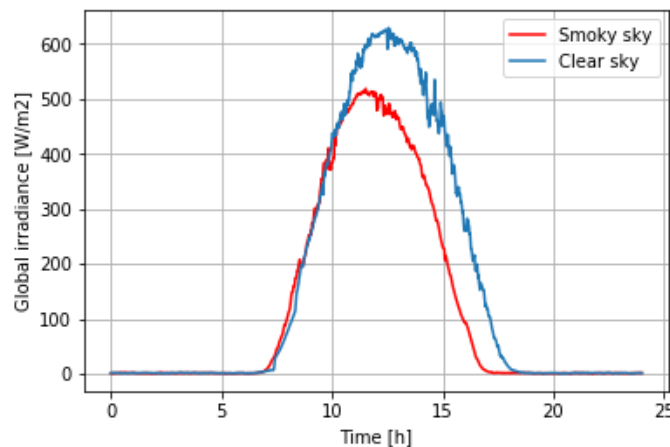

Figure 4: Irradiance measurements from Flexlab in Berkeley California before and during the smoke event related to the Camp Fire in November 2018.

## Microgrid Resilience Analysis

The microgrid project we are working on presents an opportunity to consider the tradeoffs between investments in various sub-systems in the context of responding to wildfire. The microgrid we are constructing was not complete in time to be operational during the most recent fire season (Fall 2019), but we have detailed monitoring of the site during that time to support a simple simulation of the microgrid response under various scenarios. The goal of the microgrid resilience analysis we describe here is to estimate how the system will operate in a wildfire response event with different levels of energy efficiency, non-critical load curtailment, PV capacity expansion, and battery capacity expansion. What are the tradeoffs between these various pathways to increase resilience? How can the run time of a microgrid be extended during outages?

### Modeling Approach

Our approach to modeling microgrid resilience involves identifying a 10-day period that is representative of “wildfire weather” and using an energy balance model to estimate the performance of a microgrid system operating on an hourly basis during that time. Figure 5 illustrates the energy demand in the period we selected, from October 7-17 2019. This corresponds to a period before, during, and after a PSPS event that lasted from October 9-10, which was in response to heightened wildfire risk. The period was selected as one that is representative of typical weather during potential wildfire times. The modeling approach is based on the design intent for our microgrid project and is summarized below, with key assumptions listed in Table 2:

*The following analysis is completed for each hourly time step:*

1. Identify the “net load” -- the difference between the demand and PV generation.
2. Balance the net load with the battery, or switch to backup generator:
  - a. If the net load is negative (more PV than needed), use the excess to charge the battery, within the constraints of the battery power and energy ratings.
  - b. If the net load is positive and there is sufficient energy in the battery from the previous timestep, discharge the battery to balance the net load.
  - c. If the net load is positive and there is not sufficient energy in the battery, switch to the fossil fuel backup generator and meet the total demand using the backup generator. Use any available PV energy to charge the battery for later use.
3. Update the available energy in the battery for the next time step based on the outcome.

The metrics we use to compare the performance of various scenarios are based on the resilience of the “clean energy” portion of the microgrid --- the combined PV+battery system. We calculate the number of hours of operation on clean energy and the fraction of the load served by clean energy as metrics to compare between scenarios.

Table 2: Assumptions and data input for microgrid resilience model

Parameter	Assumption / Input Data
Time Period	October 7-17, 2019 (corresponding to October 9-12 PSPS event)
Baseline Demand	Accuvim Wattnode submeters on building loads at Playstation 777 during the time period. Constant 16 kW gaming machine load removed from the “other” loads in the building before analysis (see discussion in earlier sections).
Solar PV Generation	Estimated using the “System Advisor Model” from NREL <sup>2</sup> , with weather data from October 7-17 2018 (one year previous to our load data -- 2019 data is not yet available). Analysis comparing the weather in 2018 and 2019 (temperature, clearness) supports the assumption there is a reasonable match.
PV and Battery Performance	The baseline parameters are estimated to match the installed components in our system, as described in Table 1. In summary, it is a 50 kW <sub>AC</sub> PV system and a 109 kW / 174 kWh battery. The battery efficiency is assumed to be 90%. The battery state of charge starts at 50% at the first time step.
Expansion Cost	\$3/Watt for additional PV capacity. \$250/kW + \$500/kWh for additional battery power + energy capacity.

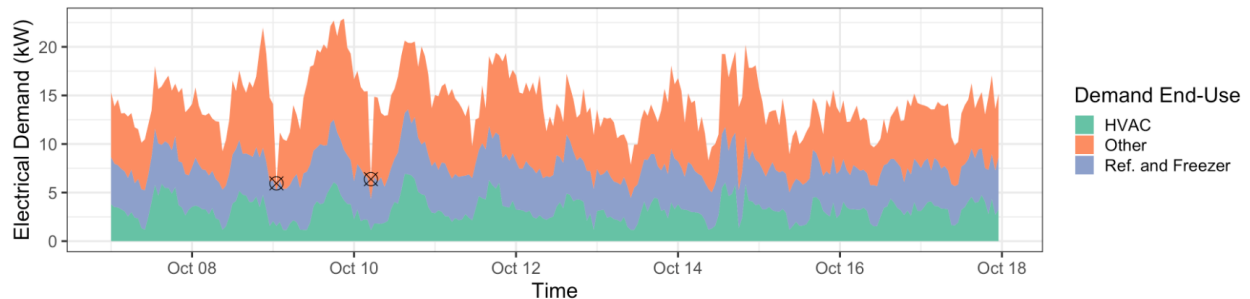

Figure 5: Measured demand at the Playstation 777 October 7-17, 2019, including a public safety power shutoff period from when grid electricity was disconnected and the site operated on backup power. The beginning and end of the PPS period are marked with ⊗.

The baseline / status quo system results in significant backup generator runtime during periods when the microgrid is not matched to the unmanaged load. During the eleven-day period (with 264 hours) the generator was needed for 103 hours (161 hours on clean energy). In total, 65% of the load was served by solar and 35% by the generator. As long as the backup generator is available this scenario is suitable for meeting demand, but results in increased local air pollution associated with the backup generator and introduces risk of outage if the generator fails to start or fuel supplies run low.

<sup>2</sup> <https://sam.nrel.gov/>

In addition to modeling the behavior of the baseline system, we use a set of scenarios to explore the tradeoffs and performance gains from energy efficiency, load curtailment, PV expansion, and battery expansion. This sensitivity analysis reveals pathways to improve the performance of the microgrid and the tradeoffs between the measures. Table 3 describes the range of parameters we included; all possible combinations of these parameters were tested in simulation. The parameters include both demand-side and generation / storage measures. For demand-side measures, the reductions in demand could come from a combination of energy efficiency upgrades and curtailment of non-critical service. The current HVAC-R equipment is standard efficiency and nearing its end-of-life at the pilot site, and the reductions in demand from 10-50% could be expected if the most efficient available equipment is installed and/or setpoints are adjusted during critical times. The “other” loads at the site include many critical loads (fuel pumping, point of sale devices, lighting), but also some that could be curtailed (advertising signage, standalone food warming devices, etc.). A detailed accounting of critical vs. non-critical loads is not in the scope of this paper, but our expectation is that a combination of EE and load curtailment (either automatically with advanced controls or manually) could achieve the range of values we consider in the sensitivity analysis. Expansion of the PV system is feasible on the rooftop of the convenience store and there is ample space in the battery cabinet to add more energy storage modules within the range we consider here.

Table 3: The range of parameters explored in the sensitivity analysis

Parameter (sensitivity direction relative to baseline)	Possible Values Tested
HVAC Demand (reduction)	0%, -25%, -50%
Refrigeration / Freezer Demand (reduction)	0%, -10%, -25%
“Other Loads” Demand (reduction)	0%, -25%, -50%
PV Capacity Expansion (increase)	0%, +50%
Battery Energy (kWh) Capacity Expansion (increase)	0%, +50%, +100%

The bookend outcomes of the sensitivity analysis are illustrated in Figure 6, showing the status quo (all “0%” from Table 3), a run with the maximum demand reduction only, a run with the maximum PV and battery capacity expansion only, and a run with “maximum everything.” The status quo system has significant run time from the generator overnight, but is able to power the site during the day and the early evening hours on PV and stored energy. With the maximum demand reduction (functionally a demand reduction of 43% compared to the baseline), the operation of the generator is eliminated. The existing PV and battery system are sufficient to power this dramatically more efficient (or curtailed) load. Maximizing the PV and storage nearly eliminates the generator operation, but after a day with particularly high demand (October 9, which was an actual power shutoff day with increased activity at the fueling station) there was still a need for backup generation overnight. As one might expect, maximizing both demand reduction and expanded capacity results in no generator operation and a curtailment of PV due to

excess. Notice that the battery storage charging reduces to zero midway through the day in that scenario, as a result of having a full battery.

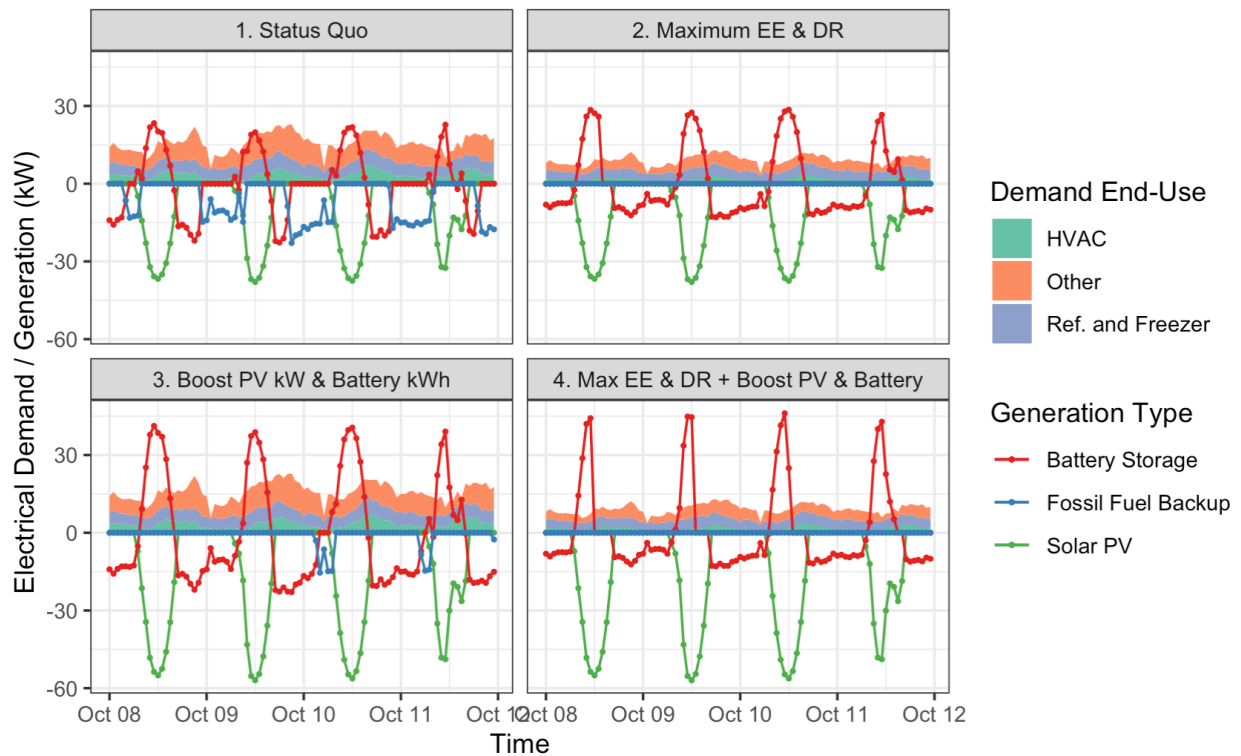

Figure 6: Expected microgrid dispatch during a hypothetical wildfire response islanding event with the status quo system and three illustrative alternatives: one with “maximum” energy efficiency and demand response (50% reduction in HVAC, 25% reduction in refrigeration, 50% reduction in other loads), one with a 1.5x boost to both the PV power capacity (kW) and storage energy capacity (kWh), and the last with all of the interventions.

Next we examined the cost implications for the full range of sensitivity cases we considered. Figure 7 shows the potential tradeoffs and complementary choices between investments in demand-side and generation-side assets. In the figure, the estimated costs for upgrading the PV and battery systems are shown using typical assumptions for the current-day cost (\$3/Watt for PV and \$500/kWh for expanding the energy stage of the battery system). Several features of the analysis are made clear by the figure. The current system is limited by energy generation, not storage. Adding to the battery energy capacity without new PV or reduced demand does not result in additional performance. One pathway for improving the resilience of the system is additional solar generation. With 50% more solar (for a total of 75 kW<sub>AC</sub>) the fraction of load served by clean energy rises from 65% to 82%. One could also consider what efficiency pathway could achieve the same result; a 23% reduction in demand also achieves an outcome where 82% of load is served by clean energy (with the baseline PV and storage system).

In this case, the comparison suggests that from a resilience perspective a ~\$90k investment in additional PV is approximately equivalent to an efficiency investment that results in ~25% lower energy use. A site operator considering these tradeoffs, along with considering the bill savings from each option.

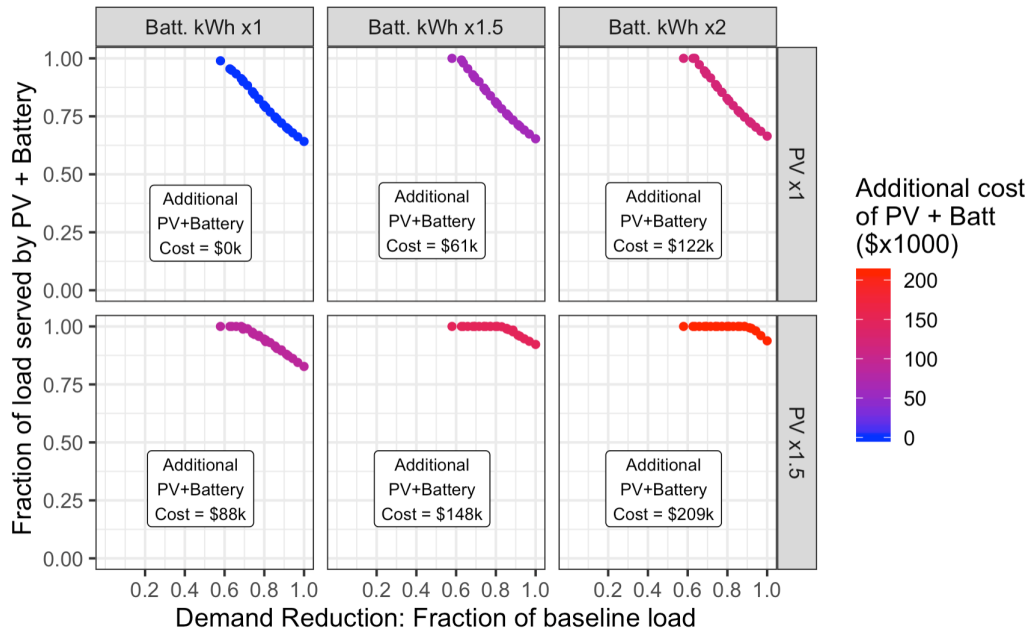

Figure 7: Resilience of microgrid across all demand reduction sensitivity cases in terms of the fraction of load served by clean energy. There are estimates of the additional cost for PV and battery storage upgrades for each combination of upgrades included.

## Discussion

The technical potential for using clean energy microgrids to provide resilient power at critical sites is clear, but significant work remains to understand and improve the economic viability of projects. Our experience shows that there is still a significant cost associated with microgrid integration, beyond the cost of solar and storage projects that do not have resilience features. These costs, however, can be reduced through continued deployment and learning.

The cheapest resilience is no doubt still a diesel generator, but these complex machines have their own risks in terms of failure to operate. Backup generators are also dirty in terms of local air pollution, noisy, and introduce the potential for fuel and lubricant spills on sites where they are used. In addition, backup generators offer no value during blue sky operation, instead just “sitting there.” The EE, PV and BESS in microgrids offer blue sky benefits and serve to help meet climate mitigation goals as well as adaptation goals via added resilience.

Our findings on the tradeoffs between demand reduction and the need for PV generation show that there could be significant opportunities for energy efficiency investments to reduce the cost of the PV portion of a microgrid. In the example we assessed, a ~25% reduction in site energy use was as good in terms of added resilience as nearly \$90k in additional PV generation. Put another way, having more efficient loads enables a site to stretch their available power farther during a blackout. Could the value of EE in terms of “more hours of service in a blackout” help close the efficiency adoption investment gap? An extra hour of operation may be much more salient to customers than focusing only on the dollars and cents on their electricity bill. As microgrids are deployed across the power system, the synergies between efficiency and resilient operation should be incorporated in R&D, program design, and deployment plans.



## Acknowledgements

This work was supported by the California Energy Commission Electric Program Investment Charge (EPIC) Program, Solicitation Grant Funding Opportunity Number: EPC-17-002, entitled “Scaling Solar+ for Small and Medium Commercial Buildings”.

## References

- Barbose, Galen, Naim Darghouth, Salma Elmallah, Sydney Forrester, Kristina Kristina S. H., Dev Millstein, Joseph Rand, Will Cotton, Stacy Sherwood, and Eric O’Shaughnessy. 2019. “Tracking the Sun: Pricing and Design Trends for Distributed Photovoltaic Systems in the United States - 2019 Edition.” Lawrence Berkeley National Lab. (LBNL), Berkeley, CA (United States). <https://doi.org/10.2172/1574343>.
- CAL FIRE. 2020. “Stats and Events.” Stats and Events. 2020. <https://www.fire.ca.gov/stats-events/>.
- Dimeas, A.L., and N.D. Hatziargyriou. 2005. “Operation of a Multiagent System for Microgrid Control.” *IEEE Transactions on Power Systems* 20 (3): 1447–55. <https://doi.org/10.1109/TPWRS.2005.852060>.
- IEEE. 2011. “IEEE Guide for Design, Operation, and Integration of Distributed Resource Island Systems with Electric Power Systems.” IEEE. <https://doi.org/10.1109/IEEESTD.2011.5960751>.
- Lasseter, Robert, Abbas Akhil, Chris Marnay, John Stephens, Jeff Dagle, Ross Guttroms, A. Sakis Meliopoulos, Robert Yinger, and Joe Eto. 2002. “Integration of Distributed Energy Resources. The CERTS Microgrid Concept.” LBNL-50829. Lawrence Berkeley National Lab. (LBNL), Berkeley, CA (United States). <https://doi.org/10.2172/799644>.
- Lazard. 2019. “Levelized Cost of Energy and Levelized Cost of Storage 2019.” Lazard.Com. 2019. <http://www.lazard.com/perspective/levelized-cost-of-energy-and-levelized-cost-of-storage-2019/>.
- Miller, Norman L., and Nicole J. Schlegel. 2006. “Climate Change Projected Fire Weather Sensitivity: California Santa Ana Wind Occurrence.” *Geophysical Research Letters* 33 (15). <https://doi.org/10.1029/2006GL025808>.
- NWS. 2020. “Fire Weather Criteria.” NOAA’s National Weather Service. 2020. <https://www.weather.gov/gjt/firewxcriteria>.
- Perry, Matthew, and Alberto Troccoli. 2015. “Impact of a Fire Burn on Solar Irradiance and PV Power.” *Solar Energy* 114 (April): 167–73. <https://doi.org/10.1016/j.solener.2015.01.005>.
- Van Wagendonk, Jan W. 2018. *Fire in California’s Ecosystems*. <https://www.ucpress.edu/book/9780520286832/fire-in-californias-ecosystems>.
- Werth, Paul A., Brian E. Potter, Craig B. Clements, Mark A. Finney, Scott L. Goodrick, Martin E. Alexander, Miguel G. Cruz, Jason A. Forthofer, and Sara S. McAllister. 2011. “Synthesis of Knowledge of Extreme Fire Behavior: Volume I for Fire Managers.” *Gen. Tech. Rep. PNW-GTR-854*. Portland, OR: U.S. Department of Agriculture, Forest Service, Pacific Northwest Research Station. 144 p. 854. <https://doi.org/10.2737/PNW-GTR-854>.
- Williams, A. Park, John T. Abatzoglou, Alexander Gershunov, Janin Guzman-Morales, Daniel A. Bishop, Jennifer K. Balch, and Dennis P. Lettenmaier. 2019. “Observed Impacts of

Anthropogenic Climate Change on Wildfire in California.” *Earth’s Future* 7 (July).  
<https://doi.org/10.1029/2019EF001210>.