

UCLA

UCLA Electronic Theses and Dissertations

Title

Giving Reflexivity a Voice: Twin Reflexives in English

Permalink

<https://escholarship.org/uc/item/8g31j3gn>

Author

Ahn, Byron Thomas

Publication Date

2014

Peer reviewed|Thesis/dissertation

UNIVERSITY OF CALIFORNIA

Los Angeles

Giving Reflexivity a Voice:

Twin Reflexives in English

A dissertation submitted in partial satisfaction of the
requirements for the degree Doctor of Philosophy
in Linguistics

by

Byron Thomas Ahn

2015

© Copyright by
Byron Thomas Ahn
2015

ABSTRACT OF THE DISSERTATION

Giving Reflexivity a Voice: Twin Reflexives in English

by

Byron Thomas Ahn

Doctor of Philosophy in Linguistics

University of California, Los Angeles, 2015

Professor Sun-Ah Jun, Co-chair

Professor Dominique Sportiche, Co-chair

Across languages, there is variability in the surface realization of reflexivity, according to various sets of properties. For example, there are languages (e.g. Greek, Lakhota) that seem to treat some of their reflexive clauses as being in a non-active voice, similar to a passive. There are also languages (e.g. French, Kannada) in which reflexivity is encoded differently depending on whether the antecedent is the subject or not. In this way, English seems to be different: reflexivity is apparently realized in a homogeneous way – filling an argument position with an anaphoric expression like *themselves* – regardless of clausal voice or grammatical role of the antecedent.

This homogeneity is an illusion. Despite using a single set of anaphoric expressions for reflexivity in various situations, reflexive anaphors in English fall into two classes: those that exhibit exceptional prosodic behaviors, and those that do not.

This exceptionality can be directly observed in two domains: the distribution of “default” phrasal stress, and the distribution of a certain focal accent. From the results of experiments on speech production and perception, I show that the distribution of exceptionally behaving reflexive anaphors is structurally constrained. This implicates that there must be a syntactic account for

these prosodic properties.

Assuming that syntactic structure plays a near deterministic role in prosody (an assumption going back to even the earliest generative work on phrasal stress; Chomsky and Halle 1968:25), I argue for a more refined syntactic structure of reflexivity. Briefly, I demonstrate a sub-class of reflexive anaphors in English undergo a syntactic movement (to a reflexive VoiceP). This movement, along with independently motivated mechanisms for placement of phrasal stress and focal accents, derives the heterogeneous prosodic behaviors of reflexives in English. Crucially, this analysis does not require the prosodic component to have any stipulations for specific (classes of) words, in line with a Minimalist approach to the Syntax-Prosody Interface.

This model of reflexivity simultaneously reduces the amount of theoretical machinery necessary to achieve descriptive adequacy, while also enhancing the model's predictive power. Moreover, this research has broad theoretical implications, beyond just reflexives in English. This theory is able to unify the various morpho-syntactic instantiations of reflexivizing functions – across languages – as being related to the Reflexive VoiceP. It also establishes a core set of properties that define clausal reflexivity, each of which are the result of the formal properties of the reflexive Voice^o. Finally, it provides direct support for the hypothesis that syntactic and prosodic structures are maximally isomorphic, with prosodic cues in the signal giving direct evidence for otherwise invisible syntactic structure.

DISSERTATION HAIKU

Reflexive clauses,

What's with the strange prosody?

Movement to VoiceP.

The dissertation of Byron Thomas Ahn is approved.

Elsi Kaiser

Timothy Stowell

Sun-Ah Jun, Committee Co-chair

Dominique Sportiche, Committee Co-chair

University of California, Los Angeles

2015

v

For my grandparents

TABLE OF CONTENTS

1	Introduction	1
1.1	Reflexive Anaphors' Prosodic Weakness (Chapter 3)	3
1.2	Interpretations of Focused Reflexive Anaphors (Chapter 4)	5
1.3	Cross-Linguistic Realization of Reflexivity (Chapter 5)	8
1.4	Summary: The Big Questions and Some Short Answers	9
1.5	Roadmap	10
2	Background	11
2.1	Syntax and the Interfaces	12
2.1.1	General Grammatical Architecture	12
2.1.2	Interfaces in Minimalism	14
2.2	Prosodic Background	17
2.2.1	The Autosegmental-Metrical Model	17
2.2.2	Lexical Stress vs. Phrasal Stress	21
2.2.3	Pitch Accents and Phrasal Stress	23
2.2.4	Default Phrasal Stress and Focal Stress	25
2.2.5	A Principle of Semantics-Prosody Isomorphism: QAC	26
2.3	Summary	29
3	Reflexivity and Phrasal Extrametricality	31
3.1	The Puzzle: Variable Prosodic Behavior of Reflexive Anaphors	33
3.2	Phrasal Stress and Context	38

3.2.1	Neutral Phrasal Stress Patterns	38
3.2.2	Discourse Information Effects on Phrasal Stress	40
3.3	Anaphors and Phrasal Stress	42
3.3.1	More Examples of the Extrametrical Anaphors	43
3.3.2	Not All Anaphors Are Extrametrical	50
3.3.3	Extrametrical Anaphors Are Not Extrametrical Pronouns	54
3.4	Are Reflexive Anaphors Given?	57
3.4.1	Constraints on Givenness and Stress Avoidance	58
3.4.2	Wagner 2006: Givenness Movement	63
3.4.3	Anaphors aren't Given	66
3.5	Defining the Structure-Based Model of Phrasal Stress	69
3.5.1	Ruling Out Linearization-Based Models for Extrametrical Reflexives	69
3.5.2	Definitions and Properties of the S-NSR	77
3.6	Interpreting Phrasal Stress Patterns Syntactically	87
3.6.1	Islands and Movement	88
3.6.2	Subjecthood and Structure	91
3.6.3	Giving Reflexivity a Voice	95
3.6.4	Two Predictions	99
3.7	Reflexive (Non-)Extrametricity as a Diagnostic	102
3.7.1	Stress-Bearing Reflexives as Indicative of Structure	102
3.7.2	Extrametrical Reflexives as Indicative of Structure	109
3.7.3	Ditransitives and Non-Syntactic Prosodic Constraints	125
3.7.4	DP-Internal Reflexive Anaphors	129

3.8	Conclusion	132
3.9	Further Research	135
4	The Distribution of Focal Stress in Reflexive Clauses	136
4.1	Reflexives and ‘Exceptional’ Focus: Some REAFR Data	139
4.2	The Puzzle: Question-Answer Congruence	142
4.2.1	QAC and Non-Reflexive Clauses	143
4.2.2	QAC and REAFR Contexts	145
4.2.3	Briefly: Dual Focus Prosody	146
4.2.4	Summary	149
4.3	Inadequate Accounts	150
4.3.1	Inadequate Account: Object Focus	150
4.3.2	Inadequate Account: Unaccusative Reflexive Syntax	151
4.3.3	Inadequate Account: Emphatic Reflexives	154
4.3.4	Inadequate Account: Anaphor-Antecedent Relationship	157
4.3.5	Summary of Inadequate Accounts	165
4.4	REAFR: Focus and REFL Semantics	167
4.4.1	Deriving REAFR’s Island Sensitivity	168
4.4.2	Deriving REAFR’s Passive Prohibition	169
4.4.3	Deriving REAFR’s Focus Properties	171
4.4.4	Deriving REAFR’s Word Order Facts	176
4.4.5	Deriving REAFR’s Subject Orientation through Semantic Composition	177
4.4.6	Question-Answer Pairs with REAFR	180

4.5	REAFR: Advantages of REFL Voice	183
4.5.1	Classical Binding Theory	183
4.5.2	Valency Reduction (Broadly Speaking)	184
4.5.3	Coargument Theories of Biding (with Valency Reduction)	186
4.5.4	Colocated External Argument Introducer and Reflexive Head	188
4.5.5	A Structurally Lower Reflexive Head	191
4.5.6	Summary: REAFR and VoiceP	193
4.6	REAFR as a Diagnostic	193
4.6.1	Returning to Ditransitives	193
4.6.2	DP-Internal Reflexives	195
4.7	Conclusion	196
5	Local Subject Oriented Reflexivity, Cross-Linguistically	200
5.1	The Puzzles	201
5.2	Previous Approaches to LSOR and Some Standing Issues	205
5.2.1	Past Movement Approaches and Our Puzzles	207
5.2.2	Evidence for Movement: Syntactic Islands	212
5.2.3	LSOR and Non-LSOR Anaphors	215
5.2.4	Movement: Motivations and Desiderata	216
5.3	Reflexive Voice	218
5.3.1	Subjects and Voice	218
5.3.2	The LSOR Derivation	224
5.3.3	Solving Puzzles with REFL Voice	229

5.4	LSOR Across Languages	237
5.4.1	LSOR Surface Variation	238
5.4.2	LSOR, “Transitivity”, and Other Voices	242
5.4.3	LSOR and Other Voice-Related Effects	244
5.4.4	Typological Conclusions	249
5.5	Conclusions	250
5.5.1	Closing Remarks	250
5.5.2	Extensions and Open Questions	252
6	Conclusion	254
6.1	Summary of Findings	254
6.2	Future Research	256
6.2.1	Phrasal Stress as a Syntactic Diagnostic	256
6.2.2	Reflexive Voice and Ellipsis	257
6.2.3	Reflexivity Without Reflexive Voice	257
6.2.4	Long Distance Reflexivity	259
	APPENDIX	261
A	Types of Movement and the Syntactic Derivation of Reflexivity	262
A.1	Choosing the Appropriate Syntactic Derivation	262
A.2	Covert Overt Movement	265
A.3	Covert Overt Movement and Prosody	266
A.4	Covert Overt Movement and its Consequences for the Theory of Islands	268
A.5	An Alternative to Covert Overt Movement	269

A.5.1	A Different Approach to DPs	269
A.5.2	The Linearization Problem Revisited	270
A.5.3	Further Support and Open Questions	272
B	Alternative Semantic Derivations	274
B.1	LF Movement	275
B.2	Lambda Abstraction	276
B.3	Anaphor=Reflexivizer	281
C	More on Reflexivity in Romance	283
D	Movement to Spec, VoiceP doesn't create binding violations	286
E	Reflexives without REFL Voice	288
E.1	Two Ways to Bind	288
E.2	Deciding How to Bind	289
F	Revisiting the Definition of Depth of Embedding	292
G	If Voice^o Introduced External Arguments	295
H	Alternative Approaches to REAFR Prosody	297
I	Examples of Local Subject-Oriented Reflexivity Across Languages	300
I.1	A Cross-Linguistic Sample	300
I.2	What to Look for to Find LSOR Markers in a Language	302
	Bibliography	305

LIST OF FIGURES

2.1	Sketch of the Grammatical Architecture	13
2.2	Sketch of the Autosegmental-Metrical Model of English	17
3.1	Sketch of the Autosegmental-Metrical Model with MAE_ToBI labels	70

LIST OF TABLES

3.1	Word Order and Phrasal Stress Location	77
3.2	Double Dissociation Between Linearization and Phrasal Stress	81
5.1	Some Morpho-syntactic Variation in LSOR at the Surface	238
5.2	Variation in 3rd Person Plural Pronominals Across a Selection of Languages . . .	239
5.3	Voice ^o s and Their Morphological Realizations on the Verb	244
5.4	LSOR effects on Morpho-Syntactic Paradigms	247

ACKNOWLEDGMENTS

First and foremost: this dissertation was only able to come to be under the advice and challenges I received during my time at UCLA. This project would not have progressed beyond shadows of intuition – and likely would not even have been begun – were it not for the members of my dissertation committee.

Sun-Ah Jun was able to take me as a second year grad student (who had virtually no interest in phonetics and phonology) and turn me into someone who is excited to think about prosody every day. If it wasn't for her ability to inspire and her openness to my naive questions, very little of what has now become my linguistic career would have come to exist. Sun-Ah's no non-sense approach to her work, along with an open mind to new alternatives, has made every meeting a pleasure. Some of my most productive thought experiments and consequent research endeavors have resulted from Sun-Ah asking point-blank, "Why do you think that?"

Dominique Sportiche has played an equally if not more formative role in my development as a theoretical thinker. In every meeting we had, Dominique pushed me and allowed me to push back. I would like to think I've gained some of his ability to separate the critical core of an argument from its implementation, effectively and convincingly for an audience. I'm sure I will spend the rest of my career hoping to achieve his success in this area. And when it comes to theory, I hope I have absorbed at least a little of Dominique's willingness to look for the most principled answer, even if (and perhaps especially if) the most principled answer challenges some basic foundational beliefs.

Tim Stowell has an incredible talent to turn apparent oddities in the data into strong (often field-changing) arguments about the theory. I cannot remember a meeting with Tim that did not include a dialog that began with "Have you considered the following? ...?". This has played no small part in the way I think about even the smallest possible counter-examples critically.

Hilda Koopman is perhaps the most principled thinkers I know, and has inspired much of

my approach to looking at a new problem. Often I find myself first considering the questions I expect Hilda would ask. As a result, I have begun looking for the (syntactic) principles in areas I might have originally thought of as unprincipled (or non-syntactic). And finding syntax where I wouldn't first expect it is truly a joy.

Elsi Kaiser has enormous patience for dealing with a theoretician who does experimental work such as myself. With her help, I have come to hone an ability to appropriately manipulate variables in seeking out the right kind of data.

Other professors at UCLA have played a guiding role in the development of my research – especially Daniel Buring, Ed Keenan, Anoop Mahajan, Keir Moulton, Jessica Rett, Yael Sharvit, Ed Stabler, Maziar Toosarvandani, and Martin Walkow. I must really thank them for their patience with guiding me through various lines of thinking and formalisms. There are so many others who have contributed to this research, in meetings, workshops, and conferences. Thanking everyone would double the size of this acknowledgments section. Despite being nameless, many of the comments and questions that they have given me have made hugely important impacts on this work.

My graduate student peers from whom I've gotten insightful feedback and emotional support, especially: Natasha Abner, Jason Bishop, Joe Buffington, Isabelle Charnavel, Thomas Graf, Annie Gagliardi, Laura Kalin, Laura McPherson, Robyn Orfitelli, Denis Paperno, Craig Sailor, Matt Tucker, Chad Vicenik, Kaeli Ward, Jamie White, Lauren Winans, Jun Yashima, and Kristine Yu.

My family has always provided the support I need in pursuing a career in academia. I was raised in an environment that encouraged questioning, debate, and thinking things through. It was at family dinners that I learned the questionable skill of debating facts – this was nevertheless useful in helping me develop an open, curious mind. My grandparents also serve as inspiration –

it was a desire for and pursuit of knowledge that brought all of my grandparents to the lives they have lived, and I hope that my attempts to emulate them will be at least moderately successful.

I'd like to thank whoever came up with the bumper sticker that read, *The twin towers didn't blow themselves up*. It was reading that while stuck in LA traffic that the phenomenon addressed in Chapter 4 was first brought to my attention. I suppose I ought to also thank the person who put it on his car bumper, as well as LA traffic.

I also must thank Living Essentials, LLC for their 5-hour Energy product, which pushed me through many a writing marathon. I am sure I played no small role in keeping them in business while writing this dissertation.

Finally, I would like to thank Scott DeBeck and Alex Dunham. Your incredible support during my graduate studies can not be done justice in words.

VITA

- 2006 B.A., Linguistics, Magna Cum Laude
 Cornell University
 Ithaca, NY
- 2010 M.A., Linguistics
 UCLA
 Los Angeles, CA

PUBLICATIONS AND PRESENTATIONS

Ahn, Byron. 2008. The Prosody of Emphatic Reflexives in English. Presented at Experimental and Theoretical Advances in Prosody. Cornell University.

Sailor, Craig and Byron Ahn. 2010. The voices in our heads: the VoiceP in English. Presented at the workshop on Morphological Voice and its Grammatical Interfaces. University of Vienna.

Ahn, Byron. 2010. Syntactic configurations of emphatic reflexives. Presented at the workshop on Peculiar Binding Configurations. University of Stuttgart.

Ahn, Byron. 2011. External Argument Focus and Clausal Reflexivity. Presented at the 29th West Coast Conference on Formal Linguistics. University of Arizona.

Ahn, Byron. 2011. Explorations of Voice, Identity and the Self. Presented at the Parallel Domains: A workshop in honor of Jean-Roger Vergnaud. University of Southern California.

Ahn, Byron. 2011. Giving Reflexivity a Voice. Invited talk for the S-Circle. University of California, Santa Cruz.

Ahn, Byron. 2011. Default Sentential Stress and Non-Exceptional Reflexives. Presented at Experimental and Theoretical Advances in Prosody 2. McGill University.

Ahn, Byron. 2011. Giving Reflexivity a Voice: Twin Reflexives in English. Presented at the NELS 42. University of Toronto.

Ahn, Byron. 2012. The Prosody of Binding: Reflexive Voice and Default Sentential Stress. Presented at the Annual Meeting of the LSA. Portland, OR.

Ahn, Byron. 2012. Twin Reflexives. Invited talk for the Department of Linguistics Colloquium. The University of Arizona.

Ahn, Byron. 2012. Tongan Relative Clauses at the Syntax-Prosody Interface. In *Proceedings of the Eighteenth Annual Conference of the Austronesian Formal Linguistics Association*.

Ahn, Byron. 2012. External Argument Focus and Clausal Reflexivity. In *Coyote Working Papers*.

Ahn, Byron. 2013. Deriving Subject-Oriented Reflexivity. Presented at the Annual Meeting of the LSA. Boston, MA.

Ahn, Byron. 2013. Universality and Subject-Oriented Reflexivity. Presented at ICL 19. Geneva, Switzerland.

Ahn, Byron and Craig Sailor. 2014. Obligatory Object Gaps in Infinitival Clauses. Presented at the Annual Meeting of the LSA. Minneapolis, MN.

Ahn, Byron. 2014. The Syntax of Phrasal Stress “Exceptions”. Presented at the Annual Meeting of the LSA. Minneapolis, MN.

Ahn, Byron and Craig Sailor. 2014. The emerging middle class. In *Proceedings of the 46th Annual Meeting of the Chicago Linguistic Society (CLS 46)*.

Ahn, Byron. 2014. Subject-Orientation and Reflexivity: Crosslinguistic Investigations at the Interfaces. Invited talk for Syntax Plus. University of Southern California.

Ahn, Byron. 2014. Modelling “Exceptional” Phrasal Stress. Presented at Exploring The Interfaces (ETI) 3. McGill University.

Ahn, Byron, and Dominique Sportiche. 2014. Bind locally indeed. In *Connectedness: Papers by and for Sarah VanWagenen*, ed. Carson T. Schütze and Linnaea Stockall. UCLA Working Papers in Linguistics 18: 61–69.

Ahn, Byron. Forthcoming. Reflexes of Reflexivity: Locality and the Interfaces. In *Proceedings of the 50th Annual Meeting of the Chicago Linguistic Society (CLS 50)*.

CHAPTER 1

Introduction

“In experimental philosophy we are to look upon propositions collected by general induction from, phenomena as accurately or very nearly true, notwithstanding any contrary hypotheses that may be imagined, till such time as other phenomena occur, by which they may either be made more accurate, or liable to exceptions.”

– Sir Isaac Newton, Rules of Reasoning in Philosophy: Rule IV (1687)

“...the sensitivity of certain anaphoric effects to sentence internal phrasal properties does not follow from the communicative function that grammars are pressed to serve...”

– Ken Safir, The Syntax of Anaphora (2004)

As the first matter of business, let us raise two big questions which will lead us to the more specific questions under consideration in this dissertation.

(1) **Broad Question 1**

How does the narrow syntax influence the distribution of (the various types of) reflexive anaphors?

(2) **Broad Question 2**

How does the narrow syntax influence the distribution of (the various types of) prosodic prominence?

This dissertation aims to address these very broad questions with some more focused (and manageable) ones. Chapters 3–5 each aim to address one of the following questions:

(3) **Specific Question 1**

How does the syntactic component of English influence the distribution of reflexive anaphors that appear to avoid phrasal stress?

(4) **Specific Question 2**

How does the syntactic component of English influence the distribution of reflexive anaphors that bear focal stress prosody for semantically focused reflexivity?

(5) **Specific Question 3**

How does the syntax of English reflexive anaphors compare to syntax of the various reflexive 'strategies' of languages of the world?

Investigating these questions will reveal that English grammar distinguishes reflexive anaphors that are obligatorily bound by a local subjects from all others. Analysis of this evidence leads to a new theory of reflexivity – for English and crosslinguistically – which has broad empirical support: a subset of anaphors must move in the narrow syntax to a position on the clausal spine associated with reflexivity: Reflexive VoiceP.

This Reflexive Voice derives effects of Principle A (in the sense of Chomsky 1981a *et seqq.* or Reinhart and Reuland 1993 *et seqq.*), its locality conditions, and other constraints, for anaphors in contexts of Local Subject-Oriented Reflexivity (LSOR). This specific theory with Reflexive Voice can be broken down into its two core components:

(6) **The Core Underpinnings of LSOR**

- i. There are two atoms of reflexivity in LSOR:
 - (a) an anaphor merged in an argument position, and
 - (b) a Reflexive head on the spine that is associated with grammatical voice and the semantic reflexivizing function
- ii. These two atoms yield the LSOR properties:
 - (a) The anaphor undergoes movement when the Reflexive Voice^o is merged, and
 - (b) The local subject necessarily binds the LSOR anaphor, due to the syntactic structure and normal rules of semantic composition.

The empirical phenomena that are focused on in this dissertation are all a result of these core properties. Any other specific aspects of the analysis presented here are simply a method of implementing these components in the framework laid out in Chapter 2.

In the remainder of this chapter, I briefly discuss the major empirical and theoretical findings of each chapter.

1.1 Reflexive Anaphors' Prosodic Weakness (Chapter 3)

To begin, let us simply note that anaphors are prosodically weak in certain contexts. They appear not to bear phrasal stress where other (strong) elements would. (In this example and in all examples in the dissertation, the underlined italics indicate the location of phrasal stress.)

- (7) Q: What was all that noise?
A1: Remy *burned* himself.
A2: Remy burned *Marie*.
A3: Remy burned his *hánd*.

Sentences like (7A1) are not isolated cases. It is generally the case that reflexive anaphors do not bear phrasal stress. Chapter 3 investigates what this might follow from. The following seem to be good initial hypotheses:

- (8) Logically Possible Accounts of the Prosodic Weakness of Reflexive Anaphors
- Reflexive anaphors are lexically (i.e. inherently) weak
 - Reflexive anaphors are instances of weak pronouns more broadly
 - Reflexive anaphors are always formally given, as a result of necessitating an antecedent

Despite the intuitive value of these ideas, none of them are supported by closer investigation of the data.

This is primarily because only some reflexive anaphors avoid phrasal stress, while others must bear phrasal stress. There are three constraints on which reflexive anaphors can avoid phrasal stress, given below:

- (9) Three Constraints on the Prosodic Weakness of Reflexive Anaphors
- Anaphors that are separated from their antecedent by an island boundary bear phrasal stress
 - Anaphors whose antecedents are subjects of passives bear phrasal stress
 - Anaphors whose antecedents are not local subjects bear phrasal stress

These constraints are decidedly concerned with the syntactic context, indicating that the prosodic weakness of anaphors is tied up in their syntactic configuration.

This leads one to the obvious questions of how syntactic configurations impact phrasal stress.

In brief, the phrasal stress rule is defined in terms of syntactic structures. In particular, phrasal stress falls on the most syntactically embedded element (Cinque 1993, Zubizarreta 1998) at Spell Out (Zubizarreta 1998, Adger 2007). Following through with the logic this model of phrasal stress, weak anaphors (those lacking phrasal stress) must occur higher in the structure than strong anaphors (those bearing phrasal stress), which is to say higher than the predicate and other ‘normal’ objects.

Assuming that reflexive anaphors are essentially pronouns (Lees and Klima 1963, Hornstein 2001, *inter alia*) and are selected by a predicate in the same way that other objects are (allowing for local Case and θ -role assignment), it must be that weak anaphors undergo an extra step of movement to occur as high as phrasal stress indicates. This is depicted in (10).

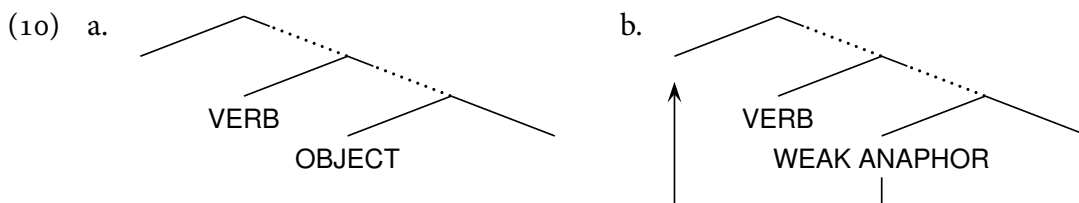

This movement that derives prosodic weakness is also what derives the island sensitivity of weak anaphors, as in (9a). (Why this movement should take place at all is addressed in Chapter 4.)

I provide evidence that this movement targets VoiceP, when it is headed by a Reflexive Voice^o. Unlike others who have used the label VoiceP, I argue that it is outside of thematic domain, higher than where external arguments are introduced (cf. Kratzer 1996), but within the smallest Spell Out Domain that contains the thematic domain.

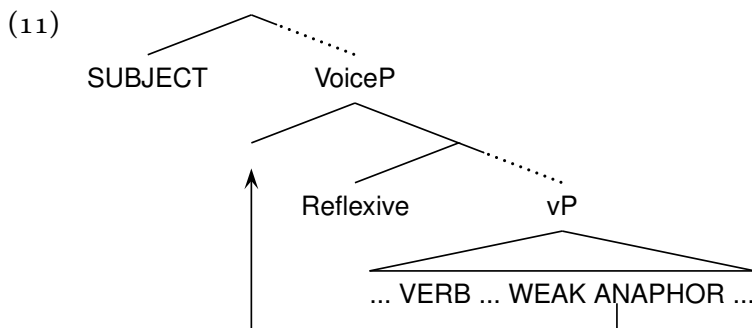

Since this derivation relies on the Reflexive Voice^o, no other Voice^o can merge, and movement of the anaphor to VoiceP will not take place if the sentence has a Passive Voice^o – this derives (9b).

One can also imagine that this movement plays the critical role in (9c) – with the general intuition that movement to be close to the subject results in binding by the subject. However, since reflexive anaphor binding is known to be possible either before movement¹ or after movement, nothing would prevent binding before the movement in (11). Understanding (9c) requires a deeper understanding of the semantics of binding, which is at the heart of Chapter 4.

1.2 Interpretations of Focused Reflexive Anaphors (Chapter 4)

Reflexive anaphors exhibit a second unexpected prosodic behavior, in that they can bear a focus accent in contexts where other phrases cannot. Focusing the anaphor appears to have similar effects to focusing external argument, as demonstrated in the comparison between (12) and (13). (In this example and in all examples in the dissertation, the bold underlined small-caps indicate the location of focus stress.)

- (12) Q: Who mocked Jenna?
A1: DÁNNY mocked Jenna.
A2: # Danny mocked JÉNNA.
A3: JÉNNA mocked Jenna.
A4: # Jenna mocked JÉNNA.
- (13) Q: Who mocked Jenna?
A1: # JÉNNA mocked herself.
A2: Jenna mocked HERSÉLF.

Though both (12) and (13) contain subject WH-questions, the appropriate prosody in the response depends on whether there is a reflexive anaphor. We term this effect Realizing External Argument Focus on a Reflexive (REAFR). REAFR is an apparent counterexample to the otherwise entirely robust principle of Question-Answer Congruence (QAC; Halliday 1967, Rooth 1992, Selkirk

¹Alternatively, after reconstruction.

1996b, Schwarzschild 1999, and Krifka 2004, among many others), which says requires that semantic focus and prosodic focus are collocated.

Deeper exploration shows that REAFR is heavily constrained, in ways that reveal its derivational source. In fact, REAFR is constrained in all the same ways as extrametrical reflexives.

(14) Constraints on Focused Reflexive Anaphors with Special Interpretation

- a. REAFR is not possible with anaphors that are separated from their antecedent by an island boundary
- b. REAFR is not possible with anaphors whose antecedents are subjects of passives
- c. REAFR is not possible with anaphors whose antecedents are not local subjects

The fact that the two share these constraints is surprising, *prima facie*, as well as telling. This suggests the same basic syntactic analysis as in Chapter 3, summarized in (209).

It follows that it is only possible for REAFR to occur when the reflexive anaphor moves to VoiceP. In order to understand this, we note that, in addition to the constraints in (14a-c) that REAFR shares with stress-avoiding anaphors, REAFR has one additional constraint.

- (14) d. REAFR is not possible when reflexivity is given information.

This means that reflexivity is what is semantically focused in REAFR, not the external argument. Moreover, focus stress is only realized on the anaphor for semantic focus on reflexivity when the anaphor moves to VoiceP. This is because the focused semantic reflexivizer in REAFR only occurs in structures with Reflexive Voice – it cannot be that reflexive anaphors are always the locus of semantic reflexivity.

I argue that the syntactic locus of semantic reflexivity is the silent Reflexive Voice^o. In the semantics, the semantic function that Reflexive Voice denotes brings about a secondary assertion, that the anaphor and the subject are coidentified. (The details are given in Chapter 4.²)

²Minimally, the reflexive function that is focused in REAFR is only introduced when the REFL is present. It could be that the reflexivizing function is in fact introduced by the anaphor, but only in LSOR configurations. Otherwise this would overgenerate. This is discussed explicitly in Section 4.4.3 of Chapter 4.

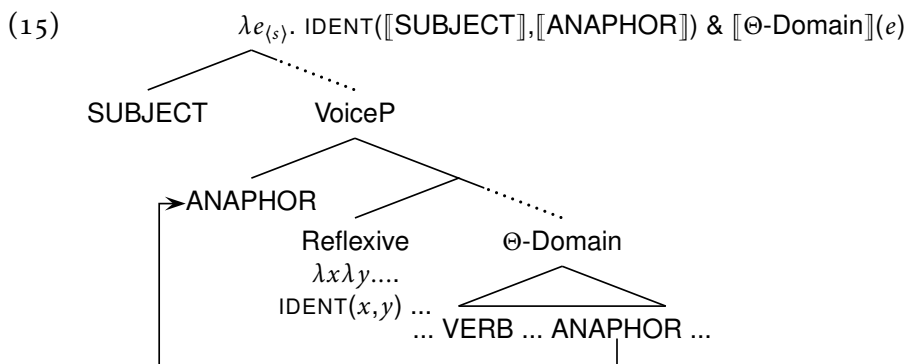

When the silent Reflexive Voice^o is marked for focus in the syntax, feeding semantics and phonology, the anaphor that moves to its specifier bears the prosodic focus, due to a general principle of syntax-prosody mapping (see also Laka 1990, Sailor 2014).

Due to the height of the semantic reflexivizing function in VoiceP, the arguments that will be coidentified in the semantics will always be the subject and the anaphor that has moved to VoiceP. This derives (14c) —and in the same way (9c)— because semantic mechanism for binding anaphors that move to VoiceP is different from the one of binding anaphors that do not. It requires the antecedent to be higher than VoiceP, for proper semantic composition, and only subjects have this property.

Finally, QAC is not violated. The assertion made by REAFR answers to subject WH questions is a denial of the presupposition that such questions carry with them: namely that the event is non-reflexive. In this way, semantically focusing reflexivity in REAFR is parallel to semantically focusing *John* in (16A).

- (16) Q: That Bill won annoyed us.
 A: **JÓHN** won.

At the same time, denying the presupposition in REAFR serves to provide enough information to answer the original question.

Nothing about REAFR is a concern for syntax, its interfaces, or principles like QAC. Instead, the apparent mismatch nature of REAFR is a window of evidence that allows us to peer into the

properties of the system.

1.3 Cross-Linguistic Realization of Reflexivity (Chapter 5)

In Chapters 3 and 4, we establish the syntax and semantics of Reflexive Voice, which derive the formal properties of Local Subject Oriented Reflexivity. Motivating this analysis primarily on English data, we may wonder how general this theory of reflexivity is, across languages. To address this requires a new kind of investigation regarding the properties of reflexive clauses across languages: an investigation which attends to issues like islandhood and grammatical voice.

Can this theory, in which reflexivity is a heterogeneous grammatical construct, more accurately account for how languages come to vary so much in their (surface-level) expression of reflexivity? In brief, this theory can indeed do just this, with only two critical assumptions, provided in (17).

- (17) a. LSOR is comprised of two atoms: a Voice head and an anaphor that moves to VoiceP
b. All variation is in properties of lexical items (Borer-Chomsky Conjecture; Baker 2008)

These assumptions correctly predict that the range of variation is not 100% free, but constrained by how these two lexical items can influence the form of the sentence. Either or both of the atoms of LSOR could be silent, and the movement could be obvious or concealed, and either of these could be homophonous/syncretic with other elements in the language. In addition, LSOR structures are fundamentally different from non-LSOR ones, allowing for multiple reflexivization strategies within a language. In this way, this framework allows for a wide range of variation, but makes supported predictions relating the possible forms to a single underlying structure.

A major finding of the investigation taken up in this chapter is that when a reflexivization strategy requires a local subject antecedent (a commonly attested pattern, heretofore largely underived and non-unified), the strategy is intimately related to grammatical voice. This is uncovered by the fact that LSOR may influence aspects of the clausal structure beyond anaphoric pronouns and

reflexive verbal heads (e.g. with regard to agreement paradigms, tense/aspect/mood paradigms, auxiliary selection, etc.), and for each language where Reflexivity does so, grammatical voice more generally influences those same elements.

Finally, this theory predicts that, if you probe deep enough, all languages distinguish LSOR from other types of reflexivity, opening the door for a new set of questions regarding the various types of reflexivity, and what is shared/distinct amongst them.

1.4 Summary: The Big Questions and Some Short Answers

Investigating the prosodic properties of English reflexive anaphors reveals that they fall into two different natural classes: one in which the anaphor seems somehow prosodically exceptional, and another in which it seems to behave prosodically normally. Making this discovery leads us to important theoretical questions; in particular, how do reflexivity and its properties emerge from the components of Grammar?

The basic finding uncovered here is that some anaphors (those in contexts of Locally Subject-Oriented Reflexivity) undergo syntactic movement to a Reflexive VoiceP. This movement derives a host of syntactic and semantic properties of LSOR anaphors, as well as their ‘exceptional’ prosodic properties in English. This makes the surprising and correct prediction that English prosodically ‘exceptional’ reflexives are constrained in all the same basic ways as LSOR marking is constrained other languages. In other words, English exhibits the same sensitivity to local-subject binding that has been known to exist more obviously in many other languages. This distinction is even encoded in the linguistic signal in English; while in many languages it is observable in the linear string, in English the distinguishing cues are prosodic.

This leads us to a critical finding: there are (at least) two kinds of reflexives anaphors (LSOR anaphors and non-LSOR anaphors), which are bound by their antecedent through different mechanisms. In the case of LSOR anaphors, Principle A's effects are derived as a simple consequence

of a structure containing Reflexive Voice^o. In these cases, there no need to refer directly to c-command or locality; instead, it results directly from first principles, such as how semantic composition propagates up the tree.

1.5 Roadmap

Let us briefly overview the shape of the dissertation. In chapter 2, I present some background and foundational ideas, which allow us to ask the necessarily more detailed questions in (3)–(4).

The proposed solution to each of these questions is a Reflexive VoiceP, and Chapters 3, 4, and 5 each provide different sources of evidence in its favor. Chapter 3 explores the placement of phrasal stress in English sentences with reflexive anaphors, and shows that movement within the lowest Spell-Out Domain occurs in clauses with a Reflexive VoiceP. In Chapter 4, we will explore data from a special interpretation of focused reflexive anaphors associated with Reflexive VoiceP, which is used to argue for the Reflexive Voice^o being the locus of semantic reflexivity. Chapter 5 focuses on the relationship between the Reflexive VoiceP and local subjects, cross-linguistically.

Finally, Chapter 6 concludes the dissertation, summarizing the major findings. Some of the next-step research questions that emerge from these conclusions are also discussed, including non-LSOR binding, lexical reflexivity, ellipsis facts, and other apparent exceptions at the syntax-prosody interface.

CHAPTER 2

Background

“A discovery in science, or a new theory, even when it appears most unitary and most all-embracing, deals with some immediate element of novelty or paradox within the framework of far vaster, unanalysed, unarticulated reserves of knowledge, experience, faith, and presupposition. Our progress is narrow; it takes a vast world unchallenged and for granted.”

– J. Robert Oppenheimer, Science and the Common Understanding (1954)

“This relation between sound (phonetic representation) and meaning (semantic representation) is not a direct one. It is mediated by structure, or syntax, the arrangement of a sentence into parts.”

– Elisabeth Selkirk, Phonology and Syntax (1984)

In this chapter, I define the framework assumed and core theoretical concepts employed in this dissertation. First, I provide a brief overview of the Minimalist architecture of grammar that is assumed here, highlighting some relevant core principles. Following that, the relevant basics of prosodic phonology are described, assuming no background on the topic. Finally, the chapter culminates in a discussion of how focus must be represented in Grammar, highlighting the interface principles discussed earlier in the chapter. This will be critical for analyzing the core novel data of the dissertation, which is concerned with the interdependence between syntactic, semantic and prosodic properties of reflexives.

2.1 Syntax and the Interfaces

2.1.1 General Grammatical Architecture

I assume a Minimalist architecture of grammar (Chomsky 1995, 2000) in which lexical items select syntactic objects. Any instance of selection must be resolved by merging the selector with the selectee to form new syntactic objects. These complex syntactic objects are then transferred to the interpretive interfaces (semantics/pragmatics and phonology/phonetics) so that they can be given the appropriate interpretations and forms. For detailed definitions and an overview of how these operations work to build complete derivations, see Collins and Stabler 2011, To Appear and references therein.

Critically, the syntactic derivation is broken into smaller cycles of computation. The completion of each cycle results in transfer of structure to the interfaces and the generation of phonological and semantic representations. Phase theory (Uriagereka 1999, Chomsky 2000, 2001, 2008, Citko 2014, Collins and Stabler To Appear, among many others) is assumed to define these smaller cycles of computation.

To be more specific, certain functional projections on a derivational spine trigger the transfer to the interfaces, and such functional projections are called phases. When the syntactic structure building completes a phase, it sends the complement of the phase head (called the Spell-Out Domain) to the phonology and semantics. In this way, a structure like (1) will involve minimally two Spell-Out Domains, indicated by the boxes. Finally, there is a final Spell-Out operation that will include the phrase Phase2P in (1), being that there are no more phases to build.¹

¹Some have argued that Phase2P does not (always) get Spelled-Out in root clauses (e.g., Fitzpatrick 2006, Rizzi 2006).

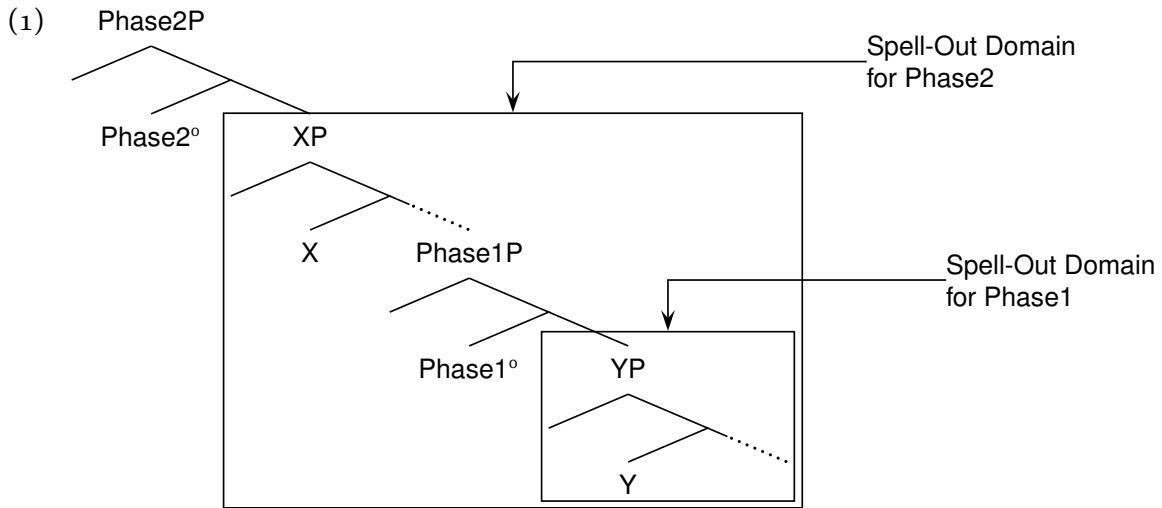

Each component then generates phonological and interpretational representations in parallel, and feeds this information back into the syntactic derivation. This gives the grammar general shape of Figure 2.1.² (This is what Uriagereka 1999 calls the “conservative” proposal to integrating multiple Spelled-Out structures into a single utterance.)

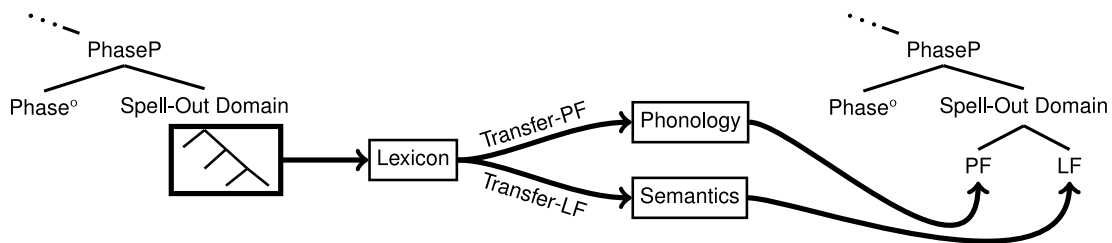

Figure 2.1: Sketch of the Grammatical Architecture

After the Spell-Out Domain is processed by Phonology and Semantics, the result is a Spell-Out Domain which has been reduced to a syntactic label paired with PF and LF representations, instead of syntactic structure. This atomized structure resembles a word in that it is a tuple of grammatical features (including a label), phonological form, and semantic form, which is manipulated

²This shares similarities with a Distributed Morphology model, though this model does not invoke morphological operations (e.g., local dislocation) between the lexicon and phonology (cf. Embick and Noyer 2001). Additionally, lexical access does not feed semantics in typical DM models, and instead occurs on the path from syntax to phonology. It seems to me that lexical items feed semantics, on the basis of implicatures triggered by particular lexical items and on the basis idiomatic interpretation of certain collections of lexical items. Nothing in this dissertation crucially relies on the timing of lexical access.

by the syntax.³

It is clear how, in this model, phonological and semantic information can accumulate in the derivation. When the next Spell-Out Domain is reached, the phonological and semantic information from the previous domain is exactly where the syntax would predict it to be.⁴ This architecture allows for the Phase Impenetrability Condition (Chomsky 2000) to be derived; the syntactic information of the material inside a Spell-Out Domain is lost by the process of association with phonological and semantic form.⁵

2.1.2 Interfaces in Minimalism

A Minimalist grammar is restricted in which modules of the grammar can interact directly, and also restricts what kind of information is available to which module. This provides the necessary foundation to approach phenomena that occur at the syntax-prosody interface.

Since Spell-Out independently and simultaneously sends syntactic material to the LF and PF components for interpretation and externalization (among other things), there is no point at which the LF and PF components communicate directly. As such, no valid PF process may directly rely on linguistic information that is only encoded in or determined by the LF component. I present this in the form of a postulate:

(2) **Interface Postulate A: the Number of Interfaces**

No operations in Phonology depend on operations/properties of Semantics, and vice-versa. (There is no Semantics-Phonology Interface).

The only sense in which LF and PF interact is rooted in their shared common base (the syntactic component), which determines their respective inputs.

³Collins and Stabler To Appear argue that this replacement violates the No Tampering Condition. In a certain manner speaking, it would seem to, but perhaps lexical insertion and mapping onto phonology and semantics is the kind of tampering that must occur to make structures externalizable.

⁴For an example of why this is necessary, see McPherson 2014:Ch.3, in which already spelled-out material with a specified phonological form behaves as active in the syntax, sensitive to *c*-command.

⁵The PIC is not derived if phonological and semantic information cannot *replace* syntactic information. See footnote 2.

Additionally, not all aspects of the syntactic representation get passed on to the interfaces. To be more clear, during the syntactic derivation that builds up the Spell-Out Domain in Figure 2.1, there is a non-trivial amount of information that doesn't undergo Transfer to PF or LF – in particular, purely syntactic features (a.k.a. uninterpretable features) must not reach the interfaces. Instead, they must be deleted (or “checked”) by the time LF or PF receive their input, as LF and PF cannot interpret them (“legibility conditions”, Chomsky 2000:§3.2).⁶ For this reason, it must not be the case that PF or LF depend on having access to formal syntactic features:

(3) **Interface Postulate B: Post-Syntactic Components**

PF and LF can only access information from syntax in the form of bare syntactic structures. (They do not have access to uninterpretable syntactic features.)

Thus, any PF (or LF) effects that appear to be the result of uninterpretable features (e.g., syntactic label/grammatical category) must not be.⁷ Instead, any such effect must be the result of something that PF does have access to: interpretable features, syntactic hierarchy, prosodic structure, phonological features, etc.

Finally, the most general postulate we have concerns the independence of syntax, phonology and semantics.

(4) **Interface Postulate C: Isolation of Components**

The grammatical rules/constraints of each component is limited in being able to only refer to objects that are primitives of their component.

- a. Syntactic constraints/rules may only refer to syntactic objects (e.g. features, phrases, heads, etc.)
- b. Phonological constraints/rules may only refer to phonological objects (e.g. syllables, pitch accents, etc.)
- c. Semantic constraints/rules may only refer to semantic objects (e.g. functions, functors, etc.)

⁶If uninterpretable formal syntactic features reach LF or PF, the derivation crashes (though cf. Preminger 2011). These features may be deleted during Vocabulary Insertion, which happens at or just/after Spell-Out (Halle and Marantz 1993). As such, lexical items, interpretable features (but not the deleted uninterpretable features), and syntactic hierarchy are sent to PF.

⁷Recent work by Chomsky assumes that grammatical labels are interpretable by the interfaces (Chomsky 2013:46). It is not clear why this should be so. However, it has been claimed that certain aspects of phonology rely on, for example, the noun/verb distinction (see Smith 2011), though it is not clear that this is not just correlation derived from a separate source.

For example, where PF effects movement of a string, it does so only in the phonological component with no changes in interpretation or syntactic structure. Infixation has been shown to be an instance of this kind of PF movement: the soon-to-be infix is merged in the syntactic component outside of the root/stem, and PF constraints/rules cause it to be pronounced in the appropriate position (e.g., McCarthy and Prince 1993, Halle 2001). Similarly, certain position-specified clitics may also be derived using phonological movement that is sensitive to phonological primitives, such as prosodic words and phonological phrases, but not syntactic position (e.g., Harizanov 2014). Moreover, as so called heavy shift has been shown to be syntactically restricted by e.g. island constraints (Ross 1967), Postulate C rules out heavy shift⁸ as being a PF phenomenon, or even a syntactic phenomenon sensitive to phonological weight. (See Büring 2013 for a sketch of an analysis in this vein.)

To summarize, the phonology and semantics lack access to information such as discourse givenness (Postulate A) or syntactic categories (Postulates B/C). As such, if either of these appear to give rise to any phonological or semantic effects, such a putative cause-effect relationship must be only illusory, and a new generalization must be found.

Taken with the other postulates, we now have the foundations to approach the simultaneous independence and interdependence between the components. We expect to find that putatively exceptional/mismatch phenomena at the interfaces often require deeper solutions, as the terms in which many of them are descriptively defined are at odds with the interface postulates above. Taking this kind of principled approach to the ‘exceptional’ data we have in reflexive prosody, we will find deeper understanding of the Grammar, that would remain undiscovered without these postulates.

⁸At least not *all* instances of what has been called heavy shift.

2.2 Prosodic Background

2.2.1 The Autosegmental-Metrical Model

To begin, let us discuss a theoretical model for intonational patterns. I assume the Autosegmental-Metrical (AM) model of English intonational phonology, as developed in Pierrehumbert 1980 and Beckman and Pierrehumbert 1986. In particular, I adopt the labeling conventions of the Tones and Breaks Indices model for Mainstream American English (MAE_ToBI), as laid out in Beckman and Hirschberg 1994 and later elaborated upon in Beckman et al. 2006. This model is abstractly portrayed in Figure 2.2. There are (at least) four relevant levels of prosodic structure: intonational phrases (IP), intermediate phrases (iP), prosodic words (ω), and syllables (σ) – and three types of tonal objects – pitch accents (T^*), phase accents (T^-), and boundary tones ($T\%$). Prosodic words associated with phrasal stress are labelled with an acute accent ($\acute{\omega}$), and syllables associated with lexical stress are also labelled with an acute accent ($\acute{\sigma}$).

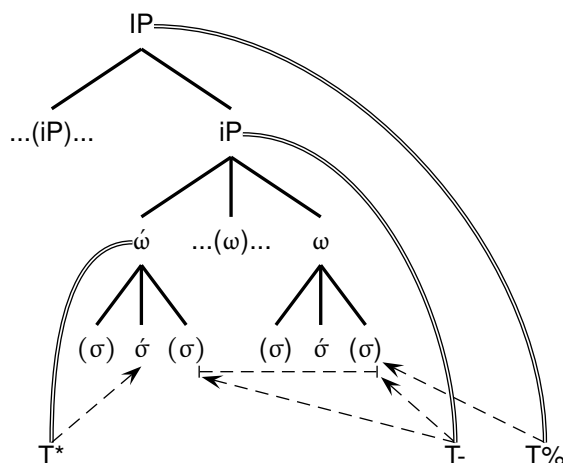

Figure 2.2: Sketch of the Autosegmental-Metrical Model of English

The solid double lines in Figure 2.2 indicate underlying (phonological) association, whereas the arrowheads on the dotted lines indicate the surface (phonetic) positions of each of these (relative⁹) tonal targets. (Interpolation essentially fills in any gaps between tone targets.) In this way,

⁹Tonal targets are not absolute, but relative as the model is a phonological one; pitch range is variable and may shift

the sketch above conveys the following information.¹⁰

(5) Auto-Segmental Model of English

- a. Every intonational phrase (IP) contains at least one intermediate phrase (iP)
- b. Every iP contains at least one prosodic word (ω)
- c. Every iP contains at least one prosodic word with phrasal stress ($\acute{\omega}$)
- d. Every prosodic word (ω or $\acute{\omega}$) contains a syllable with lexical primary stress ($\acute{\sigma}$)
- e. Every $\acute{\omega}$ is associated with a pitch accent (T^*) which is realized on the $\acute{\sigma}$ of the $\acute{\omega}$
- f. Every iP is associated with a phrase accent (T^-) which is realized as a cover tone that spreads leftward from the final syllable of the iP to the right edge of the rightmost $\acute{\omega}$
- g. Every IP is associated with a boundary tone ($T\%$) which is realized on the final syllable of the IP

Some of these properties will be discussed in more depth in the following paragraphs, in relation to (6), which is a visual representation of certain aspects of a particular recording from the 1997 English Broadcast News Speech corpus (Fiscus et al. 1998, file em970916):

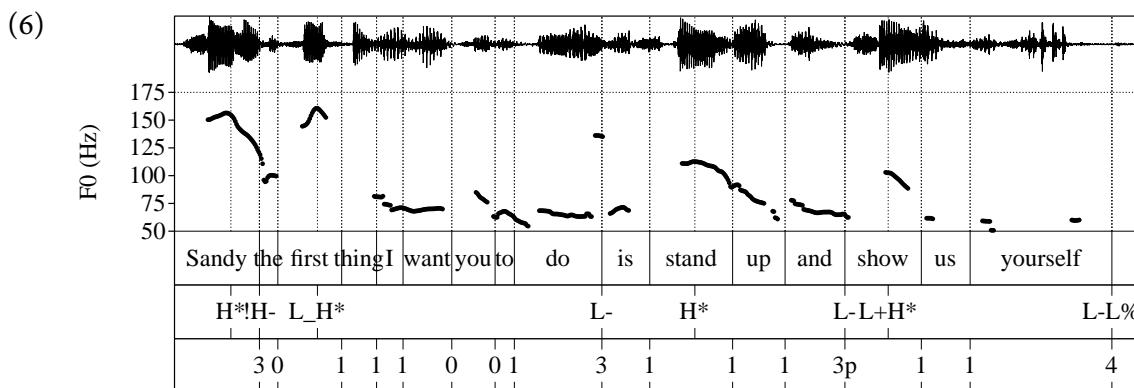

At the top of the figure in (6), the waveform for the recording is given. Distance from the centerline indicates amplitude of the wave, giving a rough estimate for intensity. Below the waveform, there is a pitch track, in which the fundamental frequency of the utterance is estimated by computer software called Praat (Boersma and Weenink 2014). There are gaps and errors in the estimated

throughout a single utterance. As such, a “low” tone target at one point in the utterance may be at a very different frequency than at another point in the same utterance. See e.g. Ladd 1996.

¹⁰The labels iP and IP are used for prosodic phrasings, following the MAE_ToBI conventions. However, not much critically changes if we use the labels ι and ϕ instead, respectively. One difference between models that use ι and ϕ is that they may allow recursion of constituents (e.g. ϕ within ϕ), which is disallowed by models (such as ToBI’s autosegmental metrical model) that adhere to the strict layer hypothesis (Selkirk 1984, *et seqq.*). For this reason, we would need to identify which kind of ϕ (the minimal one, the maximal one, or some intermediate one) is the phrasal stress domain.

pitch, due to effects of the individual consonants/vowels, as well as the recording. Below the pitch track, there are three tiers, which have annotations following the MAE_ToBI labeling conventions. From top to bottom, the three tiers are: a ‘word’ tier, a ‘tone’ tier, and a ‘break’ tier. The ‘word’ tier is entirely straightforward: the boundaries between words represent the word-boundaries. The ‘tone’ tier contains points at which T*s and T-s are realized: T*s are time-coded to the relevant phonetic pitch, and T-s are aligned with the boundary with which they are associated. This brings us to the ‘break’ tier, in which prosodic boundaries are indicated with various numbers: A 1 corresponds to a prosodic word (ω) boundary, a 3 corresponds to an iP (and simultaneous ω boundary) boundary, and a 4 corresponds to an IP (and simultaneous ω and iP) boundary.¹¹

Let us now turn our discussion to the properties of pitch accents (T*s). Pitch accents are relativized tone target that are abstractly associated with prosodic words, and are realized on the primary stressed syllable of the prosodic word. English has eight phonemic pitch accents:¹² low (L^*), high (H^*), downstep high ($!H^*$), rising peak ($L+H^*$, $L+!H^*$), scoop (L^*+H , $L^*+!H$), and staircase fall ($H+!H^*$).¹³ In (6), there are four pitch accents: the H^* on *Sandy*, the $L+H^*$ on *first*, the H^* on *stand*, and the $L+H^*$ on *show*. Each of these accents is placed on the tone tier where the relevant peak/valley is realized in the pitch track.

In English and languages like it, the choice of pitch accent and the segment(s) they are realized on is not determined on a per-lexical-item basis, instead it only relies on the location of lexical stress and general post-lexical properties of an utterance. In fact, the various pitch accents of English are associated with their own functions/interpretations; for example, H^* is the default pitch accent used to mark of phrasal stress in English (in a declarative environment). For a more complete discussion of pitch accents and their relationship to interpretative properties, see Pier-

¹¹There are other possible boundaries; see Beckman et al. 2006.

¹²This is of some debate. Some argue that H^* and $L+H^*$ are phonetic realizations of the same phonemic pitch accent. See e.g. Watson et al. 2008.

¹³To be clear, with simplex pitch accents – i.e. L^* , H^* , $!H^*$ – the T* is realized during the syllable with primary stress. With complex pitch accents – i.e. $L+H^*$, $L+!H^*$, L^*+H , $L^*+!H$, and $H+!H^*$ – the T* is realized on the syllable with primary stress, and the other part of the accent (separated by the +) occurs on the preceding/following syllable.

rehumbert and Hirschberg 1990.

Let us now turn to phrase accents (T-s). Phrase accents are associated with intermediate phrases (iPs) in the model, and are realized within the iP. English has three phrase accents: low (L-), high (H-), and downstep high (!H-). As with pitch accents, choice of phrase accent is also determined by grammatical context. Phrase accents are realized as cover tones that spread from the iP's final syllable leftward, until reaching the right edge of a prosodic word containing a pitch accent – this final pitch accent in a prosodic phrase is called the nuclear pitch accent (NPA). In (6), there are four iPs (all within the same IP), each of which is accordingly associated with a phrase accent. Each of these iPs contains a single pitch-accented word (*acute*), which is the NPA. Each of these iPs and pitch-accented words are given in (7a-d), where pitch accents are marked with acute accents and bold italics:

- (7) a. [_{iP} *Sá****ndy***]
b. [_{iP} the *fí****rst*** thing I want you to do]
c. [_{iP} is *stá****nd*** up and]
d. [_{iP} *shó****w*** us yourself]

The rightmost syllable of the iPs is associated with the T-, and where possible there is a second tone target associated with the right edge of the NPA (the phrase's final *acute*). In (7a), there is only one prosodic word in the iP, so the right edge of the iP is also the right edge of the NPA, so the !H- cannot spread leftward – there is simply no room. As a result, there are two tone targets for this iP: the high of the H* pitch accent on the first syllable of *Sandy*, and the downstep high of !H- phrase accent on the second syllable of *Sandy*, and the pitch interpolates between those two targets. On the other hand, in (7c), there are three tone targets: the high of the H* on *stand*, the low of the L- at the right edge of *stand*, and the low of the L- on *and*.¹⁴

¹⁴The pitch also appears to be falling during 'up' as well. The model predicts it to have reached the low of the L- by the beginning of 'up', but what the model predicts is not always what is realized, especially when the pitch has a long way to travel in a short interval of time. See Pierrehumbert 1980, Pierrehumbert and Beckman 1988, and Barnes et al. 2010. Similar effects can be observed in the pitch falling from the high of the H* of 'first' to the low of the L- during 'thing', even though the model would strictly speaking predict the pitch to have reached the low of the L- by the beginning of 'thing'.

Finally, there are boundary tones (T%s). Boundary tones are non-spreading tone targets that occur on an edge-adjacent syllable of an IP. English has three boundary tones: low (L%), high (H%), and initial high (%H). Every IP has an L% or H% on its final syllable, whereas the %H is optional (and more rare) and occurs on the initial syllable of an IP. Since every right edge of an IP is also the right edge of an iP, T%s and T-s both have tone targets that are realized on the final syllable of the IP. This leads to significant interaction in how the T- and T% tone target are realized on the IP-final syllable. For an in-depth discussion of how they interact, see e.g. Pierrehumbert and Hirschberg 1990 and Beckman and Hirschberg 1994.

Before concluding this summary of MAE_ToBI-labelled pitch tracks, it must be discussed where the labelling comes from. As with transcription using phonetic alphabets, it is done impressionistically by trained labellers who attend to phonetic details that are visible in the pitch track, waveform and spectrogram. When the phonetic source is compatible with multiple possible underlying transcriptions, the labeller may use his or her native speaker intuition. In particular, when faced with a decision of whether or not a word has a pitch accent, native speaker labellers rely primarily on the phonetic cues, and if they are uninformative, they rely on whether they perceive prominence on the relevant word. This is the practice I follow in labelling all the data in this dissertation.

2.2.2 Lexical Stress vs. Phrasal Stress

Let us first clarify that stress is an *abstract* prominence feature. In this sense, stress itself is not measurable in the signal, but can instead be phonetically realized in a number of ways; in English, this includes changes in pitch, amplitude and/or length. In addition, different types of phonological units can be associated with their own stress. This is at the core of the distinction between lexical stress and phrasal stress.

Every phonological word-level unit – prosodic word (ω) – must contain at least one stress-marked syllable.¹⁵ One of those stress-marked syllables must be the primary stress; this is the lexical stress of the prosodic word.¹⁶ In the same way, phonological phrases¹⁷ also carry a stress – phrasal stress. Unlike lexical stress which marks the relative prominence between syllables, phrasal stress marks prominence levels between words.

Though phrasal stress is marked on a word in a phrase, the acoustic reflexes of that stress are not evenly distributed within that word; phrasal stress is realized on word’s primary lexical stress. Imagine a phrase with four words, like (8a), in which each word contains two syllables, and the third word has the phrasal stress (indicated by underlining and italic), with the first syllable of that word bearing the primary lexical stress for that word (indicated by the acute accent, ‘ ’). That first syllable of the third word will exhibit properties of both lexical stress as well as phrasal stress, each of which are symbolized through the S(trong)-labeled branches:¹⁸

(8) a. badá₁ báda₂ báda₃ badá₄

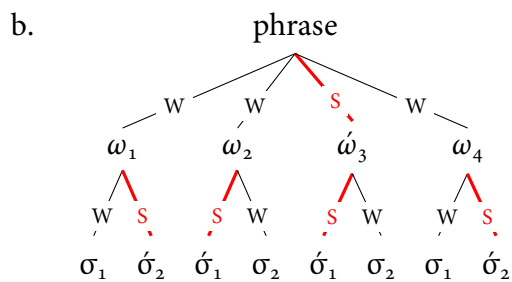

In this way, the structure represented in (8b) does not designate any specific intonation (or other phonetic/phonological features) to word₃ – it only dictates that word₃ has the abstract phonolog-

¹⁵This begs the question of what defines a prosodic word. For our purposes, the answer is simply that it behaves as a word with regard to phonological processes. (Of course, more complex answers ought to be sought out.) Importantly, a “word” in other senses, such as ‘the’, may not always behave as a prosodic word. (See Nespor and Vogel 1986 and Selkirk 1996a.)

¹⁶Deriving which syllables are stressed, and which stress is the primary one are problems that are very complex in nature, and are well outside the scope of this dissertation. (See Chomsky and Halle 1968.)

¹⁷I use this term in the loose sense of ‘phrase of phonological units’. I do not mean any specific level of phrasing (e.g., iP, IP, φ, or ι). This is because different models posit different numbers/formulations of phrases. See also footnote 10.

¹⁸There are levels of phonological structure that are not represented in (8b), such as the foot, which are irrelevant for this discussion.

ical properties that mark it for being the most prominent in the phrase. The other, more concrete phonetic features associated with these stress branches (e.g. pitch, amplitude and length) are determined separately.

A very important question, which is critical for nearly all of our discussion of phrasal stress in this dissertation, is that of how it is determined which branches are strong ones. The strong branches associated with lexical stress are determined by the lexical item (and the rules that underlie lexical stress assignment) – this will not be investigated in this dissertation (see footnote 16). We will investigate how the strong branch associated with phrasal stress is determined. Importantly, though the two abstract properties of lexical stress and phrasal stress are assigned independently of one another, both play an important role in determining the placement of pitch accents, as we will see in the next section.

2.2.3 Pitch Accents and Phrasal Stress

Since the H* tone may be underlyingly associated with the phrasal stress of an iP, we could perhaps model the second iP of a sentence like (9a), will have the phonological structure in (9b):

(9) a. [_{iP} The woman with a ponytail] [_{iP} explored many caverns today].

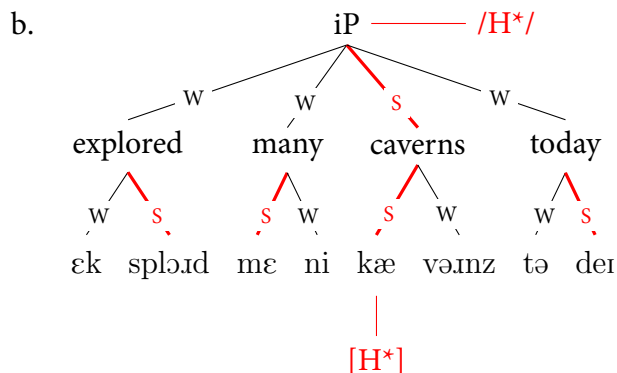

What this is meant to depict is that the H* pitch accent is phonetically realized on the lexical stress of ‘caverns’, while it is more abstractly associated with the whole iP. Despite the H* pitch accent being associated with the whole phrase, an H* is not realized on the entire iP, but only on its prosodically strongest member. The strongest member in this representation can, descriptively

speaking, be determined by starting at the root and following the strong branches down as far as we can go. This yields the result that the [kæ] syllable is its prosodically strongest member, and it will be the location of H*'s realization.

While this level of description is accurate for our purposes, it begs a very important question: why is this model accurate? Where does the phonological structure in (9b) come from, and what determines that *caverns* is the strongest branch in this four-word phonological phrase? The answers to these questions lie in the relationship between syntactic structure and prosodic structure, which will be more fully explored in Section 3.5 of Chapter 3. In brief, the phrasal stress rule states that the phrasally stressed prosodic word (*caverns* in (9b)) is the prosodic word corresponding to the most deeply embedded constituent in the (syntactic phrase that corresponds to the) iP. In other words, the most deeply embedded constituent (which corresponds to a prosodic word) in a syntactic domain (which corresponds to an iP) gets marked as phrasally stressed. This stress is called the nuclear stress of a phrase, and the principle behind the location of the nuclear stress is called the Nuclear Stress Rule (NSR).

In this sense, the iP is the domain of the NSR. Each iP must contain a phrasal stress given that that is the domain of the phrasal stress rule. Since every phrasally stressed prosodic word is associated with a pitch accent (5c), we have now derived why every iP has at least one PA (5e).

At the same time, pitch accents distribute more broadly than what the NSR predicts. Every nuclear stress (determined by syntax) must be associated with a pitch accent (Nuclear Pitch Accent). However, there must also be a secondary way in which prosodic words that are not phrasally stressed can also bear a pitch accent. In other words, phrasal stress (determined by the NSR) implicates pitch accent, but this is a one-way implication; pitch accents do not implicate phrasal stress. (This is encoded by the spirit of Büring 2013's Stress-to-Accent principle)

I do not endeavor to derive the distribution of non-nuclear pitch accents. It may be that syntax has a hand in determining non-nuclear pitch accents (similar to how it determines the NPA via the NSR), or it may be that these are governed solely by phonological/lexical effects such as

rhythm rules, prosodic heaviness, or frequency, or it may be some mix of syntactic, phonological, and lexical effects. I note this about non-nuclear pitch accents now so as to avoid unnecessary confusion what can be learned about syntax from prosody: we will only draw conclusions based on nuclear pitch accents and nuclear stress.

2.2.4 Default Phrasal Stress and Focal Stress

Before continuing on to the relationship between phrasal stress and syntax, it is important to note that there are different types of phrasal stress. Every phonological phrase¹⁹ occurs with some kind of phrasal stress, and in each phrase, there is a position that is in a sense the “default” location. Such a position can be uncovered when all the material in the phrase has the same discourse status (i.e. given, focused or new). Traditionally, this default stress is elicited through maximally discourse-neutral (also called broad focus) questions, such as *What happened?* (e.g. Zubizarreta and Vergnaud 2006). In (10), and throughout the dissertation, **bold underlined italics** are used to indicate default phrasal stress.

(10) A: What happened?

B: The woman with a ponytail explored many **cáaverns** today.

The default stress location for the whole utterance in (10B) is on *caverns*. Other positions are possible for the position of phrasal stress, but would implicate secondary (non-truth-conditional) interpretations apart from the ordinary semantic value (in the sense of Rooth 1985) of the phrase. For example, if phrasal stress had fallen on *explored*, it might convey a secondary interpretation that ‘*many caverns*’ was assumed to already be under discussion.

In this way, it has long been noticed that changes in discourse relations (in a pre-theoretical sense) play a critical role in the determination of which constituent receives phrasal stress. Though default stress is predictable, manipulating the discourse context of what is given, new or focused can appear to “shift” the location of phrasal stress (a point extensively argued in e.g. Bolinger

¹⁹Of the relevant type; intermediate phrases in the English ToBI system.

1972).²⁰ One relevant way in which the location of phrasal stress can differ from the default position is through semantic focus. In (11) and throughout the dissertation, **SMALL CAPS** are used to indicate focal phrasal stress, and the subscript F is used to indicate semantic focus.

(11) The woman with a ponytail explored **MÁNY**_F caverns today, and only a few yesterday. In the example in (11), however, *many* is semantically focused, in contrast to *a few* in the following conjunct.

Thus there are, descriptively, at least two kinds of phrasal stress: default stress as in (10), and focal stress as in (11). These different types of phrasal stress are correlated with different properties; for example, in English, focal stress is typically associated with more sudden, steeper pitch movements than default stress. (In the ToBI model, this difference may correspond to L+H* and H*, in declarative environments.)

2.2.5 A Principle of Semantics-Prosody Isomorphism: QAC

We turn now to a case of an apparent dependency between semantics and prosody. A felicitous answer to a question must obey a principle like Question-Answer Congruence (henceforth QAC; Halliday 1967, Rooth 1992, Selkirk 1996b, Schwarzschild 1999, Krifka 2004 among others), which can be roughly stated as following:

(12) **Question-Answer Congruence**

An appropriate answer to a question must semantically and prosodically focus the constituent(s) being questioned.

QAC can be seen as enforcing an isomorphism between semantic structure (LF) and prosodic structure (PF): it requires there to be both semantic and prosodic effects of focus applied to the same constituent.

Consider the following question-answer pairs, in which only one of the possible focus prosodies

²⁰There is only the *appearance* of disruption of the normal stress assigning rule. See Ahn 2014.

is felicitous – the one in which the semantically focused constituent (bracketed and marked with a subscript F in the examples below) exhaustively contains the prosodic focus (indicated by bold, underlined small-caps):

- (13) Q: Who saw Frank high-five Toofer?
 A1: [LÍZ]_F saw Frank high-five Toofer.
 A2: # [Liz]_F **SÁW** Frank high-five Toofer.
 A3: # [Liz]_F saw **FRÁNK** high-five Toofer.
 A4: # [Liz]_F saw Frank **HIGH-FÍVE** Toofer.
 A5: # [Liz]_F saw Frank high-five **TÓOFER**.
 A6: # [LÍZ]_F **SÁW** Frank high-five Toofer.
 A7: # [LÍZ]_F saw **FRÁNK** high-five Toofer.
 A8: # [LÍZ]_F saw Frank **HIGH-FÍVE** Toofer.
 A9: # [LÍZ]_F saw Frank high-five **TÓOFER**.
- (14) Q: What did Liz see Frank do?
 A1: # LÍZ saw Frank [high-five Toofer]_F.
 A2: # Liz **SÁW** Frank [high-five Toofer]_F.
 A3: # Liz saw **FRÁNK** [high-five Toofer]_F.
 A4: # Liz saw Frank [**HIGH-FÍVE** Toofer]_F.
 A5: Liz saw Frank [high-five **TÓOFER**]_F.
 A6: Liz saw Frank [**HIGH-FIVE TÓOFER**]_F.
 A7: # Liz saw **FRÁNK** [**HIGH-FIVE TÓOFER**]_F.
 A8: # Liz **SÁW** Frank [**HIGH-FIVE TÓOFER**]_F.
 A9: # LÍZ saw Frank [**HIGH-FIVE TÓOFER**]_F.

QAC cannot be formalized in our grammatical architecture, as it would rely on Phonology and Semantics sharing information, at odds with the Interface Postulates in (2)–(4). If QAC is only a descriptive statement, we can derive it separately, given that the narrow syntactic derivation feeds both LF and PF, and it need not be the case that Phonology and Semantics directly communicate. Under the approach taken up here, focused constituents are F(ocus)-marked in the syntax (e.g. Jackendoff 1972, Selkirk 1984, Rooth 1985, Selkirk 2007, Büring 2013), and sent to the semantic and phonological components of the grammar.²¹ In this way, both components act upon the following

²¹This raises the question of where syntactic F-marking comes from. Answering this is far beyond the scope of this work. I assume it is through association with a syntactic head that is spelled out as the specific language's focus-marker (e.g. morphological marking, pitch accent, etc.), but see Stevens To Appear for discussion of a different possibility. In this sense, the prosody doesn't truly see the syntactic feature, but only its spelled-out form. (It may be the case that, simultaneously, some syntactic movement of non-focused material needs to happen to place given

(simplified) structure:

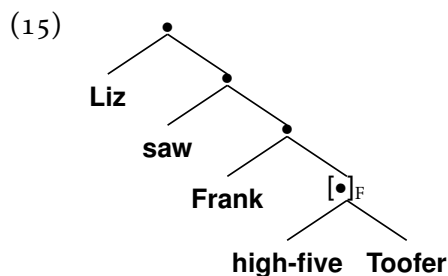

As a result of the constituent *high-five Toofer* being F-marked in the narrow syntax, the LF and PF components will respectively impose the desired interpretive and prosodic effects on it independently – thus deriving the isomorphism effects of (the unformalizable) QAC.

This raises an important question: what is the nature of locating the accent within the F-marked constituent? It has been argued that what I have marked as F-marking in (15) is actually the upper bound on an operation called Focus Projection (Selkirk 1984, Rooth 1992, Schwarzschild 1999, among many others). In such theories, the F-marking for (15) would actually be represented as:

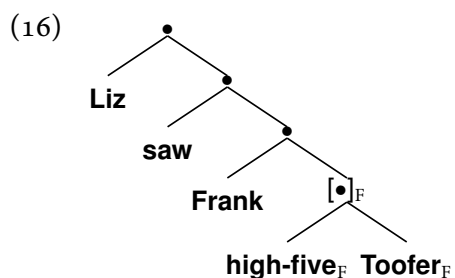

In these analyses, *Toofer* is what bears the accent because it is the internal argument of *high-five* and so it should be more prominent than the head. This is done by stipulation, but ends up having quite robust empirical support. (We need not understand the details of how Focus Projection works.)

material outside of the scope of the focus marker at LF – as predicted by a Schwarzschild's (Schwarzschild 1999) AVOIDF theory of focus – this movement is visible in Bantu (Zubizarreta 2010, though cf. Cheng and Downing 2012).

In recent years, many have come to reject the idea that the placement of the accent inside the F-marked phrase is done by Focus Projection rules (Büring 2006, 2013, Schwarzschild 1999, Selkirk 2007, Zubizarreta 1998, among many others). Instead, the stress inside the F-marked constituent is placed by whatever general principles locate phrasal stress within any kind of domain. This kind of position is one of the earliest in generative work on focus and stress, going back to Jackendoff 1972:237: “the highest stress in S will be on the syllable of [the focus constituent] that is assigned the highest stress by the regular stress rules”, and has been recently promoted as not only theoretically simpler, but empirically more justified (see also Büring 2013, but cf. Selkirk 2007 for a slightly different view).

What we can conclude is that focused constituents are F-marked in the syntax, and phonology and semantics each separately interpret that F-mark in their own way. In terms of phonology, the focal accent is placed on a syllable by the normal rules of phrasal stress placement, in the relevant context.²² The semantics sees F-marking on the same constituent as phonology, and for this reason, the principle of QAC in (12) is simply a corollary of the grammatical architecture.

2.3 Summary

In this chapter, we have seen the general architecture of grammar that will be adopted for this dissertation: a Multiple Spell-Out model in which the number of interfaces and the direction of the flow of information is constrained.

(2) **Interface Postulate A: the Number of Interfaces**

No operations in Phonology depend on operations/properties of Semantics, and vice-versa. (There is no Semantics-Phonology Interface).

(3) **Interface Postulate B: Post-Syntactic Components**

PF and LF can only access information from syntax in the form of bare syntactic structures. (They do not have access to uninterpretable syntactic features.)

²²In order to account for the same robust set of facts as the focus-projection approach, this will rely on separate treatment of, for example, given material, which has already been proposed. (See Selkirk 2007 for more discussion.)

(4) **Interface Postulate C: Isolation of Components**

The grammatical rules/constraints of each component is limited in being able to only refer to objects that are primitives of their component.

- a. Syntactic constraints/rules may only refer to syntactic objects (e.g. features, phrases, heads, etc.)
- b. Phonological constraints/rules may only refer to phonological objects (e.g. syllables, pitch accents, etc.)
- c. Semantic constraints/rules may only refer to semantic objects (e.g. functions, functors, etc.)

These constraints guide our interpretation of the prosodic data that we see, given that it is incoherent under these postulates to formulate semantic-based constraints on phonological rules.

In addition, we reviewed the core properties of the autosegmental model of prosody that is adopted for English.

(5) Auto-Segmental Model of English

- a. Every intonational phrase (IP) contains at least one intermediate phrase (iP)
- b. Every iP contains at least one prosodic word (ω)
- c. Every iP contains at least one prosodic word with phrasal stress ($\acute{\omega}$)
- d. Every prosodic word (ω or $\acute{\omega}$) contains a syllable with lexical primary stress ($\acute{\sigma}$)
- e. Every $\acute{\omega}$ is associated with a pitch accent (T*) which is realized on the $\acute{\sigma}$ of the $\acute{\omega}$
- f. Every iP is associated with a phrase accent (T-) which is realized as a cover tone that spreads leftward from the final syllable of the iP to the right edge of the rightmost $\acute{\omega}$
- g. Every IP is associated with a boundary tone (T%) which is realized on the final syllable of the IP

In particular, we are interested in the domain of phrasal stress and the rule governing its distribution (the Nuclear Stress Rule).

Finally, we saw that focal stress is (descriptively) governed by a principle of LF-PF isomorphism, the QAC.

- (12) **Question-Answer Congruence:** An appropriate answer to a question must semantically and prosodically focus the constituent(s) being questioned.

Though QAC is stated in terms of comparing semantic forms and phonological forms, this is strictly speaking impossible. Instead, it must be that QAC takes root in the syntax, which feeds both semantics and phonology.

CHAPTER 3

Reflexivity and Phrasal Extrametricality

“Our pre-scientific general beliefs are hardly ever without exceptions; in science, a law with exceptions can only be tolerated as a makeshift.”

– Bertrand Russell, The Analysis of Matter (1927)

“Any difference in the patterns of phrase, and sentence, stress [...] should instead follow from [differences in] constituent structure...”

– Guglielmo Cinque, A Null Theory of Phrase and Compound Stress (1993)

This chapter investigates the locus of phrasal stress in English sentences that contain reflexive anaphors. Reflexive anaphors seem to avoid phrasal stress in some positions where other elements would bear it, as below:¹

- (1) a. Dennis embarrassed Líz. *Final Stress*
b. Dennis embárrassed himself. *Non-final Stress*

In this sense, reflexive anaphors appear to be *extrametrical* for phrasal stress placement – i.e. reflexive anaphors are ignored by the stress placement mechanisms as a potential locus of phrasal stress (cf. extrametricality in the lexical domain; e.g. Liberman and Prince 1977, Hayes 1995). The basic idea that anaphors may be extrametrical has been reported in many past works (e.g. Bresnan 1971, Zubizarreta 1998), with relatively shallow discussion of the details. Three intuitive ideas which will be discussed in this chapter are given in (2):

¹Recall that, throughout this thesis, the bolded underlined italics indicate the locus of phrasal stress. See Section 2.2.4.

(2) Logically Possible Accounts of the Prosodic Weakness of Reflexive Anaphors

- a. Reflexive anaphors are lexically (i.e. inherently) weak
- b. Reflexive anaphors are instances of weak pronouns more broadly
- c. Reflexive anaphors are always formally given, as a result of necessitating an antecedent

I demonstrate that the generalizations on when reflexive anaphors do and do not bear phrasal stress are more complex than any of these intuitive ideas can account for, in Sections 3.3.2, 3.3.3, and 3.4, respectively.

The basic way in which previous assumptions fail is that reflexive anaphors do not avoid phrasal stress across the board, and instead the availability of prosodic contours are subject to the following constraints:

(3) **Descriptive Condition on Islands**

A reflexive anaphor may bear phrasal stress in a broad focus context, if it occurs in an island that excludes (any copy of) its antecedent.

(4) **Descriptive Condition on Subject-Orientation**

A reflexive anaphor may bear phrasal stress in a broad focus context, if its antecedent is not the subject.

(5) **Descriptive Condition on Derived Subjects**

A reflexive anaphor may bear phrasal stress in a broad focus context, if it occurs in a clause with a derived subject (e.g. a passive clause).

These descriptive constraints provide (perhaps surprising) evidence that English reflexive syntax is more like other languages than has been previously noticed. In particular, these constraints on prosodic properties of reflexive anaphors bear striking resemblance to the constraints on the occurrence of Romance *se/si* reflexives that have been noted in the literature many times (e.g. Kayne 1975, Rizzi 1986a, Burzio 1986, Sportiche 2010). Specifically, the type of reflexive anaphors that include English extrametrical reflexives and Romance *se/si* must be locally bound, and are subject oriented – for this reason, we will call them Local Subject-Oriented Reflexives (LSOR).

Of great importance is that these constraints on prosodic behavior are structural, implicating that the observed prosodic patterns arise as a result of of the syntactic structure for reflexive clauses. However, while descriptively true, these descriptive and stipulative statements in (3)–(5) are not the kind we hypothesize to be possible as part of Grammar, in a Minimalist framework, as

they do not operate locally on grammatical primitives. These descriptive conditions will need to derive from the syntax of reflexives, and the way that syntax interacts with phrasal stress assignment.

To that end, this chapter's main goal will be to motivate a model in which the extrametrical reflexive anaphors under consideration undergo syntactic movement to a position at the edge of the verbal domain, VoiceP, when it is headed by a Reflexive Voice head, REFL:

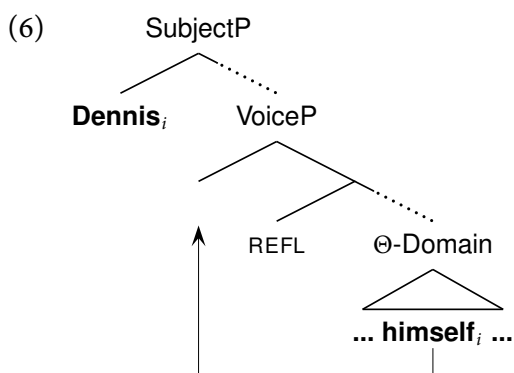

It is in this VoiceP position that the subject-oriented reflexive anaphor is bound by the subject. Moreover, this syntactic derivation feeds phrasal stress assignment in such a way as to derive the variable prosodic behavior of reflexives without stipulation, and without violating Minimalist principles on the interfaces, such as the ones in (2)–(4) of Chapter 2. The result is that English reflexive syntax closely resembles the syntax of reflexives in many other languages, in which movement is more clearly motivated. More broadly, this supports a finding that locally bound reflexive anaphors employ special syntactic structure (even in languages like English that do not appear to at first blush), effecting large-scale implications for theories of reflexivity more generally.

3.1 The Puzzle: Variable Prosodic Behavior of Reflexive Anaphors

The first puzzle we are faced with is that reflexive anaphors are extrametrical, in contexts where other (similar) constituents do bear phrasal stress.

- (7) a. You surprise your readers.
 b. You surprise yourself.

Final Stress
 Extrametrical

That *yourself* does not bear phrasal stress can be seen in the extent to which phrasal accents spread the recording below, which comes from an unscripted interview on NPR's Weekend Edition:^{2,3}

- (8) Every drawing is a kind of journey. There's an organic quality that is quite potent, you know. You surprise yourself, and that's quite nice.

(NPR, Weekend Edition Sunday, 2014/04/27)

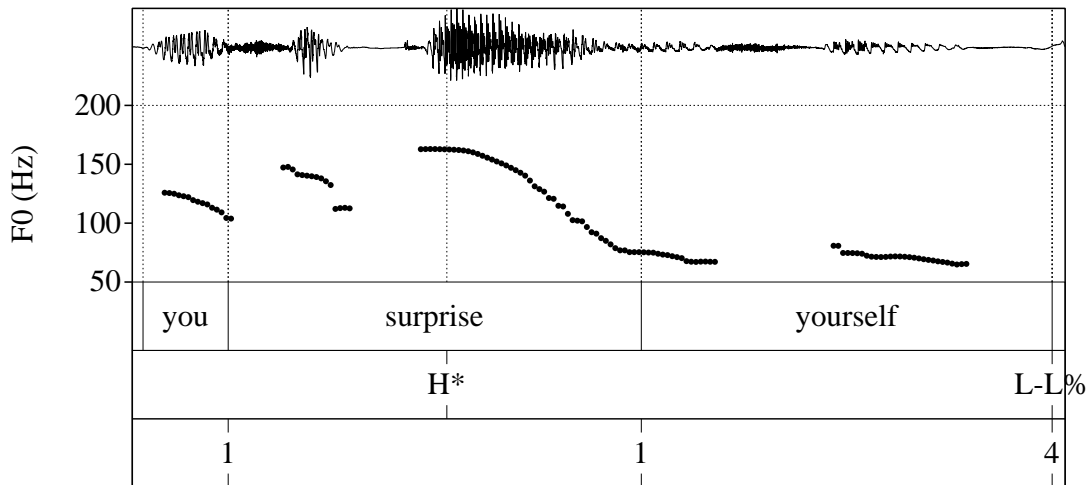

The sentence forms one prosodic phrase (specifically a single intermediate phrase (iP) and coinciding intonational phrase (IP)), *you surprise yourself*, the right edge of which is associated with a L- phrase accent which causes two tonal targets: one at the right edge of the phrasal stress (*surprise*), and one at the right edge of the entire prosodic phrase. (See Chapter 2, Section 2.2.1.) In this case that means there is a low pitch target at the right edge of *yourself* and at the right edge of *surprise*. At the same time, the H* on *surprise* dictates that there should be a high tone target on the syllable *prise*. Because there is no phonological tone target preceding it, the pitch moves steadily from the pitch of *you* up to the high pitch in *prise*. Thus we have correctly predicted the

²All examples from NPR broadcasts were collected through the NPR website, <http://www.npr.org/>, where transcripts are freely searchable and audio files are readily downloadable in MP3 format.

³Recall that Praat's generated pitch tracks like the one in (28) are not always continuous. This is because fundamental frequency is not always measurable: either because there is none to measure (during a voiceless segment), or because sometimes Praat cannot reliably compute the fundamental frequency. Additionally, Praat occasionally plots what it believes to be pitch at the wrong frequency (i.e. there are some errant dots on the pitch tract): this can be due to effects of phonation (e.g., aspiration, creak, and breathiness), background noise, or issues with the recording itself.

thee tone targets overlaid below on the observed pitch track:

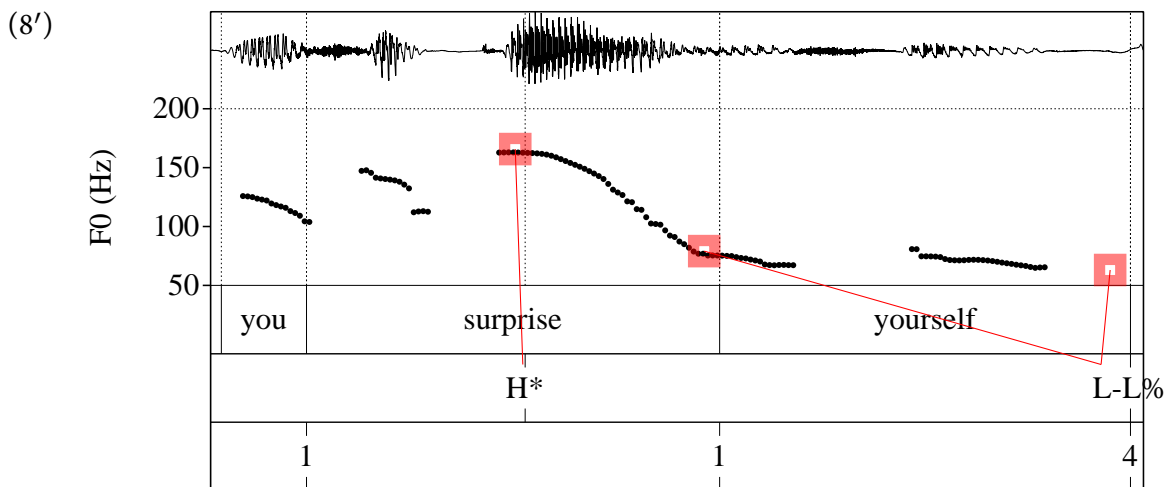

Because the L- is spreads as far left as the right edge of *surprise*, it must be the case that there is no pitch accent on *yourself*. This indicates that *yourself* is not phrasally stressed; if it were, there would necessarily be a pitch accent on *self*, because phrasal stress on a prosodic word entails a pitch accent on that word.⁴

A possible differing analysis might posit that *yourself* does have a low pitch accent (L*) on *your*. There are two problems with this. First, if there were a low pitch accent associated with *yourself*, the target ought to be on the lexically stressed syllable, *self*, and thus the pitch would not reach its lowest point by the end of *surprise*. Second, even we posited that the *your* of *yourself* were associated with a low pitch accent, a different analysis would be required to account for near minimal pair with (8), like (9), in which a high phrase accent (H-) completely covers the anaphor:

- (9) SAGAL: Do you ever surprise yourself when you sit down to write a novel and the next thing you know another bear pops up?
 IRVING: No, I don't surprise myself, because I begin with the ending of books and I know where I'm going.

(NPR, Wait Wait Don't Tell Me, 2014/06/27)

⁴This is a one-way implication. Phrasal stress entails pitch accent, but pitch accent does not entail phrasal stress. Pitch accents are known to distribute much more widely than on just phrasally stressed words. Only nuclear pitch accents (the final pitch accent of a phrase) implicates phrasal stress. See Section 2.2.3. (See also Pierrehumbert 1980, Beckman and Pierrehumbert 1986 and Ladd 1996.) In particular, some reflexive anaphors perceived as non-prominent (indicating lack of stress) do bear a kind of subordinated pitch accent. These pitch accents ought not to arise due to the phrasal stress rule. See footnote 11.

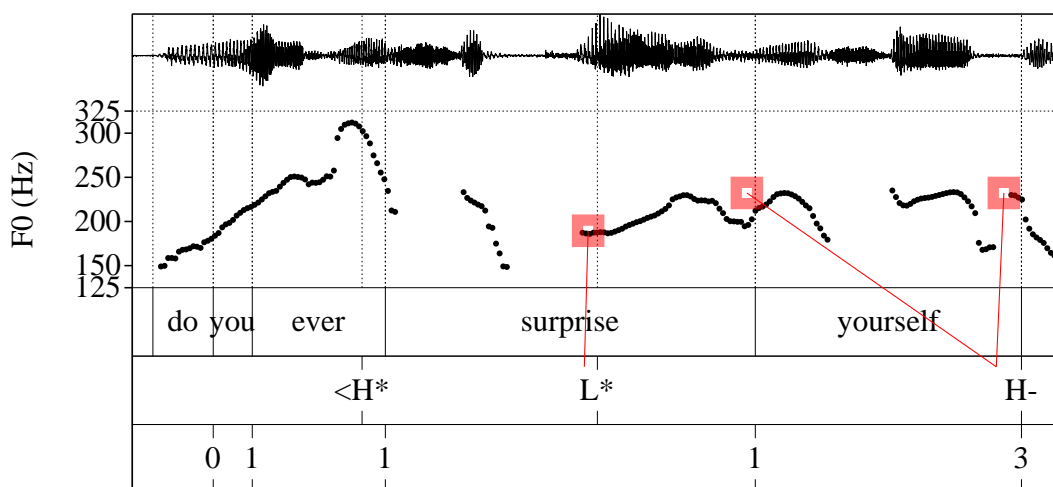

Here the pitch remains high for the entire duration of the anaphor, because there is an H- that creates a high tone target to its left. This is inconsistent with a low pitch accent on *your*, and if a pitch accent were on *your* it would have to be a high pitch accent. Thus two issues face a sufficient alternative analysis in which these anaphors are phrasally stressed and associated with a pitch accent: (i) it is unclear what would determine whether anaphors are associated with low or high pitch accents, and (ii) something would need to explain why these pitch accents are not associated with the syllable with lexical stress.

Instead, the data are straightforwardly accounted for if the anaphors do not have a pitch accent associated with them, and the pitch during reflexive anaphors is due entirely to the effects of the phrase accent. Without a pitch accent, it must be that these reflexive anaphors are not phrasally stressed. (All phrasally stressed words bear a pitch accent.)

The fact that reflexives like the ones above exhibit these prosodic patterns raises a simple question – the primary puzzle with which this chapter is concerned:

(10) **Simple Puzzle**

What allows reflexives to be extrametrical for phrasal stress?

In other words, why are reflexive anaphors not bearing phrasal stress, in linear positions where other elements do bear phrasal stress? This puzzle has typically been taken as a sub-case of some other generalizations on phrasal extrametricality. In particular, past analyses have claimed that

phrasal stress is sensitive to (i) grammatical label, (ii) the functional/lexical distinction, (iii) contextually-determined information structure properties (i.e. what is focused, new, given, etc.), (iv) linear position, and (v) syntactic structure. (Some of the works that have asserted or assumed some number of these include: Chomsky and Halle 1968, Bresnan 1971, Schmerling 1976, Selkirk 1984, Zubizarreta 1998, and Kahnemuyipour 2009.)

Under such approaches, what may be surprising is that reflexives do not always have this property. This has not been seriously addressed in the literature at all, as far as I am aware. Compare (1) with (11):

- | | | | |
|------|----|---|-------------------------|
| (1) | a. | Dennis embarrassed <u>Líz</u> . | <i>Final Stress</i> |
| | b. | Dennis <u>embárrased</u> himself. | <i>Non-final Stress</i> |
| (11) | a. | Dennis embarrassed Jenna and <u>Líz</u> . | <i>Final Stress</i> |
| | b. | Dennis embarrassed Jenna and <u>himsélf</u> . | <i>Final Stress</i> |

We have already briefly described this variable behavior in (3)–(5). Given the lack of a single obvious across-the-board generalization for the prosody of reflexive anaphors, we are led to a more complex puzzle:

(12) **Complex Puzzle**

What accounts for when reflexives are/aren't extrametrical?

Providing an account of this more complex puzzle will play the central role in deciding between possible models of reflexive anaphors' extrametricality. The answer to this complex puzzle depends on what sort of things the phrasal stress rule is sensitive to.

The factors in (i) and (ii) remain constant across (1) and (11), so they will not be given further consideration.⁵ (In addition, these assumptions run afoul of the interface postulates in Chapter 2.) For this reason, we will focus on (iii)–(v) as possibly contributing to the solution for the puzzles in (10) and (12). Ultimately, we will conclude that it must be syntactic structure (as briefly described in and around (6)) that plays the critical role in determining which reflexives are extrametrical.

Before arriving at that conclusion, we will consider a wider range of prosodic data. After that,

⁵See Chapter 2 for arguments that they are not the kind of properties that a well-formed phrasal stress rule could refer to in Minimalist architecture.

we will entertain both information structure and linearization as possibly determining the solutions to these puzzles, and we will conclude that each fails to account for the facts.

3.2 Phrasal Stress and Context

3.2.1 Neutral Phrasal Stress Patterns

As we saw in Section 2.2.4, neutral phrasal stress patterns arise naturally in out-of-the-blue contexts, and can be elicited by maximally broad-focus questions such as *what happened?* (Zubizarreta and Vergnaud 2006). As stated in the most well-known generalizations about phrasal stress in English (e.g. Chomsky and Halle 1968), in the neutral phrasal stress pattern, the stress typically falls on the rightmost word of the phrase.⁶ This descriptive generalization is lacking in several respects (see criticisms in, e.g., Cinque 1993, Zubizarreta 1998), but it will be sufficient for our current needs. Using this coarse-grained generalization, consider the following examples:

- (13) Q: What happened at work today?
A1: The CEO announced a plan ***c**onfidently.* *Final Stress*
A2: #The CEO announced a ***p**lán* confidently.
- (14) Q: What's new?
A1: Jenna tried to attack ***K**énneth.* *Final Stress*
A2: #Jenna tried to ***a**ttáck* Kenneth.

To be clear, these answers in (13) and (14) represent the neutral phrasal stress pattern, because everything in the response is new information for the discourse. It so happens that the neutral stress pattern here (as in many situations) is phrase-final. The placement of stress elsewhere is simply infelicitous in an out-of-the-blue context. That is, (13A2) and (14A2) would require the speaker to “presuppose” some shared context⁷ with the addressee which would render the context

⁶More specifically, phrasal stress is associated with the rightmost word-level stress, which is determined in a different way from phrasal stress. Phrasal stress is entirely a post-lexical property (unlike word-level stress which can be entirely lexical). See, for example, Chomsky and Halle 1968 and Liberman and Prince 1977.

⁷The word *presuppose* here is put in scare quotes because the formal definition of presuppose is inappropriate in some cases. See Büring 2013:875.

as not out-of-the-blue.

In addition, it is not the case that only out-of-the-blue contexts can elicit the neutral stress pattern for a phrase. It also arises if all the material within a certain sub-sentential phrase in question is focused information. For example, consider the slightly modified versions of (13) and (14), in which the questions are not maximally broad-focus:

- (15) Q: What did the CEO do at work today?
A1: The CEO [announced a plan ***có*nfidently**]_F. *Final Stress*
A2: #The CEO [announced a ***plán*** confidently]_F.
- (16) Q: What's new with Jenna?
A1: She [tried to attack ***Ké*nne^h**]_F. *Final Stress*
A2: #She [tried to ***attá*ck** Kenneth]_F.

The responses to these questions have the predicate as focused – indicated by the subscript F.⁸ In these more narrow-focus contexts, the placement of phrasal stress within the F-marked constituent conforms to the neutral stress pattern. This has been noticed for some time, since at least Jackendoff 1972:

“If a phrase P is chosen as the focus of a sentence S, the highest stress in S will be on the syllable of P that is assigned highest stress by the regular stress rules.”

(Jackendoff 1972:237)

This is also seen in examples where the subject is the focused phrase, as in (17):

- (17) Q: Who got fired?
A1: [Everyone who complained ***ló*udly**]_F got fired. *Final Stress*
A2: # [Everyone who ***complá*ined** loudly]_F got fired.
- (18) Q: What got Jeannie upset?
A1: [Nathan cloning ***hó*rses**]_F got Jeannie upset. *Final Stress*
A2: # [Nathan ***cló*ning** horses]_F got Jeannie upset.

Thus, the neutral phrasal stress pattern (something like “final in phrase”) emerges within the relevant phrase, regardless of whether that phrase is focused or new information. (And alternative

⁸I use this notation of F-marking as merely a descriptive device, without committing to the formal status of such features. All that is relevant is that the grammar ends up treating new, focused, and given constituents differently (e.g. Selkirk 2007, Büring 2013).

placements of phrasal stress like (17A2) and (18A2) require some additional shared context between speaker and addressee.)

3.2.2 Discourse Information Effects on Phrasal Stress

As we alluded to in the preceding discussion of neutral phrasal stress patterns, there are of course contexts in which the neutral (phrase-final) pattern regularly does not arise. We will now turn our attention to such cases. Compare the contexts and placements of phrasal stress in (14), (16) and (19):⁹

(19) Q: What's new with Kenneth?

A1: #Jenna tried to attack ***Kénneth***_G.

A2: Jenna tried to ***attáck*** Kenneth_G.

Non-final Stress

In a context where *Kenneth* is already in the discourse context because of the question, *Kenneth* is given information. Since *Kenneth* is given (but *attack* isn't), phrasal stress must not fall on *Kenneth* in the answer; it will instead fall on *attáck* – just the opposite pattern of (14) and (16). This is a rather robust judgment when givenness is as clear as it is in (19), indicating that givenness (and discourse information in general) has an effect on phrasal stress placement.

Additionally, this stress pattern can even emerge in response to the question *What's new?*. For example, if Kenneth is salient enough that the speaker believes mentioning him to the interlocutor(s) to be expected (e.g. every day something new happens with Kenneth), the phrasal stress pattern of (19A2) is felicitous. Similar effects can be observed in the example below:

(20) *Modified from Schwarzschild 1999:*

Q: Did they hire John?

A1: (Shared implicit context: *John is not a New Yorker.*)

No. Because they wanted ***a New Yórker***.

Final Stress

A2: (Shared implicit context: *John is a New Yorker.*)

Yes. Because they ***wánted*** [a New Yorker]_G.

Non-final Stress

⁹As with F-marking, I use G-marking notation as a purely descriptive notation, without committing to the formal status of such features. All that matters is that the grammar ends up treating new, focused, and given constituents differently (e.g. Selkirk 2007, Büring 2013).

Data like this reveals that even implicit discourse information may affect phrasal stress placement.

However, in scenarios where the discourse context makes everything in the answer given, the neutral phrasal stress pattern emerges again, as noted by Schwarzschild (1999) and Wagner (2006).¹⁰

- (21) Q: So, is it true that Jenna tried to attack Kenneth?
A1: Yes. [Jenna tried to attack Kénneth.]_G *Final Stress*
A2: #Yes. [Jenna tried to attáck Kenneth.]_G
- (22) *Modified from Wagner 2006:*
Q: Last week the newspaper reported that after the game all that happened was that the coach praised John. I wonder what happened after this week's game.
A1: (Once again,) [The coach praised Jóhn.]_G *Final Stress*
A2: # (Once again,) [The coach práised John.]_G

Even though *Kenneth* is given, and because *Kenneth* occurs in a sentence in which everything is given, it bears the phrasal stress in (21). Discourse givenness does not directly entail lack of phrasal stress. Thus discourse information has a more complex relationship with phrasal stress assignment. (This will be returned to in depth in Section 3.4.)

Since discourse information can influence phrasal stress placement, grammaticality judgments in these examples with phrasal stress require careful consideration of context; and as a result they can be rather fragile, as Zubizarreta and Vergnaud (2006) point out:

“...it is very hard to control for context. Strictly speaking, there is no context-neutral sentence because speakers tend (un)consciously to add background information. In other words, speakers tend to provide a context for isolated sentences because this is the way that they are naturally used...” (Zubizarreta and Vergnaud 2006:523)

Of course, we will want to understand how the model accounts for these complex interactions between discourse context and phrasal stress patterns. For now, however, it will suffice to recognize

¹⁰However, if there is a salient alternative made prominent by using a non-neutral pattern, a non-neutral pattern can be felicitously used in contexts where everything is given. See Wagner 2006 for details.

that discourse context may affect phrasal stress placement.

3.3 Anaphors and Phrasal Stress

Let us return to some sentences which occur as the answer to maximally broad-focus questions. Given the discussion in the previous section, we should expect to find the neutral stress pattern in these cases.

- (23) Q: What happened in the kitchen?
A1: Remy accidentally burned Marie. *Final Stress*
A2: # Remy accidentally búrned Marie.
- (24) Q: What happened in the kitchen?
A1: # Remy accidentally burned himsélf.
A2: Remy accidentally búrned himself. *Non-final Stress*
- (25) Q: What was all the commotion in the office?
A1: Jack was loudly encouraging Dón. *Final Stress*
A2: # Jack was loudly encóuraging Don.
- (26) Q: What was all the commotion in the office?
A1: # Jack was loudly encouraging himsélf.
A2: Jack was loudly encóuraging himself. *Non-final Stress*

In (23) and (25), the neutral stress placement is for stress to fall on the rightmost word (*Marie* and *Don*, respectively). However, in (24) and (26), it must not fall on the rightmost word (*himself*). In other words, though these nominal expressions all appear in the same linear position (sentence-finally), the neutral stress pattern is crucially different between the reflexive and non-reflexive examples. These judgments are very strong, and (24A1) and (26A1) are only felicitous in highly specified contexts – for example, (24A1) could be felicitous in a scenario in which it is given information that Remy accidentally burned someone or something. (This is consistent with what was discussed in the previous section, on the interaction between discourse information and phrasal stress.)

Similar data in which the reflexive anaphor does not bear phrasal stress where other nominals do can be found in variety of sentences, as shown in the following section. However, the facts do

not support a generalization as simple as “anaphors never bear phrasal stress”; anaphors exhibit variable behavior on whether they bear phrasal stress. This is demonstrated with data in Section 3.3.2.

Moreover, though reflexive anaphors resemble pronouns in being sometimes prosodically weak and sometimes prosodically strong, I show in Section 3.3.3 that prosodically strength in pronouns has a different distribution than prosodically strength in reflexive anaphors.

3.3.1 More Examples of the Extrametrical Anaphors

To demonstrate the robustness of this phenomenon, this section reviews some additional data in which reflexive anaphors are extrametrical.

(27) Transitive Clause

Q: Why were there some screams during the competition?

A1: Several people injured their *pártners*.

Baseline

A2: #Several people *injured* their partners.

A3: #Several people injured *themsélves*.

A4: Several people *injured* themselves.

Reflexive

Below is a naturally occurring example of this pattern, from an unscripted radio interview:

(28) It looks like anybody could come in here and just put their kayak or canoe in and start doing it. What do you do to make sure that you don't get people who could injure themselves doing it?

(NPR, Morning Edition, 2005/06/14)

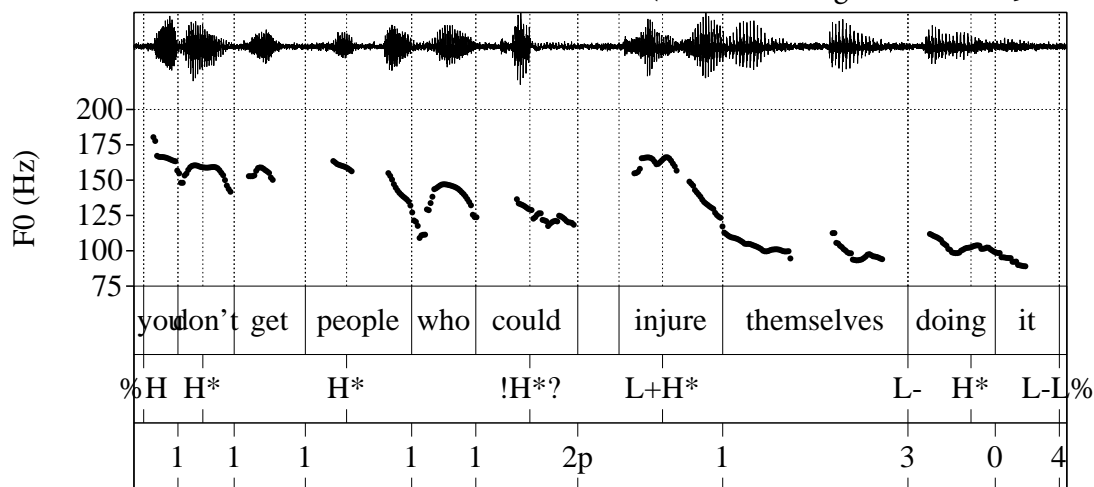

In this example, the low plateau of the pitch during the production of *themselves* is a result of the low cover tone (L-) associated with the prosodic phrase boundary to its right, causing low tonal targets on the right edges of *injure* and *themselves*. Since there is no pitch accent associated with *themselves*, it would be impossible for *themselves* to have any kind of phrasal stress (because all phrasally stressed words have a pitch accent).¹¹

In addition, so-called inherent reflexive verbs (i.e. verbs whose interpretation is only possible when its object is a reflexive; Levin 1993:§8.2) exhibit the same prosodic behavior:

(29) Inherently Reflexive Verb

Q: How did daycare go today?

A1: Terry and Janet behaved *nicely*. Baseline

A2: #Terry and Janet *beháved* nicely.

A3: #Terry and Janet behaved *themsélves*.

A4: Terry and Janet *beháved* themselves. Reflexive

The two examples above exhibit the extrametricality of reflexive anaphors in declarative clauses. Reflexives may be extrametrical in any type of clause, including interrogatives (one example already seen in (9), repeated below as (31)) and imperatives. This is exemplified below:

(30) Interrogative Clause

Q1: Do you ever surprise your *readers*? Baseline

Q2: #Do you ever *surprise* your readers?

Q3: #Do you ever surprise *yoursélf*?

Q4: Do you ever *surprise* yourself? Reflexive

(31) SAGAL: Do you ever surprise yourself when you sit down to write a novel and the next thing you know another bear pops up?

IRVING: No, I don't surprise myself, because I begin with the ending of books and I know where I'm going.

(NPR, Wait Wait Don't Tell Me, 2014/06/27)

¹¹That said, there are plenty of cases where it looks like the predicate has strong evidence of being stressed and the reflexive shows optional, subordinate properties of stress. This is the opposite of the normal situation in non-reflexive VPs, where the object has strong, obligatory stress and the verb has optional, subordinate stress. This might have to do with the fact that there are likely two sources of phrasal stress: one from syntactic input, which dictates obligatory stress locations, and one from phonological input, which is subject to more variation and phonological principles. Specifically, the strong obligatory stresses (verb in reflexive VPs, object in non-reflexive VPs) come from the syntactic input, and the weaker, optional stresses (the object in reflexive VPs, the verb in non-reflexive VPs) come from the phonological input. See Section 2.2.3 in Chapter 2, as well as footnote 4 in this chapter.

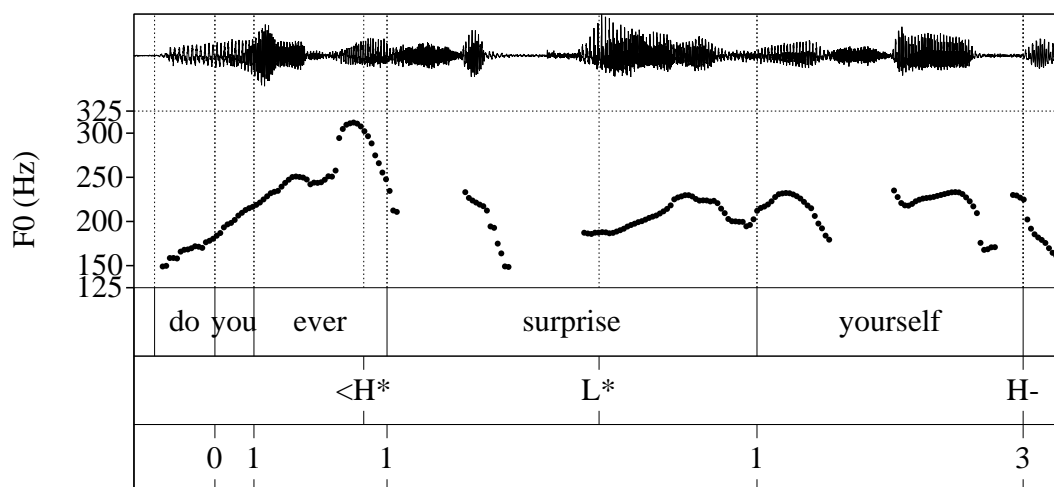

(32) Interrogative Clause

Q1: How does this guy identify his *ethnicity*?

Baseline

Q2: # How does this guy *identify* his ethnicity?

Q3: # How does this guy identify *himself*?

Q4: How does this guy *identify* himself?

Reflexive

(33) Okay. So once he gets asked a second time, how does this guy of Japanese/Eastern European Jewish descent identify himself?

(NPR, Morning Edition, 2013/11/11)

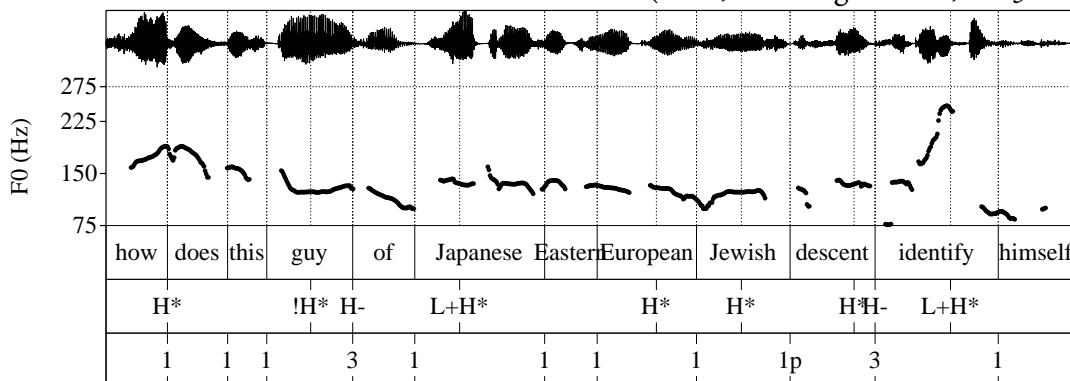

(34) Imperative Clause

Q: What's the first step for making a better society?

A1: Educate *children*.

Baseline

A2: # *Éducate* children.

A3: # Educate *yourselves*.

A4: *Éducate* yourselves.

Reflexive

(35) Chevront says he's learned some lessons which would apply to legislators fashioning a national public option. The first seems obvious, educate yourself.

(NPR, All Things Considered, 2009/09/18)

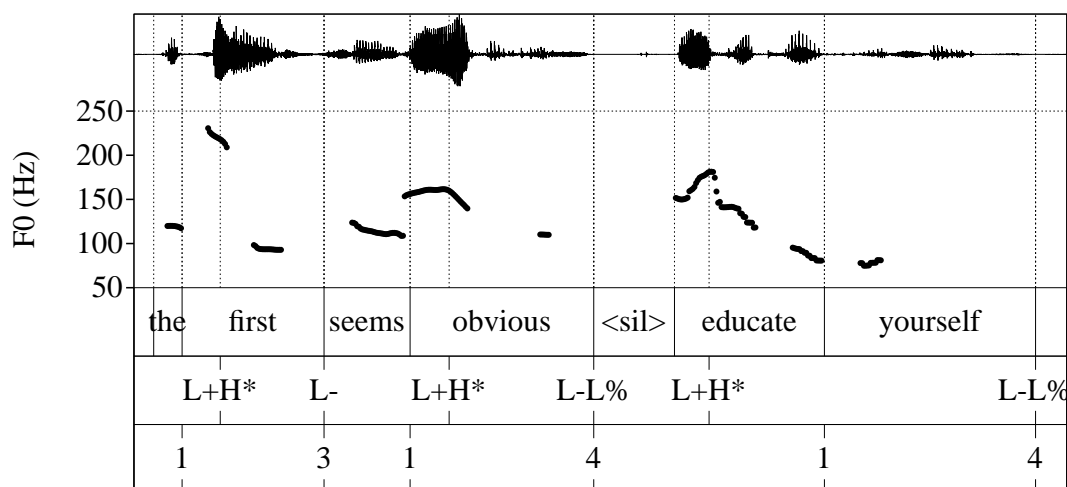

In addition, reflexives are not just extrametrical in tensed clauses, but also in various types of nominalized clauses, including ACC-*ing* clauses:

(36) ACC-*ing* Nominalization

Q: What's the oldest rule in politics?

A1: Don't get in the way of someone destroying their *carrière*.

Baseline

A2: # Don't get in the way of someone *destróying* their career.

A3: # Don't get in the way of someone destroying *themsélves*.

A4: Don't get in the way of someone *destróying* themselves.

Reflexive

(37) MCCAMMON: Gross says Romney may do just fine in Iowa despite the low profile, given that his opponents are, as he puts it, self-immolating.

GROSS: I mean, so far what he's doing - at least to his mind - has got to appear to be working. The oldest rule in politics is don't get in the way of someone destroying themselves.

(NPR, All Things Considered, 2011/11/14)

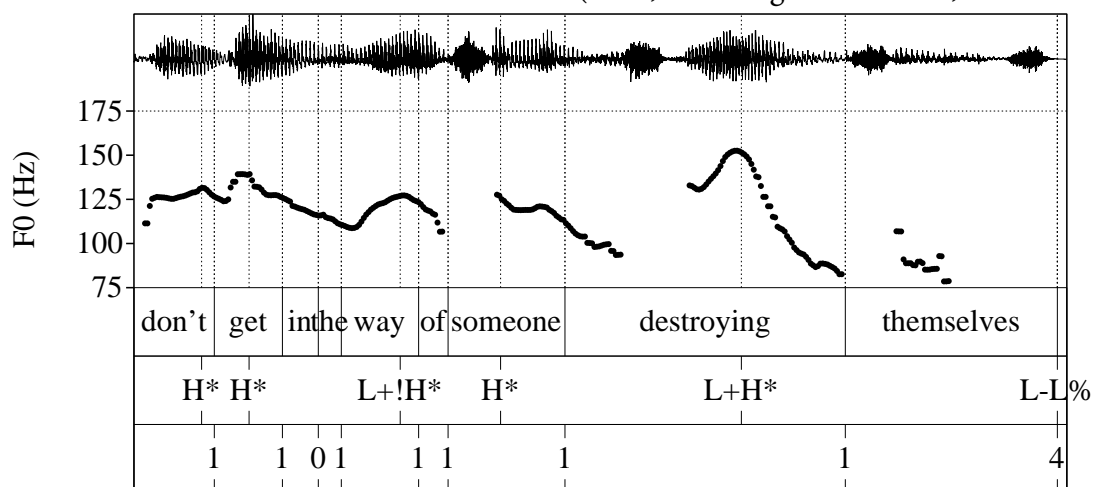

A more complex example of extrametricality can be seen with particle verbs. In particle verbs like *turn off*, a nominal object typically bears phrasal stress, even though the particle is in final position (e.g. Cinque 1993:fn.31):

(38) Particle Verb

Q: What will happen if the sensors stop working?

A1: The car will turn the áuto-pilot off. Baseline

A2: #The car will turn the auto-pilot óff.

A3: #The car will turn itsélf off.

A4: The car will turn itself óff. Reflexive

(39) Ford says that if you have an inch of - or an inch or to three inches thick of ice on the sensor, that it can mess up and it will start giving errors. And they actually wrote code to warn the driver, hey, this system is not going to work very well right now. The driving conditions are not good for it, and it will turn itself off.

(NPR, Talk of the Nation, 2010/10/11)

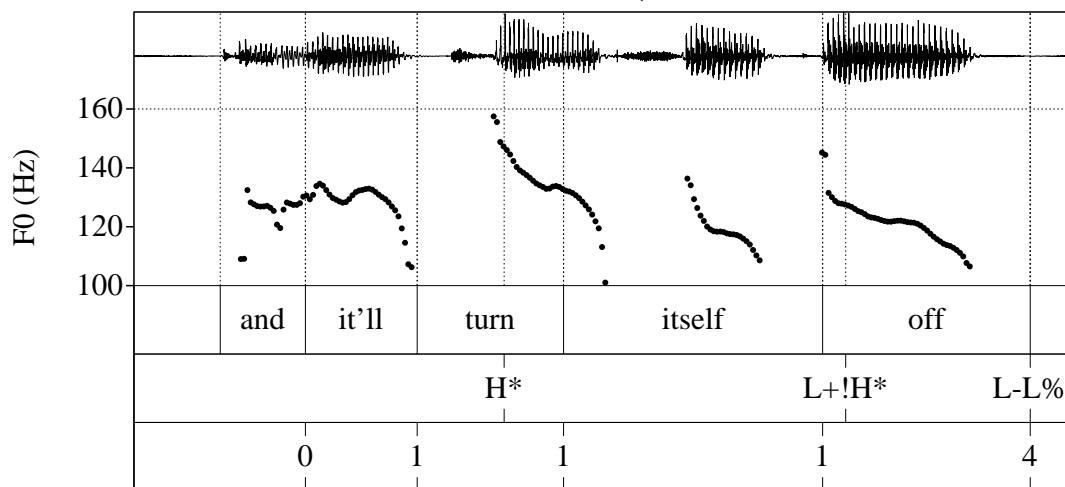

In this example, the pitch of the anaphor *itself* is not determined by a phrasal accent's cover tone, but rather it is determined by interpolation. That is to say, the pitch is moving steadily through *itself* from the high of *turn*'s H* to the low of *off*'s L+H*; if *itself* were phrasally stressed, *itself* would be associated with a pitch accent that would prevent this steady interpolation between surrounding pitch targets. To give additional evidence that the phrasal stress falls on *off* and not *itself*, consider the fact that the amplitude during *off* is significantly higher than during *itself*.

The extrametricality of these reflexives is not limited to nominal complements of verbs. The same extrametricality is observed when the reflexive is a complement of a preposition. This can

be seen in (40), where the verb is prepositional object:

(40) PP selected by a verb

Q: What was all the commotion in the other room?

A1: Jack was loudly yelling at Dón.

Baseline

A2: # Jack was loudly yélling at Don.

A3: # Jack was loudly yelling at himsélf.

A4: Jack was loudly yélling at himself.

Reflexive

Additionally, it is apparent that something prevents prepositions like *at* in (40) from bearing stress. What that is is not clear, and is outside the scope of this discussion of reflexive extrametricality.¹²

In the same way, it is not just PPs introduced by verbs in which the reflexive is extrametrical. Reflexives introduced as complements of P in an adjectival phrase may also be extrametrical:

(41) PP selected by an adjective

Q: Why is it so tense in here?

A1: Paul is angry at Jénna.

Baseline

A2: # Paul is ángry at Jenna.

A3: # Paul is angry at himsélf.

A4: Paul is ángry at himself.

Reflexive

The cases above are all with broad-focus contexts. However, recall from Section 3.2.2 that within focused constituents, the location of the focus stress within the constituent is determined by the same set of rules as in phrasal stress.¹³

(42) a. Contrast [people's mórals]_F and [their actual behávior]_F.

Baseline

b. # Contrast [péople's moral]s]_F and [their actual behávior]_F.

c. # Contrast [what people say about themsélves]_F and [their actual behávior]_F.

d. Contrast [what people sáy about themselves]_F and [their actual behávior]_F. *Reflexive*

¹²Common analyses are that grammatical category is what matters (and Ps like *at* do not bear stress; e.g., Zubizarreta 1998) or that words like *at* lack any lexical stress specification which renders them ineligible as phrasal stress bearers. However, see Ahn *in prep.* (following logic in Sportiche 2005 and Chapter 5 of Kayne 2005) for an alternative analysis, which will adhere to an exceptionless, syntactically-based phrasal stress rule advocated here.

¹³As the bracketing indicates in (42), the meaning is one in which what should be contrasted is *their actual behavior* and *what people say about themselves* – not *themselves* and *their actual behavior*. In (43), the context makes this bracketing/interpretation entirely clear.

- (43) And the research comes to us via Phillip Brenner. He's a sociologist at the University of Massachusetts in Boston. He's conducted several studies that explore this contrast between what people say about themselves and their actual behavior.

(NPR, Morning Edition, 2014/04/10)

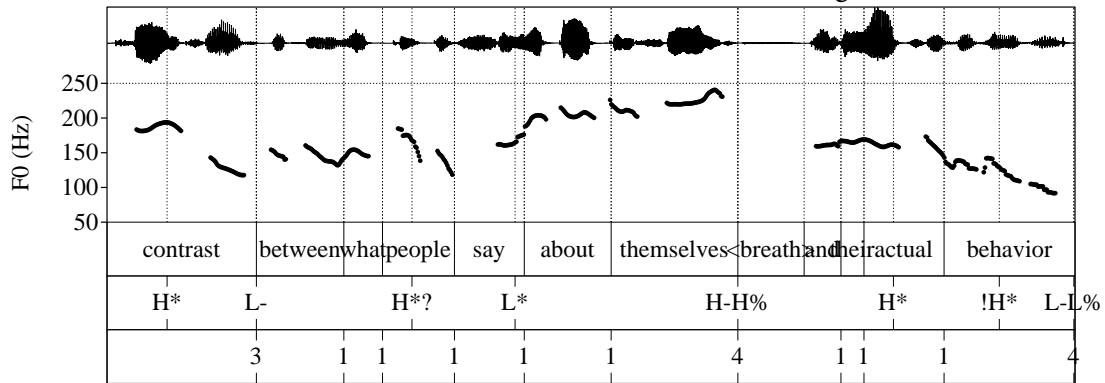

In this case, there is semantic focus on *what people say about themselves*, but the focus pitch accent for that constituent falls on *say* (and not the rightmost word, *themselves*).¹⁴

Similarly, the two conjuncts in (44) (*be proud of myself* and *not sneak*) are not contrasted with each other, but they are both under semantic focus – they are each under identificational focus. The phrasal stress of the first conjunct falls on the verb, and not on the anaphor:¹⁵

- (44) And out of all the things a father in 1959 could've told his gay son, my father tells me to be proud of myself and not sneak.

(NPR, Morning Edition, 2014/06/27)

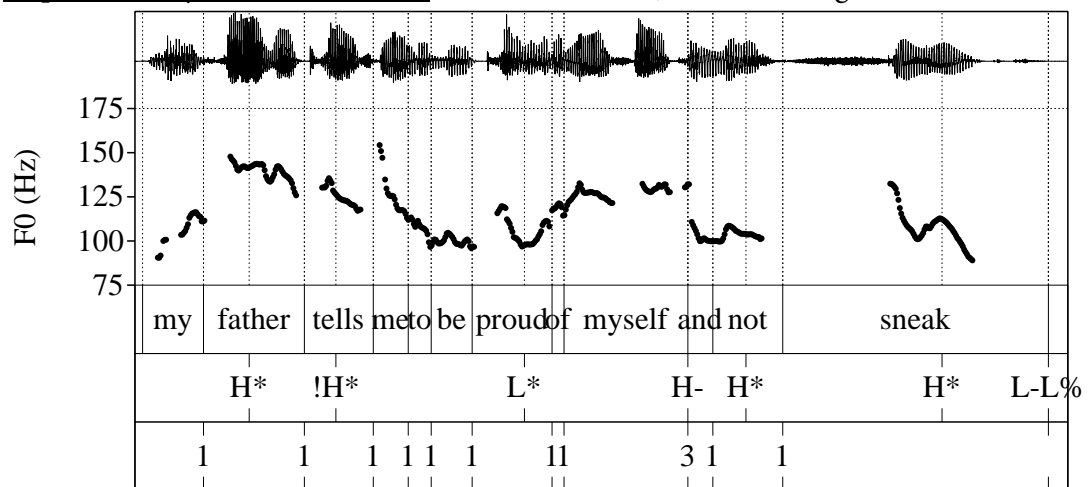

¹⁴The reflexive anaphor is covered by the H- phrase tone in (43), because the grammar calls for an H- in this context.

¹⁵The prosodic model assumed here predicts the H- to spread to the left of *of*; however, the pitch is clearly rising during *of*. One possibility is that the pitch is rising during *of* because the speaker simply did not have enough time to travel all the way from the low of the L* to the high of the H- within the same syllable (*proud*). See Barnes et al. 2010 for a more detailed discussion on the variable degree to which phrase accents spread leftward.

This wide range of data demonstrates that reflexive extrametricality is a robust phenomenon that arises in a variety of grammatical contexts. Indeed, there are even more contexts where this extrametricality can be found, and we will return to them – and their theoretical implications – after we have established a clear theory of this reflexive extrametricality.

3.3.2 Not All Anaphors Are Extrametrical

In addition to, and despite, the pervasive nature of reflexive anaphors' extrametricality, there are several neutral contexts in which reflexive anaphors do bear phrasal stress. For example, when the reflexive anaphor is in an island excluding its antecedent, it bears phrasal stress. In (45c-d), the reflexive anaphor is in an island excluding its antecedent, it bears phrasal stress. In (45c-d), the reflexive anaphor is in an complex NP island.

- (45) Q: What is the setup for the show?
 A1: Louis plays a character like his ***bróther***. *Final Stress*
 A2: # Louis plays a character ***like*** his brother.
 A3: Louis plays a character like ***himsélf***.
 A4: # Louis plays a character ***like*** himself. *#Extrametrical*

The fact that anaphors bear stress in this position is attested in (46), in which the entire utterance is new information:

- (46) The setup is that Louis, who plays a character very much like himself - a not necessarily movie star handsome comedian who does stand up in clubs - finally agrees to go on a date with a funny, charming waitress who's been asking him out for a while.
 (NPR, Tell Me More, 2014/05/21)

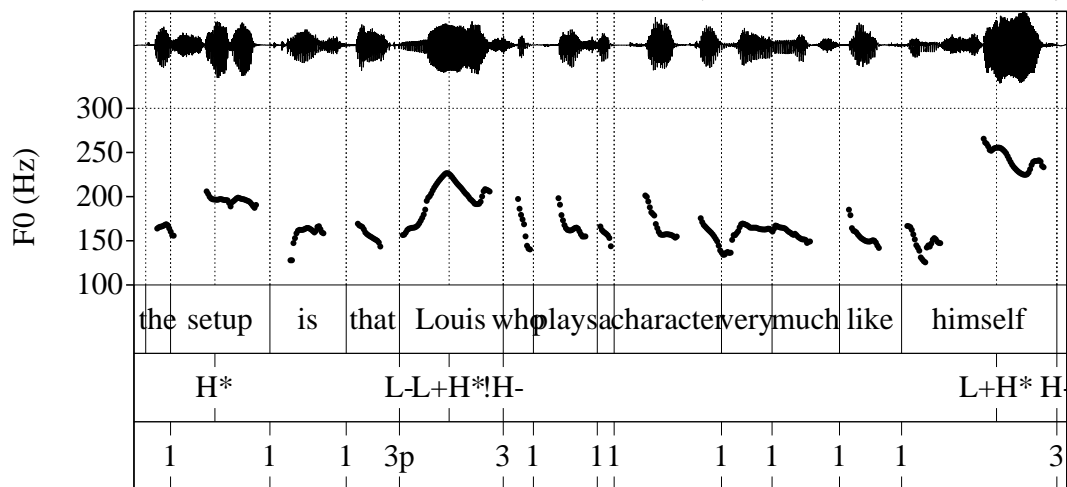

The islandhood of *a character like himself* can be demonstrated by the ill-formed (47):

(47) *Who does he play a character like ___?

As there is nothing being treated as focused or given in the utterance in (46), all the pitch accents are realizations of the default phrasal stress location. In this case, that position is the reflexive anaphor. Similarly, when an anaphor is in a coordinate structure island, it also base phrasal stress:

(48) NEARY: The idea that memoirs shouldn't be too closely scrutinized is just wrong, says Karr.

Ms. KARR: The writer scrutinizes the book and asks herself or himself, 'Is this true?'

(NPR, Morning Edition, 2006/01/13)

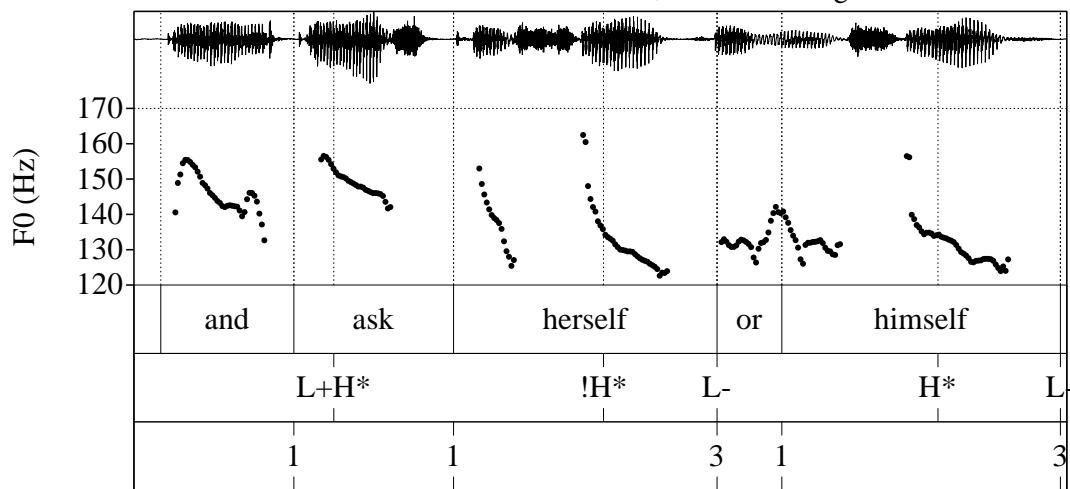

In this example, there are neutral phrasal stress pitch accents on both reflexive conjuncts. This was stated earlier in (3), repeated here:

(3) **Descriptive Condition on Islands**

A reflexive anaphor may bear phrasal stress in a broad focus context, if it occurs in an island that excludes (any copy of) its antecedent.

In addition to contexts where the anaphor is separated from its antecedent by an island boundary, reflexive anaphors also bear phrasal stress when they have non-subjects as antecedents. This is exemplified below.

(49) Q: What did the colonials do to the existing peoples?

A1: They turned them against their bróthers.

Final Stress

A2: #They turned them agáinst their brothers.

A3: They turned them against themséives.

A4: #[?]They turned them agáinst themselves.

#[?]Extrametrical

This pattern is attested in the naturally occurring example below:

(50) ...it's actually brother against brother - divide and rule which is the golden law of colonialism - English, anyway - is how they conquered all of their opponents, turned them against themselves and let them battle it out, and then they'll just pick up and sweep up the mess.

(NPR, Weekend Edition Sunday, 2007/09/09)

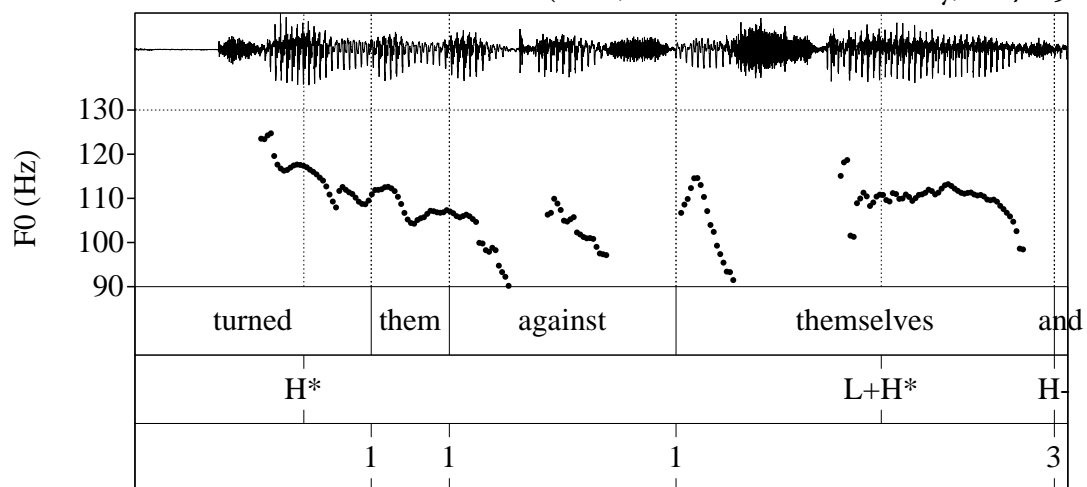

It is also not the case that this is because complements of *against* always must bear phrasal stress. In the example below, where the grammatical context for *them* is very similar to the context for *themselves* in (50), the weak pronoun *them* differs from *themselves* in that only the former bears phrasal stress:

(51) They blame Western nations and Egypt's secular political elite for demonizing them, for turning Egyptians against them and for allying with state institutions to force Morsi's ouster.

(NPR, All Things Considered, 2013/07/30)

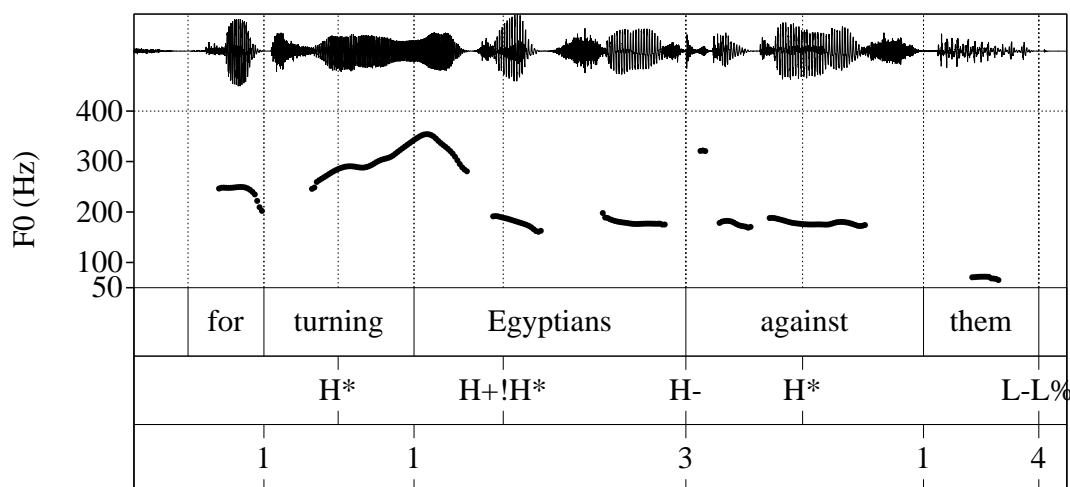

(Further differences between reflexive anaphors and weak pronouns will be discussed in the next section.) This data suggests what was presented at the beginning of the chapter in (4):

(4) **Descriptive Condition on Subject-Orientation**

A reflexive anaphor may bear phrasal stress in a broad focus context, if its antecedent is not the subject.

Thirdly and finally, it is not sufficient to say that anaphors bound by the subject are extrametrical; when occurring in a passive clause, an anaphor bears phrasal stress, even when bound by the subject:

(52) Q: What does a^2 mean?

A1: That means 'a' is multiplied by 'a'.

Final Stress

A2: #That means 'a' is múltiplied by 'a'.

A3: That means 'a' is multiplied by itself.

A4: #That means 'a' is múltiplied by itself.

#Extrametrical

An attested example of this pattern is given below:

(53) We define an exponent as 'a' to the 'n'. That means 'a' is multiplied by itself 'n' times.

(*Changing Negative Exponents to Fractions*, Education Portal. <http://goo.gl/r0vqto>)

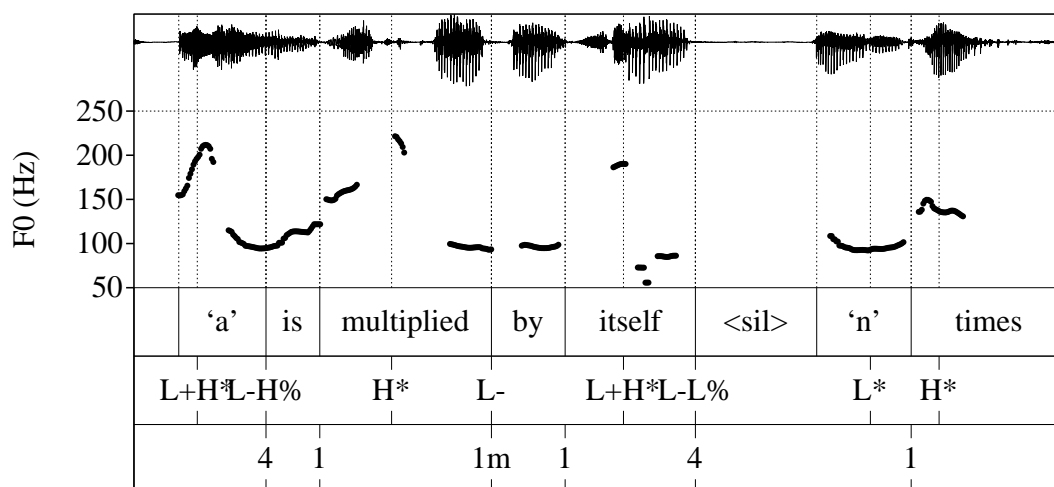

(Here, *itself* bears phrasal stress in its domain, and there is an additional phrasal stress for the constituent '*n*' times.) The generalization that captures this pattern is as in (5):

(5) **Descriptive Condition on Derived Subjects**

A reflexive anaphor may bear phrasal stress in a broad focus context, if it occurs in a clause with a derived subject (e.g. a passive clause).

(We will return to a clearer definition of 'derived subject' in Section 3.6.3.)

With the data in this section, it can thus be concluded that some reflexive anaphors are not extrametrical: they can attract phrasal stress in the same way as other constituents. More importantly for an analysis, the anaphors that are not extrametrical fall into natural classes, defined by syntactic context.

3.3.3 Extrametrical Anaphors Are Not Extrametrical Pronouns

Though 'weak' (non-deictic) pronouns tend to exhibit the a similar apparent extrametricality for the phrasal stress rule, there are difference between extrametrical anaphors and extrametrical weak pronouns. There are at least three ways in which the prosodic properties of pronouns differ from anaphors, which indicate that they are derived distinctly, despite their surface similarities in prosodic prominence.

First and foremost, though pronouns are often not extrametrical when in islands, there are

attested cases where they are.¹⁶ Compare (54A1-A2) with (54A3-A4):

- (54) Q: What did they say in the letter?
A1: They will invite Mary and me. *Final Stress*
A2: They will invite Mary and me. *Extrametrical*
A3: They will invite Mary and myself. *Final Stress*
A4: # They will invite Mary and myself. *#Extrametrical*

Similar effects are observed in other islands, such as the (reduced) relative clause island below:

- (55) Q: Tell me something you learned in your research.
A1: ?? Some social outcasts_i seek out others like them_i. *??Final Stress*
A2: Some social outcasts_i seek out others like them_i. *Extrametrical*
A3: Some social outcasts seek out others like themselves. *Final Stress*
A4: # Some social outcasts seek out others like themselves. *#Extrametrical*

Some pronouns can be extrametrical in islands (54A1-A2), and other seem to need to be (55A1-A2).

On the other hand, reflexives in these same contexts must never be extrametrical. In particular, this means that islands are always relevant for extrametricality in the case of reflexive anaphors; but this is not so for extrametricality in the case of pronouns. (Perhaps interestingly, the degraded judgment for (55A1) seems strongly tied to the interpretation where *some social outcasts* and *them* are coindexed. That is, when *them* is coindexed with *some social outcasts*, the preference is for extrametricality – unlike *themselves*, which must be coindexed with *some social outcasts* and must not be extrametrical.)

For a second source of evidence, let us now consider some prosodic properties of double object constructions. Neither extrametrical reflexives nor extrametrical pronouns can occur as the direct object of a double object verb.

- (56) (*Background Knowledge: Kevin has a picture of himself.*)
Q: What is Kevin going to do with that picture?
A1: * He will show Cónstance himself. **Extrametrical*
A2: * He will show Cónstance it. **Extrametrical*

Unlike pronouns, however, reflexives can occur in this context, if they bear phrasal stress:

¹⁶Wagner treats pronouns as extrametrical due to givenness movement (cf. §3.4.2), thus predicting that pronouns should not be extrametrical in islands from which they cannot escape. At the same time, he himself notes that some pronouns in islands are extrametrical.

(57) (*Background Knowledge: Kevin has a picture of himself.*)

Q: What is Kevin going to do with that picture?

A1: He will show Constance ***himsélf***.

Final Stress

A2: *He will show Constance ***ít***.

**Final Stress*

Similar data can be found in contexts with other double object verbs as well, such as *promise*. (The contexts below are adopted from Elfner 2014.)

(58) (*Background Knowledge: Sarah, the head of the department, is responsible for providing professors with researchers to assist them.*)

Q: What happened regarding all the assistants in yesterday's meeting?

A1: *Sarah promised ***Jóhn*** them (=all the assistants).

**Extrametrical*

A2: *Sarah promised John ***thém*** (=all the assistants).

**Final Stress*

(59) (*Background Knowledge: Sara, the head of the department, is responsible for providing professors with researchers to assist them.*)

Q: What happened regarding assistants in yesterday's meeting?

A1: *Sarah promised ***Jóhn*** herself.

**Extrametrical*

A2: Sarah promised John ***hersélf***.

Final Stress

In these double object contexts, pronouns like *it* and *them* are simply ungrammatical as the direct object – extrametrical or not. At the same time, reflexive anaphors like *himself* and *herself* can occur as the object in a double object construction, but only if they are not extrametrical.

Lastly, and also in the domain of double object constructions, reflexives can be extrametrical in scenarios where pronouns cannot be. Recall that we have seen that discourse givenness (marked here with subscript G) influences phrasal stress placement.

(60) Q: Who did you show yourself to?

A: I_G showed_G ***JÓHN*** myself_G.

Non-final Stress

(61) Q: Who did you show it to?

A: *I_G showed_G ***JÓHN*** it_G.

The reflexive anaphor *myself* is able to occur as a direct object that is extrametrical due to givenness in (60), but the pronoun *it* cannot.

To summarize, we have seen each of the following scenarios: pronouns can be extrametrical where reflexive anaphors cannot, reflexive anaphors can occur (with stress) where pronouns can never occur, and reflexive anaphors can occur (without stress) where pronouns can never occur.

At this point, we do not have an explanation for these differences. (But see Section 3.7.3 for more on double object constructions.) What is important is that phrasal stress distributes differently with reflexive anaphors and pronouns. As such, whatever model we propose for reflexive anaphors need not have direct applications to pronouns.

3.4 Are Reflexive Anaphors Given?

Thus far, we have seen that, there is something about reflexive anaphors that interacts with phrasal stress placement such that they are sometimes extrametrical. We have also seen that discourse information interacts with phrasal stress placement, such that discourse-given material is typically extrametrical as well. In other words, the normal stress patterns are not typically found when a given or anaphoric element appears to be in the position where phrasal stress is normally assigned.

That these certain constituents behave this way has been noticed for quite some time, since at least Bresnan 1971, and Zubizarreta specifically mentions these two types.

“...defocalized and anaphoric constituents (as well as functional categories) are metrically invisible with respect to the [phrasal stress assignment rule]...”

(Zubizarreta 1998:20)

That these two pattern similarly suggests that we ought to attempt to reduce the problem to the same source. One possible and simple analysis could be expressed as (62):

(62) Reductionist Hypothesis:

Anaphors are extrametrical as a result of being discourse-given.

That is, (62) is to be read such that it indicates that, when reflexive anaphors do not bear phrasal stress, it is a sub-case of given material not bearing phrasal stress. Such an approach makes good intuitive sense, and commonalities ought to be sought to the maximum extent that the data allows.

For this reason, we need to understand how given material comes to avoid phrasal stress. We will consider two models: first that there are inherent givenness features which the phrasal stress rule is sensitive to, and second that givenness requires movement, and this movement can feed

the phrasal stress rule.

Our explorations of each will show that the distribution of phrasal stress and anaphors does not fall out from either of these analyses. (But it may be that non-reflexive pronouns' prosodic behaviors do relate to givenness.) The movement analysis of given material matches the prosodic behavior of reflexives better than the inherent feature approach, and will lead us to pursue the idea that shared properties between the two arise from structural similarities between the two.

3.4.1 Constraints on Givenness and Stress Avoidance

Let us start with a clearer definition of givenness. Büring characterizes givenness as below:

- (63) Givenness (Büring 2013:875)
An expression E is given in a context C if there is a synonym or hyponym A to E such that the meaning of A is salient in C.

Many have represented givenness as being formally represented through being marked with a feature in the syntax – G-marking (e.g. Féry and Samek-Lodovici 2006, Selkirk 2007, Büring 2013). Under these approaches, G-marking is supplemented by an additional process of F-marking, which marks focused constituents (including “informational focus”, i.e. new information) as such in the syntax.¹⁷ On the other hand, Schwarzschild (1999) argues that givenness is only formally represented in the grammar by the absence of F-marking. For our purposes, the difference between the two is not critical.

The mapping of phrasal stress is assumed to be constrained by some statement in the grammar, such as (64):

- (64) Givenness Constraint on Phrasal Stress Placement (Büring 2013)
A [G]-marked element does not contain the nuclear stress (unless it is [F]-marked).

A position like this one has roots in a long tradition in the literature (Bresnan 1971, Selkirk 1996a, Zubizarreta 1998, Schwarzschild 1999, Féry and Samek-Lodovici 2006, Selkirk 2007, among many

¹⁷In recent approaches, F-marking is used only for contrastive focus, and not for “informational focus” – i.e. new information. See Selkirk 2007 for specific arguments against F-marking being used in this way, as used in Gussenhoven 1983, Selkirk 1984, 1996b, Schwarzschild 1999, among others.

others).

Thus, whenever the neutral phrasal stress pattern emerges, it necessitates that nothing (or everything) in the answer is given. Schwarzschild argues a stronger position: “Lack of prominence indicates givenness” (1999:142). This implicates that the only given material disrupts neutral phrasal stress patterns.¹⁸

- (65) Q: What was that noise?
A1: Remy burned Marie.
A2: Marie’s mom said Remy búrned [Marie]_G.
A3: Remy búrned himself.

If we assume that a reflexive anaphor is a synonym or hypernym of its antecedent, then, by this definition, reflexive anaphors would always be given elements.^{19,20} In fact, Schwarzschild’s statement that “[l]ack of prominence indicates givenness” even more strongly implicates that his analysis requires reflexive anaphors to be marked as given, when they avoid phrasal stress. In order to evaluate whether or not anaphors are formally represented as given, let us turn to modeling givenness’s interactions with stress placement.

In (65A1), nothing is given, but because anaphors in this framework are always given, by their nature, *himself* is given in (65A3). As a result of *himself* being given and the constraint in (64), *himself* is predicted not to bear the stress in (65A3), while *Marie* is in (65A2).

In order to test this further, let us turn to Schwarzschild (1999)’s specific formalization of this approach. His formalization involves an Optimality Theory style system of ranked violable con-

¹⁸Any approach in which neutral phrasal stress is derived from F-marking, as in Schwarzschild’s approach, would seem to require certain words –for example, function words– to be ineligible as bearers of F-marking, for purposes of neutral phrasal stress assignment. At the same time, such words are known to be able to bear contrastive focus, implicating that F-marking on function words is possible. This seems to require the grammar to make a contrast between categories (phrasal stress and focus stress) that this type of system is designed to unify.

¹⁹There is a tacit assumption in this idea: the relevant context for determining givenness has to be able to update within-sentence, to allow *himself* to be given due to the presence of *Remy* in the same sentence. This idea has support in data like (65A2). However, the two instances of *Marie* are much less local (allowing for more time for a dynamic update to the context) than *Remy* and *himself* in (65A3).

²⁰This assumption that reflexive anaphors are synonyms/hypernyms of the antecedent is not a trivial one, but it appears to be one that is commonly made when considering reflexive anaphors to be *de facto* given.

straints (Prince and Smolensky 1993). This provides a very specific, testable model for how givenness should interact with stress assignment and anaphors. The constraints he uses are defined in (66a) and ranked in (66b):

- (66) a. GIVENNESS: A constituent that is not F-marked is given.
 AVOIDF: Do not F-mark.
 FOC: A Foc-marked phrase (an F-marked phrase that is not dominated by an F-marked head) contains an accent.
 HEADARG: A head is less prominent than its internal argument.
 b. GIVENNESS, FOC >> AVOIDF >> HEADARG

Let us start with (65A1) – an example without an anaphor – to see how the model works. Note that the candidates in the tableau are being considered *in the context* provided in (65), in which nothing is given.

(67)

		GIVENNESS	FOC	AVOIDF	HEADARG
a.	[Remy _F [<u><i>burned</i></u> _F Marie] _F] _{Foc}	*!		****	*
b.	[Remy _F [burned _F <u>Marie</u>] _F] _{Foc}	*!		****	
c.	[Remy _F [<u><i>burned</i></u> _F Marie] _F] _{Foc}			*****	*!
d.	 [Remy _F [burned _F <u>Marie</u>] _F] _{Foc}			*****	

This OT tableau represents a competition between possible candidates for the grammatical output. The candidates in (67) differ in which constituents are F-marked and which constituent is most prominent, and which candidate is most optimal depends on which constraints are violated. Violating a highly ranked constraint once is less optimal than violating a lowly ranked constraint many times. With this in mind, we will briefly run through each of these candidates and the logic behind (67d) emerging as the most optimal result.

In (67a), the head of the VP, *burn*, is more prominent than its argument *Marie* – this means that the HEADARG constraint is violated, resulting in the placement of an * in the cell under the HEADARG heading. In addition, in each of (67a) and (67b), there are four F-marked constituents – resulting in four violations of the AVOIDF constraint. Because the property of being given arises

optimal output:

(69)

		GIVENNESS	FOC	AVOIDF	HEADARG
a.	☞ [Remy _F [<i>burned</i> _F himself] _F] _{Foc}			****	
b.	[Remy _F [burned _F <i>himsélf</i>] _F] _{Foc}	*!		*****	

If the anaphor were to be F-marked, as in (69b), GIVENNESS is violated in the same way as (68b): given material should not be F-marked. As such, this approach seems to work for basic examples that have the basic form of (65) – including sentences with reflexive anaphors, assuming reflexive anaphors are inherently given.

Let us turn now to some more complex data, in which the anaphor occurs in a coordinated structure.

(70) Q: What was that noise?

A1: Remy burned Marie and ***himsélf***.

Final Stress

A2: #Remy burned ***Marie*** and himself.

Here what we find is that (70A2) is entirely unacceptable, and (70A1) is the only way to map phrasal stress onto this string. The assumption that anaphors are always given and this constraint set/ranking, together, do not make this prediction in this case:²¹

(71)

		GIVENNESS	FOC	AVOIDF	HEADARG
a.	☛ [Remy _F [burned _F [<i>Marie</i> _F [and himself]] _F] _F] _{Foc}			*****	
b.	☹ [Remy _F [burned _F [Marie _F [and <i>himsélf</i>]] _F] _F] _{Foc}	*!		*****	

This system incorrectly predicts the candidate in (71a) to be optimal, with the assumption that

²¹Some have suggested that perhaps *Marie and himself* is being interpreted as a non-given entity – as a conjoined entity it is somehow discourse-new in the relevant way. Therefore *Marie and himself* ought to behave as discourse-new for the computation of phrasal stress, and phrasal stress will fall on it. Even if true, phrasal stress must still be placed on a word within this complex phrase (see Section 3.2.1 and Jackendoff 1972); and if *himself* is still given in all the same ways, the phrasal stress assigned to *Marie and himself* should not fall on *himself*. Thus making *Marie and himself* discourse-new will not avoid the issues raised here.

anaphors are given.²² Because they are given, F-marking one as in (71b) would be a violation of the very highly ranked GIVENNESS constraint, and would predict (71a) to be the optimal candidate.

Since (71b) is in fact the appropriate prosody, for this system to work, we would have to say that anaphors aren't given just in case they are in islands. Under this approach, where givenness is a non-derived property of a constituent, this would be very surprising.

Even more difficult for this system to predict is the contrast between (72) and (73):

- (72) Q: What will happen on April Fool's Day?
 A1: #Liz will glue Danny to *hersélf*.
 A2: Liz will glue *Dánnny* to herself. *Extrametrical*
- (73) Q: What will happen on April Fool's Day?
 A1: Liz will glue Danny to *himsélf*. *Final Stress*
 A2: #Liz will glue *Dánnny* to himself.

In (72), the anaphor *herself* is extrametrical, whereas in (73) the anaphor *himself* bears stress. This data is not only a problem for this Schwarzschildian system of determining phrasal stress, but for any theory in which givenness marking directly influences phrasal stress marking and reflexive anaphors are inherently given.

3.4.2 Wagner 2006: Givenness Movement

Wagner (2006) provides a new take on givenness, based on the semantics of givenness, the formal properties of which derive how givenness interacts with the phrasal stress rule. Instead of having inherent givenness marking, givenness emerges as a property relative to its syntactic sister.

“[Discourse-given constituents] can only deaccent if they are ‘relatively given’ to their sister constituent – and which is the the sister constituent can be adjusted by movement.”
(Wagner 2006:301)

To exemplify this approach, let us look at a simple example from the paper:

²²In Optimality Theory, the ☉ indicates that this is the form seen in the output, but the system doesn't predict it. The ☿ indicates that the system predicts this form, but it is not seen in the output.

- (74) Q: Lynn was in the kitchen. Frank walked in. What happened next?
A: Frank **kissed** Lynn.

Descriptively, *Frank* and *Lynn* are given because they appear in the previous sentence. Formally, Wagner argues that *Lynn* “moves to adjoin to a higher constituent”, which makes it given relative to its sister. This is sketched out as below:

- (75) [[Frank kissed ~~Lynn~~] Lynn_{GR}]

Wagner argues that, as a result of *Lynn* achieving its status of relative givenness (GR), phrasal stress will not fall on *Lynn*, but on a constituent in its sister.

Thus, it is not some inherent property of being given that influences phrasal stress placement, but it is instead the movement process that leads to GR marking that influences it. (Wagner does not go into detail about how givenness movement influences phrasal stress; we return to this in Section 3.5.2.2.²³)

Wagner provides substantial additional evidence for this approach by referring to data in which a constituent is given (following a definition such as (63)) but bears phrasal stress, such as (76):

- (76) Q: Jan has a blue convertible. What kind of car does Lenny have?
A: Guess what: It's a ***blue convertible***.

Despite *blue convertible* being given, it does not move and get GR-marked in (76A) because it is not given relative to anything else in the sentence. As such, phrasal stress will fall within *blue convertible*, as it would as if it had never been mentioned.

Another case where discourse-given bears phrasal stress is when movement is blocked (because of island effects). Compare (77A1) and (77A2) (adapted from Wagner):

- (77) Q: Why do you think Mary might have been involved in the burglary?
A1: They say they ***arrésted*** her.
A2: They say they arrested John and/or ***hér***.

In (77A1), *her* can move to adjoin to a position where it is relatively given, compared to its sister,

²³See also Ahn *in prep.* for a technical elaboration on this movement operation.

in the same way as (75). However, in (77A2), *her* is inside a coordinate structure island, movement is blocked, and phrasal stress falls on *her*. Other proposals that do not require relative givenness derived from movement (such as 64) would face serious difficulty in deriving this kind of data.

This data pattern in (77) is strikingly similar to the pattern we already observed with reflexives in (70), repeated below:

- (70) Q: What was that noise?
A1: Remy burned Marie and *himsélf*. *Final Stress*
A2: #Remy burned *Marie* and himself.

Due to the similarity in the patterns here, one might consider a new possibility: reflexive anaphors are extrametrical just in case they have moved to be GR-marked.

There are at least three reasons this analysis is appealing. First and foremost, this is the first approach we have seen that straightforwardly derives that reflexive anaphors are constrained as to when they can be extrametrical. (Namely it derives our descriptive condition on islands, (3).) In addition, this account can be formalized to be compatible with a grammatical architecture in which the phrasal stress rule (at PF) does not see LF-features like givenness. This model allows the GR-marking to be a derived syntactic feature which PF (and the phrasal stress rule) could see. Finally, this model is especially appealing because GR marking has been independently argued to be what's responsible for non-reflexive pronouns being extrametrical in cases like (77), above.²⁴

However, like the inherent givenness feature analysis before it (as examined in the previous section), this movement and GR-marking analysis of extrametrical anaphors cannot account for the variable behavior of the anaphors in the contexts below (repeated from (72) and (73)):

- (78) Q: What will happen on April Fool's Day?
A1: #Liz will glue Danny to *hersélf*.
A2: Liz will glue *Dánný* to herself. *Extrametrical*
- (79) Q: What will happen on April Fool's Day?
A1: Liz will glue Danny to *himsélf*. *Final Stress*
A2: #Liz will glue *Dánný* to himself.

²⁴At the same time, Wagner himself (2006:308) believes reflexive anaphors must be different from pronouns.

In (78), nothing blocks *herself* from adjoining to a higher node, where it could achieve status as GR-marked:

(78) A2': [[Liz will glue Dánnny to ~~herself~~] herself_{GR}]

It would be after this movement that the phrasal stress placement rule applies, and *Danny* will be the optimal candidate to bear stress.²⁵ Assuming that anaphors always undergo this movement as much as possible, we correctly predict that *herself* should be extrametrical in cases like (78).

On the other hand, in (79), *himself* ought to be able to do the same movement (there is no island preventing this movement), as in:

(79) A2':# [[Liz will glue Dánnny to ~~himself~~] himself_{GR}]

For all the same reasons *herself* underwent givenness movement in (78A2') which leads to extrametricality, it is not clear why it is not possible for *himself* to undergo the same givenness movement in (79A2') and become extrametrical. As such, a Wagner-style givenness movement/GR-marking approach would fail to predict that *himself* does bear phrasal stress.

Thus it seems that extrametrical reflexive anaphors cannot be derived with GR-marking in the same way that pronouns can be. (Recall that Section 3.3.3 reviews more evidence that extrametrical anaphors and extrametrical pronouns distribute differently.) At the same time, this sort of movement analysis of reflexive extrametricality provides a straightforward approach to the descriptive condition on islands. Thus, moving forward, we will keep in mind that movement of reflexive anaphors might play a role in deriving when they are extrametrical or not.

3.4.3 Anaphors aren't Given

In reviewing approaches to the relationship between givenness and phrasal stress, we have seen evidence that it would be a mistake to analyze the extrametricality of reflexives as the same as the extrametricality of given material. (See discussions at the end of Sections 3.4.1 and 3.4.2.) To

²⁵More must be said about functional elements like *to*. See footnote 12.

be absolutely clear on this finding., let us review two additional types of evidence that the givenness extrametricality and reflexive extrametricality as distinct. In both cases, the argument has the same general form: because we do not find the same phrasal stress patterns with reflexive anaphors and given material, it must be that reflexive extrametricality does not result from reflexives always being given.

First, consider the fact that neutral stress patterns may emerge when everything in an utterance is given (Schwarzschild 1999:§6.2.2, Wagner 2006:§3.1). As example, Compare (80), where just the object is given, with (81), where everything in the sentence is given:

- (80) Q: So, what happened with Dennis?
 A1: # Leo thanked Dennis
 A2: Leo thanked Dennis. *Extrametrical*
- (81) Q: So, is it true that in his speech Leo thanked Dennis?
 A1: Yes. Leo thanked Dennis. *Final Stress*
 A2: # Yes. Leo thanked Dennis.

Under Wagner's movement analysis, these patterns emerge because *Dennis* is GR-marked in (80); it is given relative to *Leo thanked*. On the other hand, nothing is GR-marked in *Leo thanked Dennis*; *Leo thanked Dennis* is not given relative to anything (because there is nothing else in the sentence).

Thus, if an anaphor *himself* is normally inherently GR-marked, then putting it in a context where the whole sentence containing a reflexive anaphor is given should bring out the neutral stress pattern as well – the reflexive anaphor should bear final stress. However, this is not what is observed:

- (82) Q: So, what happened with Leo?
 A1: # Leo thanked himself
 A2: Leo thanked himself. *Extrametrical*
- (83) Q: So, is it true that in his speech Leo thanked himself?
 A1: # Yes. Leo thanked himself.
 A2: Yes. Leo thanked himself. *Non-final Stress*

Comparing (81) with (83), it is clear that reflexive anaphors are behaving differently than given material. More specifically, it cannot be that GR-movement causes *himself* is less embedded than *thanked* in (83); everything is given in (83), and so nothing is GR-marked. Despite this, phrasal stress in (83) would seem to indicate that *himself* is less embedded than the verb. (And this cannot be due to givenness movement of *himself*.)

Second, a reflexive anaphor don't avoid stress after an answer to a WH-question, even if its antecedent is given:

- (84) Q: Who said Paul embarrassed Jenna?
A1: VERNA said Paul embarrassed Jenna.
A2: #VERNA said Paul embarrassed JENNA.
A3: #VERNA said JENNA embarrassed herself.
A4: VERNA said JENNA embarrassed HERSELF.

Here, the given *Jenna* must be totally unstressed; however, the reflexive anaphor *herself* must be focally stressed. In addition, perhaps surprisingly, there is another pattern available in these questions – where only the reflexive bears prosodic focus, even though the question is a subject-WH question.

- (85) Q: Who said Paul embarrassed Jenna?
A1: #VERNA said Paul embarrassed JENNA.
A2: VERNA said Jenna embarrassed HERSELF.

We will not look closely at this kind of data right now, but the grammaticality of this pattern (where just the anaphor bears stress in response to a subject WH question) is constrained by the *exact same* structural constraints as the grammaticality of sentences in which anaphors are not assigned phrasal stress. This set of facts plays a critical role in arguing for our analysis of subject orientation and the semantics of reflexive clauses. This will be the subject of Chapter 4.

To review, we have seen four pieces of evidence that suggest extrametricality of given material and reflexive anaphors must be analyzed separately.

- (86) Evidence Distinguishing Extrametricality of Reflexives and Given Material
- a. Reflexives bear phrasal stress when occurring in an island²⁶
 - b. Reflexives bear phrasal stress when not bound by the subject
 - c. Reflexives are extrametrical even when everything is given
 - d. Reflexives bear focal stress in some cases where given material must be extrametrical

Since reflexive anaphors exhibit all of these behaviors that are different from given material, we must dispense with the notion that extrametrical anaphors are given.

3.5 Defining the Structure-Based Model of Phrasal Stress

In this section, we will show that a structural approach to the phrasal stress rule is necessary to account for the range of data in the previous section. We will then explicitly define this structural model, and explore some of its properties and predictions in greater depth.

3.5.1 Ruling Out Linearization-Based Models for Extrametrical Reflexives

Before returning to the a structural model of phrasal stress, let us turn briefly entertain an older (and perhaps more commonly assumed model) of phrasal stress that is based on linearization, the Nuclear Stress Rule of Chomsky and Halle 1968:

- (87) **Linearization-Based Phrasal Stress Rule (L-NSR):**
The rightmost primarily-stressed vowel in a domain receives the highest stress.

We will call this type of model of phrasal stress an L-NSR model.

An L-NSR model faces serious challenges if it is to account for cases in which a reflexive is phrasally extrametrical. This is perhaps not surprising as we have already seen that syntactic context is what governs where a given constituent can be extrametrical. Let us briefly review some arguments that reflexives' extrametricality must arise from the syntactic structure, as well. There will be two possible ways in which L-NSR might be amended to account for reflexive extrametricality – the first is about the prosodic domain of phrasal stress, and the latter requires secondary

²⁶Given material and reflexives can be given a unified analysis for this, if one assumes a Wagner-style approach.

stipulations added to the L-NSR. Both of these will be shown to be inadequate.

3.5.1.1 Problems with a Domain-Relative L-NSR

In order to consider the first of these, we must first review to the model of prosodic constituency that was laid out in Section 2.2.1 of Chapter 2. The model, an Autosegmental-Metrical model, can be sketched out using MAE_ToBI conventions as in figure 3.1, and it has the properties in (88):

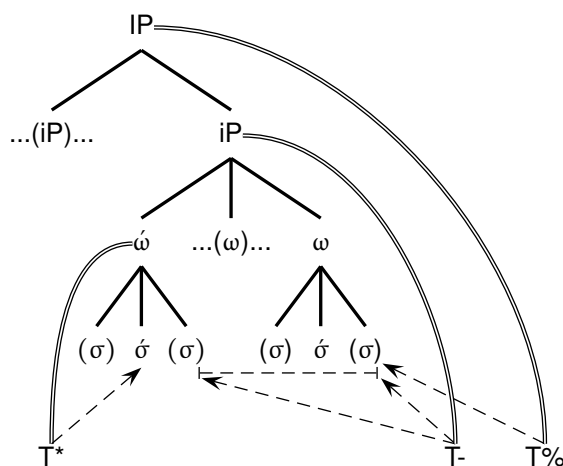

Figure 3.1: Sketch of the Autosegmental-Metrical Model with MAE_ToBI labels

(88) Auto-Segmental Model of English

- a. Every intonational phrase (IP) contains at least one intermediate phrase (iP)
- b. Every iP contains at least one prosodic word (ω)
- c. Every iP contains at least one prosodic word with phrasal stress ($\acute{\omega}$)
- d. Every prosodic word (ω or $\acute{\omega}$) contains a syllable with lexical primary stress ($\acute{\sigma}$)
- e. Every $\acute{\omega}$ is associated with a pitch accent (T^*) which is realized on the $\acute{\sigma}$ of the $\acute{\omega}$
- f. Every iP is associated with a phrasal accent (T^-) which is realized as a cover tone that spreads leftward from the final syllable of the iP to the right edge of the rightmost $\acute{\omega}$
- g. Every IP is associated with a boundary tone ($T\%$) which is realized on the final syllable of the IP

The information that will be critical for our present discussion is that the prosodic domain of phrasal stress and the rightward bound of a phrasal accent cover tone are both determined by iP boundaries — (88c) and (88f), respectively.

Having re-established this model, we can consider one attempt to allow the specific formu-

lation of the L-NSR in (87) to account for extrametrical reflexives: extrametrical reflexives are outside of the domain of phrasal stress.²⁷ That is, the L-NSR says that phrasal stress is assigned rightmost in a domain, and so perhaps reflexives are outside of this domain, which we have just established is iP – (88c).²⁸ That is, this position would require that verbs like *challenge* in (89) bear phrasal stress because – by hypothesis – they are rightmost in the phrasal-stress domain.

- (89) a. Challenge yourself!
 b. [iP [iP Challenge] yourself!]

This analysis makes at least two false predictions about how (89a) would be realized. Consider the acoustic representation of this given in (90a) from the TalkBank corpus (ClassBank Curtis nov23 line 19), which entails the phonological representation in (90b):

(90) Recording from the Curtis ClassBank in TalkBank (MacWhinney 2007, file nov23c)

a.

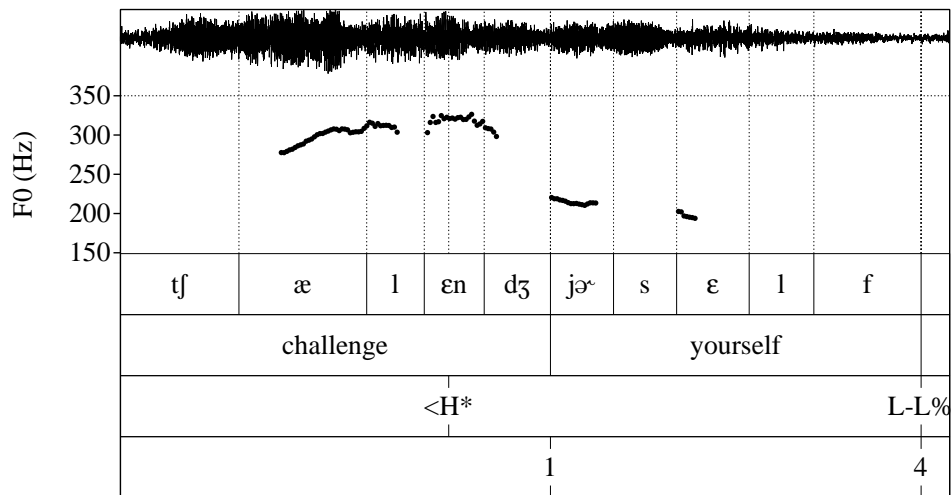

- b. [iP [iP [ω challenge] [ω yourself]]]

Let us go through this pitch track and its labeling piece by piece. First, there is a pitch accent, H*, whose peak is found in the stressed syllable of *challenge* (this can be seen by the highest point of the pitch being about where the H* is placed). Then there is the L- phrasal accent which spreads from

²⁷Alternatively, it could be that extrametrical reflexives do not contain a lexically primarily-stressed vowel. This is at odds with the fact that all reflexive anaphors do have a lexically stressed vowel: the /ɛ/ in /sɛlf/, which is the syllable that bears stress in contexts where the reflexive anaphor bears any phrasal stress.

²⁸Alternatively, the domain could be syntactically defined, as in Adger 2007. In this case, it seems Adger’s analysis would predict *yourself* to behave as though it were outside of the iP, assuming that Spell-Out maps syntactic constituents onto prosodic ones.

where it is marked all the way to the word boundary between *challenge* and *yourself*. Finally, there is the L% boundary tone, which is realized as a final fall in the final syllable (faintly observable in the ϵ). Finally, the fourth tier contains the break indices – the first break index of ‘1’ between *challenge* and *yourself* indicates that there is a prosodic word boundary between the two. The ‘4’ after *yourself* indicates that it is an IP boundary (and because of strict layering, it is also a iP and ω boundary).

A portion of this phonetic and phonological annotation is distilled in the phonological representation of prosodic hierarchy in (90b). There are at least two patterns in (90a) that strongly support this analysis. First, note that *yourself* is covered by the L- cover tone that spreads from the right edge of the utterance to the right edge of *challenge*. This means that the right boundary of the iP must be to the right of *yourself*, given (88f). Since there is no pitch accent on *yourself*, it must be that the left boundary of this iP cannot occur between *challenge* and *yourself*, otherwise this would be a violation of (88c).

Second, note how long the final syllable of *yourself* is and how short the final syllable of *challenge* is in comparison. This results from the fact that syllables that immediately precede an iP boundary are made long by a phenomenon known as final-lengthening. The fact that the final syllable of *yourself* is so much longer than the final syllable of *challenge* is consistent with there not being an iP boundary to the right of *challenge*, while there is one to the right of *yourself*.

The same phrasal accent and lengthening facts are seen in any number of examples with extra-metrical reflexives, such as (91):

(91) Recording from the Fiscus et al. 1998 (file e0970825)

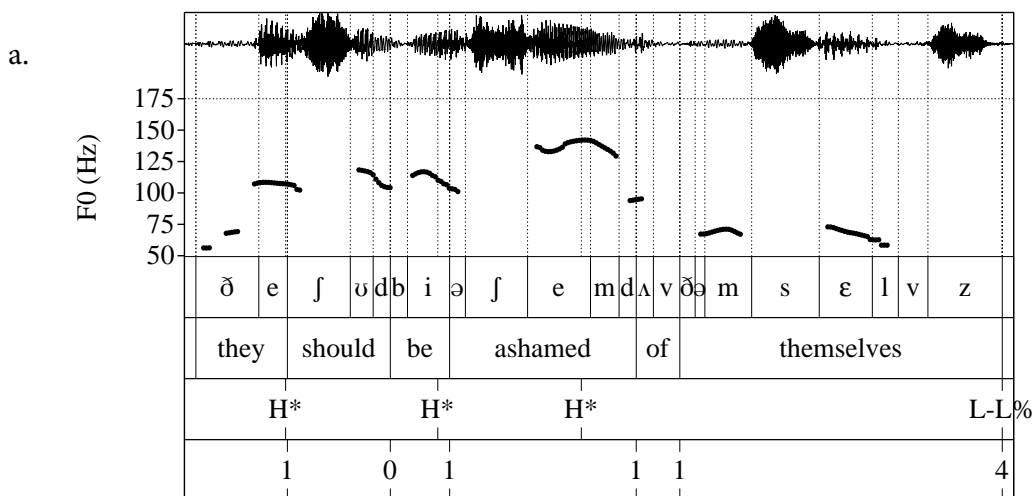

b. [IP [iP [ω they] [ω should be] [ω ashamed] [ω of themselves]]]

This phonetic investigation of these prosodic data, along with the phonological model, leads us to conclude that the extrametrical anaphor is in the same iP as the preceding phrasally-stressed predicate.

In addition to this phonetic evidence that anaphors are in the same domain as the preceding phrasal stress, there is also categorical evidence of the same conclusion. Consider the following data from particle verbs.

- (92) a. The car will turn the *áuto-pilot* off.
 b. The car will turn itself *óff*.

This data was already given in (38) and (39), and discussed there. The phrasal stress domain must include the direct object – it bears the stress in (92a) – and it must also include the particle – as it bears the stress in (92b). In this way, it must be that extrametrical reflexive anaphors are still within the relevant phrasal stress domain, but are somehow not eligible to bear the stress.

Since iP is the prosodic domain of phrasal stress, the empirical evidence is not consistent with an L-NSR approach in which extrametrical reflexives occur outside of the domain of phrasal

stress. Though it is neither unreasonable nor improbable that certain elements may simply be outside the domain of phrasal stress, this specific implementation of the idea does not work, for this phenomenon. (In fact, the solution ultimately proposed here is not so different in spirit.)

3.5.1.2 Problems with Additional Constraints for the L-NSR

Thus let us take for granted that the reflexive and the preceding stressed element are in the same phrasal stress domain. (This will again be shown to be the case in Section 3.6.) With this premise, extrametrical reflexives cannot behave the way they do as a simple result of the L-NSR in (87).

Instead, an L-NSR model would need to be supplemented by additional constraints that generate exceptions to the rule – as has been proposed (e.g. Bresnan 1971, Zubizarreta 1998²⁹):

- (93) a. “...by some means or other, anaphoric and indefinite elements are not assigned primary stress...” (Bresnan 1971)
- b. “Anaphoric phrases are metrically invisible for the NSR in English and German.” (Zubizarreta 1998)

These constraints are not investigated deeply in either work, and in both cases “*anaphoric*” is being used to refer to discourse anaphora (and not just reflexive anaphora). This general idea earns a lot of empirical coverage, while being an intuitive solution – after all, we began this chapter with the observation that reflexive anaphors tend to be extrametrical.

However, we have also already seen that such broad statements are too general to account for the range of prosodic patterns. Instead, we have enumerated several structural contexts in which reflexive anaphors bear phrasal stress, repeated below:

- (3) **Descriptive Condition on Islands**
A reflexive anaphor may bear phrasal stress in a broad focus context, if it occurs in an island that excludes (any copy of) its antecedent.
- (4) **Descriptive Condition on Subject-Orientation**
A reflexive anaphor may bear phrasal stress in a broad focus context, if its antecedent is not the subject.

²⁹Actually, Zubizarreta does not assume a linearization-based NSR, but an structurally-based one. However, the constraints that she defines for extrametricality could also apply to L-NSRs.

(5) **Descriptive Condition on Derived Subjects**

A reflexive anaphor may bear phrasal stress in a broad focus context, if it occurs in a clause with a derived subject (e.g. a passive clause).

So at minimum, if assumes an L-NSR, one would need to make a stipulation like (93) alongside additional stipulations that make explicit reference syntactic structure, like (3)–(5). This is especially suspicious, given that the L-NSR itself only makes reference to linear positions.

A more parsimonious account would involve a structurally defined NSR, since structure influences phrasal stress placement. It would seem natural for the solution to proceed in the same vein as Wagner’s solution for givenness extrametricality; reflexive anaphors’ extrametricality is also structurally-dependent, as the result of syntactic movement that influences phrasal stress.

3.5.1.3 Non-Linear Effects and the L-NSR

The role of syntactic structure is further implicated by variation in the linear position of stress within and across languages, as noted in Chapter 2. For example, the complement in a PP always bears the stress, regardless of whether the P is a preposition or postposition. This is found to be true even within-language, as Cinque (1993) points out for in German:³⁰

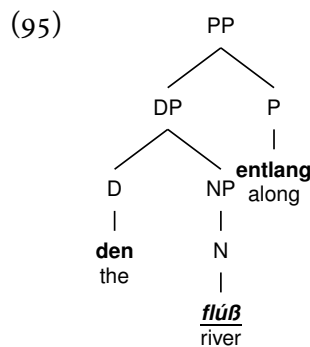
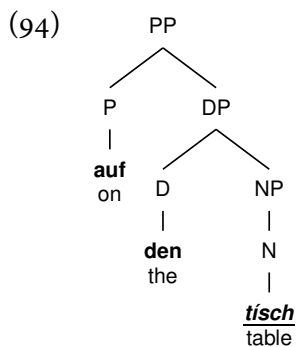

The complements of P – *den tisch* and *den fluß* – contain the phrasal stress in both (94) and (95).

³⁰Of course for this question to be relevant, it must be the case that Ps may independently bear phrasal stress in German. Biskup et al. (to appear) show that Ps can bear phrasal stress in particle Vs:

- i. Er setzt den Wanderer **über**
he set the wanderer across
'He is ferrying over the wanderer.'

This is despite the fact that the two complements are in different linear positions – something an L-NSR cannot straightforwardly account for.³¹

To be clear that structure is involved in the patterns of (94) and (95), let us briefly consider two possible explanations that might be consistent with an L-NSR. The first alternative view that would be consistent with an L-NSR might be that certain words (including many pre/postpositions) are simply too phonologically weak/light to bear phrasal stress. However, this would be insufficient for the case for (95), because *entlang* is quite phonologically heavy but is still extrametrical.

The second alternative analysis that might work for (95) might be that P is a functional category, and that is why it does not bear phrasal stress. However, German exhibits the same pattern with its variable SVO and SOV word orders. Even though it is a content word from a lexical category, the verb does not bear phrasal stress in (96) when it follows an object:³²

- (96) a. Waldemar spielt ***Theáter*** [Cinque 1993:(35a)]
Waldemar plays theater
'Waldemar is on the stage'
b. Waldemar will ***Theáter*** spielen
Waldemar will theater play
'Waldemar will be on the stage'

Thus, an L-NSR account for German would have to involve some additional, non-linearization-based stipulation(s) such that verbs with objects cannot bear phrasal stress.³³ Formulating such a constraint will almost certainly have to reference syntactic structure, in which case a structurally defined NSR would seem to have the advantage of parsimony, as we saw in the previous section.

Moreover, an NSR sensitive to syntactic configurations could be formulated to account for the fact that objects of verbs bear phrasal stress under normal circumstances, regardless of whether

³¹I do not return to an analysis specific to these data. Briefly, it is because the complements of P are more embedded than P; see Section 3.5.2. (Even if the DP *den fluß* has moved to be specifier of P in (95), the phrasal stress model in this dissertation predicts this, as long as movement of the DP to Spec,PP is movement through a phase edge. See Section 3.5.2.1 for a discussion of how different movements interact differently with the NSR.)

³²Thanks to Martin Walkow, for providing the data in (96b), as a minimal pair to (96a) from Cinque 1993.

³³Schwarzschild 1999 and Büring 2013 offer such a constraint, which effectively says predicates should be prosodically weaker than their arguments. This works for these cases, but not for all – e.g. when a specific object undergoes object shift, the predicate it is an argument of gets the phrasal stress; Cinque 1993:(38b).

the verb precedes or follows the object – note the similarities to (94) and (95):



(For our purposes here, it neither matters where the verb is in the structure nor that the verb is argued to be in different positions in these two structures. All that matters is that the object occurs in a complement position in both cases.)

Finally, in addition to this within-language data from German, Donegan and Stampe’s (1983) crosslinguistic comparison found that a verb’s object bears phrasal stress, regardless of a language’s basic constituent word order. This is in Table 3.1.

	Phrasal Stress on Object	Phrasal Stress on Verb
VO-language	✓	✗
OV-language	✓	✗

Table 3.1: Word Order and Phrasal Stress Location

Though the position of phrasal stress location cannot be defined linearly for this kind of data, it is easily defined structurally: it is consistently found to fall on the object in simple clauses with just a subject, object and verb. In the next section, we turn to a specific model which can capture these findings by referencing syntactic depth of embedding.

3.5.2 Definitions and Properties of the S-NSR

As briefly exposed in Section 2.2.3 of Chapter 2, the appropriate model of phrasal stress must be sensitive to structural height and syntactic domains. We will refer to this type of approach to phrasal stress placement as a Structure-Based Nuclear Stress Rule (S-NSR), and one specific

formalization of this S-NSR is defined below.³⁴

(99) **Structure-Based Phrasal Stress Rule (S-NSR):**

The most deeply embedded constituent in a Spell-Out Domain receives the phrasal stress.

(100) **Depth of Embedding:**

A syntactic object, X, is more deeply embedded than some other syntactic object, Y, provided that no copy of X c-commands all copies of Y³⁵

This specific formulation of phrasal stress placement follows from previous extensive works showing both that embedding is what matters (Cinque 1993, Zubizarreta 1998, Kahnemuyipour 2009, and Kratzer and Selkirk 2007) and that cyclic domains as defined by Spell-Out (Zubizarreta 1998, Legate 2003, Adger 2007).³⁶

3.5.2.1 Divorcing Phrasal Stress and Linearization

Recall that it was shown in the previous section (3.5.1) that structure (not linear order) is the input for determining the locus of phrasal stress. This implies that linearization and phrasal stress ought to be dissociated from one another. In this section, further evidence will show that linearization and phrasal stress must indeed be dissociated.

Before reaching this conclusion, we will explore our predictions using more abstract structures. Consider the structure in (101), in which a constituent X moves around another constituent Y:

³⁴Recall from Section 2.1.1 of Chapter 2 that non-complements do not have any depth, due to our Multiple Spell-Out model of Grammar. Uriagereka 1999 shows this must be the case with arguments from linearization, and argues that non-complements are forced to Spell Out (i.e. become a pairing of phonological and semantic forms with a syntactic label) before merging with the spine. For more details on how this impacts phrasal stress, see Appendix F and Ahn *in prep.*

³⁵Informally, this means that a constituent is most embedded if it doesn't c-command (all the copies of) some other constituent. A more formal definition can be given in terms of Collins and Stabler's notion of *occurrence*: X is more embedded than Y if the highest occurrence of X is lower than the highest occurrence of Y.

³⁶Kratzer and Selkirk 2007 and Kahnemuyipour 2009 argue that it is not "most embedded", but "least embedded". The findings of a cartographic approach to adverbs (e.g. Cinque 1999) and the placement of stress implicates that it is in fact most embedded, and not least embedded. An additional argument comes from object-bound anaphors (i.e. anaphors about by an object), which we will return to in Section 3.7.1.4.

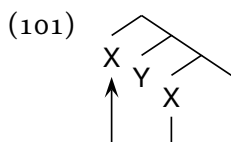

It has been argued that movements of X may or may not affect linearization (Bobaljik 1995, 2002, Fox 2002, Fox and Nissenbaum 1999, and Pesetsky 1998, among others), even if the movement takes place in the narrow syntax. That is, the linearization operation could ignore the lower copy of X (resulting in the order ‘XY’), or the higher copy of X (resulting in the order ‘YX’). We will refer to these two linearization options as “spelling out the head of the chain” or “spelling out the tail of the chain”, respectively. Because the latter is a recent theoretical development, many of the narrow-syntactic movement operations posited in the literature are the former type, spelling out the head of the chain. For example, German object shift is a movement that spells out the head of the chain (data from Cinque 1993):³⁷

- (102) a. ... daß Bruno oft den Kindern sein Géld gab
 ... that Bruno often the.DAT children.DAT his money gave
 “... *that Bruno often gave his money to the children*”
 b. ... daß Bruno sein Geld [oft den Kínderen ~~sein Geld~~ gab]
 ... that Bruno his money often the.DAT children.DAT gave
 “... *that Bruno often gave his money to the children*” (Object Shift)

In (102b), *sein Geld* has moved, resulting in being linearized before an adverb and the other complement.

On the other hand, more recent works on Quantifier Raising (QR) have argued QR to be the type of movement that spells out the tail of the chain – the grammar dictates that this movement take place, however its effects are concealed from the linear order (data/analysis adopted from Fox and Nissenbaum 1999).

- (103) a. (look for > ∃)
 I looked for a picture yesterday.
 b. (∃ > look for)
 I [looked for a picture yesterday] a picture. (QR)

³⁷Cinque gives this object shift data in an embedded context to give rise to SOV order. Similar effects are found in matrix clauses when there is an auxiliary verb: *Bruno hat sein Geld oft den Kínderen gegeben*. (Thanks to Martin Walkow for the judgment.)

(Fox and Nissenbaum have additional arguments that this movement takes place, from word order facts.) Thus, though *a picture* has moved, its higher copy seems to be being ignored by the linearization function, resulting in spell out of the tail of the chain.

Comparing (102) and (103), it would seem that movements in the narrow syntax need not always result in a new linearization, because the linearization function may either attend to the head or tail or a movement chain.

Independent of linearization, narrow syntactic movement of X may or may not affect phrasal stress assignment. Compare the givenness movement in (104), adapted from Wagner 2006, with the WH-movement in (105), adapted from Bresnan 1971:

- (104) a. (John walked in. What happened next?)
 He kissed the ***girls***.
- b. (The girls sat at their desks. John walked in. What happened next?)
 [He ***kissed*** the girls] ~~the girls~~. (Givenness Movement)
- (105) a. Helen had written some ***books***.
- b. What ***books*** has Helen written ~~what books?~~ (WH-Movement)

The givenness movement feeds phrasal stress – after movement it seems like the lower copy of *the girls* is ignored so that *kissed* is considered most embedded. In other words, within the Spell Out Domain containing the verb and its complement, it is as though the copy of the complement which is more embedded than the verb is ignored, for phrasal stress assignment. On the other hand, in the case of WH-movement, the higher copy seems to be ignored so that *what books* is considered most embedded. That is, though a copy of the WH-phrase c-commands most of the structure at one level of representation, the S-NSR attends to the copy of the WH phrase that occurs in the most embedded position.

In fact, the decisions of which copy is relevant for linearization and which copy is relevant for phrasal stress appear to be made entirely independently of one another. This is laid out in Table

3.2.

		<u>Relevant for Linearization</u>	
		Higher Copy	Lower Copy
<u>Relevant for NSR</u>	Higher Copy	Object Shift; e.g. (102)	Givenness Movement; e.g. (104)
	Lower Copy	WH-Movement; e.g. (105)	QR; e.g. (103)

Table 3.2: Double Dissociation Between Linearization and Phrasal Stress

(Though it was not discussed when (102) and (103) were presented, the examples are marked for phrasal stress, exhibiting the patterns described in the table.)

This double dissociation between linearization and phrasal stress assignment means the neither operation should not be defined in any way that depends on the other. We should want to understand how then we can derive which copy the NSR pays attention to. Critically, these patterns summarized in Table 3.2 are very difficult to understand in an L-NSR framework. In the next section we will turn to a solution using the S-NSR, examining each of the different types of movement individually.³⁸

3.5.2.2 Phrasal Stress and Two Kinds of Movement

As was just demonstrated, there seem to be cases in which the copy relevant for the NSR is the higher copy, and some cases where this is the lower copy. This split is exactly what is predicted when the S-NSR is couched in a Multiple Spell Out framework (e.g. Uriagereka 1999, Chomsky 2000, *et seqq.*).

Recall from our definition of the S-NSR, that phrasal stress is computed on the hierarchical

³⁸We should also want to understand what determines which copy linearization attends to. To my knowledge, this question has not been fully addressed in the literature discussing variable Spell Out of a head/tail of a chain, and addressing it here is beyond the scope of this dissertation.

structure of the Spell-Out Domain. This derives from the fact that the structural input to Phonology (where the NSR applies) is not the entire clause – and not even an entire phase – but rather the complement of the phase head: a Spell-Out Domain. Thus in the structure below, there is a Spell-Out Domain containing X and Y, but excluding Z and Phase^o (the labels Phase^o and Spell-Out Domain are purely descriptive, to avoid unnecessary theoretical commitments):

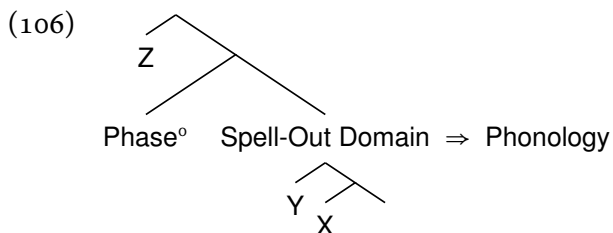

The fact that only the substructure [Y [X]] is sent to Phonology derives the restriction in the definition of the S-NSR that it applies to Spell-Out Domains.

Now let us turn to movement and Spell Out. Consider the following abstract structure, in which there are two copies of X and two copies of Y:

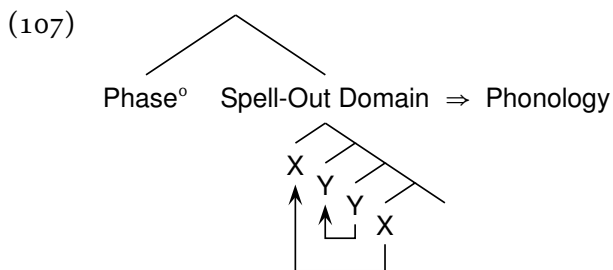

In this structure, when the NSR applies, its input will be the Spell-Out Domain, [X [Y [Y [X]]]]. Because there is a copy of X that c-commands all copies of Y, Y is most deeply embedded, according to our definition of embeddedness in (100). As a result the S-NSR assigns phrasal stress to Y. In other words, Y being most embedded depends on the there being a higher copy of X that is visible to the NSR.

On the other hand, let us consider a very similar structure, where the only difference is that the movement of X targets a position outside of the Spell-Out Domain:

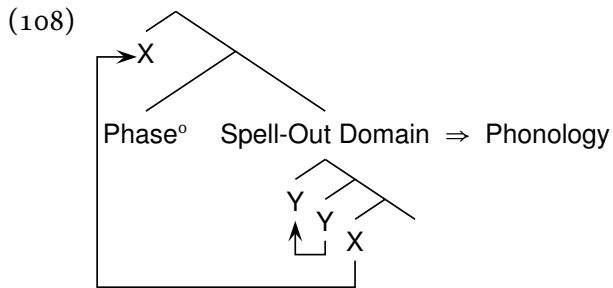

Unlike (107), X is most deeply embedded and is assigned phrasal stress. What the S-NSR sees is the Spell-Out Domain [Y [Y [X]]], in which there is only a single copy of X that Y c-commands. The higher copy of X is not visible to the S-NSR, as it would not yet be Spelled-Out; the fact that there is a higher copy of X is irrelevant for the NSR.

With this in mind, let us briefly return to the data from (102)–(105) in which movement has taken place.

- (109) a. ... daß Bruno sein Geld [oft den Kinderen ~~sein Geld~~ gab]
 ... that Bruno his money often the.DAT children.DAT gave
 “... that Bruno often gave his money to the children” (Object Shift)
- b. (∃ > look for)
 I [looked for a picture yesterday] ~~a picture~~. (QR)
- c. (The girls sat at their desks. John walked in. What happened next?)
 [He kissed the girls] ~~the girls~~. (Givenness Movement)
- d. What books has Helen written ~~what books~~? (WH-Movement)

In all of these examples, the moving constituent has one copy that is the most deeply embedded element in the sentence, and another copy that is not.

In (109a) and (109c), the moving constituent does not bear phrasal stress, even though it has a copy that is (in a sense) most deeply embedded. This implicates a structure like (107), in which both copies of the chain are within the same Spell-Out Domain. This is represented visually in the trees below:

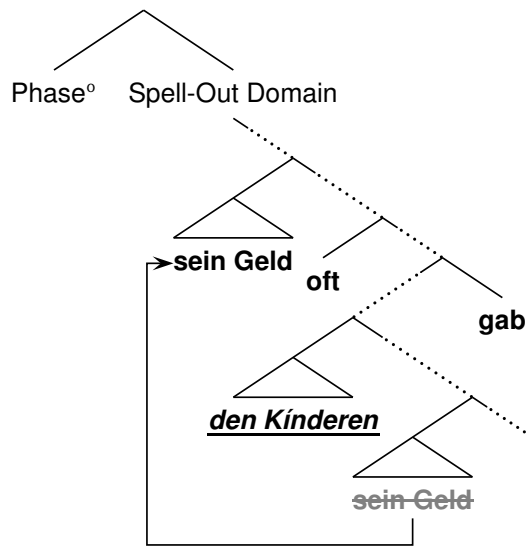
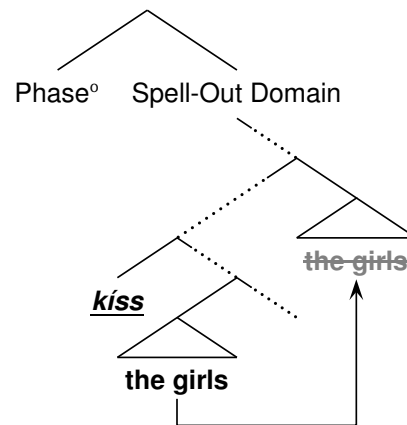
(110) German Object Shift(111) Givenness Movement

To be absolutely clear, our definition of depth makes *den Kinderen* most embedded at Spell-Out in (110), because there is a copy of *sein Geld* that is higher than *den Kinderen*. Similarly, in (111), a copy of *the girls* c-commands all copies of *kiss*, meaning *kiss* is most embedded. In this way, the S-NSR correctly predicts the phrasal stress placement in these two derivations.

On the other hand, in (109b) and (109d), the higher copy must not be in the same Spell-Out Domain as the lower copy. If it were, we ought to find extrametricality of the moving constituent. (The NSR would see the copy that is higher than the verb, and the verb would be most most embedded and bear stress.) Instead, the stress is assigned to the phrases undergoing QR or WH-movement, because the copy (or copies) of QR'd phrase/WH-moved phrase are most embedded within the Spell Out Domain containing them.³⁹

³⁹An observant reader might note that other WH phrases do not exhibit this property – only WH phrases with lexical heads do. (Compare (109d) with *What has Helen written?*) There must be additional properties that rule out the fact that such WH phrases are extrametrical. Bresnan 1971 proposes that they are indefinite pronouns which are not visible to the NSR. In a model in which the NSR has no exceptions, this is only a descriptive generalization, which begs the question of what derives it. See Ahn *in prep.* for some discussion.

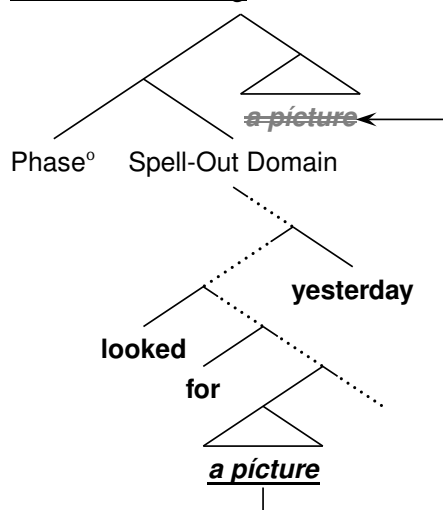
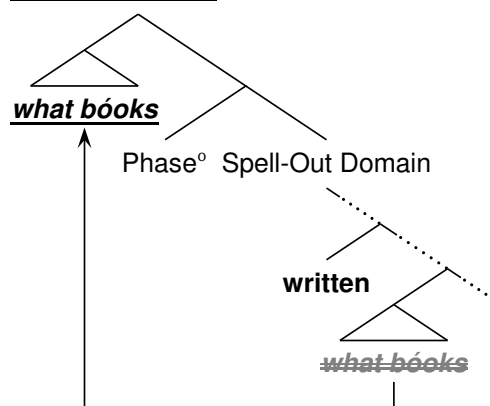
(112) Quantifier Raising(113) WH-Movement

In (113), at Spell-Out, Phonology only sees one copy of *what books*, and it is the most embedded constituent in the Spell-Out Domain, so the S-NSR marks it with phrasal stress, and the higher copy gets Spelled Out and bears the stress.⁴⁰ The derivation proceeds nearly identically for *a picture* in (112), except that the lower copy is pronounced. Phrasal stress falls on *a picture* because only its lower copy is within the Spell-Out Domain, feeding the NSR, despite its higher copy.

To review, the range of phrasal stress data is the range one would expect from a syntactically governed NSR in a Multiple Spell Out architecture. With this model, phrasal stress data can be employed to make syntactic arguments, similar to how linearization is used to the same end. The fact that German Object Shift and English givenness movement target positions within the Spell-Out Domain implies that the Spell-Out Domain containing the verb is probably larger than originally thought (see Ahn *in prep.* for more discussion). In addition, WH-movement and QR do not target any positions within the Spell-Out Domain; instead they target a phase-edge po-

⁴⁰This is because the lower copy of *what books* is marked (abstractly) with phrasal stress; and following that, all members of the chain have the same marking, or they wouldn't be true copies. This implicates that Phonology knows about chains/copies, and copy deletion will need to take place in phonology (as in Nunes 1995, *et seqq.*). Alternatively, there is only ever one copy in a derivation associated with multiple addresses in the structure, as in multidominance models, in which case it is trivial that phrasal stress marking is shared across copies. (See Appendix A for a brief exposition of a possible multidominance approach for extrametrical reflexive anaphors.) For additional cases of post-lexical PF features being shared across copies, see also Chapter 4, Selkirk 1996b and McPherson 2014.

sition. This confirms previous work on the position(s) targeted by WH-movement and QR (e.g. Chomsky 2000, Legate 2003, Citko 2014).

Further research is necessary to make more precise conclusions on these topics, but phrasal stress patterns can (and should) be used to inform our understanding of the grammatical phenomena being observed. They can be used to indicate the location of phase boundaries, whether or not movement has taken place within a Spell-Out Domain, as well as hierarchical relations between constituents. In fact, phrasal stress data can be used to uncover, and argue for, aspects of syntactic derivations that might otherwise remain hidden.

3.5.2.3 Summary of the Structural Model

Let us briefly review the core of what we have seen thus far. Our model of phrasal stress is remarkable for its simplicity; it involves only one statement (below), but can straightforwardly account for complex patterns, without the need for any new technical machinery or special operations.

(99) **Structure-Based Phrasal Stress Rule (S-NSR):**

The most deeply embedded constituent in a Spell-Out Domain receives the phrasal stress.

In the context of our grammatical architecture, this model of phrasal stress has two important corollaries, which will be critical for the syntactic investigation of any phrasal stress phenomenon.

First, phrasal stress is entirely dissociated from linearization – the two operations can attend to different copies in a chain. At the same time, it is understandable how the two would overlap so heavily – both depend on the syntactic structure and position of copies. This dissociation is both necessary to account for the data (see 3.5.1.3) and also desirable in that it is what we expect from a simple structure-based approach to the NSR.

Second, whether movement applies within or out of a Spell-Out Domain one determines which copies are relevant for the NSR. This falls out as a corollary of the phrasal stress model being couched in a Multiple Spell-Out architecture of grammar. Because the NSR applies at Phonology, and Phonology does not see all the structure at once, we derive the fact that some movements will

feed phrasal stress, and others will not. Namely, only movement within a Spell-Out Domain (i.e. where the movement results in multiple copies within a single phonological computation) will feed phrasal stress. In other words, all copies are relevant for the NSR. The NSR never ignores any copy that it can see. It is just that some copies are not visible at Phonology, due to the architecture of grammar.

As a consequence of this phrasal stress model, both the theoretician and the learner can use prosodic data to bootstrap what kind of syntactic derivation is necessary. Phrasal stress is a cue for syntactic structure, the same way that interpretation and word order also present cues for the structure. In the next section, we explore in more depth the phrasal stress patterns for reflexive anaphors, and their implications for the syntactic derivation.

3.6 Interpreting Phrasal Stress Patterns Syntactically

We now turn to some prosodic data, for a chance to understand how one can make conclusions about the syntax from it in the framework just established in the previous section. Consider the following very simple data set in (114):

- (114) a. *Dánce!*
b. Dance the *Chárleston!*
c. Dance the Charleston onto the *stáge!*

Taking these data together, our definition of S-NSR requires that there is a Spell-Out Domain containing *dance*, *Charleston* and *stage*, with the following hierarchical ordering:⁴¹

- (115) dance > Charleston > stage

The fact that *stage* bears phrasal stress in (114c) indicates that it is more embedded than *the Charleston*; this rules out a structure where the *onto the stage* is externally merged higher – e.g. as an adjunct to VP.

⁴¹The greater-than symbol, “>”, should be read as “is less embedded than”, following the definition of embeddedness in (100).

Thus, with more evidence (from phrasal stress or otherwise), we would arrive at a structure that broadly resembles (116):

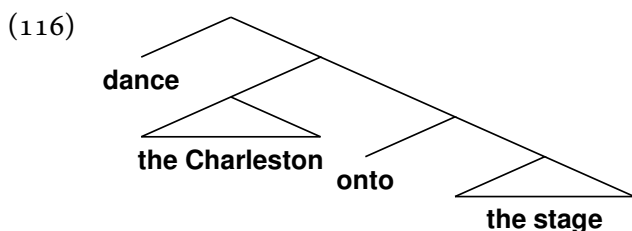

This structure, which we have derived on the basis of phrasal stress, is independently supported by research on similar sentences. In particular, the hierarchical organization of (115) is strongly reminiscent of a Larsonian thematic hierarchy of V > theme > goal (Larson 1988).

With this idea of how to interpret phrasal stress data for syntactic purposes, let us now return to the findings of our investigations of phrasal stress with given material and reflexive anaphors. Recall the constraints we have seen on where extrametrical reflexive anaphors can occur:

(3) **Descriptive Condition on Islands**

A reflexive anaphor may bear phrasal stress in a broad focus context, if it occurs in an island that excludes (any copy of) its antecedent.

(4) **Descriptive Condition on Subject-Orientation**

A reflexive anaphor may bear phrasal stress in a broad focus context, if its antecedent is not the subject.

(5) **Descriptive Condition on Derived Subjects**

A reflexive anaphor may bear phrasal stress in a broad focus context, if it occurs in a clause with a derived subject (e.g. a passive clause).

Proper interpretation of these constraints will lead us to an analysis of extrametricality in reflexives.

3.6.1 Islands and Movement

Beginning with (3), we can interpret this generalization in a similar way that the island facts are interpreted for givenness: extrametrical reflexives move (cf. Section 3.4.2). The answer to the question “Why (3)?” has to do with the fact that movement obeys islands.

(117) **First Theoretical Observation of Extrametrical Reflexives:**

Movement constrains the grammatical contexts in which reflexives may be extrametrical.

In the remainder of this section, we will clarify this observation and provide a more detailed formal characterization of the movement.

Let us begin with the basic motivations for movement. In (118), it must be that *Roberta* is more deeply embedded than the verb *loves*. This is represented in (119), using canonical labels and head movement.

(118) Werner loves ***Roberta***.

(119) [_{VP} loves [_{VP} ***Roberta*** loves]]

Let us assume that there is some constraint on mapping between syntactically selected arguments and the thematic interpretations of each of those arguments – it could be UTAH (Baker 1988) or something much weaker like (125):

(120) **Predicate-Relativized UTAH**

For any predicate P, if P selects an argument with thematic role X, which appears in the structural position S as a consequence of selection, then, across utterances, any time P selects an argument with thematic role X, it must appear in the same structural position S.

In other words, across utterances with the same predicate, the syntactic positions in which the predicate's arguments are introduced remain constant. With any kind of constraint like this, it must be that every argument that is interpreted as the theme of *love* is introduced in the same, most-embedded position as (119).

Now consider the sentence in (121), in which all arguments have the same thematic relations as (118):⁴²

⁴²The syntax of (122) is not unaccusative, unlike some analyses of Romance languages (e.g., Marantz 1984, Sportiche 1990, Pesetsky 1995, Rooryck and Vanden Wyngaerd 2011, among many others). See arguments in Chapter 4 as well as Sportiche 2014.

(121) Werner loves himself.

Thus, following the S-NSR and (Predicate-Relativized) UTAH, it must be that *himself* moves from the most embedded position (where *Roberta* occurred in (119)) to a position higher than *loves*:

(122) Werner ~~himself~~ [_{VP} loves himself].

To be clear, this movement results in there being a higher copy of the reflexive anaphor that is less embedded than the verb, and the tail of the chain is spelled out. (This is basically identical to the givenness movement from Section 3.5.2.2; compare (122) with the structure in (111).) When this movement is not possible, it doesn't take place, and the anaphor may bear phrasal stress.

As a reminder: it's not the case that movement is necessary for binding. The reflexive pronoun is bound by Werner in (123), despite the island:

(123) Werner loves [_{island} Roberta and himself] *Final Stress*

Instead, what movement is necessary for is to license the extrametrical reflexives.⁴³

If the island containing the anaphor also contains a copy of the antecedent, it is possible for the anaphor to move to be near it and to be extrametrical:

(124) Werner [_{island} listened to Roberta and defended himself]. *Extrametrical*

(125) Werner [_{island} ~~Werner~~ listened to Robérta and ~~Werner himself~~ [defénded himself]]

Here, there are two copies of *Werner* within the island – as the subject of each extended verbal projection. *Werner* then ATB moves out to TP, where it become the subject of the sentence. Due to the presence of a copy within the island, *himself* seems to be able to move to be near it, and become extrametrical, in accordance with (3).

An important issue we must address is where *himself* moves to in (122) and (125). Moving within the island in (125), which is a small clause of some kind, is enough to achieve extrametricality; so the target of movement seems to be close to the subject, but not as high as the sentential

⁴³The reflexive anaphors in (122) and (123) are subject to different licensing mechanisms. See Appendix E.

subject position. Additionally, because the movement feeds phrasal stress, it must be the target of the reflexive movement is within the the same Spell-Out Domain as the verb, as only movement within the Spell Out Domain feeds the S-NSR. (See Section 3.5.2.2.) These analytical facts are represented in the underspecified structure below:

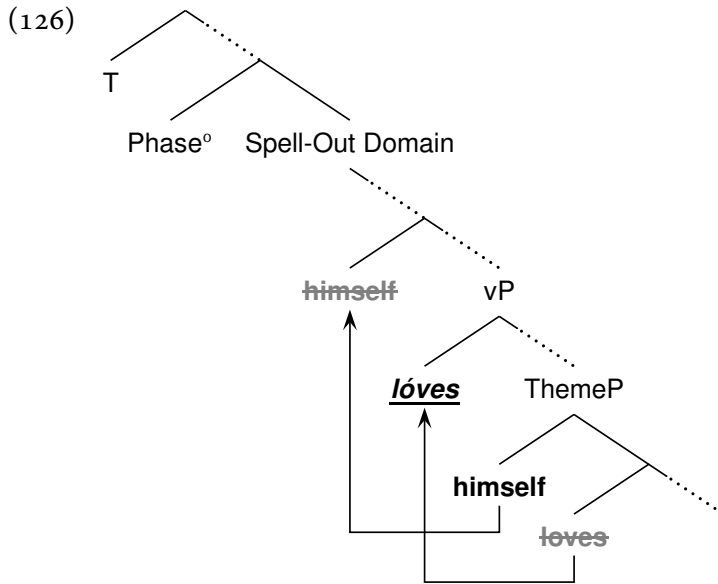

This structure represents a derivation in which *himself* is externally merged in theme position, *loves* occurs in a position higher than that (as a result of the head movement in (126)), and finally *himself* moves to a position higher than *loves* (though it is spelled out in its thematic position).

This structure represents only the beginning of an analysis of extrametrical reflexives. It ought to be made more precise, with a deeper explanation as to why the derivation proceeds in this way. We will do so by considering the other two descriptive conditions on extrametrical reflexive anaphors.

3.6.2 Subjecthood and Structure

What we don't yet understand is where they move to or why. Investigating the next two constraints, repeated below, will help to answer these questions.

(4) **Descriptive Condition on Subject-Orientation**

A reflexive anaphor may bear phrasal stress in a broad focus context, if its antecedent is not the subject.

(5) **Descriptive Condition on Derived Subjects**

A reflexive anaphor may bear phrasal stress in a broad focus context, if it occurs in a clause with a derived subject (e.g. a passive clause).

Let us first consider the property of subject orientation, in (4). Past analyses of subject oriented anaphors have posited movement of the anaphor, in addition to whatever the normal binding conditions on anaphors are, which have not made reference to the antecedent (only to the anaphor). This tendency in derivational approaches has been noted before:⁴⁴

“...the most prominently defended mechanism for explaining the crosslinguistic variety of locality conditions on anaphors has been to posit (covert) movement to the more local domain.” (Safir 2004:7)

This movement (which is sometimes argued to be at LF) targets a landing position so that the anaphor is in the subject’s local domain – typically somewhere in the INFL region.

(127) **Basic Movement Analysis of Subject-Oriented Anaphors**

[_{InflP/TP} SUBJECT ANAPHOR [_{vP/VP} VERB (INTERVENER) ANAPHOR]]



As a result, the only possible antecedent after movement is going to be the subject, because of locality considerations for possible syntactic binders.⁴⁵

“...the reflexive must move to a position sufficiently near its antecedent. This might happen in the syntax, as in the cliticization processes of the Romance languages. If not, then it must happen in the LF component.” (Chomsky 1995:Ch. 1)

⁴⁴Hornstein (2001) and Kayne (2002) also employ movement to relate the anaphor and its antecedent, but they differ from other movement theories in that they posit this movement for all anaphors, not just subject-oriented ones, and they do not posit that the anaphor itself moves. Since they do not distinguish subject-binding from non-subject binding, I focus on theories in which the anaphor moves just in case the subject is the binder. I assume that, with little to no real substantive changes, the Hornstein and Kayne approaches could be amended to capture the same facts as the anaphor-movement approach espoused here.

⁴⁵Any approach to binding which does not make reference to syntactic structure would need to capture subject orientation in some other way. For example, an approach which refers to thematic hierarchy could stipulate that subject oriented anaphors are defined such that their antecedent must not only be higher on the thematic hierarchy than the anaphor (e.g. Pollard and Sag 1992), but the highest. On the other hand, I believe past coargument approaches (e.g. Reinhart and Reuland 1993, Reuland 2011) or a valency-reducing approaches (Bach and Partee 1980, Szabolcsi 1987, Keenan 1988, Schlenker 2005, *inter alia*) cannot speak at all to this, without additional conditions, as the relevant notion of ‘subject’ is syntactic and not semantic.

Exactly where the anaphor lands is not relevant (nor is it often specified) – this type of analysis only depends on there being no possible interveners between the subject and the anaphor, after movement.

Subject orientation is tied up in movement to be near the subject antecedent (as reflected in (126) and (127)). However, (127) is too simple of an analysis.⁴⁶ Analyses of the type in (127) have a problem of overgeneration. Specifically, if all reflexives that undergo movement like this are extrametrical, such analyses predict that any subject should be able to function as the antecedent of an extrametrical reflexive.

However, derived subjects of passive and raising-over-experiencer clauses do not license surface-clausemate extrametrical reflexives. (Similar facts have long been known for subject-oriented anaphors in other languages; see Chapter 5 and references therein.) If we are to explain this restriction on the type of subject that qualifies for licensing reflexive movement (and by extension, reflexive extrametricality), we must provide an analysis that is more concrete than (127).

To analyze these facts, it may be helpful to first synthesize (4) and (5) as a single statement:

(128) **Descriptive Condition on Subject Antecedents**

A reflexive anaphor may bear phrasal stress in a broad focus context, if its antecedent is not both the grammatical subject (S-structure subject) and the highest thematic argument (D-structure subject).

Putting this generalization in terms that result in a well-formed condition in the grammar would seem to be difficult. Simultaneously considering a constituent's S-structure position and its D-structure position would be a non-local operation. That is, there is no point in the derivation that would locally and directly indicate whether a constituent is both the S-structure subject and the D-structure subject. (Minimalist grammars hold that what becomes the subject is based solely on first principles such as Attract Closest/Relativized Minimality and the Activity Condition.)

We need to re-frame these descriptive constraints, in order to be able to derive them under a

⁴⁶There is also an issue of the timing of binding principles in this kind of analysis. This is discussed in depth in Chapter 5.

unified approach. Instead of non-local constraints on syntactic positions at different levels of representation, this constraint could refer to the mechanism for deriving which thematic argument gets mapped onto the grammatical subject position: grammatical voice.

That is, grammatical voice can be thought of as a set of conditions that define which constituent in the underlying argument structure becomes the surface subject (cf. Ahn and Sailor 2014, Sailor and Ahn 2010). Thus, our observations in (4) and (5) are not about subjecthood, *per se*, but rather about grammatical voice. Extrametrical reflexives are dependent on the grammatical voice of the clause:

(129) **Second Theoretical Observation of Extrametrical Reflexives:**

Grammatical voice constrains the grammatical contexts in which reflexives may be extrametrical.

By associating extrametrical reflexives with the grammatical voice of the clause, we can account for (4) and (5).

In order to derive the observation in (129), we need a clearer idea of how grammatical voice is instantiated in the syntax. We syntactically define Voice as (features on) a head outside of the lexical verb (Kratzer 1996, Chomsky 1995, 2001, among many others). More specifically, voice is represented as the head of a projection (VoiceP) that sits in a position higher than the external argument (Collins 2005b, Gehrke and Grillo 2009, Harley 2013, Chapter 4). Finally, VoiceP is situated within the same spell-out domain as the lexical verb (explicitly so in Coon et al. 2011).⁴⁷ These properties of grammatical voice are represented in (130) (where Θ -Domain indicates the entire stretch of structure in which all thematic arguments are externally merged):

⁴⁷See Chapter 5 for a survey of a variety of different past approaches to grammatical voice.

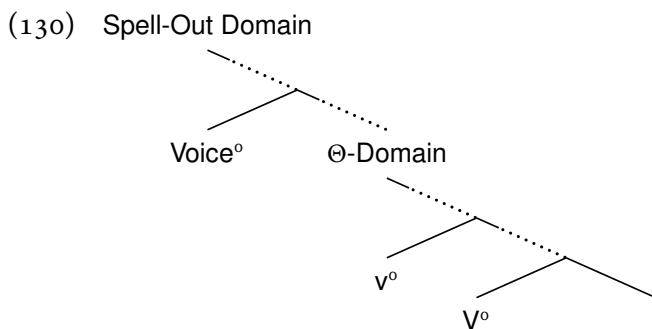

The featural properties of Voice° affect which constituent may become the surface subject in the course of the derivation (e.g. Collins 2005b, Sailor and Ahn 2010).

In particular, extrametrical reflexives depend on a certain Voice° – one which will not result in a derived subject, and one which will also effect a reflexive movement like the one in (127). The proposal here is that the Voice° that has this property is a Reflexive Voice°.

3.6.3 Giving Reflexivity a Voice

Taking these findings together, what we have is a system in which certain reflexives move, to a position that is near the antecedent and that is within the Spell-Out Domain for the extended verbal projection. This movement is triggered by the presence of a Reflexive Voice head (REFL), which is endowed with an EPP feature that attracts a reflexive argument. This is sketched out below:

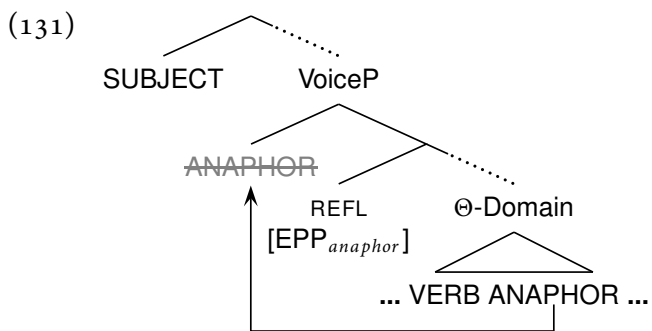

This movement is like givenness movement in Section 3.5.2.2, in that it is movement that (i) targets a position within the Spell-Out Domain, and (ii) spells out a lower copy. This explains the

similarities (and why the two extrametricality phenomena are often conflated). The differences between givenness and reflexivity are rooted in the fact that REFL is what triggers the movement of the anaphor. These facts derive from the constraints in (3)-(5), and results in the anaphor only moving in contexts of Local Subject-Oriented Reflexivity (LSOR).

Movement of a reflexive has been proposed before (Pica 1987, Chomsky 1995, Safir 2004, Reu-land 2011, etc.), but across the board, these previous movement proposals differ in their formal properties such that they cannot account for the observed (variable) stress properties of reflexive anaphors. To see how the proposal in (131) accounts for the prosodic data, let us turn to a more concrete example with a more complete derivation:

(132) Structure for *Werner loves himself* (To Be Revised)

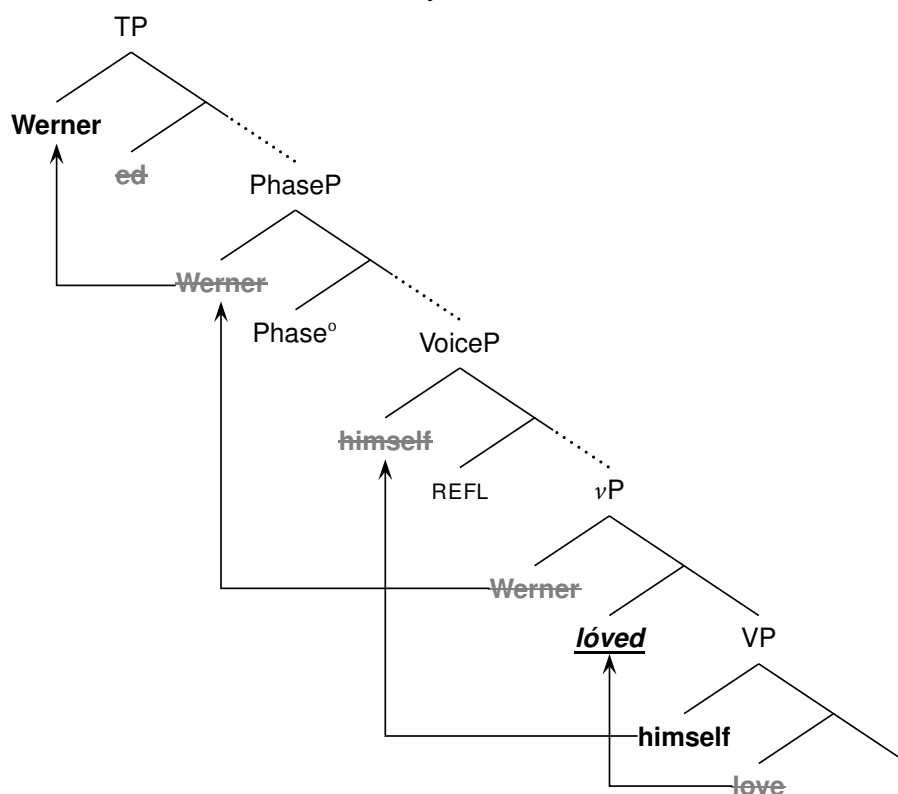

In this derivation, *Werner* and *himself* are externally merged in their thematic positions, in ν P and VP, respectively, satisfying the selectional properties of *love*'s extended projection. after the thematic domain is complete, the REFL Voice^o merges, and its EPP feature attracts the anaphor,

himself, to its specifier.⁴⁸

Shortly after, the Phase head merges, and the subject must stop in its specifier position, so that it is visible to T's features so that it can be drawn up to TP. At this point in the derivation, *Werner* is within the PhaseP and is also the only DP c-commanding the LSOR-reflexive. Because of the nature of the binding relation, this will be the point (approximately) at which binding will be established, leaving *Werner* as the only possible binder of *himself*.⁴⁹

Thus, there are at least three ways to make a derivation with an LSOR reflexive anaphor, which moves to VoiceP, impossible:

(133) **Theoretical Derivation of Descriptive Constraints**

- a. The LSOR-reflexive cannot be separated from VoiceP by an island boundary, because it must move to VoiceP from its base position.
- b. The LSOR-reflexive must have a subject antecedent because only subjects occur high enough in the clause to give the reflexive the correct interpretation.
- c. The LSOR-reflexive cannot have a derived subject as an antecedent, because LSOR-reflexives rely on the Reflexive Voice^o, while derived subjects rely on some other Voice^o.

At this point we should be explicit about what is meant by “derived subject”, as this term is dependent on the framework in which one is working. A derived subject is a phrase in the surface subject position which is hierarchically inferior to some other argument in the thematic domain, and which becomes the minimal candidate to move to subject position via a (non-Active, non-Reflexive) Voice^o (e.g. Passive or Raising-over-Experiencer).

Each of these formal generalizations in (133a–c) derive the descriptive ones at the beginning of this chapter.

⁴⁸Condition C is not violated at this point. A nearly identical structure occurs when an anaphor is the experiencer in a raising clause; e.g., *John seems to himself ~~John~~ to be happy*. The fact that anaphors can sometimes c-command their antecedent (that later moves) is predicted by Sportiche 2011b, which explores the timing of Condition C's evaluation.

⁴⁹The subject stops in a position between the Phase head and the REFL Voice head, putting a copy of the subject and the anaphor in a single Spell-Out Domain such that the former c-commands the latter. Bowers 2001's PredP appears to be the relevant position for many reasons, including the behaviors of reflexive anaphors in small clauses and VP-fronting. This will be returned to in Section 3.7.2.3. This may be necessary if existential closure obligatorily applies in the Semantics at every instance Spell Out, in the same way that the NSR obligatorily applies in the Phonology at every instance of Spell Out.

(3) **Descriptive Condition on Islands**

A reflexive anaphor may bear phrasal stress in a broad focus context, if it occurs in an island that excludes (any copy of) its antecedent.

(4) **Descriptive Condition on Subject-Orientation**

A reflexive anaphor may bear phrasal stress in a broad focus context, if its antecedent is not the subject.

(5) **Descriptive Condition on Derived Subjects**

A reflexive anaphor may bear phrasal stress in a broad focus context, if it occurs in a clause with a derived subject (e.g. a passive clause).

This is a critical advantage of this theory over others. We will come back to these generalizations shortly, in the Section 3.7, where we will turn our attention to one of the most important consequences of this analysis: it accurately predicts the contexts in which reflexives must bear phrasal stress.

Before moving on, we ought to take note that it is critical that the Reflexive Voice^o must be situated in the position where it is within the phase but outside of the thematic domain. If Voice were outside of the phase (or if it were the phase head), movement to its specifier would be movement out of the Spell-Out Domain. Since this is the type of movement that does not feed phrasal stress (see §3.5.2.1), it must be that VoiceP is within the Spell-Out Domain.

Another (in principle) logical possibility is that VoiceP is within the thematic domain – either as a projection that introduces arguments of a certain thematic role (e.g. Agents), or as a projection that is between argument introducers. At this point, we have no strong arguments against these possibilities. However, there are arguments against these approaches for other grammatical Voice^os (e.g. Harley 2013). In addition, in the next chapter, we will see arguments that REFL voice and the agent-introducer must be distinct heads.

This REFL VoiceP analysis has strong empirical support from phrasal stress patterns of English, but there are still some deeper questions that have yet to be answered. First and foremost, why should binding relations be established at the point where the subject is on its way up to sub-

ject position? Under some analyses of reflexivity, one might expect binding to be established at deep structure (i.e. the thematic domain; ν P in (133)), and other others one might expect it to be established at the surface structure representation of the whole sentence.

Second, and more technically, why should REFL attract an anaphor? At this point, our answer is that the movement is to check an EPP feature; but this answer is not a deep one, nor is it one that would survive in a system where EPP feature checking is not a requisite (as in Preminger 2011).

These two questions share a common answer that has to do with the semantics of REFL. Briefly, the height of REFL and the nature of semantic computation will provide the relevant answers to these two questions. This will shown in Chapter 4, in which we further investigate REFL's properties.

3.6.4 Two Predictions

3.6.4.1 Givenness and Interactions with Reflexives

It is too strong to say that extrametrical anaphors are only ever the result of movement to VoiceP. Just like non-reflexive constituents are extrametrical when (relatively) given, reflexive anaphors' extrametricality interacts with givenness as well.

For example, in (134A), *himself* is not given and is predicted to be extrametrical by movement to VoiceP. If (134B) is a follow up to (134A), *himself* is now given, relative to the verb *show*, and it is extrametrical:

(134) A: Drew sáw himself.

B: Yeah, because Carol shówed [Drew himself]_{GR}.

To be clear, the extrametricality of *himself* in (134B) cannot be a result of *himself* moving to VoiceP: this reflexive is bound by an object and so a derivation with REFL Voice would not converge. Instead, the anaphor undergoes Givenness movement, as described in Section 3.4.2.

On the other hand, givenness seems to be able to make even LSOR-reflexives bear phrasal

stress. Consider the example below, where A's comment makes everything in B's reply given, except for *to herself*.

- (135) A: Liz was talking in her sleep.
 B: Yup. [She was talking]_{GR} to hersélf [in her sleep]_{GR}.

In this case, *hersélf* moves up to VoiceP – nothing blocks it. However, it bears phrasal stress because everything else is given and has undergone Givenness movement to a position above VoiceP.⁵⁰ This is predicted because even reflexive anaphors that move to VoiceP are not, by their nature, going to be extrametrical. The entire structural configuration matters, including whether everything else in the clause is higher than VoiceP.

Since the extrametricality of an anaphor can be due solely to givenness, and because an anaphor in VoiceP can bear phrasal stress in the correct discourse context, one must carefully control for context when considering phrasal stress data with reflexives. Failure to do so can lead to the wrong conclusion about the structure.

3.6.4.2 Particle Verbs and Linearization

This structure also makes a prediction, by having the tail of the chain be Spelled Out. This predicts that certain movement operations that re-order an argument with respect to other material will not be visible in the linearization – such movements may only re-place the head of the chain without affecting word order. With particle verbs like *look up* and *throw away*, a typical DP object can occur between the V and particle, or after the particle:

- (136) Q: What happened at the rehearsal?
 A1: The actors used IMDb to look Cary Gránt up. V Óbj Prt
 A2: The actors used IMDb to look up Cary Gránt. V Prt Óbj

⁵⁰We do have to be careful about whether this is simply new information phrasal stress on *hersélf*, or whether it is a focus accent, which has a broader distribution than S-NSR (and our understanding of the structure) obviously predicts.

(137) Q: Tell me something that happens in Harry Potter.

A1: The house-elf throws *the gárbage* out.

V Óbj Prt

A2: The house-elf throws out *the gárbage*.

V Prt Óbj

In both word orders, the DP object is what bears the phrasal stress, meaning whatever movement takes place, it doesn't affect placement of phrasal stress.

Now consider examples where the argument is an anaphor, where the phrasal stress strongly affects acceptability:

(138) Q: What happened at the rehearsal?

A1: The actors used IMDb to look themselves *úp*.

V Refl Prt

A2: # The actors used IMDb to look *úp* themselves.

#*V Prt Refl*

(139) Q: Tell me something that happens in Harry Potter.

A1: The garbage throws itself *óut*.

V Refl Prt

A2: # The garbage throws *óut* itself.

#*V Prt Refl*

The anaphor, which moves to VoiceP, must stay fixed in its position between the verb and the particle, and cannot move away.⁵¹ No matter where the head of the movement chain ends up, the tail will always be between the verb and the particle, and so it will be spelled out there.

Importantly, this word-order phenomenon is constrained by syntax, and does not have to do with prosodic weight constraints on the kinds of things that can move to follow the particle: *itself* is a rather phonologically heavy word, which can bear phrasal stress. In fact, there are even prosodically heavier anaphors, e.g. ones with focus accents, that cannot move to follow the particle either. In these cases, it will again be the syntax of Reflexive VoiceP that disallows that movement. This will be discussed in Chapter 4.

⁵¹This follows Kayne 1985 and den Dikken 1995, among others, in placing the case/thematic position between the verb and the particle. What (136) and (137) show is the object is lower than the particle at Spell Out, no matter the surface word order. This is taken to mean the DP moves to a position following the particle, outside of the Spell Out Domain where phrasal stress is determined, in (136A2) and (137A2). See Ahn *in prep.*.

3.7 Reflexive (Non-)Extrametricity as a Diagnostic

3.7.1 Stress-Bearing Reflexives as Indicative of Structure

As we saw in 3.6.3, there are at least three ways to block a syntactic derivation with a LSOR-reflexive.

(133) **Theoretical Derivation of Descriptive Constraints**

- a. The LSOR-reflexive cannot be separated from VoiceP by an island boundary, because it must move to VoiceP from its base position.
- b. The LSOR-reflexive must have a subject antecedent because only subjects occur high enough in the clause to give the reflexive the correct interpretation.
- c. The LSOR-reflexive cannot have a derived subject as an antecedent, because LSOR-reflexives rely on the Reflexive Voice^o, while derived subjects rely on some other Voice^o.

Let us explicitly discuss how these generalizations can be used to probe structure of clauses containing reflexives.

3.7.1.1 Anaphors inside Island

Let us now turn to some additional data showing the island sensitivity of reflexive anaphor extrametricality. In each of the following examples from (140) to (142), there is an island boundary separating the anaphor from its antecedent, and as a result the anaphor must bear phrasal stress.

- (140) Q: What was all the commotion in the other room?
A1: Jack was loudly encouraging [himself and Dón]. *CSC Island Baseline*
A2: # Jack was loudly encouraging [himsélf and Don].
A3: Jack was loudly encouraging [Don and himsélf].
A4: # Jack was loudly encouraging [Dón and himself]. *#Extrametrical*
- (141) Q: What was all the commotion in the other room?
A1: Jack was loudly encouraging [the executives like Dón]. *Red.Rel. Island Baseline*
A2: # Jack was loudly encouraging [the executives like Don].
A3: Jack was loudly encouraging [the executives like himsélf].
A4: # Jack was loudly encouraging [the executives like himself]. *#Extrametrical*

- (142) Q: What was all the commotion in the other room?
 A1: Jack was loudly encouraging [the men less confident than Dón]. *Adjunct Island Baseline*
 A2: # Jack was loudly encouraging [the men less cónfident than Don].
 A3: Jack was loudly encouraging [the men less confident than himsélf].
 A4: # Jack was loudly encouraging [the men less cónfident than himself]. *#Extrametrical*

In each of these islands, the anaphor can be bound by the subject, but only in case the anaphor bears phrasal stress. Our VoiceP theory predicts this data, because any REFL VoiceP that would cause movement (and subsequent extrametricality) would be outside of these islands where the reflexive anaphor is merged as an argument.

At the same time, there are islands in which reflexive anaphors are extrametrical:

- (143) Q: What will happen on April Fool's Day?
 A1: They will glue Danny to [an actress who dislikes Jáck]. *Rel.Cl. Island Baseline*
 A2: # They will glue Danny to [an actress who dislíkes Jack].
 A3: # They will glue Danny to [an actress who dislikes hersélf].
 A4: They will glue Danny to [an actress who dislíkes herself]. *Extrametrical*

With this VoiceP analysis, we can conclude that these relative clauses are large enough to contain a VoiceP of their own, to which a reflexive anaphor can move and become extrametrical. This is not particularly surprising in this case; relative clauses are known to be structurally very similar to main clauses. That said, this is a result that we can take to less well-understood domains; if we an extrametrical anaphor inside an island (whose extrametricality is not due to givenness), it must be that the island is big enough to contain a VoiceP.

In addition, there are other types of islands such as tensed relative clauses, for which speakers of most dialects of English do not allow the anaphor to be bound by the subject of the main clause, regardless of prosody. Contrast (144) with (140).

- (144) Q: What will happen on April Fool's Day?
 A1: They will glue Danny to [an actress who is jealous of Jáck]. *Rel.Cl. Island Baseline*
 A2: # They will glue Danny to [an actress who is jéalous of Jack].
 A3: # They_i will glue Danny to [an actress who is jealous of thémselves_i].
 A4: # They_i will glue Danny to [an actress who is jéalous of themselves_i]. *#Extrametrical*

The fact that (144A3) is generally ungrammatical but (140A3) is generally grammatical is not a contrast that our REFL Voice analysis makes predictions on. No predictions are made by REFL Voice on the grammaticality of a non-LSOR-reflexive anaphor. This implies that there is at least one additional set of principles that governs their distribution. Perhaps this other set of principles is more like other binding theories explored more commonly in the literature. (This also is briefly discussed in Section 6.2.3 of Chapter 6 and Appendix E.)

3.7.1.2 Non-Subject Bound Anaphors

As established in (4) and (133b), when lacking a local subject antecedent, reflexive anaphors bear phrasal stress. This is exemplified in (145) and (146).

- (145) Q: What did Wesley just do?
 A1: Wesley locked his bike to a tr  e. *Baseline*
 A2: # Wesley locked his b  ke to a tree.
 A3: Wesley locked his bike to itself.
 A4: # Wesley locked his b  ke to itself. *#Extrametrical*
- (146) Q: What did I miss from the last episode?
 A1: Liz’s actions pitted Jack against Devon. *Baseline*
 A2: # Liz’s actions pitted Jack against Devon.
 A3: Liz’s actions pitted Jack against himself.
 A4: # Liz’s actions pitted Jack against himself *#Extrametrical*

In addition, this is also observable in obligatorily object-bound contexts. If the *of*-PP argument of *remind* contains a reflexive anaphor, it must be bound by the object. This is likely for semantic/pragmatic reasons, as *I remind Bill of myself* is not something whose meaning is clear in out-of-the-blue contexts. For that reason, it is expected that, when it does have a reflexive anaphor (which will be obligatorily object bound), it will bear phrasal stress.

(147) Obligatory Object-Oriented Anaphors

Q: Tell me something about the characters on this show.

A1: Janet reminds Criss of Jenna.

Baseline

A2: # Janet reminds Criss of Jenna.

A3: Janet reminds Criss of himself.

A4: # Janet reminds Criss of himself.

#Extrametrical

This reinforces the analysis that the position to which reflexives move, VoiceP, must be such that only a subject can bind the moving reflexive.

Under this analysis, the subject property is only a matter of the structural position of a constituent, and not its thematic role or prominence, per se. This allows us to probe the structures of predicates like *show*, in which the first object has been sometimes argued to be a subject of a small clause.

(148) Bev showed Jack her clipboard = Bev CAUS [Jack [SEE her clipboard]]

This raises a question: if *Jack* is the subject of *SEE*, is it a subject in the relevant structural sense?

(149) Q: What happened before the meeting?

A1: Bev showed Jack her clipboard.

Baseline

A2: # Bev showed Jack her clipboard.

A3: Bev showed Jack himself.

A4: # Bev showed Jack himself.

#Extrametrical

Though there may be some definitions of subject (e.g., specifier of some predicate) which allow *Jack* in (149) to be construed as a subject, that is not the definition of subject that LSOR attends to. Specifically, if *show* is to be structurally interpreted as *CAUS+SEE*, there is not a Voice head between the *CAUS* head and the *SEE* head, such that an anaphor could move to it and be bound by *Jack*. (Similarly for (145)–(147).) The fact that *himself* bears phrasal stress in (149) can be used to refine the analysis in (148).

In Section 3.7.2.3, we will see that some data have been given analyses very similar to (148), while do allow extrametricality of the anaphors. This indicates structural differences between phenomena that in the past have been similarly analyzed, and allows us to make new conclusions about a range of structures. In particular, it must be that small clauses like (148) lack a VoiceP, but

other small clauses have one.

3.7.1.3 Passive-Voice and Raising-Voice Clauses

This analysis of the syntax of reflexive anaphors requires that, in order to be extrametrical, there must be a REFL head which draws the reflexive up, and which blocks the merging of other grammatical voices, such as passive. We noted this in (133c) to derive (5). This is why the Passive (150) allows *herself* to bear phrasal stress in a way in which the Reflexive (151) does not:⁵²

- (150) Q: What will happen on April Fool's Day?
A1: Danny will get glued to Jáck. Baseline
A2: # Danny will get glúed to Jack.
A3: Danny will get glued to himsélf.
A4: #? Danny will get glúed to himself. #Extrametrical
- (151) Q: What will happen on April Fool's Day?
A1: # Liz will glue Danny to hersélf.
A2: Liz will glue Dánnny to herself. Extrametrical

This is taken as evidence against analyses where 'surface subject' is a relevant and sufficient formal object for licensing LSOR anaphors.⁵³ Instead of relying upon a definition that makes explicit reference to the grammatical role of its antecedent, this theory derives this pattern because REFL and PASS compete for the same structural position: Voice^o.

Surface subjecthood is also insufficient for licensing LSOR in other cases, beyond passives. Raising-over-experiencer predicates such as *seem* and *appear* behave similarly with the experiencer argument. In English, this is manifested by the fact that reflexive anaphor experiencers in

⁵²On the other hand, (150A4) is not as bad as #*Liz glued Dánnny to himself*. This is not predicted by these descriptive generalizations, but perhaps this can fall out from something else. For example, perhaps this has to do with adjectival passive structure, where there is not a passive voice, but instead the clauses are being treated as some kind of resultative adjective phrase. We have seen that reflexive complements of APs can be extrametrical, in (41). Alternatively, perhaps this has to do with discourse information such that the anaphor is given in (150A4) in a way that it is not given in #*Liz glued Dánnny to himself*. Whatever the underlying cause, what is important is the contrast between (150A3) and (151A1).

⁵³Past attempts at ruling out LSOR derivation with passives, as in (150A4), include Burzio 1986 and Rizzi 1986a. These analyses fail, because they assume (i) LSOR binding takes place in deep-structure only, and (ii) subjects of reflexive clauses are merged in the surface subject position (i.e. they are not moved there from a VP-internal position). I will not discuss this in greater detail; see Sportiche 2010.

such clauses can bear phrasal stress, and are not extrametrical.

In order to consider the prosodic behavior of the experiencer argument, we will have to attend to non-sentence-final phrasal stress, which are typically more difficult to perceive.⁵⁴ However, in this case, the sentence forms to two prosodic phrases with phrasal stress, which makes it somewhat easier. The judgments for this are very robust.

- (152) Q: Tell me something about Jack.
A1: [He seems to Náncy] [to have chánged]. *Baseline*
A2: # [He séems to Nancy] [to have chánged].
A3: [He seems to himsélf] [to have chánged].
A4: # [He séems to himself] [to have chánged]. *#Extrametrical*

We see here that the reflexive experiencer bears stress in the same way as the name *Nancy*. We can also rule out the possibility that the experiencer must bear phrasal stress, by turning to weak pronouns:

- (153) a. Tell me something about Nancy.
b. # [Jack seems to hér] [to have chánged].
c. [Jack séems to her] [to have chánged]. *Extrametrical*

Pronouns can be extrametrical in this position, but reflexive anaphors cannot. (Recall that extrametrical pronouns distribute differently than extrametrical reflexives; see §3.3.3.)

The main clause subject, *Jack*, can bind the main clause experiencer, *himself*, but when it does, *himself* bears phrasal stress. This indicates the reflexive anaphor does not move to VoiceP, despite having a local subject antecedent. This implicates that a non-Reflexive Voice^o is merged in the (153), blocking movement of the reflexive to VoiceP.

This implicates a (Passive-like) Raising Voice^o for structures with raising over an experiencer. There are striking similarities between raising over an experiencer predicates and passives (the logical subject of a predicate is ‘demoted’ into an oblique PP, and a structurally lower argument is raised into subject position), which has led to the two being derivationally related (see Collins

⁵⁴Sentence-final experiencers are not used, because they do not seem to allow the matrix subject to bind them, at all:
**He seems to have changed to himself.*

2005a,b). Even stronger evidence for a Passive-like Raising Voice comes from Orfitelli 2012, which shows (i) that passives and raising over experiencer structures are both rather late in a child's language development, and (ii) children acquire the two simultaneously (even observable within-child), while (iii) other raising structures are acquired much earlier. In short, the development of raising over experiencer syntax is time-locked with the development of passive syntax.

Given the parallels in structure and grammatical development between passive and raising-over-experiencer predicates, it is not surprising that the two should also share similar behaviors with regard to reflexives and extrametricality. In particular, the analysis set forth here is that all these parallels are due to the fact that Passive and Raising (over an Experiencer) structures involve non-Active, non-Reflexive Voice heads. Thus, passive and raising-over-experiencer clauses will have stress-bearing reflexives, even in otherwise local subject-bound reflexivity contexts, for the same reason: Reflexive Voice cannot merge and attract the anaphor.

3.7.1.4 Depth of Embedding and Phrasal Stress

At this point, we have established an answer to all of the puzzles that we began this chapter with, by adopting the S-NSR and a definition of depth of embedding, repeated below:

(99) **Structure-Based Phrasal Stress Rule (S-NSR):**

The most deeply embedded constituent in a Spell-Out Domain receives the phrasal stress.

(100) **Depth of Embedding:**

A syntactic object, X, is more deeply embedded than some other syntactic object, Y, provided that no copy of X c-commands all copies of Y

While there is resounding support for the fact that syntactic structure (beyond word order) is the input to the phrasal stress rule (Cinque 1993, Zubizarreta 1998, Kratzer and Selkirk 2007, Kahnemuyipour 2009). However, some (e.g., Kratzer and Selkirk 2007 and Kahnemuyipour 2009) have argued that it is in fact the least embedded element of a Spell-Out Domain that receives phrasal stress.

We can affirm the theory in (99), where the most embedded syntactic object is relevant, by

considering non-subject bound anaphors. These non-subject bound anaphors need an antecedent which c-commands them to be licensed, explaining the contrast in (154):⁵⁵

- (154) a. Wesley locked his bike to itself.
b. *Wesley locked himself to his bike.

This means the anaphor is more embedded than the antecedent – the antecedent c-commands the anaphor, and our definition of depth is built upon c-command in this way.

As we have already seen, in cases like (154a), the anaphor is what bears phrasal stress:

- (145) Q: What did Wesley just do?
A1: Wesley locked his bike to a trée. *Baseline*
A2: # Wesley locked his bíke to a tree.
A3: Wesley locked his bike to itsélf.
A4: # Wesley locked his bíke to itself. *#Extrametrical*

Since binding properties establish that the non-moving *itself* in (154) is more embedded than *his bike*, it must be that most deeply embedded constituents bear phrasal stress – not least embedded ones.

3.7.2 Extrametrical Reflexives as Indicative of Structure

Having established the syntax of reflexivity when the anaphor is extrametrical, let us return now to a broader set of data for analysis. We can use extrametricality as a diagnostic for the structure, at times illuminating properties of derivation that have been controversial in the past.

Movement to VoiceP, which derives binding properties of LSOR anaphors, is what underlies the extrametricality of reflexive anaphors. We can apply this finding to a range of grammatical contexts in which the syntax of reflexivity is (potentially) controversial, and draw conclusions about the proper analysis. In one particular example that we will review, the data will show that semantic coargumenthood is not a factor in ability to move to VoiceP; thus, licensing those anaphors

⁵⁵C-command, not precedence, can account for this contrast as well as the following grammatical sentence: “*To itself, Wesley locked his bike.*”. Precedence can only be used to account for this example, if we consider precedence at earlier stages of the derivation, precedence between all copies, or something to this effect. See Bruening 2014.

that undergo this movement must not be constrained by semantic coargumenthood.

3.7.2.1 Other Subordinate Clauses

At this point, we have seen that not all subjects can license reflexive extrametricality. (For example, subjects of passives cannot.) One may wonder whether the range of unpronounced subjects found in subordinate clauses are like ‘ordinary’ subjects, or like passive subjects, in their ability to license LSOR extrametricality.

First, we will consider some subordinate clauses with adjunct properties, such as temporal adjunct clauses:

(155) Temporal Adjunct Clauses

Q: What happened during the fourth hour of the Today show?

A1: Jenna Maroney cut her hair after promoting *her shów*.

Baseline

A2: # Jenna Maroney cut her hair after *promóting* her show.

A3: # Jenna cut her hair after promoting *hersélf*.

A4: Jenna cut her hair after *promóting* herself.

Reflexive

The fact that *herself* can be extrametrical in (155A4) indicates that it has moved to a position higher than *promoting*. This cannot be because *herself* is moving to VoiceP of the main clause to be bound by the matrix *Jenna Maroney*, because these temporal adjunct clauses are islands:

(156) *What did Jenna Maroney cut her hair [after promoting ___]?

As such, the extrametricality of *herself* in (155A4) must be due to movement within the island. This indicates that temporal adjunct clauses, even when appearing to lack finiteness and a pronounced subject, may contain a REFL VoiceP to which *herself* can move and be bound.

Similar results can be found for a range of adjunct subordinate clauses, including relative clauses and purposive clauses:

(157) Relative Clauses

Q: Tell me about one of your new sketch characters.

A1: Mayor McCheese is an anthropomorphic hamburger that eats frénch fries. *Normal*

A2: # Mayor McCheese is an anthropomorphic hamburger that éats french fries.

A3: # Mayor McCheese is an anthropomorphic hamburger that eats itsélf.

A4: Mayor McCheese is an anthropomorphic hamburger that éats itself. *Reflexive*

(158) Purposive Clauses

Q: What happened during the fourth hour of the Today show?

A1: Jenna Maroney cut her hair in order to promote her shów. *Baseline*

A2: # Jenna Maroney cut her hair in order to promóte her show.

A3: # Jenna cut her hair in order to promote hersélf.

A4: Jenna cut her hair in order to promóte herself. *Reflexive*

As with the temporal adjunct clause before, both the relative and purposive clauses are islands, as

(159) shows, and the anaphor is still extrametrical.

(159) a. *What is Mayor McCheese an anthropomorphic hamburger [that eats ___]?

b. *What did Jenna Maroney cut her hair [in order to promote ___]?

We can conclude that *herself* moves to a VoiceP in the adjunct clauses, and is bound by a silent subject in that VoiceP's clause. Moreover, each of these three adjunct clauses appears with a different form of the verb (ACC-*ing*, finite, and infinitival, respectively), but all of these clauses must include a Reflexive Voice.

In addition to adjunct clauses like those above, complement clauses of nouns exhibit similar properties:

(160) Finite Nominal Complements

Q: What did Andrea announce at the meeting?

A1: Andrea announced [her belief that Gavin had embarrassed the stáff]_F. *Baseline*

A2: # Andrea announced [her belief that Gavin had embárrased the staff]_F.

A3: # Andrea announced [her belief that Gavin had embarrassed himsélf]_F.

A4: Andrea announced [her belief that Gavin had embárrased himself]_F. *Reflexive*

(161) Non-finite Nominal Complements

Q: What happened when after the show came back from hiatus?

A1: Liz left the writers some instructions to justify their choices. *Baseline*

A2: # Liz left the writers some instructions to jústify their choices.

A3: # Liz left the writers some instructions to justify themsélves.

A4: Liz left the writers some instructions to jústify themselves. *Reflexive*

As with the adjunct clauses, these clauses are islands as well, as (162) shows, and the anaphor is still extrametrical in all cases.

- (162) a. *Who did Andrea announce her belief [that Gavin had embarrassed ___]?
b. *What did Liz leave the writers some instructions [to justify ___]?

Regardless of whether the clause is finite with a pronounced subject, or non-finite with an unpronounced subject, there must be a subject and a VoiceP within these nominal complement clauses.

In each of these, the reflexive anaphor is extrametrical, implicating that the structure of those subordinate clauses is large enough to allow movement to a Reflexive VoiceP.

3.7.2.2 Control, Raising, and ECM Predicates

There are observable structural differences between clauses embedded by raising predicates and control predicates. Perhaps one of those differences is whether the embedded clause can license movement to VoiceP by a reflexive. In each of the examples below, whether the embedding predicates was raising or control had no impact on whether a reflexive in the embedded predicate could be a LSOR-reflexive.

- (163) Object of Clause Embedded by a Raising to Subject Predicate
Q: What happened when after the show came back from hiatus?
A1: Lutz now appears to disgust *Fránk*. *Baseline*
A2: # Lutz now appears to *disgúst* Frank.
A3: # Lutz now appears to disgust *himsélf*.
A4: Lutz now appears to *disgúst* himself. *Reflexive*
- (164) Object of Clause Embedded by an ECM Predicate
Q: What happened when after the show came back from hiatus?
A1: Jenna now expects Lutz to disgust *Fránk*. *Baseline*
A2: # Jenna now expects Lutz to *disgúst* Frank.
A3: # Jenna now expects Lutz to disgust *himsélf*.
A4: Jenna now expects Lutz to *disgúst* himself. *Reflexive*
- (165) Object of Clause Embedded by a Subject Control Predicate
Q: What happened after the restaurant closed?
A1: Chef Chros tried to reinvent *hót-dogs*. *Baseline*
A2: # Chef Chros tried to *reinvént* hot-dogs.
A3: # Chef Chros tried to reinvent *himsélf*.
A4: Chef Chros tried to *reinvént* himself. *Reflexive*
- (166) Object of Clause Embedded by an Object Control Predicate
Q: What happened after the restaurant closed?
A1: Ms. Lemon asked Chef Chros to reinvent *hót-dogs*. *Baseline*
A2: # Ms. Lemon asked Chef Chros to *reinvént* hot-dogs.
A3: # Ms. Lemon asked Chef Chros to reinvent *himsélf*.
A4: Ms. Lemon asked Chef Chros to *reinvént* himself. *Reflexive*

Though the embedded clauses above lack a pronounced subject, and the various types of clauses have been argued to differ structurally, it must be that they all contain a VoiceP for the reflex-

ive anaphor to move to, and that the different subject types are all able to license this VoiceP-movement.

One historically contested point about the difference between object control and ECM predicates has been the position of the apparent object of the OC/ECM predicate. Namely, it has been claimed that object control objects are in the higher structure (in the upstairs clause), as true objects, but ECM ‘objects’ are in fact in the subject position of the embedded clause. This has contributed to the formulations of certain theories of binding - specifically those whose binding domain references argument structure of a single predicate, such as Pollard and Sag 1992 *et seqq* and Reinhart and Reuland 1993 *et seqq*.⁵⁶

(167) Reflexive ‘Object’ for Object Control Predicate

Q: It is difficult to read Japanese.

A1: Yes, but Mary successfully taught her students [to read Japanese]_G.

A2: # Yes, but Mary successfully taught her students [to read Japanese]_G.

A3: # Yes, but Mary successfully taught hersélf [to read Japanese]_G.

A4: Yes, but Mary successfully taught herself [to read Japanese]_G.

It would seem difficult to use phrasal stress to probe the depth of the object in an object control predicate; phrasal stress applies to the most embedded constituent, and object control predicates always have clausal complements that are deeper than their nominal complement. However, if we make the clausal complement given information, it will move to be less embedded than the nominal complement. (See Section 3.4.2.) Since the nominal complement *hersélf* in (167) doesn’t bear stress, we obtain the result that *hersélf* is higher than *taught*. This leads to the conclusion that *hersélf* moves to VoiceP of the upstairs clause, where it can be bound by the subject *Mary*, just

⁵⁶In fact, existing accounts of exemption/logophoricity in both of these frameworks are inadequate and don’t cover the whole range of where exempt anaphors can/cannot exist. For example, exempt anaphors seem to be predicted fine in **Ken’s mother likes the picture of himself*, despite its ungrammaticality. Also, Reinhart and Reuland 1993 would predict that ECM predicates should use exempt anaphors (since there is not semantic reflexivity in the predicate), but this prediction is not borne out, as discussed by Fox (1993). Reuland 2011 attempts to address the issue of ECM predicates, but essentially reduces the problem to a stipulation that SELF moves up to the verb that has as an argument the anaphor’s antecedent, thereby allowing the anaphor and the antecedent to be coarguments of a predicate. This is problematic in several ways; first, this amounts to the type of underived stipulation that we are trying to avoid. Second, and more problematically, it incorrectly predicts object-bound anaphors in ditransitives will involve SELF movement. This dissertation shows that reflexive movement critically does not occur when object-bound.

like other anaphoric complements of non-control predicates. This is sketched out in (168).

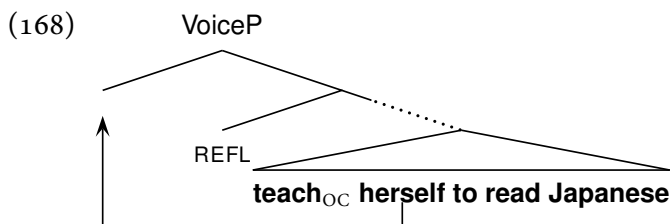

Similarly, we can probe the position of the apparent object of the ECM predicates. Again, givenness is used to make it feasible to use phrasal stress to probe the position of a constituent that is rather high in the structure.

(169) Reflexive ‘Object’ for ECM Predicate

Q: The game is difficult to win.

A1: Yes, but Mary expects ***her opponent*** [to win it]_G.

A2: # Yes, but Mary ***expects*** her opponent [to win it]_G.

A3: # Yes, but Mary expects ***herself*** [to win it]_G.

A4: Yes, but Mary ***expects*** herself [to win it]_G.

In the same way as (168), the reflexive behaves as though it moves to the main clause’s VoiceP. Since binding takes place while the LSOR anaphor is in VoiceP, it is clear that binding of an ‘object’ (regardless of what predicate introduces it) takes place in the same way for Object Control predicates (e.g., (168)) and ECM predicates (e.g., (169)).

This means that the subject of the embedded clause, *herself*, must move to the VoiceP of the higher clause to be higher than *expect*.⁵⁷ This is sketched out below.

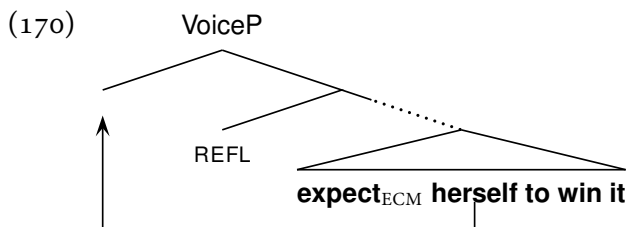

If *herself* remained as the in situ subject of the infinitival clause, a sentence in which *herself* bears phrasal stress, (169A3), should be deemed equally acceptable as (169A1) – contrary to fact. We

⁵⁷It cannot be that the extrametricality of *herself* in (169A4) is the result of movement to a VoiceP in the embedded clause. This would not make *herself* less embedded than the ECM predicate, *expect*.

can conclude that the anaphoric subject of a complement clause of an ECM predicate behaves identically to the anaphoric object of a Object Control predicate, in that both move to the VoiceP of the upstairs predicate.

3.7.2.3 Small Clauses

Resultative Clauses

Consider now a context where reflexive anaphor appears as the subject of an embedded small clause. Is it that these anaphors are bound in situ, or do they move up to VoiceP of the main clause, as they did when subject of an ECM clause? As before, we will use givenness to explore the position of a constituent that is high in the structure. Let us begin by considering a sentence with a non-reflexive constituent, *a rocket*, as the subject of the resultative small clause:

(171) Subject of a Resultative Clause

Q: Why is there a trail of smoke going across the canyon on this episode of Looney Toons?

A1: Wile E. Coyote shot a r**ó**cket [across the canyon]_G. *Baseline*

A2: # Wile E. Coyote sh**ó**t a rocket [across the canyon]_G.

Here, *a rocket* bears phrasal stress. This should be taken as evidence that a non-reflexive subject of the resultative clause is more deeply embedded than the upstairs verb (*shoot*, in this case), and illuminating the position of resultative clauses, relative to the verb.

(172)

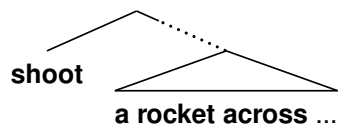

Simple constituency tests corroborate this structure. For example, the small clause cannot “survive” *do so* replacement – *He did so* (**across the canyon*); this is a property of complements. Along side other facts, this has led to the standard analysis of resultative clauses having the same basic configuration (e.g., Marantz 1989, Hale and Keyser 1993, den Dikken 1995, Bowers 2001, Embick 2004).

On the other hand, when the small clause subject is a reflexive anaphor and the predicate is

given and extrametrical, the anaphor is also extrametrical:

(173) Q: Why is there a trail of smoke going across the canyon on this episode of Looney Toons?

A1: # Wile E. Coyote shot *himself* [across the canyon]_G.

A2: Wile E. Coyote *shót* himself [across the canyon]_G. *Reflexive*

This extrametricality of the anaphor indicates that it has moved higher than the verb. We will conclude from this that reflexive subjects of resultative small clauses move to VoiceP, when possible – just like other reflexive objects.

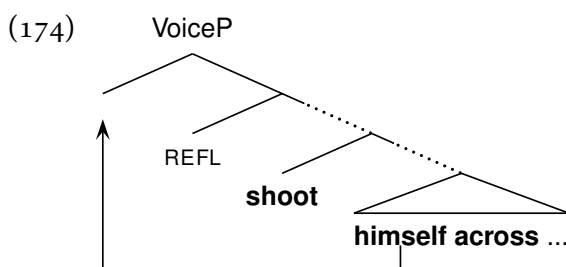

To be clear, binding the subject of a resultative small clause is very much like the binding of a direct object of a prototypical monotransitive verb, and even more like the binding of the subject of a downstairs clause in an ECM predicate.⁵⁸ This is perhaps unsurprising, given the fact that resultative clause subjects can also become main clause subjects in a passive (e.g. *A rocket was shot across the canyon*), just like objects of a monotransitive verb or subject of the complement of an ECM predicate.

We can similarly look at “fake reflexive” (FR) constructions, which are a sub-type of resultative predicates in which the subject must be a reflexive anaphor. For this reason, we can’t directly compare anaphors with other NPs, so instead we will manipulate the givenness of the resultative predicate:⁵⁹

(175) “Fake Reflexive”

⁵⁸In addition, (173A2) indicates that the given resultative predicate has moved higher than the upstairs verb, and not just to some position higher than the resultative subject.

⁵⁹Moreover, assuming that the subject of FR resultatives is in the same position(s) as the subject of normal resultatives (like (171)), we don’t need to look at other NPs in this position – we already know that such a position is in principle a position in which phrasal stress may fall.

Q: Why does Jenna's voice sound so off-key?

A1: She and the rest of the choir screamed themselves hoarse.

Baseline

A2: # She and the rest of the choir screamed themselves hoarse.

A3: # She and the rest of the choir screamed themselves hoarse.

(176) Q: Why does Jenna's voice sound so hoarse?

A1: # She and the rest of the choir screamed themselves [hoarse]_G.

A2: # She and the rest of the choir screamed themselves [hoarse]_G.

A3: She and the rest of the choir screamed themselves [hoarse]_G.

Extrametrical

The pattern in (175) indicates that the FR predicate (*hoarse*, in this case) is more deeply embedded than the main predicate (*scream*) and the reflexive anaphor. In addition, (176) indicates that a given constituent moves to a position higher than the main predicate (for relative givenness, in Wagner's terms); it also indicates that the anaphor is moving to a position higher than the main predicate: to VoiceP under our analysis. This means that binding a FR anaphor subject of a small clause is no different than binding of a typical direct object reflexive, and FR small clauses share the same structure as other resultatives – at least, their structures can both be characterized as (174).

It would seem that the only difference is that the FR small clauses must co-occur with the reflexive VoiceP in the main clause, in order to rule out any non-reflexive subject of the resultative. This could either be due to the pragmatic properties of such FR-embedding predicates (e.g., it is not logically possible to scream someone else hoarse), and/or it could be that FR-embedding predicates are structurally more complex in nature (e.g., lexicalizing a stretch of structure including the REFL Voice).

Other Small Clauses At this point, we have established that subjects of resultative clauses can move out of the resultative clause up to VoiceP of the upstairs predicate. We may now wonder if the resultative clause itself may contain a REFL VoiceP. Consider the following example:

- (177) Resultative PP Small Clause Subject Antecedent
- Q: What is that noise coming from the kitchen?
- A1: The butler is stacking the dishes on top of the póts. *Baseline*
- A2: #The butler is stacking the dishes on tóp of the pots.
- A3: #The butler is stacking the dishes on top of themsélves.
- A4: The butler is stacking the dishes on tóp of themselves. *Reflexive*

Since the subjects of the small clauses count as a subject in the sense of our descriptive condition on subject orientation, (4), and we derived that condition with REFL VoiceP, it must be that resultative small clauses are big enough to include a REFL VoiceP.⁶⁰ This is unlike the small clause we saw earlier with *show* in (148), indicating that some “ditransitive” verbs (e.g. *stack*) involve a complement containing a VoiceP and others (e.g. *show*) do not. We can thus use the availability of reflexive extrametricality to illuminate where REFL, and thus Voice^o more generally, merges.

In other types of small clauses, besides resultatives, the reflexive is extrametrical when bound by the small clause subject.

- (178) VP Small Clause Subject Antecedent
- Q: What happened after Jenna left?
- A1: Pete saw Liz embarrass Pául. *Baseline*
- A2: #Pete saw Liz embárrass Paul.
- A3: #Pete saw Liz embarrass hersélf.
- A4: Pete saw Liz embárrass herself. *Reflexive*
- (179) ACC-ing VP Small Clause Subject Antecedent
- Q: What happened after Jenna left?
- A1: Pete saw Liz embarrassing Pául. *Baseline*
- A2: #Pete saw Liz embárrassing Paul.
- A3: #Pete saw Liz embarrassing hersélf.
- A4: Pete saw Liz embárrassing herself. *Reflexive*

⁶⁰Toman 1991 includes data in which anaphors in this situation cannot be the LSOR-reflexive marker, taking this as evidence that *the dishes* in this kind of sentence is not a subject. However, Czech (and other similar languages) employ clitic LSOR-reflexive markers, which can only cliticize to verbal elements, and not elements like prepositions or adjectives. It is for that reason that a LSOR-reflexive is ruled out, and not because *the dishes* is not a subject. For further discussion of how REFL VoiceP extends to other languages, see Chapter 5.

(180) AP Small Clause Subject Antecedent

Q: What happened during the writer's meeting yesterday?

A1: Jenna made Patrice proud of his joke.

Baseline

A2: # Jenna made Patrice próud of his joke.

A3: # Jenna made Patrice proud of himsélf.

A4: Jenna made Patrice próud of himself.

Reflexive

The consensus in the literature on small clauses is that the subject of the small clause predicate is introduced in its normal thematic position (e.g., Marantz 1989, Hale and Keyser 1993, den Dikken 1995, Bowers 2001, Embick 2004). Because the anaphors become extrametrical within these clauses, it must be that these small clauses are larger than the thematic domain; large enough to contain a REFL VoiceP. Minimally, this makes *make Patrice proud of himself* have a structure like the following:

(181) *make Patrice proud of himself* (Preliminary)

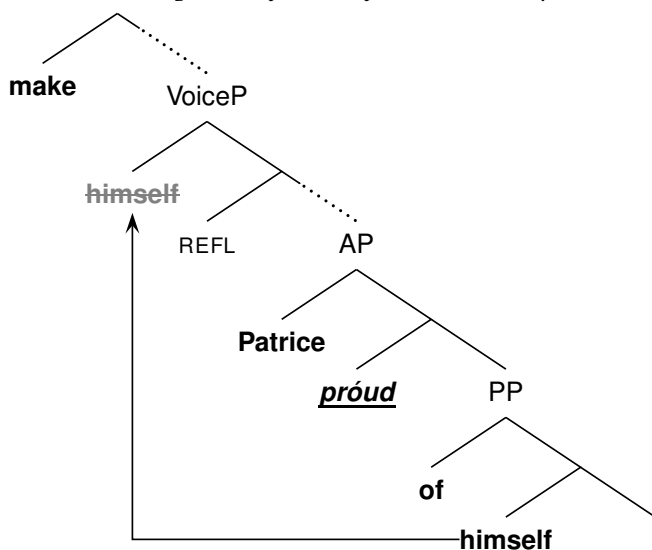

We will return to this structure with more detail shortly.

Moreover, the extrametricality of these anaphors does not depend on their antecedent remaining a non-derived, syntactically local subject throughout the derivation.

- (182) Antecedent as Passivized Subject of a PP Small Clause
 Q: What is that noise coming from the kitchen?
 A1: The dishes are being stacked on top of the póts. *Baseline*
 A2: #The dishes are being stacked on tóp of the pots.
 A3: #The dishes are being stacked on top of themsélves.
 A4: The dishes are being stacked on tóp of themselves. *Reflexive*
- (183) Antecedent as Passivized Subject of a VP Small Clause
 Q: What happened after Jenna left?
 A1: Liz was seen embarrassing Pául. *Baseline*
 A2: #Liz was seen embárrassing Paul.
 A3: #Liz was seen embarrassing hersélf.
 A4: Liz was seen embárrassing herself. *Reflexive*
- (184) Antecedent as Passivized Subject of an AP Small Clause
 Q: What happened during the writer's meeting yesterday?
 A1: Patrice was made proud of his jóke. *Baseline*
 A2: #Patrice was made próud of his joke.
 A3: #Patrice was made proud of himsélf.
 A4: Patrice was made próud of himself. *Reflexive*

Critically, this demonstrates that it is not appropriate to evaluate our subject-orientation and derived-subject constraints in terms of local/derived subjecthood at the end of the derivation. Instead, in passive examples like (182)–(184), there is an point during the progression of derivation at which the conditions imposed by REFL are met (i.e. within the small clause, before passivization in the matrix clause).

Subjects and Binding in Small Clauses

What the passivization facts indicate is that there is a subject position within the small clause, at which point the binding by the local subject takes place. (This was already implicated by our finding that there is a VoiceP within the small clause.) Given our analysis of local subject binding in 3.6.3, small clauses must be slightly larger in order to accommodate a position for the subject binder that is above VoiceP. Bowers 2001 provides an analysis of small clauses that will allow this. Under this analysis, small clauses subjects are in the specifier of the same kind of phrase, PredP, which allows for coordinations like the following, in which the predicates are of different syntactic

categories:

- (185) a. She got [_{PredP} Kathy sober] and [_{PredP} Devon in a taxi].
 b. Ken saw [_{PredP} Ron embarrass himself] and [_{PredP} Floyd on the floor laughing].

Additionally, expletives can appear as its specifier of PredP:

- (186) a. Mr. Jordan watched [_{PredP} it rain outside].
 b. Bijou made [_{PredP} there be a party in our honor].

This implicates that PredP is not within the thematic domain, but outside of it, and the subject raises to PredP.

Having established these facts about PredP, we are now in a position to revise our previous structure for *make Patrice proud of himself*.

- (187) *make Patrice proud of himself* (Finalized)

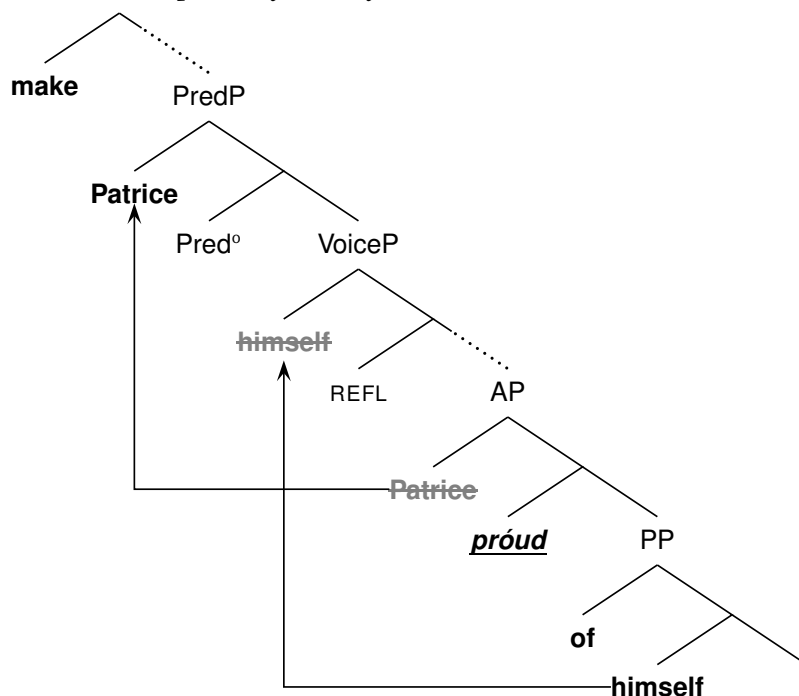

It is this PredP position which allows the subject to bind the anaphor, even if the subject moves away from being the local subject (e.g., in passivization like (184)).

PredP Beyond Small Clauses

Bowers argues that even clauses without obvious small clauses have small clause structure (i.e. a

PredP). He argues that PredP – which is below T, Neg, Auxiliaries and Modals is what fronts in VP topicalization.⁶¹

- (188) a. Praised by Jenna, Liz’s work would have been, if there had been time.
 b. *Been praised by Jenna, Liz’s work would have, if there had been time.
 c. *Have been praised by Jenna, Liz’s work would, if there had been time.

Given this analysis, the interpretation of the anaphors in (189) and (190) differ, as discussed in Huang 1993:

- (189) a. Liz₁ knew that Jenna₂ would [_{PredP} ~~Jenna₂~~ praise herself_{2/*1}].
 b. Liz₁ knew that, [_{PredP} ~~Jenna₂~~ praise herself_{2/*1}], Jenna₂ would.
 (190) a. Liz₁ knew that Jenna₂ would dismiss [_{DP} some rumor about herself_{2/*1}].
 b. Liz₁ knew that, [_{DP} some rumor about herself_{1/2}], Jenna₂ would dismiss.

In (190), many dialects of English allow *herself* to be bound by either *Liz* or *Jenna* in (190b), but only allow it to refer to *Jenna* in (190a).⁶² In those same dialects, *herself* always refers to *Jenna* in (189), regardless of movement. Huang and Bowers argue that this is because there is a trace of the subject binder which always intervenes between the anaphor and any other higher DP only when there is VP fronting – not in other cases of topicalization, like (190).

A VoiceP analysis maintains the generalizations of Huang and Bowers, and unifies it with the fact that the cases of VP topicalization like (189) involve extrametrical reflexive anaphors. The reason the antecedent is fixed in VP topicalization is that VoiceP is contained within PredP, where LSOR binding properties are established. To be clear, in Section 3.6.3, the subject position that was relevant was the subject moving through the phase edge (which may be problematic under some accounts). At this point, we see that the relevant subject position is even more local to the anaphor in VoiceP: when the subject passes through the PredP. The analysis in (191) supercedes the one in (132).

⁶¹ PredP is above participial morphemes, *-ing* and *-en*, given that small clauses verbs may have participial morphology. This is precisely what (Sailor 2014:Ch.4) argues for VP topicalization. That the subject occurs in this position has independent support from Harwood 2013’s findings about the position of external argument subjects in Transitive Expletive Constructions.

⁶² There are dialects where both are the same: *herself* can be bound by *Liz* in both case or neither.

(191) Structure for *Werner loves himself* (Revised)

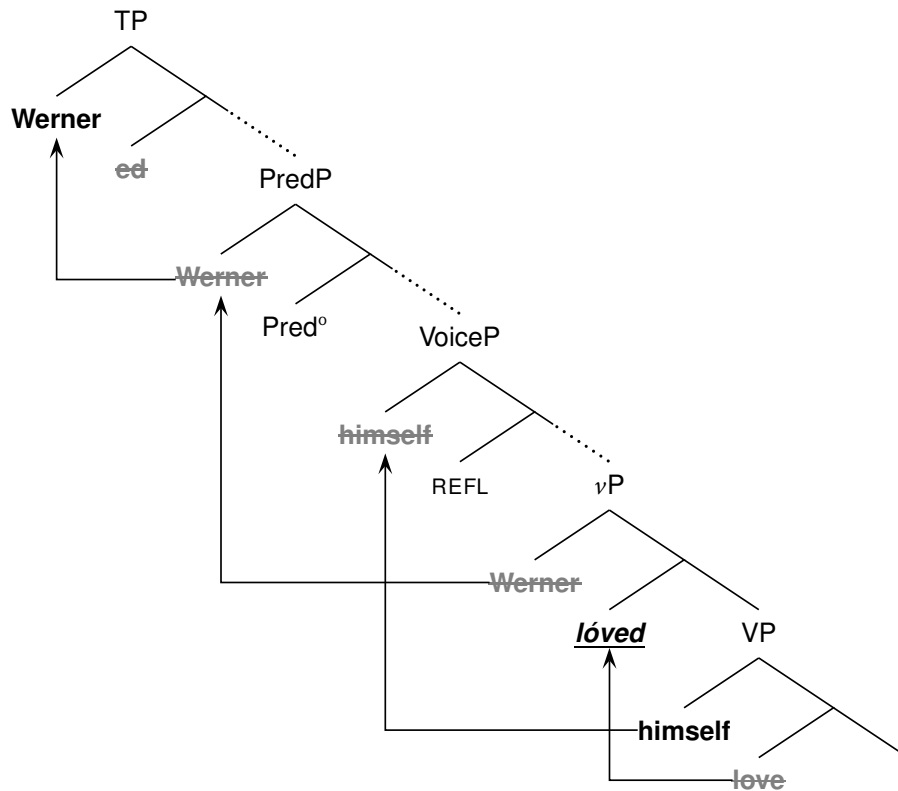

The only revision to (132) that we have made is that there is a PredP in which the subject sits. It is not clear, based on the current data, whether there is a phase between PredP and TP, or whether PredP is the phase. We will return to this issue in Chapter 4, where data suggests that PredP is within the same Spell Out Domain as VoiceP.

Summary

Small clauses reveal three important generalizations. First, there are a range of small clauses that are large enough to contain a (REFL) VoiceP, but not all small clauses are. Second, we require an approach in which the conditions on LSOR anaphors are evaluated at intermediate stages of the derivation. Third, there is a PredP in all clauses (small and larger), which is the relevant subject position for binding in REFL Voice structures. Finally, the binding of the LSOR anaphor obligatorily occurs at an intermediate point in the derivation, when the LSOR anaphor is in VoiceP and the subject is in PredP.

3.7.3 Ditransitives and Non-Syntactic Prosodic Constraints

Ditransitive predicate structures are known to be complex, but the nature of their complexity is still not fully resolved. Here we explore how the diagnostics provided by phrasal stress and Reflexive Voice can be used to explore the complexity further.

3.7.3.1 Reflexives, Extrametricality, and Ditransitive Structures

First, let us consider a more straightforward case, when the reflexive is the (prepositional) indirect object in a ditransitive predicate:

(192) IO of ditransitive V

Q: What will happen on April Fool's Day?

A1: Liz will glue Danny to ***Jáck***.

Baseline

A2: # Liz will glue ***Dánny*** to Jack.

A3: # Liz will glue Danny to ***hersélf***.

A4: Liz will glue ***Dánny*** to herself.

Reflexive

It is clear that the indirect object, like a direct object of a monotransitive clause, moves to VoiceP. Various tests (employing NPIs, Principle C effects, etc.) indicate that the direct object in these situations is hierarchically superior to indirect objects. So to test whether anaphors in the indirect object position move to VoiceP, we need to make the constituent that is more embedded than the reflexive be given (as with small clause subjects).

(193) DO of ditransitive V

Q: What will happen to Jack on April Fool's Day?

A1: Liz will glue ***Dánny*** [to Jack]_G.

Baseline

A2: # Liz will ***glúe*** Danny [to Jack]_G.

A3: # Liz will glue ***hersélf*** [to Jack]_G.

A4: Liz will ***glúe*** herself [to Jack]_G.

Reflexive

Since *herself* is in fact extrametrical without being given in (193), we can conclude that this is due to movement to VoiceP. This means that a LSOR anaphor can be merged as either a direct object or indirect object of a ditransitive verb of this type and move to VoiceP.

However, in double object construction structures (which are notoriously more structurally complex), ditransitives exhibit further complications that obscure whether anaphors can move to VoiceP. In double object constructions, the indirect object is hierarchically superior to the direct object at Spell Out (again with evidence from NPIs and binding effects). So again we make the more embedded constituent, *Danny*, given to see if a reflexive in this position moves to VoiceP.

- (194) IO in Double Object Construction
Q: What did Liz do with Danny?
A1: she showed ***Jack*** [Danny]_G.
A2: # she ***showed*** Jack [Danny]_G.
A3: # she showed ***hersélf*** [Danny]_G.
A4: she ***showed*** herself [Danny]_G.

Since *hersélf* is extrametrical, we can conclude that indirect objects in the double object construction can move to VoiceP for binding.

On the other hand, subject-bound direct objects are not extrametrical – they obligatorily bear phrasal stress in the neutral contexts.

- (195) DO in Double Object Construction
Q: What did Liz do?
A1: She showed Jack ***Danny***.
A2: # She showed ***Jack*** Danny.
A3: She showed Jack ***hersélf***.
A4: # She showed ***Jack*** herself.

This is different from other cases of stress-bearing reflexives, as these reflexives are not predicted to bear stress by any of our descriptive conditions (4)–(5), and also not straightforwardly predicted by our theoretical derivation of those conditions (133a-c). The binder is the subject, the anaphor is not in an island, and the clause is not passive. In other words, nothing seems to prevent a structure in which *hersélf* moves to Spec, VoiceP; yet, this data seems to suggest that it does not.

It is not difficult to imagine that not every anaphor can move to VoiceP, even if it is locally subject bound, not in an island, and not in a passive clause. It would not be surprising at all if there were other constraints: movement is constrained in many ways, and some of those constraints are

bound to interact with movement to VoiceP. However, we will now turn to prosodic constraints on possible outputs, and demonstrate that the pattern in double object constructions could be due to non-syntactic constraints.

3.7.3.2 Prosodic Structure and Prosodic Ungrammaticality

In addition to the syntactic structures which affect where phrasal stress may (not) be realized, the prosodic phonology has independent constraints one where phrasal stress must fall, which are defined solely in terms of phonological primitives. Recall (88c), repeated as (196):

(196) Every iP contains at least one prosodic word with phrasal stress⁶³

Additionally, there are independent rules governing prosodic structure building, which will determine which syntactic objects map onto iP-level constituents. For example, in double object constructions, Elfner (2014) finds evidence in the distribution of phrase-final lengthening, the possibility of pauses, and pitch movement that all suggest that the verb and the indirect object form an prosodic constituent, to the exclusion of the direct object, which forms its own prosodic constituent. Though she does not explicitly say so, given her findings on accents, it would seem that the constituents are iPs. Thus the double object construction in (197a) has the prosodic structure in (197b):⁶⁴

⁶³As before, it does not matter for our purposes what the exact formulation of the constraint is, as long as there is some constraint that defines a prosodic constituent that must contain a phrasal stress.

⁶⁴It does not seem that this is the necessary phrasing when the indirect object is prosodically weak – i.e. a pronoun like *it* or *'em*.

- i. a. [_{iP} show 'em Danny]
- b. [_{iP} show 'em it]

Here the phrasing appears to be that the entire verbal constituent is a single iP, though more careful testing (as in Elfner 2014) needs to be done to confirm this. One possibility is that the syntax-prosody mapping produces (ill-formed) prosodic structures like (ii), and the prosodic component itself restructures them into (well-formed) constituents like (i):

- ii. a. * [_{iP} show 'em] [_{iP} Danny]
- b. * [_{iP} show 'em] [_{iP} it]

This kind of prosodic restructuring operation that has posited as a ‘repair’ for ill-formed representations, especially for ones like (iib) (e.g. Nespor and Vogel 1986). Restructuring would need to be constrained, however – it does not seem to apply to double object constructions where the indirect object is prosodically ‘heavier’ (e.g. a name). See fn. 65.

- (197) a. Show John Danny.
 b. [_{iP} show **John**] [_{iP} **Danny**]

Regardless of exactly how this prosodic structure arises, there is a critical consequence: any constituent in the direct object position of a double object construction, like *Danny* in (197), will necessarily contain a phrasal stress.

Thus, this necessary prosodic structure along with the constraint in (196) correctly predicts that obligatorily stressless weak clitic pronouns such as *it* must not occur as the direct object of a double object construction – as we saw in Section 3.3.3.⁶⁵

- (198) a. * Show John it.
 b. * [_{iP} show **John**] [_{iP} it]

The phonology cannot create an optimal output that satisfies (196) for (198b) if *it* is obligatorily stressless.⁶⁶

In a similar way, extrametrical *herself* is ruled out in direct object position as well; but unlike *it*, *herself* is not inherently stressless. This is shown below, which repeats (195).

- (199) DO in Double Object Construction
 Q: What did Liz do?
 A1: She showed Jack **Danny**.
 A2: # She showed **Jack** Danny.
 A3: She showed Jack **hersélf**.
 A4: # She showed **Jack** herself.

To be clear, the fact that (199A3) is good and (199A4) is bad results from independent facts about the prosodic structure generated in double object constructions, and it is independent of whether *herself* moves to VoiceP.

⁶⁵This begs the question: why can't prosodic restructuring (as in fn. 64) occur to rescue (198b)? That is, at one level of derivation (perhaps just after syntax is mapped onto prosodic phrasing) *it* is in its own prosodic phrase; but because this is ill-formed, the phonology might be able to cause *it* to not be in its own phrase. In other words, why is (i), below, ill-formed?

i. * [_{iP} show **John** it]

Why this restructuring cannot happen here (or with reflexives, as in (199A4)) is left as an important open question for further research.

⁶⁶In fact, there are some speakers who do allow a stressed *it*; for them, (198a) is grammatical, with a stressed *it*.

One possibility is that *herself* doesn't move to VoiceP, and so the S-NSR applies phrasal stress to *herself* based on syntactic input. Another possibility is that *herself* does move to VoiceP, and so the S-NSR does not predict it to bear phrasal stress⁶⁷; but it is placed in an iP by itself during the prosodic structure building, and as such the prosodic phonology imposes some phrasal stress on *herself* based on phonological input. (This is allowed with *herself* where it wasn't with *it* due to *it* being obligatorily stressless, unlike *herself*.)

In this way, the phrasal stress in double object constructions like (199A3) could be derived on a structure where the anaphor moves to VoiceP, or on a structure where it does not. Prosody is not clearly uninformative about structure here. This highlights the fact that prosodic properties are fed by syntax, but are also subject to independent constraints. We will return to the case of these direct object anaphors in ditransitives, in Chapter 4.

3.7.4 DP-Internal Reflexive Anaphors

The final area we will explore, only briefly, is in the domain of argument-internal reflexives like the underlined himself in (200):

(200) Pete showed himself a picture of himself.

Reflexive anaphors in picture NPs like the one above have been discussed quite extensively the literature for various reasons (e.g., Barss 1986, Pollard and Sag 1992, Reinhart and Reuland 1993, Chomsky 1995, Büring 2005, Reuland 2011, to name only a few). For our purposes, it is important to know the prosody of a sentence like (200) before we can make any convincing arguments about their structure. Consider the sentence in (201):

(201) [_{iP} Pete shówed himself] [_{iP} a phóto of himself].

What is important to note here is that both instances of *himself* are extrametrical. The indirect object *himself* moves to VoiceP, deriving its extrametricality – we know indirect objects in double

⁶⁷This assumes that, in double object constructions, the phase where the S-NSR applies for the first time is at the same point as elsewhere – at a point above VoiceP – consistent with modern analyses of double object constructions (e.g. Larson 1988, Pesetsky 1995, Harley 2002).

object constructions can undergo this movement. On the other hand, in *photo of himself*, *himself* is extrametrical but can't move to the same VoiceP; its specifier is occupied by the indirect object *himself*. This indicates that the extrametricality of the second *himself* is not the result of movement to the main clause VoiceP. This could indicate one of two things: (i) there is a second possible source for extrametricality of anaphors, or (ii) the structure for (201) might be different from what is traditionally assumed.

While the first option is possible, this option would need to be worked out such that the availability of this second source is strongly constrained. If it were not, we might expect to see reflexive anaphors becoming extrametrical via this second operation in places where REFL Voice syntax is disallowed (cf. the descriptive constraints and their derivation in (4)–(5) and (133)).

Instead, it could be that both instances of *himself* are moving to VoiceP, but not to the same VoiceP. In particular, the indirect object would move to the main clause VoiceP, as we've said, and the DP-internal *himself* moves to a separate VoiceP, within the DP. To be clear, this would mean that *a photo of himself* is complex and has hidden syntactic argument structure, which includes a Voice projection and a subject, paralleling the clause. (This is very similar to proposals that assert that all NPs are clausal (Bach 1968, Campbell 1996, Davies and Dubinsky 2003, Koopman 2003, 2005, among others).)

To provide further evidence for this latter alternative in which DPs may contain a REFL VoiceP, let us consider another set of examples. Consider (202):

(202) Jack found letter to himself.

The *himself* here is quite clearly extrametrical, but where does this property come from? First, let us establish that *himself* is not in an island:

(203) Who did Jack find a letter to _____?

The grammaticality of (203) indicates that *himself* in (202) is not in an island, and in principle it could be moving to the VoiceP associated with *find*. However, if the binder is not the subject of main clause, or if main clause is passivized, *himself* is still extrametrical.

(204) Jack showed Kathy a letter to herself.

(205) Kathy was shown a letter to herself.

What (204) and (205) show is that, as with (201), (202) must not involve movement of *herself* to the main clause VoiceP. In (204), we wouldn't expect *herself* to be extrametrical because its apparent binder, *Kathy*, is not the subject of the main clause. This means that the binder of *herself* must be some local subject that is not overtly expressed in (204). Additionally, in (205), the main clause's VoiceP is specified as passive, and REFL and passive are in complementary distribution. Instead, the local subject binder of *herself* must be located elsewhere in the structure. These issues would be resolved if there were a REFL VoiceP and a silent local subject binder within the DP *letter to herself*.

To further motivate an analysis whereby there is a VoiceP and hidden argument structure within the NP, let us observe how there is available an alternative prosody, which comes with slightly distinct interpretational properties:

(206) a. Jack found a letter to himself.

 ⊨ Jack wrote the letter.

 b. Jack found a letter to himself.

 ⊭ Jack wrote the letter.

In (206a), there is a strong judgment that the sentence entails *Jack* writing the letter. (206b), on the other hand, does not exhibit the same strong judgment of entailment. Perhaps in (206a) there is an argument structure projected for *letter* and there is a REFL Voice that binds *himself* and a silent DP-internal subject, while (206b) lacks that argument structure and so there are no arguments of *letter* and nothing for a REFL Voice to relate. This kind of duality in the complexity of DP structure is perhaps surprising, and is even argued specifically against by Bach (1968). As such, further work needs to be done to diagnose the differences in structure between (206a) and (206b).

Finally, consider data like (207), in which the focus prosody shows up on *letter* when the constituent *a letter about himself* is focused.

(207) a. What did John destroy?

 b. He destroyed [a letter about himself]_F.

First, this data provides further evidence of *himself* being extrametrical. Second, this *himself* occurs in a structural context that prevents it from moving to the main clause. Consider (208), based on logic from Davies and Dubinsky 2003, where extraction out of the DP is illicit.

(208) *Who did you destroy [a letter about _____]?

This corroborates an analysis in which the property of being extrametrical is the result of moving within the DP, to a position like VoiceP.

This is only a brief review of the properties of DP-internal reflexives, and it does not offer a deep derivation for many of the properties found with DP-internal reflexives in other works. In fact, seeing as the analysis is that DPs may or may not contain REFL VoiceP, the findings of other works in the literature deserve further investigation, to see if controlling for the (silent) structural complexity of the DP in which the reflexive occurs affects the grammatical properties of the anaphor.

3.8 Conclusion

In this chapter, we explored the fact that, while reflexive anaphors are generally phrasally extrametrical, this extrametricality is not an inherent property of the reflexive anaphor itself. Moreover, this extrametricality is also not due to being a weak pronoun (which distribute differently than extrametrical reflexives), nor is it due to the grammar somehow treating anaphors as given.

The distributional patterns of extrametrical reflexive anaphors are more complex than any of these simpler hypotheses would suggest. As such, instead of trying to reduce the empirical phenomenon of extrametrical reflexive anaphors to a sub-type of similar empirical phenomena, this chapter has shown that extrametricality is the result of syntactic inputs to a single, exceptionless nuclear stress rule.

(99) **Structure-Based Phrasal Stress Rule (S-NSR):**

The most deeply embedded constituent in a Spell-Out Domain receives the phrasal stress.

(100) **Depth of Embedding:**

A syntactic object, X, is more deeply embedded than some other syntactic object, Y, provided that no copy of X c-commands all copies of Y

The extrametricality of a reflexive anaphor is constrained by the phrasal stress and its input, which is hierarchical structure from the syntax. Only when the anaphor undergoes movement in the narrow syntax can it be extrametrical. Specifically, extrametrical reflexive anaphors move to the specifier of Reflexive VoiceP, just in case they are bound by the local subject (Local Subject Oriented Reflexivity; LSOR). LSOR-reflexives thus have been argued to rely upon a derivation like (209), the core properties of which are laid out in (210).

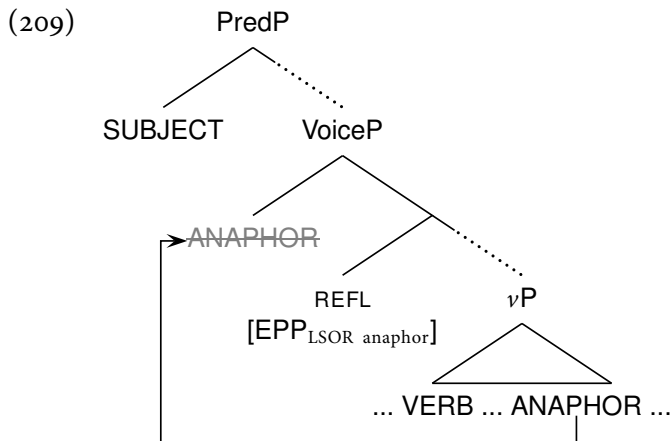

(210) **The Core Aspects of the Derivation of Extrametrical Reflexive Anaphors**

- i. Extrametrical reflexive anaphors is the result of an LSOR derivation
- ii. There are two atoms of reflexivity in LSOR:
 - (a) an anaphor merged in an argument position, and
 - (b) a Reflexive head on the spine that is associated with grammatical voice and the semantic reflexivizing function
- iii. These two atoms yield the LSOR properties:
 - (a) The anaphor undergoes movement when the Reflexive Voice^o is merged, and
 - (b) The local subject necessarily binds the LSOR anaphor, due to the syntactic structure.

This movement of LSOR-reflexives parallels overt movements of other languages, but in the case of English, the LSOR anaphor is pronounced in its normal case/thematic position, while its prosodic properties indicate that a copy occurs higher in the structure.

In addition to the LSOR reflexives that are derived like (209), there are also reflexive anaphors

that do not move. Phrasal-stress bearing reflexives must also be licensed (i.e. bound), but their licensing conditions are not dependent of a Reflexive Voice. We have left the nature of these other licensing conditions as an open question, recognizing only that not all reflexive derivations are identical.

The VoiceP analysis in (209) captures our basic observations on how extrametrical reflexive anaphor distribute. Namely, the constraints in (3)–(4) can be analyzed and distilled as the following two theoretical observations:

- (117) **First Theoretical Observation of Extrametrical Reflexives:**
Movement constrains the grammatical contexts in which reflexives may be extrametrical.
- (129) **Second Theoretical Observation of Extrametrical Reflexives:**
Grammatical voice constrains the grammatical contexts in which reflexives may be extrametrical.

Placing these observations in our framework yields a structure like (209), and allows us to formally derive our descriptive constraints: in the following ways, which depend on (210):

- (133) **Theoretical Derivation of Descriptive Constraints**
- a. The LSOR-reflexive cannot be separated from VoiceP by an island boundary, because it must move to VoiceP from its base position.
 - b. The LSOR-reflexive must have a subject antecedent because only subjects occur high enough in the clause to give the reflexive the correct interpretation.
 - c. The LSOR-reflexive cannot have a derived subject as an antecedent, because LSOR-reflexives rely on the Reflexive Voice^o, while derived subjects rely on some other Voice^o.

However, at this point we have yet to see exactly how the semantic derivation only yields “the correct interpretation” for the LSOR reflexive when the subject is the antecedent of binding. To understand that, we will expand our empirical range to observe the behavior of reflexive anaphors under focus, in the next chapter. Critically, the behavior to be observed will be constrained in all of the same ways as extrametrical anaphors.

3.9 Further Research

In this chapter, we explored a range of locally bound reflexive anaphors, including anaphors in various structural configurations with different types of antecedents. As we have essentially re-defined the structural configuration of reflexive clauses in LSOR contexts, previous findings in the extensive literature on binding may need re-evaluation, especially with regard to works that attempt to unify the licensing conditions of all reflexives under a single formal rule. In particular, Section 3.7.4 argues that there are two types of reflexive anaphors that can occur in the nominal domain: one that depends on a REFL Voice within the DP, and one which does not. This adds a new dimension to the study of so-called picture-NP reflexives, which may resolve some standing issues in the area.

In addition, there are several questions that have not yet arisen. For example, does REFL Voice (or some other Voice) relate to reciprocity? We should look to see if there are syntactic/prosodic effects parallel to LSOR in “Local Subject-Oriented Reciprocity” contexts. This might be especially fruitful as reciprocal anaphors have a somewhat wider distribution than reflexive anaphors.

Another important question relates to the fact that there are two types of locally bound reflexivity: reflexivity that involves a REFL VoiceP (i.e. LSOR) and reflexivity that doesn't (e.g., object-oriented reflexivity). These two types of reflexivity involve rather different derivations, but what drives the choice between the derivations? Perhaps the choice is driven by a general principle that favors the most constrained derivation. (This issue is further discussed in Appendix E.)

Of course, we need to explore how this derivation relates to semantics, as well as how this derivation relates to reflexive structures in other languages. These two issues are the primary topics of Chapters 4 and 5.

CHAPTER 4

The Distribution of Focal Stress in Reflexive Clauses

“Therefore to the same natural effects we must, as far as possible, assign the same causes.”

– Sir Isaac Newton, Rules of Reasoning in Philosophy: Rule II (1687)

“Any semantic object or operation on such objects has to have a correlate in the syntax, an expression or operation that triggers it. And conversely, all expressions and all structural operations in the syntax have to have a semantic correlate.”

– Martin Stokhof, The development of Montague grammar (2006)

Typically, a sentence with a prosodically focused constituent gives rise to a set of alternative propositions in which the focused constituent is replaced with other (similar) constituents – either formally (e.g. Rooth 1985, *et seqq.*) or descriptively. This is exemplified in (1a), for which some possible alternatives are given in (1b).¹

(1) a. Marie saw **WARREN** at the party.

b. Alternatives to (1a) = $\left\{ \begin{array}{l} \text{Marie saw } \underline{\text{Charles}} \text{ at the party} \\ \text{Marie saw } \underline{\text{Moir}} \text{a at the party} \\ \text{Marie saw } \underline{\text{Jean}} \text{ at the party} \\ \dots \end{array} \right\}$

In other words, the constituent on which prosodic focus falls (the accented bolded, underlined and small-caps string) is the one for which alternatives are considered, i.e. the semantic focus.²

¹Throughout this chapter, the bolded, underlined small-caps indicate contrastive focus (as opposed to presentational focus), typically realized as a L+H* pitch accent (Pierrehumbert and Hirschberg 1990).

²More complex statements have been said to be required when the semantic focus contains multiple words. See Section 2.2.5.

Similarly, in response to a WH-question, prosodic focus in the answer will fall on the constituent that corresponds to the WH constituent in the question. This is exemplified in (2), where the prosodic focus falls on the same word that is the semantic focus:

- (2) Q: Who injured Charles?
A1: ÉMMMA injured Charles.
A2: # Emma injured CHÁRLES.
A3: # Emma ÍNJURED Charles.

Despite the robustness of these descriptive generalizations, there appears to be a systematic exception in the case of (certain) reflexives. Consider the minimal pair for (2) in (3).

- (3) Q: Who injured Charles?
A1: # CHÁRLES injured himself.
A2: Charles injured HIMSÉLF. REAFR
A3: # Charles ÍNJURED himself.

Though felicitous answers to subject-WH questions generally involve (prosodic and semantic) focus on the subject in the answer, this is not possible for answers with reflexives like in (3). The special pattern of prosodic focus (3A2) is what I assign the descriptive term, Realizing External Argument Focus on a Reflexive (REAFR).^{3,4} (This term is descriptive, and it will be seen that what is under semantic focus is not the external argument.) In the course of studying REAFR's distribution, we will find independent corroboration for the REFL Voice theory of reflexivity presented in Chapter 3.

In particular, it was shown that Local Subject-Oriented Reflexive (LSOR) anaphors occur in a distinct structural position, in which other nominal objects do not occur, which yields their extrametricality. This is a departure from the various past approaches to (English-like) reflexivity, which generally assume that the (surface) structural position of a reflexive object like *himself* in (4) is the same as other objects, like *Erik* in (5) (cf. Chomsky 1981b, 1986a, Pollard & Sag 1992, Reinhart & Reuland 1993, Hornstein 2001, *inter alia*). An example of this (assumed) similarity is

³Special thanks to Natasha Abner for assistance in naming this phenomenon.

⁴Given modern analyses of argument structure, it may be unclear what is meant by "external argument." I use this term to refer to the argument which becomes the subject in a "normal" active clause.

provided in (4):⁵

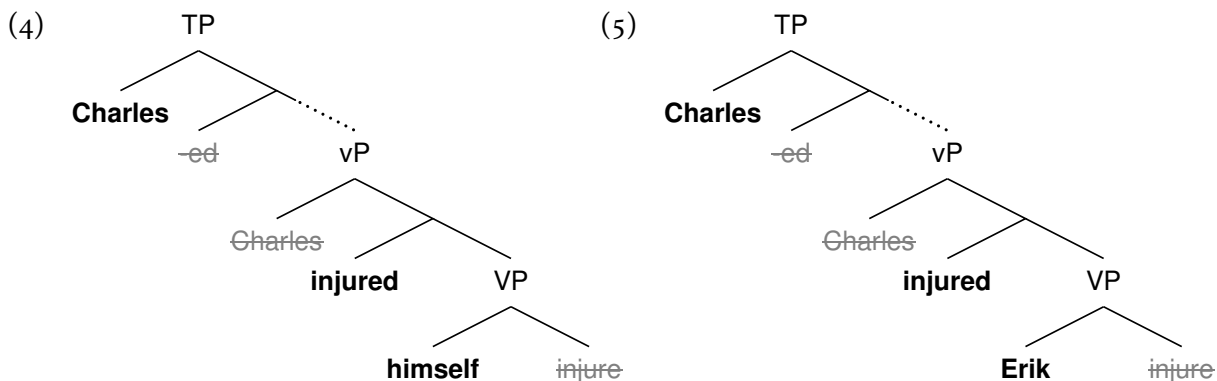

Reflexive clauses in which the antecedent is the local subject are more complex, involving movement of the anaphor to a Reflexive VoiceP:

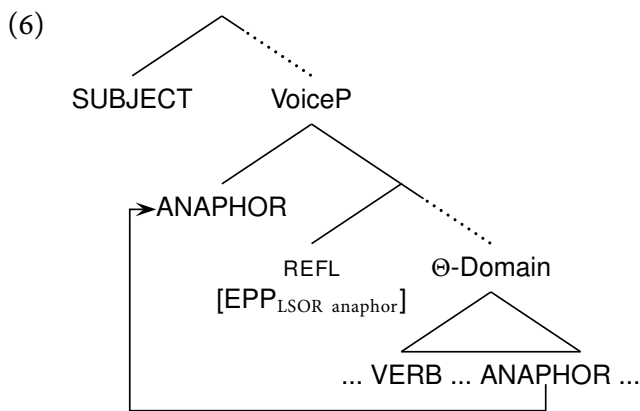

This structure, which was motivated on the basis of phrasal stress in English, also derives REAFR and its properties. In fact, the very same conditions that constrained the distribution of extrametrical reflexive anaphors also constrain REAFR. Compare the constraints on extrametrical reflexives in (3)–(5) of Chapter 3 with the constraints on REAFR in (7)–(9).

(7) Descriptive Condition on Islands

REAFR is not possible if the reflexive anaphor occurs in an island that excludes (any copy of) its antecedent.

⁵As before, I continue to use the label “vP” for the phrase in which the highest thematic argument is introduced, and “VP” for the phrase in which lower arguments are introduced – with the two together comprising the thematic domain. I do not attach any other theoretical meaning to these projections. In fact, it is perhaps more likely that there are other projections within the thematic domain: one for every unique theta role. This would be in line with a theory of thematic roles like UTAH (Baker 1988), and with a syntactic model in which a neo-Davidsonian semantics (e.g. Parsons 1990) is directly encoded by the syntax (e.g. Borer 2005, Pylkkänen 2008, Lohndal 2011).

(8) **Descriptive Condition on Subject-Orientation**

REAFR is not possible if the antecedent of the reflexive anaphor is not the subject.

(9) **Descriptive Condition on Grammatical Voice**

REAFR is not possible if the reflexive anaphor occurs in a passive clause.

This is entirely unexpected, *prima facie*, and adds critical support to a VoiceP-theory of LSOR in English.

Elaborating upon this structure, our investigation of REAFR will reveal the semantic properties of REFL, providing a deeper understanding of the nature of the subject-oriented reflexives and their movement to VoiceP. To be specific, we will conclude that REFL is the locus of semantic reflexivity, and in REAFR contexts, REFL is what is under semantic focus. This is motivated by an additional descriptive constraint on REAFR:

(10) **Descriptive Condition on Discourse Information**

REAFR is not possible if the reflexive anaphor occurs in a context in which reflexivity is given information.

Finally, the prosodic focus associated with the semantically-focused, yet silent REFL is then realized on the anaphor, conforming to a general mechanism that applies when a silent constituent is focused. This will capture where REAFR is possible and where it is not, while motivating the syntactic correlates of REAFR and predicate-level reflexivity.

4.1 Reflexives and ‘Exceptional’ Focus: Some REAFR Data

To get a better sense of REAFR, we will now explore some of the many contexts in which REAFR can occur.

We have seen already that REAFR is possible in response to a subject WH-question, when the answer provides the identity of that subject. In addition, REAFR prosody is contexts where the identity of an external argument an action is being corrected. Each of these is exemplified below:

- (11) A: Who defended Liz?
 B1: LÍZ defended Liz. Subject Focus
 B2: # Liz defended LÍZ.
 B3: # LÍZ defended herself.
 B4: Liz defended HERSÉLF. REAFR
- (12) A: Jack defended Liz.
 B1: No, LÍZ defended Liz. Subject Focus
 B2: # No, Liz defended LÍZ.
 B3: # No, LÍZ defended herself.
 B4: No, Liz defended HERSÉLF. REAFR

In both of these cases, a possible response is one like (11B1) and (12B1), where subject-focus is expressed by placing prosodic focus on the subject in the response. However, when expressing that Liz is the one who defended Liz, and there is a reflexive anaphor in the object position, it is infelicitous if the prosodic focus falls on *Liz* and not *herself*, as in the (11B3) and (12B3). Instead, if there is a single prosodic focus in the response, it must fall on the anaphor. (We return to the possibility of multiple prosodic foci in Section 4.2.3.)

In addition, REAFR occurs in a range of other naturalistic contexts. In each of the examples below, a paraphrase using a non-reflexive clause shows the parallels with subject focus; and where possible, annotated pitch tracks of the original utterance are provided.

- (13) The twin towers didn't blow THEMSÉLVES up. (bumper sticker)
 ≈ THE TWIN TÓWERS didn't blow the twin towers up.
 ≠ The twin towers didn't blow THE TWIN TÓWERS up.
- (14) My sandwich didn't eat ITSÉLF.
 ≈ MY SÁNDWICH didn't eat my sandwich.
 ≠ My sandwich didn't eat MY SÁNDWICH.

- (15) They [Kids] practically raise THEMSÉLVES, what with the Internet and all.
 ≈ KÍDS raise kids. (The Simpsons Ep.233)
 ≠ Kids raise kÍDS.

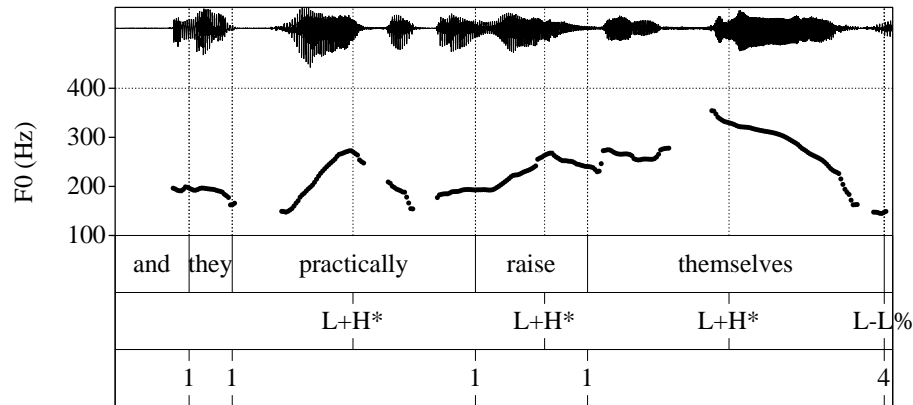

- (16) No one is censoring us; but we are censoring OURSÉLVES.
 ≈ WÉ are censoring us. (NPR, Weekend Edition Saturday, 2008/07/26)
 ≠ We are censoring ÚS.

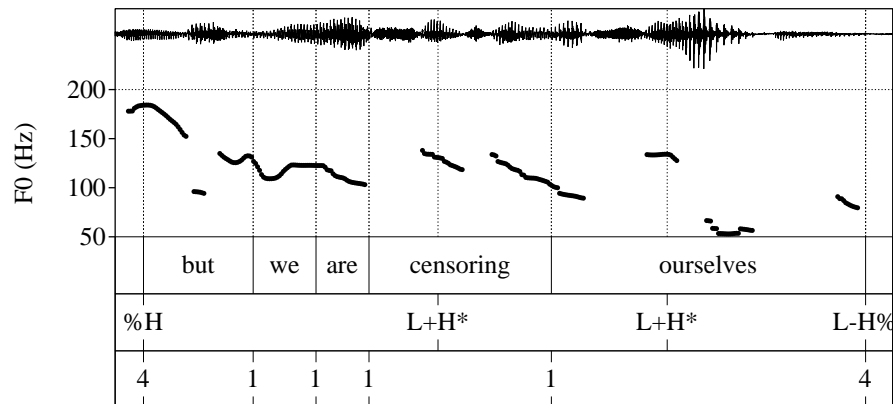

- (17) Sometimes life trips us up. And sometimes, we trip OURSÉLVES up.
 ≈ WÉ trip us up. (Liberty Mutual TV Ad)
 ≠ We trip ÚS up.

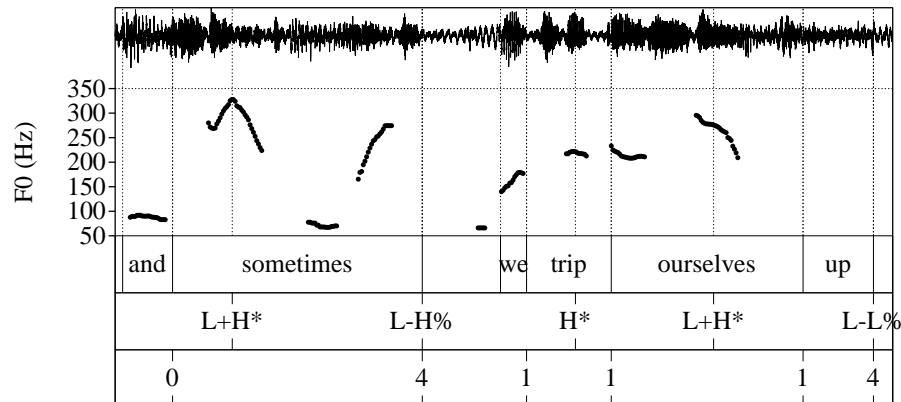

In each utterance, the subject does not bear any focal accents; instead the reflexive anaphor bears a focus accent, despite the alternatives appearing to be other subjects and not other objects.

Finally, let us consider the effect of different prosodic contours for the same clause with a reflexive in it. The sentence in (18a) simply has default phrasal stress, which falls on the verb particle in these contexts (as discussed in Section 3.6.4.2), whereas the sentence in (18b) has focus stress on the reflexive anaphor.

- (18) a. I'll show myself óut. Default Phrasal Stress
b. I'll show MYSÉLF out. REAFR

With simple phrasal stress, (18a) can essentially be interpreted as saying 'I'll leave'. However, with the focus on *myself*, there are two interpretations that emerge:

- (19) a. I won't show YOU out, I'll show MYSELF out.
b. YÓU don't need to show me out, I will show MYSÉLF out.

The interpretation of (19a) is simply one which yields an object-focus interpretation – this is the expected interpretation from placing focus on a constituent in object position. The interpretation of (19b) is a REAFR interpretation, where alternatives to subjects seem to be generated. This ambiguity is telling; there must be different structures that yield these different interpretations. Further investigation is required to come to an understanding of the source of this REAFR interpretation.

Although we have seen REAFR occurring in a wide variety of discourse contexts in this section, question-answer contexts will be considered most often in the remainder of our investigation of REAFR in this chapter. The reason for this is that they provide rather clear insight into the discourse context, which is critical for a contextually sensitive phenomena like focus and reflexivity, which are at the very core of REAFR.

4.2 The Puzzle: Question-Answer Congruence

Now recall from Section 2.2.5 of Chapter 2 the constraint on Question-Answer Congruence (QAC):

(20) **Question-Answer Congruence**

An appropriate answer to a question must semantically and prosodically focus the constituent(s) being questioned.

As a descriptive generalization the QAC is extremely robust. Despite the widely-supported descriptive accuracy of the QAC, REAFR appears to present an exception to it.

In this light, REAFR can either be taken to be a true exception to the QAC (in which case, REAFR represents something of a stumbling block for the learner), or it could be that the QAC is informative about the grammatical properties of reflexive clauses. After deeper investigation into how REAFR is constrained, we will come to understand the theoretical underpinnings of REAFR, and instead the derivation that is supported is one in which the theoretical underpinnings of the QAC are maintained as exceptionless.

4.2.1 QAC and Non-Reflexive Clauses

Before turning to REAFR, let us first consider QAC in some clauses without reflexive anaphors. In a sentence like *Liz entertained Ken*, there is an entertaining event, in which Liz is the agent and Ken is the theme. This can be represented (with some level of abstraction) as (21):

- (21) Notionally Non-Reflexive Situation
entertain(*e*) & agent(Liz,*e*) & theme(Ken,*e*)

If one posed an object-WH question as in (22Q), and the answer reflects the scenario in (21), a full-sentence answer could be *Liz entertained Ken*, and Ken would be the semantic focus. This answer is given with different realizations in (22A1-A3) – these answers differ on the placement of the prosodic focus (indicated by bolded, underlined small caps with an accent: ´), while the semantic focus (indicated by the diacritic _F) is constant.

- (22) Q: Who did Liz entertain? Object Question
A1: # **LÍZ** entertained [Ken]_F.
A2: # Liz **ENTERTÁINED** [Ken]_F.
A3: Liz entertained [**KÉN**]_F.

QAC dictates that, since the semantic focus falls on the object, the prosodic focus should also be

on the object. Only (22A₃) achieves this; the answers in (22A₁-A₂) violate QAC and are ruled out.⁶

Asking the subject question in (23Q) in the same context in (21) will result in the answer *Liz entertained Ken*, though this time the semantic focus will be on the subject, *Liz*. Likewise, the location of prosodic focus in an answer to a subject-WH question like (23Q) shifts to the subject:

- (23) Q: Who entertained Ken? Subject Question
A₁: [LÍZ]_F entertained Ken.
A₂: # [Liz]_F ENTERTAINED Ken.
A₃: # [Liz]_F entertained KÉN.

Because (23A₁) is the only answer in which the prosodic focus on the constituent that is semantically focused, (23A₂-A₃) are ruled out by QAC. Thus, QAC makes the correct (and seemingly obvious) prediction that the location of prosodic focus in answers to subject-WH and object-WH questions is going to be entirely distinct.

Now let us consider a similar situation, but one which is notionally “reflexive” (but not grammatically so): in a single entertaining event, Ken was both the agent and the theme.

- (24) Notionally Reflexive Situation
entertain(*e*) & agent(Ken,*e*) & theme(Ken,*e*)

In (25Q) and (26Q), object-WH and subject-WH questions are posed, and in a context like (24), we can get *Ken entertained Ken* as the answer, and the location of semantic focus tracks the type of question. The location of possible prosodic focus is given in (25) and (26).

- (25) Q: Who did Ken entertain? Object Question
A₁: # KÉN entertained [Ken]_F.
A₂: # Ken ENTERTAINED [Ken]_F.
A₃: Ken entertained [KÉN]_F.

⁶It may seem that “too much focus” may arise without violating the QAC – that is, based on the informal definition of QAC in (12), one might expect “*LÍZ entertained KÉN*” to be felicitous as well. In such a case, the QAC is met by having the object *Ken* being focused, and nothing seems to rule out adding more foci. See Krifka 2004 for a formal definition of QAC that rules out such an “overfocused” answer. Alternatively, there could be a constraint like Schwarzschild 1999’s AVOIDF which limits the amount of focusing in an utterance.

- (26) Q: Who entertained Ken? Subject Question
 A1: [KÉN]_F entertained Ken.
 A2: # [Ken]_F ENTERTAINED Ken.
 A3: # [Ken]_F entertained KÉN.

Just as in the object-WH and subject-WH questions for the non-reflexive situation in (21), QAC correctly predicts the felicitous prosodic contours associated with the answers to (25Q) and (26Q). Moreover, it correctly predicts that the answers for the subject- and object- questions are prosodically distinct from one another.

4.2.2 QAC and REAFR Contexts

In addition to *Ken entertained Ken*, there is a second string which can be used to answer the questions in (25) and (26) a context that is *a priori* notionally identical to (24), but with a different grammatical form in (27).

- (27) Grammatically Reflexive Situation
 entertain(*e*) & agent(Ken,*e*) & theme(himself,*e*)

(At this point we cannot explain what it means for *himself* to be the theme in the event, as it is not clear how to semantically treat an anaphor like *himself*. This will be described in Section 4.4.5.)

Consider now the possible placement of focus accents for the object and subject questions:⁷

- (28) Q: Who did Ken entertain? Object Question
 A1: # KÉN entertained [himself]_F.
 A2: # Ken ENTERTAINED [himself]_F.
 A3: Ken entertained [HIMSÉLF]_F. Object Focus
- (29) Q: Who entertained Ken? Subject Question
 A1: # KÉN entertained himself.
 A2: # Ken ENTERTAINED himself.
 A3: Ken entertained HIMSÉLF. REAFR

In (28), just as in other object-question scenarios, QAC is respected in the expected way: the felicitous answer has prosodic focus on the object, and semantic focus is also on the object. However,

⁷I have chosen not to F-mark any constituent in (28) and (29). At this point, I do not wish to make any assumptions on which constituent is semantically focused, as that is part of what I investigate throughout this chapter. I return to this in detail in §4.4.

the felicitous answer to the subject question in (29) seems to be a direct violation of QAC: the object is prosodically focused in response to a subject question. (I have left semantic focus out of the representation of REAFR, as it is not yet clear where it should be placed. The placement of semantic focus will be returned to in Section 4.4.)

Another way of posing the problem is that (28A3) and (29A3) appear to have semantic focus on the object and subject, respectively, while the have prosodic focus remains in a constant location on the reflexive anaphor. The answer to the subject question in (29Q) as well as the object question in (28Q) can be entirely homophonous, both segmentally and supra-segmentally. This data is presented in a different format below, and the two responses will be referred to as REAFR and object focus responses, respectively:

- (30) Q: Who ___ entertained Ken?
A: Ken entertained HIMSÉLF. REAFR
- (31) Q: Who did Ken entertain ___?
A: Ken entertained HIMSÉLF. Object Focus

The ambiguity of the sort exhibited by the focused reflexives in (30)-(31) is not straightforwardly derivable though QAC. Assuming that answers to subject-questions like (30) semantically focus an entirely distinct constituent than answers to object-questions like (31), how could they both map the prosodic focus onto the reflexive, given QAC?

4.2.3 Briefly: Dual Focus Prosody

Before continuing on into discussing potential accounts of REAFR, and REAFR's relationship with QAC, we should first briefly discuss the fact that questions that may result in REAFR answers also permit a second prosodic contour in their answers.

For example, the subject WH-question in (29Q), which is repeated below in (32), can have a REAFR response like (32A1), or a response like (32A2), in which both the reflexive and the subject bear focus:

- | | |
|---|------------------|
| (32) Q: Who entertained Ken? | Subject Question |
| A1: Ken entertained <u>HIMSÉLF</u> . | REAFR |
| A2: <u>KÉN</u> entertained <u>HIMSÉLF</u> . | Dual Focus |

We will call the pattern in (32A2) the “Dual Focus” pattern.

Although superficially very similar to REAFR, the Dual Focus pattern exhibits different properties and a different distribution. In a Dual Focus answer, the representation is different: it contains two semantic foci and likewise two prosodic foci, the placement of each conforming to the QAC. In other words, (32A2) has a representation like (33A1), similar to (33A2):

- | | |
|---|------------|
| (33) Q: Liz entertained Ken. | |
| A1: No, <u>KÉN</u> _F entertained <u>HIMSÉLF</u> _F . | Dual Focus |
| A2: No, <u>JÉNNA</u> _F entertained <u>JÁCK</u> _F . | Dual Focus |

REAFR does not involve this kind of dual semantic focus marking, and in particular it does not involve a representation in which semantic focus falls on the subject. This can be shown by considering what happens in cases where the subject may be silent/unexpressed: imperatives. Imagine a scenario where person A tells person B to do the dishes, but person B thinks person A should do the dishes.

- | | |
|-----------------------------------|------------------|
| (34) A: Make a sandwich. | |
| B1: # No, (you) <u>máke</u> one! | #No Focus |
| B2: # No, (you) make <u>ÓNE</u> ! | #Focus on Object |
| B3: # No, <u>MÁKE</u> one! | #Focus on Verb |
| B4: No, <u>YÓU</u> make one! | Focus on Subject |

In these cases, if the agent of who is to do the dishes is being focused in B’s retort. In order to felicitously express this, the subject *you* cannot be omitted, and it must bear the prosodic focus. In other words, the grammar will not tolerate a silent subject where the subject bears semantic focus.

The facts are different in imperatives with reflexive objects. Compare (34) with minimal pairs in (35) and (36).

- (35) A: Make yourself sandwich.
 B1: # No, (you) make me one! #No Focus
 B2: # No, (you) make me ONE! #Focus on Direct Object
 B3: # No, (you) make MÉ one! #Focus on Indirect Object
 B4: # No, (you) MÁKE me one! #Focus on Verb
 B5: No, YÓU make me a sandwich! Focus on Subject
- (36) A: Make me a sandwich.
 B1: # No, (you) make yourself one! #No Focus
 B2: # No, (you) make yourself ONE! #Focus on Direct Object
 B3: No, (you) make YOURSELF one! REAFR
 B4: # No, (you) MÁKE yourself one! #Focus on Verb
 B5: # No, YÓU make yourself a sandwich! #Focus on Subject

The example in (35A) does not have a reflexive anaphor in the response, and behaves just like (34A) in terms of an obligatory prosodic-focus-bearing subject. On the other hand, the example in (36A) is different. It has reflexive anaphor in the response, and now prosodic focus obligatorily falls on the reflexive, and the subject need not be pronounced. Since semantically focused pronouns cannot go unpronounced, it must be that the optional subject does not bear semantic focus.

A naturalistic example of this comes from a television commercial, provided in (37) with the relevant portion of the pitch track:

- (37) Don't take our word for it. [...] Prove it to YOURSELF! (Television Ad for Purex)
 ≈ Don't have ús prove it to you.
 ≠ Don't prove it to ús.

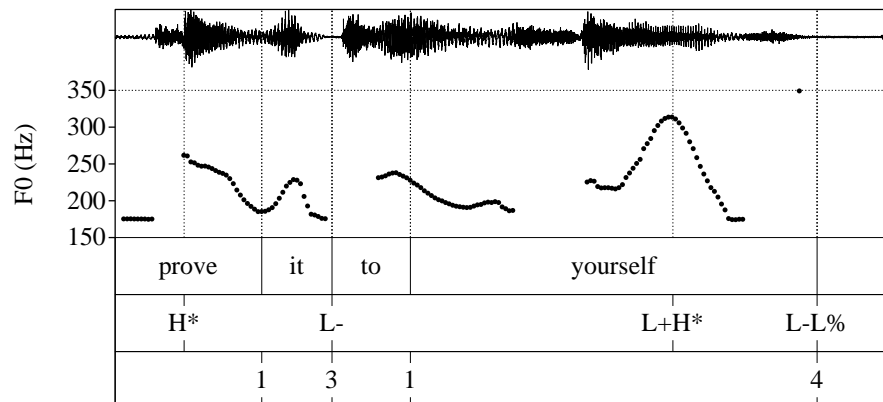

Note that this context is ill-suited for any kind of object-focus interpretation, yet the subject also need not bear any focus since it is optional.

To be entirely clear, the crucial fact is that REAFR can appear in contexts where the antecedent subject is silent. Because semantically focused subjects must be pronounced, we can conclude from examples like (36B₃) and (37) that REAFR involves no subject focus.

Additionally, this means that the Dual Focus pattern ought to involve an entirely different derivation from the one that derives REAFR. This analysis will gain further support as we see that the dual focus pattern has a much wider distribution than REAFR does. (This will be laid out clearly in Section 4.3.4.) The dual focus pattern does not depend on any of the REAFR-specific analysis (i.e. REFL Voice, as will be shown in Section 4.4) in order to be felicitously used.

4.2.4 Summary

REAFR appears to present a serious problem, if we consider the QAC to be a generalization that is rooted in the nature of linguistic derivations: namely that mapping between prosodic and semantic structures (as mediated by the syntax) is entirely regular, with maximally little distortion between the structures. Taking the fact that the set of apparent exceptions to the QAC is remarkably small, the theoretician may pursue two different types of solutions. On the one hand, one could invoke a finite list of exceptions to QAC that is stipulated where necessary, which would include REAFR. On the other, the location of semantic focus and prosodic focus actually result from the the normal, exceptionless mechanism for mapping syntactic structure to semantic and prosodic foci (meaning that that mechanism or its input is different from what appears to be the case, at first blush).

In the next section, I demonstrate that any analysis in which REAFR is treated as an exception would fail to predict that REAFR is only felicitous in certain grammatical contexts. Taking the stronger position on QAC – that its theoretical underpinnings are inviolable and without exceptions – this REAFR data is no longer stipulated away, but rather informs our theory of the

syntactic and semantic representation of reflexivity.

4.3 Inadequate Accounts

In this section, we explore several logically possible explanations for the REAFR phenomenon. Each of those explored here has short-comings, either empirical, theoretical, or both. By understanding where other potential analyses fail, the core grammatical properties of REAFR and its formal derivation will be uncovered.

4.3.1 Inadequate Account: Object Focus

One possible account appeals to the homophony between REAFR and object focus sentences. Recall (30) and (31), repeated below.

- (30) Q: Who ___ entertained Ken?
A: Ken entertained HIMSÉLF. REAFR
- (31) Q: Who did Ken entertain ___?
A: Ken entertained HIMSÉLF. Object Focus

Perhaps this homophony is not accidental, and the REAFR interpretation could be the result of applying some sort of transformational operation to the structure that yields the object focus pattern in (31), whose derivation is more straightforwardly understandable. (This operation could be in the syntactic, semantic or phonological component – I leave its exact nature open to interpretation.)

In this way, the syntactic structures of (30) and (31) would be identical, and QAC is not violated, if evaluated at the appropriate level of derivation. REAFR interpretations are reliant on an object focus structure, and as such REAFR should be unavailable in any case that object focus is unavailable.

To test this hypothesis, let us consider so-called inherently reflexive predicates, such as *perjure oneself*:

- (38) A: Let me get this straight: MEGAN_F will make Dennis lie on the stand.
 B: No, actually, Dennis will perjure HIMSÉLF. REAFR
 ≈ Dennis is the one who ___ will make Dennis lie on the stand.

If we assume that “*X perjures Xself*” has a meaning like “*X causes an event in which Xself lies on the stand*”, we can understand how the focused anaphor in *perjure Xself* should be interpreted in a REAFR context like (38). Focus on the anaphor is used to deny another person as being the causer of the event of perjury. This interpretation from a focused anaphor is not a normal object-focus reading, but a REAFR reading.

However, if we manipulate the context such that we want to deny the one who is lying in the event of perjury, focus on the anaphor as in (39) is infelicitous.

- (39) A: Let me get this straight: Dennis will make MEGAN_F lie on the stand.
 B: #No, actually, Dennis will perjure HIMSÉLF. #Object Focus
 ≠ Dennis is the one who Dennis will make ___ lie on the stand.
- (40) A: #Who did Dennis perjure ___?
 B: #He perjured HIMSÉLF. #Object Focus

In fact, it is not even possible to question the object of an inherently reflexive predicate, as (40) shows. There is only one kind of argument that can be the object of *perjure* – meaning there are no viable focus alternatives – so focusing the object of an inherent reflexive will always be infelicitous.

Data like data like (38)–(40) show that focus on the anaphor in inherently reflexive predicates is possible, but only with a REAFR interpretation. This is despite the fact the object focus in an inherently reflexive predicate will always be infelicitous. In this way, REAFR ought not depend on an object focus structure input.

4.3.2 Inadequate Account: Unaccusative Reflexive Syntax

Another possibility for deriving REAFR data might involve an syntactic analysis of reflexives whereby they are (at least sometimes) unaccusative structures: the sentential subject is an internal argument, and the reflexive is an external argument (e.g., Marantz 1984, Sportiche 1990, Pesetsky 1995, Rooryck and Vanden Wyngaerd 2011, among many others). That is, in a sentence like (41A),

the surface subject, *Ken*, is in fact the deep structure object (bearing the theme theta role) and *himself* is the deep structure subject (bearing the agent theta role):

- (41) Q: Who entertained Ken? Agent Question in Active
A: Ken entertained HIMSÉLF. REAFR

In this way, the REAFR prosody could be expected. The question seeks information about the agent, and the answer realizes the focus prosody on the agent. This analysis would seem to be supported by the realization of focus in a passive answer to an active question:

- (42) Q: Who entertained Ken? Agent Question in Active
A: Ken was entertained by LÍZ. Focused Agent in Passive

This would mean that REAFR prosody is critically available only when unaccusative syntax is a possible derivational source for a sentence with a reflexive. The question to address is thus, which clauses can have unaccusative syntax with a reflexive anaphor?

Here we will use an argument put forth in Sportiche 2014, concerning the availability of focus alternatives. Consider the fact that (43) is ambiguous:

- (43) Only Jack likes himself.

Under one reading, Jack likes himself, and no one else holds the self-liking property – this is the so-called sloppy reading, in which the anaphor is construed as a semantically bound variable (Büring 2005). Under the other, Jack likes Jack, and no one else holds the Jack-liking property – this is the so-called strict reading, in which the anaphor is construed as a constant (*ibid.*).

Thus, the two readings of (43) can be disambiguated in paraphrases of the following terms:

- (44) a. Jack is the only x such that x likes x Sloppy Reading
b. Jack is the only x such that x likes Jack Strict Reading

(These paraphrases are meant only to be paraphrases, and don't represent what an unaccusative hypothesis for reflexivity predicts. The predictions will be returned to shortly.)

The ambiguity of (43) and the readings in (44) can be confirmed by the fact that (43) can be denied in two ways, each denial corresponding to a paraphrase in (44). The sloppy reading in (44a) can be denied with sentences like *No, Tom likes himself too*, and the strict reading in (44b) can be

denied with sentences like *No, Tom likes Jack too.*

Let us check to see how these two semantic properties of the anaphor meld with what an unaccusative analysis would predict. The unaccusative structure for (43) is as in (45):

(45) [himself]_{Agent} likes [only Jack]_{Theme}

The deep subject is *himself*, which is assigned the Agent theta role, and the deep object is *only Jack*, which has the Theme theta role. To generate paraphrases for this unaccusative structure for reflexives, we replace *only Jack* with a variable *x*, and begin the sentence with ‘*Jack is the only x such that*’. In this way, both paraphrases will have the form of (46):

(46) Jack is the only *x* s.t. himself_{Agent} likes *x*_{Theme} Ambiguous

The difference between the sloppy and strict readings of (46) arise from how we treat *himself* in the paraphrase. In the sloppy reading, *himself* is replaced with a bound variable that covaries with the binder, *only Jack*, giving us:

(47) Jack is the only *x* s.t. *x*_{Agent} likes *x*_{Theme} Sloppy Reading

This corresponds to (44a), and allows the appropriate denial. However, if *himself* is given a constant interpretation, where it is fixed as referring to *Jack*, the strict reading of (45) is as (48):

(48) Jack is the only *x* s.t. Jack_{Agent} likes *x*_{Theme} Strict Reading

This is importantly the wrong prediction. This does not correspond to the other reading, (44b), and instead would be denied *No, Jack likes Tom too.* In other words, the basic prediction of the unaccusative derivation of a sentence like *Only Jack likes himself* would have a structure like (45), and would incorrectly predict a denial of its strict reading to be *No, Jack likes Tom too.*

In fact, reflexives in English are never found to allow a denial of this form, meaning that no reflexives ought to be given unaccusative structures. As such, there is no support for a REAFR

derivation that depends on the anaphor being the external argument of the clause.

4.3.3 Inadequate Account: Emphatic Reflexives

Emphatic Reflexives, exemplified in (49), are similar to REAFR in that they also involve prosodically focused reflexives (e.g., Eckardt 2001, Hole 2002, 2008, Ahn 2010, 2012a).

(49) Emphatic Reflexives

- a. Liz HERSÉLF sold the company.
- b. No one had done their homework THEMSÉLVES.

One possible analysis of REAFR might attempt to relate it to Emphatic Reflexives and their structure. Under this sort of account, REAFR as in (50a) might result from a post-syntactic deletion operation on the Emphatic Reflexive in (50b), or might be derivationally related in some other way.

- (50) a. Ken entertained HIMSÉLF. REAFR
b. Ken entertained himself HIMSÉLF. reflexive object & Emphatic Reflexive

If this were the case, REAFR should only be available in grammatical contexts where an Emphatic Reflexives would be constrained.

To evaluate this account, we require a clear view of the distribution of Emphatic Reflexives. As explicitly discussed and formalized in Ahn 2010, 2012a, Emphatic Reflexives fall into two sub-types, each of which is subject to its own distributional constraints. To consider the possibility that REAFR is formally related to Emphatic Reflexives, we must compare and contrast each sub-type of Emphatic Reflexive with REAFR.

The first of the two Emphatic Reflexives we will discuss is a subject-oriented verbal-adjunct (abbreviated ^{VP}ER). ^{VP}ERs contribute an anti-assistive interpretation, which can be very roughly paraphrased as along the lines of “without help”. Crucially, ^{VP}ERs are only licensed by a subject antecedent that is a volitional Agent. Causers, Experiencers, and Themes cannot license an ^{VP}ER.

- (51) a. No doctor can cure you ^{VP}HIMSÉLF. Agent antecedent; ^{VP}ER
 b. # No medicine can cure you ^{VP}ITSÉLF. Causer antecedent; #^{VP}ER
 c. # No mother worries about it ^{VP}HERSÉLF. Experiencer antecedent; #^{VP}ER
 d. # No response angered the instructor ^{VP}ITSÉLF. Theme antecedent; #^{VP}ER

If it is ^{VP}ERs that are the type of Emphatic Reflexive that REAFR is formally dependent upon, then we should expect to find REAFR ruled out in the range of contexts where ^{VP}ERs are ruled out. However, REAFR is compatible with a subject antecedent with any thematic role – e.g. Agents, Causes, Experiencers, and Themes:

- (52) Q: Who ___ was talking to Emma?
 A: Emma was talking to HERSÉLF. Agent antecedent; REAFR
 (53) Q: What ___ cools graphene transistors?
 A: Due to their inherent properties, they cool THEMSÉLVES. Cause antecedent; REAFR
 (54) Q: Who ___ likes the loudest boy?
 A: The loudest boy likes HIMSÉLF. Experiencer antecedent; REAFR
 (55) Q: What ___ frustrated the instructor?
 A: The instructor frustrated HIMSÉLF. Theme antecedent; REAFR

In short, REAFR is possible in grammatical contexts that exclude ^{VP}ERs. As such, it cannot be the case that REAFR is derived in the same way as ^{VP}ERs.

The second kind of Emphatic Reflexive is an adjunct to the DP (abbreviated ^{DP}ER), and a phrase of the form “X ^{DP}itself” means something like “X, not Y”. ^{DP}ERs are limited to cases where their antecedent is a DP of type ⟨e⟩, ruling out sentences where the ^{DP}ER’s antecedent is a quantified expression, (56b), or non-specific indefinite, (56d).

- (56) a. A midwife washed Billy ^{DP}HIMSÉLF. ⟨e⟩ antecedent; ^{DP}ER
 b. # A midwife washed every newborn boy ^{DP}HIMSÉLF. ⟨et,t⟩ antecedent; #^{DP}ER
 c. A nice girl might want to marry the president ^{DP}HIMSÉLF. ⟨e⟩ antecedent; ^{DP}ER
 d. # A nice girl might want to marry a schizophrenic ^{DP}HIMSÉLF. ⟨e,t⟩ antecedent; #^{DP}ER

However, REAFR is compatible with a DP antecedent of type ⟨e,t⟩ or ⟨et,t⟩:

- (57) Q: Who ___ washed every baby boy?
 A: Every baby boy washed HIMSÉLF. ⟨et,t⟩ antecedent; REAFR
 (58) Q: Who ___ might want to marry a schizophrenic?
 A: A schizophrenic might want to marry HIMSÉLF. ⟨e,t⟩ antecedent; REAFR

Thus, REAFR seem to be felicitous when ^{dp}ERs are not. However, there is another possibility for REAFR cases like (57)-(58): a ^{dp}ER is adjoined to a silent pronoun, which is what yields a REAFR interpretation.⁸ Assuming this silent pronoun to be of semantic type (e), this would give the appropriate type of antecedent. The distribution of silent pronouns is restricted in English; they famously cannot occur in the subject position of a tensed clause. As such, if this hypothesis is correct, the pronoun and ^{dp}ER that yield REAFR would appear as a [pronoun ^{dp}ER] sequence in the subject position. However, a pronoun-^{dp}ER sequence (i.e., *he himself*, in (59A1)) cannot be associated with the REAFR interpretation:

- (59) Q: Who said Floyd went to Cleveland?
 A1: # Floyd said he **HIMSÉLF** went to Cleveland. #REAFR
 A2: **FLÓYD** said he went to Cleveland.

We can make two conclusions about trying to relate REAFR and ^{dp}ERs. First, REAFR is felicitous even when ^{dp}ERs are not. Second, an analysis that tries to makes use of a (silent) pronoun that ^{dp}ERs are adjoined to in order to generate REAFR interpretations predicts REAFR in places where it is impossible. For these reasons alone, a ^{dp}ER ought not to be employed in the derivation for REAFR.

One final argument against using Emphatic Reflexives to derive REAFR has to do with linear order. In particle-verb constructions, an Emphatic Reflexive (^{vp}ER or ^{dp}ER) that is bound by the subject must occur after the verb particle. This is seen in (60).

- (60) a. *Walter warmed it ^{dp/vp}**HIMSÉLF** up. *verb ER particle
 b. Walter warmed it up ^{dp/vp}**HIMSÉLF**. verb particle ER

⁸^{dp}ERs have been analyzed as being highly degraded when adjacent to pro-forms that are not in the nominative case (Lasnik and Sobin 2000):

- i. *? Charles gave {me ^{dp}myself/you ^{dp}yourself/him ^{dp}himself/himself ^{dp}himself} the reward.
- ii.
 - a. {You/Ø} go there!
 - b. {You ^{dp}yourself/*Ø ^{dp}yourself} go there!
 - c. {You/Ø} go there ^{dp}yourself!

The question is of course, *why?*, but without a clear answer, we will assume that there may be some contexts in which a ^{dp}ER can be adjoined to a silent pronoun, even though it is not possible in (ii).

Conversely, a REAFR anaphor must occur between the verb and its particle:⁹

- | | | |
|---------|---|----------------------|
| (61) a. | The coffee won't warm <u>ITSÉLF</u> up. | verb REAFR particle |
| b. | #The coffee won't warm up <u>ITSÉLF</u> . | #verb particle REAFR |

These facts of linear word order provide additional evidence that rules out analyses in which REAFR depends directly upon the syntax of Emphatic Reflexives. In addition, the linear order facts of (61) are informative about the structural position of reflexives that participate in REAFR. Namely, if we take the position between the verb and its particle to be the Case position for direct objects (e.g. Kayne 1985, den Dikken 1995), the generalization could be that REAFR reflexives must surface in their Case position. A proper account of REAFR must address this finding, and the derivation we arrive at in Section 4.4 will do so.

In summary of the facts seen here, REAFR can thus occur in grammatical contexts that exclude ^vPERS, ^{dp}ERS, or both. It does not seem possible, therefore, to posit any structure where REAFR is derivationally dependent on an Emphatic Reflexive structure. In fact, closely considering the differences between Emphatic Reflexives and REAFR has uncovered a new generalization about the structural position of reflexive anaphors in REAFR structures.

4.3.4 Inadequate Account: Anaphor-Antecedent Relationship

Another possible account might propose that, since reflexive anaphors are inherently referentially dependent, (prosodically) focusing the reflexive can in turn (semantically) focus its antecedent.

One specific way to cash this out is that, as a result of the binding operation that takes place between an anaphor and its antecedent in the semantics, the focus feature is able to (optionally) move. This means that a REAFR sentence like (62) would involve mismatching representations at

⁹Some variation has been found here, in which both word orders of (61) are fine for some speakers. This does not affect the line of reasoning pursued here. All speakers allow (61a) and disallow (60a). This is enough to indicate that the grammar distinguishes REAFR from Emphatic Reflexives. The fact that some speakers allow (61b) only indicates that some dialects of English allow ERs and REAFR reflexives to end up in the same linear position. If ERs were at the core of REAFR, the pan-dialectal contrast between (60a) and (61a) would not be predictable.

LF and PF, as in (63).¹⁰

- (62) Q: Who slapped Angie?
 A: Angie slapped HERSELF_F.

(63) LF Structure for REAFR:

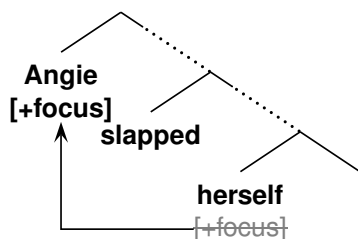

PF Structure for REAFR:

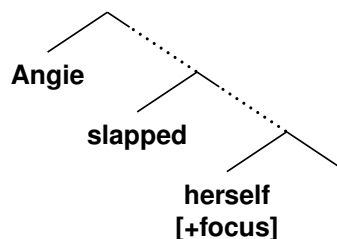

If what licenses this feature movement in LF is the binding mechanism, we should predict that, prosodic focus on any reflexive should be able induce semantic focus any antecedent of binding, regardless of structural or interpretational factors.¹¹ This analysis is insufficient in five ways, as I demonstrate with the data below. In fact, any analysis in which the anaphor-antecedent binding relationship plays a role in deriving REAFR will require additional constraints to adequately account for where REAFR is or is not available.

The first way in which any anaphor-antecedent based account of REAFR is insufficient is that, if the antecedent of the reflexive is not a grammatical subject, REAFR is impossible. Consider the following minimal pair:

- (64) Q: Who ___ introduced Angie to Ken? Agent antecedent
 A1: JACK introduced Angie to Ken.
 A2: #KÉN introduced Angie to himself.
 A3: Ken introduced Angie to HIMSÉLF. REAFR
- (65) Q: Who did Ken introduce ___ to Angie? Theme antecedent
 A1: Ken introduced JACK to Angie.
 A2: #Ken introduced ÁNGIE to herself.
 A3: #Ken introduced Angie to HERSÉLF. #REAFR

¹⁰Alternatively, the focus feature could be on the subject in the syntax, and at PF the feature lowers onto the anaphor, in principle. However, this would be less obviously motivated; LF is sensitive to properties like binding, but PF is not, so it is not clear how PF would ‘know’ where the focus feature should be lowered to.

¹¹This feature movement must not be obligatory, and must instead be sensitive to context. This feature movement must happen for answers to subject questions (where the semantic focus appears to be on the subject), but must not happen for object questions (where the semantic focus appears to remain on the reflexive object).

It may not be entirely apparent that the same focus pattern is exhibited by (64A3) and (65A3), so before we continue on, I will explain how they are the same. To make talking about these examples easier, let us call the XP in the answer that corresponds to the WH phrase in the question, “XP_{ANS}.” Thus, in (64) XP_{ANS} is *Ken*, and in (65), it is *Angie*.

As a description of the what happens at the surface in REAFR, minimally the following seems to necessarily be true:

(66) **Surface Properties of REAFR**

- a. XP_{ANS} (or what it refers to) occurs in the question
- b. where XP_{ANS} occurs in the question, it is replaced, in the answer, by a reflexive anaphor which is co-indexed with XP_{ANS}
- c. the reflexive anaphor bears prosodic focus, and XP_{ANS} does not

In (64A3) behaves just this way: the XP_{ANS} is *Ken*, the *Ken* that occurs in the question is the complement of *to* is replaced by a focus-bearing *himself*, and the *Ken* that fills the question gap has no prosodic focus. The example in (65A3) represents the best-possible parallel to (64A3): the XP_{ANS} is *Angie*; the *Angie* that occurs in the question is the complement of *to*, and is replaced by a focus-bearing *herself*; and the *Angie* that fills the question gap bears no prosodic focus.

It is then unexpected under this account that only the reflexive in (64A3) can felicitously participate in REAFR. Because nothing about this account as it has been formulated could distinguish (64A3) and (65A3), focusing the reflexives in both should be equally felicitous. The minimal difference between (64A3) and (65A3) is that of the structural position and thematic role of the antecedent, implicating the importance of the antecedent’s syntactic properties.

To decide whether structural position or thematic role is the relevant factor, consider an example like (67), with a Theme subject:¹²

¹²Instead, this constraint could also be stated in relative terms about the thematic hierarchy. Ultimately, how this descriptive generalization is formulated will not have great impact on our formal analysis of REAFR.

(67) (Context: *Lately, Rita Mae has been having dreams every night in which someone from the future appears to her and delivers her a message.*)

Q: Who came to Rita Mae in a dream last night?

A1: SÁM came to Rita Mae in a dream last night.

A2: # RITA MÁE came to herself in a dream last night.

A3: Rita Mae came to HERSÉLF in a dream last night.

REAFR

Thus, even Themes can antecede REAFR anaphors, just in case they are the subject. This indicates that subjecthood is the relevant property, motivating the following constraint on REAFR:

(68) **Descriptive Condition on Derived Subjects**

REAFR is not possible if the reflexive anaphor occurs in a clause with a derived subject (e.g. a passive clause).

(Recall the definition of “derived subject” that we are assuming, in Section 3.6.3 of Chapter 3. By this definition, the subject of the answers in (65) is a derived subject, but the subject of (67) is not.) This is the first of several constraints that will inform a proper theoretical account of REAFR.

While having an antecedent that is a subject is necessary to license REAFR, not every subject will suffice. In particular, neither a surface subject antecedent nor a deep subject (i.e. the *by*-phrase expression) antecedent can license REAFR in a passive clause:¹³

(69) Q: Who was Angie introduced to Ken by ____?

Passive agent antecedent

A1: Angie was introduced by JÁCK to Ken.

A2: # Angie was introduced by KÉN to himself.

A3: # Angie was introduced by Ken to HIMSÉLF.

#REAFR

(70) Q: Who ____ was introduced to Ken?

Passive subject antecedent

A1: JÁCK was introduced to Ken.

A2: # KÉN was introduced to himself.

A3: # Ken was introduced to HIMSÉLF.

#REAFR

In addition, passive clauses do not allow REAFR when the antecedent is an object, conforming to (68).

¹³Though (69A) is ungrammatical, it is not so for reasons of binding; (80A) forms a minimal pair with (69A), and (80A) is grammatical.

- (71) Q: Who was Angie introduced to ___ by Ken? Passive object antecedent
 A1: Angie was introduced to JÁCK by Ken.
 A2: # Angie was introduced to KÉN by himself.
 A3: # Angie was introduced to Ken by HIMSÉLF. #REAFR

Despite adhering to the REAFR pattern of focus as described in (66), the attempts at REAFR in (69)–(71) are infelicitous. This indicates that the grammatical voice of the clause in which the reflexive appears – which is arguably the only differentiating factor between (64Q) and (69Q)–(71Q) – affects the availability of REAFR.

(72) **Descriptive Condition on Grammatical Voice**

REAFR is not possible if the reflexive anaphor occurs in a passive clause.

This is beyond what an analysis based on the anaphor-antecedent relationship account could account for.¹⁴

Third, there are clauses meeting the previous two constraints which still disallow REAFR prosody. Namely, when the reflexive is in a syntactic island, as in (73)–(75), REAFR prosody is infelicitous.

- (73) Q: Who ___ entertained Liz and Ken? Coordinate structure island
 A: JÁCK entertained Liz and Ken.
 A: # KÉN entertained Liz and himself.
 A: # Ken entertained Liz and HIMSÉLF. #REAFR
- (74) Q: Who ___ entertained [three people besides Ken]? Adjunct island
 A: JÁCK entertained three people besides Ken.
 A: # KÉN entertained three people besides himself.
 A: # Ken entertained three people besides HIMSÉLF. #REAFR
- (75) Q: Who ___ entertained people like Ken? Reduced relative clause island
 A: JÁCK entertained people like Ken.
 A: # KÉN entertained people like himself.
 A: # Ken entertained people like HIMSÉLF. #REAFR

¹⁴This restriction, in conjunction with the first one in this section, can also be interpreted as limiting REAFR to clauses where its antecedent is both the *surface and deep subject*, similar to the constraint Sportiche 2010 identifies for French *se*. As mentioned in Section 3.6.2 of Chapter 3, this amounts to a descriptive condition which cannot be formalized directly in the grammar. If the constraint were to be stated in this way, it would (correctly) predict that REAFR prosody is unavailable on experiencer reflexives in raising clauses. We return to this in Section 4.4.2.

Given that islands are purely syntactic phenomena, any non-syntactic account cannot capture this kind of data and the matching constraint below.

(76) **Descriptive Condition on Islands**

REAFR is not possible if the reflexive anaphor occurs in an island that excludes (any copy of) its antecedent.

Moreover, the fact that islands play any role at all in determining REAFR felicity suggests that movement is involved in a REAFR derivation.

At this point it is relevant for us to revisit the superficial definition of REAFR, provided in (66). In clauses with REAFR, such as all the preceding data in this section, the XP_{ANS} must not bear focus. On the other hand, the dual focus prosody (as discussed in Section 4.2.3) is felicitous in all of these cases where REAFR has been ruled out. Compare (64)-(65), (67), (69)-(71), and (73)-(75) with their minimal pairs in (77)-(85).

- | | |
|---|--------------------------------|
| (77) Q: Who ___ introduced Angie to Ken? | Agent antecedent |
| A: <u>KÉN</u> introduced Angie to <u>HIMSÉLF</u> . | Dual Focus |
| (78) Q: Who did Ken introduce ___ to Angie? | Theme antecedent |
| A: Ken introduced <u>ÁNGIE</u> to <u>HERSÉLF</u> . | Dual Focus |
| (79) Q: Who ___ came to Liz in in a dream last night? | Theme antecedent |
| A: <u>LÍZ</u> came to <u>HERSÉLF</u> in a dream. | Dual Focus |
| (80) Q: Who was Angie introduced to Ken by ___? | Passive agent antecedent |
| A: Angie was introduced by <u>KÉN</u> to <u>HIMSÉLF</u> . | Dual Focus |
| (81) Q: Who ___ was introduced to Ken? | Passive subject antecedent |
| A: <u>KÉN</u> was introduced to <u>HIMSÉLF</u> . | Dual Focus |
| (82) Q: Who was Angie introduced to ___ by Ken? | Passive object antecedent |
| A: ? Angie was introduced to <u>KÉN</u> by <u>HIMSÉLF</u> . | Dual Focus |
| (83) Q: Who ___ entertained Liz and Ken? | Coordinate structure island |
| A: <u>KÉN</u> entertained Liz and <u>HIMSÉLF</u> . | Dual Focus |
| (84) Q: Who ___ entertained [three people besides Ken]? | Adjunct island |
| A: <u>KÉN</u> entertained three people besides <u>HIMSÉLF</u> . | Dual Focus |
| (85) Q: Who ___ entertained people like Ken? | Reduced relative clause island |
| A: <u>KÉN</u> entertained people like <u>HIMSÉLF</u> . | Dual Focus |

The dual focus response is felicitous regardless of the antecedent's thematic role, the voice of the clause, and syntactic islandhood. This indicates that the dual focus prosody is a separate phe-

nomenon, and care must be taken so as to be sure that there is *no focus* on the XP_{ANS}, when testing the limits of REAFR. (And it is for this reason that the cases of REAFR in imperatives are especially informative; see §4.2.3.)

Fourth, the REAFR reflexive is constrained in its structural position, as we saw in (61) in the previous section. A minimal pair showing this constraint on linear positions for REAFR as compared to an object focus example is given below.

- (86) Q: Who will look Danny up on IMDb?
 A1: Danny will look HIMSÉLF up. REAFR
 A2: # Danny will look up HIMSÉLF.
- (87) Q: Who will Danny look up on IMDb?
 A1: Danny will look HIMSÉLF up. Object Focus
 A2: Danny will look up HIMSÉLF.

REAFR is limited to contexts where the anaphor occurs linearly between the verb and the particle. On the other hand, object focus contexts allow *himself* to occur either before or after the particle. This indicates refutes an often cited logic for the placement of elements like reflexive anaphors between the verb and particle. The claim that is often made is that anaphors are prosodically weak, and the position between the verb and the particle is where such prosodically weak elements must occur.

As (87) shows, it is not the case that all focused anaphors are restricted in this way. Thus, under this sort of account, focus has been said to add prosodic weight, allowing anaphors to occur following the particle. However, this makes the wrong prediction for (86). Despite being focused (thereby prosodically heavier), REAFR anaphors must occur between the verb and the particle.

This restriction on linear order cannot be the result of prosodic weakness of anaphors. This is important for two reasons. First, specific to the problem at hand, since REAFR interpretation is tied to a certain phonological form (i.e. (86A1) and not (86A2)), the restriction on the position of

the REAFR anaphor in particle verbs must be a result of the syntax that feeds both Semantics and Phonology. The REAFR anaphor must occupy a specific structural position – its Case position (e.g. Kayne 1985, den Dikken 1995).

(88) **Descriptive Condition on Linearization**

REAFR is not possible if the reflexive anaphor is not linearized in its Case position.

This contrast between Object Focus and REAFR patterns data clearly shows the need for a unique syntactic derivation for REAFR.

Second, and more broadly, this is a critical finding for the work on the syntax-prosody interface. The source of this contrast in word order possibilities for particle verbs is not prosodic, but is instead syntactic.¹⁵ This challenges a commonly held assumption in work on the syntax prosody interface – perhaps there are no cases where prosodic considerations (e.g., prosodic weight) influence syntax directly.¹⁶

Finally, the fifth fact that an anaphor-antecedent account cannot capture is that, when the reflexivity of a clause is already established in the discourse, REAFR is infelicitous. Consider the minimal pair below.

- | | |
|--|-----------------------|
| (89) Q: Which guy entertained Ken? | Reflexivity not given |
| A1: Ken entertained HIMSÉLF . | REAFR |
| A2: # KÉN entertained himself. | |
| (90) Q: Which guy entertained himself? | Reflexivity given |
| A1: #Ken entertained HIMSÉLF . | #REAFR |
| A2: KÉN entertained himself. | |

If prosodic focus on an anaphor can yield an interpretation of semantic focus on its antecedent, there would be no way to rule out (90A1). This data might, on its own, inspire an account that is purely semantic/pragmatic in nature. Specifically, it could be imagined that the WH phrase

¹⁵More weakly, it is not always prosodic, and it may sometimes be purely syntactic.

¹⁶This is not to say prosodic weight has no place in determining that acceptability of certain outputs. Rather, it calls into question the assumption that such output constraints can influence the syntax directly. (Cf. Büring 2013’s Try-and-Filter approach.)

is, under normal circumstances, sufficiently domain-restricted, so that other participants in the event are ruled out as likely answers. Though interpretational considerations like this indeed play a role in REAFR's felicity in this way (we return to this idea in §4.4.6), a solely semantic/pragmatic account can not straightforwardly capture the syntactic constraints on the distribution of REAFR exhibited in (65)-(75).

(91) **Descriptive Condition on Discourse Information**

REAFR is not possible if the reflexive anaphor occurs in a context in which reflexivity is given information.

The badness of (90A1) is attributable to the fact that given information is being focused. We therefore need a representation of REAFR in which semantic reflexivity is what is focused in REAFR.

4.3.5 Summary of Inadequate Accounts

Though the problem of REAFR may be approached in several logically possible ways, the alternatives presented in §4.3.1–4.3.4, which violate the spirit of QAC, are not tenable. The ways in which these alternative accounts have failed provide important information about the linguistic environments under which REAFR is licensed. Consider the summary of restrictions below:¹⁷

(92) **Constraints on the Distribution of REAFR**

- i. A REAFR anaphor must not be separated from its antecedent by an island boundary.
- ii. A REAFR anaphor cannot occur in a clause in the passive voice.
- iii. The reflexivity of a REAFR clause cannot be given information.
- iv. A REAFR anaphor requires its antecedent to be the local subject.
- v. A REAFR anaphor must be linearized in its Case position.

Of note, (92i-ii,iv-v) are syntactic restrictions, and are essentially the restrictions we found in Chapter 3's investigation of extrametrical reflexives. This is perhaps the most surprising finding here. It is also conceptually very important, as we now have two empirical domains supporting the same theoretical conclusions.

More specifically, (92i) implicates movement on the part of the reflexive, (92ii&iv) indicates

¹⁷The restrictions have been re-ordered for the way in which it will be best to analyze them in the following section.

that subjecthood and clausal voice play a critical role, and (92v) suggests REAFR anaphors occur in a fixed structural position. Any non-syntactic account is faced with the difficult task of explaining away these clearly syntactic properties. In addition, since (92iii) relates to focus interpretation, the structural account to be proposed ought to be able to interface with the prosodic and semantic locus of focus.

4.4 REAFR: Focus and REFL Semantics

To account for all the properties of REAFR, including its distributional constraints in (92) and the fact that the anaphor bears the focus prosody, we will appeal to essentially the same three theoretical constraints on LSOR anaphors we invoked in Chapter 3 for extrametrical reflexive anaphors.

(93) **Theoretical Derivation of Descriptive Constraints on REAFR**

- a. The LSOR-reflexive cannot be separated from VoiceP by an island boundary, because it must move to VoiceP from its base position.
- b. The LSOR-reflexive cannot occur in passive clauses, because LSOR-reflexives rely on the Reflexive Voice^o, while passive relies on some other Voice^o.
- c. The LSOR-reflexive must have a subject antecedent because only subjects occur high enough in the clause to give the reflexive the correct interpretation.

These constraints lead to a derivation in (94), which (for obvious reasons) is essentially identical to the derivation for extrametrical reflexives:

(94) Structure for *Ken introduced Angie to HIMSÉLF*

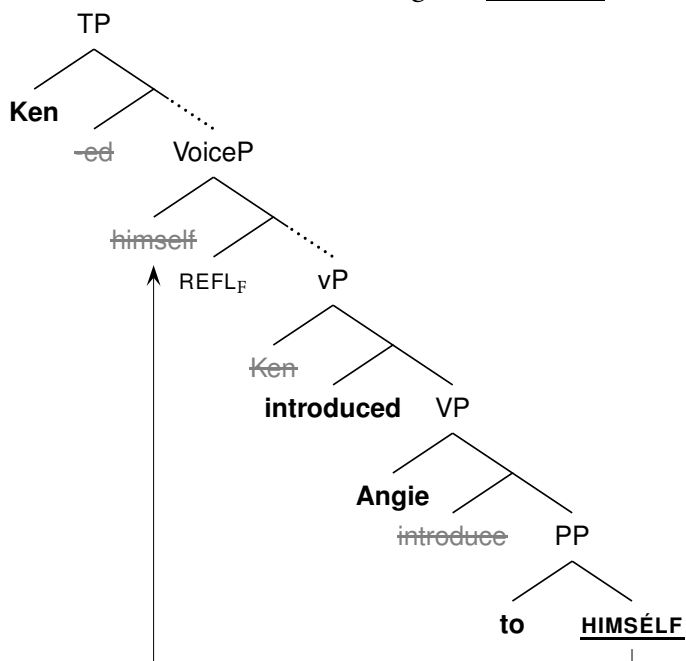

As with extrametrical anaphors, REAFR requires a structure with local subject-oriented reflexive (LSOR) anaphors, which move to the specifier of Reflexive VoiceP. There is only one essential

difference from the derivation for extrametrical anaphors: the semantic reflexivity is under focus. In the derivation in (94), this is represented by the F-marking on the silent REFL. This derivation will yield all of the various properties we have witnessed for REAFR.

4.4.1 Deriving REAFR's Island Sensitivity

The descriptive constraint in (92i) – i.e. that REAFR is restricted to contexts in which the anaphor is not in an island – is captured straightforwardly by an analysis like (94). REAFR is predicated upon LSOR syntax, and therefore the REAFR anaphor must move to Spec, VoiceP. If the anaphor is merged in an island, it cannot move to Spec, VoiceP to satisfy REFL's μ EPP feature.

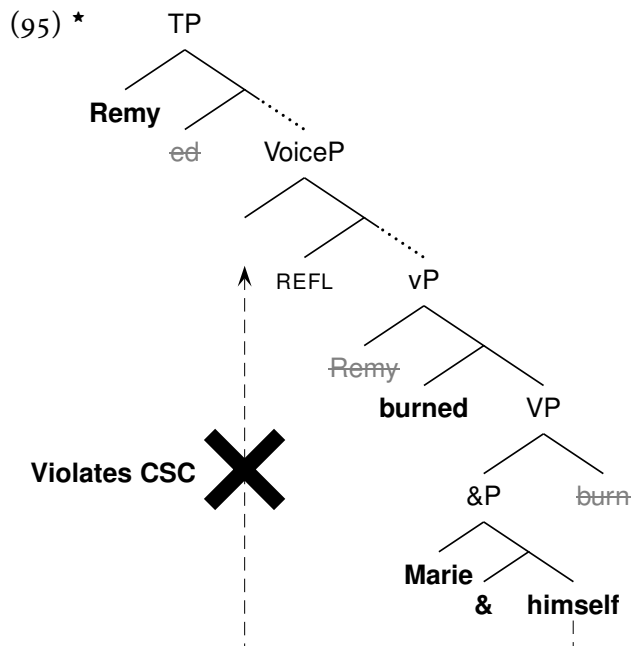

(Failure to move also predicts that the semantic derivation will not converge; we return to this in Section 4.4.5.) Since REAFR can only arise with the anaphor in Spec, VoiceP, anaphors in islands are correctly predicted to be unable to bear REAFR prosody.

Moreover, a derivation in which there is REFL Voice and an anaphor in an island will crash. Since anaphors can grammatically occur in islands, any sentence with such an anaphor must not

involve REFL Voice.¹⁸

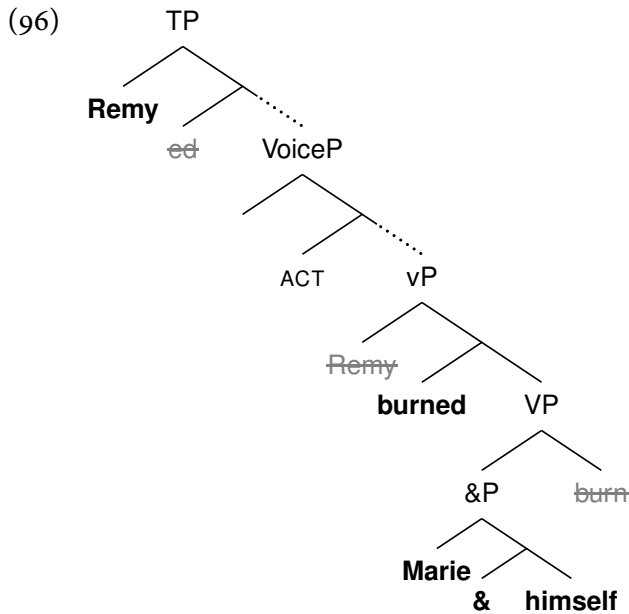

If the Reflexive Voice is to derive the licensing of LSOR anaphors, this means that anaphors like the one in (96) must employ a second mechanism for licensing anaphors – one that does not require movement. (This is an issue we have mentioned before; it is briefly discussed in Chapter 6 and somewhat more deeply discussed in Appendix E.)

4.4.2 Deriving REAFR's Passive Prohibition

Since, as previously discussed, active, passive, middle and reflexive all instantiate the same head, no clause can be in both the reflexive and passive voice. This is for the simple reason that each clause can only ever have at most one VoiceP. Reflexive anaphors are only featurally motivated to move to VoiceP by the Reflexive Voice^o; a Passive VoiceP will never have a reflexive anaphor as its specifier, because the Passive Voice^o does not attract one. In this way, (97) will always be ungrammatical:

¹⁸For further evidence to this effect, see Ahn 2011, which shows that the distribution of strict interpretations in ellipsis is identical to that of active/passive voice mismatch, in the senses of Kehler 2002 and Merchant 2007, 2013.

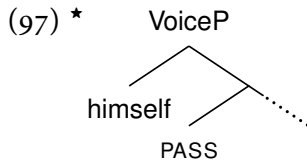

Since REAFR depends a reflexive anaphor sitting in the specifier of a VoiceP headed by the Reflexive Voice^o, simple complementary distribution between the Reflexive and Passive Voice^os derives (92ii)'s restriction against REAFR in passive clauses.

Of course, reflexive anaphors may still be bound in Passive Voice clauses, so as to account for data like (98):

(98) Ken was introduced to himself.

What is relevant is that such anaphors are not LSOR anaphors (i.e., those with exceptional prosodic properties in English), which rely exclusively on REFL Voice.¹⁹

In Chapter 3, we observed that anaphor experiencers in raising-over-experiencer contexts could not be extrametrical, and we analyzed this as being the result of a Passive-like Raising Voice^o. In this way, we correctly predict that our analysis of blocking REAFR in passives extends to data like (99).

- | | |
|--|----------------------|
| (99) Q: Who seems to Jack to have changed? | Raising Voice Clause |
| A1: <u>NÁNCY</u> seems to Jack to have changed. | |
| A2: #Jack seems to <u>HIMSÉLF</u> to have changed. | #REAFR |
| A3: <u>JÁCK</u> seems to <u>HIMSÉLF</u> to have changed. | Dual Focus |

Clauses like (99) involve raising over experiencers, and such structures share many properties (see Orfitelli 2012 and Section 3.7.1.3 of Chapter 3). Analyzing that they have a Raising Voice^o unifies these properties and explains why REAFR is blocked in this context.

¹⁹Similarly, other languages allow binding in passive contexts, with various reflexive markers. For example, Schäfer (2011) discusses data from German (and Icelandic) in which a reflexive marker (*sich*) occurs in passive voice clauses. These reflexives must be further investigated vis-a-vis the generalizations discussed here before we can understand how to analyze them, and before we could consider them as counter-evidence against this theory.

4.4.3 Deriving REAFR's Focus Properties

Let us turn now to how the derivation in (94) is at the core of the focus properties of REAFR, which will derive the prohibition against REAFR in contexts where reflexivity is given (92iii).

Recall that, when the reflexivity is given information as in (90), REAFR prosody is infelicitous. This is due to the fact that REAFR is the result of the *reflexivity* being focused, as independently argued by Spathas (2010, 2012). As such, it must be that the semantic locus of reflexivity is F-marked. The important question is: what is the semantic locus of reflexivity? An LSOR derivation, with REFL Voice, comes with two atoms of reflexivity: the anaphor and the LSOR REFL Voice head. In principle, either of these could be the locus of semantic reflexivity.

The facts we have seen support an analysis the focused semantic reflexivizer is the REFL Voice^o, and the reflexive anaphor acts as its pronominal argument. (We return to the proposed alternative in Spathas 2010, 2012 in Section 4.5.3.) At its most basic, the semantic derivation proceeds instead as (100):²⁰

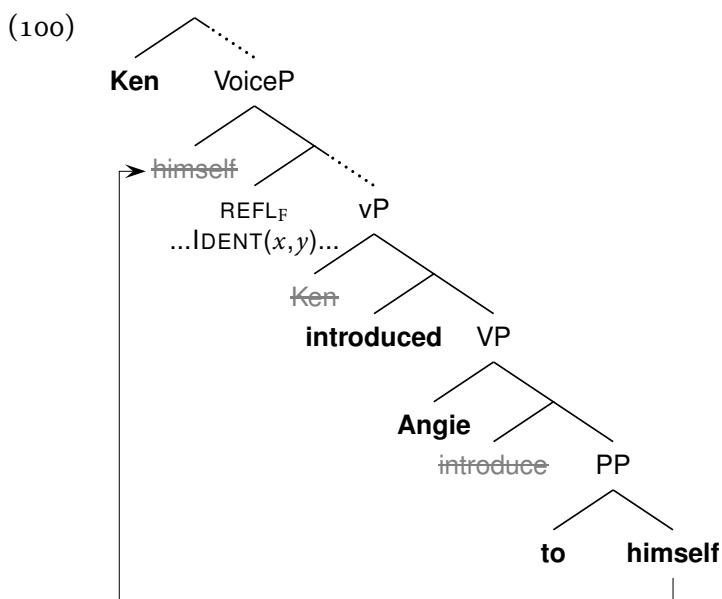

²⁰Anaphors like *himself* may in fact be the locus of semantic reflexivity, but it would have to be that they are only the locus of semantic reflexivity just in case they move to a REFL VoiceP. For more discussion on this or other alternative semantic derivations, see Appendix B.

In this way, the semantics generates focus alternatives where there is not identity that holds between two of the arguments of the predicate. To be clear, the set of focus alternatives would include other Voice^os, which do not entail reflexive identity.²¹ (See §4.4.6.)

This being the structure, the next question is: why does the anaphor bear the focus accent? In order to answer that, we must address the more general question of what happens when silent elements are focus marked. The general observation is that when silent material is semantically focused, the phonological focus surfaces in *a priori* surprising ways.

Laka (1990) argues for a principle like (101), as a specific tool for accounting for such surprising data:²²

(101) **Head-Specifier Focus Transference**

Just in case an F-marked syntactic head is silent, the specifier of that head's projection bears focus prosody.

Before turning to the data that this will account for, let us briefly discuss how this could possibly be derived. In fact, (101) could be made to follow from only a few premises, which are independently necessary. First, given an F-marked constituent, locating prosodic focus is subject to the same principles as locating phrasal stress. Second, phrasal stress is assigned to the most deeply embedded constituent. Third and finally, when the most deeply embedded constituent is silent, the stress is assigned to the next most deeply embedded constituent. If a silent head is focused, our third premise is followed when locating the focus stress, and the next most deeply embedded constituent – typically the specifier – will be the one to bear the stress.²³

As evidence, for this kind of transference, Laka provides polarity focus (a semantically focused Σ) from Basque; the focus accent is borne by the specifier of ΣP when Σ is silent, but by Σ when it

²¹This presupposes that other Voice^os have semantic content. This is corroborated by independent work, including Gehrke and Grillo 2009, which provides an analysis of the semantic content of Voice in Passive clauses.

²²Laka argues that the focus is transmitted from head to specifier via agreement (1990:140), utilizing the same syntactic mechanism as ϕ -feature agreement (p.c.).

²³Appendix H presents some alternatives to Head-Specifier Focus Transference. However, they make more assumptions than can be adequately argued for here. For this reason, I will continue to use the Head-Specifier Focus Transference as a description of the data, recognizing that it may not be the appropriate theoretical mechanism and may be derived by other, well-motivated mechanisms.

is overt:

(102) Basque Polarity Focus

(Laka 1990:105)

- a. IRUNE \emptyset_F da etorri
IRUNE Σ_F has arrived
 'Irune DÍD arrive'

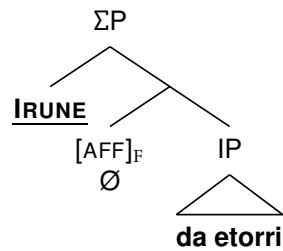

- b. Irune BA_F da etorri
 Irune Σ_F has arrived
 'Irune did sÓ arrive'

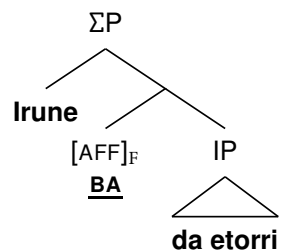

Semantically focus on the same head can result in two different loci of prosodic focus, with the same focus alternatives, depending on whether that head has (the appropriate kind of) phonological material. To be clear, the set of focus alternatives generated in the semantics for both structures in (102) include other possible Σ heads (e.g., the negative polarity head). In this way, a silent head with focus marking leads to apparent mismatches between semantics and prosody, because of the need for phonological stress to associate with segmental material.²⁴ However, this is only an apparent mismatch, as the formal locus of focus marking in the syntax is the same in the underlying representation for both semantics and phonology, and general principles of syntax-phonology and syntax-semantics mapping yield the appropriate phonological and semantic representations.

Similarly, an operation like Head-Specifier Focus Transference is supported by English emphatic polarity: *too* and *not* occur in Spec, Σ P and receive focus prosody when the silent polarity head is focused (e.g. Sailor 2011):²⁵

²⁴An abstractly very similar pattern arises in Irish (so-called Irish Verum Focus), as discussed by McCloskey (2014), in which subject pronouns in some contexts bearing focus prosody with an interpretation of focused polarity. McCloskey explores a different approach to this apparent semantics-phonology mismatch, and the patterns are more complex than the Basque case, as this pattern occurs even in the presence of (what is analyzed as) a pronounced Neg head. It is in principle possible to restate McCloskey's findings in terms compatible with our concept of Head-Specifier Focus Transference, but it remains an open question of whether it is appropriate to do so.

²⁵Perhaps do-support *do* and other V-to-T material may bear the focus prosody for focused silent Σ will be realized

(103) English Polarity Focus

a. Sally did TÓO burn me.

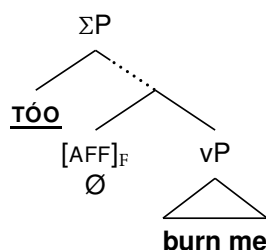

b. Sally did NÓT burn me.

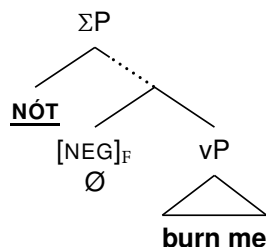

Again, because the locus of semantic focus is a silent head, phonology must exploit the Transference operation, in order for the phonological focus to have segmental material to associate with. Underlyingly, both semantic and phonological focus falls on the Σ head, for which focus alternatives are generated.

A final example of Head-Specifier Focus Transference is discussed in Ahn 2010, 2012a, which find that a silent head ID is what is actually focused in Emphatic Reflexives:²⁶

(104) English Emphatic Reflexives

a. No student did it HIMSÉLF.

b. Jack HIMSÉLF arrived.

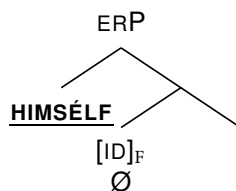

Exactly before, focused silent material yields perhaps surprising phonological results.

A principle like Head-Specifier Focus Transference accounts for the range of data in (102)–(104). Though strictly speaking these data represent exceptions to a descriptive constraint like

on such material. Perhaps this too is an instance of head-to-specifier Transference, assuming the right syntax. Alternatively, *do* and other modals/auxiliaries are simply the next-most-embedded constituents, and will thus bear focus prosody – not in exactly the way described by (101), but in the way described just below (101).

²⁶This assumes that the argument of the intransitive ID head is introduced in its specifier.

QAC, they do not violate the formal principles that give rise to QAC-effects. To be clear, since we lack a Semantics-Phonology interface, the effects of QAC (repeated below) must follow the placement of the F-marking and how it is interpreted at the interfaces. (See Section 2.2.5 of Chapter 2.) This results in the prosodic focus falling on the semantically focused element to the greatest extent possible, which excludes cases where the F-marked constituent is silent.

Returning now to REAFR, when the F-marking on REFL is interpreted by the interfaces (i.e. after VoiceP is sent to Semantics/Phonology at Spell-Out), Semantics will generate a set of focus alternatives to REFL. At the same time, Phonology will view REFL as an impossible candidate for bearing the prosodic focal (as it is phonologically null). Head-Specifier Focus Transference must therefore apply, and the anaphor in Spec,VoiceP will bear the prosodic focus stress associated with the F-marking on REFL. Seeing as the lower copy is what is actually spelled out in this theory, it must be if one member of a chain is assigned an underlying focus stress (e.g., the anaphor in Spec,VoiceP), then all members of the chain have this abstract focus stress mark (e.g., the spelled-out anaphor in its base position). The phonetic component then produces that prosodic stress on the lower copy, as that is the one that is realized in pronunciation. (See Selkirk 1996b and McPherson 2014 for other cases where post-lexical marks associated with one member of a chain are realized in other members of the chain.)

In this way, the REAFR prosody of reflexives that are in Spec,VoiceP, (100), is entirely consistent with the formal principles that yield QAC, in the same way any example involving the Head-Specifier Focus Transference operation of (101) is. REAFR provides no exception to the principles that underlie how F-marking is interpreted by the Semantics and Phonology. Since REFL must be focused, any discourse situation in which it is given will immediately rule out REAFR as a possibility.²⁷ This derives the constraint in (92iii).

²⁷Focusing an argument generally allows you to focus the XP in which it appears, as in VP-focus being borne by the object (see e.g. Selkirk 1996b). However, only the Voice^o, not the entire VoiceP, is focused in (100). Thus it is unlikely that this is like cases of prosodic-object-focus yielding semantic-VP-focus.

We now understand how REAFR focus-placement is derived, but what has not yet been addressed is how the REAFR answers are appropriate for the question that can be used to prompt them. We will return to this question in Section 4.4.6.

4.4.4 Deriving REAFR's Word Order Facts

Recall data like (61), repeated below, which demonstrate that certain word orders are not possible with REAFR, as stated in (92v).

- (61) a. The coffee won't warm **ITSELF** up. REAFR
 b. # The coffee won't warm up **ITSELF**.

That is, for REAFR anaphors, the only possible linear position is between the verb and the particle. In our Reflexive VoiceP analysis, the anaphor moves up to VoiceP but the tail of that movement chain is spelled out, as in (105).

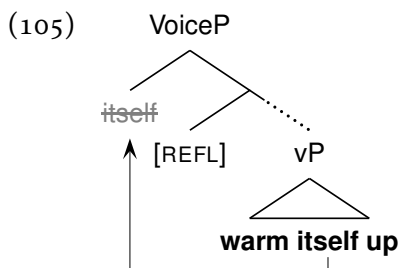

The reason LSOR anaphors occur between verbs and particles has to do with the fact that reflexive anaphors are spelled out in its thematic/Case position, when moving to VoiceP. Since the thematic/Case position of objects is between the verb and the particle (e.g. Kayne 1985, den Dikken 1995), then it is predicted that REAFR interpretation does not arise in (61a), but it does in (61b).²⁸

²⁸This raises the question of how to derive the Object Focus interpretation of (61) —the coffee won't warm up something else, it will warm up itself— to the extent that it is pragmatically possible. I argue that the reflexive anaphor in examples of Object Focus like this is not the reflexive which moves to a REFL VoiceP. Instead, it is a reflexive licensed by a second binding mechanism, which does not induce movement (see Appendix E) – thereby allowing *himself* to behave as any other nominal-expression argument. Such an analysis gains support from the fact that object focus readings in Italian use the non-movement form of the reflexive: *se stesso*. To put it another way, Object Focus always forces the non-movement (i.e. non-LSOR) form of reflexivity to be used. Why this should be the case is an open question, but the generalization is clear: the Object Focus anaphor is not the same as the moving anaphor employed in REAFR.

As discussed in Section 4.3.4, this provides strong argument against a theory in which reflexives occupy the position between the verb and the particle because of prosodic weakness. In fact, since LSOR anaphors occur in the position between the verb and the particle, even when focused (and not prosodically weak), it must be the case that prosodic status as weak or strong is not what determines this linear order. Only the syntax of particles and the syntax of movement to VoiceP determine the ordering between verb, anaphor, and particle.

4.4.5 Deriving REAFR's Subject Orientation through Semantic Composition

Finally, if the semantic function introduced in the REFL Voice^o coidentifies two arguments, the first of those arguments will be the anaphor that is remerged in Spec, VoiceP.²⁹ The second will always be the subject, due to the denotation and syntactic height of REFL function³⁰ and to the fact that all subjects pass through the same phase-internal position in PredP before reaching their surface position in Spec,TP. This is exemplified in (106):^{31,32}

²⁹Movement is implicated in many ways, including islands and thematic interpretation of the anaphor argument.

³⁰The denotation of REFL may have to be slightly amended so that quantified expressions antecedents can be accounted for as well. One solution might be to change the denotation of REFL so that the variable saturated by the subject, y , is of type $\langle et, t \rangle$ and individual-denoting subjects, like *Ken*, are type-lifted so as to be able to compose. Alternatively, only NPs enter bear merge in the thematic domain (quantifiers and determiners merge late in the derivation; see e.g. Sportiche 2005), and the subject NP composes with the IDENT function before it picks up its quantifier/determiner. In such a derivation, at the relevant stage of composition, the antecedent that saturates IDENT's second lambda will always be of type $\langle e, t \rangle$, and no type-shifting would be necessary. (Note: this solution would require the subject NP to stop in the PredP position before the quantifier/determiner is merged.)

³¹For the derivation in (106), I assume that moved objects can recombine, as seems to be in the basic spirit of a copy-theory of movement. This is not a necessary assumption, however, if lower copies undergo Trace Conversion (see Fox 2002). Also see Appendix B for derivations in which objects do not recombine.

³²It is not obvious from the representation in (106) how the vP is semantically composed. Its composition might arise through the lexical entry of the the predicate (in this case *introduce*), in addition to a semantic function in the syntax that is severed from the lexical predicate which introduces the agent (e.g. Kratzer 1996). Alternatively, the structure of what I label as vP is in fact more complex, perhaps with each argument and its theta-assigner being severed from the lexical predicate.

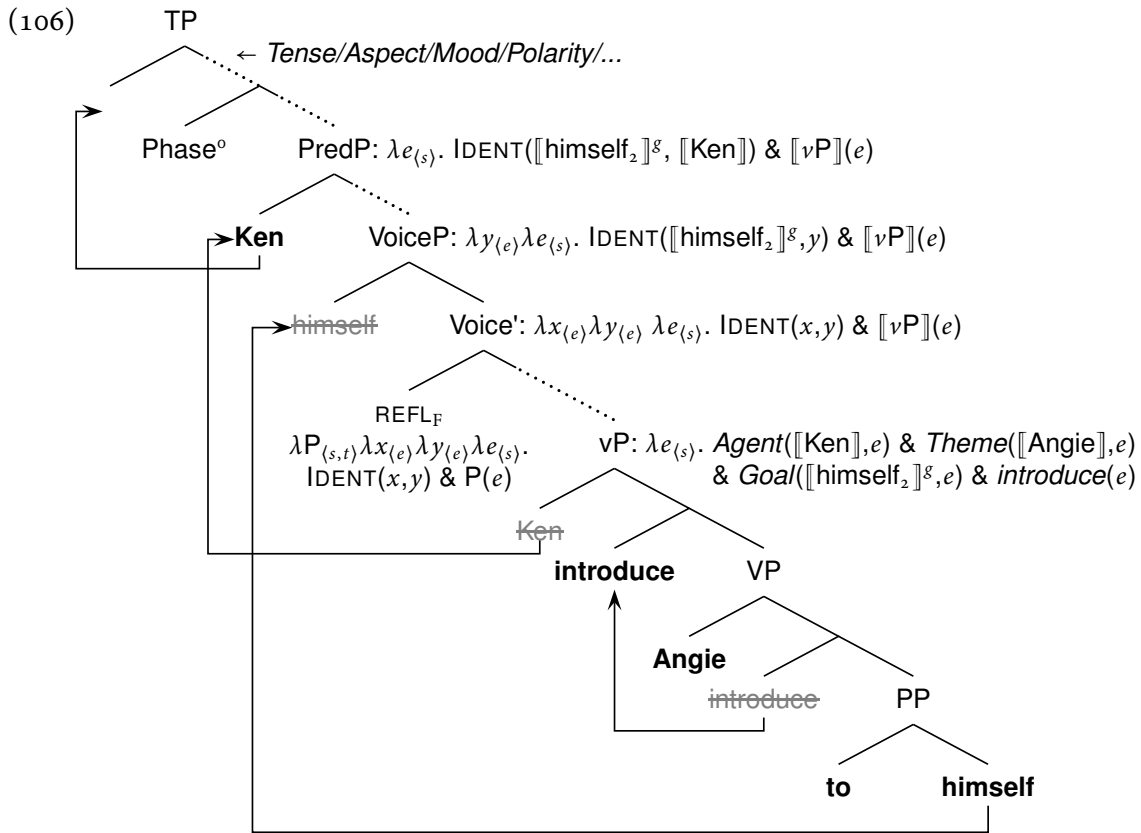

Before reviewing the semantic details of this analysis, let us first understand how its basic syntactic properties. First, all the arguments (*himself*, *Angie*, and *Ken*) are base-generated within the vP, along with the verb. Next, *himself* moves up to VoiceP to check REFL’s EPP feature.

Next, I follow Bowers (2001) in assuming that subjects always move up through a small clause (phase-internal) subject position: the specifier of PredP. (Harwood 2013’s analysis of Transitive Expletive Constructions provides additional evidence for such a phase-internal position for subjects.) Evidence for the relevant subject position being this low in the structure comes from the fact that small clauses also license REAFR.

(107) Q: Who ___ introduced Angie to Ken?

A: I had [_{smallclause} Ken introduce Angie to **HIMSELF**].

REAFR

It is when the subject is in this position that the semantic binding takes place, via the denotation of REFL.

In the semantic derivation, the anaphor behaves in the same way as a pronoun – it is a variable

whose reference is (partially) determined by a contextually-specified assignment function, g :

$$(108) \quad \llbracket \text{himself}_2 \rrbracket^g = g(2)$$

This is consistent with the idea of Lees and Klima 1963 that the difference between *himself* and *him* is only a formal/syntactic one (see also Hornstein 2001). The syntactic component recognizes *himself* as an anaphor, and is thus able to target it for movement to Spec, VoiceP to check REFL's EPP feature for an anaphor (cf. §3.6.3). If some non-anaphor (e.g. *him*) were merged instead, the derivation would not converge, as REFL's μ EPP feature would go unchecked.

The IDENT function instantiated by the REFL Voice^o, (109), is what ensures the binding of *himself* by the local subject in PredP.

$$(109) \quad \llbracket \text{REFL} \rrbracket = \lambda P_{\langle s,t \rangle} \lambda x_{\langle e \rangle} \lambda y_{\langle e \rangle} \lambda e_{\langle s \rangle}. \text{IDENT}(x,y) \ \& \ P(e)$$

Since only anaphors move to Spec, VoiceP of a reflexive voice clause, only anaphors can compose as the first argument of this IDENT function, which asserts that the variable is sufficiently identical³³ to the second argument. IDENT thus essentially constrains the assignment function in (108) by making an independent assertion as to what a reflexive pronoun like *himself* can refer to. Specifically, it must be identical to the second argument of IDENT, which will always be the subject – again, because of the syntactic height of Voice, between the thematic domain and the PredP subject position.

In this way, REFL could never co-identify any other arguments; co-identifying the direct object *Angie* and an indirect object *herself* is impossible. The first argument that can merge with the IDENT function after the anaphor will always be the subject in PredP – no other objects move outside of the thematic domain.³⁴ As such, the subject-orientation of the reflexive in REAFR, (92iv), is the result of mechanical aspects of the way in which reflexivity is formally encoded – no privileged notion of subject needs to be posited in the grammar of locally-bound subject-oriented

³³I make no claims as to what determines “sufficiently identical” – e.g. it may be that a proxy interpretation of an anaphor is sufficiently identical to the antecedent.

³⁴At least, not before the subject moves to PredP. A-bar movements such as WH movement and QR target positions outside of the phase, meaning the first place they land will be the phase edge, which is higher than the subject in PredP.

anaphors (i.e. LSOR anaphors).

An important result of this analysis of LSOR anaphors is that REFL is what ensures that the anaphor is bound, due to the semantics REFL introduces. This fact that *himself* is bound as a result of the semantic computation derives Principle A for LSOR anaphors. Specifically, the c-command restriction of Principle A follows from the fact that both arguments of IDENT must be merged on the spine of the derivation in order to compose with it. The locality restrictions again follow from semantic composition: if the subject were not in the same local domain as the LSOR anaphor, the anaphor would not be bound when the Spell Out domain is sent to Semantics for interpretation. (Non-LSOR anaphors do not involve REFL, and so we are not deriving Principle A effects for them. See Appendix E.) This obviates the need for a representational constraint like Principle A for LSOR anaphors, and instead derives its effects from first principles.

4.4.6 Question-Answer Pairs with REAFR

In Section 4.4.3, we addressed the issue of how focus prosody comes to be on the anaphor: semantic reflexivity is focused, and standard principles of syntax-phonology/syntax-semantics mapping yields the correct interpretation and prosody. What remains unclear is how the REAFR answers are conversationally appropriate responses for the question that can be used to prompt them.

To be concrete, let us consider the question in (110Q), and the REAFR response in (110A2).

(110) Q: Who was distracting Paul?

A1: PÁUL_F was distracting Paul.

A2: Paul was ~~HIMSÉLF~~_F REFL_F distracting HIMSÉLF. REAFR

Before discussing the issue formally, let us briefly discuss each of the answers above in common terms. The answer in (110A1) is appropriate in that the F-marking on *Paul* leads to phonological focus stress on the agent, *Paul*. At the same time, this is appropriate since the question is seeking information about the agent, which is being semantically focused. On the other hand, in (110A2),

the reflexivity is F-marked, leading to the appropriate phonological manifestation of focus on the anaphor (§4.4.3), but it is not clear how this should be semantically appropriate to answer the question, which is not obviously about reflexivity.

To put this discussion in more formal terms, I will employ the analysis of Rooth 1992, where Rooth specifically addresses the nature of what makes a valid question-answer pair, in a focus-alternative approach to the semantics of focus. In this analysis, a valid answer to a question is one in which the ordinary semantic value of the question entails the focus semantic value of the answer. This is formalized in (111):

- (111) **Semantically Appropriate Question-Answer Pairs** (cf. Rooth 1992:(26d))
 For an answer α to be appropriate for a question ψ , the ordinary semantic value of ψ must be a subset of the focus semantic value of α .

Let us apply this principle to (110), to understand how (110A1) is predicted to be a straightforwardly valid answer, while (110A2) is not so clearly valid. The ordinary semantic value of (110Q) is something like (112):

- (112) Ordinary Semantic Value of (110Q)
 $\{ \text{distract}(e) \ \& \ \text{theme}(\underline{\text{Paul}},e) \ \& \ \text{agent}(x,e) \mid x \in E \wedge \text{person}(x) \}$

In general terms, it is the set of people who were distracting Paul. This analysis would allow (110A1) as an acceptable answer, as its focus value is as in (113):

- (113) Focus Semantic Value of (110A1)
 $\{ \text{distract}(e) \ \& \ \text{theme}(\underline{\text{Paul}},e) \ \& \ \text{agent}(x,e) \mid x \in E \}$

In general terms, (113) refers to the set of anything that was distracting Paul. Since the set in (112) is a subset of the set in (113), this is an acceptable answer.

On the other hand, the focus semantic value of (110A2) is as in (114):

- (114) Focus Semantic Value of (110A2)
 $\{ \text{distract}(e) \ \& \ \text{theme}(\underline{\text{himself}},e) \ \& \ \text{agent}(\underline{\text{Paul}},e) \ \& \ R(\underline{\text{himself}},\underline{\text{Paul}}) \mid R \in \{ \text{IDENT}, \text{NON-IDENT} \dots \} \}$

Here, the denotation is the set of situations where $\llbracket \text{Paul} \rrbracket$ was distracting $\llbracket \text{himself} \rrbracket$, and $\llbracket \text{Paul} \rrbracket$ may or may not be identical to $\llbracket \text{himself} \rrbracket$. (Recall that we are treating anaphors as simple pro-

nouns.)

In fact, REAFR responses are not appropriate answers to the question, in terms of Rooth's statement in (111). Instead of directly addressing the question, they address a presupposition it introduces. In particular, I assume that a question like (110Q) has an ordinary semantic value like (115a) and presupposes something like (115b):

- (115) Who was distracting Paul?
a. {distract(e) & theme(Paul, e) & agent(x , e) | $x \in E \wedge \text{person}(x)$ }
b. NON-IDENT(x ,Paul)

The REAFR response functions not as a direct answer to the question, but as a denial of its presupposition in (115b). At the same time, enough information is provided by the ordinary semantic value of the REAFR response, given in (116), to resolve the identity of x in (115a).

- (116) Ordinary Semantic Value of (110A2)
{ distract(e) & theme(himself, e) & agent(Paul, e) & IDENT(himself,Paul) }

In particular, the agent of the event in (116) is *Paul*, and this information can be used to identify that x in (116a) refers to *Paul*.³⁵

To support the notion that REAFR can be used to deny presuppositions in this way, consider the data in (117):

- (117) (Context: *Paul's grades have been suffering since he started dating Jenna. Person A assumes that Paul was being distracted by Jenna, but Person B knows that the person distracting Paul was Paul. Suddenly, Paul's grades improve.*)
A: Oh, Jenna must have stopped distracting Paul.
B: (Actually...) Paul was distracting **HIMSELF**.

Here, A's statement in (117) clearly presupposes that the theme and agent of *distract* are non-identical – in particular, it presupposes that *Paul* is the theme and *Jenna* is the agent. B's response in (117) focuses the reflexivity (i.e. the identity function) to deny this presupposition. The response in (117B) is especially natural if 'Actually...' is used to indicate that a presupposition will be denied. Similarly, it is natural to use 'Actually...' in the same way in REAFR responses to questions. This is

³⁵I do not provide any formalism of how this is achieved, and it is well beyond the scope of this dissertation.

exemplified below, and similarly is possible in all instances of REAFR as a response to a question.

(118) Q: Who was distracting Paul?

A: Actually... Paul was distracting HIMSÉLF. REAFR

Thus REAFR is can be used as a way of denying a presupposition. When it comes to being an answer to questions, REAFR can be used in the same way, but because of the nature of the identity function, REAFR simultaneously provides the listener with the information he/she was seeking.

4.5 REAFR: Advantages of REFL Voice

This approach to reflexivity is able to capture which grammatical contexts allow for REAFR prosody and which do not, based solely on a new approach to how reflexivity is semantically/syntactically encoded. This is something that other, widely-accepted approaches to reflexivity cannot achieve, without secondary stipulations. I will demonstrate this by considering in detail classical binding theory's (CBT) Principle A (Chomsky 1986b, et seq.) and semantic valency-reducing approaches (Bach and Partee 1980, Szabolcsi 1987, Keenan 1988, Schlenker 2005, a.o.) to locally-bound anaphora.³⁶ In addition to discussing other binding theories, I will discuss the advantages that this theory has over some other analytical possibilities for Voice and REFL.

4.5.1 Classical Binding Theory

At its most basic, CBT's Principle A functions as a post-syntactic constraint that checks the structural configuration in which anaphors occur. Roughly speaking, this is given in (119):

(119) **CBT's Principle A**

An anaphor must be c-commanded by a local co-indexed constituent.

This locality principle says nothing about the possible antecedent of an anaphor, except that it must be syntactically local. (Recent investigations suggest that this locality is determined by the phase; Chomsky 2008, Lee-Schoenfeld 2008, Tucker 2010, Charnavel 2012, Charnavel and Sportiche

³⁶This wording is meant to exclude cases of long-distance anaphors and logophors.

2014, *inter alia*.) Thus restricting antecedents to subjects has, in the past, typically involved movement of subject-oriented reflexives. Such a movement-for-locality analysis goes back to at least Kayne 1975, and has been argued in many works (e.g., Pica 1987, Chomsky 1995, Safir 2004).

- (120) Jean₁ se_{1/*2} présenta les enfants₂ se. [French]
 Jean SE introduce.FUT the children
 “Jean will introduce the children to himself.”

However, this movement analysis of when an anaphor must be subject oriented amounts to a stipulation. Movement occurs when it is appropriate, and not otherwise. For that reason, it has no deep explanatory power. Moreover, it fails to predict that reflexive movement cannot occur when the clause is, for example, in the passive voice. If the movement is only to be closer to the binder, why not when the binder is a passive subject? That is, we do not understand why the following derivation does not converge:

- (121) *Les enfants₂ se_{1/*2} sera présenté les-enfants se. [French]
 The children SE PASS.FUT introduced
 “The children will be introduced to themselves.”

Kayne 1975, Rizzi 1986a, and Burzio 1986 attempt to keep this analysis in such cases; but ultimately, their analyses depend on grammatical machinery that has been abandoned and logic that does not follow in modern frameworks. In this way, subject orientation (and thus REAFR) is not derivable through Principle A approaches, even if movement is invoked for purposes of locality. The movement operation is important for this VoiceP approach, however it is not spurious and unmotivated; it is required for syntactic and semantic well-formedness. As we said in Section 4.4.5, this VoiceP approach derives CBT’s Principle A for LSOR anaphors.

4.5.2 Valency Reduction (Broadly Speaking)

Turning now to the semantic valency-reducing approach, it (minimally) takes reflexives to be functions on the predicates in which they appear, having a denotation such as (122):

- (122) $[[\text{SELF}]] = \lambda R \lambda w. R(w)(w)$

As such, the antecedent of the anaphor will always be a co-argument of the same predicate relation (R, above). Thus, imagine we have the following predicate R_2 in (123a), which is a two-place predicate.³⁷ Applying SELF to it yields the reflexive predicate in (123b).

- (123) a. $\llbracket R_2 \rrbracket = \text{SEE}(y)(x)$
 b. $\text{SELF}(\llbracket R_2 \rrbracket) = \text{SEE}(w)(w)$

In the same way, if we have a three-place predicate R_3 like (124a), applying SELF to it could yield any of the three results in (124b).³⁸

- (124) a. $\llbracket R_3 \rrbracket = \text{INTRODUCE}(z)(y)(x)$
 b. $\text{SELF}(\llbracket R_3 \rrbracket) = \begin{cases} \text{INTRODUCE}(w)(w)(x) \\ \text{INTRODUCE}(w)(y)(w) \\ \text{INTRODUCE}(z)(w)(w) \end{cases}$

This should, without further stipulation, predict $R(w)(w)(x)$, which contains an object-oriented reflexive (e.g., *introduce*(to-herself, Angie, Ken); *Ken introduced Angie to herself*), to behave as the other two possibilities in (124b), which each contain a subject-oriented reflexive. However, as the extrametricality and REAFR data in English (as well as a *wide* variety of data across languages) show, the reflexivizing predicate only produces valid outputs of the form $R(w)(y)(w)$ or $R(z)(w)(w)$. Similarly, there is no obvious way in which SELF would be ruled out as applying to a passivized predicate that has two unsaturated arguments, e.g. *be introduced* in (125):

- (125) Angie was introduced to herself.

At one level, there appears to be a predicate of the same form as R_2 above: BE-INTRODUCED(y)(x). SELF should be able to apply to that function, giving BE-INTRODUCED(w)(w).

This ability of SELF to apply in cases of object orientation and passivized predicates has gen-

³⁷Such SELF function relies on the existence of a single lexical predicate that it can target. In other words, there would need to be a semantic constituent with a completely specified argument structure and (at least) two unvalued arguments. We will ignore the fact that such a constituent more-or-less must be abandoned under a Distributed Morphology model, and certainly must be abandoned with a neo-Davidsonian syntax/semantics.

³⁸It ought to be noted that achieving non-subject binding has sometimes required a brute-force effort – manipulating the exact formulation of SELF just in case the binder is not the subject (see e.g. Szabolcsi 1987). This ought to be considered evidence against a unified approach to all instances of English *himself*, and is in line with the theory presented here in which the syntactic/semantic derivation of subject-oriented reflexives is distinct from non-subject-oriented reflexives.

erally been viewed positively. It predicts the observable fact that some reflexive anaphors can be object oriented or occur in passives. However, by the same virtue, it does not predict that reflexive anaphors are a heterogeneous class: i.e. it fails to distinguish LSOR and non-LSOR anaphors. As such, if a lexical reflexivization process is all that underlies the distribution of anaphora, it would fail to predict the distribution of REAFR.

4.5.3 Coargument Theories of Biding (with Valency Reduction)

At this point, we have developed a theory in which semantic reflexivity is introduced outside of the thematic domain, in VoiceP. Reflexives that associate with semantic reflexivity must move to VoiceP in the narrow syntax, and those that do not associate with semantic reflexivity do not move. Crucially, only reflexives that move can bear sole prosodic focus in REAFR contexts, as they are the only ones that associate with the semantic reflexivizer (which is semantically focused).

A very similar, but distinct view has been argued for, in Spathas 2010, 2012. Spathas assumes a framework in which some reflexive anaphors introduce semantic reflexivity (in the vein of Bach and Partee 1980, Keenan 1988, Reinhart and Reuland 1993, *inter alia*). Those reflexive anaphors obligatorily move to adjoin to the verb (to reflexive-mark the predicate, and for semantic composition due to type-mismatch, like QR). Other reflexives do not introduce semantic reflexivity – they are called exempt anaphors.³⁹

In this kind of Voiceless theory of REAFR, like in the Reflexive Voice theory, only reflexives that move can bear focus prosody in REAFR, as they are the only ones that associate with semantic reflexivity, which is semantically focused. Let us call this approach to REAFR the Reductionist Reflexivizing Anaphor (RRA) approach to REAFR.

³⁹Spathas 2012's footnote 4 claims that the cases in the only cases in which anaphors do not license REAFR interpretations are exempt anaphors. Assuming "exempt" refers to anaphors which do not follow principles of grammatical anaphor-licensing, the only anaphors which are exempt that have been investigated here (and in Ahn 2012b) are those in islands. The anaphors that are subject-oriented, are object-oriented, and/or occur in passives that I consider are all non-exempt reflexive anaphors.

Thus, it may seem at first glance that these two theories are simply notational variants of one another, with respect to deriving REAFR; both theories agree upon the following:

(126) **REAFR and Moving Reflexives: Overlap between the Reflexive Voice and RRA Theories**

- i. Moving reflexives are associated with semantic reflexivity
- ii. Moving reflexives can participate in REAFR (when reflexivity is focused)
- iii. Moving reflexives cannot occur in a syntactic island that is smaller than a complete predicate

In addition to agreeing upon the fact that only moving reflexives associate with reflexivity and can therefore participate in REAFR, both theories require that moving reflexives move outside of the predicate, thereby predicting the island facts. However, there are two main ways in which the two differ.

First, in our Reflexive Voice theory, the locus of semantic focus (Voice^o) isn't the same as the locus of prosodic focus (Spec, VoiceP). In an RRA approach to REAFR, the locus of semantic focus and prosodic focus is the same lexical item: the reflexive anaphor that is also the reflexivizer. This difference presents no real issue for deciding between the two theories; a Reflexive Voice theory can be made compatible with this view. (See Appendix B.3.)

Second, while the Reflexive VoiceP theory in this dissertation derives the facts in (127) by employing Reflexive Voice, an RRA approach cannot straightforwardly account for them.

(127) **Properties of Moving Reflexives (Derived in a Reflexive Voice Theory, but not an RRA Theory)**

- i. Moving reflexives must have the grammatical subject as their antecedents
- ii. Moving reflexives cannot appear in passive voice clauses
- iii. Moving reflexives surface in only certain linear positions
- iv. Phrasally extrametrical reflexives are subject to these same constraints

If all non-exempt anaphors that move to VoiceP are semantic reflexivizers, data that corroborate the constraints in (127i-iii), such as (65), (70), and (86A2) —none of which involve exempt anaphors— are left unexplained. Moreover, nothing about an RRA approach can account for (127iv) – though an RRA approach employs movement that could yield extrametricality, it cannot predict that the extrametricality is sensitive to constraints like (127i-iii).

An RRA approach to REAFR seems perhaps more straightforward in its application. However, in order to have the same empirical coverage as a Voice theory, the task in arguing for an RRA approach to REAFR is to account for the properties in (127). It seems to me that (127) would need to be stipulated in an RRA approach, with (127iv) being especially problematic.

4.5.4 Colocated External Argument Introducer and Reflexive Head

In several papers on the subject of grammatical voice, it has been claimed that VoiceP is the projection in which external arguments are syntactically and/or semantically introduced (Kratzer 1996, Alexiadou et al. 2006, Pylkkänen 2008, Lohndal 2011, Harley 2013, Ahn and Sailor 2014, among many others). In fact, many other works have assumed that the projection that determines grammatical voice and introduces external argument are the same, without calling that projection VoiceP (often calling it vP, following Chomsky 1995). A question that we must address is whether it is possible that the Reflexive VoiceP and the external-argument introducing head are the same head.

Any framework under which the semantic introduction of external arguments is also determined by the Voice^o would have to assume that the denotation of the REFL Voice is a conjunction of sorts, as in the simplified denotation in (128):^{40,41}

$$(128) \quad \llbracket \text{REFL} \rrbracket = \lambda P \lambda x \lambda y \lambda e. \text{IDENT}(x, y) \ \& \ \text{EXTARG}(x, e) \ \& \ P(e)$$

In order to support the assumption that I make in this dissertation – that Voice^o is in fact independent of the introduction of external arguments – I demonstrate in this section that a conjunction like (128) makes false predictions for the interpretation of anaphors that bear focus prosody.

⁴⁰The representation in (i) falsely assumes that all external arguments are introduced in the same way (see Pesetsky 1995, Ahn 2012a for reasons that this is not possible). Either there need to be different heads for each kind of external argument (i.e. a one-to-one mapping for theta roles and functional heads), or the head that introduces the external argument must be able to host different semantic functions (i.e. an NP with a given theta role will always originate in the same syntactic projection, but not every theta role has its own unique syntactic projection).

⁴¹Harley 2013 would not assume this denotation for REFL, as the semantic external argument introducer is v^o , while Voice^o is only the *syntactic* introducer of the external argument.

Before getting to arguing against (128), let us consider a separate example of conjunction and the interpretation of focus in English, with the modal auxiliary *will*. It has been claimed that a modal like *will* encodes (at least) the meanings of both future (FUT) and affirmative polarity (AFF), as a sort of conjunction (see e.g. Klein 1998), like in (129):

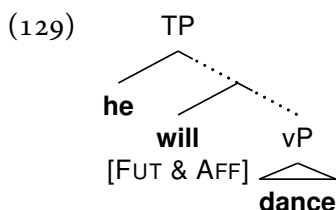

Now consider the fact that *will* can bear focus prosody when either of the conjuncts that it represents are focused. This is exemplified by the exchanges below, where each of B's utterances focuses a different aspect of *will*'s meaning:

(130) A: He won't dance.
 B: You mean, he WILL dance. (FUT & [AFF]_F)

(131) A: He danced.
 B: You mean, he WILL dance. ([FUT]_F & AFF)

Thus a single word that represents a semantic conjunction should be able to bear focus prosody when either of its conjuncts is semantically focused.

By this logic, a conjunctive analysis of Voice^o as in (128) would predict homogeneous placement of prosodic focus, regardless of whether the semantic focus is the EXTARG(x) conjunct or the IDENT(x)(y) conjunct. Since REFL is silent, its specifier would bear focus prosody in either case. This account encounters its first problem, albeit a technical one: which is the (relevant) specifier? That is, under this conjunctive analysis, one might expect Voice to have multiple specifiers to satisfy both of functions that comprise it, as in (132):⁴²

⁴²I assume a merge-over-move constraint, which would mean that Voice merges the external argument as its first specifier before attracting the moved reflexive. It may also be the case that the reflexive is the first specifier (perhaps because of 'Tucking In') – problems similar to those that arise with (i) still arise when the specifier order is different.

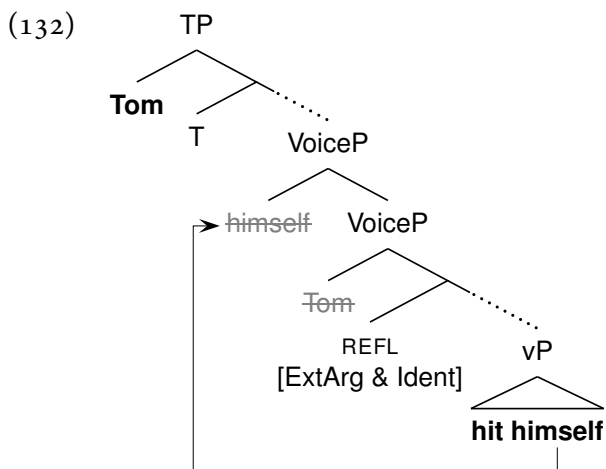

Let us assume that the Head-Specifier Focus Transference mechanism discussed in §4.4.3 targets the first specifier. (This is in the spirit of the justification given to the mechanism just after it is introduced.) If this were the case, we should expect B's response to be felicitous in both of the following discourses:

- (133) A: Who hit himself?
 B: TÓM hit himself. ([ExtArg]_F & Ident)
- (134) A: Who hit Tom?
 B: #TÓM hit himself. (ExtArg & [Ident]_F)

In (133), the silent Voice head introduces the external argument, and when it is focused, it causes the prosodic focus to be realized on the first specifier (the external argument, *Tom*) making a correct prediction of (133)'s felicity. In (134), the same silent Voice head also encodes reflexivity, and when it is focused, it again causes the prosodic focus to be realized on the first specifier (the external argument, *Tom*). However, this is not a felicitous response, and thus this specific formulation of the theory ought to be abandoned.

There is still the possibility of maintaining the conjunctive analysis of REFL, as it could alternatively be that the focus-transference targets the second specifier. (This is decidedly non-local, and likely not the kind of rule that we should posit.) If this were the case, we should expect B's response to be felicitous in both of the following discourses:

- (135) A: Who hit himself?
 B: #Tom hit HIMSÉLF. ([ExtArg]_F & Ident)
- (136) A: Who hit Tom?
 B: Tom hit HIMSÉLF. (ExtArg & [Ident]_F)

This time, the REAFR prosody of (136) is predicted – the reflexivity of Voice^o is focused, and this is realized on the second specifier, *himself*. But now, the prosody for external argument focus in a reflexive clause like (135) is not predicted. That is, if the external argument introducer of Voice^o is focused, prosodic focus is (incorrectly) predicted to fall on the second specifier, *himself*.

Thus, under a conjunctive account of the REFL Voice^o, we cannot simultaneously predict REAFR as well as normal external argument focus in a reflexive clause. For this reason, I argue that it can not be the case that external arguments are introduced by the same head that attracts a reflexive anaphor to its specifier.⁴³ Instead, VoiceP (the projection which controls the clause's grammatical voice) must be outside of the thematic domain.

4.5.5 A Structurally Lower Reflexive Head

Finally, instead of trying to collocate Reflexive and the External Argument introducer, let us consider a structure in which reflexivity is introduced at or below the External Argument introducing projection(s).⁴⁴ More specifically, one could imagine that if reflexivity were as in (137), you would derive subject orientation for (most) reflexive clauses:

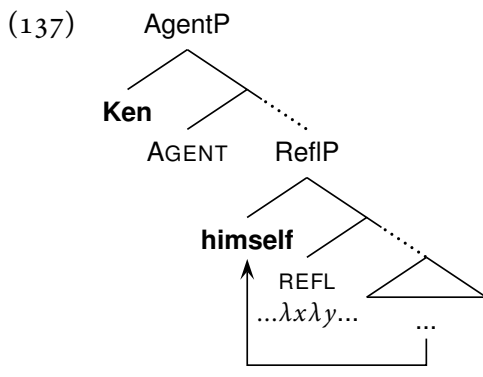

⁴³That said, if Voice^o can be conclusively shown to be the introducer of external arguments, this theory of REAFR is not lost. See Appendix G.

⁴⁴Thanks go to Keir Moulton for discussing this sort of analysis with me.

In this model, REFL must be higher than the position where the reflexive anaphor is introduced so that the reflexive anaphor can move to it. (Recall that there must be movement of the reflexive anaphor, so as to derive the island facts.⁴⁵) Thus, reflexivity would be positioned somewhere between what typically instantiate subjects and what typically instantiate objects:⁴⁶

(138) Agent > Causer > Experiencer > ... REFL ... > Theme > Goal > Oblique

Thus what saturates REFL's λy will always be an Agent, Causer, or Experiencer (and never a Theme, Goal, or Location) because only Agent, Causer, or Experiencer would be in a position to saturate REFL's λy .

The first problem that this model encounters has to do with unaccusatives. If the reflexive's antecedent is a Theme, and REFL's λy is saturated by the argument in the Agent/Causer/Experiencer's thematic position, then unaccusatives are predicted to be incompatible with REFL. In other words, any reflexive anaphor that occurs in an unaccusative ought to be the type which does not move and does not exhibit any REFL properties – including REAFR prosody. This prediction is contradicted by the following kind of data, repeated from (67):

(139) (Context: *Lately, Rita Mae has been having dreams every night in which someone from the future appears to her and delivers her a message.*)

Q: Who came to Rita Mae in a dream last night?

A1: SÁM came to Rita Mae in a dream last night.

A2: # RITA MÁE came to herself in a dream last night.

A3: Rita Mae came to HERSÉLF in a dream last night. REAFR

Since (139A3) is grammatical with REAFR prosody, doubt is cast upon the model in (137). On the other hand, in the model in (106) where Voice is between the complete thematic domain and the Pred^o, the Theme subject will pass through the PredP small-clause subject position, and that is where it will compose with the REFL Voice.

Besides losing the ability to derive subject orientation (and not Agent orientation), a second

⁴⁵Additionally, a theory in which REFL is lower (perhaps bundled with the head that thematically introduces the reflexive anaphor) would be insufficient because it would incorrectly allow non-subjects to bind the anaphors in such a way that would license REAFR prosody.

⁴⁶See Larson 1988 for evidence of Theme > Goal > Oblique, and Ahn 2010, 2012a for evidence of Agent > Causer > Experiencer.

problem for the model in (137) is that it seems to lose the relationship to grammatical voice, which is necessary to derive the passive prohibition and the cross-linguistic data that will be discussed in Chapter 5.

4.5.6 Summary: REAFR and VoiceP

Thus a semantically focused REFL Voice^o that is the locus of reflexivity derives all properties in (92), repeated below:

(92) **Constraints on the Distribution of REAFR**

- i. A REAFR anaphor must not be separated from its antecedent by an island boundary.
- ii. A REAFR anaphor cannot occur in a clause in the passive voice.
- iii. The reflexivity of a REAFR clause cannot be given information.
- iv. A REAFR anaphor requires its antecedent to be the local subject.
- v. A REAFR anaphor must be linearized in its Case position.

This derives as well why the reflexive bears focus prosody in REAFR clauses. Moreover, the data and formalisms introduced in this section expose the need for a second (non-REFL-Voice) binding mechanism. They also expose the fact that a lexical valency-reducing function cannot derive (REAFR) reflexivity, as it does not make the appropriate subject/non-subject distinctions. Perhaps the most important finding we have from this investigation of REAFR is a clear understanding of the nature of subject orientation in LSOR derivations: it is a result of the semantic reflexivizing function that only occurs when the Reflexive Voice^o is merged.

4.6 REAFR as a Diagnostic

4.6.1 Returning to Ditransitives

Recall from Section 3.7.3 of Chapter 3 that extrametrical anaphors offered an inclusive result on the syntax of reflexivity in double object constructions. Specifically, we saw that anaphors in the indirect object position could move to VoiceP, as they avoid phrasal stress where other constituents

bear it, while anaphors in direct object position bear stress:

(140) IO in Double Object Construction

Q: What did Liz do with Danny?

A1: she showed **Jack** [Danny]_G.

A2: # she **showed** Jack [Danny]_G.

A3: # she showed **hersélf** [Danny]_G.

A4: she **showed** herself [Danny]_G.

(141) DO in Double Object Construction

Q: What did Liz do?

A1: She showed Jack **Danny**.

A2: # She showed **Jack** Danny.

A3: She showed Jack **hersélf**.

A4: # She showed **Jack** herself.

We offered multiple possible interpretations of this fact, concluding that either (i) the anaphor in (140) does not move to VoiceP, because of some unknown constraint on movement, or (ii) movement to VoiceP does take place, but prosody-specific constraints impose phrasal stress on the anaphor. With REAFR, we have a new way to test for movement to VoiceP: interpretation of focus stress. This will provide some new evidence to distinguish between these two hypotheses.

First, we will consider the indirect object reflexive anaphor in (142), and its ability to occur with REAFR prosody.

(142) IO in Double Object Construction

(Context: *There are a bunch of pictures of various staff members that Jack has seen. I want to know how showed jack a picture of who.*)

a. Who showed Jack Liz?

b. **DON** showed Jack Liz.

c. # Don showed **JACK** Liz.

d. # (Actually,) **JACK** showed himself Liz.

e. (Actually,) Jack showed **HIMSELF** Liz.

The indirect object anaphor can occur with REAFR prosody, which supports our analysis that REAFR and extrametricality for anaphors are the result of the same core underpinning. Both REAFR and neutral phrasal stress indicate that indirect object anaphors in double object constructions move to VoiceP.

Before turning to the case of direct objects, let us briefly consider the possibilities. If REAFR prosody is not possible with the reflexive anaphor in the direct object position of a double object construction, we have evidence for the hypothesis that movement to VoiceP is blocked by some syntactic mechanism. If REAFR prosody is possible in this context, we have evidence for the hypothesis that movement to VoiceP may take place, and phonology-specific constraints on phrasal stress yield the pattern in (141).

Turning now to the crucial case, what we find is that REAFR prosody is indeed possible when the anaphor is the direct object:

- (143) DO in Double Object Construction
(Context: *There are a bunch of pictures of various staff members that Jack has seen. I want to know how showed jack a picture of who.*)
- a. Who showed Jack Liz?
 - b. **DON** showed Jack Liz.
 - c. #Don showed Jack **LIZ**.
 - d. # (Actually,) **LIZ** showed Jack herself.
 - e. (Actually,) Liz showed Jack **HERSELF**.

This provides support for some phonology-specific constraint(s) on the placement of phrasal stress. In particular, as suggested in Chapter 3, it is likely that the direct object in a double object construction forms its own prosodic domain (iP) as a result of syntax-prosody mapping, and phonology requires that all such domains contain a phrasal stress. This underscores the importance of attending to both syntactic and phonological influences on placement of phrasal stress.

4.6.2 DP-Internal Reflexives

Finally, we will again only briefly explore the nature of reflexives contained within nominal arguments, like the underlined himself in (144):

- (144) Pete showed himself a picture of himself.

As mentioned in Section 3.7.4 of Chapter 3, these anaphors have been widely discussed in the literature and are a source of analytical controversy. The phrasal stress data for (144) is repeated

below.

(145) [_{iP} Pete **shówed** himself] [_{iP} a **phóto** of himself].

The *himself* within *a picture of himself* is extrametrical but this could not possibly be due to movement to the main clause VoiceP – that position is occupied by the indirect object *himself*. Two possibilities were discussed in Chapter 3: (i) there is a second way to achieve extrametricality for nominal-internal anaphors, or (ii) there is a nominal-internal VoiceP which can attract the anaphor *himself*.

If the second hypothesis is correct, we should expect to also be able to find REAFR prosody with this nominal-internal anaphors, where the anaphors bear the sole obligatory focus in a response.⁴⁷

(146) Q: Who gave himself a picture of Pete?
A1: **PÉTE** gave himself a picture of **HIMSÉLF**. Dual Focus
A2: Pete gave himself a picture of **HIMSÉLF**. REAFR

Similar results are found in

(147) Q: Who found a letter to Jack?
A1: **JÁCK** found a letter to **HIMSÉLF**. Dual Focus
A2: Jack found a letter to **HIMSÉLF**. REAFR

Since REAFR is possible in these cases, this adds supports to the analysis that there is a nominal-internal VoiceP to which anaphors can move in English. With this evidence that even nominal arguments may contain REFL VoiceP, we may now have a new approach to solving various standing issues in the domain of so-called picture-NP reflexives.

4.7 Conclusion

In this chapter, we have found that the REAFR phenomenon is not a violation of the grammatical principles that yield the QAC and any other constraints on syntax-semantics-prosody isomor-

⁴⁷The answers in (146) are broken up into two prosodic phrases in the same way as (145). For (146A2), there is phrasal stress on *gave* in the first iP, and the sole focus stress of the clause is in the second iP, on the nominal-internal *himself*.

phism. At the same time, only derivations in which anaphors that move to VoiceP introduce the semantic reflexivizer that is semantically focused in REAFR. (If the semantic reflexivizing function were not tied to Reflexive Voice in this way, REAFR interpretations should be much more widely available than seen in Section 4.3.4.)

Instead, at the core of the apparent mismatch is a silent Reflexive Voice^o which denotes the semantic reflexivizer, and which attracts a reflexive anaphor to its specifier. This basic analysis is laid out as (148):

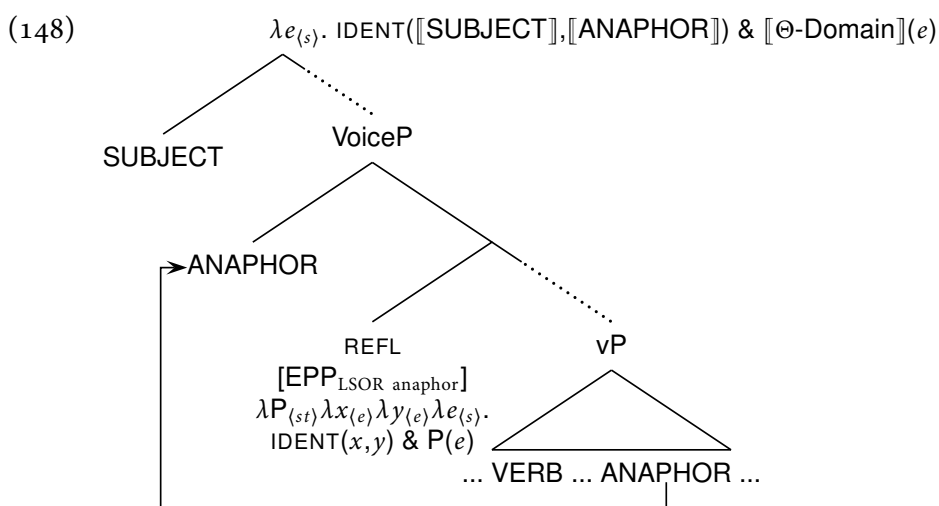

In addition, REAFR include F-marking on the Reflexive Voice head, which both Semantics and Phonology interpret, giving rise to the REAFR interpretation and prosody.

It is notable that—in general—apparent mismatches like the one in REAFR only arise when a silent lexical item that is F-marked is sent to Phonology. In such cases, focus prosody undergoes a regular shifting process so that phonology can properly express the F feature, in accordance with general rules of syntax-prosody mapping. (We saw additional cases of this shifting from other empirical domains.) In particular in REAFR, the silent REFL’s prosodic focus gets shifted to its specifier, the reflexive anaphor. This supports a strong theory in which there are maximally few mismatches between the syntactic, semantic and prosodic structure.

As a result of this Voice-mediated approach to binding, the seemingly exceptional qualities of

REAFR, and all of the constraints on its occurrence, are the expected results of independently motivated structural mechanisms. Grammatical derivations are highly restricted by the grammatical properties of REFL; the only ones that converge are those in which the IDENT function coidentifies the subject and the anaphor that moves to VoiceP.

It is important to note, however, that though the data to be accounted for is captured by the formalisms above and framework assumed, there are only a few aspects of the analysis that are truly necessary.

(149) **The Core Aspects of the REAFR Derivation**

- i. There are two atoms of reflexivity in LSOR:
 - (a) an anaphor merged in an argument position, and
 - (b) a Reflexive head on the spine that is associated with grammatical voice and the semantic reflexivizing function
- ii. These two atoms yield the LSOR properties:
 - (a) The anaphor undergoes movement when the Reflexive Voice^o is merged, and
 - (b) The local subject necessarily binds the LSOR anaphor, due to the syntactic structure and normal rules of semantic composition.

Reducing this account to these fundamental properties of the derivation allows this theory to be easily translated into various different specific implementations. For some derivations with alternative formalisms (including LF movement, lambda abstraction, and a different syntactic locus for the IDENT function), see Appendix B.

Critically, REAFR anaphors and extrametrical reflexive anaphors share the same core constraints:

(150) **Constraints on the Prosodically Exceptional Reflexive Anaphors**

- i. The clause's grammatical voice must be Reflexive.
- ii. The anaphor must not be separated from Reflexive Voice by an island boundary.
- iii. The anaphor's antecedent must be the local subject of the clause.
- iv. The anaphor is linearized in its Case position.

That the two share this set of constraints is importantly indicative of the shared syntax between REAFR and extrametrical reflexives. This is entirely unpredicted if prosodically focused reflexive anaphors and extrametrical reflexive anaphors were each the result of different exceptional prop-

erties attributed to anaphors. Instead, the constraints illuminate that the two share a syntactic base, which influences prosodic properties.

Exploring REAFR has allowed us to understand the local subject orientation property shared by REAFR and extrametrical anaphors. The semantics of an LSOR clause (which by definition involves a Reflexive Voice^o) only properly converges when anaphor specifier of VoiceP and the subject in PredP compose with the IDENT function of the Voice^o. In this way, the Reflexive Voice^o derives Principle A effects for LSOR anaphors, and first principles alone cause LSOR anaphors to be bound by local subjects.

Finally, this account is able to predict that reflexivity in English is fundamentally the same as it is in other languages, despite superficial differences. In particular, English exhibits unique grammatical properties in the context of Local Subject Oriented Reflexivity (LSOR), apart from other types of reflexivity. The crosslinguistic applicability of a Reflexive VoiceP analysis will be the primary focus of the following chapter. Any languages whose surface forms do not readily exhibit LSOR properties, such as English, would only need more careful investigation into the data to reveal it.

CHAPTER 5

Local Subject Oriented Reflexivity, Cross-Linguistically

“The qualities of bodies, which admit neither intension nor remission of degrees, and which are found to belong to all bodies within the reach of our experiments, are to be esteemed the universal qualities of all bodies whatsoever.”

– Sir Isaac Newton, Rules of Reasoning in Philosophy: Rule III (1687)

“I strongly suspect that essential aspects of reflexivization are a universal phenomenon.”

– Paul Postal, A Note on 'Understood Transitively' (1966)

In the previous chapters, the most notable empirical observations that emerged were the fact that reflexive anaphors of a certain type in English behave prosodically distinct from others. This entails that there are different types of reflexive anaphors in natural language, which the grammar can formally distinguish from one another. Past research corroborates this, providing an ontology of different anaphoric subtypes like (1) below:¹

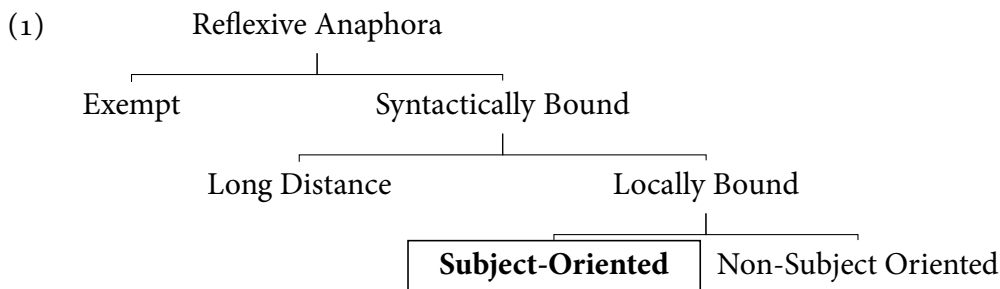

Despite this, in the development of binding theory, attention has been primarily paid to account-

¹This ontology, inspired in part by Sportiche 2012, is intended to be descriptive, and it is almost certainly incomplete. There are different types of long-distance reflexives, and there are different types of exempt anaphors, possibly including (the different types of) logophors.

ing for as wide a range of empirical phenomena as possible. While it may be desirable in terms of formal simplicity for there to be one theory of binding that governs all anaphors in the same way, this aesthetic desire ought to be abandoned in favor of more complex solutions when necessary.

As we have already seen in Chapters 3 and 4, some types of reflexivity involve different syntactic derivations, with observable prosodic and semantic effects. As such, instead of aiming to develop a theory that accounts for as many of these distinct phenomena as possible, this chapter follows the previous two and focuses on the type boxed in (1): where the reflexivity is clause-bound, with the local subject as antecedent. We have been calling this Local Subject-Oriented Reflexivity (LSOR). Investigation of LSOR reveals the necessity for a derivation of the binding facts that is fundamentally different from other types of reflexivity.

As this chapter deals with a different set of languages and possibly different phenomena, we will largely ignore the findings of the previous two chapters. We will use very similar logic for this new set of crosslinguistic data, and ultimately we will be led to the same structural conclusions that we arrived at for English. We then extend our investigation to explore new puzzles about the forms that LSOR clauses can take, across languages.

5.1 The Puzzles

Shona (Bantu) distinguishes LSOR from other types of reflexive anaphora by employing a *zvi-* agreement morpheme only in LSOR contexts, and not in any of the other reflexive contexts in (1). This is exemplified by the fact that the *zvi-* marked predicate in (2) only allows one reading:

- (2) Mufaro a- ka- **zvi-** bik -ir -a mbudzi [Shona]
 Mufaro.1 SUBJ.1-PST-**LSOR**-cook-APPL-FV goat.9
 'Mufaro_i cooked the goat_j for himself_{i/*j}.' (Storoshenko 2009:(23))

Specifically, since *zvi-* is an LSOR marker, the only possible reading of (2) is one where the beneficiary argument of *cook* in (2) is bound by the subject *Mufaro*, and not by the direct object *mbudzi*.²

²Importantly, if (2) were embedded, the antecedent of the bound argument could not be the matrix subject.

A great number of languages overtly distinguish LSOR from other types of reflexivity. A brief list of languages and the relevant marker is given in (3):

(3)	Danish	<i>sig selv</i>	(Scandinavian, Vikner 1985)
	Inuit	<i>immi</i>	(Eskimo–Aleut; Bittner 1994a)
	Japanese	<i>zibunzisin</i>	(Altaic; Katada 1991)
	Kannada	<i>-koL</i>	(Dravidian; Lidz 1996)
	Lakhota	<i>ic’i-</i>	(Siouan; Charnavel 2009)
	Romance	<i>se/si</i>	(Kayne 1975, Burzio 1986, Rizzi 1986a, Sportiche 2010)
	Russian	<i>sebe</i>	(Slavic; Timberlake 1979)
	Shona	<i>zvi-</i>	(Atlantic-Congo; Storoshenko 2009)
	Toro So	<i>unO</i>	(Dogon; Culy et al. 1994)
	...		

LSOR marking is present even in languages that have emerged more recently, such as Russian Sign Language and Sign Language of the Netherlands (Kimmelman 2009).

Considering the fact subject-orientation is a necessary property for this cross-linguistically pervasive type of reflexivity, we are led to our first puzzle, a naïve one:

(4) **Naïve Subject-Orientation Puzzle**

Why is it that special morphosyntactic marking of reflexives occurs only when the *subject* is the antecedent of the bound argument?

This question can be put in more theoretical terms as the following: why is morphosyntactic marking of reflexivity sensitive to the grammatical role of the bound argument’s antecedent, and why must that grammatical role be the subject? In addition, this puzzle can be put in more empirical terms: why is there no language with special marking of reflexivity for when an object (as opposed to all other grammatical roles) is the antecedent of the binding relationship? Thus, one of our primary goals is to determine what it is about subjects that is tied to the formal representation of (this sub-type of) reflexivity.

In addition, it is not the case that all subjects can license LSOR. That is to say, though subject-orientation is a necessary condition on licensing LSOR, it is not a sufficient condition. It has been noticed many times in the literature that passive and raised subjects cannot license LSOR in a variety of languages (Burzio 1986, Kayne 1975, Lidz 1996, Rizzi 1986a, Sportiche 2010, Storoshenko

2009, among others) – including English, as seen in the previous two chapters. Taking this into account now raises a more empirically-informed (and more complex) puzzle.

(5) **Informed Subject-Orientation Puzzle**

Why can only some subjects license LSOR?

These two puzzles are at the core of the issue of LSOR structure. To the extent that the puzzles in (4) and (5) have been noticed, existing accounts have not attempted to tackle them exhaustively; in particular none attempts to address them in a wide range of languages simultaneously. A proper account of LSOR will not only solve these puzzles, but will also derive the LSOR/non-LSOR distinction and empirical differences between the two, without stipulation. Section 5.2 lays out some of the previous approaches, elaborating the issues and the minimum requirements for an adequate analysis of LSOR.

After solving the general mechanics of LSOR, there remain some important questions about the specifics of how languages implement LSOR, morpho-syntactically. In many languages, the anaphor used in LSOR contexts may differ from the reflexive anaphor used in other contexts; for example, French *se* is used in LSOR contexts, but *lui-même* is used as a reflexive anaphor in other contexts. Descriptively, this generalization is clear, but theoretically it is important to understand what it is that allows LSOR contexts to influence which anaphor to appear.

(6) **LSOR Anaphoric Form Puzzle**

What about LSOR contexts effects the morphological form of the reflexive anaphor?

Moreover, different languages involve different “constructions” to mark LSOR; and the range of possibilities is quite wide. Languages have been observed to use some number (possibly zero) of the following “strategies”: special anaphors, verbal marking, and special word orders, among others. This raises a challenge for a theory that should apply cross-linguistically:

(7) **Typological Puzzle**

What is the range of possibilities for marking LSOR, and why?

How ought a theoretician approach the range of possibilities for LSOR marking? This very important puzzle has not received adequate attention in the literature on binding. The solution to both

of these puzzles is rooted in the syntactic solution to the former two puzzles, with the specifics falling out from general principles on structure-form mapping.

It will be shown that a proper solution to all of these puzzles will have the following two central components:

(8) The Core Underpinnings of LSOR

- i. There are two atoms of reflexivity in LSOR:
 - (a) an anaphor merged in an argument position, and
 - (b) a Reflexive head on the spine that is associated with grammatical voice and the semantic reflexivizing function
- ii. These two atoms yield the LSOR properties:
 - (a) The anaphor undergoes movement when the Reflexive Voice^o is merged, and
 - (b) The local subject necessarily binds the LSOR anaphor, due to the syntactic structure and normal rules of semantic composition.

The syntax of a novel solution that incorporates these underpinnings is sketched out in (9):³

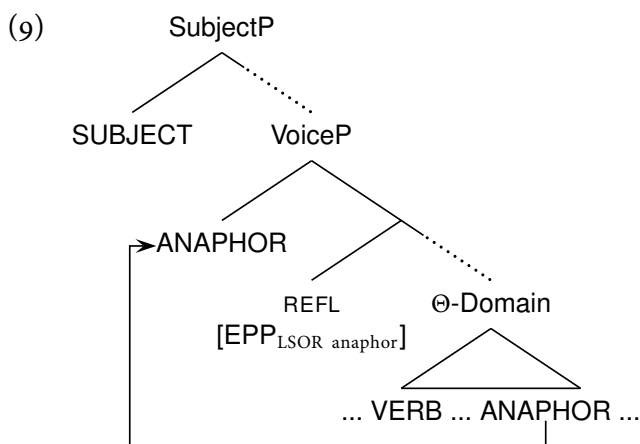

This structure and its underpinnings are identical to those motivated in the previous two chapters for English. Section 5.3 lays out the specifics of this derivation, and then shows that its syntactic properties and its semantic interpretation derive the solutions to our puzzles. This provides a framework in which we can analyze a range of languages, beyond English.

Section 5.4 explores how this analysis predicts the range in variety of “strategies” used to mark

³As this chapter deals with language data from many languages, I am more cautious with the use of grammatical labels, using SubjectP (instead of TP) for the surface position of subjects, and Θ-Domain (instead of *v*P) for the stretch of structure in which all arguments of a predicate are introduced.

LSOR, across languages. The fact that languages make use of special reflexive pronouns, special word orders, and/or verbal affixes in LSOR clauses can be explained straightforwardly with the sort of analysis laid out in (8) and (9). Moreover, we can also explain a well-documented fact that LSOR marking often overlaps with (non-reflexive) Voice marking (e.g. Lidz 1996), while its usage in LSOR has properties distinct from its usage in other Voices.

In summary, this chapter provides evidence that LSOR, all its properties, and apparent variation emerge simply from what UG provides, namely (i) the syntax-semantics interface, and (ii) the REFL Voice^o.

5.2 Previous Approaches to LSOR and Some Standing Issues

By definition, LSOR markers cannot be used in clauses describing reflexive events when the local subject is not the binder of an anaphoric argument. Despite this, well-established theories of reflexivity – both semantic ones and syntactic ones – cannot (or do not) distinguish binding by a subject and binding by a non-subject from one another.

Consider the following very short list of brief descriptions of previous binding theories in (10). None of these as they are formulated can distinguish LSOR binding from non-LSOR binding.

(10) A Very Brief and Simplified List of Previous Approaches to Binding

i. *Valency-Reducing Theories:*

A reflexivizing predicate, SELF, operates on a function, R that has (at least) two open variables, and coidentifies them; SELF(P(x,y)) returns P(x,x). (e.g. Bach and Partee 1980, Keenan 1988)

ii. *Semantic Co-argument Theories:*

(Certain) reflexive anaphors must be bound by a semantic co-argument of a reflexive-marked predicate. (e.g. Reinhart and Reuland 1993, Reuland 2011)

iii. *Principle A Theories:*

Reflexive anaphors must be bound by a c-commanding constituent, within a syntactically-

defined binding domain. (e.g. Chomsky 1981a)

iv. *Movement-Chain Theories:*

Reflexive anaphors form a movement chain with their antecedents (and are therefore bound), and are the Spell-Out of certain types of traces. (e.g. Hornstein 2001)

v. *Antecedent Movement Theories:*

Reflexive anaphors form an underlying constituent with their antecedent, where binding occurs locally; the antecedent moves and strands the anaphor. (e.g. Kayne 2002)

Valency-reducing theories, (10i), and semantic co-argument theories, (10ii), simply cannot refer to the notion of ‘subject’ in the adequate way. As it relates to LSOR, ‘subject’ is a structural notion, not one of semantic argument structure, and as such these formalisms cannot on their own place appropriate constraints to derive LSOR.⁴ In addition, syntactic binding theories in the spirit of Principle A, (10iii), do not refer to subjects either; they only place constraints on the anaphors, not on the grammatical roles of their antecedents. Similarly, movement-based syntactic theories of binding, (10iv) and (10v), do not made any reference to the subject position as unique in any way that would affect reflexive licensing. As such, though formally possible for a syntactic theory to refer to a syntactic primitive like subjecthood, previous analyses do not, and thus cannot distinguish LSOR from other types of reflexivity.

In the frame of this chapter, it might seem that this inability of previous binding theories is a short-coming; however, it has in fact been seen as a benefit, as it seems that not all languages differentiate LSOR anaphora from non-LSOR anaphora. Consider the fact that English uses a single set of anaphoric pronouns for LSOR and non-LSOR contexts:

- (11) a. Ken_k assigned Angie_j to herself_j.
b. Ken_k assigned Angie_j to himself_k.

This has led to the following (implicit) line of reasoning: though reflexivity is an inherent aspect of language, LSOR is not – not all languages appear to distinguish LSOR from other kinds of reflexivity. (That said, we know from the previous two chapters that even English distinguishes LSOR

⁴Though there is a semantic notion of ‘subject’ (i.e. ‘highest thematic argument’), this notion is not what is meant by ‘subject’ here. We will see in Section 5.3 that this notion of subject plays a role, but is ultimately inadequate. Moreover, even though these semantic theories can in principle refer to this (insufficient) notion of subject, they do not.

and non-LSOR structures.) As such, all languages share a base of rules governing the distribution of reflexives (which apply to LSOR and non-LSOR types of reflexivity), and LSOR —when it occurs— is the result of some additional, language-specific rule(s) and/or mechanism(s).

5.2.1 Past Movement Approaches and Our Puzzles

Turning now to previous approaches to LSOR, the additional mechanism needed to solve the Naïve Subject-Orientation Puzzle, (4), has traditionally been movement of the anaphor. That is, the anaphor moves to a position from which the closest and only possible antecedent could be the local subject. This movement has typically been said to target a position in the INFL region, and can possibly take place at LF.⁵ This tendency in derivational approaches has been noted before:

“[T]he most prominently defended mechanism for explaining the cross-linguistic variety of locality conditions on anaphors has been to posit (covert) movement to the more local domain.” (Safir 2004:7)

Let us characterize the theoretical logic of such approaches, in which LSOR is reduced to anaphor-movement and normal binding conditions, generally as (12):

(12) **Reductionist Movement Approach to LSOR**

In an LSOR context, the anaphor undergoes movement from a thematic position to a position near to the subject (e.g. the INFL domain). The anaphor is necessarily bound by the subject, as a result of locality and normal binding conditions.

As an example of a reductionist approach, Kayne 1975 argues that the reason that reflexive clitics in French are subject-oriented is that they overtly move to a preverbal position, from which position the only potential binder is the subject:

⁵Hornstein (2001) and Kayne (2002) also employ movement to relate the anaphor and its antecedent, but they differ from other movement theories in that they do not posit that the anaphor itself moves. Hornstein posits that the anaphor is the spell-out of (a certain subset of) trace positions of the antecedent, and Kayne posits that the anaphor and its antecedent form an underlying constituent and the antecedent is what moves, stranding the anaphor. Thus, without identifying movement of an argument to the local subject position as unique from all other kinds of movement, these analyses would also need to posit a secondary mechanism or constraint to ensure that local subjects are the antecedent in LSOR clauses – perhaps in the same way as these other previous movement-based approaches to LSOR.

In the body of this chapter, I focus on theories in which the anaphor moves. However, with little to no substantive changes to the discussions of anaphor-movement theories, these discussions apply to the Hornstein and Kayne theories as well.

- (13) Jean₁ s'_{1/*2} est présenté les enfants₂ se. [French]
 Jean **LSOR** PERF introduced the children
 "Jean introduced the children to himself."

Safir (2004) also argues (based on the logic of Pica 1987) that the Norwegian LSOR *seg selv* (and other related Mainland Scandinavian anaphors) is subject-oriented, due to covert movement of *seg* that targets a landing site that is local to the subject position:

- (14) Jon₁ seg fortalte meg₂ om seg selv_{1/*2} [Norwegian]
 Jon told me about **LSOR**
 "Jon told me about himself."

Along these lines, Chomsky 1995 (Ch.1) promotes a reductionist approach for binding more generally:⁶

"...the reflexive must move to a position sufficiently near its antecedent. This might happen in the syntax, as in the cliticization processes of the Romance languages. If not, then it must happen in the LF component."

Thus one should expect to extend a reductionist movement analysis to languages like Czech (Slavic) and Inuit (Eskimo-Aleut), in which the anaphors are subject-oriented (data from Toman 1991 and Bittner 1994a):

- (15) Hrabě₁ si pronajal sluhy₂ si_{1/*2} [Czech]
 count **LSOR.DAT** rented servants
 "The count rented servants to himself."

- (16) Juuna₁-p ~~immi~~ Kaali₂ immi_{1/*2}-nik uqaluttuup-p -a -a [Inuit]
 Juuna -ERG Kaali **LSOR** -INS tell -IND-[+tr]-3SG.3SG
 "Juuna told Kaali about himself (Juuna)."

As previously mentioned, reductionist movement analyses typically treat this movement as independent of (or additional to) the mechanism(s) for licensing reflexives. That is to say that, past reductionist movement analyses typically treat LSOR as a special case of reflexive-marking and the binding conditions in general.

⁶Given that Romance has non-clitic anaphors that do not (appear to) move as well, it would seem to be that reductionist movement approaches such as the one promoted by Chomsky only apply to some anaphors.

Such reductionist movement approaches raise some questions, in regards to the timing of binding conditions. Upon first investigation, it would seem that LSOR anaphors must get their reference after movement. That is, if the normal conditions of binding theory hold for LSOR anaphors, and if the movement of the reflexive to INFL is what derives subject-orientation because of (structural) proximity, the proximity required will only obtain after the anaphor moves. To be clear, if the binding of subject-oriented anaphors could take place before movement, a subject-oriented anaphor like the ones in (13)–(16) would be able to have a non-subject antecedent bind it in the deep structure, counter to fact. Thus, reductionist movement approaches would seem to require LSOR anaphors to be bound after moving to the INFL region (at S-structure or, more likely, at LF).

On the other hand, if all it takes to license LSOR is for the anaphor to move local to the subject, any subject should be able to license LSOR, because this anaphor-movement is independent of the syntax of filling the subject position. Moreover, since all subjects reach subject position through A-movement (e.g. Koopman and Sportiche 1991), there is no reason for ‘normal’ subjects and ‘derived’ subjects (e.g. subjects in passive/raising clauses) to pattern differently with regard to allowing anaphor-movement.⁷ Despite this prediction from a reductionist movement approach, derived subjects are well known to disallow LSOR in a variety of languages (Kayne 1975, Burzio 1986, Lidz 1996, Rizzi 1986a, Sportiche 2010, Storoshenko 2009), recalling our Informed Subject-Orientation Puzzle in (5).⁸ To exemplify this, first consider the normal active clause in (17), which obligatorily employs LSOR marking:

⁷For a more formal definition of ‘derived subject’, see Section 3.6.3 of Chapter 3.

⁸Similarly, any movement-based approach to reflexivity that differs from the reductionist movement approach outlined in (12) and that also takes LSOR to be a sub-case of the general licensing mechanism of reflexivity (e.g. Hornstein 2001, Kayne 2002) overgenerates in the same way.

- (17) Hari tann-annu hoDe-du -koND-a [Kannada]
 Hari self -ACC hit -PST.PRT-LSOR -3SM
'Hari hit himself.'

Here, the (non-derived) subject *Hari* binds the anaphor *tann*, and LSOR-marking with the verbal affix *-koL⁹* is grammatical (and necessary; the anaphor *tann* requires it in this context).

Now consider (18), in which LSOR marking is ungrammatical:

- (18) a. hari (tann-age) santooshaagiruwaage kaNis-utt -aane
 Hari (self -DAT) be.happy seem -PRES-3SM
'Hari seems (to himself) to be happy'
 b. *hari (tann-age) santooshaagiruwaage kaNis-koLL -utt -aane
 Hari (self -DAT) be.happy seem -LSOR-PRES-3SM
Intended: 'Hari seems to himself to be happy' (Lidz 2001b:(53))

This example contrasts with (17) in that *Hari* is the derived subject of the clause it in which it appears. As a derived subject, it is able to grammatically bind the anaphor experiencer argument of *seem*, in (18a). However, despite the fact that the subject of the *seem* clause binds a clause-mate anaphor, the use of the LSOR marker on *seem* is not grammatical in this case. To reiterate, the minimal crucial difference with (17) is that the clause's subject is a derived one. In order to rule out (18b), past reductionist approaches (e.g. Burzio 1986) have argued that LSOR anaphors must be bound before moving to the INFL region (i.e. at D-structure), where *Hari* would not c-command *tann*.¹⁰

Thus, under a reductionist movement approach to LSOR, there is binding conditions must apply both before and after anaphor-movement. Though grammar could in principle be structured with the timing of binding conditions set this way for LSOR (in fact, this is descriptively true), it is curious that binding conditions for LSOR anaphors are timed differently from those

⁹This morpheme has many allomorphs, such as the one in (17), *-koND*.

¹⁰Alternatively, it has been argued (e.g. in Rizzi 1986b) that grammatical principles rule out a scenario in which an LSOR anaphor c-commands its antecedent at one level of representation, while its antecedent c-commands the LSOR anaphor at another (as in the Italian equivalent of (18b), which is also ungrammatical). However, assuming the VP-Internal Subject Hypothesis (or some such theoretical equivalent), even non-derived subjects occur in a position where the LSOR anaphor c-commands the subject at a certain level of representation.

for non-LSOR anaphors: non-LSOR anaphors can be bound before all movements,¹¹ (19a), after all movements, (19b), or even at intermediary stages, (19c):¹²

- (19) a. The crystal ball₂ predicted which stories about herself₁ Mary₁ would write ~~which stories about~~ herself₁.
- b. The crystal ball₂ predicted which stories about itself₂ Mary₁ would write ~~stories about~~ itself₂.
- c. Which stories about itself₂ did the crystal ball₂ predict ~~which stories about~~ itself₂ Mary₁ would write ~~which pictures of~~ itself₂?

Further support that it is non-LSOR anaphors that behave this way comes from languages which morphologically distinguish LSOR and non-LSOR anaphors, like French. In such languages, non-LSOR anaphors have been shown to exhibit the same range of possibilities regarding the timing of binding (Charnavel and Sportiche 2013:(81,88), Starke 2001:(153)).

At this point, a reductionist movement analysis provides a tentative solution to our Naïve Subject-Orientation Puzzle and Informed Subject-Orientation Puzzle, but only with certain stipulations on the timing on binding for only LSOR anaphors, even though there is neither any clearly motivated reason for such timing, nor any clearly motivated reason why this timing must be so only for LSOR anaphors.

Moreover, there is evidence that the binding conditions used in LSOR contexts are not the same as those used in non-LSOR contexts. Kannada *tann* appears to have two entirely different sets of binding conditions. On the one hand, when in cases where it occurs in a clause with the LSOR suffix on the verb, it must be subject bound (before and after movement). On the other

¹¹Or after reconstruction, if this is an independent operation that occurs after movement. In such a scenario, the issues presented here could be discussed not in terms of timing, but in terms of what is able to reconstruct. In such terms, the puzzle would change to why LSOR anaphors must not reconstruct, whereas non-LSOR anaphors may. For a discussion in terms of reconstruction possibilities, see, for example, Sportiche 2011b.

¹²One may try to argue that the anaphors in (19) are “exempt”, meaning that they do not follow any binding conditions (e.g., Pollard and Sag 1992 and Reuland 2011). However, this idea is disproven by the ungrammaticality of a sentence like (19b) that lacks movement, as in **The crystal ball₂ predicted that someone₁ would write some stories about itself₂*. If *itself* were exempt and did not follow binding conditions, this ungrammatical sentence ought to be grammatical, as no specific structural relations with an antecedent would be required. (The problem is that exempt anaphors, at least in investigated languages, are morphologically syncretic with other local anaphors; see Charnavel and Sportiche 2013 for discussion about how to distinguish exempt anaphors from those which follow binding conditions.)

hand, outside of such cases, *tann* must not have as its antecedent a clausal co-argument (Lidz 2001a). Compare (17), which has been repeated below, with (20):

- (17) Hari tann-annu hoDe-du -koND-a [Kannada]
 Hari self -ACC hit -PST.PRT-LSOR-3SM
 'Hari hit himself.'
- (20) *Hari tann-annu hoDe-d -a
 Hari self -ACC hit -PST-3SM
 'Hari hit himself.'

The descriptive reason for (20) being ungrammatical is that, in the absence of LSOR-marking on the predicate, *tann*'s antecedent must not be a clausal co-argument. In other words, *tann* requires an local (non-derived subject) antecedent when there is LSOR marking on the verb, and it requires a non-local (non-clausemate) antecedent in contexts like (20). Exact reasons for this difference aside, the basic conclusion that we can make is that the binding conditions for *tann* in non-LSOR contexts like (20) are distinct from those in LSOR contexts like (17). A reductionist movement approach, as described in (12), might incorrectly predict that the *tann* would follow the same binding conditions in both LSOR and non-LSOR clauses.¹³

5.2.2 Evidence for Movement: Syntactic Islands

Despite these apparent shortcomings of a reductionist movement approach to LSOR, the basic idea that LSOR anaphors move appears to be correct, for the same reason. For example, it derives the following descriptive generalization (which, as we will later see, will require some rephrasing):¹⁴

- (21) **Condition on Islands in LSOR Clauses** (to be revised)
 In an LSOR clause, the bound argument must not be licensed in an island that excludes the subject.

The condition in (21) can be straightforwardly derived if it is the case that all anaphors need to

¹³See Lidz 2001a for a solution different from the one to be argued for here. (See also fn.18.)

¹⁴This generalization is a descriptive one, and on its own it is entirely stipulative. We will see later that refining this statement will make clear how it can be derived from independent facts.

move to be close to the subject binder. However, this is strange: (some) anaphors clearly can occur in islands that do not contain their subject antecedent.¹⁵ Let us turn to some data to illuminate the issue.

The distribution of the French LSOR clitic, *se*, obeys (21), as can be seen in the data in (22b-c), in which the bound argument occurs in a complex NP island that excludes the clause's subject:

- (22) a. Lucie *s'* est vu [French]
 Lucie **LSOR** PERF seen
'Lucie saw herself.'
- b. *Lucie *s'* est compté(e) cinq [island filles en dehors (de)]
 Lucie **LSOR** PERF counted five girls outside (of)
Intended: 'Lucie counted five girls outside of herself.'
- c. Lucie a compté cinq [island filles en dehors d' elle-même]
 Lucie PERF counted five girls outside of herself
'Lucie counted five girls outside of herself.'

In (22a), the LSOR marker is associated with an argument position that is not separated from the subject by an island. On the other hand, (22b&c) differ minimally from (22a) in that the LSOR marker is associated with argument position is separated from the subject by an island¹⁶ – as a result, using *se* is ungrammatical, and a different derivation must be employed. Even though the anaphor in (22c) is bound by the local subject, the non-LSOR anaphor (i.e. an anaphor which lacks any subject-orientation requirement), *elle-même* is used. Perhaps then it is a property of *se* that requires its movement to a position near the subject, and *elle-même* lacks such a property.

In other words, this kind of data seems to suggest that the anaphor that is used in LSOR clauses cannot be merged in an island, and that that is because an LSOR anaphor (like *se*) must move. Just such an analysis is suggested in Kayne 1975 (ch.5), by the analysis that LSOR anaphors “originate

¹⁵Again, the issue of exempt anaphors arises here; unlike the picture-NP type cases that do involve exempt anaphors, this kind of anaphor cannot be replaced by a pronoun. See footnote 12.

¹⁶That there is an island containing the relevant argument in (22b%c), consider (i):

- i. *Qui a Lucie compté cinq filles en dehors (de)
 who PERF Lucie counted five gives outside (of)
Intended: 'Lucie counted five girls outside of who?'

Similar sets of examples demonstrating the effects of islands on the form of reflexive markers can be constructed with any number of islands (e.g. coordination, complex NP, etc.).

as pronouns in postverbal object NP position” and have a +R feature “ensuring them to be spelled *se* in the clitic position.”

However, this analysis does not seem to be adequate. Island effects also arise with LSOR configurations in languages where it is not the case that the anaphor used in LSOR clauses must always move to be near its antecedent. Consider the data from Kannada on the distribution of the anaphor *tann* and the verbal-affix LSOR marker *-koL*, from Lidz (2001a, p.c.):

- (23) a. Hari tann-annu hoDe-du -koND-a [Kannada]
 Hari self -ACC hit -PST.PRT-**LSOR** -3SM
‘Hari hit himself.’
- b. *Hari [tann-annu mattu tann-a hendati-yannu] hoDe-du -koND-a
 Hari self -ACC and self -GEN wife -ACC hit -PST.PRT-**LSOR** -3SM
Intended: ‘Hari hit himself and his wife.’
- c. Hari [tann-annu mattu tann-a hendati-yannu] hoDe-d -a
 Hari self -ACC and self -GEN wife -ACC hit -PST-3SM
‘Hari hit himself and his wife.’

Kannada employs the anaphor *tann* in LSOR clauses in Kannada, such as (23a), as well as in clauses where it cannot move, such as (23b). This indicates that the (23c) is ungrammatical not because of a property of *tann*, but because the LSOR verbal suffix *-koL* is merged.¹⁷ This is surprising, because there seems to be no a priori reason to expect that islands would have an effect on whether a verbal affix can be present or not.

We have reached a point where we can now express a fifth (and final) puzzle about LSOR that needs to be addressed:

(24) **LSOR Island Puzzle**

What in the formal grammar ensures that LSOR marking is impossible when the antecedent and anaphor are separated by an island?

An obvious solution, which will be pursued in §5.3, is that the LSOR suffix necessarily triggers movement of the anaphor to be near the subject; this would unify the island effects in (22) and

¹⁷This assumes that there is only one anaphor *tann*. Minimally what must be concluded is that, if there a features like Kayne’s +R, it is not the sole impetus for the movement of the anaphor; there is (also) a feature on the head that attracts the anaphor. See footnote 28.

(23) as the result of the same syntax.¹⁸ However, an unresolved issue at this point would be why it should necessarily trigger movement of the anaphor. That is, it is not *a priori* clear why it couldn't be the case that a verbal reflexive suffix like *-koL* simply enforces a local-subject restriction, without triggering movement. We will derive this in Section 5.3.2, thanks to the semantic derivation.

5.2.3 LSOR and Non-LSOR Anaphors

An additional unanswered issue for a reductionist movement approach to LSOR has to do with differences between the anaphors used in LSOR and non-LSOR clauses. If binding in LSOR configurations is a subtype of binding in non-LSOR configurations, it is unclear how to derive why it is that LSOR and non-LSOR clauses should employ distinct anaphors.

For example, the anaphors used in French, Norwegian, Czech, Inuit and Kannada differ in form, depending on whether the context is an LSOR one (*se, seg selv, si, immi, and tann*, respectively) or a non-LSOR one (*eux-même, ham selv, sobě, taa-ssu, and awan-age-taane*, respectively).¹⁹ Compare the non-LSOR anaphors below with the LSOR anaphors in (13)-(17).

- (25) Jean₁ a présenté les enfants₂ à eux -même_{2/*1/*3}. [French]
 Jean PERF introduced the children to them-INTNS
 "Jean introduced the children to themselves."
- (26) Vi₁ fortalte Jon₂ om ham selv_{2/*1/*3} [Norwegian]
 We told Jon about him INTNS
 "We told Jon about himself."
- (27) Hrabě₁ pronajal sluhy₂ sobě_{2/1/*3} [Czech]
 count rented servants self.DAT
 "The count rented servants to themselves/himself."
- (28) Juuna₁-p Kaali₂ [taa -ssu_{2/3/*1}-minnga] uqaluttuup-p -a -a [Inuit]
 Juuna -ERG Kaali DEM-SG -INS tell -IND-[+tr]-3SG.3SG
 "Juuna told Kaali about himself."

¹⁸Lidz (2001a) proposes a different analysis (what he calls Condition R) to account for this, which does not appeal to islands directly. I do not believe Condition R is necessarily wrong; in fact, it may even be derived under the account to be presented in this chapter.

¹⁹3rd person masculine forms are given here. INTNS stands for 'intensifier'; also called emphatic reflexive. See, e.g., Gast 2006, Ahn 2010.

- (29) Rashimi₁ [awan_{2/*1/*3}-age-taane] Hari₂-yannu tooris-id -aLu [Kannada]
 Rashimi he -DAT-INTNS Hari -ACC show -PST-3SF
“Rashimi (F) showed Hari (M) to himself.”

There are also languages in which there is no apparent difference between anaphors used in the LSOR and non-LSOR contexts, such as English (recall (11)). Given this, we can make a generalization that the anaphor in an LSOR context may have a distinct morpho-lexical form from the anaphor in a non-LSOR context. This raises the puzzle we saw in (6), repeated below:

(6) **LSOR Anaphoric Form Puzzle**

What allows LSOR contexts to effect the morphological form of the reflexive anaphor?

If movement along with locality and binding conditions derive subject-orientation, as in past approaches described in (12), it is unclear why these non-LSOR anaphors should not also be able to move in the same way as their LSOR counterparts. (Recall from the discussion around (20) that it is not necessarily a property of the anaphor that movement is required.)

This also raises another important question: why do some anaphors move, necessarily yielding a subject-oriented interpretation, while others do not? Previous analyses have simply stipulated that there is a connection between movement and subject orientation on the one hand, and the lexical form of the anaphor that can move on the other. This has been hard coded into some analyses as a feature on the anaphor (e.g. Kayne 1975; see discussion around (22)), but this begs another question: why does this feature trigger movement? Thus a primary goal of this chapter will also be to provide a deeper explanation to derive the relationship between movement and lexical form of the anaphor in LSOR.

5.2.4 Movement: Motivations and Desiderata

Past reductionist approaches like those described in (12) have argued that a movement analysis can yield subject-orientation and begin to solve the Naïve Subject-Orientation Puzzle in (4) and the Informed Subject-Orientation Puzzle in (5). Additional motivation for a movement-based

approach to LSOR is found in the island-sensitivity of LSOR clauses.

However, we have seen a few remaining issues in past movement-based approaches, and the analysis argued for in the following section will address all of them. First, reductionist movement approaches like (12) only provide (partial) solutions to our subject-orientation puzzles, and they rely on underivable stipulations on timing. This is additionally problematic in that it is entirely unclear why these timing stipulations are restricted only to LSOR contexts (and not to other reflexivity contexts). Moreover, these previous approaches have relied on the idea that the same binding conditions apply in both LSOR and non-LSOR contexts; argued against by Kannada data like (20). Despite effects general success with islands, a reductionist movement approach does not provide a clear explanation for why islands block the merging of LSOR verbal suffixes. Finally, it is not the case that all anaphors can undergo this movement – languages have the ability to differentiate between different types of anaphors, and we need to go beyond the descriptive facts to understanding how the formal grammar differentiates LSOR and non-LSOR anaphors.

All of this evidence indicates that we need a new approach to the understanding LSOR and its associated properties. Our goals in looking for the correct approach ought to meet the following desiderata:

(30) Desiderata for a Theory of LSOR

- i. to solve our Naïve Subject-Orientation Puzzle and Informed Subject-Orientation Puzzle
- ii. to understand why LSOR marking is impossible when the anaphoric argument is in an island separated from the subject
- iii. to derive why LSOR is sensitive to the morpho-lexical shape of the anaphor
- iv. to solve our subject-orientation puzzles without relying on timing-stipulations or needing to appeal to binding conditions

Correct understanding of what motivates this movement and the landing-site that this movement targets will be the key to meeting all of these desiderata.

5.3 Reflexive Voice

In this section, we will describe a theoretical approach to LSOR which meets all the goals in (30). At its core, this theory invokes a secondary predicate, REFL, sometimes realized as a verbal reflexive affix, which is the head of VoiceP (in the extended verbal projection, outside of the Θ -Domain).

The semantic denotation of this REFL head is responsible for the locality and subject-oriented aspects of LSOR clauses (as Subbārāo 2012 states is descriptively the case for overt verbal reflexive markers in South Asian languages), and enforces binding in a way independent of binding conditions that hold for non-LSOR binding. It does so by attracting an anaphor from within the Θ -Domain to its specifier, one which is featurally-specified in the appropriate way.

5.3.1 Subjects and Voice

Since the correct approach to LSOR needs to be able to refer to subjects, a basic question arises, which we have not yet addressed: which notion of subjecthood is relevant? The relevant notion could be the S-structure subject (S-subject) —the subject in grammatical subject positions, TP/IP— or the D-structure subject (D-subject) —the highest thematic argument.²⁰

If it is the D-subject that LSOR relies on, then we would predict that a D-subject that fails to become an S-subject ('demoted subjects'; e.g. the passive's by-phrase) should be able to license LSOR marking.²¹ However, this is not the case: D-subjects in a by-phrase cannot license LSOR. This is exemplified by the French data in (31):

- (31) *Pierre **se**_i sera présenté par Jean_i [French]
Pierre **LSOR** PASS.FUT introduced by Jean
Intended: 'Pierre will be introduced by Jean_i to himself.' (Sportiche 2010:(8c))

On the other hand, if LSOR relies on S-subjects (without attention paid to D-structure), any de-

²⁰In some ways, this is a re-cast version of the question of timing that was discussed at the end of §5.2.1.

²¹This assumes a theory in which the by-phrase is not an adjunct (as in, e.g., Baker et al. 1989), but is rather the highest argument of the lexical predicate at D-structure (as in, e.g., Collins 2005b).

rived subject should be able to license LSOR. This is also not true: derived subjects cannot license LSOR. This point can again be exemplified by French data, as in (32):²²

- (32) *Tu_i te_i seras décrit par ta femme [French]
 You LSOR PASS.FUT described by your wife
Intended: 'You_i will be described to yourself_i by your wife.' (Kayne 1975:(91a))

Taken together, (31) and (32) demonstrate that, on their own, neither the notion of D-subject nor S-subject is enough. Instead, LSOR licensing depends on the subject both at S-structure and D-structure binding the reflexive argument.

This fact has been found to various extents in the previous literature (e.g., Storoshenko 2009, Sportiche 2010), and can be summarized as the generalization below:

- (33) **Generalization on Subjects in LSOR Licensing**
 In cases of LSOR, the reflexive argument must be bound by the syntactic object which is both the D-subject and the S-subject.

Given such a generalization, a deeper question arises: where does this come from? Another way of looking at this question is: how does the grammar enforce a restriction that requires that the D-structure subject gets mapped onto the S-structure subject?

The answer lies in what controls mapping between D-structure and the S-structure subject: grammatical voice. We will assume a theory in which grammatical voice is instantiated syntactically as feature bundles merged as the head of VoiceP, which essentially acts as the gateway between the thematic domain and the subject domain (e.g. Ahn and Sailor 2014, Sailor and Ahn 2010).

As such, any derivation in which the D-subject does not become the S-subject can only be generated through the merging of some non-active Voice^o. For example, in verbal passives and raising over an experiencer, the derived and demoted subjects reach their surface-structural positions as the result of a non-active Voice^o (see also Collins 2005a,b) – were the Active Voice^o to

²²Similar examples have been noted by many over the years in Romance (Burzio 1986, Lidz 1996, Rizzi 1986a, Sportiche 2010). The previous analysis was that licensing *se/si* requires a D-subject; however, (31) demonstrates that this is insufficient. See Sportiche (2010) for a thorough discussion of Romance clitic binding.

come in two sets – those for active clauses and those for non-active clauses²⁵ – and reflexive *-Dom* uses the non-active TAM morpheme. This leads to a potentially surprising conclusion (from the viewpoint of a language like English): LSOR clauses are not simply active voice clauses. However, as I will demonstrate, they are not passive or unaccusative clauses, either. (This is most obvious in their interpretation; LSOR clauses are interpreted differently from passives or unaccusatives.) Instead, LSOR clauses employ a separate, non-active, non-passive grammatical voice – REFL Voice.

The idea of a reflexive grammatical voice is an old one, especially in philological traditions. However, as Geniušienė (1987) aptly points out, “...the status of [reflexive predicates] with respect to voice is theory dependent in the sense that it depends on the definition of voice...” (emphasis mine). Thus in order to continue in trying to derive (33) with a Reflexive Voice^o, it is necessary to formally define the Voice^o.

Before arriving at the formal definition of Voice^o, let us review recent generative approaches to voice/Voice^o. Although all analyses agree that voice plays a crucial role in determining which constituent becomes the (S-structure) subject, there is no real consensus on the formal definition of voice that derives this, even restricting ourselves to definitions from contemporary generative works. Below is an (incomplete) list of recent analyses of voice in (35), along with the brief characterizations of each:²⁶

(35) **An Incomplete List of Various Recent Approaches to Grammatical Voice**

i. *Verbal Projection Host:*

Voice^o is a head which attracts a portion of the verbal domain, for formal reasons (e.g. Collins 2005b)

ii. *Discourse-Related Phase Edge:*

Voice^o attracts a portion of the verbal domain for (aspectually-related) interpretive

²⁵For reasons that I do not understand, Peterson uses the terms “active” and “middle” for the active/non-active split in TAM morphemes. The same “middle” TAM markers are used in a variety of non-active contexts, and there is no third set of TAM morphemes.

²⁶It may be worth noting that most of these papers focus on the role of VoiceP in active- and passive-type voices, though Collins (2005a) discusses raising (over an experiencer), Sailor and Ahn (2010) also discuss middles and unaccusatives, and Coon et al. (2011) also discuss Agent Focus.

purposes; Voice^o is a phase head (e.g. Gehrke and Grillo 2009)

iii. *Austronesian voice*:

A'-movement derives the subject; different voice morphemes are introduced in different aspectual positions in the verbal domain (e.g. Pearson 2005)

iv. *Auxiliary head*:

Voice^o is the site of verbal inflectional features, and auxiliaries (such as passive 'be') can be merged there (e.g. Bjorkman 2011)

v. *External argument introducer (1)*:

VoiceP is within the thematic domain, introducing the external argument (e.g. Kratzer 1996, Sailor and Ahn 2010); it is the phase edge (e.g. Pyllkänen 2008)

vi. *External argument introducer (2)*:

VoiceP is within the thematic domain, introducing the external argument; it is below the lowest phase edge (e.g. Coon et al. 2011)

vii. *External argument host*:

VoiceP is outside of the thematic domain, but it is where external arguments are syntactically first merged (e.g. Harley 2013)

viii. *Split-Voice*:

A high VoiceP responsible for grammatical voice syntax is outside of the smallest phase, and a low VoiceP responsible for grammatical voice inflection is within the smallest phase (e.g. Sailor 2012)

The conceptualization of REFL Voice^o that I argue for here shares core properties with some of these, while differing as well.²⁷

²⁷It is possible that there is a deeper reason for this lack of consensus on the properties of VoiceP: it could be that the basic premise of much of this research, that there is a single VoiceP for all grammatical voices, is flawed. Conflicting accounts arise because each only pays attention to certain aspects of certain grammatical voices, and tries to create a unified structural analysis, even though there might not be a single syntactic locus of Voice (Hilda Koopman, p.c.; see Pearson 2005).

At the same time, if there are multiple Voice^o positions, why do voices appear in complementary distribution? (Similar questions arise for tense: if different tenses are merged in different projections [e.g. Cinque 1999]: why should tense morphemes be in complementary distribution within a clause?) If there is a single Voice^o position, this fact is easily derivable (as explicitly argued in Sailor and Ahn 2010) because different heads are competing to merge in the same position; on the other hand, if there are multiple positions, more complex reasoning will be necessary (e.g. perhaps related to features and selection; see Sportiche 2010 and the complementary distribution between his HS and certain voices). No matter what the analysis, something must block multiple Voice^os from being realized in a single clause. (At least, this must be blocked as much as it is observed to be impossible.)

At this point, I take no strong stance as to whether the correct approach uses multiple Voice^o positions, or just one. Instead, if there are multiple Voice^o positions, the primary impact that would have on this analysis would be that the assertions I make on the position/properties of Voice^o ought to be more narrowly-construed, as relating only to REFL Voice (and not Passive, or Active, for example).

Let us now turn to the technical details of VoiceP and, more specifically, REFL. First, the overlap between this VoiceP and past analyses of voice is that VoiceP is syntactically situated within the verbal Spell-Out Domain (as in, e.g., Coon et al. 2011), and (just) outside of the Thematic Domain of the lexical predicate (as in, e.g., Collins 2005b, Gehrke and Grillo 2009, Harley 2013). The only syntactic difference between different grammatical voices is reduced to featural differences on Voice^o (as in Sailor and Ahn 2010); the relevant distinguishing feature for REFL Voice^o is a *uEPP* feature²⁸ that attracts the LSOR reflexive anaphor from its base position in the Θ -Domain.²⁹ These basic syntactic aspects of REFL are laid out visually in (36):

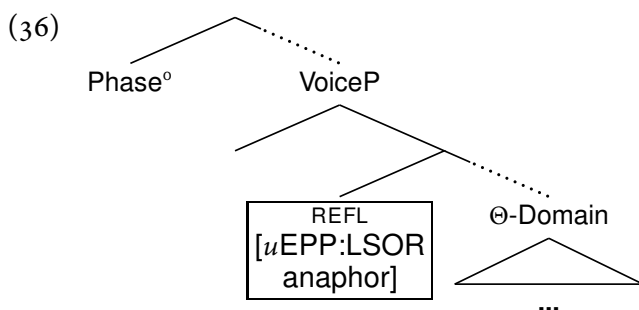

In terms of REFL’s semantic contribution, it is the source of the reflexive interpretation of the clause, and it denotes a function that coidentifies two arguments of the predicate:³⁰

$$(37) \quad \llbracket \text{REFL} \rrbracket = \lambda P_{(st)} \lambda x_{(e)} \lambda y_{(e)} \lambda e_{(s)}. \text{IDENT}(x, y) \ \& \ P(e)$$

Note that no “valency-reduction” in the predicate, *P*, is necessary, nor is there any altering of already computed semantic values in *P*. Instead, the two arguments of *IDENT*, *x* and *y*, will always be the reflexive anaphor and the subject, for simple reasons of the mechanics of grammar.

The following section walks through a complete LSOR derivation, which will expose how the

²⁸In this way, the REFL Voice head is what requires its feature to be checked by the LSOR anaphor. However, it could may well be that there is (also) a feature on the LSOR anaphor that needs to be checked by REFL Voice (this would be like Kayne 1975’s +R feature); in such a scenario, both the anaphor and REFL have features that each need to be checked by the other.

²⁹“ Θ -Domain” refers to the stretch of structure in which all of a predicate’s arguments are introduced; this is often labeled as ν P. The labels PhaseP and Θ -Domain are used to avoid confusion caused by the fact that ν P is often used in a way that conflates the functions of the phase, voice, and highest argument introducing heads.

³⁰It could be that REFL’s participation in the semantic derivation is responsible for “reflexive marking” the predicate, in the sense of Reinhart and Reuland 1993. (More will be said on Reinhart and Reuland’s analysis of reflexives in Section 5.5.2 and appendix B.)

mechanics of REFL laid out in (36) and (37).

5.3.2 The LSOR Derivation

For our example derivation, we will make use of some basic data from Kannada. Recall that Kannada uses an anaphor *tann* and a verbal affix *-koND* in LSOR clauses.

- (38) hari tann-annu hoDe-du -koND-a [Kannada]
 Hari self -ACC hit -PST.PRT-LSOR -3SM
 'Hari hit himself' (Lidz 1996)

I give relevant portion of the syntactic derivation for (38) in (39).³¹

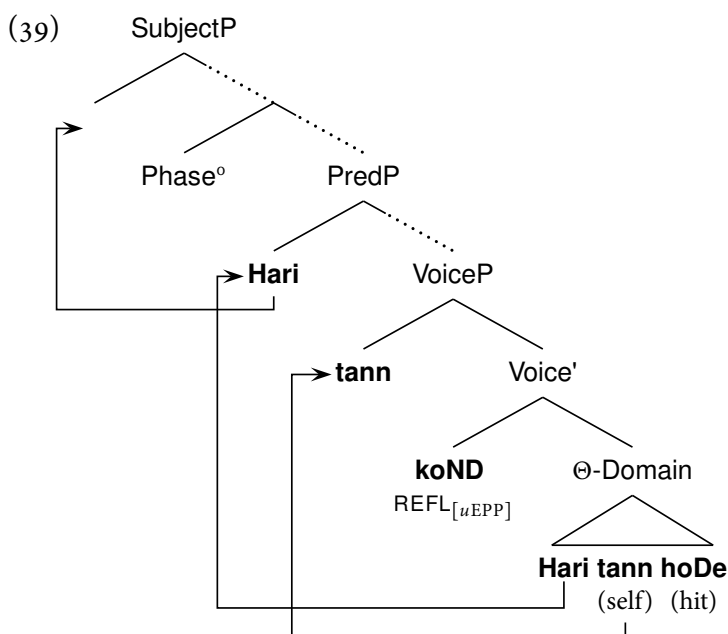

This portion of the derivation proceeds as follows. First, *Hari* and *tann* are (external) merged in their respective thematic positions within the Θ -Domain of the predicate *hoDe* (which is dominated by VoiceP). Next, the anaphor *tann* is attracted to VoiceP by REFL’s EPP feature that probes for an LSOR anaphor, and it moves from its thematic position up to the specifier of VoiceP.³²

³¹Note that the lexical verb, *hoDe*, and the Voice suffix, *koND*, are not in the correct order in this structure. This means that either there is some kind of movement, affix-lowering, or directionally-specified branching (i.e. the Voice head is head-final). The appropriate derivation of the correct linearization is outside the scope of this analysis, and will not be further addressed.

³²This movement takes place in the narrow syntax; it is not LF-movement. See appendix B.1.

Following that, the D-subject *Hari* is attracted to the predicate-internal subject position. I follow Bowers (2001) in calling the projection containing this subject position “PredP”, which is not-coincidentally the projection that defines small clauses. (For additional evidence of a phase-internal position for subjects, see Harwood 2013’s discussion of Transitive Expletive Constructions.) While in PredP, *Hari* is local³³ to the anaphor *tann* and the REFL Voice head.

Note that, though the anaphor is hierarchically superior to the subject at the completion of the VoiceP, the anaphor is not attracted to SubjectP. This is because it is not the kind of constituent that can be attracted to SubjectP (perhaps in terms of grammatical category, perhaps in terms of ‘activity’ in the sense of Chomsky 2000).³⁴ In other words, being the wrong type of constituent, and being that minimality is relativized (e.g. Rizzi 1990b), the LSOR anaphor in Spec, VoiceP is not an intervener between the highest D-structure argument and the subject position.

Let’s turn now to how the semantics and its interface with the syntax derives subject orientation in a REFL derivation. Before beginning, a crucial assumption is that the semantic derivation directly depends on the syntactic derivation (in a familiar Minimalist way). That is, the semantic interpretation simply follows from denotations of constituents and the order in which they merge. The details of this derivation are laid out in (40), which is syntactically and semantically identical to the English derivation in Section 4.4 of Chapter 4, though Kannada differs in providing a pronounced REFL head.

³³I do not use the term “local” here to indicate strict syntactic locality in the sense of “within the same XP”, but rather use it more loosely in the sense that they are hierarchically proximate – this proximity will be clearer and more relevant in considering the semantic derivation.

³⁴This may in fact derive the Anaphor Agreement Effect, as laid out by Rizzi (1990a) and Woolford (1999).

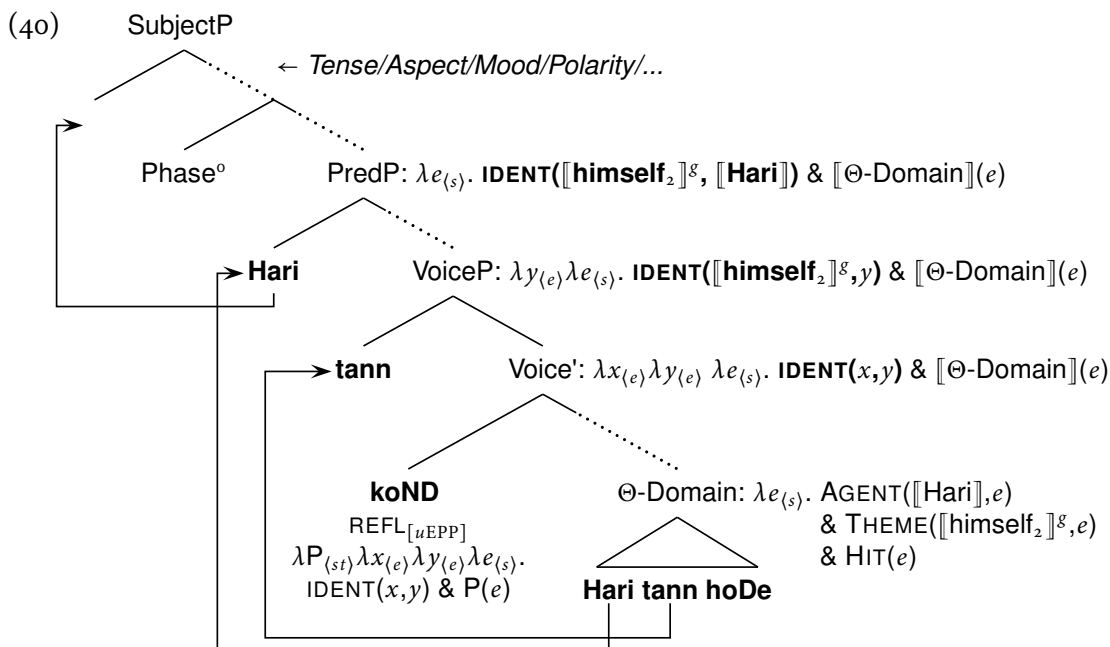

Though the specific semantic derivation in (40) relies on the framework-specific properties (which I will discuss shortly), there are two general aspects of this analysis that should be focused on.

- REFL Voice (in this case *koND*) is associated with the IDENT function, which is responsible for a reflexive interpretation.
- The LSOR anaphor and the subject (in this case *tann* and *Hari*, respectively) will necessarily be the arguments of IDENT because of where they occur in the syntactic structure.

Other frameworks of semantics or its interface with syntax may be employed derive these in a slightly different technical manner.³⁵ Regardless of the choice framework, these two aspects of the semantic derivation ought to remain constant.

The technical details of the specific analysis in (40) are as follows. First of all, LSOR anaphors (such as *tann*, and *himself*) are semantically interpreted as simple pronouns. This idea is one of the oldest in generative syntactic approaches to anaphors, going back to Lees and Klima 1963, and which has recently been revitalized in Hornstein 2001: the only difference between *himself* and *him* is a formal/syntactic difference. This makes the correct prediction that the morphological

³⁵See appendix B for presentations of some alternatives, including one in which the LSOR anaphor is the reflexivizer, as is assumed in many semantic theories of reflexivity. In this case, it is still true that REFL is still associated with IDENT, in that it attracts that anaphor that denotes it to its specifier.

shape of the anaphor in LSOR could possibly be the same as a pronoun – this is what is found in, for example, the 1st/2nd person of Romance languages, and even Old English (e.g. Siemund 2000).³⁶

As with all pronouns, the denotation of anaphoric pronouns such as *himself* is only an index, and a contextually-specified assignment function (which we call *g*) determines the reference of the index. As such, in a given context, *him* and *himself* can ultimately have the same semantic denotation. For example, in (41), :

- (41) John₂ hit himself₂. Then Mary₁ hit him₂.
 a. $\llbracket \text{himself}_2 \rrbracket^g = g(2)$
 b. $\llbracket \text{him}_2 \rrbracket^g = g(2)$

In this way, the Θ -Domains in ‘*Mary₁ hit him₂*’ and ‘*John₂ hit himself₂*’ differ semantically only in the argument of the AGENT function, in a context where *him* refers to John:

- (42) a. John₂ hit himself₂.
 $\llbracket \Theta\text{-Domain} \rrbracket^g = \lambda e_{\langle s \rangle}. \text{AGENT}(\llbracket \text{John}_2 \rrbracket^g, e) \ \& \ \text{THEME}(g(2), e) \ \& \ \text{HIT}(e)$
 b. Mary₁ hit him₂.
 $\llbracket \Theta\text{-Domain} \rrbracket^g = \lambda e_{\langle s \rangle}. \text{AGENT}(\llbracket \text{Mary}_1 \rrbracket^g, e) \ \& \ \text{THEME}(g(2), e) \ \& \ \text{HIT}(e)$

Crucially, the argument of the THEME function in *both* sentences is *identical*: the referential value of index 2, given by the assignment function *g*. Thus, what the IDENT function essentially does is constrain the assignment function, by forcing the anaphor to have the same reference as the subject.³⁷

Finally, perhaps what is most crucial here is that syntax feeds semantics cyclically. This is a feature of the general architecture of a Minimalist grammar: semantics crucially depends on syntax, and semantic computations happen regularly at small intervals during the building of the syntactic structure, and thus syntactic operations feed semantic operations. With grammar having this architecture, it stands to reason that a grammatical object should be able to compose with mul-

³⁶In fact, it might be that the *-self* morpheme in English is the lexicalization of the REFL head. This is possible, but (for word order reasons) requires a syntax much more complicated than can be argued for here.

³⁷The phrasing “same reference” is likely too strong, as the ‘identity’ between the anaphor must be defined loosely enough for proxy NPs and the proxy-referent to be deemed as identical, since LSOR marking seems to be able to occur with proxy interpretations.

multiple semantic functions by undergoing syntactic movement. This is at the core of Montagovian grammar, which Stokhof 2006 nicely summarizes in a recent characterization:

“Any semantic object or operation on such objects has to have a correlate in the syntax, an expression or operation that triggers it. And conversely, all expressions and all structural operations in the syntax have to have a semantic correlate. Thus the autonomy of syntax is limited.”
(Stokhof 2006:2067)

In this way, in the case of a REFL derivation, movement of the subject and anaphoric pronoun can affect how they get interpreted. Specifically, the subject *Hari* and anaphor *tann* will each compose with two functions in (40): a thematic licenser associated with the lexical predicate before movement, and with the IDENT function after movement. (This idea of movement allowing a single syntactic object to compose with multiple semantic functions isn't a novel one: a variety of analyses at the syntax-semantics interface are predicated on this idea, for example, movement theories of control, e.g. Hornstein 2001, and movement theories of possessor dative constructions, e.g. Lee-Schoenfeld 2006.)

This narrow approach to grammatical Voice and the syntax-semantic interface are what derive LSOR. All the technical details/decisions that comprise it are well-within the previously established bounds of grammatical architecture. That said, this theory for deriving LSOR can be summarized in two general statements, as laid out in the introduction, which are much less theory-specific:

(8) **The Core Underpinnings of LSOR**

- i. There are two atoms of reflexivity in LSOR:
 - (a) an anaphor merged in an argument position, and
 - (b) a Reflexive head on the spine that is associated with grammatical voice and the semantic reflexivizing function
- ii. These two atoms yield the LSOR properties:
 - (a) The anaphor undergoes movement when the Reflexive Voice^o is merged, and
 - (b) The local subject necessarily binds the LSOR anaphor, due to the syntactic structure and normal rules of semantic composition.

In this way, different frameworks and/or assumptions can be used to cover the same range of data,

provided that they conform to these two statements. See Appendix B for some examples of this.

5.3.3 Solving Puzzles with REFL Voice

In this section REFL's syntactic and semantic properties will be shown to allow us to meet all the desiderata laid out in (30), repeated below:

(30) **Desiderata for a Theory of LSOR**

- i. to solve our Naïve Subject-Orientation Puzzle and Informed Subject-Orientation Puzzle
- ii. to understand why LSOR marking is impossible when the anaphoric argument is in an island separated from the subject
- iii. to derive why LSOR is sensitive to the morpho-lexical shape of the anaphor
- iv. to solve our subject-orientation puzzles without relying on timing-stipulations or needing to appeal to binding conditions

Recall the two subject-orientation puzzles referred to in (30i), which we began with:

(4) **Naïve Subject-Orientation Puzzle**

Why is it that special morphosyntactic marking of reflexives occurs only when the *subject* is the antecedent of the bound argument?

(5) **Informed Subject-Orientation Puzzle**

Why can only some subjects license LSOR?

We will begin with our these puzzles, and then we will return to the other desiderata in (30).

5.3.3.1 Only Subjects

With regard to the Naïve Subject-Orientation Puzzle, the answer that we have come to is that the REFL head, together with the syntax-semantics interface provides the solution. Specifically, the LSOR anaphor will need to be identical to the subject, due to where each of them is (re-)merged in the syntax. Only the subject occurs in a position where it can saturate the second of IDENT's arguments.

No other argument of the main predicate can saturate IDENT's second argument, because anything occurring lower in the structure will not reach a point where it could compose with IDENT.

Thus, binding between a direct object and an indirect object, for example, cannot employ REFL for semantic reasons. Consider the ditransitive examples in (43); the two underlined constituents are intended to be interpreted as the arguments of the REFL Voice^o's IDENT function (*ils* and *se* in (43a-b), and *esclave/roi* and *se* in (43c-d)):³⁸

- (43) a. Ils se sont ~~ils~~ ~~se~~ Ø ~~ils~~ vendus un esclave ~~se~~ [French]
 They **LSOR** PERF [REFL] sold a slave
'They_i sold a slave to themselves_i'
- b. Ils se sont ~~ils~~ ~~se~~ Ø ~~ils~~ vendues ~~se~~ au roi
 They **LSOR** PERF [REFL] given to.the king
'They_i sold themselves_i to the king'
- c. *Ils se sont ~~ils~~ ~~se~~ Ø ~~ils~~ vendus un esclave ~~se~~
 They **LSOR** PERF [REFL] sold a slave
Intended: 'They sold a slave_i to himself_i'
- d. *Ils se sont ~~ils~~ ~~se~~ Ø ~~ils~~ vendus ~~se~~ au roi
 They **LSOR** PERF [REFL] sold to.the king
Intended: 'They sold himself_i to the king_i'

Merging the REFL Voice is grammatical in (43a)-(43b); the anaphor will move to VoiceP (to satisfy REFL's EPP feature) and the subject will move to PhaseP (for independent reasons): positions in which they enter into the IDENT relation.

On the other hand, merging REFL Voice in (43c)-(43d) is ungrammatical; again, and for the same reasons, the anaphor will move to VoiceP and the subject will move to PhaseP, where they will enter into the IDENT relation, which does not yield the intended interpretation. The other object, *esclave* in (43c) and *roi* in (43d), will not be able to enter the IDENT relation with the anaphor, since it will not merge in a position where it can compose with the IDENT function denoted by REFL.

Other similar sentences in which one object binds another will thus never be able to employ REFL Voice^o, for the simple reason that such a semantic derivation will never converge in the intended way. Thus, all derivations which do employ REFL Voice^o will necessarily be local subject-oriented, solving our Naïve Subject-Orientation Puzzle. Moreover, this is achieved without any

³⁸Both *ils* and *se* occur in more places than indicated – specifically, *se* surfaces in a very high position (above T) but must also occur lower in VoiceP (to satisfy its EPP feature); similar with *ils*, which occurs above T but also within the lower phase, just above Voice^o.

constraints on “timing” for the binding of LSOR anaphors; instead, the same generalizations on timing are derived by the architecture of the syntax and its interface with the semantics.

5.3.3.2 Only Some Subjects

As for the Informed Subject-Orientation Puzzle —why derived and demoted subjects are ruled out in LSOR clauses— this is also solved with the REFL derivation described in §5.3.2. The reason for this has to do with how derived subjects become subjects at S-structure, and why demoted subjects don’t become subjects at S-structure.

Recall our previous characterization of grammatical voice, in Section 5.3.1, as being what is responsible for mapping D-structure arguments onto S-structure positions. Without a special grammatical voice inducing some kind of inversion, the highest D-structure argument is attracted to the subject position, as a result of minimality effects (i.e. Attract Closest).³⁹ That is, a lower D-structure argument is not attracted to the subject position because the highest D-structure argument intervenes between it and the subject position. As such, whenever there is a derived subject (one which is not the highest D-structure argument, it must be that something has caused the highest D-structure argument to not intervene between SubjectP and the derived subject): that ‘something’ is triggered by Voice^o (see e.g. Collins 2005b, Sailor and Ahn 2010).

In other words, derived subjects become subjects via various (non-Active, non-REFL) Voice^os. These various other Voice heads are in complementary distribution with REFL, as they compete for the chance to merge in VoiceP.⁴⁰ As such, derived subjects (which rely on non-REFL Voice) and LSOR (which relies on REFL Voice) are simply derivationally incompatible. This is exemplified in (44), which is based on data in (18), with additional analysis concerning the Voice head that is merged in the higher clause:

³⁹Recall from Section 5.3.2 that anaphors in REFL clauses are not interveners, and thus the highest D-structure argument will move to subject position, and the anaphor is ineligible to do so.

⁴⁰Alternately, there could be multiple syntactic loci of grammatical voice, and something else rules out multiple voices in a single clause; see fn. 27.

- (44) a. hari tann-age santooshaagiruwaage kaNis- \emptyset -utt -aane [Kannada]
 Hari self -DAT be.happy seem NONACT-PRES-3SM
Intended: 'Hari seems to himself to be happy'
- b. *hari tann-age santooshaagiruwaage kaNis-**koLL**-utt -aane
 Hari self -DAT be.happy seem -REFL -PRES-3SM
Intended: 'Hari seems to himself to be happy'

The non-LSOR example in (44a) is grammatical because the voice used for deriving *Hari* as the subject (here glossed as NONACT), which is silent in Kannada, is merged. Conversely, (44b) is ungrammatical because REFL Voice is merged, blocking the merging of the NONACT voice, which is necessary to derive the *Hari* as the subject of *seem*.⁴¹ As such, we understand why it is that a subject that is only a subject at S-structure is unable to license LSOR.

For very similar reasons, demoted subjects are different cannot license LSOR. Consider *Jean* in (45), which is a subject only at D-structure:⁴²

- (45) a. *Pierre se sera \emptyset présenté par Jean [French]
 Pierre **LSOR** PASS.FUT REFL introduced by Jean
Intended: 'Pierre will be introduced by Jean to himself.'
- b. *Pierre se présentera \emptyset par Jean
 Pierre **LSOR** introduce.FUT REFL by Jean
Intended: 'Pierre will be introduced by Jean to himself.'

For both of these sentences, there are multiple reasons that the derivation will not converge. First of all, in both of the derivations above, the demoted subject *Jean* (the intended second argument of IDENT) never occurs in Spec,PhaseP – where it would need to occur if it were to compose with IDENT. Additionally for (45a), REFL and PASS both need to be merged (*se* depends on REFL, and the argument-inversion and passive auxiliary depend on PASS) – this is ruled out for the same reason as the NONACT and REFL Voices both merging in (44). And additionally for (45b), there is a passive derived subject, but there is no PASS head which would allow the argument-inversion between *Pierre* and *Jean*.⁴³ For these reasons, we understand why it is that a subject that is only a

⁴¹It is worth wondering what Voice this is. It could perhaps be characterized as a Raising-Over-Intervener Voice^o (like the v^o that induces smuggling in Collins 2005a); see fn.23.

⁴²The silent REFL is given as occurring before the lexical verb *présenté* in (45a) and after the lexical verb *présentera* in (45b) for independent reasons: the main verb would move higher in (45b) than in (45a).

⁴³In a Collins 2005b approach, the *par* is actually the passive voice head, which would mean any clause with a *par*-phrase that is interpreted as the highest argument of the verb is necessarily a PASS clause (and not a REFL one).

subject at D-structure is unable to license LSOR.

Thus, derived subjects and demoted subjects are both ruled out as licensing an LSOR anaphor; they would each rely on a non-REFL Voice clause, while the LSOR anaphor would rely on a REFL Voice clause.⁴⁴

5.3.3.3 LSOR Island and Anaphoric Form Puzzles

Recall the generalization on islands and the puzzle it raised, both repeated below:

- (21) **Condition on Islands in LSOR Clauses** (to be revised)
In an LSOR clause, the bound argument must not be licensed in an island that excludes the subject.
- (24) **LSOR Island Puzzle**
What in the formal grammar ensures that LSOR marking is impossible when the antecedent and anaphor are separated by an island?

The generalization in (21) is essentially true, but it cast in terms that are not expressible in our formal grammar, and so it does not help us solve the puzzle in (24). Why should it matter that the anaphor is not separated from the subject by an island boundary? Recall that a theory in which this is due to the fact that anaphors move to be near the subject is inadequate, as it faces our Informed Subject-Orientation Puzzle of why LSOR movement does not happen with all subjects.⁴⁵ Instead, we now can recast this generalization in terms of movement to VoiceP, which does help us to solve

⁴⁴At this point, it may be worth asking whether all non-nominative/oblique subjects (besides demoted subjects in *by*-phrases) are unable to license LSOR. Let us very briefly consider dative subjects, which exist in a variety of languages. In some languages, they seem to not license LSOR (e.g. Kannada, Lidz 2001b:§3.5.1; Tsez, Polinsky and Comrie 2003:(26)), while in others they seem to be able to (e.g. Russian, Zlatić 1997:§5:(5a)). This is likely due to the fact that oblique case-marking on a subject does not arise from a singular type of derivation. That is, there are almost certainly multiple derivations which lead to oblique case-marked subjects, some of which are compatible with REFL, and some of which are not. The fact that case-marking is divorced from subjecthood and the ability to license LSOR can be seen in ergative/absolutive languages like Inuit, in which both ergative and absolutive subjects can license the LSOR anaphor (Bittner 1994a:§4.2).

⁴⁵Theories like Hornstein (2001) and Kayne (2002), which relate (certain) anaphors to movement, don't have movement of the anaphor to the subject position, *per se*. Instead, they relate those anaphors to movement in that they only occur where the antecedent DP had been previously merged (under certain conditions; the two formulations differ in their details). Even still, they face the same difficulties as movement-of-the-anaphor theories, with regards to the Informed Subject-Orientation Puzzle: to the extent that LSOR is licensed by movement of the subject to subject position, why couldn't movement of a derived subject also license LSOR?

the LSOR Island Puzzle:

(46) **Condition on Islands in LSOR Clauses** (revised)

In an LSOR clause, the bound argument must not be licensed in an island that excludes the REFL VoiceP.

This condition on islands predicts the following clauses to all be ungrammatical:

- (47) a. *Marie est \emptyset remercié [_{island} moi ou **se**] [French]
 Marie PERF [REFL] thanked me or **LSOR**
Intended: 'Marie thanked me or herself.'
- b. *Marie est \emptyset remercié [_{island} **se/s'** ou moi]
 Marie PERF [REFL] thanked **LSOR** or me
Intended: 'Marie thanked me or herself.'
- c. *Marie **s'** est \emptyset remercié [_{island} moi ou ~~se~~]
 Marie **LSOR** PERF [REFL] thanked me or
Intended: 'Marie thanked me or herself.'
- d. *Marie **s'** est \emptyset remercié [_{island} ~~se~~ ou moi]
 Marie **LSOR** PERF [REFL] thanked or me
Intended: 'Marie thanked me or herself.'

If the anaphor cannot move to VoiceP, LSOR is blocked. As mentioned earlier, *a priori*, this might be surprising: why must the reflexive argument be able to move to VoiceP? At this point the answer ought to be obvious: the LSOR derivation requires the anaphors to move to VoiceP for syntactic and semantic reasons, and islands separating the LSOR anaphor's base position and VoiceP prevent this. Thus (47a-b) are ruled out because, though island constraints are satisfied, REFL's EPP feature goes unchecked; and (47c-d) are ruled out because, though REFL's EPP feature gets checked, the coordinate island constraint is violated.⁴⁶ Though this limitation on the distribution of LSOR is not one we initially set out to account for, this analysis correctly and straightforwardly derives it.

Finally, there is the connection to the morpho-lexical form of the LSOR anaphor, as questioned

⁴⁶One may wonder if (a-b) would be OK if ACT Voice^o was merged instead of REFL; at this point, we have not discussed any reason to rule this out, though all of the examples in () would still be ungrammatical if the perfect auxiliary were *avoir* (distinguishing the clause as in the active voice). This may suggest that *se* also has a feature that must be checked; see fn.28.

in (6), repeated below.⁴⁷

(6) **LSOR Anaphoric Form Puzzle**

What allows LSOR contexts to effect the morphological form of the reflexive anaphor?

In the syntax argued for here, REFL Voice^o selects for the LSOR anaphor as its specifier, and a REFL Voice derivation as in (40) will not converge if a non-LSOR anaphor is merged in place of the LSOR anaphor, as in (48b):

- (48) a. Lucie s' est ∅ vu [French]
Lucie **LSOR** PERF REFL seen
'Lucie saw herself.'
- b. *Lucie est ∅ vu elle-même
Lucie PERF REFL seen herself
Intended: 'Lucie saw herself.'

Recall that when the clause is in the REFL Voice, the perfect auxiliary will be a form of *être*, as in (48). There are two specific ways in which the derivation in (48b) fails if the non-LSOR anaphor is merged in place of the LSOR one in a REFL Voice clause.⁴⁸ First, the EPP feature of REFL will not be checked, and second, the IDENT function will not compose with the two appropriate arguments. Employing a non-LSOR anaphor in a REFL clause, as in (48b), would require a derivation like (49), which would also not converge:

⁴⁷We will return to other markers of LSOR (e.g. verbal affixes, agreement markers) shortly, in Section 5.4.

⁴⁸In some languages, the anaphor used for non-LSOR purposes can co-occur with REFL Voice marking, when oriented to the local subject. For example, the Kannada complex anaphor (which can occur outside of LSOR contexts) and the reflexive verbal suffix *-koL* can co-occur; however, it is notable that in Kannada (and other South Asian languages that behave this way), the complex anaphor (*tannu-taane*) contains the LSOR anaphor (*tannu*), and thus the REFL Voice's EPP feature could be satisfied (at some level of representation) by *tannu*. Differently, in other languages, the non-LSOR anaphor is also used in certain emphatic/focus contexts and can occur alongside REFL Voice and the LSOR anaphor (e.g. Romance *lui-même, se stesso*, Greek *ton eafto tu*, Swahili *mwenyewe*). In such cases, the EPP feature is still satisfied by the appropriate LSOR anaphor, which also saturates the IDENT function's second lambda; additionally, there is a separate mechanism which licenses the non-LSOR anaphor – perhaps as a double, perhaps as an argument of a separate predicate.

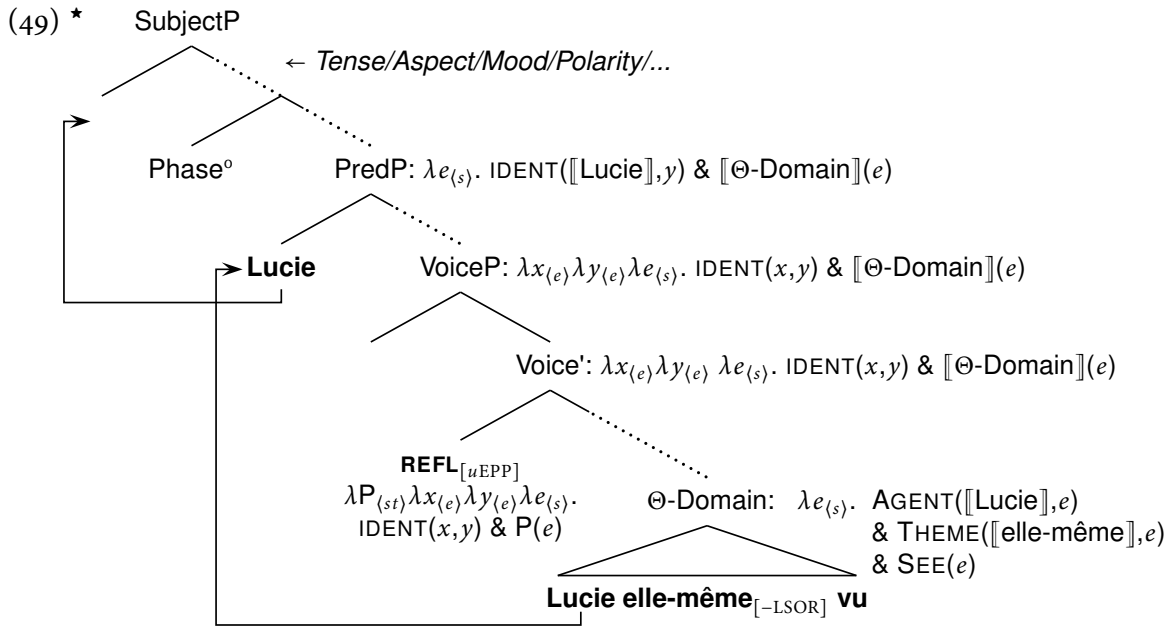

Thus the problem of merging the appropriate form of anaphor has been reduced to one of the most basic aspects of the syntactic system: selection. LSOR anaphors must bear certain features that non-LSOR anaphors do not so that REFL can select for them; and since feature composition distinguishes between lexical items, it is expected that languages will have different morpho-lexical forms for reflexive anaphors.

5.3.3.4 Wrapping Up Some Puzzles

To emphasize the core aspects of this theory that have been argued for which, with the REFL Voice, let us return to the desiderata laid out for a theory of LSOR:

(30) **Desiderata for a Theory of LSOR**

- i. to solve our Naïve Subject-Orientation Puzzle and Informed Subject-Orientation Puzzle
- ii. to understand why LSOR marking is impossible when the anaphoric argument is in an island separated from the subject
- iii. to derive why LSOR is sensitive to the morpho-lexical shape of the anaphor
- iv. to solve our subject-orientation puzzles without relying on timing-stipulations or needing to appeal to binding conditions

(30i) and (30iv) are resolved by the fact that semantic reflexivity is associated with the REFL Voice,

which is located between the Phase edge and the Θ -Domain; and (30ii) and (30iii) are understood because the REFL Voice attracts an argument to its specifier, via selection. The theory of LSOR, at its core, is the result of the following formal properties:

(50) **Theoretical Components that Derive LSOR**

- i. The structural height of REFL outside of the Θ -Domain but within the Phase,
- ii. where subject and anaphor occur in the derivation, and
- iii. the nature semantic composition, how it interacts with syntax

5.4 LSOR Across Languages

We will now turn to the cross-linguistic properties of LSOR and REFL Voice. Recall the typological puzzle from the introduction.

(7) **Typological Puzzle**

What is the range of possibilities for marking LSOR, and why?

At this point we have discussed variation in the LSOR anaphor, but what about variation in where that LSOR is manifested? Descriptively, languages vary wildly on the surface with regards to how LSOR is expressed: some languages employ a complex anaphor, some a clitic, and others no apparent anaphor at all; some languages employ verbal affix while others do not; some languages use special word-orders; some languages use a combination of these. This range of variation is not only accounted for under this theory, it is predicted.

In addition to differences in surface expression, languages also differ in what other morpho-syntactic “constructions” LSOR patterns with. For example, in some languages, reflexives exhibit more similarities with active transitives, and in others, they exhibit similarities with unaccusatives, passives, and/or middles. In addition to typological variation, within a single language, LSOR clauses may exhibit some properties shared with active transitives while simultaneously exhibiting others shared with non-actives. This tension that is observed both across and within languages is

resolved by the fact that REFL is a distinct Voice.

5.4.1 LSOR Surface Variation

An LSOR derivation essentially relies on the presence of two pieces —the REFL Voice, and the anaphor it selects for— and either or both of the reflexive Voice^o and the LSOR anaphor may be silent, in a given language. Additionally, the LSOR anaphor moves from its argument position, but this movement may or may not visibly affect word order (as syntactic movement, for various reasons, may end up being string vacuous).

This leads to 8 kinds of languages (without considering whether the LSOR anaphor has a unique morpho-lexical shape), only 6 of which are logically possible (if the anaphor is silent, it is not logically possible for movement to be visible). This is laid out in Table 5.1.

Anaphor is overt?	REFL is overt?	Movement is overt?	Example language
Yes	Yes	Yes	Greek
Yes	Yes	No	Kannada
Yes	No	Yes	French, Czech
Yes	No	No	English, Japanese
No	Yes	No	Finnish
No	No	No	Shona
<i>No</i>	<i>Yes</i>	<i>Yes</i>	<i>(logically impossible)</i>
<i>No</i>	<i>No</i>	<i>Yes</i>	<i>(logically impossible)</i>

Table 5.1: Some Morpho-syntactic Variation in LSOR at the Surface⁴⁹

As an additional source of variation, there may be different the lexical items for LSOR contexts and for non-LSOR contexts, or there may be syncretism. As an example, consider the data in Table 5.2.

⁴⁹This characterization of these languages may not apply across the board in all LSOR contexts of all these languages (e.g. Greek inherent reflexive predicates behave differently in an LSOR context, and Shona LSOR contexts may in some focus contexts involve an overt anaphor). Additionally, whether French *se* has itself moved (so that the anaphor movement is overt) is not clear (instead of, say, a null pronoun moving; cf. e.g. Borer (1984) and Sportiche (1996)).

	French	Japanese	Czech	English	Tongan
LSOR anaphor	se	jibunjishin	se	themselves	kiautolu
Non-LSOR anaphor	eux-meme	{ jibun karejishin }	sebe	themselves	kiautolu
Non-Refl. Pronoun	eux	karera	je	them	kiautolu

Table 5.2: Variation in 3rd Person Plural Pronominals Across a Selection of Languages

(Note that non-LSOR anaphors aren't necessarily a homogeneous group, as Japanese shows; see the ontology in (1).)

At the same time, the only anaphors that are sensitive to their antecedent's grammatical role are anaphors that require a subject antecedent. That is to say, no language has been found in which the anaphor has a special form just in case its antecedent is a direct object. This is captured by the following descriptive generalization:

(51) **Generalization on LSOR and Reflexive Anaphors**

If an anaphor requires its antecedent to have a certain grammatical role, then that grammatical role is that of the subject.

Homophony may abound, but the categories whose form the Grammar considers is constrained; there is an category for LSOR, but no category for local direct object oriented reflexivity.

The Grammar does not require there to be any unique surface morpho-syntactic effects of LSOR – all exponents of reflexivity could be silent or homophonous with other lexemes (as seems to be the case in Tongan). What is critical is that the variation that does manifest across languages for LSOR is restricted to the surface forms of underlyingly distinct categories. In this way, the same abstract underpinnings is maintained across all Language in the structural representation of LSOR.

More specifically, the syntactic properties of LSOR clauses remain constant across languages, due to the fact UG specifies (i) the height of REFL, and (ii) how its denotation necessitates movement. Moreover, the wide range of variation that we see in LSOR at the surface is predicted by the

Borer-Chomsky Conjecture (Baker 2008): all variation is in lexical items.

“[B]eyond PF options and lexical arbitrariness[...], variation is limited to nonsubstantive parts of the lexicon and general properties of lexical items.”

(Chomsky 1995:170)

In this case, the Borer-Chomsky Conjecture predicts that REFL will have different lexical properties across languages (silent/pronounced; bound affix/free morpheme; etc.) and that a lexical item can be homophonous with, or differentiated from, other elements within a language (e.g. REFL and other Voices; LSOR anaphors and pronouns or non-LSOR anaphors).

One language type that we have not focused on intently in this chapter is the English-type language: English LSOR appears morph-syntactically identical to non-LSOR reflexivity. (The overt LSOR anaphor in English is segmentally homophonous with the non-LSOR anaphor, and there are no word-order effects of movement.) As we saw in Chapters 3 and 4, English anaphors exhibit differential prosodic behaviors, along the LSOR/non-LSOR distinction. First, LSOR anaphors do not bear phrasal stress where other words do; compare (52a) and (52b). Moreover, when merging an LSOR anaphor is impossible, because of (46), the anaphor bears phrasal stress just as other words; compare (53c) and (53d).⁵⁰

- (52) a. Liz embárrassed herself. (LSOR)
b. Liz embarrassed Jáck.
c. Liz embarrassed people besides hersélf. (Non-LSOR)
d. Liz embarrassed people besides Jáck.

Additionally, in subject-WH questions, typically the subject must be prosodically focused in the answer; but in cases of LSOR, the anaphor can be prosodically focused to allow an special interpretation whereby the reflexivity (and not the anaphoric argument itself) is semantically focused

⁵⁰Though in this context the reflexive pronoun would seem to behave the same way as pronouns; however, in other scenarios, pronouns differ in prosodic behavior, showing that the behavior of *herself* in (52a) cannot be reduced to the general behavior of pronouns. See Chapter 3, Section 3.3.3.

(see also Spathas 2010).⁵¹ However, this special interpretation is only allowable with an LSOR clause, and is disallowed in all other contexts:

- (53) a. A: Who fired Jack?
 B: Jack fired HIMSÉLF. (LSOR)
- b. A: Who fired Jack?
 #B: Ken fired JÁCK.
- c. A: Who fired all the executives besides Jack?
 #B: Jack fired all the executives besides HIMSÉLF. (Non-LSOR)
- d. A: Who fired all the executives besides Jack?
 #B: Jack fired all the executives besides KÉN.

Based on the fact that both phrasal stress and focus stress depend on syntactic structure (Chomsky and Halle 1968, Selkirk 1984, Cinque 1993, among many others), this data indicates that English LSOR and non-LSOR reflexives are syntactically distinct. Moreover, the specifics of the data and the theoretical framework together indicate that the syntactic structures for LSOR clauses in English meet the descriptions in (8) in such a way that the derivation can proceed as in (40). See Chapter 4 for more data and discussion.

Where there was once chaos there is order. We now have a restricted and principled way in which LSOR manifestations can vary – though Greek and English differ greatly on the surface, the underlying system is the same for both languages. It is also clear that LSOR (but not non-LSOR reflexivity) can be encoded with unique verbal morphology – only LSOR employs a unique grammatical voice to encode reflexivity, REFL, even though in principle the situation to be the converse. And finally, we understand why LSOR (and only LSOR) may have both verbal and pronominal exponents to express reflexivity – REFL and the pronominal anaphor may both be overtly realized (see Table 5.1).⁵²

⁵¹A second prosody is available as an answer to the questions in (53), as discussed in Chapter 4, Section 4.2.3. In this second prosody, both the subject and the reflexive anaphor bear focus stress. However, this is shown to be a distinct phenomenon, with a different distribution and different derivation.

⁵²More daringly, this theory may explain why LSOR markers can be morphologically complex (e.g. *jibunjisin*) – one of the morphemes may be the REFL morpheme and the other is the pronominal.

5.4.2 LSOR, “Transitivity”, and Other Voices

Past research on reflexive structures have argued that, for some languages, reflexive clauses are treated as syntactically intransitive, and/or are grouped with unaccusative clauses (e.g. Marantz 1984, Sportiche 1990, Pesetsky 1995). This has been seen as a point of variation: reflexivity in some languages is unaccusative, while in other it is transitive. Others have argued that LSOR is syntactically aligned with the middle voice in some languages (e.g. Kemmer 1994), adding another possible variant in the way LSOR is encoded.

This raises some important questions: what kind of variation is possible? And what determines what alignments are possible? (E.g., is it possible the reflexives and actives pattern alike to the exclusion of other voices?) Let us begin answering these questions by making a simple observation:

(54) **Voice Patterning of LSOR Clauses**

LSOR clauses do not pattern uniformly as either active/transitive or non-active/ intransitive, across languages.

That is, in one language LSOR clauses may seem to pattern (in some ways) as active, whereas in another language LSOR clauses may seem to pattern as non-active.

This is predicted under the REFL Voice theory presented here. It has been pointed out many times in the literature on voice morpho-syntax that not every grammatical Voice comes with its own unique set of morpho-syntactic reflexes or paradigms, including by Lidz 1996 in his investigation of reflexivity across languages, by Embick 1998 in his investigation of Greek non-active voices, and by Alexiadou and Doron 2012 in their examination of the passive and middle Voices across languages. As an example, Alexiadou and Doron show that Modern Greek uses the same non-active voice paradigm for middles, passives, and reflexives (Embick 1998, Alexiadou and Doron 2012). This is exemplified the active, middle, passive and reflexive clauses in (55),⁵³ with the latter

⁵³Lexical reflexives do not behave entirely the same way as non-lexical reflexives in Greek. Though they use non-active voice morphology, they do not employ an *afto*- anaphor (they instead appear to employ a silent anaphor). Perhaps lexical reflexives in Greek involve a different REFL Voice – this can be motivated by semantic and morpho-syntactic

three all involving the same morphological Voice marker, despite having (non-morphological) properties that can distinguish between them.⁵⁴

(55) **Greek**

a.	o	Janis	diavase	to	vivlio	[ACT]
		the	Yani	read.ACT.PFV.PST.3S	the book	
		<i>'John read the book'</i>				
b.	i	Maria	afto -katastrefete			[REFL]
		the	Maria	self- destroy. NONACT .IPFV.NPST.3S		
		<i>'Maria destroys herself'</i>				
c.	afto	to	vivlio	diavazete	efkola	[MID]
		this	the book	read. NONACT .IPFV.NPST.3S	easily	
		<i>'This book reads easily'</i>				
d.	afto	to	vivlio	diavastike	xtes	[PASS]
		this	the book	read. NONACT .PFV.PST.3S	yesterday	
		<i>'The book was read yesterday'</i>				

Of course not every language morphologically distinguishes Voices in the same way as Greek. Since LSOR is derived by a unique grammatical Voice, and since not every grammatical Voice comes with its own unique set of morpho-syntactic reflexes, LSOR may exhibit some morpho-syntactic properties similar to active clauses and some properties that are similar to non-active clauses. Moreover, nothing requires that a given Voice exhibits the same active/non-active patterns across languages.⁵⁵ Consider this very small typology with a small set of Voice^os:⁵⁶

differences between lexical reflexive and productive reflexive strategies (see e.g. Moulton 2005). Or perhaps lexical reflexives employ a second kind of anaphor, which could have a unique phonological form (possibly silent) and which can only be used with certain predicates (as a sort of phrasal idiom). It is possible that both proposals are right: there is this second REFL which selects this second (silent) anaphor.

⁵⁴The NONACT morpheme has different surface forms in (55b–d) due to the fact that the realization of the voice morpheme depends on interactions with agreement, tense, and aspect.

⁵⁵It is also likely that no language morphologically distinguishes each Voice from all others.

⁵⁶The way Table 5.3 is set up might implicate a kind of linear continuum of voices, with Passive and Active being diametrically opposed. This implication need not hold; e.g. Voice^os might be better described along multiple dimensions, and a linear representation based solely on “activity” is not adequate. (i.e. It is not clear how many features ought to be used to define Voice.)

	PASSIVE Voice ^o	MIDDLE Voice ^o	REFL. Voice ^o	ACTIVE Voice ^o
English	non-act. morph.	act. morph.		
Greek	non-act. morph.			act. morph.
Kannada	pass. morph.	refl. morph.		act. morph.
Finnish ⁵⁷	N/A	mid. morph.	refl. morph.	act. morph.

Table 5.3: Voice^os and Their Morphological Realizations on the Verb

What Table 5.3 demonstrates is that there can be syncretism in voice morphology, so LSOR markers can also be markers of other grammatical functions, thereby capturing earlier generalizations (e.g. Geniušienė 1987, Lidz 1996).

5.4.3 LSOR and Other Voice-Related Effects

Besides the form of the LSOR anaphor and voice morphology on the verb, REFL Voice can impact other aspects of the grammar in the same way that other Voices do. We will turn now to the treatment LSOR clauses as active or non-active, in perfect auxiliary selection in Spanish and French in LSOR clauses. Famously, French active clauses differ from LSOR clauses in perfect auxiliary⁵⁸ selection, in that the former employs *avoir* ('have'), while later employs *être* ('be'). Additionally, 'be' is used as the passive auxiliary,⁵⁹ as well as the perfect auxiliary for unaccusative clauses, which has

⁵⁷Finnish is said to have a passive – but the external argument is obligatorily absent such a voice, so I assume that this is in fact the middle voice. Since the number of Voice^os is certainly much greater than four, it might be that the Finnish “passive” is neither what I have marked as PASSIVE nor what I have marked as MIDDLE. It may be that the only overt, clearly segmentable Voice^o morpheme in Finnish is the REFL Voice; the Finnish “passive” (MID) morpheme forms a portmanteau with TAM and subject agreement morphemes, making it difficult to determine, using only morphology, if it instantiates the same head as REFL (which occurs between the stem and TAM).

⁵⁸By ‘perfect auxiliary’, I mean the auxiliary verb that obligatorily takes as its complement a predicate that contains a perfect participle. In French, this auxiliary contributes a simple past interpretation, as in (56).

⁵⁹It ought to be noted that the passive auxiliary is distinct from the perfect auxiliary, as the two can co-occur. Forming a perfect on top of a passive, the passive auxiliary ‘be’ occurs in the participle form immediately before the lexical verb participle, and that is preceded by the perfect auxiliary ‘have’: *J’ ai été vu* (lit. ‘I have been seen’). What this indicates is that not every auxiliary is necessarily sensitive to Voice, when there are multiple auxiliaries. However, there are also languages in which both auxiliaries are ‘be’ in such a scenario, e.g. Italian (Burzio 1986:(81)). See Charnavel 2008 for more on multiple auxiliaries in French and their form (w.r.t. ‘have’/‘be’) in various complex

contributed to the (erroneous) conclusion that French reflexives are unaccusative (as in Sportiche 1990; but see Sportiche 2010 for specific criticisms against an unaccusative analysis of French reflexives).

(56) **French**

- a. je l' ai vu [ACT perfect]
 I him PERF.AUX seen
'I saw him.'
- b. je **me** suis vu [REFL perfect]
 I **LSOR** PERF.AUX seen
'I saw myself.'
- c. je suis arrivé [UNACC perfect]
 I PERF.AUX arrived
'I arrived.'
- d. je suis vu [PASS]
 I PASS.AUX seen
'I am (being) seen.'

On the other hand, Spanish active, LSOR, and unaccusative clauses all employ *haber* ('have') as the perfect auxiliary:

(57) **Spanish**

- a. yo lo he visto [ACT perfect]
 I him PERF.AUX seen
'I have seen him.'
- b. yo **me** he visto [REFL perfect]
 I **LSOR** PERF.AUX seen
'I have seen myself.'
- c. yo he llegado [UNACC perfect]
 I PERF.AUX seen
'I have arrived.'
- d. yo soy visto [PASS]
 I PASS.AUX seen
'I am (being) seen.'

In this way, it is clear that auxiliary selection is sensitive to the clause's Voice, and that the primary difference between Spanish and French is in how they divide up the uses of 'have' and 'be', across Voices.⁶⁰

scenarios.

⁶⁰It is additionally possible that only the 'have'/'be' distinction can be related to which auxiliary can bear the necessary feature to attract a clitic group that contains a *se/si*. (Note the similarity of this proposal to the one in Burzio 1986:(Ch.1).) This would account for the fact that all Voices that involve *se/si* (e.g. reflexive, middle, anticausative,

Besides auxiliary selection, languages like Kharia (Munda, Austroasiatic) and Mandinka (Mande, Niger-Congo) have different sets of TAM markers, split between active and non-active clauses. In the case of Kharia, reflexive clauses use the non-active set (Peterson 2011):

(58) **Kharia**

- | | | |
|----|---|--------|
| a. | lebu -ki-te yo -[yo']-j | [ACT] |
| | person-PL-OBL see-PST -1 SG | |
| | <i>'I saw the people'</i> | |
| b. | yo -Dom-[ki]-kiyar | [REFL] |
| | see-REFL -PST-DU | |
| | <i>'The two of them saw themselves'</i> | |
| c. | yo -Dom-[ki]-kiyar | [PASS] |
| | see-REFL -PST-DU | |
| | <i>'The two of them were seen'</i> | |

However, in the case of Mandinka (which only distinguishes the two in affirmative perfective clauses), reflexive clauses use the same TAM morpheme as active transitives (Creissels, to appear):

(59) **Mandinka**

- | | | |
|----|--|--------|
| a. | mus -óo [ye] kód -oo nukuj | [ACT] |
| | woman-DEF PERF.AFF money-DEF hide | |
| | <i>'The woman hid the money'</i> | |
| b. | díndíj-o [ye] í nukuj yír -óo kóoma | [REFL] |
| | child -DEF PERF.AFF REFL hide tree-DEF behind | |
| | <i>'The child hid himself behind the tree'</i> | |
| c. | díndíj-o nukún-[tá] yír -ôo kóoma | [PASS] |
| | child -DEF hide -PERF.AFF tree-DEF behind | |
| | <i>'The child was hidden behind the tree'</i> | |

Similar to voice morphology and auxiliary selection, TAM markers can be divided up across Voices, and a language can align reflexive clauses with actives or with non-actives.

Agreement markers can also be sensitive to the voice of the clause. Lakota (Siouan) and Chickasaw (Muskogean) both have a two-way split between active/non-active clauses in subject agreement-markers: subjects of active clauses use one set, and subjects of non-active clauses use another. In an LSOR context, the non-active set is obligatorily used (Charnavel 2009):

impersonal) use the same perfect auxiliary ('be' for French, 'have' for Spanish).

(60) **Lakhota**

- a. **[wa]**-pázo [ACT]
1s- display
'I displayed (it).'
- b. **[m]**-ik- pázo [(REFL)]
1s- REFL-display
'I displayed myself.'

On the other hand, in LSOR contexts in Chickasaw, the active agreement marker is used for the subject (Pam Munro, p.c.):

(61) **Chickasaw**

- a. **[ish]**-hoppi-taam [ACT]
2s- bury -Q.PST
'Did you bury (it)?'
- b. **[ish]**-ili- hoppi-taam [(REFL)]
2s- REFL-bury -Q.PST
'Did you bury yourself?'

At this point we have seen that LSOR clauses may resemble actives, passives, or neither, along other dimensions such as voice morphology, auxiliary selection, TAM markers, and agreement markers. This is summarized in Table 5.4, below:

LSOR clauses...	...pattern like	...pattern like	...pattern
	actives	non-actives	distinctly
Voice morphology	English	Greek	Kannada
Auxiliary selection ⁶¹	Spanish	French	Sye(?)
TAM Markers	Mandinka	Kharia	?
Agreement morphology	Chickasaw	Lakhota	Shona

Table 5.4: LSOR effects on Morpho-Syntactic Paradigms

⁶¹Auxiliary selection in French is sensitive to reflexivity only in the perfect. All that is indicated by this row is that auxiliary selection in some part of the grammar is impacted by reflexivity. As for Sye, it is said to have reflexive auxiliary *ehpe* (Crawley 1998), I put a question mark here for two reasons. First, and more importantly, the data in Crawley's grammar is inadequate to argue either way whether *ehpe* is restricted to LSOR contexts or not. All the sentences given are simple non-passive mono-transitives, such as (i), below:

In other words, this variable behavior is captured by the assumption that basic reflexive structures differ across languages, and that in some languages reflexives are “transitive” and in others they are “intransitive” or “detransitivized”. Instead of arguing for variable structures across languages, it is being argued here that reflexives are a unique Voice category, which the grammar may align with transitives (e.g. Active), or intransitives (e.g. Middle/Unaccusative/Passive), or neither.

Importantly the morpho-syntactic effects of reflexivity in Table 5.4 are predicted to be limited in the way that LSOR is restricted by the syntactic configurations that we discussed in §3.3. For example, though the Shona *zvi* LSOR marker is a reflexive agreement marker (and not a Voice morpheme), it cannot occur when the voice of the clause is passive (Storoshenko 2009:§5.1). Compare the grammatical, non-passive (2) with the ungrammatical passive (62):

(62) Mufaro a- ka- **zvi**- bik -ir -Ø -a mbudzi [Shona]
 Mufaro.1 SUBJ.1-PST-**LSOR**-COOK-APPL-REFL-FV goat.9
 ‘Mufaro_i cooked the goat_j for himself_{i/*j}.’ (Storoshenko 2009:(23))

(63) *A- ka- **zvi**- bik -ir -w -a
 SUBJ.1-PST-**LSOR**-COOK-APPL-PASS-FV
 Intended: ‘She was cooked for herself’ (ibid.:(29a))

(63) is ungrammatical because the (silent) REFL Voice head that triggers *zvi* is in complementary distribution with Passive suffix *-w*.

Another example: recall that Greek LSOR clauses use a nonactive Voice, as in (64a). There is a second way to express reflexivity in Greek, with the active Voice and a full noun phrase anaphor *o eaftos tu*, (64b). In non-LSOR reflexive contexts such as (64c),⁶² a non-REFL Voice strategy like (64b) must be used:

i. y- ehpe n- ochi
 3SG:DISTPASTdo.reflexively NOM-see:3SG
 ‘He/She saw himself/herself’ (Crawley 1998:127)

Second, it is not clear how grammatically similar *ehpe* is to more familiar auxiliaries; for example, the complement of *ehpe* is glossed as a kind of nominalization in Crawley (though this is, of course, one analysis).

⁶²Data from Anagnostopoulou and Everaert 1999.

- (64) a. **afto-** katastrafome [REFL]
LSOR-destroy.**NACT**.IPFV.NPST.1S
- b. katastrefo ton eafto mu [ACT]
destroy.ACT.IPFV.NPST.1S the self my
“I destroy myself”
- c. O Janis edhikse stin Maria ton eafto tis [Obj-Oriented]
the Yani show.ACT.PFV.PST.3S to.the the self her
“Yani showed to Maria herself”

The form of the anaphor, and its properties (e.g. as subject orientation, movement from argument position) are directly tied to the Voice of the clause, in line with the theory and its predictions as they were laid out in §5.3.3.

5.4.4 Typological Conclusions

We have seen a number of ways in which LSOR can be manifested in a given language. There are three descriptive generalizations that emerge from this data.

(51) **Generalization on LSOR and Reflexive Anaphors**

If an anaphor requires its antecedent to have a certain grammatical role, then that grammatical role is that of the subject.

That is, no language has an anaphor that is used only if a non-subject (e.g. a direct object) is the antecedent of binding.

(65) **Generalization on LSOR and Reflexive Verbal Affixes**

If a verbal affix is used to mark reflexivity, the local subject must be the antecedent of binding.

That is, no language has a reflexive-marking verbal affix that is used only if a non-subject (e.g. a direct object) is the antecedent of binding.

(66) **Generalization on LSOR and Other Morphosyntactic Patterns**

If LSOR affects the realization of a morpheme in a paradigm other than the voice or anaphor paradigm (e.g. the aspectual paradigm), then voice more generally affects that morphological paradigm.

For example, we saw that French auxiliary selection is sensitive to LSOR, as is Kharia TAM-marking, and both the French auxiliary system and Kharia TAM system are sensitive to gram-

matical voice more generally. In other words, the relevant LSOR-sensitive morphosyntactic phenomenon is sensitive to grammatical voice more generally. This provides very strong evidence that reflexivity is formally represented in the same way as voice (i.e. as a Voice^o).

All of these generalizations are the result of the formal derivation of LSOR, and the following theoretical generalization can be made:

(67) **Generalization on Possible Exponents of LSOR**

LSOR's morphosyntactic exponents are limited to Voice^o and its selectional relatives.

In other words, the only things that show morphosyntactic effects of REFL are Voice^o, the specifier it selects (the LSOR anaphor), and other things that have more indirect selectional relationships with Voice^o, such as agreement, aspect, and the auxiliary system (which are all structurally close to Voice).

This supports the general idea that the only variation across languages is variation in lexical items (Borer-Chomsky Conjecture; Baker 2008), the surface forms of which may be impacted by selection.⁶³ Given two featurally similar lexical items A and B (e.g. LSOR anaphors and non-LSOR anaphors, or REFL Voice and PASS Voice, etc.), a language may assign the same or different phonological forms (possibly silent forms) to A and B. Additionally, A and B may interact with other components of the grammar in an overt way, or not. In this sense, all typological variation in LSOR is purely at the surface; and the types of variation observed are predicted, given the definition of REFL Voice motivated here.

5.5 Conclusions

5.5.1 Closing Remarks

LSOR, the solution to the puzzles it implicates, all its properties, and apparent variation emerge from what UG provides: the general architecture of grammar, and the REFL Voice^o. Recall (30),

⁶³More accurately, selection may determine features, and features determine lexical form.

repeated below as (68), in which we laid out the desiderata for a complete theory of LSOR:

(68) **Desiderata for a Theory of LSOR**

- i. to solve our Naïve Subject-Orientation Puzzle and Informed Subject-Orientation Puzzle
- ii. to understand why LSOR marking is impossible when the anaphoric argument is in an island separated from the subject
- iii. to derive why LSOR is sensitive to the morpho-lexical shape of the anaphor
- iv. to solve our subject-orientation puzzles without relying on timing-stipulations or needing to appeal to binding conditions

Each of these was solved using a single derivation that is centered around the syntax and semantics of a Reflexive VoiceP:

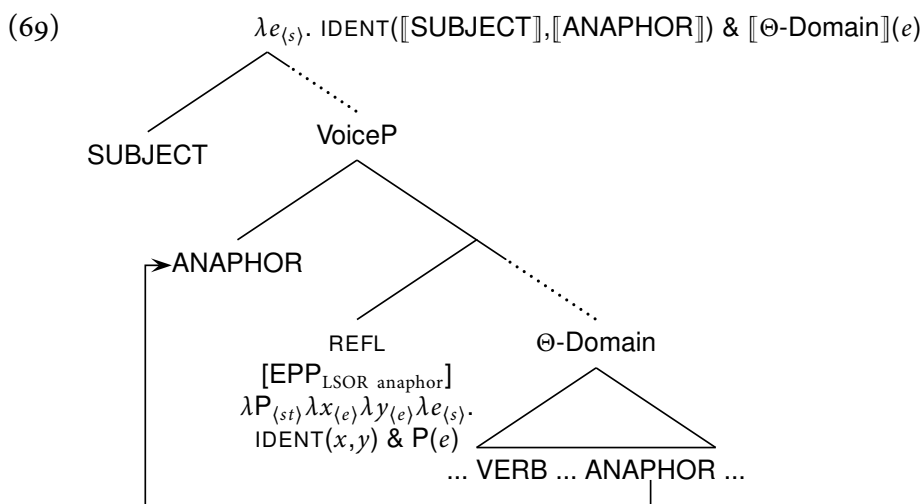

This relevant specifics of this derivation are as follows: (i) REFL, a unique grammatical Voice head associated with the semantic reflexivizer, is what licenses LSOR anaphors, (ii) REFL attracts an anaphor to VoiceP via selection, and that selection can impose restrictions on the kind of anaphor that is attracted, and (iii) due to the general nature of the organization of the grammar, subjects (and only certain subjects) and the LSOR anaphor are the only constituents capable of composing as co-arguments of an identity function introduced in the REFL Voice^o.

Though we have successfully met our desiderata in this particular way, many of our choices are framework-specific. At the core of this analysis are only two central statements:

(8) **The Core Underpinnings of LSOR**

- i. There are two atoms of reflexivity in LSOR:
 - (a) an anaphor merged in an argument position, and
 - (b) a Reflexive head on the spine that is associated with grammatical voice and the semantic reflexivizing function
- ii. These two atoms yield the LSOR properties:
 - (a) The anaphor undergoes movement when the Reflexive Voice^o is merged, and
 - (b) The local subject necessarily binds the LSOR anaphor, due to the syntactic structure and normal rules of semantic composition.

In any specific implementation of these two statements, local subject-orientation emerges an epiphenomenal property of a derivation with predicate-level reflexivization. Moreover, LSOR is not simply a special-case of normal binding conditions – defining LSOR in such a way would require unmotivated stipulations on the timing of binding, which in addition would ultimately be explanatorily inadequate.

In addition to accounting for the desiderata in (30), this account predicts the range of morpho-syntactic variation in LSOR-marking, given entirely basic expectations on the kinds of lexical variation one ought to expect. Specifically, LSOR involves two lexical items (REFL and the moving anaphor), either or both of which may (or may not) have unique exponents, and REFL can share its morpho-syntactic paradigms with other Voice^os. It follows from this, that languages that do not obviously mark LSOR (e.g. English) ought to still employ REFL, despite lacking an obvious way of marking it – it's just that more careful investigation may be required to uncover its effects. (As we saw in the previous chapters.)

5.5.2 Extensions and Open Questions

In addition to deriving the ways in which LSOR can be instantiated in a language, this analysis can also derive the core properties of Reinhart and Reuland 1993's theory (and Reuland 2011's subsequent modifications) on the distribution of clausal reflexivity. For their analysis, they propose their Condition B alongside a definition of 'reflexive-marking', laid out below:

(70) **Reinhart and Reuland 1993's Condition B (slightly rephrased)**

A semantically reflexive clause must be reflexive-marked

(71) **Reflexive marking (Reuland 2011:(3), p.249)**

A predicate (of P) is *reflexive-marked* iff either P is lexically reflexive or one of P's arguments is a SELF anaphor.

In the theory motivated in this chapter, semantically reflexive predicates are only semantically reflexive because REFL (the semantic reflexivizing function) has been merged, and the movement involved reflexive marking is required for interpretive and formal reasons. Thus, reflexive marking is no longer a spurious requirement – it is required by REFL – and thus Condition B is derived. The primary difference in the VoiceP theory of this dissertation is that anaphors always move in the narrow syntax, whereas theories like those in Reinhart and Reuland 1993 and Reuland 2011 promotes an post-syntactic, LF-movement approach for languages like English (see appendix B.1).

At this point there are several unanswered questions that ought to be further addressed as a result of the conclusions made here. First, what grammatical mechanisms underlie other, non-LSOR reflexives, such as the ones laid out in (1)? (Is it one of the theories described in (10)?) Is it possible that long-distance subject-oriented reflexives, in addition to local ones, employ something like REFL Voice? If not, how is its subject-orientation derived? Second, are local subject-oriented reflexivity and local subject-oriented reciprocity different animals, using different voices? Given the semantic definition of REFL given here, it would seem that is necessary, but perhaps it could be modified in an appropriate way to capture both. And finally, in terms of the grammar, what mechanisms are involved in allowing different grammatical voices to share morpho-syntactic paradigms? Is there massive accidental homophony, feature underspecification within the paradigms, or something else? This research sets some jumping-off points for investigation, but to answer these questions, further research is needed.

CHAPTER 6

Conclusion

“We are to admit no more causes of natural things than such as are both true and sufficient to explain their appearances.”

– Sir Isaac Newton, Rules of Reasoning in Philosophy: Rule I (1687)

“...‘reflexive constructions’ can be viewed as taxonomic epiphenomena. Principles at work in binding relationships are those that are at work elsewhere in the grammar.”

– Johan Rooryck & Guido Vanden Wyngaerd, Dissolving Binding Theory (2011)

6.1 Summary of Findings

After investigating the prosodic properties of English reflexive anaphors, it is now clear that there are two distinct sets of anaphors. One that co-occurs with a grammatical Reflexive Voice head, and a (perhaps heterogeneous) set that does not occur with a specific Reflexive Voice. The former, Local Subject-Oriented Reflexivity, is boxed in the ontology below.

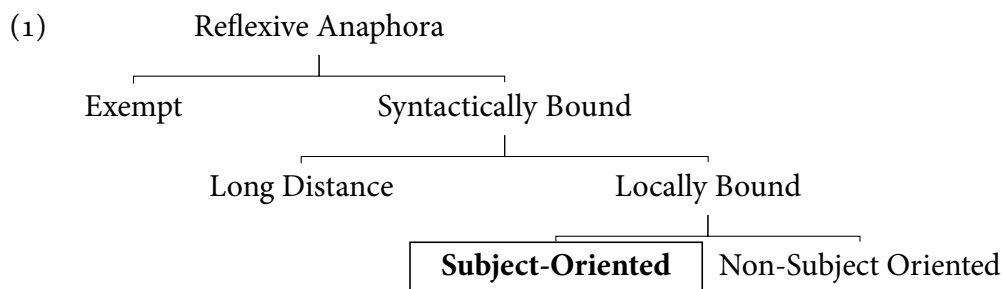

Only LSOR anaphors exhibit the *a priori* unexpected prosodic patterns, in English. This is because LSOR anaphors result from a unique derivation; the structure argued for here is summarized in

(2), with its core properties described in (3).

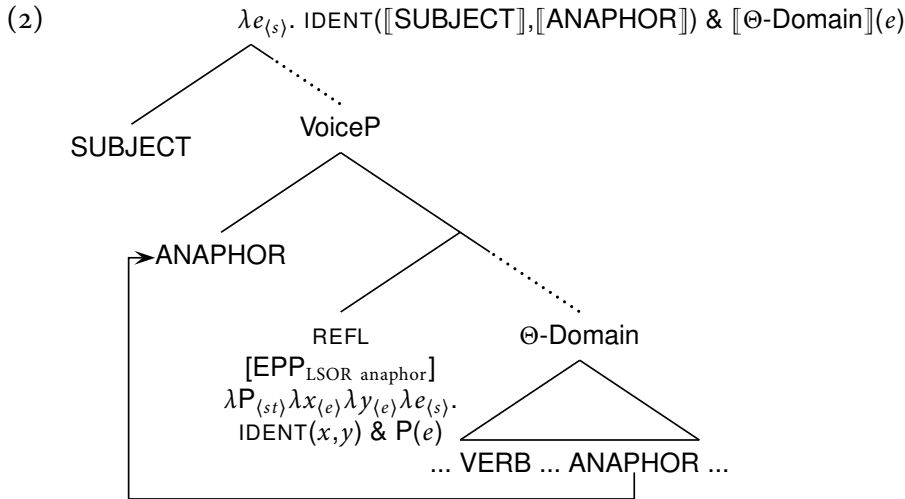

(3) **The Core Underpinnings of LSOR**

- i. There are two atoms of reflexivity in LSOR:
 - (a) an anaphor merged in an argument position, and
 - (b) a Reflexive head on the spine that is associated with grammatical voice and the semantic reflexivizing function
- ii. These two atoms yield the LSOR properties:
 - (a) The anaphor undergoes movement when the Reflexive Voice^o is merged, and
 - (b) The local subject necessarily binds the LSOR anaphor, due to the syntactic structure and normal rules of semantic composition.

Given that syntactic structures like the one in (2) are the input to the prosodic component, the observed “exceptional” prosodic patterns are straightforwardly predicted based on the a simple NSR and two simple focal stress rules. No special mapping rules with limited scope apply, and the desired properties of complex data set emerge. Prosodic patterns are as informative of the deeper syntactic representation as word order.

This derives what are classically called Principle A effects for a subset of anaphors: LSOR anaphors. In fact, it is not clear that Principle A is an operational constraint – least of all for LSOR anaphors – but rather merely a description of the distribution of anaphors. In order to fully answer this question, the complete set of reflexive anaphora must be viewed together. (See §6.2.3.)

English is like languages from all over the world. Though it appears to use the same syntax

for reflexives across the board, this simply cannot be. Even in English, there are two atoms of reflexivity; though the presence of the Reflexive Voice is not obvious in languages like English, it is detectable. In this way, we make a logical extrapolation: all languages share a formal base for LSOR contexts. In some languages, LSOR is easier to detect than in others, and languages all look rather different from one another on the surface with marking LSOR, but closer investigation reveals deep similarities.

6.2 Future Research

Having provided motivation for dividing reflexivity up into LSOR and non-LSOR derivations, it is important to explore the effects of these structures in different contexts, perhaps solving older puzzles while bringing to light new ones.

6.2.1 Phrasal Stress as a Syntactic Diagnostic

Finally, the model of phrasal stress explicitly argued for here allows for new ways to probe syntactic structure in ways we have not been able to before. We ought to know how reliable of a tool phrasal stress is – extrametrical reflexive anaphors do not provide any exception to the NSR, but do other instances of extrametricality?

There are a range of different kinds of constituents that have been claimed to be exceptions to the NSR: given material, pronouns, function words, etc. in a variety of cases; are there ever any exceptions? In some forthcoming work (Ahn In Preparation), I argue that there are no clear cases of exceptionality to this rule. In this way, the NSR provides the learner, hearer, and theoretician with overt cues in the signal about the structure – in the same way the word order provides cues about the structure.

Taking word order cues and prosodic cues from the signal results in a very rich set of data, which can be used to reliably bootstrap complex syntactic and phonological derivations, as each

utterance in the input provides multiple dimensions of structural information.

6.2.2 Reflexive Voice and Ellipsis

Given a Reflexive Voice that underlies LSOR, LSOR is predicted to interact with Voice-related phenomena such as voice-mismatch in ellipsis (e.g. Kehler 2002, Merchant 2007, 2013, Tanaka 2011). In particular, this research all claims that voice mismatch is only possible in certain cases of ellipsis. Kehler argues for a pragmatic constraint on where it is available, while Merchant and Tanaka argue that there is an additional constraint on syntactic identity.

if sloppy interpretations are cases of voice-match, and strict interpretations are cases of voice-mismatch, the prediction is that sloppy interpretations should be available in all types of ellipsis, whereas strict interpretations will only be available in contexts meeting the grammatical constraints on voice-mismatch.

It has already been noted that strict readings are not always available (e.g., Fox 1993, Fiengo and May 1994, Hestvik 1995, Kehler 2002). The task is to explore how much of the (un)availability of strict interpretations is predicted by a voice theory of reflexivity. Initial work on this topic (Ahn forthcoming) finds this is indeed the case, but much more work remains.

6.2.3 Reflexivity Without Reflexive Voice

Having derived canonical Principle A effects for a subset of reflexive anaphors, we should broach the topic of the other types of reflexive anaphors. How different is licensing LSOR anaphors from licensing non-LSOR anaphors?

Complementary work to this effect has been undertaken in Charnavel 2012 and Charnavel and Sportiche 2014, investigating the properties of the different types of (non-LSOR) syntactically bound reflexive anaphors. What seems to be clear is that these non-LSOR anaphors do not involve two atoms of reflexivity, and instead rely on c-command within a Spell-Out Domain as

the relevant licensing condition.

Now that there are two licensing mechanisms reflexive anaphors, an important question is: What causes one derivation to be used over another? In some languages (e.g. French and English), LSOR derivations must be used as much as possible. This is seen in the judgments below:

(4) Q: What happened in the deposition?

A1: Hazel *defénded* herself.

A2: #Hazel defended *hersélf*.

(5) a. Elle s' est defendue

She LSOR has defended

'She defended herself'

b. *Elle a defendu elle-même

She LSOR has defended

Intended: 'She defended herself'

An attempt to derive this strong preference is given in the appendix as an implicature: using non-LSOR derivations implicates that the speaker had grammatical/contextual grounds to not use the LSOR. (See Appendix E).

However, this idea runs into some issues in that other languages do not seem to have a preference for the LSOR structure. For example, Japanese has an LSOR anaphor *jibunjishin*, but in cases like (6), the two are in free variation:

(6) a. Aki-wa jibunjishin-o hometa

Aki -TOP LSOR -ACC praised

'Aki praised herself'

b. Aki-wa jibun-o hometa

Aki -TOP self -ACC praised

'Aki praised herself'

It is unclear what will cause some languages to be more rigid in their maximization of LSOR structures, while others are able to be more free. Deeper crosslinguistic comparisons are needed, though it is likely that deeper language-internal investigations are needed first.

6.2.4 Long Distance Reflexivity

Also in the domain of non-LSOR anaphors, the issue of subject-orientation in long distance anaphor arises. In the case of LSOR, the subject-orientation is addressed by locality and semantic composition. Across the world's languages, a great number of systems of long distance reflexivity are claimed to be sensitive to subject orientation (for example, Koster and Reuland (1991), Pollard and Xue (1998), Cole et al. (2001), Huang and Liu (2001), Loss (2011) to name only a few). What remains to be seen is where this subject orientation comes from.

The Reflexive Voice seems to be a highly unlikely source, as whenever there is an overt morphological expression of Reflexive Voice, it necessitates local binding. This is also seen in the typologist's view, as Subbārāo states is descriptively the case for overt verbal reflexive markers in South Asian languages.

“The presence of the VR [verbal reflexive marker] blocks long-distance binding in Dravidian, Munda and Tibeto-Burman [...] An anaphoric form which is otherwise ‘antilocal’ becomes ‘local’ when the VR occurs.” (Subbārāo 2012:66)

Instead, it remains an open question what derives subject orientation in these long distance cases. There are two possibilities that come to mind, which I will briefly describe.

The first is that, even though Reflexive Voice is lacking, long distance reflexive anaphors undergo (covert) movement to a position in the higher clause, in which the only possible binder is the clausal subject. Under this account, non-subjects would be ruled out as binders because they are too low in the structure, compared to the landing site of this moving reflexive. This idea is essentially the idea that was called Reductionist Movement Approach in (12) of Section 5.2.1, which many have argued for (along the lines of Lebeaux 1983, Chomsky 1986, Pica 1987, Huang and Tang 1991, among many others). The proposal I am exploring here is that this approach only applies to long distance reflexives, and predicts a contrast in properties between local and long

distance subject orientation. In particular, because reflexive Voice is not involved, subjecthood of any type would do, and there would be no expected constraints on derived subjects or clausal voice like we saw in Chapters 3-5; instead, any subject should be able to bind the long-distance reflexive. This proposal essentially predicts that there are two types of reflexive anaphor: local subject-oriented reflexives —involving movement to VoiceP— and others —which may or may not move, but always take a structurally local antecedent.

The second is that subject orientation in long distance binding is in fact an illusion. In recent work, Charnavel and Sportiche (2014, Forthcoming) argue that apparent long distance binding is only ever possible when the antecedent has certain interpretive properties (e.g., being some kind of perspective holder). Under this analysis, the subjecthood constraint on possible binders would, in this analysis, be due to the strong overlap between subjects and logophoric centers.

APPENDIX

APPENDIX A

Types of Movement and the Syntactic Derivation of Reflexivity

A.1 Choosing the Appropriate Syntactic Derivation

One of the core aspects of the VoiceP analysis of LSOR is that the anaphor moves to Spec, VoiceP. I assume that this movement involves spell out of a lower copy, as in (1a), but this movement operation could be thought of in at least three other ways:

- (1) a. Spell-Out of a Lower Copy

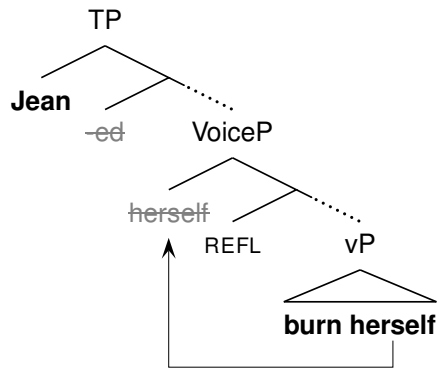

- b. Rightward Movement

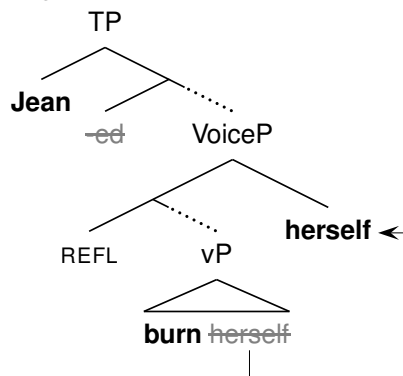

c. Remnant Movement

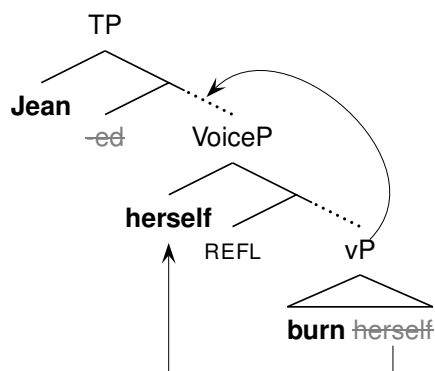

d. Multidominance

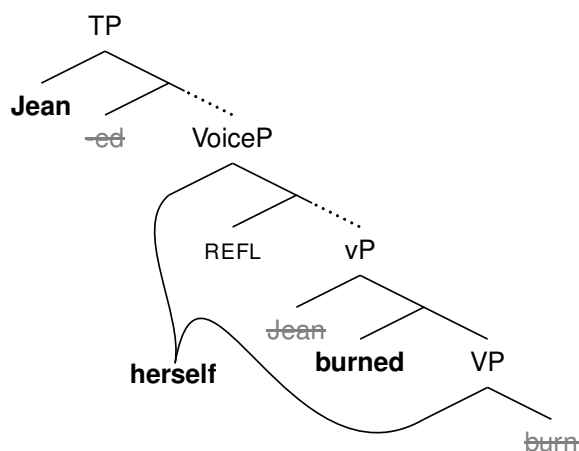

All of these derivations will yield the same prosodic effect: the anaphor is no longer considered to be the most deeply embedded. To be clear, this “most deeply embedded” status could be thought of in two ways. The first way this could arise is because the grammar considers the anaphor to be absent from the position where it might have otherwise been considered as most deeply embedded, because it has moved away (this is possible for derivations like (1b,c)). The alternative is (as presented in the body of the dissertation) that the grammar considers the anaphor to be in more than one position, and therefore is not the most deeply embedded, because it also occupies a higher position (this is possible in any of the derivations in (1)). In this way, any of the derivations above (among others) could achieve the prosodic effects that are captured in this dissertation by the anaphor having moved to Spec, VoiceP.

However, English word order makes it seem that the Voice-related reflexives, such as the extrametrical reflexive in (2) and the REAFR example in (3), have not moved beyond the normal

object position:

- (2) Q: What is Ken doing?
A: He's cooling *some súp* down. Baseline
A: He's cooling himself *dówn*. Extrametrical
- (3) Q: Who put Norbert in a gorilla suit?
A: **WÉ** put Norbert in a gorilla suit. Baseline
A: Norbert put **HIMSÉLF** in a gorilla suit. REAFR

Specifically, nothing can intervene between the verb and the anaphors in (3), in the same way that nothing can intervene between the verb and other DPs:

- (4) a. He puts (*often) Liz in a gorilla suit.
b. He puts (*often) himself in a gorilla suit.

Doubt seems to be cast on analyses like (1b&c). In either of these analyses, it might be expected that something could intervene between the verb and the anaphor, as the anaphor and the verb have been pulled apart.

Under a separate interpretation of an analysis like (1c), one might expect that the anaphor has moved into a position where the anaphor is closer to the verb and cliticizes to it (not unlike Romance). However, consider (5):

- (5) Q: Who gives a hefty bonus to Jack every year?
A: Jack gives a hefty bonus to **HIMSÉLF** every year. REAFR

This shows that the anaphor can be linearly separated from the verb by lexical material, which would not be possible under a cliticization-to-verb analysis.

For these reasons, I argue that a derivation like (1d) or (1a) best fits the data.¹ In the body of the dissertation I employ the latter, for the way it deals with linearization (see Section 3.5.2.1 for further discussion); additional statements would be necessary to deal with linearization and (1d) (see, e.g., Fowlie 2011).

¹However, nothing explicitly rules out other derivations, as it could be that subsequent movements would yield the appropriate word order facts.

A.2 Covert Overt Movement

Though it has been proposed that (certain) anaphors undergo LF-movement (i.e. true covert movement; see e.g. Reuland 2011), it cannot be that the anaphor becomes associated with Voice via LF-movement or via a probe-goal relationship (i.e. without movement). If either of these operations were employed, the prosody would not be fed. Under standard approaches to spell-out, the syntactic structure is sent to the phonological component (where prosodic calculations are made) before any LF-movements would occur. Similarly, probe-goal relationships that don't necessitate movement will not affect the structure that is sent to the phonological component.

However, if the anaphor moves via a “covert overt movement” operation as in (1a), the syntactic structure sent to the phonology would be affected without affecting word order. The big question that arises out of this is, why does movement in this situation spell out a lower copy? In other words, why would the grammar opt for lower-copy spell out in this situation?²

One possible answer to this question is that this reflexive movement cannot be result in a new linear order because it would violate a previously established linearization (cf. Fox and Pesetsky 2005's Cyclic Linearization). Thus to comply with the conflicting demands of “move” and “don't

²The question for a multidominance approach would be: what determines which structural ‘address’ of a constituent it is that linearization attends to?

create a new linearization”, the tail of the movement chain is spelled out.³

A.3 Covert Overt Movement and Prosody

It has been proposed that prosody and covert movement are tightly linked. Namely, Hirotsu (2004) proposes that the scope of any element should not extend beyond the prosodic phrase containing it. Hirotsu’s generalization can be captured if we assume that QR is covert overt movement (e.g. Groat and O’Neil 1996, Fox and Nissenbaum 1999, Bobaljik 2002), and if we assume that prosodic phrasing is dependent on syntactic phrasing (e.g. Selkirk 2011). To clarify, consider (6), where A and B are scope bearing elements, and A is generated below B, but is interpreted above B by QR’ing (undergoing covert overt movement) to XP.

$$(6) \quad [_{XP} \overset{\uparrow}{A} \dots B \dots [_{YP} A]]$$

The phonology will decide to phrase A and B together because they are both within XP. However, A is pronounced lower, in YP, which the phonology may want to be its own prosodic phrase. Thus the phonology has conflicting interests – it wants to give YP its own phrase boundaries, (7a), but it also wants A and B phrased together, (7b):

$$(7) \quad \begin{array}{l} \text{a. } [_{\Phi} B \dots] [_{\Phi} A] \\ \text{b. } [_{\Phi} B \dots A] \end{array}$$

In such a scenario, the phonology ranks phrasing A and B together as more important than giving YP its own prosodic phrase boundaries – thus A and B will be phrased together by the normal rules of phrasing, just in case A has QR’ed to above B.⁴

Additionally, beyond QR, Givenness has been argued to require movement that feeds prosody.

³If this is the case, then a language with overt movement and a language with covert overt movement ought to be distinguished by some independent parameter that would play a role in whether reflexive movement would violate a previously established linearization. Alternatively, perhaps it’s that there are multiple levels of structure, which want to be as isomorphic as possible (Shape Conservation, Williams 2003). In this system, perhaps reflexive-movement is only done in prosodic structure (and not surface structure) minimizing shape distortion between surface structure and, for example, theta and case structures.

⁴Again, assuming LF does not feed prosody, non-syntactic movement would not make any predictions here.

In many languages, such as German or Japanese, movement is required for Topic-hood. This English may look like an entirely different system, Wagner 2006 shows rather convincingly that movement happens even in English, despite the fact that Given material doesn't always overtly move. Specifically, he argues that the reason Given material avoids phrasal stress is because it has moved to a position that the phrasal-stress licenser would not assign stress to. Though he does not discuss what kind of movement is employed, it seems to fit the description of covert overt movement.

Similarly, in many languages (e.g. Hungarian, Zulu), Focus must involve overt movement, even though English seems to be able to achieve focus without movement.⁵ If Focus requires movement, English seems to employ covert overt movement since focused elements do not often seem to be displaced.⁶

In other words, there seems to be a family of grammatical phenomena in English whose derivations involve spell-out of a lower copy: Focus, Givenness, QR, and Reflexivity. Though covert in their consequences for linearization, these derivations all catalyze prosodic effects.⁷ However, more work must be done in investigating how these derivations are related such that they all would employ covert overt movement, as opposed to a 'normal' overt movement opera-

⁵I believe Wagner would also treat this apparent focus-movement phenomena as the result of movement as the result of something else being Given. I remain agnostic as to this – either way, what appears to be displacement of Focused things would be derived by overt movement (at least in some languages).

⁶Thus Focus inside of islands must be resolved by having a Focus projection inside of the island, or perhaps allowing long-distance licensing of Focus just in case movement is impossible (along the lines of what Preminger 2011 describes for agreement and object shift, among other operations). The latter seems more appropriate given certain Zulu facts with double object constructions – see fn. 2.

⁷It could be that this is how covert movements could be learnable: they have prosodic effect.

tion.

A.4 Covert Overt Movement and its Consequences for the Theory of Islands

As a consequence of covert overt movement, PF-theories of islands (e.g. Merchant 2001, Fox and Lasnik 2003) face problems.⁸ Under a PF-theory of islands, the problem with moving out of an island is that the trace (or perhaps unpronounced copy) left in the island is marked with a *-feature, which cannot be sent to PF (e.g. Merchant 2008). Thus, an island violation like (8) is due to the *-marked copy being sent to PF.

(8) *What do you eat [_{island} beans and ~~what~~*]
▲

This is exploited to resolve the problem of being apparently able to violate island constraints, just in case the structure containing the *-marked copy/trace undergoes ellipsis. That is, the answer to the question in (9), when given as a fragment answer, is assumed to involve movement of *rice* to the left periphery, with the rest of the clause undergoing ellipsis (the ▲ symbol indicates the ellipsis site).

(9) Q: You ate beans and what?

A: Rice ▲.

(▲ = I ate beans and ~~rice~~*)

Since the copy with the *-feature was elided, it was not sent to PF, and did not crash the derivation.

Now let us consider a sentence in which the reflexive anaphor has moved to Spec, VoiceP from inside an adjunct island. If this movement could occur, then *herself* would be able to bear REAFR prosody.

(10) Q: Who counted five tourists besides Lucie?

A: # Lucie [_{VoiceP} herself counted [_{island} five tourists besides **HERSELF**]].
▲

However, REAFR is not available here. In other words, this movement is island-sensitive, even though you spell-out the tail of the chain. There is no trace or unpronounced copy within the

⁸Thanks to Norbert Hornstein, for bringing this to my attention.

island; therefore, there should be no trace/copy in the island to be *-marked. In other words, a PF-theory of islands would incorrectly predict that (10) to be grammatical – putting into question whether such a theory of islands is appropriate.⁹

A.5 An Alternative to Covert Overt Movement

A.5.1 A Different Approach to DPs

Current lines of research suggest that much of the functional material in the nominal domain is merged rather high in the clausal structure – outside of the thematic domain – e.g. prepositions (e.g. Kayne 2005), (certain) person features (e.g. Coon and Preminger 2012), and even determiners (e.g. Sportiche 2005).

As such, the nominal arguments of predicates are NPs, not DPs. This is corroborated by the fact that predicates are known select certain types of NPs (animates, time expressions, holders of political office), yet hardly ever select a certain type of D. If selection is local, this means predicates must select NPs, and not a DP (as the properties of the NP are invisible to the predicate, if the NP is embedded in a DP).

Additionally, this solution obviates the need for type shifting of quantified nominal expressions in argument positions, when it comes to composing with the predicate. All of a predicate's nominal arguments are NPs of the same semantic type¹⁰, and the D or Q, which merges later on the spine, restricts the interpretation appropriately, without issue of type-mismatch.

In this way, the structure that underlies linearization of a VDN sequence such as *see the mon-*

⁹A PF-theory of islands might be able to work if the higher copy were somehow *-marked, or the lower pronounced copy were (though *-features are implemented under a trace-theory of movement). It is not clear whether copies outside of the island (or pronounced copies within the island) would be assigned a *-feature under the normal rules of *-feature-assignment.

¹⁰NPs are said to be of type $\langle e, t \rangle$, and predicates have been said to compose with arguments of type e . This approach would mean we would need to adjust the lexical semantic properties we posit for predicates with nominal arguments.

key is quite complex, and the verb must land in a position such that it precedes the D head that is outside of the VP. In this way, perhaps the anaphor in an LSOR derivation moves rather high – to VoiceP – but the fact that the verb precedes moving anaphors (in the way that the verb precedes all other nominal arguments) does not need to rely on spelling out the tail of the chain. Instead, the anaphor could still be higher than the verb at the relevant stage of the derivation, while being linearly preceded by it. This will be more formally laid out in the following subsection.

A.5.2 The Linearization Problem Revisited

Let us imagine that the phi-feature bearing morpheme of the DP reflexive anaphor (e.g. *my* in *myself*) is the D.¹¹

- (11) [_{DP} [_D my] self]

Empirical evidence for this comes from the behavior of incorporated nominal arguments:

- (12) a. We are fools who medicate **our dolphins**.
 b. We are **dolphin**-medicating fools.
 c. *We are **our dolphin**-medicating fools.
 d. We are fools who medicate **ourselves**.
 e. We are **self**-medicating fools.
 f. *We are **ourselves**-medicating fools.

Incorporation has long been known to involve the “removal” of functional morphemes such as Ds, explaining why (12b) is grammatical, but (12c) is not. The fact that the “our” gets removed from (12a) in the incorporation case in (12b) is expected, if it is some kind of D that is structurally similar to the D in (12a–c).¹² As such, the “removal” of “our” in the incorporation in (12e) – and its inability to be present in incorporation contexts like (12f) – can be taken as evidence that “our” is a D in “ourselves”.

¹¹Or maybe some larger conglomeration of heads that are merged outside of the thematic domain.

¹²It is not problematic if standard analyses are correct and “our” is more than a simple D, as has been the standard analysis for canonical instances of Saxon genitives since Abney 1987. If incorporation “removes” the possessive D that introduces the possessor pronoun, then the possessor pronoun ought to also be “removed”, since nothing will have selected it as a specifier.

If Ds are merged outside of the theta domain, that leaves “self”/“selves” as the NP merged within the thematic domain of a reflexive clause, and this will be what moves to VoiceP:

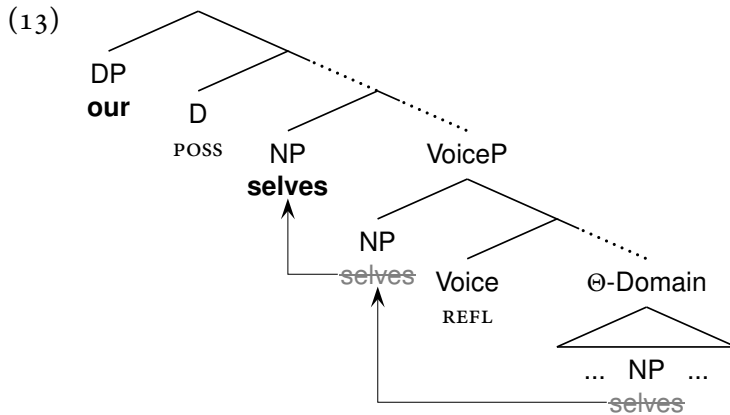

Now, if much (or all) of functional material of the DP is merged outside of the thematic domain, then, like the D associated with a reflexive NP “self”/“selves”, the D associated with a non-reflexive NP will be similarly outside of the thematic domain:

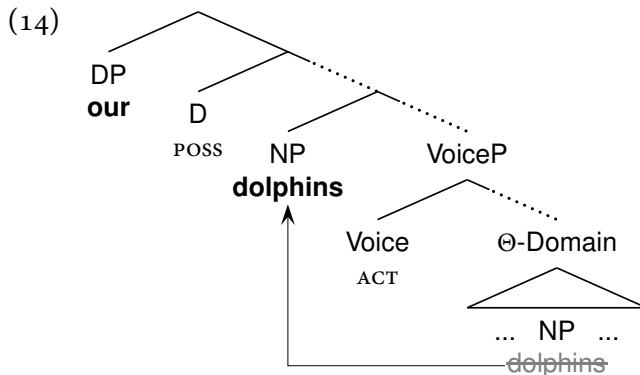

Then it must be there is additional movement of NPs to the appropriate Ds/Ps/etc, to create the surface constituency that we see. In this sense, it is these movements, plus movements of constituents that contain the verb, that determine the linear order of the arguments in the VP (and not simple X-Bar settings, for example). And direct objects, reflexive or not, will all be linearized in the same position.

This more complicated syntax derives the original problem presented in Chapter 3, in a new way: How do we get reflexive objects to linearize in the same position as non-reflexive objects

while having different prosodic properties? The new solution in this appendix section is basically the same as the original presented in the body of this thesis: the reflexive NP undergoes a movement that the non-reflexive doesn't (compare the two movements of (13) to the single movement of (14)), and that movement changes phrasal stress assignment.

The only difference is that, under this theory, surface position of objects is not determined within the thematic domain, but outside of it. Spelling out a lower copy was only necessary if the linear order of non-reflexive objects is a direct result of their structural position within the thematic domain. Since that is no longer the case, and since both reflexive and non-reflexive objects move out of the thematic domain to form a surface constituent with their Ds (and Ps, etc.) in the same way, the theory need not be weighted down by the stipulation that reflexive objects, and not other objects, are spelled out lower than their highest structural position.

A.5.3 Further Support and Open Questions

The semantic system set up here would predict that the definiteness or quantificational nature of an antecedent has no bearing on the binding of the LSOR anaphor. The anaphor is bound as a result of VoiceP merging, at which point all arguments are still NPs. In this way, the semantic type of the antecedents in (15a–c) is identical at the relevant point of the derivation:

- (15) a. Every nun surprised herself.
b. The nun surprised herself.
c. A nun surprised herself.

As a result, nothing special needs to be said about type shifting so that the binder can enter the IDENT relation with *herself*. (For details of the IDENT relation, see Chapters 4 and 5.)

This is important because it is not clear that we should find LSOR marking interacting with definiteness, specificity or quantification in a language. Such data has yet to be uncovered. If such a language were found, this theory makes the prediction that Ds/Qs must be in a (potentially indirect) selectional relationship with VoiceP, and as such interactions between Voice and D/Q

should be seen elsewhere in the language. (See Section 5.4.4).

The general idea of (13) and (14) is that they occupy very similar positions, because of the D. Because of this, an open question for this framework would be, how we now derive the word-order effects we see in English. The prosodic properties of LSOR anaphors seems to indicate that in V Prt sequences, the LSOR anaphor must occur between V and Prt (unlike other nominal complements in particle verb constructions). LSOR anaphors must occur between V and Prt:

(16) Q: What happened at the rehearsal?

A1: The actors used IMDb to look themselves úp. *V Refl Prt*

A2: # The actors used IMDb to look úp themselves. *#V Prt Refl*

This is even in REAFR constructions, where they are prosodically heavier (indicating that prosodic weight is not the issue):

(17) a. The coffee won't warm ITSÉLF up. *V REAFR Prt*

b. # The coffee won't warm up ITSÉLF. *#V Prt REAFR*

Now that, in this framework, LSOR anaphors and other nominal complements are being argued to occupy the same position, the task is to find a structure that derives the differences in the linear surface positions the LSOR anaphor and other nominal complements.

APPENDIX B

Alternative Semantic Derivations

At this point, it is well motivated that there are two basic types of anaphors: (i) LSOR anaphors, whose distribution is constrained in many ways, including that they must have a local subject as their antecedent, and (ii) non-LSOR anaphors, whose distribution is constrained in different ways not explored here. In Chapter 3, we sketched out the basic syntactic properties of the LSOR derivation, and in Chapter 4, we elaborated upon that structure, in the contribution of the Reflexive Voice head.

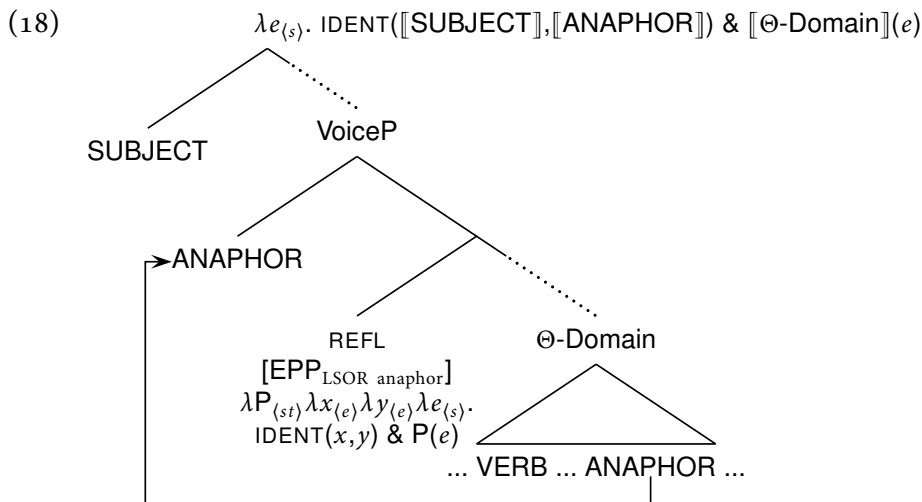

In particular, we argued that the Reflexive Voice^o contributes the semantics of the IDENT function. As a result, the only possible derivation is one in which the IDENT function coidentifies the subject and the anaphor that moves to VoiceP.

Though the data to be accounted for is captured by the formalisms above and framework assumed, there are only a few aspects of the analysis that are truly necessary.

(19) **The Core Underpinnings of LSOR**

- i. REAFR is the result of an LSOR derivation with focus on the semantic reflexivizer
- ii. There are two atoms of reflexivity in LSOR:
 - (a) an anaphor merged in an argument position, and
 - (b) a Reflexive head on the spine that is associated with grammatical voice and the semantic reflexivizing function
- iii. These two atoms yield the LSOR properties:
 - (a) The anaphor undergoes movement when the Reflexive Voice^o is merged, and
 - (b) The local subject necessarily binds the LSOR anaphor, due to the syntactic structure and normal rules of semantic composition.

This condensed version of the theory allows for derivations with different specific implementations. In this appendix, we will explore some possible alternative semantic derivations, with LF movement, lambda abstraction, and a different syntactic locus for the semantic reflexivity function.

B.1 LF Movement

In some frameworks, movement can take place after the syntactic information is sent to Phonology; this post-syntactic movement for purposes of interpretation is known as LF movement. In some past analyses of reflexivity, reflexive anaphors have been argued to undergo LF-movement (e.g. Lebeaux 1983, Chomsky 1986b, Reinhart and Reuland 1993, Reuland 2011). Chomsky 1995 describes this derivational option:

“...the reflexive must move to a position sufficiently near its antecedent. This might happen in the syntax, as in the cliticization processes of the Romance languages. If not, then it must happen in the LF component.” (Chomsky 1995:104)

English, in which there is apparently no necessary word-order change to express any kind of reflexivity, has been argued to be the kind of language in which reflexive anaphors move at LF.

Of course, even movement in the narrow syntax can be consistently string-vacuous (e.g. English subject-WH questions). How then can it be argued whether a given movement is taking place in the narrow syntax or at LF? In the standard Minimalist conceptualization, one differ-

ence between LF-movements and narrow-syntactic movements is that only the latter can have any phonological effects (as LF operations do not feed the PF component). Thus, if a movement operation results in PF effects in any domain (including but not limited to linearization), then that would be enough to argue that that movement takes place in the narrow syntax, and not at LF. With English as the classic case for LF-movement of anaphors, the idea that LF movement is possible is dealt a striking blow by the fact that English exhibits prosodic effects just in cases where movement is necessary (see Chapters 3 and 4).

Of course, it is still possible that there exists some language in which LF movement of the anaphor is still a tenable analysis. However, there is no necessary requirement that a movement should have some PF effect; as such, not finding PF evidence for the movement would not be enough to argue that it must take place at LF.

This raises an important question concerning the status of LF movement. In the absence of PF evidence for movement X, the learner is presented with three options: (i) movement X is consistently done at LF, (ii) movement X is consistently done in the narrow syntax, or (iii) movement X is variably takes place at LF or in the narrow syntax. What the learner actually does in such a situation would have to be a question for further research. Of course, the architecture of the Language Faculty could inform this debate. For example, it has been argued that post-syntactic movement is not a grammatical operation at all; instead, all purported instances of LF-movement are in fact instances of movement in the narrow syntax (e.g. Kayne 1998). If this is the case, there is no problem for the learner (or the theoretician) – the movement will certainly take place in the narrow syntax.

B.2 Lambda Abstraction

This dissertation assumes a theory in which any given element can compose with multiple semantic functions, as the result of movement – I will call this multiple-composition. The following

structure is taken from Chapter 5 Section 5.3.2 :

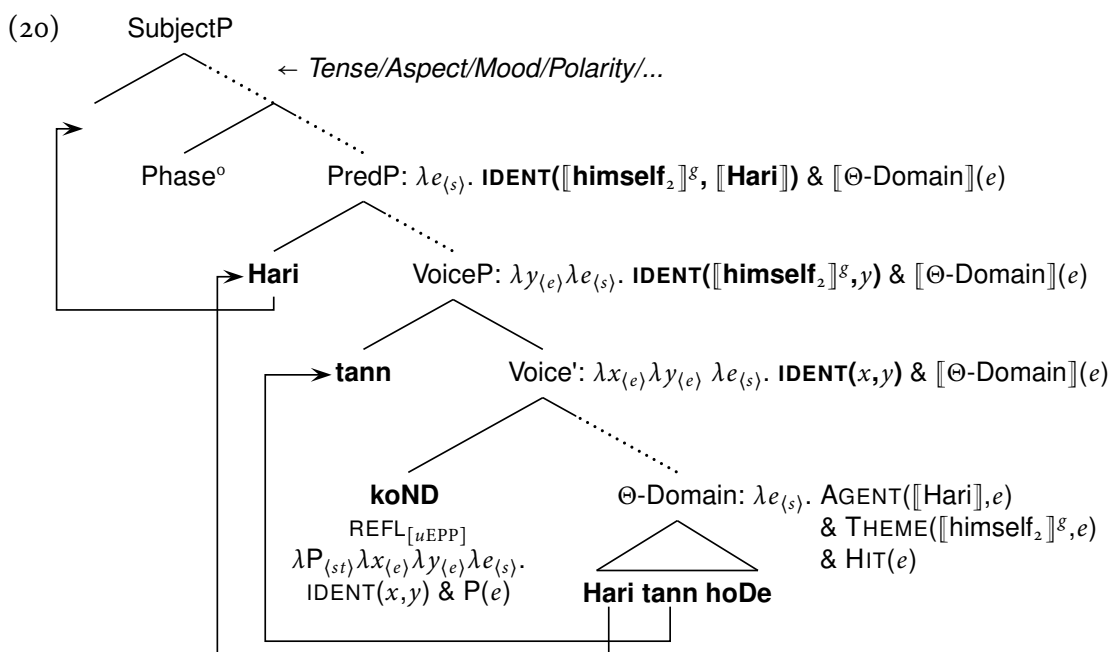

In (20), both *Hari* and *tann* have composed with two functions (their respective theta assigners and IDENT). Many standard theories of the syntax-semantics interface do not derive structures using such multiple-composition, and it might be that this is because multiple-composition is in fact not a grammatical possibility. Even it can be convincingly shown that multiple-composition is impossible, the derivation in (20) could still be re-cast using what (in this author's opinion) amounts to a notational variant: lambda abstraction (e.g. Heim and Kratzer 1998).

Let us explore a few possibilities of how a derivation could proceed, using lambda abstraction instead of multiple-composition. As a first pass (which fails), let us attempt a derivation identical to (20), with the exception that lambda abstraction is used. There are two things worth pointing out in (21): first and foremost, it does *not* converge; second, the lambda abstractors for the traces are indicated in boxes.

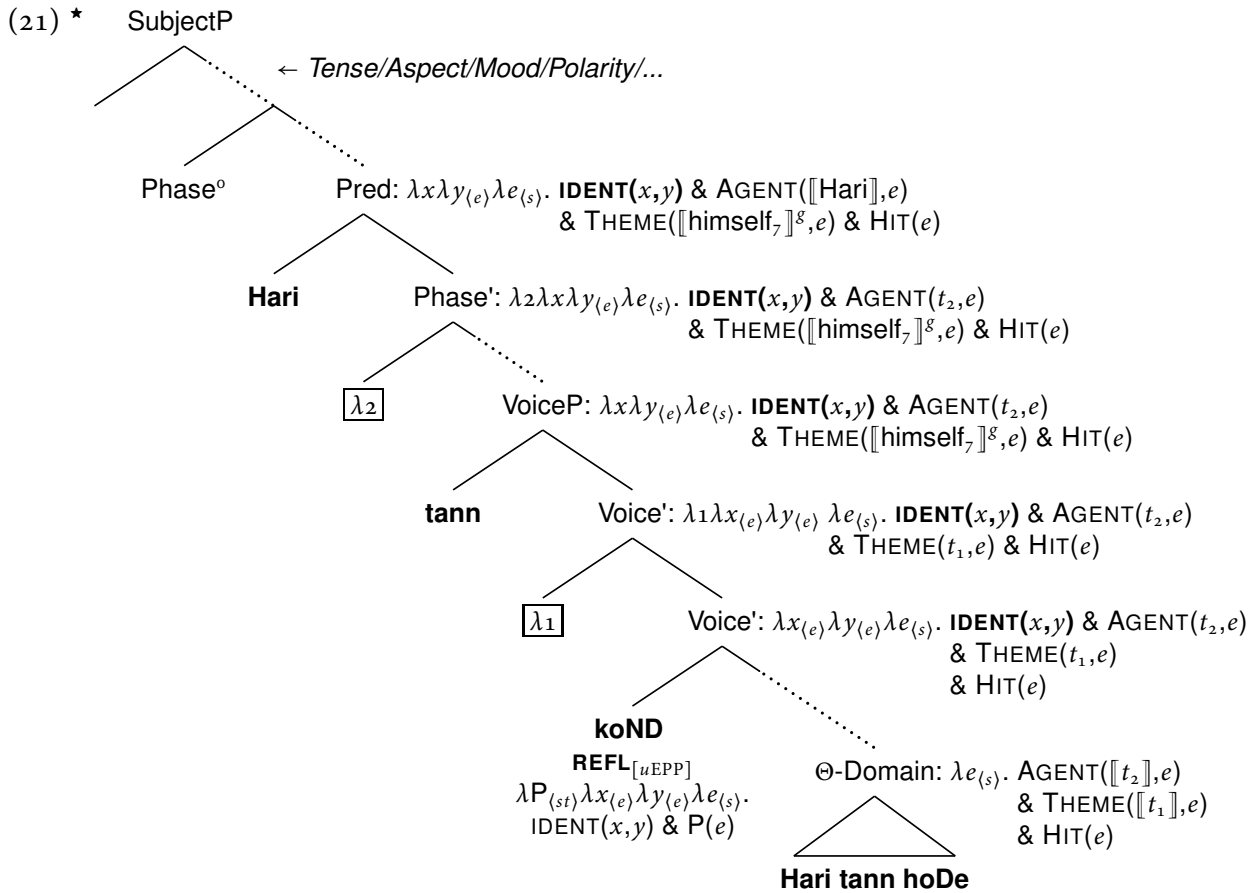

The problem with this kind of derivation is the λx and λy introduced by the REFL function will not have the chance to be saturated (at least not by the right constituent). This is because *tann* and *Hari* compose with λ_1 and λ_2 , respectively, and this essentially blocks them from being able to compose with IDENT.

To solve this problem, we could imagine that the λ_1/λ_2 are not (spuriously) added outside of REFL when movement takes place (in fact, if they were, this would seem to be a violation of the No-Tampering Condition, Chomsky 2007). Instead, it could be that the lambda abstractors are bundled within the Voice head – in a sense replacing the λx and λy in (21).¹ Thus, (20) could instead be derived as in (22):

¹Keir Moulton (p.c.) has proposed a nearly identical structure in an unpublished presentation, in a similar vein: some types of reflexivity are restricted to structures in which bundling of this kind of lambda onto the Voice head has occurred.

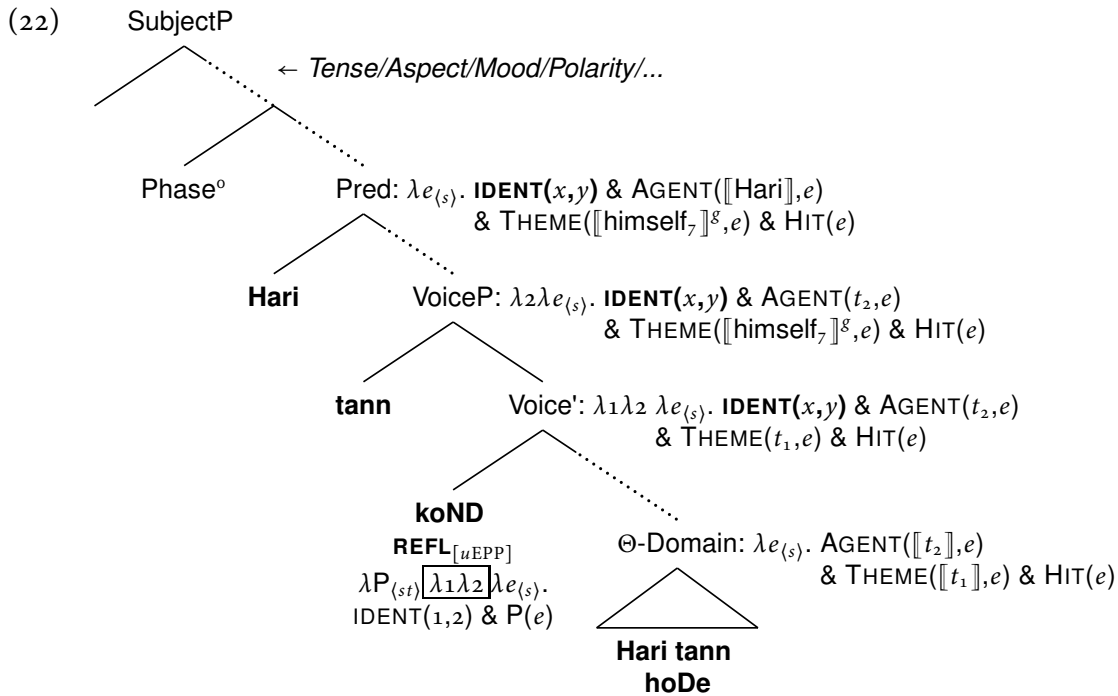

Essentially, bundling the lambda abstractors with the REFL Voice head means that merging REFL will always result in the movement of two things from in its complement to a higher position (like the EPP). If there is no movement, the semantic derivation will crash as the abstractors will not be abstracting over any trace variables. Another way of looking at this is that we have reduced the $uEPP$ feature to the denotation of REFL (or have at least made them effect the same result). Thus an analysis like (22) in which we have lambda abstraction over traces leans on movement in the same way as (20): both the subject and anaphor must move, in order for a derivation with REFL Voice° to converge. The only differences are technical ones.²

Another (very similar) possibility would be that these lambda abstractors are the semantic reflex of the EPP for both subject and anaphor. In such a derivation, this would mean that REFL has 2 EPP features: one for the LSOR anaphor, and one for the subject. This would mean that the movement of both must target the VoiceP, requiring that multiple specifiers are a derivational possibility.³ The relevant differences between (22) and this alternative are presented in the truncated

²This is not to dismiss the differences; it just means that the correct derivation for LSOR leans not on the basic machinery of this analysis, but on the technical machinery made available to the grammar.

³One final alternative is that REFL doesn't attract the subject and the anaphor separately, but as a single constituent,

structure below:

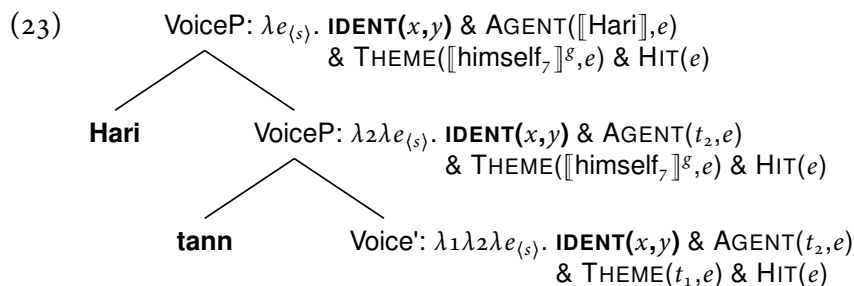

Again, the movement is necessary for semantic reasons. (22) and (23) only differ in that (i) the subject is more syntactically local to the head that introduces its lambda-abstract, and (ii) it relies on the existence multiple specifiers.

Returning now to the larger point, the multiple-composition approach in (20) and both of the converging lambda-abstraction derivations above in (22) and (23) have more similarities than differences. In fact, all are predicated on movement in order to converge and more generally rely on tight relations between syntactic and semantic structure. This invokes a sense of isomorphism between syntactic and semantic structures, and is reminiscent of the basic claims of long-standing grammatical approaches such as Montague grammar (and the approaches it has subsequently inspired). Stokhof has recently characterized Montague grammar with the following passages, which are well-represented by (20), (22) and (23).

“Semantics is syntax-driven, syntax is semantically motivated.”

(Stokhof 2006:2067)

“Any semantic object or operation on such objects has to have a correlate in the syntax, an expression or operation that triggers it. And conversely, all expressions and all structural operations in the syntax have to have a semantic correlate. Thus the autonomy of syntax is limited.”

(*ibid.*)

such as the kind of constituent proposed in Kayne 2002. (This would entail changes in the denotation/location of the IDENT function.) This Kaynean alternative would not require multiple specifiers, and would be in the same spirit as (23).

B.3 Anaphor=Reflexivizer

Some theories of reflexivity assume differently that (certain) anaphors instantiate the semantic reflexivizers (Bach and Partee 1980, Szabolcsi 1987, Keenan 1988, Schlenker 2005, Spathas 2010, among others). In such a theory, the reflexivizer *himself* has a denotation like the following:

$$(24) \llbracket \text{himself} \rrbracket = \lambda R_{\langle \text{est} \rangle} \lambda x. R(x, x)$$

Let us call this theory the Anaphor=Reflexivizer (A=R) theory; and the theory presented in this dissertation will be called the Voice=Reflexivizer (V=R) theory.

Importantly, regardless which theory is correct, the generalizations found here about LSOR rely on *movement*. An A=R theory does not inherently rely on movement, meaning that it requires careful formulation in order to have the appropriate empirical coverage.

Some semantic approaches to reflexivity (which are compatible with an A=R hypothesis) argue that movement *does* happen when the anaphor is the reflexivizer (e.g. Reuland 2011). For example, this movement has been said to be required in order to reflexive-mark the predicate (see Section 5.5.2 of Chapter 5), or to allow for composition to happen normally. If, in addition, this movement targets the specifier of a REFL VoiceP, we can achieve all the same generalizations that were seen in body of this dissertation, and the A=R and V=R theories have the potential to be notational variants.⁴

In order for the A=R and V=R theories to be notational variants, what must remain constant is (i) that there is a unique REFL VoiceP, to which LSOR anaphor move, and (ii) that REFL VoiceP is associated (directly or indirectly) with semantic reflexivity. If REFL Voice were not associated with semantic reflexivity, deriving the complementarity with passives and other voices is obscured, and

⁴Though both are potential solutions, each theory would make some rather different assumptions in the framework. Thus evidence in favor of one framework over another could influence the choice between A=R and V=R theories. For example, if one assumes (as I do) that syntactic arguments (i.e. non-heads) are never semantic functions on their sisters, only the V=R theory is a possible candidate. (Such an assumption (predictably) constrains and complicates syntactic representations, but makes more principled the mapping of syntax onto semantics.)

we potentially lose the connection to subject orientation and word-order facts.

Of course, the A=R and V=R theories necessitate differences, the most notable of which is in the denotation of the reflexivizer function; they cannot be the same, since the structural locus of reflexivity will differ.

In summary, the basic theory must say that a the semantic reflexivizer function depends on (i) reflexive anaphors move, and (ii) movement depends on a unique Voice^o (REFL). Thus the basic ingredients of a complete analysis of LSOR are the same, though how exactly this is implemented theoretically is up for debate. In fact, the choice of either V=R or A=R over the other is likely to be dictated by the choice of framework.

APPENDIX C

More on Reflexivity in Romance

Sportiche (2011b) motivates the need for phrasal movement of *se*, not unlike the movement of *himself* argued for in this dissertation, employing a functional head HS^o. However, given the way HS^o is described, it may in fact be the same as Voice^o; thus I assume a structure like (26) for (25):¹

- (25) Jeanne se blesse
 Joan REFL hurt
 'Joan hurt herself'

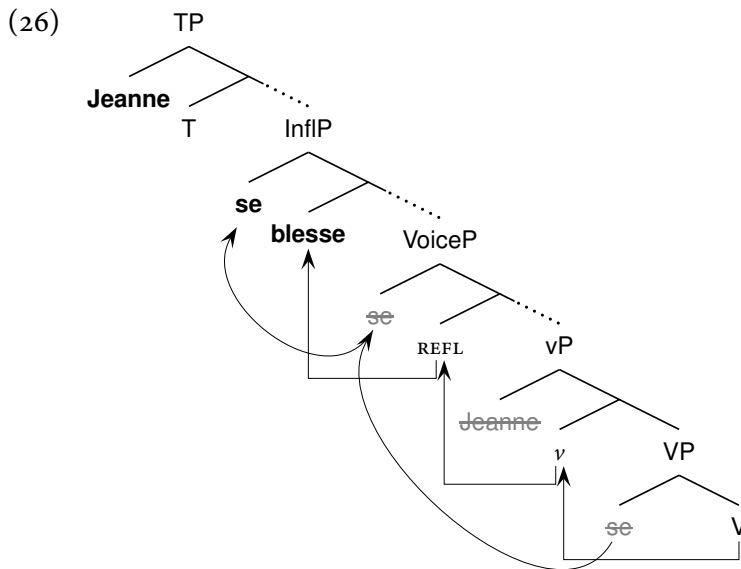

For language-specific reasons, French demonstrates the need for slightly more articulated structural analysis. Namely, I assume that the verb moves beyond VoiceP (to, for example, Infl), deriving the difference from English in terms of, e.g., adverb placement (Pollock 1989):

¹An different solution might consider *se* to be base-generated higher in the structure, requiring a silent reflexive pro-form to move to Spec,VoiceP (see e.g. Borer 1984 and Sportiche 1996). Such an analysis still makes the same predictions regarding Voice and where *se* can occur, as in (28).

- (27) a. *John kisses often Mary.
 b. Jean embrasse souvent Marie
 John kiss often Mary
 'John often kisses Mary'

Thus the clitic must have moved beyond the specifier of VoiceP, in order for it to linearly precede the verb.² However, it is important to note that, aside from the independent differences of V-to-I and clitic-climbing, the structure at VoiceP for French is identical to the English structure argued for here. Due to the derivational similarities, this analysis predicts the properties shared by English and French, laid below in (28):³

(28)	REFL-related <i>himself</i>	Romance <i>se/si</i>
a. Can be Direct Object	✓	✓
b. Can be Indirect Object	✓	✓
c. Can be generated in an island	×	×
d. Can have a non-subject antecedent	×	×
e. Can have a derived-subject antecedent	×	×
f. Can occur in passives	×	×

These shared derivational properties are predicted under the REFL Voice analysis of reflexive *se/si*. Importantly, these properties are not predicted for Romance languages, if the reflexive *se/si* is merged as the external argument, or if it occurs in reflexive clauses as a more general marker of unaccusativity/reduced valency (see Section 4.3.2 and Sportiche 2014, contra e.g. Marantz 1984, Sportiche 1990, Pesetsky 1995, Rooryck and Vanden Wyngaerd 2011).

As evidence for this, children acquiring Italian treat reflexive *se/si* as different from other instances of *se/si*, with regard to auxiliary selection⁴ (Nina Hyams and William Snyder, p.c.). What this shows is that, to whatever extent there are unaccusative/reduced valency uses of *se/si*, reflexive

²Alternatively, the verb may not move beyond Voice and the *se* may not either, if remnant movement of VoiceP is employed rather than separate movements of the verb and its clitics. In fact, this would seem preferable, so that the subject could be the closest DP for movement to subject (if *se* and other clitics are interveners of the relevant type).

³French disallows *se* in some contexts that English allows the Voice-related *himself*: namely when the anaphor is the object of certain (strong) prepositions. This is likely due to the fact that English allows P-stranding but French does not.

⁴Reflexive *se/si* sometimes occurs in child speech with perfect auxiliary 'have', whereas other types of *se/si* always occur with 'be'. (Adult grammars employ 'be' for all types of *se/si*.)

se/si is not treated as the same by the grammar.

APPENDIX D

Movement to Spec, VoiceP doesn't create binding violations

In a REFL Voice derivation, it might appear that the moved reflexive should create a condition C violation, since the reflexive ends up c-commanding a coindexed DP lower in the structure:

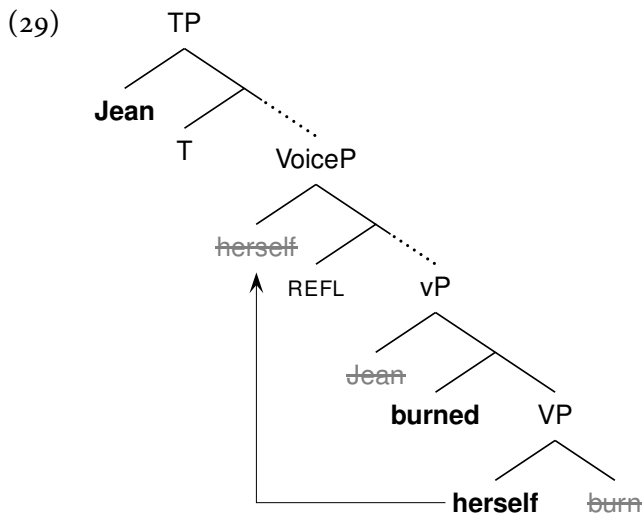

If binding conditions are checked at every point in the derivation, $herself_i$ would bind (the lower copy of) $Jean_i$ in (29). However, if (29) is in fact *the* grammatical structure, there must not be a condition C violation. This apparent contraction is resolved if the binding conditions need not be checked before the last A-movement (Sportiche 2011a). In other words, the binding conditions need not be checked until *Jean* has raised (A-moved) to its case position, in TP.

To motivate this, consider another empirical phenomenon in which a reflexive c-commanding its antecedent doesn't create a condition C effect: raising over an experiencer. To understand how experiencers relate to the issue at hand, I first establish that the experiencer argument of a raising verb like *seem* c-commands into the complement clause, despite being inside the *to*-PP:

- (30) a. It seems to him_i that you are taller than John_{j/★i}.
 b. You seem to him_i ~~you~~ to be taller than John_{j/★i}.
- (31) a. It seems to [every girl]_i that John is taller than her_i father.
 b. John seems to [every girl]_i ~~John_j~~ to be taller than her_i father.

Given the condition C effects and pronominal binding of (30) and (31), respectively, it must be that the lower clause is in the experiencer's c-command domain. Logically, then, a reflexive experiencer as in (32) should c-command into the lower clause.

- (32) John_j seems to himself_j ~~John_j~~ to be taller.

Moreover, if binding is evaluated at every merge, we ought to expect a condition C violation in (32); namely, at this point:

- (33) [_{TP} seems to himself_j [_{TP} John_j to be taller]]

Under the Sportiche approach, however, the grammar can delay the checking of binding conditions until after *John* reaches its case position, in TP.¹ In this way, there will be no Condition C violation, in the same way that the reflexive doesn't create a Condition C violation in a simple clause like (29).

¹The impossibility of coindexation between a raised subject and a pronominal experiencer is still predicted in a sentence like '*John_i seems to him_{k/★i} ~~John_j~~ to be tall*'. Checking binding conditions before movement will yield a Condition C violation, and checking after *John* reaches its case position will yield a Condition B violation.

APPENDIX E

Reflexives without REFL Voice

E.1 Two Ways to Bind

Reflexive Voice and the derivational properties it yields derive Principle A effects for LSOR anaphors. Local *c*-command within a domain is the only possibility when the Reflexive Voice^o is merged, due to the kind of derivation that is necessary to satisfy the Reflexive Voice^o's syntactic and semantic properties.

Though we derive Principle A's effects for LSOR anaphors, no conclusions are drawn here about how to do so for non-LSOR anaphors. Instead, we conclude that LSOR anaphors and non-LSOR anaphors are subject to different licensing mechanisms. That the binding of an LSOR anaphor is distinct from the binding of a non-LSOR anaphor can be seen in different behaviors with regard to reconstruction/timing effects.

In particular, because the LSOR anaphor's binding is the result of Reflexive Voice, which does not move, we (correctly) expect that there will be no reconstruction effects. It is meaningless to discuss whether an LSOR anaphor reconstructs/is bound before movement – binding only ever happens in VoiceP. On the other hand, if the non-LSOR anaphors themselves are responsible for their binding, we ought to expect variability in where/when binding relations take place with respect to reconstruction/movement. The variable reconstruction/binding effects between LSOR and non-LSOR anaphors is the result of the locus of binding: VoiceP (for LSOR anaphors) or anywhere the anaphor occurs (for non-LSOR anaphors). This highlights the conclusion that the

two are subject to different binding conditions.

E.2 Deciding How to Bind

We also have evidence for the two types of binding from other languages: some languages more obviously differentiate between LSOR and non-LSOR anaphors. For example, in Section 5.4, it is shown that LSOR clauses in some languages employ a perfect auxiliary distinct from the one used in active voices. Italian LSOR clauses employ an anaphoric clitic, *si*, and when *si* is used, the perfect auxiliary used is ‘*be*’:

- (34) Gianni **si** è accusato [Italian, Burzio 1986]
Gianni **LSOR** PERF.NONACT accuse.PART
‘*Gianni accused himself*’

As has been known since at least Burzio 1986, the meaning expressed by (34) can also be expressed without *si*, in which case the non-LSOR (‘strong form’), *se stesso* is used. These clauses, as in (35), behave as active clauses, in that they use the ‘*have*’ perfect auxiliary:

- (35) Gianni ha accusato se stesso
Gianni PERF.ACT accuse.PART himself
‘*Gianni accused himself*’

Minimally, what (34) and (35) indicate is that there must be (at least) two kinds of reflexive anaphors, and only *si*-clauses exhibit behaviors consistent with employing a non-active voice.

However, this begs a deeper question: since both *si* and *se stesso* can be used in similar contexts in terms of meaning, which reflexive ought to be used in which situations? In other words, if a reflexive meaning can be created without REFL, it is puzzling that REFL should be used at all. To ask a stronger question why does the grammar even have LSOR anaphors at all, if their usage isn’t always required; and why are they the more prevalent/preferred pattern?

Perhaps the answer is like Grodzinsky and Reinhart (1993)’s Rule I or Fox (2000)’s Rule H, which place limits on derivational possibilities with regards to coreference:

(36) Rule H A pronoun α , can be bound by an antecedent, β , only if there is no closer antecedent, γ , such that it is possible to bind α by γ and get the same semantic interpretation.

(37) Rule I α cannot corefer with β if an indistinguishable interpretation can be generated by replacing α with a bound variable, γ , bound by β .

To extend this kind of logic to the current problem of LSOR and non-LSOR anaphors, I propose a strong hypothesis, in the form of an additional rule:

(38) Rule J REFL Voice^o should be merged if (i) its presence is grammatically possible and (ii) its presence doesn't change the interpretation.¹

That is to say that usage of LSOR anaphors ought to be maximized. This is striking given that (i) LSOR anaphors are more restricted in its distribution than non-LSOR anaphors (e.g. with regards to clause-boundedness, subject orientation, island restrictions, etc.), and (ii) LSOR seems to be more derivationally complex than non-LSOR (LSOR employs a movement and a semantic function that are not employed in non-LSOR clauses).

This raises still another question: why Rule J, and why force the more restricted and derivationally complex option? This seems to be part of a larger pattern in grammar syntax:

(39) **Maximize Complexity**

The more constrained derivation is utilized to the greatest extent possible.

In fact, there are a great many empirical phenomena in which the more restricted grammatical form is preferred; (40) lists several phenomena of this type:²

¹It might seem desirable to reduce Rule J to being a consequence of Rule I, since REFL Voice^o forces a bound-variable interpretation (see Ahn 2011). However, such an analysis faces some empirical issues, since it seems that bound variable interpretations can arise without REFL:

i. Dr. Freud told Dora about herself before he did [~~tell~~] Little Hans [~~about himself~~].

²Preminger 2011 discusses object shift for specificity as always involving a single grammatical function, which desires movement as much as possible but which does not crash the derivation if movement does not occur. This framework could be useful in explaining possessor raising, movement for focus, and possibly even English reflexive anaphors – the extra movement is done as much as possible; but, if it is not possible, the operation that would normally induce movement can still succeed.

However, if an account in the spirit of Preminger's account is correct, more would have to be said for phenomena in which different lexical items are used for moved and unmoved forms – for example, weak/strong pronoun alternations and LSOR/non-LSOR anaphor alternations in languages that use different lexical items (e.g. Romance). It would require the grammar would have to have an additional set of rules that dictates the choice lexical item for anaphor type, independent of the item's licensing conditions (a post-syntactic, late Spell-Out-type Lexical Insertion

- (40) a. Weak/strong pronoun alternation, (Cardinaletti and Starke 1999)
 b. Object-shift-dependent specificity, (Germanic, Adger 1994; Tagalog, Rackowski and Richards 2005)
 c. Possessor raising, (Nez Perce, Deal 2011; Hebrew and Romance, Landau 1999)
 d. Movement for focus, (Zulu, Halpert 2011; Hungarian, Szendrői 2003)

While a generalized constraint like (39) seems to have descriptive currency in a wide range of domains, one may still wonder about the benefit of preferring complexity. Perhaps (39) is the result of an effort on the speaker's part to exploit the grammatical machinery made available by UG in order to minimize vagueness and/or maximize pragmatic cooperation. In other words, the choice between LSOR and non-LSOR (or any of the derivational options in (40)) could perhaps be reduced to a problem of Gricean reasoning (similar to how Maximize Presupposition is argued to be, in Schlenker 2012).

Since LSOR derivations with REFL Voice are more constrained than derivations which do not employ REFL and instead use non-LSOR anaphors, Maximize Complexity suggests that LSOR anaphors should be used to the greatest extent possible. As a general statement about languages like English or French, this seems to be an accurate assessment of the data. Analyses of other languages, such as Japanese or Kannada, suggest that usage of LSOR syntax is not employed to the maximum extent possible. To account for this, Maximize Complexity could be parametric, to use terms from a principles and parameters framework. Alternatively, in a constraint ranking framework, Maximize Complexity could be ranked differently for each (I-)language, on a per-phenomena basis, and/or relative to other constraints.

model might be appropriate).

Alternatively, it may be that there are two grammatical operations, each selecting different lexical items.

APPENDIX F

Revisiting the Definition of Depth of Embedding

Recall our syntactic, depth-based Nuclear Stress Rule, which was given the following formal definition:

(41) **Structure-Based Phrasal Stress Rule (S-NSR):**

The most deeply embedded constituent in a Spell-Out Domain receives the phrasal stress.

This definition of phrasal stress relies on an understanding of depth of embedding. A preliminary definition of depth of embedding is given in (42):

(42) **Depth of Embedding:**

A syntactic object, X, is more deeply embedded than some other syntactic object, Y, provided that no copy of X c-commands all copies of Y

In informal terms, this definition indicates that a constituent is most embedded if it doesn't c-command (all the copies of) any other constituent.

However, this definition of depth does not make a clear prediction about what is most deeply embedded when a specifier is more structurally complex than its sister. Consider (43) and its structure at Spell-Out, (44), where *funny clowns* is analyzed as more complex than its sister *dance*:

(43) I saw funny clowns dánce

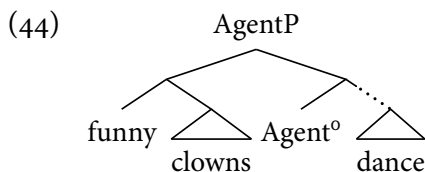

We want to know what the S-NSR and our definition of depth predict as bearing the phrasal stress in a case like (44) (regardless of whether this structural analysis of unergative small clauses

is right).

The definition of depth we have in (42) would make the contradictory prediction that both *clowns* to be more embedded than *dance* and vice-versa, since there is no c-command between the two. This is problematic – it does not derive the fact that *dance* bears phrasal stress in (43) and *clowns* does not. As a result, a reformulation of our definition of depth is required.

Intuitively, there is a sense in which *dance* is more embedded in (44). This intuition seems to come from the idea that there is a spine to the tree, and when considering candidates for depth of embedding we compare elements that merge on the spine. The notion of there being a spine that hold special privilege in considering depth is of the utmost importance. Before implementing this notion formally, let us consider what this notion buys us, in less formal terms.

We want the mechanism for determining depth of embedding to search down the the spine. This means it should consider the nodes that are directly merged on the spine, but it will not look into specifiers' structure. The internal structure of specifiers is not on the spine, and will not even be visible to an operation that only sees what merges with the spine. In other words, the S-NSR considers non-complements to be atomic units, without any structural depth.

This idea, that anything that (re-)merges in a non-complement position will be seen as atomic, is explored in Cinque 1993 and Uriagereka 1999.¹ Paraphrased, Cinque 1993 says that, when a non-complement merges with the path of complementation, that non-complement is only visible as a structural atom.

This implies that no matter how complex the specifier of CP, AgrP, and DP, it will never win over a complement, or, in the absence of [a complement], over the head.

(*ibid.*)

In particular, Uriagereka takes this to mean that non-complements are sent to Spell-Out before merging on the spine – thus they lack apparent depth.

Evidence that specifiers behave as though they have been previously sent to Spell-Out comes

¹A similar but different idea is explored by Hornstein (2010).

from phrasal stress. Specifiers always have a phrasal stress assigned internally, before merging on the spine. (Determining the relative strength between the specifier-internal stress and other stresses is a question outside the scope of this dissertation.) That is, the specifier XP is sent to Spell-Out, the S-NSR operates upon that XP, and the result is an structural atom with (among other things) a phrasal stress. This resulting structural atom can then merge with the spine.

Uriagereka 1999 follows the same logic in the domain of linearization – \$ is an example of a non-complement's root node:

...elements dominated by \$ precede whatever \$ precedes. [...] this is a direct consequence of the fact that [the non-complement \$] *has been spelled-out separately [...] in a different derivational cascade.* (ibid., emphasis mine)

In other words, a specifier is internally-linearized before merging with the spine, and as a consequence precedes whatever the root-node of the specifier precedes.

This leads us to a finalized conceptualization of Depth of Embedding

(45) **Depth of Embedding** (constrained):

- a. A syntactic object, X, is more deeply embedded than some other syntactic object, Y, provided that no copy of X c-commands all copies of Y.
- b. The internal structure of non-complements is not accessible when calculating depth for a given domain.

On some level, the constraint clause in (45b) is unnecessary, as it is a derived property of the system.² It is mentioned as separate (i) for clarity, and (ii) in case a model is employed in which (45b) is not a result of the system. For a more in-depth look at other possible definitions of depth of embedding, see Ahn, *in prep.*

²In fact, there are even more radically reduced systems in which the internal structure of non-complements is *never* accessible for syntax. Non-structural operations would then have access to internal elements of non-complements – see Hornstein 2010's conceptualization of Copy.

APPENDIX G

If Voice^o Introduced External Arguments

The account in Section 4.5.4 of Chapter 4, whereby the reflexive anaphor moves to the specifier of a reflexivizing function that is instantiated by Voice^o, seems to be at odds with past literature that claims that Voice^o introduces external arguments. As discussed in Chapter 4, I take this to be evidence that Voice^o does not introduce those external arguments. For the sake of argument, let us assume that Voice^o has been conclusively demonstrated to introduced external arguments. Even if this were the case, the general analysis of REAFR presented here would still hold.

Being that a conjunctive analysis —in which REFL Voice^o introduces both the external argument and reflexivity— has been shown to be untenable (§4.5.4), a REFL Voice^o could not, in addition to licensing the external argument, instantiate the reflexivizing function. Instead, there would be a second projection that is the locus of the reflexivizing function, to which the reflexive anaphor moves – call it FP – and FP would be in a selectional relationship with the REFL Voice. That is, we split the *ExtArg* and *Ident* functions across two projections (like in the rest of this dissertation), but Voice^o instantiates *ExtArg*, not *Ident* (unlike in the rest of this dissertation).^{1,2}

¹Essentially, this analysis recognizes that there is thematic domain and the reflexivizing function is outside of that domain – deciding which projection to label “VoiceP” is more-or-less arbitrary (apart from trying to unify the locus of grammatical voice in the structure). This is reminiscent of the way Sailor and Ahn 2010 deals with passives, whereby the head which attracts a verbal projection is outside of the external-argument-introducing Voice.

²This treatment of FP would still follow if F were merged below the external-argument-introducing Voice. However, I do not flesh this argument out in detail, as it would seem to run against a theoretical desideratum that the theta domain not contain any non-theta-related positions.

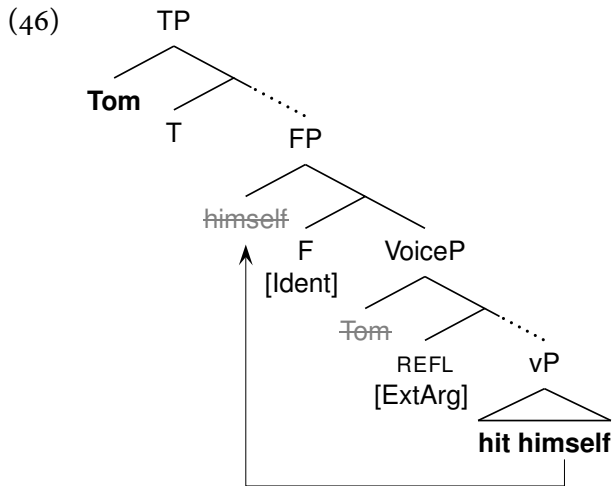

The position to which the reflexive anaphor moves, FP, is outside of the thematic domain (here terminating at VoiceP), as argued throughout this dissertation. Moreover, under this analysis, the stress ‘avoidance’ and REAFR prosody would still arise because the reflexivizing function would be encoded in F^o, which is situated within the lowest Spell-Out Domain. Since F^o is silent, the focus would be realized on its specifier, the reflexive anaphor – as argued specifically in Section 4.4.3 of Chapter 4.

Finally, under this approach, we could still preserve all of the Voice-related facts, since there is a distinct Voice^o for reflexive clauses, which is required whenever the anaphor-attracting F^o is also in the numeration.³ At the same time, this analysis would also maintain that Voice^o is not a conjunction of the external argument introducer and the reflexivizing function – the former is encoded by Voice^o, and the latter is encoded by F^o.

³Recall that reflexive and passive clauses are in complementary distribution, as we saw with REAFR in §4.3.4 and that other languages more clearly demonstrate a connection between grammatical voice and reflexivity in the many of the same ways as English (Chapter 5). See Ahn 2011 for evidence additional from the fact that the constraints on active/passive Voice-mismatch under ellipsis are identical to those which restrict strict interpretation (active/reflexive Voice mismatch).

APPENDIX H

Alternative Approaches to REAFR Prosody

In Chapter 4, it was argued that focus prosody arises on the anaphor because the semantically focused constituent is silent. Specifically, we relied on a rule like (47), which has support from a range of phenomena.

- (47) **Head-Specifier Focus Transference:** Just in case an F-marked syntactic head is silent, the specifier of that head's projection bears focus prosody.

That is, in a configuration like (48), (47) applies and the prosodic focus is borne by *himself*.

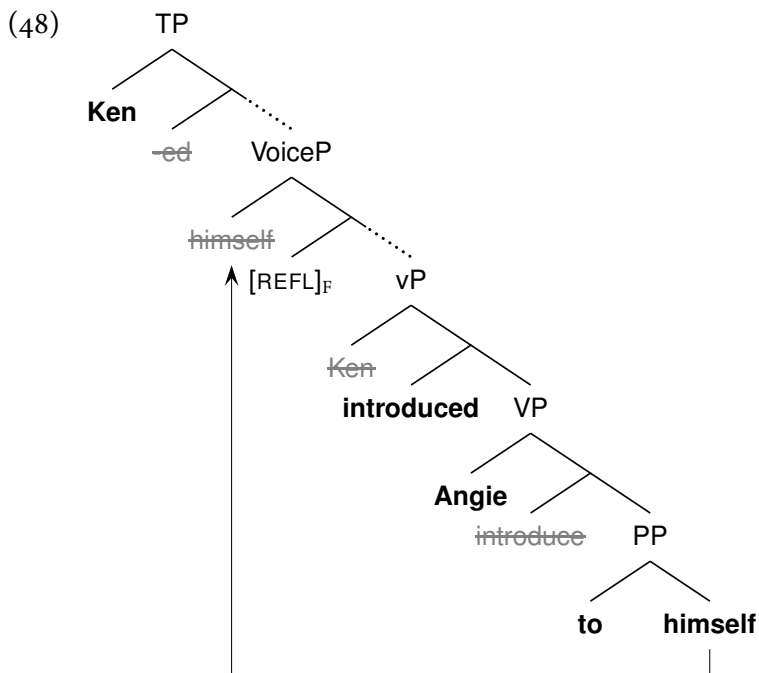

One might call into question the Head-Specifier Focus Transference operation, despite its general support. Below are some alternatives which do not invoke this specific mechanism to yield the focus prosody on the anaphor in REAFR contexts.

A first alternative possibility is that all the given/presupposed information moves to be deaccented (Wagner 2006), as we saw in Section 3.4.2 of Chapter 3. If everything but the anaphor and REFL are given and undergo such movement, this would leave *himself* as most deeply embedded constituent in the domain that gets interpreted as the semantic focus.¹ This is sketched out below:

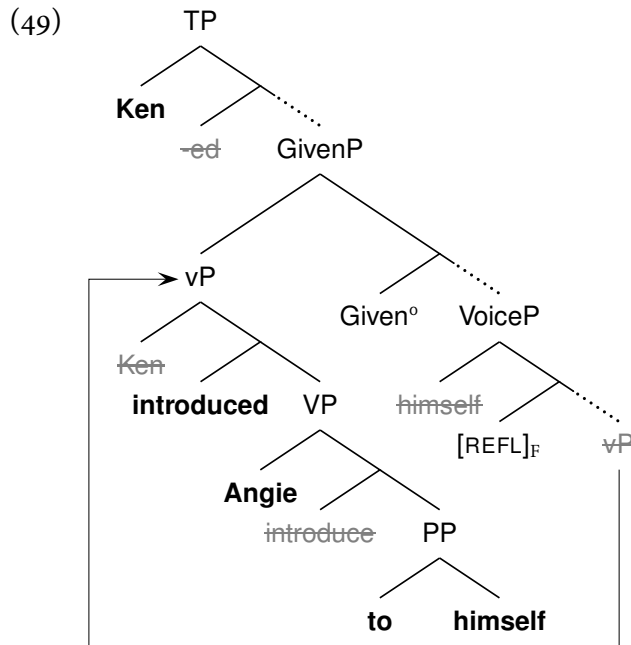

This derivation converges and accords with many of the properties we are interested in with REAFR anaphors. One issue to be investigated is whether this movement of vP to GivenP is constrained in the ways that movement to GivenP is generally constrained. (See §3.4.2 of Ch.3.)

One other alternative could be that semantic foci move to a certain position – call it FocusP. Occurring in this FocusP position is essentially the equivalent of F-marking, and yields both semantic and phonological properties of focus. What “ought” to be under focus is the Voice^o itself, but perhaps movement of a head to the specifier of FocusP is impossible, and instead the anaphor in Spec, VoiceP is pied-piped with it to the focus position.

¹Thanks to Isabelle Charnavel for helpful discussions on this possibility.

(50)

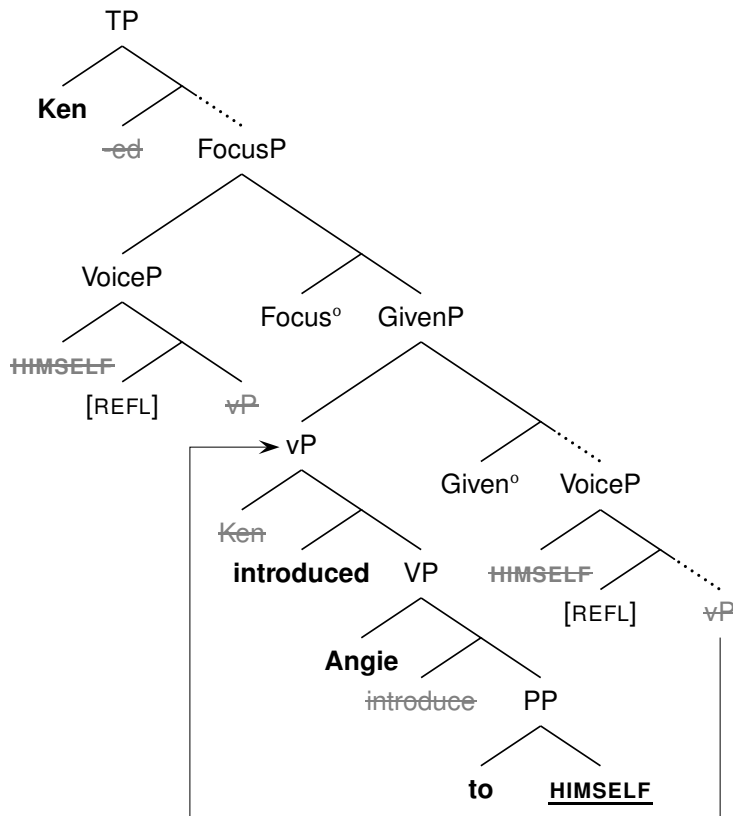

This results in the Reflexive VoiceP being in FocusP, with the anaphor being the only phonological material in VoiceP, causing it to bear the focal stress.

Both of these alternative derivations involve more movements, and each of these operations would need to be carefully argued for, and their properties ought to be more deeply investigated. Arguing between these three analyses requires a deeper understanding of the representational and derivational properties of information structure notions like givenness and focus, and I leave this issue to further research.

APPENDIX I

Examples of Local Subject-Oriented Reflexivity Across Languages

I.1 A Cross-Linguistic Sample

Below are several the morpho-syntactic configurations that many languages employ when the local reflexivity exhibits LSOR properties:¹

- (51) (Albanian, Indo-European; Williams 1988)
Gazetari i a përkroi Agimin vetes
journalist-the 3sgDat 3sgAcc describe.pastdef.act Agim self.DAT
'The journalist₁ described himself_{1/*2} to Agim₂'
- (52) (Czech, Slavic; Toman 1991)
Sultán si nabídl otroka
Sultan REFL.DAT offer slave
'The sultan₁ offered the slave₂ to himself_{1/*2}'
- (53) (Danish, Scandinavian; Vikner 1985)
... at Peter fortalte Michael om sig selv
... that Peter told Michael about REFL intns
'... that Peter₁ told Michael₂ about himself_{1/*2}'

¹It may be that some of these morpho-syntactic reflexive strategies listed here are not quite the same as what we've already seen. We need to be careful, as the morpho-syntactic configuration used for LSOR in a given language may have a broader distribution, beyond just LSOR. That is, due to homophony/paradigm-sharing, it might be that the morpho-syntactic configuration for LSOR (determined by REFL Voice) is surface-identical to some other kind of reflexivity (not determined by REFL Voice).

- (54) (Finnish², Uralic; Ahn 2011)
 Jussi puolusta-utu -i paremmin kuin Pekka
 Jussi.NOM defend -REFL-PAST better than Pekka.NOM
 'John₁ defends himself better than Peter₂ does [~~defend himself~~_{2/*1}].'
- (55) (French, Romance; Sportiche 2010)
 Marie **se** montre Jean
 Marie REFL show.3SG John
 'Marie₁ is showing John₂ to herself₁/*herself₂'
- (56) (Greek, Hellenic; Tsimpli 1989)
 O Yanis **afto**-katastraf-i -ke
 The Yani.NOM self- destroy -NONACT-3sg.past
 'Yani destroyed himself'
- (57) (Inuit, Eskimo–Aleut; Bittner 1994b)
 Juuna-p Kaali **immi**-nik uqaluttuup-p -a -a
 Juuna-ERG Kaali self -INS tell -IND-[+tr]-3SG.3SG
 'Juuna₁ told Kaali₂ about himself_{1/*2}'
- (58) (Japanese, Altaic; Katada 1991)
 Bill-ga Mike-ni **zibun-zisin**-no koto -o hanas-ita
 Bill -NOM Mike -DAT REFL -intns-GEN matter-ACC speak-PST
 'Bill₁ told Mike₂ about himself_{1/*2}'
- (59) (Kannada, Dravidian; Lidz 2001b)
 rashmi tan -age-taane hari-yannu pariçaya -maaDi-**koND** -aLu
 Rashmi SELF-DAT-INTNS Hari-ACC introduction-do -LSOR.pst-3SG.F
 'Rashmi₁ introduced Hari₂ to herself₁/*herself₂'
- (60) (Lakhota, Siouan; Charnavel 2009)³
 iwó- m- igl- ak -e
 talk.about-1sg.II-REFL-talk.about-abl
 'I talk about myself'
- (61) (Lango, Nilo-Saharan; Foley and Van Valin 1984)
 Lócà ò- kwá -o dákó pìr -'ε **kεNε**
 man 3SG.A- ask -3SG.U woman about -3SG self
 'The man₁ asked the woman about himself₁/*herself₂'

²See Ahn (2011) for argumentation that Finnish -UtU is the Voice morpheme.

³Charnavel does not give a grammatical example with two possible binders in a single clause. Instead she says that, in order to express something like 'I talk to Anne about herself', you cannot use the reflexive morpheme, and instead must use a paraphrase like 'I talked to Anne and I talked about her'.

- (62) (Malayalam, Dravidian; Jayaseelan 1999)
 raaman kriṣṇan -ooḍə **tan**-ne patti **tanne** samsaariccu
 Raman Krishnan-to **self**-ACC about **EMPH** talked
 'Raman₁ talked to Krishnan to himself_{1/*2}'
- (63) (Marathi, Indo-Aryan; Wali and Subbarao 1991)
 Lili -ni Susi -laa **swataah** -baddall kaahihi saangitla naahi
 Lili -ERG Susi -to **self** -about anything told not
 'Lili₁ didn't tell Susi₂ anything about self_{1/*2}'
- (64) (Norwegian, Scandinavian; Hellan 1988)
 Jon fortalte meg om **seg selv**
 John told me about **REFL intns**
 'Jon₁ told me₂ about himself_{1/*myself₂}'
- (65) (Russian, Slavic; Timberlake 1979)
 Ja emu skazal vse o **sebe**
 I him told all about **REFL**
 'I₁ told him₂ everything about myself_{1/*himself₂}'
- (66) (Russian Sign Language, Signing; Kimmelman 2009)
 BOY IX-A GIRL IX-B **SELF**+IX-A/*IX-B TELL
 boy girl **REFL** tell
 'The boy tells the girl about himself/*herself'
- (67) (Sign Language of the Netherlands, Signing; Kimmelman 2009)
 BOY IX-A GIRL IX-B ABOUT **ZELF**+IX-A/*IX-B A-TELL-B
 boy girl about **REFL** told
 'The boy tells the girl about himself/*herself'
- (68) (Toro So, Niger-Congo; Culy et al. 1994)
 Mariam Omar nE sO **unO** mO sOaa be
 Mariam Omar to word **REFL** POSS talked PST
 'Mariam₁ talked to Omar₂ about himself_{1/*herself₂}'

I.2 What to Look for to Find LSOR Markers in a Language

This section is provided as a brief guide for gathering the kind of data that would be necessary to determine which morphemes, words, and/or syntactic configurations are used for LSOR clauses in a language. Data of these types are necessary to tease apart various different ways of encoding

in the syntax a notionally reflexive concept.

First, we need to find the baseline for subject-bound anaphors. Try to elicit data like the following:

- (69) The man dislikes himself.
- (70) The thieves defended themselves.

Be aware; there might be multiple ways of expressing these kinds of sentences. The prediction that this dissertation makes is that, if LSOR is marked in some way in the signal, it should be detectable in (one of the ways of expressing) these kinds of examples.

Next, find out what form you get when there is an island; that includes the reflexive but exclude (all silent objects referring to) the subject binder:

- (71) The man dislikes people like himself.
- (72) The thieves defended the murderers and themselves.

Prediction: whatever LSOR marking there is, it should be absent in these cases.

What form of reflexive is used when there are multiple , the lower of which is in a PP, and whose reflexive pronoun is subject bound.

- (73) The psychiatrist told the woman about the boy.
- (74) Which boy did the psychiatrist tell the woman about?

If movement can be applied to “the boy” in (73), as in (74). We’ll check (75) and (76). If not, is there a preposition that can be stranded? Or is there another way of expressing this such that the thematically lowest argument can move? Prediction: whatever LSOR marking there is, it should be here (if movement (74) is possible).

Find out what happens when the reflexive in a PP is bound by a higher object, or by a passive subject.

- (75) The psychiatrist told the woman about herself.
- (76) The woman was told about herself (by the psychiatrist).

Prediction: whatever LSOR marking there is, it should be absent here.

Find out what form you get in a double object construction (if one exists), when the lower argument is subject bound.

(77) The principal showed the teachers the problem.

(78) Which teachers did the principal show the problem?

If movement can be applied to “the teachers” in (77), as in (78). We’ll check (79). If not, does “the teachers” look like a subject of a lower clause that cannot move for independent reasons? Is there another way of expressing this such that the thematically lowest argument can move? Prediction: whatever LSOR marking there is, it should be here (if movement (78) is possible).

Find out what happens when an object reflexive is bound by a higher object, or by a passive subject.

(79) The principal showed the teachers themselves.

(80) The teachers were shown themselves (by the principal).

Prediction: whatever LSOR marking there is, it should be absent here. (If the reflexive marker in (79) looks like the LSOR marker, maybe (77) in this language really involves a biclausal structure, where the higher surface-object is really a subject that can license LSOR.)

BIBLIOGRAPHY

- Abney, Steven. 1987. The English noun phrase in its sentential aspect. Doctoral Dissertation, MIT.
- Adger, David. 1994. Functional heads and interpretation. Doctoral Dissertation, University of Edinburgh.
- Adger, David. 2007. Stress and phasal syntax. *Linguistic Analysis* 33.
- Ahn, Byron. 2010. Not just emphatic reflexives themselves: Their prosody, semantics and syntax. Master's thesis, UCLA.
- Ahn, Byron. 2011. Explorations of voice, identity and the self. Presented at Parallel Domains: A workshop in honor of Jean-Roger Vergnaud.
- Ahn, Byron. 2012a. Emphatic reflexives reflecting syntactic structure. Ms., UCLA.
- Ahn, Byron. 2012b. External argument focus and the syntax of reflexivity. *Coyote Papers: Working Papers in Linguistics, Linguistic Theory at the University of Arizona* 20.
- Ahn, Byron. 2014. The syntax of phrasal stress “exceptions”. Presented at the 2014 Annual LSA Meeting.
- Ahn, Byron. forthcoming. Prosody of yes/no questions in English. UCLA.
- Ahn, Byron. In Preparation. There's nothing exceptional about the phrasal stress rule. Ms., UCLA.
- Ahn, Byron, and Craig Sailor. 2014. The emerging middle class. In *Proceedings from the 46th Annual Meeting of the Chicago Linguistic Society*.
- Alexiadou, Artemis, Elena Anagnostopoulou, and Florian Schäfer. 2006. The properties of anti-causatives crosslinguistically. In *Phases of interpretation*, 187–211. Berlin: Mouton de Gruyter.
- Alexiadou, Artemis, and Edit Doron. 2012. The syntactic construction of two non-active Voices: passive and middle. *Journal of Linguistics* 48:1–34.
- Anagnostopoulou, Elena, and Martin Everaert. 1999. Toward a more complete typology of anaphoric expressions. *Linguistic Inquiry* 30:97–119.
- Bach, Emmon. 1968. Nouns and noun phrases. In *Universals in linguistic theory*, ed. Emmon Bach and Robert Harms, 90–122. Holt, Rinehart and Winston.

- Bach, Emmon, and Barbara H. Partee. 1980. Anaphora and semantic structure. In *Papers from the Parasession on Pronouns and Anaphora*, ed. Jody Kreiman and Almerindo E. Ojeda, 1–28. Chicago Illinois: University of Chicago.
- Baker, Mark. 1988. *Incorporation: A theory of grammatical function changing*. University of Chicago Press.
- Baker, Mark. 2008. The macroparameter in a microparametric world. In *The limits of syntactic variation*, ed. T. Biberauer, 351–374. Amsterdam: John Benjamins.
- Baker, Mark, Kyle Johnson, and Ian Roberts. 1989. Passive arguments raised. *Linguistic Inquiry* 20:219–251.
- Barnes, Jonathan, Nanette Veilleux, Alejna Brugos, and Stefanie Shattuck-Hufnagel. 2010. Turning points, tonal targets, and the english L- phrase accent. *Language and Cognitive Processes* 25:982–1023.
- Barss, Andrew. 1986. Chains and anaphoric dependence: On reconstruction and its implications. Doctoral Dissertation, MIT.
- Beckman, Mary E., and Julia Hirschberg. 1994. The ToBI annotation conventions. *Ohio State University* .
- Beckman, Mary E., Julia Hirschberg, and Stefanie Shattuck-Hufnagel. 2006. The original ToBI system and the evolution of the ToBI framework. In *Prosodic typology: The phonology of intonation and phrasing*, ed. Sun-Ah Jun, 9–54. Oxford: Oxford University Press.
- Beckman, Mary E., and Janet Pierrehumbert. 1986. Intonational structure in Japanese and English. *Phonology Yearbook* 3:255–309.
- Biskup, Petr, Michael Putnam, and Laura Catharine Smith. To Appear. German particle and prefix verbs at the syntax-phonology interface. *Leuvense Bijdragen*.
- Bittner, Maria. 1994a. *Case, scope, and binding*. Dordrecht: Kluwer.
- Bittner, Maria. 1994b. Cross-linguistic semantics. *Linguistics and Philosophy* 17:53–108.
- Bjorkman, Bronwyn. 2011. BE-ing default: The morphosyntax of auxiliary verbs. Doctoral Dis-

- sertation, MIT, Cambridge, MA.
- Bobaljik, Jonathan. 1995. Morphosyntax: The syntax of verbal inflection. Doctoral Dissertation, MIT.
- Bobaljik, Jonathan. 2002. A-chains at the PF-interface: Copies and covert movement. *Natural Language & Linguistic Theory* 20:197–267.
- Boersma, Paul, and David Weenink. 2014. Praat: doing phonetics by computer [computer program]. Available at <http://www.praat.org/>.
- Bolinger, Dwight. 1972. Accent is predictable (if you're a mind-reader). *Language* 48:633–644.
- Borer, Hagit. 1984. *Parametric syntax: Case studies in Semitic and Romance languages*. Dordrecht, Holland: Foris.
- Borer, Hagit. 2005. *The normal course of events*, volume II of *Structuring Sense*. Oxford: Oxford University Press.
- Bowers, John. 2001. Predication. In *The handbook of contemporary semantic theory*, ed. Mark Baltin and Chris Collins, 299–333. Blackwell Publishing.
- Bresnan, Joan. 1971. Sentence stress and syntactic transformations. *Language* 47:257–281.
- Bruening, Benjamin. 2014. Precede-and-command revisited. *Language* 90:342–388.
- Büring, Daniel. 2005. *Binding theory*. Cambridge: Cambridge University Press.
- Büring, Daniel. 2006. Focus projection and default prominence. In *The architecture of focus*, ed. Valéria Molnár and Susanne Winkler. Berlin/New York: Mouton de Gruyter.
- Büring, Daniel. 2013. Syntax and prosody, syntax and meaning. In *The cambridge handbook of generative syntax*, ed. Marcel den Dikken, 860–895. Cambridge: Cambridge University Press.
- Burzio, Luigi. 1986. *Italian syntax: A government-binding approach*. Dordrecht: Reidel.
- Campbell, Richard. 1996. Specificity operators in SpecDP. *Studia Linguistica* 50:161–188.
- Cardinaletti, Anna, and Michal Starke. 1999. The typology of structural deficiency: A case study of the three classes of pronouns. In *Clitics in the languages of Europe*, ed. Henk Van Riemsdijk. Mouton de Gruyter.

- Charnavel, Isabelle. 2008. L'alternance avoir été/être eu dans les auxiliaires du passé surcomposé en français: Un nouvel argument pour le caractère syntaxique du morphème *se*. In *Actes du congrès annuel de l'association canadienne de linguistique 2008/proceedings of the 2008 annual conference of the canadian linguistics association*, ed. Susie Jones.
- Charnavel, Isabelle. 2009. Reflexivization in Lakhota: Lexical or syntactic? Ms., UCLA.
- Charnavel, Isabelle. 2012. On her own - parsimonious compositionality: Probing syntax and semantics with french *propre*. Doctoral Dissertation, UCLA.
- Charnavel, Isabelle, and Dominique Sportiche. 2013. Anaphor binding domains. *lingBuzz/001742*.
- Charnavel, Isabelle, and Dominique Sportiche. 2014. Anaphor binding domains. *ling-Buzz/001742*.
- Charnavel, Isabelle, and Dominique Sportiche. Forthcoming. Anaphor binding: What French inanimate anaphors show. *Linguistic Inquiry*.
- Cheng, Lisa Lai-Shen, and Laura J. Downing. 2012. Against FocusP: arguments from Zulu. In *Contrasts and positions in information structure*, ed. Ivona Kučerová and Ad Neeleman, 247–266. Cambridge University Press. URL <http://dx.doi.org/10.1017/CBO9780511740084.012>.
- Chomsky, Noam. 1981a. *Lectures on government and binding*. Dordrecht: Foris.
- Chomsky, Noam. 1981b. *Lectures on government and binding*. Providence, RI: Foris.
- Chomsky, Noam. 1986a. *Barriers*. Cambridge, MA: MIT Press.
- Chomsky, Noam. 1986b. *Knowledge of language: Its nature, origin and use*. New York, NY: Praeger.
- Chomsky, Noam. 1995. *The minimalist program*. Cambridge, MA: MIT Press.
- Chomsky, Noam. 2000. Minimalist inquiries: The framework. In *Step by step: Essays on minimalist syntax in honor of Howard Lasnik*, ed. Roger Martin, David Michaels, and Juan Uriagereka. Cambridge, MA: MIT Press.
- Chomsky, Noam. 2001. Derivation by phase. In *Ken Hale: A life in language*, ed. Michael Kenstowicz, 1–52. Cambridge, MA: MIT Press.
- Chomsky, Noam. 2007. Approaching UG from below. In *Interfaces + recursion = language?*, ed.

- Uli Sauerland and Hans-Martin Gärtner, 1–29. Berlin: Mouton de Gruyter.
- Chomsky, Noam. 2008. On phases. In *Foundational issues in linguistic theory: Essays in honor of Jean-Roger Vergnaud*, ed. Robert Freidin, Carlos Otero, and María Luisa Zubizarreta, 133–166. Cambridge, MA: MIT Press.
- Chomsky, Noam. 2013. Problems of projection. *Lingua* 130:33 – 49.
- Chomsky, Noam, and Morris Halle. 1968. *The sound pattern of English*. New York, NY: Harper and Row.
- Cinque, Guglielmo. 1993. A null theory of phrase and compound stress. *Linguistic Inquiry* 24:239–297.
- Cinque, Guglielmo. 1999. *Adverbs and functional heads: A cross-linguistic perspective*. New York, NY: Oxford University Press.
- Citko, Barbara. 2014. *Phase theory: An introduction*. New York, NY: Cambridge University Press.
- Cole, Peter, Gabriella Hermon, and C.-T. James Huang, ed. 2001. *Long distance reflexives*, volume 33 of *Syntax and Semantics*. San Diego, CA: Academic Press.
- Collins, Chris. 2005a. A smuggling approach to raising in English. *Linguistic Inquiry* 36:289–298.
- Collins, Chris. 2005b. A smuggling approach to the passive in English. *Syntax* 8:81–120.
- Collins, Chris, and Ed Stabler. 2011. A formalization of minimalist syntax. [lingbuzz/001691](#).
- Collins, Chris, and Ed Stabler. To Appear. A formalization of minimalist syntax.
- Coon, Jessica, Pedro Mateo Pedro, and Omer Preminger. 2011. The role of Case in A-bar extraction asymmetries: Evidence from Mayan. [lingBuzz/001401](#).
- Coon, Jessica, and Omer Preminger. 2012. Towards a unified account of person splits. In *Proceedings of the 29th West Coast Conference on Formal Linguistics*, ed. Jaehoon Choi, E. Alan Hogue, Jeffrey Punske, Deniz Tat, Jessamyn Schertz, and Alex Trueman, 310–318. Somerville, MA: Cascadilla Proceedings Project.
- Crawley, Terry. 1998. *An Erromangan (Sye) grammar*. University of Hawai'i Press.
- Creissels, Denis. To appear. Valency properties of Mandinka verbs. In *Valency classes: A compar-*

- ative handbook*. Mouton de Gruyter.
- Culy, Christopher, Koungarma Kodio, and Patrice Togo. 1994. Dogon pronominal systems: their nature and evolution. *Studies in African linguistics* 23.
- Davies, William D., and Stanley Dubinsky. 2003. On extraction from NPs. *Natural Language & Linguistic Theory* 21:1–37.
- Deal, Amy Rose. 2011. Possessor raising. lingBuzz/001371.
- den Dikken, Marcel. 1995. *Particles: On the syntax of verb-particle, triadic, and causative constructions*. New York, NY: Oxford University Press.
- Donegan, Patricia, and David Stampe. 1983. Rhythm and the holistic organization of language structure. In *The interplay of phonology, morphology, and syntax*, ed. John Richardson, Mitchell Marks, and Amy Chuckerman, 337–353. University of Chicago.
- Eckardt, Regine. 2001. Reanalysing selbst. *Natural Language Semantics* 9:371–412.
- Elfner, Emily. 2014. Syntax-prosody mismatches in Irish and English verb-initial structures. Presented at ETI3, McGill University.
- Embick, David. 1998. Voice systems and the syntax/morphology interface. *MIT Working Papers in Linguistics* 32:41–72.
- Embick, David. 2004. On the structure of resultative participles in English. *Linguistic Inquiry* 35:355–392.
- Embick, David, and Rolf Noyer. 2001. Movement operations after syntax. *Linguistic Inquiry* 32:555–595.
- Fiengo, Robert, and Robert May. 1994. *Indices and identity*. Cambridge, MA: MIT Press.
- Fiscus, Jonathan, John Garofolo, Mark Przybocki, William Fisher, and David Pallett. 1998. The 1997 English broadcast news speech (HUB4). Web Download. Philadelphia: Linguistic Data Consortium.
- Fitzpatrick, Justin M. 2006. Deletion through movement. *Natural Language & Linguistic Theory* 24:399–431.

- Foley, William A., and Robert Van Valin. 1984. *Functional syntax and universal grammar*. Cambridge, UK: Cambridge University Press.
- Fowlie, Meaghan. 2011. Multidominant minimalist grammars. Master's thesis, UCLA.
- Fox, Daniel, and David Pesetsky. 2005. Cyclic linearization of syntactic structure. *Theoretical Linguistics* 31.
- Fox, Danny. 1993. Chain and binding – a modification of Reinhart and Reuland's 'Reflexivity'. MIT.
- Fox, Danny. 2000. *Economy and semantic interpretation*. Cambridge, MA: MIT Press.
- Fox, Danny. 2002. Antecedent-contained deletion and the copy theory of movement. *Linguistic Inquiry* 33:63–96.
- Fox, Danny, and Howard Lasnik. 2003. Successive cyclic movement and island repair: The difference between sluicing and VP ellipsis. *Linguistic Inquiry* 34:143–154.
- Fox, Danny, and Jon Nissenbaum. 1999. Extraposition and scope: A case for overt QR. In *Proceedings of the 18th West Coast Conference on Formal Linguistics*, ed. Sonya Bird, Andrew Carnie, Jason D. Haugen, and Peter Norquest, 132–144.
- Féry, Caroline, and Vieri Samek-Lodovici. 2006. Focus projection and prosodic prominence in nested foci. *Language* 82:131–150.
- Gast, Volker. 2006. *The grammar of identity*. New York, NY: Routledge.
- Gehrke, Berit, and Nino Grillo. 2009. How to become passive. In *Explorations of phase theory: Features, arguments, and interpretation at the interfaces*, ed. Kleanthes Grohmann. Mouton de Gruyter.
- Geniušienė, Emma. 1987. *The typology of reflexives*. New York: Mouton de Gruyter.
- Groat, Erich, and John O'Neil. 1996. Spellout at the LF interface. In *Minimal ideas: Syntactic studies in the minimalist framework*, ed. Werner Abraham, Samuel Epstein, Höskuldur Thráinsson, and C. Jan-Wouter Zwart, 113–139. Amsterdam: John Benjamins.
- Grodzinsky, Yosef, and Tanya Reinhart. 1993. The innateness of binding and coreference. *Linguis-*

- tic Inquiry* 24:69–101.
- Gussenhoven, Carlos. 1983. Testing the reality of focus domains. *Language and Speech* 26:61–80.
- Hale, Kenneth, and Samuel Jay Keyser. 1993. On argument structure and the lexical expression of syntactic relations. In *The view from building 20*, ed. Kenneth Hale and Samuel Jay Keyser, 53–110. Cambridge, MA: MIT Press.
- Halle, Morris. 2001. Infixation versus onset metathesis in Tagalog, Chamorro, and Toba Batak. In *Ken hale: A life in language*, ed. Michael Kenstowicz, chapter 4, 153–168. Cambridge, MA: MIT Press.
- Halle, Morris, and Alec Marantz. 1993. Distributed morphology and the pieces of inflection. In *The view from building 20*, ed. Kenneth Hale and Samuel Jay Keyser, 111–176. Cambridge, MA: MIT Press.
- Halliday, M.A.K. 1967. Notes on transitivity and theme in English: Part 2. *Journal of Linguistics* 3:199–244.
- Halpert, Claire. 2011. Low subjects in Zulu and the prosody-syntax interface. Presented at ACAL 42, June 2011.
- Harizanov, Boris. 2014. The role of prosody in the linearization of clitics: Evidence from Bulgarian and Macedonian. In *Formal approaches to slavic linguistics 22: The mcmaster meeting 2013*, ed. Cassandra Chapman, Olena Kit, and Ivona Kučerová, 109–130. Ann Arbor, MI: Michigan Slavic Publications.
- Harley, Heidi. 2002. Possession and the double object construction. *Linguistic Variation Yearbook* 2:31–70.
- Harley, Heidi. 2013. External arguments and the Mirror Principle: On the distinctness of Voice and v. *Lingua* 125:34–57.
- Harwood, Will. 2013. An existential crisis: understanding the aspectual restrictions on English existential constructions. lingBuzz/001829.
- Hayes, Bruce. 1995. *Metrical stress theory: Principles and case studies*. University of Chicago Press.

- Heim, Irene, and Angelika Kratzer. 1998. *Semantics in generative grammar*. Malden, MA: Blackwell Publishing.
- Hellan, Lars. 1988. *Anaphora in Norwegian and the theory of grammar*. Dordrecht: Foris.
- Hestvik, Arild. 1995. Reflexives and ellipsis. *Natural Language Semantics* 3:211–237.
- Hirotsani, Masako. 2004. Prosody and LF: Processing Japanese wh-questions. Doctoral Dissertation, University of Massachusetts, Amherst.
- Hole, Daniel. 2002. Agentive selbst in German. In *Sinn und Bedeutung VI, Proceedings of the Sixth Annual Meeting of the Gesellschaft für Semantik*, ed. Graham Katz, Sabine Reinhard, and Philip Reuter. Osnabrück: University of Osnabrück.
- Hole, Daniel. 2008. Focus on identity – the dark side of ziji. *The Linguistic Review* 25:267–295.
- Hornstein, Norbert. 2001. *Move! a minimalist theory of construal*. Malden, MA: Blackwell Publishing.
- Hornstein, Norbert. 2010. Outlines of a minimalist syntax. Lectures Presented at Syntax Fest 2010.
- Huang, C.-T. James. 1993. Reconstruction and the structure of VP: some theoretical consequences. *Linguistic Inquiry* 24:103–138.
- Huang, C.-T. James, and C.-S. Luther Liu. 2001. Logophoricity, attitudes, and ziji at the interface. *Syntax and Semantics* 33:141–195.
- Jackendoff, Ray. 1972. *Semantic interpretation in generative grammar*. Cambridge, MA: MIT Press.
- Jayaseelan, K.A. 1999. *Parametric studies in Malayalam syntax*. New Delhi: Allied Publishers Ltd.
- Kahnemuyipour, Arsalan. 2009. *The syntax of sentential stress*. Oxford: Oxford University Press.
- Katada, Fusa. 1991. The LF representation of anaphors. *Linguistic Inquiry* 22:287–313.
- Kayne, Richard. 1975. *French syntax: The transformational cycle*. Cambridge, MA: MIT Press.
- Kayne, Richard. 1985. Principles of particle constructions. In *Grammatical representation*, ed. Jacqueline Guéron, Hans-Georg Obenauer, and Jean-Yves Pollock. Dordrecht: Foris.
- Kayne, Richard. 1998. Overt vs. covert movement. *Syntax* 1:128–191.

- Kayne, Richard. 2002. Pronouns and their antecedents. In *Derivation and explanation in the minimalist program*, ed. Samuel Epstein and Daniel Seely, 133–166. Malden, MA: Blackwell Publishers.
- Kayne, Richard. 2005. *Movement and silence*. Oxford: Oxford University Press.
- Keenan, Edward L. 1988. On semantics and the binding theory. In *Explaining Language Universals*, ed. John Hawkins, 105–144. Oxford: Blackwell Publishing.
- Kehler, Andrew. 2002. *Coherence, reference, and the theory of grammar*. Center for the Study of Language and Information.
- Kemmer, Suzanne. 1994. Middle voice, transitivity, and the elaboration of events. In *Voice: Form and function*, ed. Barbara Fox and Paul Hopper, volume 27 of *Typological Studies in Language*, 179–230. John Benjamins Publishing Company.
- Kimmelman, Vadim. 2009. Reflexive pronouns in Russian Sign Language and Sign Language of the Netherlands. Master's thesis, University of Amsterdam.
- Klein, Wolfgang. 1998. Assertion and finiteness. In *Issues in the theory of language acquisition. essays in honor of Jürgen Weissenborn*, ed. Norbert Dittmar and Zvi Penner, 222–245. Bern: Lang.
- Koopman, Hilda. 2003. The locality of agreement and the structure of the DP in Maasai. In *The role of agreement in natural language: TLS 5 proceedings*, 206–227. Texas Linguistic Society.
- Koopman, Hilda. 2005. On the parallelism of DPs and clauses: Evidence from Kisongo Maasai. In *Verb first: On the syntax of verb initial languages*, ed. Andrew Carnie, Heidi Harley, and Sheila Ann Dooley, 281–301. John Benjamins.
- Koopman, Hilda, and Dominique Sportiche. 1991. The position of subjects. *Lingua* 85:211–258.
- Koster, Jan, and Eric Reuland, ed. 1991. *Long-distance anaphora*. Cambridge: Cambridge University Press.
- Kratzer, Angelika. 1996. Severing the external argument from its verb. In *Phrase structure and the lexicon*, 109–137. Dordrecht: Kluwer.
- Kratzer, Angelika, and Elisabeth Selkirk. 2007. Phase theory and prosodic spellout: The case of

- verbs. *The Linguistic Review* 24:93–105.
- Krifka, Manfred. 2004. The semantics of questions and the focusation of answers. In *Topic and focus: A cross-linguistic perspective*, ed. Chungmin Lee and Matthew Gordon, 139–151. Kluwer Academic Publishers.
- Ladd, Robert. 1996. *Intonational phonology*. Cambridge: Cambridge University Press.
- Laka, Itziar. 1990. Negation in syntax: On the nature of functional categories and projections. Doctoral Dissertation, MIT.
- Landau, Idan. 1999. Possessor raising and the structure of VP. *Lingua* 107:1–37.
- Larson, Richard. 1988. On the double object construction. *Linguistic Inquiry* 19:335–391.
- Lasnik, Howard, and Nicholas Sobin. 2000. The who/whom puzzle: On the preservation of an archaic feature. *Natural Language & Linguistic Theory* 18:343–371.
- Lebeaux, David. 1983. A distributional difference between reciprocals and reflexives. *Linguistic Inquiry* 14:723–730.
- Lee-Schoenfeld, Vera. 2006. German possessor datives: raised and affected. *Journal of Comparative Germanic Linguistics* 9:101–142.
- Lee-Schoenfeld, Vera. 2008. Binding, phases, and locality. *Syntax* 11:281–298.
- Lees, Robert, and Edward Klima. 1963. Rules for English pronominalization. *Language* 39:17–28.
- Legate, Julie Anne. 2003. Some interface properties of the phase. *Linguistic Inquiry* 34:506–515.
- Levin, Beth. 1993. *English verb classes and alternations: A preliminary investigation*. The University of Chicago Press.
- Liberman, Mark, and Alan Prince. 1977. On stress and linguistic rhythm. *Linguistic Inquiry* 8:249–336.
- Lidz, Jeffrey. 1996. Dimensions of reflexivity. Doctoral Dissertation, University of Delaware.
- Lidz, Jeffrey. 2001a. Anti-antilocality. In *Long distance reflexives*, ed. Peter Cole, Gabriella Hermon, and C.-T. James Huang, volume 33 of *Syntax and Semantics*. Academic Press.
- Lidz, Jeffrey. 2001b. The argument structure of verbal reflexives. *Natural Language & Linguistic*

Theory 19:311–353.

- Lohndal, Terje. 2011. The addicities of thematic separation. In *Proceedings of SALT XXI*, ed. Neil Ashton, Anca Chereches, and David Lutz, 1–18.
- Loss, Sara. 2011. Iron range english long-distance reflexives. Doctoral Dissertation, University of Minnesota at Twin Cities.
- MacWhinney, Brian. 2007. The TalkBank project. In *Creating and digitizing language corpora: Synchronic databases*, ed. Joan C. Beal, Karen P. Corrigan, and Hermann L. Moisl, volume 1. Houndmills: Palgrave-Macmillan.
- Marantz, Alec. 1984. *On the nature of grammatical relations*. Cambridge, MA: MIT Press.
- Marantz, Alec. 1989. Projection vs. percolation in the syntax of synthetic compounds. In *Selected papers from the annual spring colloquium*, 95–112. Chapel Hill, NC: University of North Carolina, UNC Linguistics Circle.
- McCarthy, John, and Alan Prince. 1993. Prosodic morphology i: constraint interaction and satisfaction. Ms., University of Massachusetts Amherst, and Rutgers University.
- McCloskey, James. 2014. Prosody, focus, and ellipsis in Irish. Presented at ETI3, McGill University.
- McPherson, Laura. 2014. Replacive grammatical tone in the dogon languages. Doctoral Dissertation, UCLA.
- Merchant, Jason. 2001. *The syntax of silence: Sluicing, islands, and the theory of ellipsis*. Oxford: Oxford University Press.
- Merchant, Jason. 2007. Voice and ellipsis. Ms., University of Chicago.
- Merchant, Jason. 2008. Variable island repair under ellipsis. In *Topics in ellipsis*, ed. Kyle Johnson, 132–153. Cambridge: Cambridge University Press.
- Merchant, Jason. 2013. Voice and ellipsis. *Linguistic Inquiry* 44:77–108.
- Moulton, Keir. 2005. Strong reflexivity and attitudes *de se*. Ms., UMass Amherst.
- Nespor, Marina, and Irene Vogel. 1986. *Prosodic phonology*. Dordrecht, Holland ; Riverton, N.J.: Foris.

- Nunes, Jairo. 1995. The copy theory of movement and linearization of chains in the Minimalist Program. Doctoral Dissertation, University of Maryland.
- Orfitelli, Robyn. 2012. Argument intervention in the acquisition of A-movement. Doctoral Dissertation, UCLA, Los Angeles, CA.
- Parsons, Terence. 1990. *Events in the semantics of English: A study in subatomic semantics*. Cambridge, MA: MIT Press.
- Pearson, Matthew. 2005. The Malagasy subject/topic as an A'-element. *Natural Language & Linguistic Theory* 23:381–457.
- Pesetsky, David. 1995. *Zero syntax*. Cambridge, MA: MIT Press.
- Pesetsky, David. 1998. Some optimality principles of sentence pronunciation. In *Is the best good enough? optimality and competition in syntax*, ed. Pilar Barbosa, Danny Fox, Paul Hagstrom, Martha McGinnis, and David Pesetsky, 337–383. Cambridge, MA: MIT Press.
- Peterson, John. 2011. *A grammar of Kharia: A South Munda language*. Leiden; Boston: Brill.
- Pica, Pierre. 1987. On the nature of the reflexivization cycle. In *Proceedings of North East Linguistic Society*, volume 17, 483–500.
- Pierrehumbert, Janet. 1980. The phonology and phonetics of English intonation. Doctoral Dissertation, MIT.
- Pierrehumbert, Janet, and Mary E. Beckman. 1988. *Japanese tone structure*, volume 15 of *Linguistic Inquiry Monograph*. MIT Press.
- Pierrehumbert, Janet, and Julia Hirschberg. 1990. The meaning of intonational contours in the interpretation of discourse. In *Intentions in communication*, ed. Philip R. Cohen, Jerry L. Morgan, and Martha E. Pollack, 271–311. Cambridge, MA: MIT Press.
- Polinsky, Maria, and Bernard Comrie. 2003. Constraints on reflexivization in Tsez. In *Current trends in Caucasian, East European and Inner Asian linguistics: Papers in honor of Howard I. Aronson*, ed. Dee Ann Holisky and Kevin Tuite, 265–289. Amsterdam: John Benjamins.
- Pollard, Carl, and Ivan Sag. 1992. Anaphors in English and the scope of binding theory. *Linguistic*

- Inquiry* 23:261–303.
- Pollard, Carl, and Ping Xue. 1998. Chinese reflexive ziji: Syntactic reflexives vs. nonsyntactic reflexives. *Journal of East Asian Linguistics* 7:287–318.
- Pollock, Jean-Yves. 1989. Verb-movement, Universal Grammar, and the structure of IP. *Linguistic Inquiry* 20:365–424.
- Preminger, Omer. 2011. Agreement as a fallible operation. Doctoral Dissertation, MIT.
- Prince, Alan, and Paul Smolensky. 1993. Optimality theory: Constraint interaction in generative grammar. Rutgers University and University of Colorado, Boulder.
- Pylkkänen, Liina. 2008. *Introducing arguments*. Cambridge, MA: MIT Press.
- Rackowski, Andrea, and Norvin Richards. 2005. Phase edge and extraction: A Tagalog case study. *Linguistic Inquiry* 36:565–599.
- Reinhart, Tanya, and Eric Reuland. 1993. Reflexivity. *Linguistic Inquiry* 24:657–720.
- Reuland, Eric. 2011. *Anaphora and language design*. Cambridge, MA: MIT Press.
- Rizzi, Luigi. 1986a. Null objects in Italian and the theory of *pro*. *Linguistic Inquiry* 17:501–557.
- Rizzi, Luigi. 1986b. On chain formation. In *The grammar of pronominal clitics*, ed. Hagit Borer. Academic Press.
- Rizzi, Luigi. 1990a. On the anaphor-agreement effect. *Rivista di Linguistica* 2:27–42.
- Rizzi, Luigi. 1990b. *Relativized minimality*. Cambridge, MA: MIT Press.
- Rizzi, Luigi. 2006. Grammatically-based target-inconsistencies in child language. In *The proceedings of the inaugural conference on generative approaches to language acquisition - north america (galana)*, ed. Kamil ud Deen, Jun Nomura, Barbara Schulz, and Bonnie D. Schwartz, UCONN / MIT Working Papers in Linguistics, 19–49. Cambridge, MA: MIT Press.
- Rooryck, Johan, and Guido Vanden Wyngaerd. 2011. *Dissolving binding theory*. Oxford: Oxford University Press.
- Rooth, Mats. 1985. Association with focus. Doctoral Dissertation, University of Massachusetts, Amherst.

- Rooth, Mats. 1992. A theory of focus interpretation. *Natural Language Semantics* 1:75–116.
- Ross, John R. 1967. Constraints on variables in syntax. Doctoral Dissertation, MIT.
- Safir, Kenneth. 2004. *The syntax of anaphora*. Oxford: Oxford University Press.
- Sailor, Craig. 2011. Remarks on retorts: On emphatic polarity in English. Presented at NELS 42, University of Toronto.
- Sailor, Craig. 2012. The size of silence: Diagnosing the fine structure of VP ellipsis. Presented at University of Illinois at Chicago Talks in Linguistics.
- Sailor, Craig. 2014. The variables of VP ellipsis. Doctoral Dissertation, UCLA.
- Sailor, Craig, and Byron Ahn. 2010. The Voices in our heads: The VoiceP in English. Presented at Morphological Voice and its Grammatical Interfaces, University of Vienna.
- Schlenker, Philippe. 2005. Non-redundancy: Towards a semantic reinterpretation of binding theory. *Natural Language Semantics* 13:1–92.
- Schlenker, Philippe. 2012. *Maximize Presupposition* and Gricean reasoning. *Natural Language Semantics* 20:391–429.
- Schmerling, Susan F. 1976. *Aspects of English sentence stress*. University of Texas Press.
- Schwarzschild, Roger. 1999. Givenness, AvoidF and other constraints on the placement of accent. *Natural Language Semantics* 7:141–177.
- Schäfer, Florian. 2011. On passives of reflexive verbs and the nature of (natural) reflexivity. In *NELS 41: Proceedings of the 41st annual meeting of the North East Linguistics Society*, ed. Lena Fainleib, Nicholas LaCara, and Yangsook Park.
- Selkirk, Elisabeth. 1984. *Phonology and syntax: the relationship between sound and structure*. Cambridge, MA: MIT Press.
- Selkirk, Elisabeth. 1996a. The prosodic structure of function words. In *Signal to syntax: Bootstrapping from speech to grammar in early acquisition*, ed. James Morgan and Katherine Demuth, 187–213. Mahwah, NJ: Lawrence Erlbaum Associates.
- Selkirk, Elisabeth. 1996b. Sentence prosody: Intonation, stress, and phrasing. In *The handbook of*

- phonological theory*, ed. John A. Goldsmith, 550–569.
- Selkirk, Elisabeth. 2007. Contrastive focus, givenness and the unmarked status of “discourse-new”. In *The notions of information structure*, ed. Caroline Féry, Gisbert Fanselow, and Manfred Krifka, volume 6 of *Interdisciplinary Studies on Information Structure*, 125–145. Universitätsverlag Potsdam.
- Selkirk, Elisabeth. 2011. The syntax-phonology interface. In *The handbook of phonological theory*, ed. John A. Goldsmith, Jason Riggle, and Alan Yu. Blackwell Publishing, 2nd edition edition.
- Siemund, Peter. 2000. *Intensifiers in English and German: A comparison*. New York, NY. Routledge.
- Smith, Jennifer. 2011. Category-specific effects. In *The blackwell companion to phonology*, ed. Marc van Oostendorp, Colin Ewen, Beth Hume, and Keren Rice, 2439–2463. Malden, MA: Wiley-Blackwell.
- Spathas, Giorgios. 2010. Focus on anaphora. Doctoral Dissertation, University of Utrecht.
- Spathas, Giorgios. 2012. Reflexivizers and intensifiers: consequences for a theory of focus. In *Proceedings of sinn und bedeutung*, ed. Emmanuel Chemla, Vincent Homer, , and Grégoire Winterstein, volume 17, 581–598.
- Sportiche, Dominique. 1990. Movement, agreement and case. Published in Sportiche (1998), *Partitions and Atoms of Clause Structure*.
- Sportiche, Dominique. 1996. Clitic constructions. In *Phrase structure and the lexicon*, ed. Johan Rooryck and Laurie Zaring, 213–276. Kluwer Academic Publishers.
- Sportiche, Dominique. 2005. Division of labor between merge and move: Strict locality of selection and apparent reconstruction paradoxes. [lingBuzz/000163](#).
- Sportiche, Dominique. 2010. French reflexive se: Binding and Merge locality. [lingBuzz/001273](#).
- Sportiche, Dominique. 2011a. French relative Qui. *Linguistic Inquiry* 42:83–124.
- Sportiche, Dominique. 2011b. The van Riemsdijk-Williams puzzle: in de Fourier’s footsteps. Presented at Parallel Domains: A workshop in honor of Jean-Roger Vergnaud. [lingBuzz/001272](#).

- Sportiche, Dominique. 2012. Binding domains. Presented at Berkeley Linguistics Society 38th Annual Meeting.
- Sportiche, Dominique. 2014. Assessing unaccusativity and reflexivity: Using focus alternatives to decide what gets which θ -role. *Linguistic Inquiry* 45:305–321.
- Starke, Michal. 2001. Move dissolves into merge: A theory of locality. Doctoral Dissertation, University of Geneva.
- Stevens, Jon Scott. To Appear. Against a unified analysis of Givenness and Focus. *Proceedings of WCCFL* 31.
- Stokhof, Martin. 2006. The development of Montague grammar. In *History of the language sciences*, ed. Sylvain Auroux, E.F.K. Koerner, Hans-Josef Niederehe, and Kees Versteegh, 2058–2073. Berlin/New York: Walter de Gruyter.
- Storoshenko, Dennis. 2009. Investigating the Shona reflexive *zvi*. In *Selected proceedings of the 39th annual conference on African linguistics*, ed. Akinloye Ojo and Lioba Moshi. Cascadilla Proceedings Project.
- Subbārāo, Kārumūri V. 2012. *South Asian languages: A syntactic typology*. New York, NY: Cambridge University Press.
- Szabolcsi, Anna. 1987. Bound variables in syntax (are there any?). In *Proceedings of the 6th amsterdam colloquium*, ed. Jeroen Groenendijk and Martin Stokhof, 331–353. Amsterdam: University of Amsterdam.
- Szendrői, Kriszta. 2003. A stress-based approach to the syntax of Hungarian focus. *The Linguistic Review* 20:37–78.
- Tanaka, Hidekazu. 2011. Voice mismatch and syntactic identity. *Linguistic Inquiry* 42:470–490.
- Timberlake, Alan. 1979. Reflexivization and the cycle in Russian. *Linguistic Inquiry* 10:109–141.
- Toman, Jindřich. 1991. Anaphors in binary trees: an analysis of Czech reflexives. In *Long-distance anaphora*, ed. Jan Koster and Eric Reuland. Cambridge: Cambridge University Press.
- Tsimpli, Ianthi-Maria. 1989. On the properties of the passive affix in Modern Greek. *USL-Working*

Papers 235–260.

- Tucker, Matthew A. 2010. Even more on the anaphor agreement effect. Ms., University of California, Santa Cruz.
- Uriagereka, Juan. 1999. Multiple spell-out. In *Working minimalism*, ed. Samuel Epstein and Norbert Hornstein, 251–282. Cambridge, MA: MIT Press.
- Vikner, Sten. 1985. Parameters of binder and of binding category in Danish. *Working Papers in Scandinavian Syntax* 23.
- Wagner, Michael. 2006. Givenness and locality. In *Proceedings of SALT XVI*, ed. Masayuki Gibson and Jonathan Howell, 295–312. CLC Publications.
- Wali, Kashi, and K.V. Subbarao. 1991. On pronominal classification: Evidence from Marathi and Telugu. *Linguistics* 29:1093–1110.
- Watson, Duane, Michael Tanenhaus, and Christine Gunlogson. 2008. Interpreting pitch accents in online comprehension: H* vs. L+H*. *Cognitive Science* 32:1232–1244.
- Williams, Edwin. 2003. *Representation theory*. Cambridge, MA: MIT Press.
- Williams, Kemp. 1988. Exceptional behavior of anaphors in Albanian. *Linguistic Inquiry* 19:161–168.
- Woolford, Ellen. 1999. More on the anaphor agreement effect. *Linguistic Inquiry* 30:257–287.
- Zlatic, Larisa. 1997. The structure of the Serbian noun phrase. Doctoral Dissertation, The University of Texas at Austin.
- Zubizarreta, María Luisa. 1998. *Prosody, focus, and word order*. Cambridge, MA: The MIT Press.
- Zubizarreta, María Luisa. 2010. The syntax and prosody of focus: the Bantu-Italian connection. *Iberia* 2.
- Zubizarreta, María Luisa, and Jean-Roger Vergnaud. 2006. Phrasal stress and syntax. In *The Blackwell Companion to Syntax*, ed. Martin Everaert and Henk van Riemsdijk, volume 3, chapter 49. Blackwell Publishing.