

UC Berkeley

Research Reports

Title

Field Demonstration and Tests of Lane Assist/Guidance and Precision Docking Technology

Permalink

<https://escholarship.org/uc/item/8g37d23s>

Authors

Tan, Han-Shue
Bu, Fanping
Johnston, Scott
et al.

Publication Date

2009

CALIFORNIA PATH PROGRAM
INSTITUTE OF TRANSPORTATION STUDIES
UNIVERSITY OF CALIFORNIA, BERKELEY

Field Demonstration and Tests of Lane Assist/Guidance and Precision Docking Technology

**Han-Shue Tan, Fanping Bu, Scott Johnston,
Benedicte Bougler, Wei-Bin Zhang, Sonja Sun**

**California PATH Research Report
UCB-ITS-PRR-2009-12**

This work was performed as part of the California PATH Program of the University of California, in cooperation with the State of California Business, Transportation, and Housing Agency, Department of Transportation, and the United States Department of Transportation, Federal Highway Administration.

The contents of this report reflect the views of the authors who are responsible for the facts and the accuracy of the data presented herein. The contents do not necessarily reflect the official views or policies of the State of California. This report does not constitute a standard, specification, or regulation.

Final Report for 6606

January 2009

ISSN 1055-1425

Field Demonstration and Tests of Lane- Assist/Guidance and Precision Docking Technology

Final Report for Task Order 6606

Prepared by:

California PATH

University of California, Berkeley

And

California Department of Transportation

In collaboration with

AC Transit

October 2008

Acknowledgements

This work was performed by the California PATH Program at the University of California at Berkeley in cooperation with the State of California Business, Transportation and Housing Agency, Department of Transportation (Caltrans). The contents of this report reflect the views of the authors, who are responsible for the facts and the accuracy of the data presented herein. The contents do not necessarily reflect the official views or policies of the State of California.

The authors thank Don Dean, and Larry Orcutt of Caltrans' Division of Research and Innovation, Paul Chiu and Sean Nozorri of Caltrans District 4, Jim Cunradi of AC Transit District for their support and advice during the project and Susan Dicky and Steve Shladover of PATH for their technical contributions.

Author List

University of California, Berkeley

Han-Shue Tan

Fanping Bu

Scott Johnston

Benedicte Bougler

Wei-Bin Zhang

Division of Research and Innovation, Caltrans

Sonja Sun

Abstract

This document reports the improvement and implementation of the magnetic lane-guidance and precision docking system on a 60ft articulated bus and the extensive testing on a 0.9 mile test track installed with magnets along southbound East 14th Street, San Leandro, California between 139th and 150th Avenue on a real-world operation setting. The extensive testing in the real-world setting provided valuable opportunities to discover and thus resolved a number of issues that might have prevented the system from achieving high repeatability and reliability in the future deployment on a large, public scale.

Keywords: Vehicle Assist and Automation, Transit Lane-Assist System, Lateral guidance, Advanced Vehicle Control

Executive Summary

PURPOSE:

Bus Rapid Transit (BRT) systems can provide high quality, high capacity bus transit service on easily identifiable route structures at a lower development and implementation cost with higher modification flexibility than urban light rail systems. BRT services can be greatly improved with the addition of the ITS technology of electronic guidance, which would provide lane-assistance and precision docking functions, allowing the bus to operate in a designated lane that is only slightly wider than the bus itself and to precisely dock the bus at bus stops within an accuracy measured in centimeters. Buses equipped with lane-assist technologies can be operated at higher speeds on narrow lanes, facilitating greater rider satisfaction as well as cost effectiveness. Precision docking capability at bus stops allows fast loading and unloading of passengers with special needs, thereby reducing waiting time and improving ease of access for all passengers.

Field demonstration and tests of lane-assist/guidance and precision docking technology are important milestone in the progress of the vehicle guidance technology that Caltrans has been supporting for many years, from research through development and testing for operational deployment. Success in this test/demonstration will help contribute toward commercialization of lane-assist and precision docking technologies by showing the viability of the technology in a real-world setting. Not only will it prove the utility of the technologies in transit systems, the demonstration will also provide opportunities for improving better and safer guidance technologies by finding and fixing real-world problems.

PROJECT DIRECTION:

This project was conducted based on the following research and development directions:

- Reviewed and improved existing lane-guidance and precision docking system for real-world operation including vehicle position sensing, steering actuator, controllers, human machine interface, fault detection and management.
- Executed test plan that focused on developing docking control function for the 60ft articulated bus, as well as conducting demonstrations and extensive testing in a real-world operation setting.
- Selected and prepared a test track that is part of the planned route for AC Transit's BRT service, and is an urban corridor with geometric and traffic conditions representative of other BRT applications, for transferability of the results and lessons learned.

- Established “Safety First” testing guidelines where all software modifications and parameter tuning need to be thoroughly tested at the Richmond Field Station (RFS) test track first and no software debugging would be carried out at East 14th Street.
- Discovered and resolved real-world guidance related problems that are unique to the busway (electronic guidance) compared to those in a railroad environment.
- Conducted demonstrations for government agencies, public transit agencies, local city planner, as well as mass media under a real-world operation setting with live traffic using a 60 ft articulated bus to showcase the maturity of the technology and to build interest and support among general public for its future deployment.

CONCLUSIONS:

The project has successfully improved the existing magnetic lane-guidance and precision docking system on a 60ft articulated bus and conducted extensive testing on a 0.9 mile test track installed with magnets along southbound East14th Street, San Leandro, California between 139th and 150th Ave on a real-world operation setting. This is a regular AC Transit bus route and is also part of a planned AC Transit BRT route. Three regular bus stations had magnets installed for curb-side precision docking. The extensive testing in the real-world setting provided valuable opportunities to discover and thus resolved a number of issues that might have prevented the system from achieving high repeatability and reliability in the future deployment on a large, public scale.

192 test runs on 17 days with automated steering were safely conducted along the East 14th Street test track between February to September in 2008 without a single control system failure. After the automated system was finalized on July 23, 2008, 95 runs were conducted on five different days, each with 12 to 24 runs, under the normal bus operational environment including transit ride-along and demonstrations. Among these field test runs, 35 runs had complete data saved for analysis. Data analysis of these 35 data sets showed that the tracking error standard deviation (STD) when the bus was under automated control was 10.52 cm. The STD of the tracking error became 7.2 cm when we exclude all tracking data under S-curves. The standard deviation of the tracking error when the bus was at the final approach along the curb to the docking station after was 1.10 cm. The STD of the tracking error at the bus stop was 0.67cm. The mean of the final vehicle angle at the bus stop was 0.14 degrees, with the associated STD of 0.13 degrees – the bus was virtually parallel to the curb line every time.

Demonstrations were conducted on both September 5, 2008 and September 23, 2008. During the first day of demonstration, several demonstration runs along East14th Street were provided to the media reporters from different television stations and print journalists first. A press release was issued by University of California at Berkeley. Demonstration participants from government agencies, public transit agencies and local

city management were divided into several groups to experience riding-along on the bus. Following the demonstration, a workshop was held with extensive discussions and exchanging of ideas among all participants. Many were very enthusiastic about the potential applications and hoped to include the Vehicle Assist and Automation (VAA) technology in their future BRT route planning and construction. They generally agreed upon the benefits that VAA technology could provide and were surprised by the superior performance shown by the 60ft automated bus on a public street in live traffic. They raised some questions regarding the reliability and robustness of the technology, the construction and the maintenance of the magnetic tracks and platforms, driver training and cost/maintenance of the VAA vehicles that warrant additional larger-scaled field operational tests.

RECOMMENDATIONS:

Several important lessons were learned during this period of real-world operations:

- Busway (electronic guidance) is different from a railroad track
 - Irregular road surfaces such as various road crowns (3-5 degrees on road side), road crown changes at intersections, storm drains along curb, utility access covers under the roadway, crack and pot holes are important attributes that distinguish a true “rail” system and the “electronic rail” system, and must be taken into account. Such irregularities will likely require large and smart nonlinear control to compensate if high precision is required
 - Roadside infrastructural objects could become very close to bus mirror along stations. Examples of such objects are utility poles, pedestrian and traffic signs, light poles, as well as trees
- Operation flexibility is important
 - Stop-and-go at will, and consistent steering control performance for any possible operational speeds from inching forward to high speeds are all critical real-world operation modes for BRT, especially under mixed traffic conditions
 - Easy, reliable, and possibly multiple methods of transitioning between manual and automated control to is a must, especially under mixed traffic conditions
 - Speed (especially for sharp curves), as well as stop location advisories would be helpful

The successful delivery of the field demonstration and tests of lane-assist/guidance and precision docking technology at East 14th Street provided a solid foundation for the VAA Pilot Program sponsored by the Federal Transit Administration (FTA) and ITS Joint Program Office (JPO). The program will address VAA deployment issues, and assess the cost and benefits in revenue-service operations.

The following are several future improvements that will be recommended for the magnetic guidance system, and modifications for some of them have already begun:

- Simultaneously detecting and processing multiple magnetic tracks will facilitate “track transition”
- Implementing virtual docking trajectory will facilitate more flexible docking operations
- Redundancy on critical components will further improve operational safety

Table Of Contents

Executive Summary	vii
Table Of Contents	xv
List of Figures	xix
List Of Tables	xxv
1 Background and Overview	1
1.1 Customer Needs and Interests in Deployment of Lane-Assist and Precision Docking Technologies.....	1
1.2 Value to Caltrans	2
1.3 Organization of the report	3
2 Literature Review.....	3
2.1 Magnetic Guidance System.....	4
2.2 GPS Guidance System	5
2.3 Vision-based Guidance System.....	7
3 Existing PATH System Review.....	8
3.1 Functionalities of existing PATH lane-assist system.....	8
3.2 System architecture of existing PATH system.....	9
4 Field Testing Goals and Objectives	13
5 Develop Docking Control for 60ft Articulated Bus.....	14
5.1 Dynamic model of a 60ft articulated bus	14
5.2 Docking controller design	18
6 Development of Testing/Demonstration Environment.....	20
6.1 Test/Demonstration Site Selection.....	20
6.2 Track Design and Survey	24
6.3 Test Track Installation Methodology	25

6.4	Test Track Magnet Installation	25
7	Test and Demonstration	29
7.1	Test Plan Development	29
7.2	Problems Encountered and Resolutions	32
7.3	Field Test Operations	39
7.4	Demonstrations.....	46
8	Data Analysis and Evaluation.....	48
8.1	Single Run Data Examination	48
8.2	Lane-Guidance Data Evaluation for ALL 35 Field Test Runs.....	53
8.3	Precision Docking Data Evaluation for All 35 Runs	57
8.4	Manual Override and Stop-and-go Control.....	62
8.5	Data Statistics.....	64
9	Conclusion	65
	Appendix A Track Design and Survey	69
	Appendix B Magnet Installation Methodology	76
	Appendix C Workshop and Demonstration Participant List	79
	Appendix D Media Report Collections.....	80
	Appendix E Press Release of Demonstration	81
	Appendix F FAQ Handout of Demonstrations	84

List of Figures

Figure 1 A general functional diagram of lane-assist system.....	9
Figure 2 Instrumentation of 60ft articulated bus.....	11
Figure 3 Software block diagram for PATH lane-assist system.....	12
Figure 4 Software architecture of PATH lane-assist system on 60ft articulated bus	12
Figure 5 Configuration of articulated bus.....	14
Figure 6 Frequency response from steering angle to lateral acceleration.....	17
Figure 7 Frequency response from steering angle to front section yaw rate	17
Figure 8 Frequency Response from steering angle to trailer section yaw rate	18
Figure 9 Controller design configuration.....	19
Figure 10 Map of Test Route	21
Figure 11 Location of Station #1	21
Figure 12 Station #1	22
Figure 13 Location of Station #2	22
Figure 14 Station #2.....	23
Figure 15 Location of Station #3	23
Figure 16 Station #3.....	24
Figure 17 East 14 th Street Installation: Survey and Mark (1m around station, 10m otherwise) on the Ground.....	26
Figure 18 East 14 th Street. Installation: Chalk Line Based on 10m Survey Marks	26
Figure 19 East 14 th Street Installation: Wooden 10m Template.....	27
Figure 20 East 14 th Street. Installation: Drilling Holes.....	27
Figure 21 East 14 th Street. Installation: Placing Magnet and Checking Polarity (with home-made tool).....	27
Figure 22 East 14 th Street. Installation: Sealing Magnets.....	28

Figure 23 East 14 th Street. Installation: Two Team Installation (Drilling, Cleaning Holes and Placing Magnets).....	29
Figure 24 Objects Close to Curb along East 14 th Street. (Station #2)	34
Figure 25 Utility Pole near Station #1 (right: 6” to curb; left: bus mirror next to pole when the bus is 20 cm to the curb)	34
Figure 26 Pedestrian Sign and Utility Pole near Station #2 (when bus is 20 cm to the curb)	35
Figure 27 Road Crown before Station #2 (4.75-4.15 degree); Right figure: Notice Road Crown from the Crossroad – 144 Ave.	35
Figure 28 Storm Drain in front of Station #1	36
Figure 29 Utility access cover in front of Station #1	36
Figure 30 Loop Detectors on the Ground (before 148 th Ave).....	37
Figure 31 Station #1 Precision Docking Performance.....	45
Figure 32 Station #2 Docking Precision Performance (Uneven Road Surfaces)	45
Figure 33 Station #2 Precision Docking Performance.....	46
Figure 34 Station #3 Precision Docking Performance.....	46
Figure 35 Single Run Example, Time-Based (avoiding bicyclist): front position, speed, LED, switch	50
Figure 36 Single Run Example, Magnet-Based (avoiding bicyclist): front/rear position, speed	51
Figure 37 Single Run Example, Magnet-Based (avoiding bicyclist): position, vehicle angle.....	51
Figure 38 Single Run Example, Magnet-Based (avoiding bicyclist): steering angle/command.....	52
Figure 39 Single Run Example, Time-Based (lane change): front position, speed, LED, switch	52
Figure 40 Lateral Positions and Trajectory (35 Field Test Runs) Magnet-Based	54
Figure 41 Front/Rear Lateral Positions (35 Field Test Runs) Magnet-Based	55

Figure 42 Lateral Position Errors (35 Field Test Runs) Magnet-Based	55
Figure 43 Vehicle Angle (35 Field Test Runs) Magnet-Based.....	56
Figure 44 Speed (35 Field Test Runs) Magnet-Based	56
Figure 45 Time from Track Start (35 Field Test Runs) Magnet-Based.....	57
Figure 46 Lateral Positions at Station #1 (35 Field Test Runs) Magnet-Based.....	59
Figure 47 Lateral Positions at Station #2 (35 Field Test Runs) Magnet-Based.....	59
Figure 48 Lateral Positions at Station #3 (35 Field Test Runs) Magnet-Based.....	60
Figure 49 Vehicle Angles at Station #1 (35 Field Test Runs) Magnet-Based.....	60
Figure 50 Vehicle Angles at Station #2 (35 Field Test Runs) Magnet-Based.....	61
Figure 51 Vehicle Angles at Station #3 (35 Field Test Runs) Magnet-Based.....	61
Figure 52 Manual Override or Switching to Manual Steering (10 Field Test Runs) Magnet-Based	63
Figure 53 Vehicle Speeds at Station #2 (35 Field Test Runs) Magnet-Based.....	63
Figure 54 Vehicle Speeds at Station #3 (35 Field Test Runs) Magnet-Based.....	64
Figure 55 Initial Test Track Design for Station #1	71
Figure 56 Initial Test Track Design for Station #2	72
Figure 57 Initial Test Track Design for Station #3	73
Figure 58 Example of Final Survey Map (Station #2).....	75
Figure 59 Example of Final Survey Map (Station #3).....	76

List Of Tables

Table 1 60ft articulated bus parameters	16
Table 2 Test and Demonstration Plan.....	32
Table 3 East 14 th Street Field Test Record	41
Table 4 Tracking Accuracy (Tracking error STD) Based on 35 Recorded Runs.....	64
Table 5 Docking Accuracy (Tracking error STD) Based on 35 Recorded Runs.....	64
Table 6 Final Docking Accuracy (Vehicle Angle at Stop) Based on 35 Recorded Runs.	65
Table 7 S-Curve Docking Time Based on 35 Recorded Runs (From Lane-Change to Stop at Station)	65
Table 8 Final Docking Speed Based on 35 Recorded Runs (From Lane-Change to Stop at Station).....	65
Table 9 Final Docking Station Parameters	76
Table 10 Code Table at East 14 th Street Test Track (Excluding header and trailer)	77

1 Background and Overview

1.1 Customer Needs and Interests in Deployment of Lane-Assist and Precision Docking Technologies

Bus Rapid Transit (BRT) systems can provide high quality, high capacity bus transit service on easily identifiable route structures at a lower development and implementation cost with higher modification flexibility than urban light rail systems. BRT services can be greatly improved with the addition of the ITS technology of electronic guidance, which would provide lane-assistance and precision docking functions, allowing the bus to operate in a designated lane that is only slightly wider than the bus itself and to precisely dock the bus at bus stops within an accuracy measured in centimeters. Such technologies afford a consistency and accuracy that is often difficult to attain even with highly-skilled drivers. All this can be done without increasing driver workload, and furthermore, provide cost and comfort benefits. Precision docking capability at bus stops allows fast loading and unloading of passengers with special needs, thereby reducing dwell time and improving ease of access for all passengers. Buses equipped with lane assist technologies can be operated at higher speeds on narrow lanes, facilitating greater rider satisfaction as well as cost effectiveness. This capability can significantly reduce the amount of land that is usually set aside for special bus-ways, which often take up a large amount of road space. The lane-assist function provides rail-like features that enhance efficiency, safety and quality of service for the BRT operations. Recent case studies conducted with Alameda-Contra Costa Transit District (AC Transit), Los Angeles County Metropolitan Transportation Authority (LACMTA), San Diego Association of Governments (SANDAG) and Lane Transit District in Eugene, OR show that the lane-assist capability can reduce up to 20% of the infrastructure cost. More significantly, the reduction of lane width can facilitate dedicated BRT in some cases where regular lane width (12ft wide) cannot be accommodated.

Many California transit agencies are interested in lane-assist and precision docking technologies. For example, AC Transit is planning a new BRT system along Telegraph Avenue in Berkeley to International Blvd in San Leandro, along which many locations are constrained by the width of the road. Lane-assist systems can support the reduction of lane width needed, which, in turn, could have major implications for infrastructure expenses by lowering construction costs and even establishing the basic feasibility of inserting BRT in the corridor. The capability to operate in a much narrow lane will make it possible for a new BRT system to be built upon or added to an already existing lane instead of entirely new lanes. Los Angeles MTA, which is already the nation's largest BRT service operator, is also interested in lane-assist technologies to facilitate dedicated BRT systems that enhance the efficiency and effectiveness of the operation. SANDAG is in the early stages of planning for future BRT deployments that could potentially benefit

from lane-assist services. Although the United States has been leading the research and development of lane-assist technologies, research products developed by US research organizations have not been moved to deployment in the United States, primarily due to the fact that the transit market is relatively small and that manufacturers doubt that investments in such technology would be financially viable. In order to interest businesses and manufacturers in public transit, which could potentially become one of the fastest-growing industries in the United States, the ground-work and infrastructure must first be laid by the government. Therefore, government-sponsored deployment projects are essential in encouraging the commercialization of this critical enabling technology.

The Federal Transit Administration (FTA) and the US DOT ITS Joint Program Office (JPO) have developed a new ITS initiative to address the deployment issues for Vehicle Assist and Automation (VAA) for Transit Operations. The objectives of the VAA program are to implement lane-assist/precision docking systems at selected transit agencies for field operational tests and to facilitate deployment of these systems. The VAA program has included an initial phase (1-3 years) for testing lane-assist technologies in controlled environments and a Field Operational Test phase (3-5 years). These two phases, together, take concrete steps toward the commercialization of vehicle assist and automation technologies. The VAA planning is currently underway and the multimillion dollar full scale program (with local cost match) is expected to start in the 2005-2006 federal fiscal year.

1.2 Value to Caltrans

This test/demonstration is an important milestone in the progress of the vehicle guidance technology that Caltrans has been supporting for many years, from research through development and testing for operational deployment. Success in this test/demonstration will help contribute toward commercialization of lane-assist and precision docking technologies by showing the viability of the technology in a real-world setting. Not only will it prove the utility of the technologies in transit systems, the demonstration would also provide opportunities for finding and fixing problems, promoting ever-better and safer versions, while placing California in a good competitive posture for the FTA Vehicle Assist and Automation test project.

The vehicle guidance technology should be beneficial to Caltrans in a variety of ways:

- helping make BRT buses more competitive with the quality of service given by rail transit, while simultaneously providing a much more cost-effective means of offering high-quality transit service;
- reducing the width of the right-of-way needed for BRT busways along state highways, making it easier to accommodate them without excessive impacts on parking and other traffic;

- enabling reduced width of future truck-only highway facilities so that they should cost less to build and require less right of way;
- supporting improved snow removal by improving the steering control of snow removal vehicles when lane markings are obscured by snow.

1.3 Organization of the report

This report is organized as follows: Chapter 2 provides a detailed review on the current status of lane-guidance technologies: magnetic guidance system, GPS guidance system and vision-based guidance system; Chapter 3 reviews the current status of magnetic guidance technology at California PATH; chapter 4 proposes a test/demonstration plan which focuses on the refinement of the technology and aims at the future deployment; chapter 5 documents the development of docking controller for the 60ft articulated bus; chapter 6 provides a detailed description on test/demonstration infrastructure construction including selection of demonstration/test site, magnetic track design, survey and installation; the description of test and demonstration procedure is provided in chapter 7; chapter 8 documents the detailed analysis of the data collected during test and demonstration chapter 9 concludes the report.

2 Literature Review

Before the actual development of a test and demonstration plan with the goal of future deployment of the VAA technologies, it is necessary to conduct a review on the current status of the different VAA technologies and understand the strength and weakness of each technology. A literature review with these objectives in mind will provide valuable insight for us to further improve upon magnetic guidance technology, the technology primarily selected for this project. For the past thirty years, researchers have been in the process of inventing and developing electronic guidance technologies. A general electronic guidance system works as follows. Position sensors are installed to detect vehicle lateral deviation from the lane center. The vehicle's lateral deviation is then fed back to a computer, where the corresponding steering command will be calculated and sent to a steering actuator (e.g. a motor actuating steering column through gears). The steering actuator will steer the vehicle according to the received command and maintain the vehicle within the lane boundary. Steering actuator design is quite similar, in principle, for different existing electronic guidance technologies. Usually an electric motor is used to actuate the bus steering system (e.g. steering column). Rather, the feature that most distinguishes different electronic guidance technologies is their method of determining the vehicle's lateral deviation from lane center with high accuracy, high bandwidth and robustness. Based on how the lateral deviation with respect to lane center is detected, electronic guidance technologies can be classified into magnet guidance system, GPS guidance system and vision guidance system.

2.1 Magnetic Guidance System

Magnetic guidance systems use magnetic material (e.g., magnetic tape or discrete magnets) located on, or embedded in, the lane center. Magnetometers mounted under the vehicle sense the strength of the magnetic field as the vehicle passes over discrete magnets or magnetic tape. Onboard signal processing software calculates the relative displacement from the vehicle to the magnet based on the magnetic field strength and the knowledge of the magnetic field characteristics of the magnet. Among the available technologies, the magnetic guidance system is the only one that has been verified to have the capability to be operated under all weather and operation conditions and to have fail-safe characteristics.

The advantages of using a magnetic guidance system are:

- Relative insensitivity to environmental factors such as lighting, weather and pavement conditions
- Very high positioning accuracy possible (centimeter level)
- Support for binary coding (e.g., road curvature or mile post)

The disadvantages of a magnetic guidance system are:

- Ferrous components in the vehicle, structural supports or reinforcing rods (rebar) may distort the local magnetic field. Such a change in background magnetic field is sometimes hard to identify and deteriorates the performance of the lateral sensing.
- The magnetic marker, if not installed properly (e.g. buried too close to the road surface or too deep, or not perpendicular to the road surface), may also increase the noise effect on lateral position estimation.
- The low field strength provided by the in-road magnets limits the maximum range for which the lateral position can be reliably estimated.

Under the sponsorship of Caltrans and US DOT, California PATH has developed and extensively tested the magnetic guidance system since 1988. PATH has installed the magnetic guidance prototype system on various vehicle platforms, including passenger cars, class-8 tractor/trailer rigs and buses. The magnetic guidance system has been successful in providing both completely automated steering control at highway speeds, as well as smooth, comfortable rides with high steering accuracy. In 1997 [1-4], a magnetic marker based lateral control system was installed on several Buick LeSabres and showcased in public demonstrations for different scenarios such as platoons driving on highway, high g maneuver and precision docking. In 2003, two 40-foot-long CNG New Flyer buses and one 60-foot-long articulated New Flyer bus were retrofitted with a magnetic guidance system. Precision docking and stopping maneuvers, both inline and s-curve, were demonstrated successfully in Washington DC and San Diego by a 40-foot-long bus with 2 cm accuracy laterally and 15 cm accuracy longitudinally. Lane-assist,

lane change and auto/manual transitions were demonstrated on the I-15 High Occupancy Vehicle (HOV) lane in San Diego. Fifteen cm lateral tracking accuracy was achieved at speeds of up to 65 mph for both 40-foot-long single unit buses and a 60-foot-long articulated bus. Since 1998, the magnetic guidance system has been field tested for snowplow guidance [5] and snowblower automated steering applications on the Donner Pass under the most severe operating conditions, and the magnets have remained in place and in good working condition through multiple freeze/thaw cycles each year.

Toyota has developed an Intelligent Multimode Transit System (IMTS) [6-8] which consists of automatically driven buses on exclusive tracks. Magnetic markers are used in order to sense the bus's lateral deviation from its course. Initial experimental study on a test course shows ± 5 cm lateral deviation up to 30 km/h [9]. The IMTS system was demonstrated at the 2005 World Exposition in Nagoya, Japan with platooning, lane-assist and precision docking functions [6].

The Phileas bus has an electronic lane-assistance and precision docking system with all-wheel steering [10]. The system is based on magnetic markers implanted underneath the road surface every 4 meters and works at speeds up to 45 km/h and under most weather conditions. While driving in automatic mode, the Phileas bus requires 6.6 m width for two-way dedicated lanes at 70 km/h. Although it was introduced to public service in October 2004, it was subsequently withdrawn from service for modifications, which are currently in progress.

2.2 GPS Guidance System

The Global Positioning System (GPS) is a convenient and accurate method for determining vehicle position in a global coordinate system. The advantages of using a GPS system as the positioning system for electronic guidance are [11]:

- Roadway infrastructure can be added at low cost.
- Significant amounts of path preview and roadway information together with digital maps can be used to facilitate electronic guidance design and BRT operations.
- GPS signals are available in all weather conditions.
- Unlimited sensor range.

However, GPS systems do have some disadvantages that limit their application to electronic guidance with regards to the high accuracy, high bandwidth and robustness requirements:

- Though GPS signals can be broadcast under all weather conditions, environment does have a great impact on GPS position accuracy. Performance may degrade significantly due to multi-path error and blockage of the signal.

- When GPS receiver changes satellites to calculate its solution, large transient errors may occur.
- GPS has some characteristics which may complicate the control system design for electronic guidance functions.
 - The GPS outputs are at a relatively low update rate (< 20 Hz) [11].
 - The GPS receiver outputs typically have a significant latency [11]. The latency for Trimble ms 750 receiver was found to be 34.7 ms in [12].
 - Strong coupling with vehicle motion: a GPS antenna is usually installed on top of the vehicle, generally away from the vehicle CG, thus creating strong coupling between GPS measurement and vehicle roll or pitch motions.

California PATH, in cooperation with U.C. Riverside, has conducted several projects with the purpose of improving current GPS technology and developing vehicle control/guidance using a GPS-based positioning system. In reference [11, 13-19], carrier phase signal processing and ultra-tight DGPS/INS (inertial navigation system) integration were investigated to address the problems associated with GPS-based positioning systems such as accuracy, latency and update rate. In [15], the integrated Carrier Phase (CP) DGPS/INS system could provide vehicle position, velocity, acceleration, heading and angular rate at 150 Hz with accuracies (standard deviation) of 1.5 cm, 0.8 cm/s, 2.2 cm/s/s, 0.1 deg and 0.1 deg/s. In [17, 20], a CP DGPS/INS based control system was tested onboard a PATH vehicle at the Crow's Landing test facility. Decimeter accuracy was achieved up to 70 mph under the open sky.

Researchers at the University of Minnesota have also conducted research work on GPS/INS-based vehicle control/guidance. In [21-22], researchers discuss issues surrounding DGPS-based control of heavy vehicles. In [23-24], CP DGPS was used for snowplow guidance in Minnesota. In this case, integration with INS was used to address the GPS signal loss due to certain intermittent blockages from satellite signals when driving through bridges and canyons. In the Minnesota study, two back-up solutions were prepared in the case of GPS signal loss. If the signal is lost for less than 30 sec, estimation from INS will be used for guidance. However, if the signal is lost for more than 30 sec, magnetic tape embedded in the roadway was used to provide lateral position to the system. In [25], a lane support system retrofitted on a Metro Transit bus was demonstrated to be capable of steering a 9.5 ft wide bus along a 10 ft wide "bus only shoulder" in the Minneapolis/St. Paul Minnesota Metro Area. Two CP DGPS receivers (Trimble ms 750) were used to provide centimeter accuracy position, roll and heading information. 13 cm (standard deviation) lateral tracking error was achieved at up to 35 mph. Most GPS based control/guidance tests were carried out in ideal or semi-ideal environments where sufficient satellites were available with little problems of blockage.

2.3 *Vision-based Guidance System*

Vision-based guidance/control mimics a human driver in the sense that it gathers information about the vehicle's position visually and determines its course of action. Usually, vehicle position relative to the road is extracted from images captured by cameras. Although some systems have been designed to handle completely unstructured roads without visual cues or landmarks, most systems focused on locating special features such as markings painted on the road surface. The advantages of vision-based guidance are:

- Vision-based guidance/control usually requires fewer infrastructure modifications.
- Vision information can be used for the estimation of road curvature, slope and super elevation, which may facilitate design of control/guidance system. Furthermore, traffic sign recognition and obstacle identification can be realized based on vision information acquired.
- Vision-based sensors are defined as passive sensors which can acquire data in a non-invasive way without altering the environment. Thus the chance of sensor interference with other systems both on and off the buses will be minimized.

The major disadvantage of vision-based guided system is that it increases sensitivity to environmental factors such as lighting, weather or pavement conditions. It also has limited measurement accuracy, based on the number of image pixels that are used to represent the lane marking.

Recent advances in both microprocessor and sensor technologies make possible the application of machine vision in vehicle guidance/control [26-30]. The CIVIS bus developed by IRISBUS and MATRA Transport International (subsequently taken over by Siemens) uses a vision-based control/guidance system. The bus position is estimated by detecting stripes painted in the center of the lane. CIVIS buses were introduced to everyday operation in several cities such as Clermont-Ferrand and Rouen in France as well as Las Vegas, Nevada, primarily for precision docking rather than lane-guidance. The CIVIS buses can dock within 2 inches of the curb while only requiring lane width that is 5 ft narrower than normal for the operation [31]. The major constraints of snow and ice preclude its application in northern parts of US and all of Canada [31]. Also, the operations carried out in Las Vegas demonstrate that vision-based landmarks can be easily affected by a variety of unpredictable factors. Because painted stripes last only for a short period of time when exposed to the high heat and intense UV rays of the desert, (Las Vegas), and it is expensive to periodically repaint the lane markers over the entirety of the bus route, Las Vegas is reconsidering the merits of continuing to use the system [25].

3 Existing PATH System Review

Automatic steering and precision docking systems for transit buses have been developed, tested and demonstrated in prototype form by the PATH research team since 2003. In this chapter, a brief summary of the PATH lane-assist system functionalities will be presented first. Following that will be a review for the system architectures including both software and hardware.

3.1 Functionalities of existing PATH lane-assist system

Since 2003, the PATH research team has been working with automatic steering and precision docking systems for transit buses. In 2003, the team began development of these systems, followed by testing and public demonstrations of the prototype systems. The first public debut of PATH lane-assist technology for transit bus was at the National Intelligent Vehicle Initiative (IVI) Meeting held in Washington, DC from June 24-26, 2003. A 90 m magnetic test track was built at a parking lot of Turner-Fairbanks Federal Highway Administration (FHWA) Research Center, in McLean, Virginia. A 40ft CNG single unit New Flyer bus was demonstrated with lane-assist, s-curve docking and precision stopping capabilities. The demonstration continued for about 2 days with 10-15 runs and various numbers of passengers onboard. On August 23-24, 2003, some of the key technologies for automated bus rapid transit services were demonstrated for invited visitors in San Diego, CA. The visitors who participated in this demonstration included members of the Board of Directors of ITS America and the Program Steering Committee of the Cooperative Vehicle-Highway Automation Systems (CVHAS) pooled-fund project, as well as the attendees of the TRB meeting on "Urban & Community Transit - The Role for Automated BRT". Lane-assist functions for both 40 ft single unit and 60 ft articulated buses were demonstrated along an 8-mile test track on the HOV lane of I-15 with highway speed. Both inline and s-curve docking functionalities were demonstrated for the 40ft single unit bus using the precision stopping function at the test track built in the I-15 south control yard. Lane-assist, precision docking, precision stopping and platoon were demonstrated for two 40ft single-unit buses along a circular track built at AT&T park in San Francisco, California for the 12th ITS World Congress on Nov. 6-10, 2005.

Although several different public demonstrations were conducted for the PATH lane-assist system, these demonstrations have only showed the basic performance and technological feasibility of these systems. Firstly, from the technological point of view, most lane-assist functions in the existing PATH system were developed for the 40 ft single unit bus. Although the 60 ft articulated bus's greater capacity means that it is widely used in public transit, only limited lane-assist functions were developed and demonstrated for the 60ft articulated bus in the existing PATH system. The development of precision docking function is more difficult for the 60 ft articulated bus due to the extra degree-of-freedom introduced by trailer section. Secondly, most tests and demonstrations were conducted in controlled environments such as the Richmond Field

Station test track, parking lot of AT&T Park in San Francisco, south control yard at I-15 in San Diego and parking lot of FHWA facility in Washington DC. Compared with public streets where BRT will operate, the controlled environments have the advantages of much better road surface (e.g. flat, even and no sewage cover or storm drain cover), which means less disturbance to the lane-assist controller and better overall performance. More importantly, live traffic on the public street including pedestrians and bikers, traffic lights and vehicles cutting into the test track could possibly interrupt the operation of the bus with lane-assist system. Therefore, a more sophisticated lane-assist system, which can be quickly turned off or on at any stage of the operation, either automatically or manually, is required for any bus operations using lane-assist systems on public streets. Thirdly, most demonstrations were a two or three day event, so the durability of such systems over long periods of time with heavy use is still unknown. Only limited demonstration runs were conducted due to the necessary busy scheduling of such events.

3.2 System architecture of existing PATH system

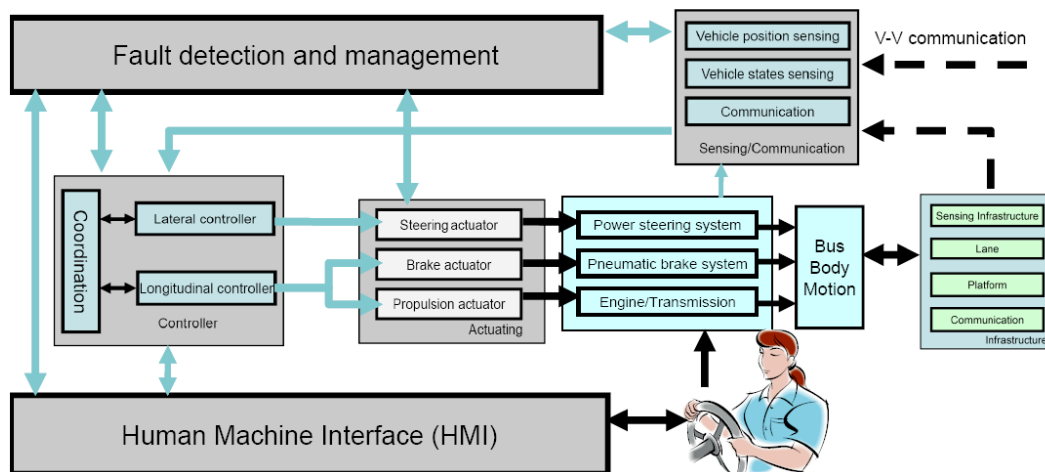

Figure 1 A general functional diagram of lane-assist system

Figure 1 shows the general functional diagram of a lane-assist system including the following basic elements:

- Vehicle position sensing:** In principle, any lateral guidance technologies (such as GPS, DGPS/INS, machine vision, electronic marker system, magnetic tape, magnetic markers, transponders, etc.) can be a candidate for precision docking as long as they satisfy the reliability and accuracy requirements for the specific precision docking application. In this study, the magnetic guidance system was chosen because of its high reliability under almost all operational scenarios as well as its ability to provide accuracy to within a centimeter. A typical lateral guidance system may involve infrastructure support, sensors, signal processing and validation.

- **Steering actuator:** The steering actuator receives control commands from an upper level controller and actuates the existing steering system to the desired steering angle.
- **Controller:** The controller is the brain of the lane-assist system. It receives commands from the driver through the Human Machine Interface (HMI) and relevant sensing information from the sensing systems. Appropriate commands are then calculated and sent to the actuators to achieve the desired maneuvers.
- **Human machine interface (HMI):** The HMI is the bridge or communication channel between the driver and the lane-assist system. It can serve multiple functions, including providing diagnostics, warnings, driver assistance, system activation or deactivation via multiple modalities (audible, visual, or haptic feedback to driver).
- **Fault detection and management:** Fault detection and management form a necessary functional element for the lane-assist system because it is a safety critical system. Alerts will be issued to the driver when failures and inconsistencies are detected in the sensor, actuator or controller functioning. The lane-assist system will then switch to operation under a failure mode with degraded performance but guaranteed safety.

Figure 2 depicts the major components for the PATH lane-assist system retrofitted on a 60 ft articulated bus. As seen in this figure, the major components are: front and rear magnetometers as the main lateral sensors, yaw gyro and speed as auxiliary sensors, add-on DC motor on the steering column as the steering actuator, computer with all the signal processing, control algorithms, and HMI controls as the intelligent center of the system, and button/switches, driver indicators, sound and indicators as the DVI systems.

Figure 3 illustrates the system block diagram of the lane-assist system on the 60 ft articulated bus, which includes hardware and software with various functions. The hardware consists of various switches, steering DC motor, vehicle sensors, computer, displays and audible units. The software consists of various software drivers, steering actuator algorithm, lateral control algorithms, and DVI controls. The steering actuator control algorithm provides functions such as self-calibration, tight position servo, various mode transition and fault detection. The lateral control algorithms include lane-tracking control, transition control, trajectory planning, mode switching and failure detection and fault mode control. The DVI control tracks the control states, driver reactions, and provides appropriate interface for manual, automated, and transition controls. It also includes warning and emergency supports.

Figure 4 shows the software architecture of the PATH precision docking system. The core of the software architecture is a “public” subscribed database (db_slv). All application software make their decisions based on the real-time database information. The lateral control consists of the following blocks: vehicle I/O (sensor inputs), lateral

control (sensor signal processing and various lateral controls), steering actuator (steering hardware drivers), steering inner loop (steering servo and its associated intelligence), and HMI inputs and outputs.

The existing PATH lane-assist system on the 60 ft articulated bus adopted a centralized system architecture. All the sensors and actuators were directly connected to a central computer, which hosted processes such as magnetic sensing processing, steering servo, vehicle state sensing and controller. The drawbacks of such centralized system architecture are obvious. First of all, all the real-time processes such as controller, steering servo and magnet sensing processing resided in the same computer, where they were competing for the limited CPU power. To satisfy the real-time constraint, the sampling rate of each program had to be chosen carefully. Second, all the wires to/from sensors/actuators had to be routed to the central computer, which not only complicated the wire routing but also introduced possible electro-magnetic noise. For example, the centerpieces of the magnetic guidance system are two magnetometer bars, each of which includes seven magnetometers. Each magnetometer has three outputs, representing the magnetic field strength in three orthogonal directions. That alone introduced 42 wires routed to the central computer, without counting the ground and power. Finally, in such a centralized architecture, the reliability of the central computer is critical.

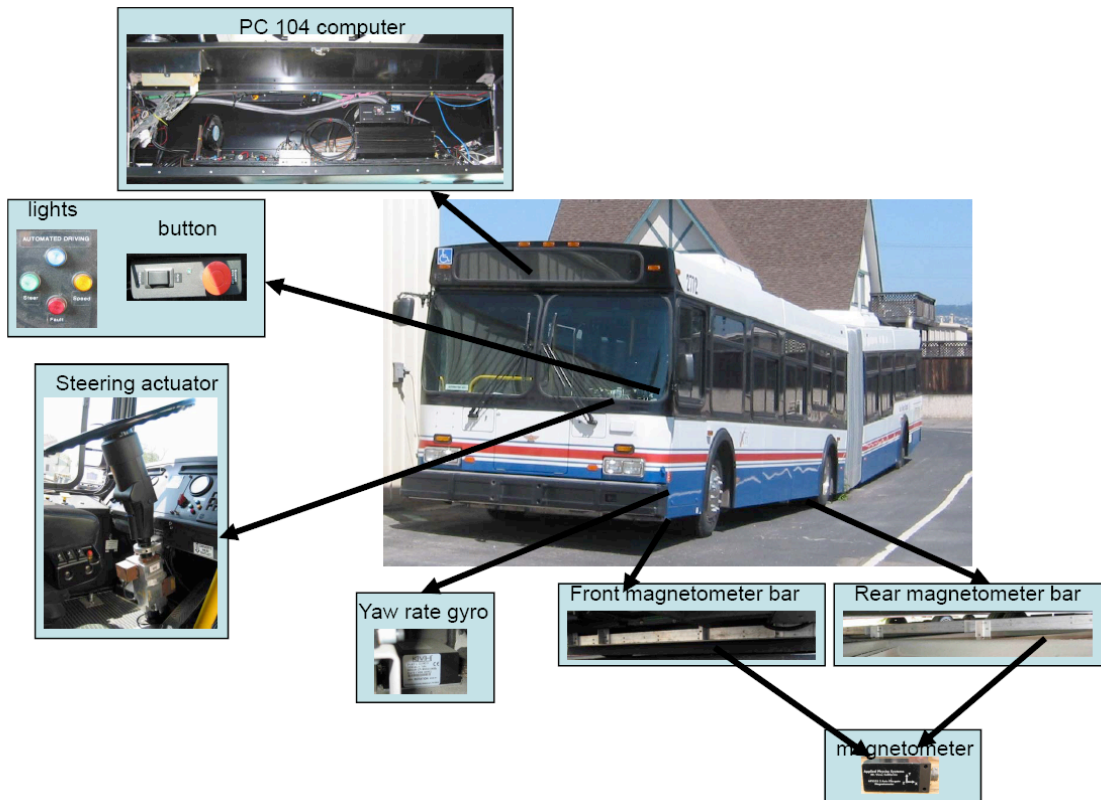

Figure 2 Instrumentation of 60ft articulated bus

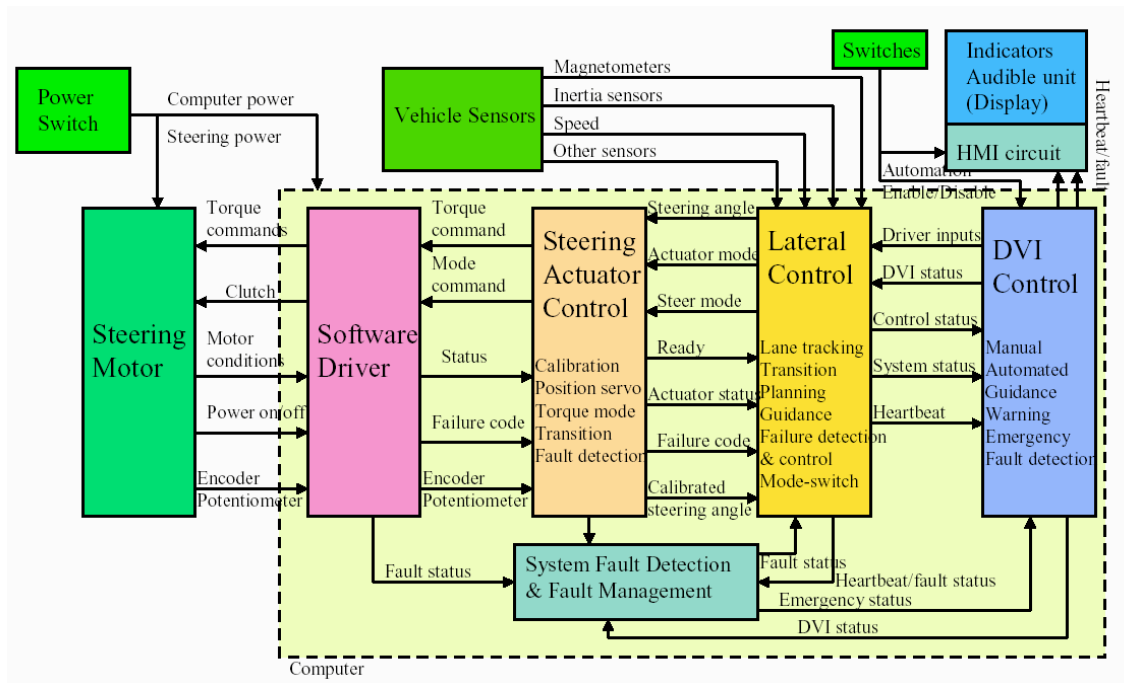

Figure 3 Software block diagram for PATH lane-assist system

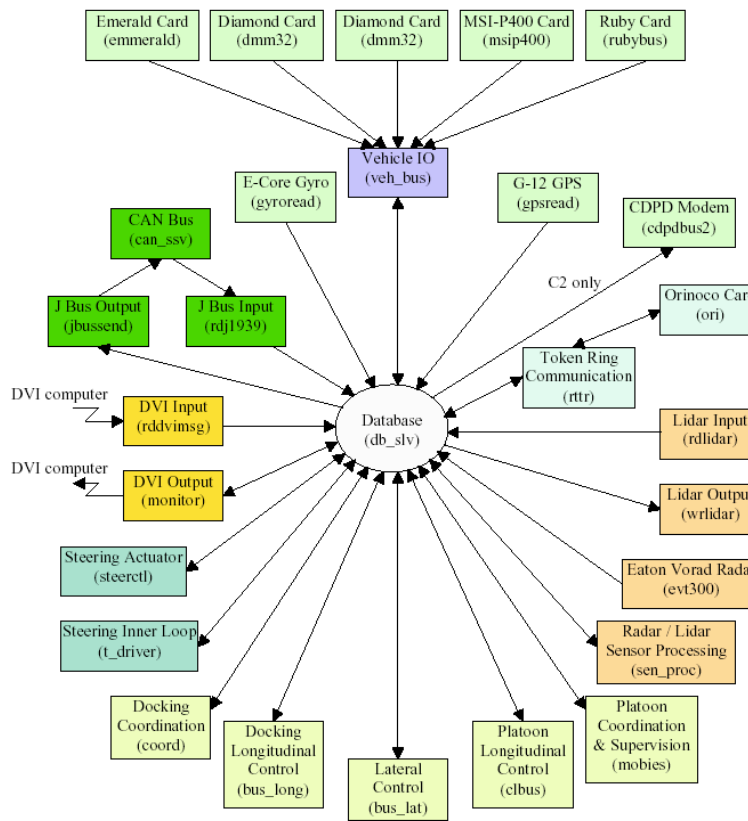

Figure 4 Software architecture of PATH lane-assist system on 60ft articulated bus

4 Field Testing Goals and Objectives

As presented in the previous two review chapters, magnetic guidance technology could provide reliable and accurate vehicle position measurement for both lane-assist and precision docking functions. California PATH has already developed the lane-assist system based on the magnetic guidance technology. Although this system has been demonstrated publicly several times at different events, those demonstrations only showed performance and technology feasibilities of such system. The PATH lane-assist system is still not at the stage of real-world application in the following areas:

- Docking function was only developed for the 40 ft single unit bus. It will be preferable that such function could also be available for 60 ft articulated bus which is widely used in the public transit
- All the past demonstrations were conducted in a controlled environment which has better road surface and no interruption from live traffic, in great contrast to the public roads where BRT usually operates
- All the past demonstrations were conducted for two or three days with limited demonstration runs. It is necessary to conduct extensive testing to validate the robustness and reliability of the lane-assist system and provide guidelines for the future deployable system design.
- The existing PATH lane-assist system adopted a centralized architecture which is not preferable for the future deployable system design.

Addressing all of these issues is too large of a job to be accomplished within the scope of the proposed project and in a university research environment, so the research is focusing on the two issues:

- Develop docking control function for 60 ft articulated bus. This will extend the lane-assist system application (on 40 ft buses) to the widely used vehicle fleet in the public transit
- Conduct the demonstration and extensive testing in a real-world operation setting. This task serves several purposes.
 1. The docking system design will be tested and modified in a real-world operation setting to accommodate situations such as road surface conditions and interruption by live traffic.
 2. The extensive testing in the real-world setting will expose the problems in the system that prevent it from achieving high repeatability and reliability, outlining the changes that will be necessary for a system design in the future that can be deployed on a large, public scale.

3. The public demonstration on the real-world operation setting will showcase the applicability of the technology to different parties such as government agencies, public transit agencies and local city management and promote its future adoption

5 Develop Docking Control for 60ft Articulated Bus

In this chapter, a dynamic model for the lateral dynamics of the 60ft articulated bus will be developed first to further understand the problems that accompany a docking controller design for an articulated bus of a length of 60 feet, and provide foundation for the docking controller design. A docking controller design based on mixed H_2 / H_∞ optimization will be presented later.

5.1 Dynamic model of a 60ft articulated bus

With the additional degree-of-freedom introduced by trailer section, the dynamics of a 60 ft articulated bus is very different from that of a 40 ft single section bus. This is especially true when an articulated bus makes a lane change and docks at the station. During initial testing, we observed that the trailer section shows significant oscillation when the bus enters or exits during a lane change with relatively high speed (e.g. higher than 15 mph). Therefore, the lateral dynamics of the articulated bus needs to be studied before a high performance robust docking controller can be designed for the articulated bus. Using Kane's equation, the dynamic model of a 60 ft articulated bus can be developed. If we assume small steering angle and small articulation angle, the lateral dynamics of articulated bus can be written as:

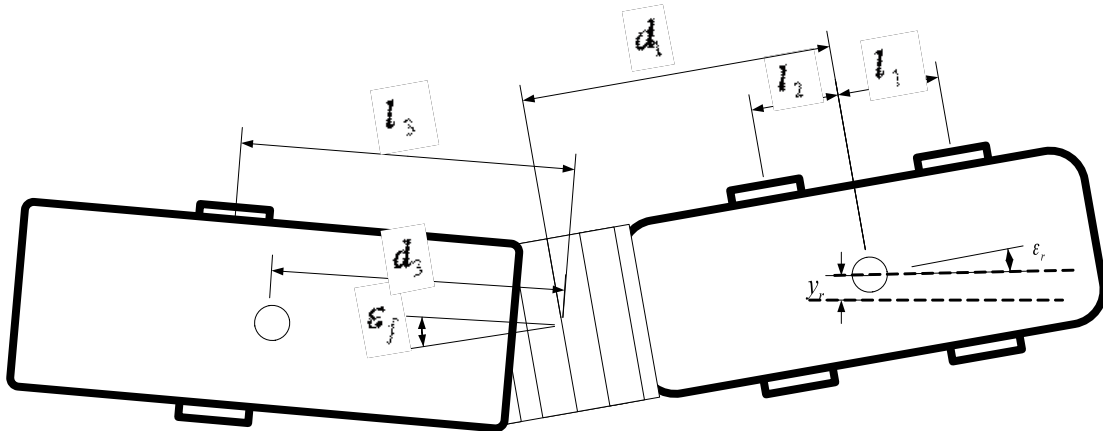

Figure 5 Configuration of articulated bus

$$M\ddot{q} + C\dot{q} + F = E_1\dot{\varepsilon}_d + E_2\ddot{\varepsilon}_d \quad (1)$$

where $q = [y_r \quad \varepsilon_r \quad \varepsilon_f]^T$ and y_r represents the lateral displacement of the bus's front section CG with respect to the lane's center line, ε_r is the yaw angle of bus front section with respect to the lane's center line, ε_f is the articulation angle shown in Figure 5. $\dot{\varepsilon}_d = v\rho$ is the angle velocity of road reference frame where v is vehicle longitudinal speed and ρ is the curvature of the road. The rest of the matrices are defined as follows:

$$M = \begin{bmatrix} m_1 + m_2 & -m_2(d_1 + d_3) & -m_2d_3 \\ -m_2(d_1 + d_3) & I_{z1} + I_{z2} + m_2(d_1 + d_3)^2 & I_{z2} + m_2d_3^2 + m_2d_1d_3 \\ -m_2d_3 & I_{z2} + m_2d_3^2 + m_2d_1d_3 & I_{z2} + m_2d_3^2 \end{bmatrix} \quad (2)$$

$$C = \begin{bmatrix} 0 & (m_1 + m_2)v & 0 \\ 0 & -m_2(d_1 + d_3)v & 0 \\ 0 & -m_2d_3v & 0 \end{bmatrix} \quad (3)$$

$$F = H\dot{q} + Kq + G\delta \quad (4)$$

$$H = \frac{2}{v} \begin{bmatrix} C_{af} + C_{ar} + C_{at} & C_{af}l_1 - C_{ar}l_2 - C_{at}(d_1 + l_3) & -C_{at}l_3 \\ C_{af}l_1 - C_{ar}l_2 - C_{at}(d_1 + l_3) & C_{af}l_1^2 + C_{ar}l_2^2 + C_{at}(l_3 + d_1)^2 & C_{at}(l_3 + d_1)l_3 \\ -C_{at}l_3 & C_{at}l_3(l_3 + d_1) & C_{at}l_3^2 \end{bmatrix} \quad (5)$$

$$K = 2 \begin{bmatrix} 0 & 0 & -C_{at} \\ 0 & 0 & C_{at}(l_3 + d_1) \\ 0 & 0 & C_{at}l_3 \end{bmatrix} \quad (6)$$

$$G = -[C_{af} \quad C_{af}l_1 \quad 0] \quad (7)$$

$$E_1 = \begin{bmatrix} -(m_1 + m_2)v - \frac{2}{v}(C_{af}l_1 - C_{ar}l_2 + C_{at}(l_3 + d_1)) \\ m_2(d_1 + d_3)v - \frac{2}{v}(C_{af}l_1^2 + C_{ar}l_2^2 + C_{at}(l_3 + d_1)^2) \\ m_2d_3v - \frac{2}{v}C_{at}l_3(l_3 + d_1) \end{bmatrix} \quad (8)$$

$$E_2 = \begin{bmatrix} m_2(d_1 + d_3) \\ -(I_{z1} + I_{z2} + m_2(d_1 + d_3)^2) \\ -(I_{z2} + m_2d_3^2 + m_2d_1d_3) \end{bmatrix} \quad (9)$$

where δ is front wheel steering angle. m_1 , m_2 , I_{z1} and I_{z2} represent the mass of the bus's front section, mass of the bus's trailer section, moment of inertia of the bus's front section and moment of inertial of the bus's trailer section respectively. C_{af} , C_{ar} and C_{at} represent cornering stiffness of bus front tires, rear tires and trailer tires respectively. If we choose state variables $x = [y_r \quad \varepsilon_r \quad \varepsilon_f \quad \dot{y}_t \quad \dot{\varepsilon}_r \quad \dot{\varepsilon}_f]^T$, steering angle δ as the system control input and $d = [\dot{\varepsilon}_d \quad \ddot{\varepsilon}_d]^T$, the lateral dynamics of the articulate bus can be written in state space as:

$$\dot{x} = Ax + B\delta + Ed + n \quad (10)$$

where

$A = \begin{bmatrix} 0 & I \\ -M^{-1}K & -M^{-1}(C+H) \end{bmatrix}$, $B = \begin{bmatrix} 0 \\ -M^{-1}G \end{bmatrix}$, $\begin{bmatrix} 0 & 0 \\ E_1 & E_2 \end{bmatrix}$ and n represents the disturbances that cannot be modeled exactly, which are generated by conditions such as road crown angle, holes and unevenness on the road surface. The parameters of a 60-foot-long diesel articulated bus can be found in Table 1.

Figure 6-Figure 8 show the frequency responses that result from the vehicle steering angle to vehicle lateral acceleration, front section yaw rate and trailer section yaw rate at different longitudinal speeds. As vehicle longitudinal speed increases, resonant peaks appear around 0.3Hz, especially for the trailer section yaw rate. This verifies what we experience on the field.

Table 1 60ft articulated bus parameters

Descriptions	Values
Mass of front section (kg) m_1	8,210
Mass of articulated section (kg) m_2	10,387
Front section yaw moment of inertia (kgm^2) I_{z1}	58,344
Articulated section yaw moment of inertia (kgm^2) I_{z2}	93,221
Front section front tire stiffness (N/rad) C_{af}	143,000
Front section rear tire stiffness (N/rad) C_{ar}	250,452
Articulated section tire stiffness (N/rad) C_{at}	285,300
Distance: front axle to articulated joint (m) d_1	8.1
Distance: front section CG to rear axle(m) l_2	3.52
Distance: front section CG to front axle (m) l_1	2.28
Distance: articulated joint to articulated section axle	5.69
Distance: articulated section CG to articulated joint (m) l_3	5.2

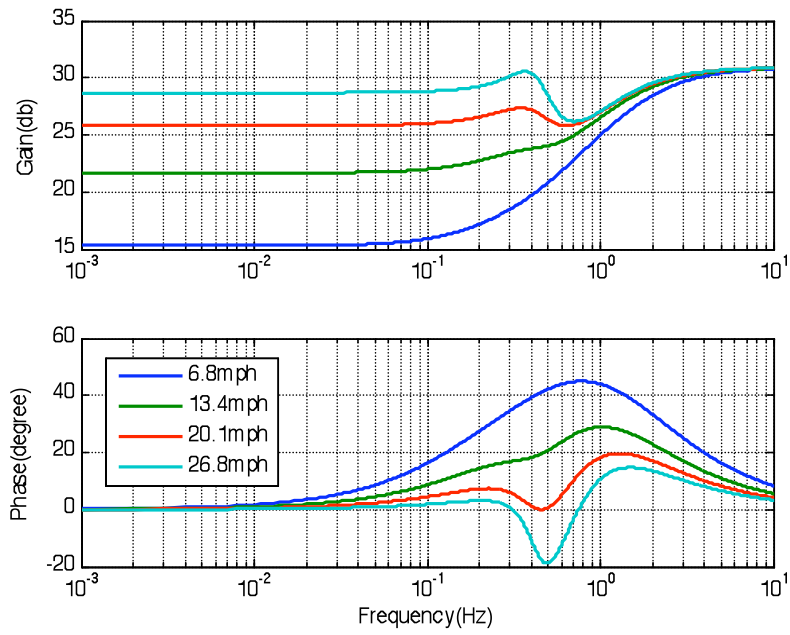

Figure 6 Frequency response from steering angle to lateral acceleration

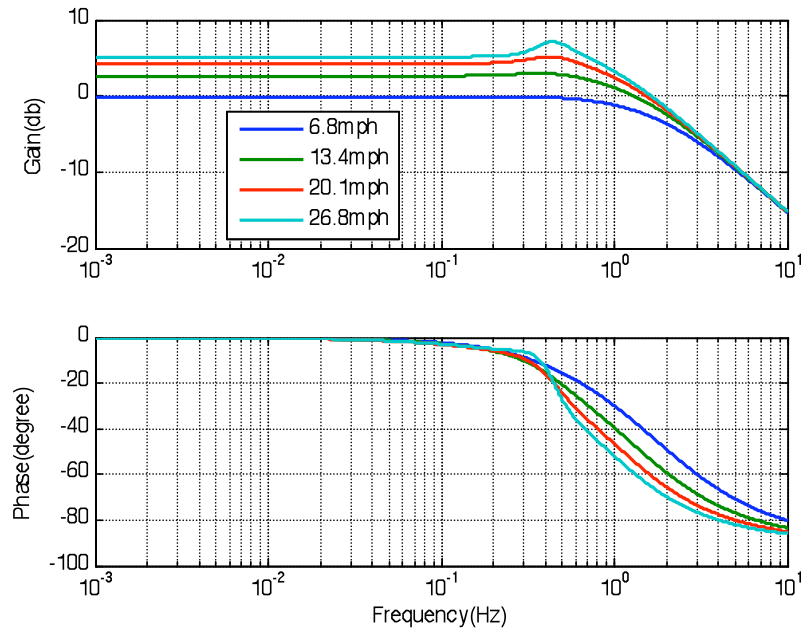

Figure 7 Frequency response from steering angle to front section yaw rate

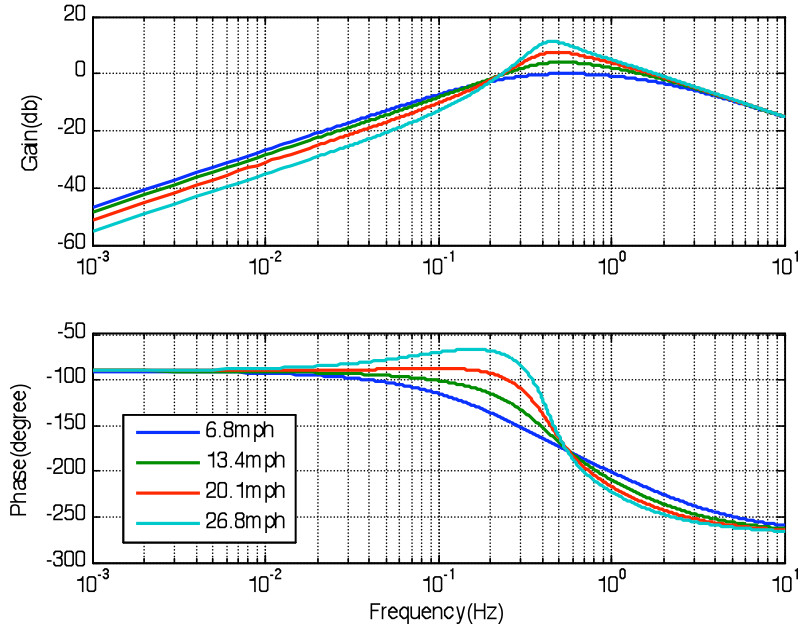

Figure 8 Frequency Response from steering angle to trailer section yaw rate

5.2 Docking controller design

The objective of the docking steering controller is to keep the lateral error in front of the bus, $y_h = y_r + \varepsilon_r d_4$, small by using the front steering angle δ as the control input, where d_4 is the look ahead distance. There are several difficulties inherent in the design of this controller. First, the lightly damped mode introduced by the bus's trailer section tends to oscillate when the bus enters and exits a lane change maneuver with increased speed. Secondly, the system is subject to multiple uncertainties (such as changes in road surface conditions), large external disturbances from curvature change, and external load changes from passenger loading and unloading. These uncertainties are represented by the lumped disturbances d and n .

Various control techniques can be employed to design the feedback controller; we choose the mixed H_2/H_∞ synthesis for both performance and robustness. The generalized H_2 norm is a convenient way of expressing performance requirements such as disturbance rejection of the bus docking operation. Since the generalized H_2 norm represents the system gain from L_2 to L_∞ , its value can be interpreted as the worst time-domain amplification of the disturbance input with finite energy. In addition, the H_∞ criterion provides a natural expression for the system robustness.

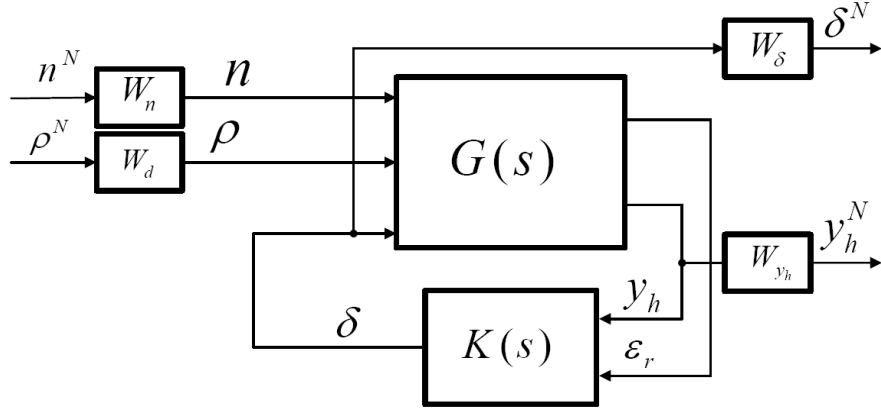

Figure 9 Controller design configuration

The mixed H_2/H_∞ synthesis can be formulated as shown in Figure 9, where $G(s)$ represents the open-loop articulated bus lateral dynamics and $K(s)$ represents the controller to be synthesized. W_d , W_δ , W_n and W_{y_h} are the control design weighting functions. By denoting:

$$y_h^N = T_1(s)(d^N, n^N)^T \quad \delta^N = T_2(s)(d^N, n^N)^T \quad (11)$$

where T_1 and T_2 are the transfer functions from the disturbance to the bus look ahead lateral deviation and to the front steering control, respectively. Minimizing the H_2 norm of T_1 imposes the performance requirement described above. Minimizing H_∞ norm of T_2 increases the system robustness against unstructured additive uncertainties. Since T_1 and T_2 represent two channels with different roles in the control design, it is desirable that these two channels are treated separately. In the traditional H_2 or H_∞ design, these two channels are usually combined together with different weighting functions and can be optimized only for either H_2 or H_∞ norm. An LMI-based multi-objective strategy can treat each channel separately with different norm criteria. Such a design technique provides more design flexibility compared with traditional design and is therefore adopted for the bus docking controller design.

The control objective is to minimize $\|T_1\|_2$ subjected to $\|T_2\|_\infty < \gamma$. This can be interpreted as maximizing system disturbance rejection performance with guaranteed system robustness against unstructured additive uncertainties. This sort of mixed H_2/H_∞ synthesis problem can be solved via LMI optimization. In practice, bus lateral dynamics can be regarded as a linear parameter-varying system with respect to the vehicle longitudinal speed v . Due to the large mass and passenger comfort requirement,

the speed variations during operation are generally small. A practical approach for the synthesis is to design the controller at several speed grid points and use interpolation for implementation.

6 Development of Testing/Demonstration Environment

6.1 Test/Demonstration Site Selection

The test site was proposed for East 14th Street in San Leandro for several reasons:

- This is part of the planned route for AC Transit's BRT service, so this test could help show the benefit of lane-guidance and precision docking for that service in a tangible way.
- This is part of SR-185, so Caltrans has responsibility for the right of way.
- It is an urban corridor with geometric and traffic conditions representative of other BRT applications, for transferability of the results and lessons learned.

The actual test site (section) was selected based on the following guidance:

- A test site that presented real-life situations but without excessive variability, as this test is the first on-road test of these buses in live traffic.
- Simple geometry or straight streets if possible, to reduce cost and complication.
- Streets that experience relatively few large activities or events.
- Away from one lane traffic to facilitate magnetic track installation and onsite system debugging so that at least one lane could be kept open for vehicle drivers.
- Street parking is not too close to the bus station so that bus could pull out from station easily.
- The length of straight section is long enough for the bus to (automatically) approach, stop and pull out.

After discussions with Caltrans District 4 and several site visits, the site for the lane-assist test track was Southbound East 14th Street in San Leandro, roughly between 139th Ave. to 150th Ave. as shown in Figure 10. The total length of this route is about 0.9 mile. The first station is a normal southbound bus stop between 139th Ave. and 141st Ave (as shown in Figure 11 and 12). The second station is a normal southbound bus stop between 144th Ave. and 145th Ave (as shown in Figure 13 and 14).. The third station is a rapid southbound bus stop between Hesperian Blvd and 150th Ave on East 14th Street (as shown in Figure 15 and 16).

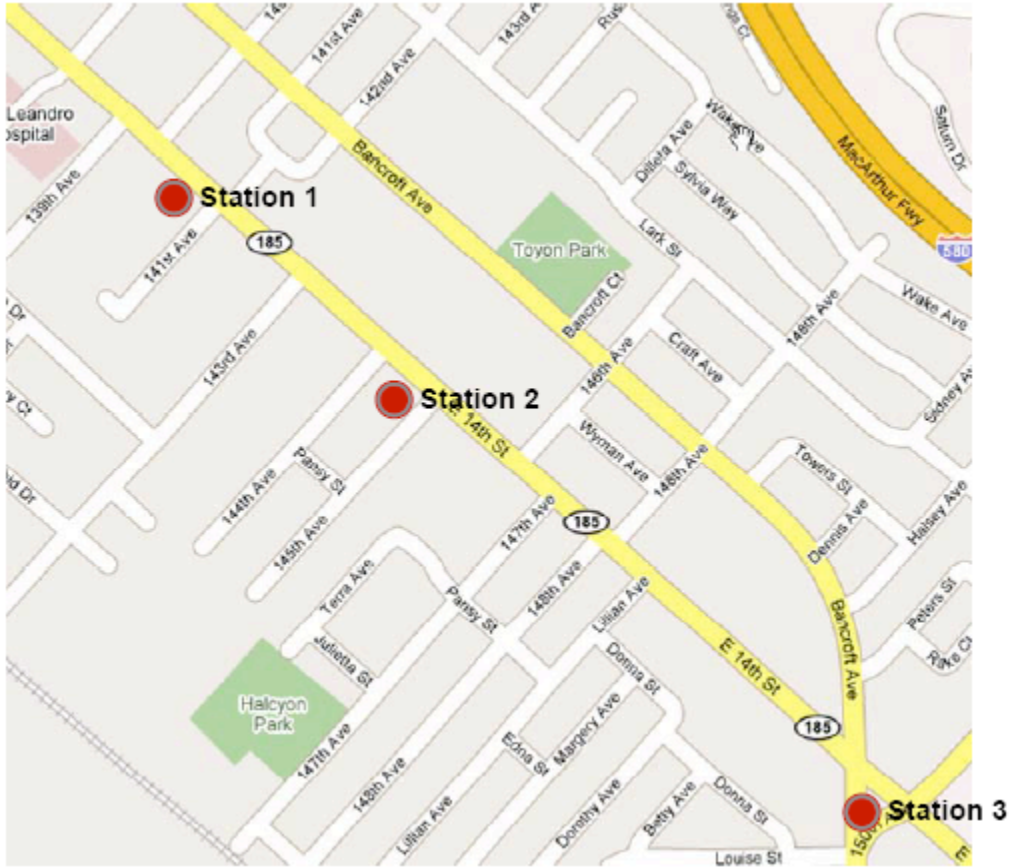

Figure 10 Map of Test Route



Figure 11 Location of Station #1



Figure 12 Station #1



Figure 13 Location of Station #2



Figure 14 Station #2

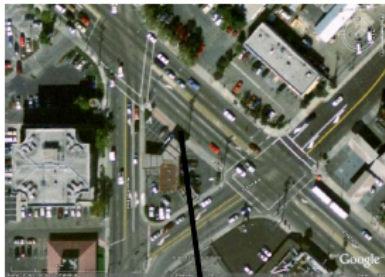

Station



Figure 15 Location of Station #3



Figure 16 Station #3

6.2 Track Design and Survey

Once the test route and the station locations were decided, the next step was to design detailed test track layouts for the surveyor. The PATH engineers first created several test track initial designs based on the on-site measurements, especially in the areas around the bus satiations. These initial designs included drawings of the magnetic trail as well as the associated S-curve equations of each docking station that traded off existing physical constraints surrounding the station. Examples of the constraints were utility poles, traffic signs and trees that were close to the curb, the existing bus stop locations, the nearest street parking spaces, as well as locations of the storm drains and utility access covers along the track. Iterations were then made between the surveyors and the PATH engineering until the final magnetic track was determined. The final magnetic track included 1272 magnet locations. The survey points are 1m apart for docking curves, and 10 meters apart for other areas. In addition, the in-pavement obstacles such as traffic loop detectors were also indicated in the survey map and were be marked on the pavement accordingly to facilitate movement of the magnet location forward and backward along the track to provide sufficient distance between the loop and the magnet during the installation procedure. The detailed track design and survey can be found in Appendix A.

6.3 Test Track Installation Methodology

The magnetic track design, survey and installation were conducted once the testing site was fully evaluated by all parties involved (Caltrans, City of San Leandro, AC Transit, and PATH). The magnetic track installation was carried out on the public street. Although we avoided the road section with only one lane on each direction, the installation would still block one southbound lane. Specific test track installation procedure was then developed to minimize the impact on traffic and ensure fast and accurate installation. The detailed installation methodology that included the rule for magnet installation as well as the procedures and responsibilities of each party during the installation can be found in Appendix B.

6.4 Test Track Magnet Installation

The test track along East 14th Street was surveyed and the magnets were installed in two days during a weekend on November 17 and 18, 2007. The installation process included the following procedures that are typically performed in parallel:

1. Performing road closure (a small section at a time)
2. Survey and marking magnets (1m apart around docking stations, 10m apart otherwise): see Figure 17 for an example of the two-man survey team
3. Using chalk lines to create a 10m line between two adjacent points: see Figure 18
4. Using a 10 m wooden template to mark a magnet point every one meter: see Figure 19
5. Drilling holes (4"+ deep) for magnets: see Figure 20
6. Placing magnets based on the code table and checking polarities using another magnet: see Figure 21
7. Sealing magnet using sealer: see Figure 22

The survey team was generally one block ahead of the installation team. The installation was performed by three teams of three members each. The two drill teams each had 1 person drilling and 1 person preparing the holes. One additional team first marked the additional drill points using chalk lines and templates, then placed, checked and sealed the magnets. A total of 1272 magnets were surveyed, marked and installed in two days. A few magnets were placed too close to the loop detectors and had to be removed. The follow-up bus testing indicated that no mistakes were made during installation.



Figure 17 East 14th Street Installation: Survey and Mark (1m around station, 10m otherwise) on the Ground

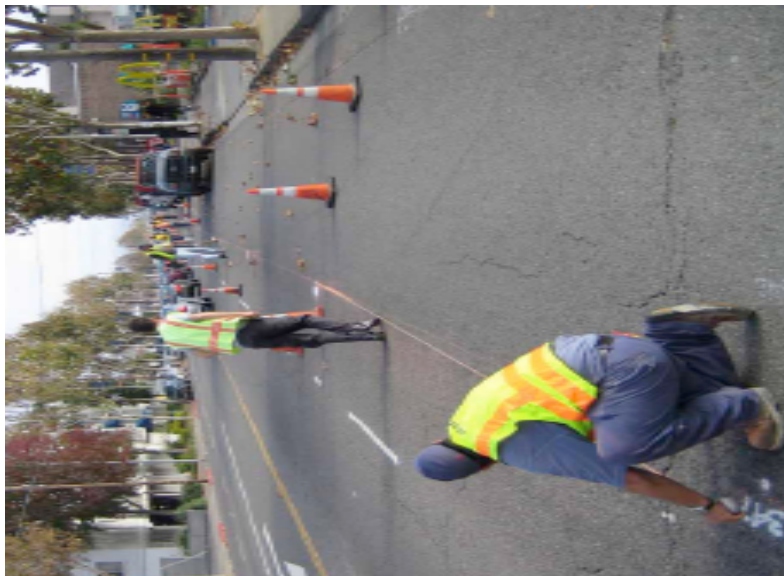

Figure 18 East 14th Street. Installation: Chalk Line Based on 10m Survey Marks



Figure 19 East 14th Street Installation: Wooden 10m Template.



Figure 20 East 14th Street. Installation: Drilling Holes



Figure 21 East 14th Street. Installation: Placing Magnet and Checking Polarity (with home-made tool)



Figure 22 East 14th Street. Installation: Sealing Magnets



Figure 23 East 14th Street. Installation: Two Team Installation (Drilling, Cleaning Holes and Placing Magnets)

7 Test and Demonstration

7.1 Test Plan Development

Purposes:

This test is a critical step that marks the progress that has been made under Caltrans support on vehicle guidance technology, from research to development, followed by testing toward operational deployment. By demonstrating the capability and profitability of buses equipped with lane-assist and precision docking technologies in a real-world setting, a successful testing of the technologies described in this report will greatly contribute toward commercialization of such systems for public transit. Careful testing will also reveal the possible unforeseen difficulties or problems inherent in the system itself or in relation to its environment, presenting opportunities to redesign a safer and more robust system that can be marketed with greater success. Lastly, these tests can serve as a good foundation for the approved FTA Vehicle Assist and Automation test project.

Tasks:

Task 1: Infrastructure-related software preparation

Once the magnets are installed, the first task is to check the correctness of the track design and the precision of the magnet installation using the articulated bus. Software compensation may need to be developed if there are installation variations or errors. In addition, the magnetic de-coder will also need to be implemented and verified. The sub-tasks include:

1. Check magnetic installation & possible software correction design
2. East14th Street magnetic coding-de-coding software implementation
3. New/variable preview information software implementation

Task 2: East14th Street “real-world” control software preparation

Initial functionality testing will be conducted once the magnetic track installation is completed. Any newly integrated system function will be first fully tested at the Richmond Field Station test track to ensure all functions follow the correct procedures. Coordination between PATH and AC Transit will be conducted to identify preferred testing schedules, for example, to avoid peak traffic hours. Tests conducted on East 14th Street will focus on dialing in system parameters for various system functionalities and road geometries. The testing will include the following sub-tasks:

1. Re-tuning lane-guidance functions for higher speeds
2. Design and testing for low speed articulated-bus docking robustness and repeatability
3. Docking exit design (including designing of specific exit maneuvers for East 14th Street docking station #2)
4. Designing and testing for driver abort and engaging
5. Stop-and-go design and validation
6. Designing and testing for accommodating specific East14th Street real-world roadway situations such as trees, signs near the docking station, large (5 deg+) and variable road crown, storm drain covers and utility access covers, etc.
7. Transitional and operational state machine design among different stations

Task 3: East 14th Street testing and data collection:

A series of tests will be conducted at East14th Street under different scenarios for real-world situation evaluations and for initial system robustness assessments. Data will be collected for further analysis; occurrences of various real-world situations will be documented and tabulated including events such as use of the emergency brake, vehicle cut-in, or switching off automatic control. During the testing, data such as vehicle speed, steering angle, yaw rate, vehicle longitudinal location, lateral deviation and automation status will be recorded for each run. Certain scenarios may be videotaped for further analysis. The data collection will include the following two basic data types:

1. Technical data collection: These tests will be conducted during early hours when there is little traffic on the road. The following specific maneuvers will be repeated for further data collection and analysis. The exact number of runs on each specific maneuver will be determined based on the available time for testing and the consistency of the specific maneuver.
 - a. Stop-and-go maneuver
 - b. Automation transition (automatic or manual)
 - c. Operation with load
2. Normal operational data collection: Tests will be conducted during various hours in a typical day under normal traffic conditions. A minimum of 12 runs per day will be performed on at least two different days.

Task 4: Transit Agency Ride-along & Public demonstration:

Ride-along will be conducted for various local transit operators and drivers, in particular from ACTransit, Valley Transportation Authority (VTA) and San Mateo County Transit District (Samtrans). Discussions among all participants will be conducted during and after the ride-along to exchange ground-level ideas and experiences about the application of lane-assist technologies in the transit areas. A public demonstration will be conducted at East14th Street for various stakeholders from Caltrans, VTA, ACTransit, Samtrans, Sacramento Regional Transit District (Sacramento RT) and Eugene LTD. The demonstration will be videotaped. The sub-tasks include:

1. Ride-along preparation and execution
2. Demonstration preparation and staging
3. Public demonstration

Task 5: Data analysis and report

After the testing and demonstrations are completed, data of the test runs on the bus performance and the ability of the system to perform its functions in regards to the comfort and safety of the passengers will be compiled and evaluated. Suggestions and comments from participants during the demonstrations will also be taken into account for any modifications or redesigning that may have to be done to the system to meet the accuracy, repeatability, and robustness requirements. A report on the system, the procedures, the details of the magnetic installation, and the testing and any such problems encountered will be documented in a written report.

Timeline:

The above tasks were performed according to the following timeline:

Table 2 Test and Demonstration Plan

	Feb	March	April	May	June	July	Aug.	Sept.	Oct.
Task 1. Infrastructure SW preparation	X	X							
Task 2. Real-world SW preparation		X	X	X	X				
Task 3. E14 testing & data collection					X	X	X	X	
Task 4. Ride along & demonstration							X	X	
Task 5. Data analysis & report								X	X

7.2 Problems Encountered and Resolutions

The demonstrations carried out for lane-assist and precision docking technologies along the East 14th street incorporated more real-life situational features than in previously conducted tests for the same technologies. As a result, there were certain problems encountered brought into play by the introduction of new factors, but with each new problem resolution, the viability of the systems in real-life applications was heightened. Previously, tests were carried out on controlled test tracks that had little to no traffic interference, but were built expressly as runways for vehicles carrying these technologies in isolated territories. These test tracks more closely resembled rail transit tracks in that they were typically flat and smooth, and lacked the unexpected but normal roadway situations that buses often have to face every day along their routes. The field tests described in this report demonstrated the earliest use of buses equipped with the technologies in a real-life environment, allowing firsthand experience of the pitfalls in the program or other factors that have gone undetected. On the other hand, experience of what went wrong granted an opportunity to set things right. The following lists the problems encountered and the methods for their resolution during the period of preparation and field testing:

Problem 1: Obstacles and disturbances along the bus route such as trees, traffic signs, and utility poles next to the docking curve around bus stops, especially such obstacles that lean toward the street and into the path of the oncoming bus.

One of the first things observed along East 14th Street was that there are many roadside objects (see Figure 24) that are located very close to the curb. These road-side objects can be trees, traffic signs, fire hydrants as well as various utility poles. When any of these objects are at the edge of curb the docking curve along East 14th Street, it is possible the right side mirror of the bus may hit one of these objects, especially when the object leans toward the street. There is at least one utility pole, road sign, or tree that is within 6 inches to the curb along each docking station. In particular, the bus right side mirror will definitely hit two objects along the East14th Street test track if the bus simply follows the planned magnetic route. The first such object is an utility pole, six inches to the curb that leans toward the street with a 1.4 degree angle, at the end of the S-curve before Station #1

(see Figure 25). The second set of objects is the pedestrian sign and the utility pole at the end of the S-curve before Station #2 next to the pedestrian crosswalk.

Since the magnetic coding has provided the exact bus location to the steering controller, a set of relatively sharp dynamic docking offsets (up to 30 cm) is created when the bus is within 7 or 10 meters of this object. The steering controller will therefore have the bus follow a specific object-avoidance trajectory and quickly direct the bus to converge to the original docking trajectory after passing this object.

Problem 2: Large and variable road crown

The second notable roadway characteristic is the relatively large lateral road angles (crowns) especially close to the curb (see Figure 27). These angles are typically not constant and change almost continuously along East 14th Street. The crown angle is about 3.2 degrees along Station #1. The Station #2 has the largest crown angle variation along the curb, causing the bus to tilt toward the right due to the 4.75 degree crown at the end of the S-curve-in, and then bringing the bus's tilt back to zero degrees when it reaches 144 Ave. However, the pitch angle of the bus will then follow the road crown of the 144 Ave as shown in Figure 27 (right figure), and the bus will immediately sink toward the right at 4.75 degrees once it is back on East 14th Street. The bus will then follow the road crown from 4.75 degrees to 4.15 degrees in a distance of about 10 meters before the bus reaches the bus stop. The bus will also experience a sudden road tilt of 3.5 degrees after it crosses Hesperian Blvd and come to a halt in the space of a bus length with a final tilt of 2.8 degrees.

Since the existing bus steering assist mechanism has 22 degrees of free play, a discrete nonlinear additive steering control command was designed to compensate for the backlash effect. The large uncertainties and “control noises” resulting from the variable road crown effect coupled with the discrete nonlinear control created large, noticeable low speed oscillations along the final docking curve. In order to correct this problem, the discrete additive steering nonlinear command was modified to a continuous additive steering nonlinear command during the final straight docking maneuver to account for both the variable road crown and the steering backlash (free-play). The overshoot oscillation during the final straight section was reduced to 2.5 cm or less after such a modification.



Figure 24 Objects Close to Curb along East 14th Street. (Station #2)



Figure 25 Utility Pole near Station #1 (right: 6" to curb; left: bus mirror next to pole when the bus is 20 cm to the curb)



Figure 26 Pedestrian Sign and Utility Pole near Station #2 (when bus is 20 cm to the curb)



Figure 27 Road Crown before Station #2 (4.75-4.15 degree); Right figure: Notice Road Crown from the Crossroad – 144 Ave.

Problem 3: Uneven road surface along docking curve

We encountered two types of uneven road surface conditions along the East 14th Street magnet track. The first type of uneven road creates control difficulties when the lateral road angle changes abruptly and that generates a large lateral force on the bus. This typically excites control oscillations such as the one resulting from the road crown changes present along East 14th Street through 144 Ave. and back to East 14th Street along Station #2 as discussed in Problem 2. The second type of uneven road encountered was the very frequent storm drains along the curb as shown in Figure 28. There is one storm drain around the end of the S-curve-in for Station #2, and one four meters before the bus stops for Station #1. A typical storm drain (1.5 m wide) forces one bus wheel to bounce up and down and thus generates a noticeable disturbance to the highly precise steering control especially along the final approach to the station.

The solution implemented for Problem 2 can also be used to increase the effective steering control gains to compensate the storm drain effect without inducing additional

oscillation. As discussed before, by modifying a discrete additive nonlinear steering command to a continuous one to account for variable road crown and steering backlash, the combined overshoot oscillation during the final straight section is reduced to within 2.5 cm.



Figure 28 Storm Drain in front of Station #1



Figure 29 Utility access cover in front of Station #1

Problem 4: In road obstacles along magnet track

Besides roadside obstacles and pavement problems, we have also encountered and addressed several kinds of possible pavement or in-pavement obstacles that relate directly to the magnetic sensing system. Those obstacles often prevent the installation of magnets according to the survey results or the ideal design (for example, 1 meter apart). The most

common pavement obstacles in East 14th Street are utility access covers (see Figure 29 for an example of a utility access cover just after the final stop for Station #1. The other utility access cover along the foot print of the magnet track is the S-curve-in of Station #3). The second kind of in-pavement obstacle that we have encountered are the loop detectors (see Figure 30 for loop detectors before 148th Ave). Longitudinal distance between magnets needs to be modified in order to install the magnet and maintain the minimum designated distance to the buried loop.

The magnetic signal processing algorithm was designed and modified to reliably process variable spacing between magnets as long as they are within specifications (0.8 – 1.2 meter). The steering control algorithm was also re-tuned to allow up to three continuously “missing” magnets by using the “observer” values of the lateral displacements. However if the system misses more than three continuous magnets, the controller will treat that situation as if it is a “restart” condition and look for the first available magnet reading.



Figure 30 Loop Detectors on the Ground (before 148th Ave)

Problem 5: Different distances between the magnet track and the docking curb/station

One likely real-world scenario is the possibility that not every magnet will maintain the exact same parallel distance to the station along the track. Among the three field test bus stations along East 14th Street, the distances from the magnet track in front of the station to the nearest upper corner of the curb were 1.395 m, 1.42 m, and 1.41 m. The main reason for these variable lengths was that the surveyors used the base of the curb rather than the upper corner of the curb as the targeted distance of 1.36 m. However during field testing, we were using the upper outside corner of the curb as the rim of the imaginary docking platform.

Since the magnetic coding has provided information of the incoming bus station to the steering controller, a stationary docking offset was encoded in the software to provide the automated bus with the appropriate offset distance before the bus reaches the docking curve. A smooth transition from the normal magnet trail to the offset trajectory (typically completed in 5 meters) was also automatically created. The steering controller will therefore steer the bus and follow a specific offset trajectory that converges to the desired lateral position as quickly and smoothly as possible. In East 14th Street, the offset distances were 3.5 cm, 6 cm and 6 cm into the curb.

Problem 6: Miss reading of magnets when bus is creeping at very low speed

One signal processing issue observed during the field testing at East 14th Street was that the signal processing algorithm sometimes missed a couple of magnets when the bus was creeping at extremely low speeds. In fact, it typically happened when the bus driver was trying to automatically pull the bus back into the traffic lane after it automatically stopped at the bus station.

The root cause of this problem resided in the signal processing algorithm. The peak detection's sensitivity to noise increases when the bus speed is close to 0 mph. We have modified the algorithm to drop the low-speed threshold to about 0.4 mph. Further improvement will be made by modifying the peak detection algorithm. In addition, the resolution for Problem 4, where the steering control algorithm was re-tuned to allow up to three continuously "missing" magnets by using the "observer" values of the lateral displacements, also helped to alleviate this problem.

Problem 7: Large oscillation and tracking error when the bus enters the docking S-curve too fast

One puzzling problem that we observed was the larger tracking errors and occasionally large oscillations when the bus speed exceeded 12 mph (a high speed for the S-curve based on the 5th order polynomial) when entering the S-curve for docking. We eventually identified the cause to be the rate-limitation (~500 degrees hand-wheel per second) of the specific steering actuator that was used for automated control. Driving the bus and following the S-curve at speeds higher than 12 mph will require moving the steering wheel faster than 500 degrees per second around the mid-point of the S-curve. To partially mitigate this limitation, we increased the maximum steering rate from 30 deg/sec to 40 deg/sec (at tire). However, the sure way to avoid this kind of dangerous situation is to remain below 12 mph while entering the S-curve. One lesson we learned here is that there is a relationship and a tradeoff among the maximum rate of the steering actuator, the sharpest curvature that the bus needs to negotiate, and the allowable maximum speed for that particular curve.

Problem 8: Steering command overshoots after the bus exits the S-curve after docking

This problem is closely related to Problem 7. Both problems have their reasons rooted in the S-curve design. The reason that the system created a steering overshoot right after the bus left the last S-curve was that the exit of the S-curve was too sharp for the bus's speed. Limiting the speed to under 15 mph right after this specific S-curve as well as designing a "softer" exiting curve would be solutions to this problem.

Problem 9: CAN bus message delay on bus speed

The fault detection program of the automated steering controller has repeatedly reported "speed fault" on several runs on a single field test day. The problem disappeared and never showed up again after we rebooted the bus system. The saved data revealed that the CAN bus speed message exhibited noticeable time delays for these few runs. The fault detection routine about CAN speed fault was then modified to allow for the control system to operate under a certain small amount of CAN speed reporting interval variations. However, the lesson that we learned is that a more sophisticated version of CAN bus monitoring protocol would be needed for future lane-assist systems.

Problem 10: Large control gain oscillation when bus travels at medium to high speeds

This problem, which is only related to the articulated bus automated steering control, occurred early on during the East 14th Street testing. Since the precision docking controller was originally designed for the 40-ft bus, the universal high-gain controller for both high-speed lane-assist and precision docking did not take the articulated portion of the bus into account. The controller was then modified and re-tuned, as indicated in Section 5.

7.3 Field Test Operations

This section describes the principles for the field test preparation, the records of the field testing, as well as the operating performance of the field testing on East 14th Street, San Leandro, CA. The detailed data analysis will be presented in the next section.

East 14th Street Field Test Preparation Principle

The most important principle for preparing the East 14th Street Field Test is "Safety First".

Under the safety first principle, the following development and testing guidelines were used throughout the period of software and control algorithm preparation and tuning for the field testing along the East 14th Street test track:

- All software modifications need to be thoroughly tested at the Richmond Field Station (RFS) test track first
- All possible parameter tuning and software variations are first conducted and evaluated at RFS test track first
- No software debugging will be carried out at East 14th Street

- All new software changes and modifications are first tested at East 14th Street at early morning hours with minimum traffic
- Normal field operations during regular hours are only conducted when all the above procedures are followed

The RFS test track was one of the best tools that prepared the buses for the field tests. All signal processing algorithms, control algorithms, and trajectory modifications (including pole and sign avoidance and docking trajectory offsets) were tested, debugged and evaluated at RFS. A minimum of 10 runs of continuous operation was conducted before any software could be tested at East 14th Street.

By gradually easing the automatic steering control system into the real-world environment, East 14th Street testing continuously presented new problems and challenges to the researchers and constantly called for re-evaluations of the current controller. Modifications were then developed and tested at RFS before being evaluated at East 14th Street again. The preparation and test iterations were the operational principle for the safe operation of this project.

Once the modified automated control system structure was finalized, all possible operational scenarios including different lane-guidance speeds, different docking speeds, stop-and-go controls, transition into and out of automation, driver overrides, and emergency shutdown were evaluated during early morning hours at East 14th Street before final field tests were conducted during normal operational hours under typical East 14th Street traffic conditions. All ride-along as well as demonstrations were conducted during normal operational hours under normal traffic conditions.

East 14th Street Field Tests Record

192 test runs with automated steering were safely conducted along the East 14th Street test track with 3 automated precision docking stations. Among these 192 runs, 96 runs had the data for whole runs saved for further analysis. Some of these data were saved and used for analyzing newly discovered problems; others were used to compare performance or effects of different tuning parameters.

For the purpose of capturing a rare problem and being able to analyze it (as a black box), and to also provide sufficient information for debugging software, the real-time automated system has only allocated certain dynamic memory to save the last 20 minutes of continuous data with a very high data rate. A typical automated bus run took anywhere between 4 to 7 minutes, with turnaround time taking 7 to 10 minutes. This was part of the reason that some data were not saved when the automated control system was continuously operated, especially during the ride-along and demonstration runs. Some other runs were conducted without stopping to save data, leaving only the last run with data saved.

Table 3 lists all the test record during the entire test period at East 14th Street.

Table 3 East 14th Street Field Test Record

Test Date	# of runs	Data saved	Tasks Accomplished	Issue Discovered
01-18-2008	4	3	Baseline system tested. Magnet installation validated.	System would require pole and traffic sign avoidance along docking curves.
02-08-2008	5	3	Decoder evaluated without preview implementation.	Decoder reset was not function correctly.
02-15-2008	12	12	Decoder validated with preview control implemented.	Reconstructive data was collected for further signal processing evaluation.
03-12-2008	7	7	Pole/Sign avoidance tested using avoidance trajectory with discrete nonlinear additive gains.	Medium/high speed steering control exhibited oscillation. Missing magnet detection was observed during bus creeping forward at very low speeds.
03-17-2008	8	5	Station offset implemented. Magnet detection signal processing speed lowered. Low speed control improved.	Bus occasionally moved back toward station while leaving station. Magnet track distance to curb varied up to three cm.
03-26-2008	7	5	Variable station offset implemented. Automatic dynamic station-exiting offset implemented	Speed fault discovered. Final docking approach accuracy exceeded 2.5 cm with oscillation at over 8mph final docking speed.
04-07-2008	4	2	CAN speed message fault detection validated. Extension of speed delay tolerance implemented.	
04-24-2008	12	6	Continuous additive gain implemented for final approach. Stop-and-go control validated. Higher docking speed control validated.	Larger tracking errors and steering oscillation observed when bus speed exceeded 12 mph entering the S-curve.
05-01-2008	15	10	Various operational speed scenarios including stop-and-go during docking tested. Steering actuator rate limitation impacts validated.	High speed tracking errors exhibited higher STD then previous results. Occasional large steer overshoots were observed immediately after the exiting S-curve.
05-30-2008	10	1	Reduced high speed angle gain	Occasional large steer

			implemented. Various speed scenarios re-tested. Various transitioning methods (including driver steer override) between automated control and manual steering tested.	overshoots were still observed immediately after the exiting S-curve.
06-11-2008	9	0	Various driver steering override and emergency shut-down practiced. Various designated automated driving scenarios final validated. Exiting docking curve trajectory modification tested.	Occasional large steer overshoots were still observed immediately after the exiting S-curve.
06-20-2008	14	2	Exiting S-curve trajectory softening implemented. Continuously run for robustness evaluation conducted. First normal-day operation conducted.	Frequent stop-and-go during Station #2 observed.
07-23-2008	13	9	Design, as well as system and control gains finalized. Field test during normal operational environment conducted.	Frequent stop-and-go during Station #2 observed. Occasionally transitioning to manual control in mixed traffic situation was an operational necessity.
08-14-2008	24	18	All day field test runs conducted. Internal demonstration with PATH, Caltrans, UCB, and AC Transit conducted.	
08-28-2008	17	2	Half day continuously field test run (w/o stopping or data saving) conducted.	
09-05-2008	15	3	Media event conducted. Transit (VIP) ride along conducted.	
09-23-2008	16	8	3/4 day field testing conducted. One media event conducted.	
Total #	192	96	Total test runs at East 14 th Street	
Final Gains	95	35	Field tests with the final system/control gains	

East 14th Street Lane-Guidance and Precision Docking Field Test Operations

The automated steering control system for the East 14th Street field testing was finalized on July 23, 2008. Ninety-five runs were conducted after the system was finalized and under the normal bus operational environment. Among these runs, 35 runs had the complete runs saved for further analysis. Data analysis will be presented in next section. This section covers the operational accomplishments during this period.

Before January 2008, the following technical preparations were performed in addition to the route selection, track design and magnet installation on East 14th Street: baseline control and safety system examination and improvement development, transition control design and evaluation, development of the modified control system for the articulated bus, steering actuator function evaluation, as well as fault detection system review.

The magnet installation was validated and basic modifications with respect to the East 14th Street test track (coding and de-coder design) were completed between January and February, 2008.

The iterations of the following automated maneuver functions were successfully conducted between designing and debugging at RFS and evaluations at East 14th Street: static trajectory planning for roadside objects, dynamic trajectory planning for exiting station, docking offsets based on station location and magnetic coding, missing magnet control using observer, continuously additive nonlinear steering control for compensating large road crown and uneven surface, multiple methods for transitioning between automatic control and manual steering, stop-and-go and bus creeping precision steering control, as well as CAN message fault detection.

Final field testing under normal day-to-day bus operational environment (without paid passengers) with the same system were successfully conducted between July and September, 2008 including a ride-along transit demonstration and two media events. No controller failure has occurred since the start of the testing in February 2008.

A few important real-world lessons were learned during this period of real-world operations:

- Stop-and-go, as well as the bus inching forward at extremely slow speeds are an important real-world operation mode for BRT, especially under mixed traffic conditions
- Irregular road surfaces such as various road crowns, pot holes and storm drains are important distinctions between a true “rail” system and the “electronic rail” system. Such irregularities will likely require large and smart nonlinear control to compensate if high precision is required
- Easy and multiple methods of transitioning from automated control to manual control is a must, especially under mixed traffic conditions
- Detecting multiple magnetic tracks will facilitate “track transition”

- Virtual docking trajectory will facilitate more flexible docking operations

Figure 31 shows the precision docking performance at Station #1. It can be observed that (1) the bus leans toward the curb-side because of the road angle, (2) the utility pole behind the bus is clearly in the way of the bus mirror and a collision would occur if there is no “pole avoidance” technique, (3) the bus is perfectly parallel to the curb. In fact, many personnel from transit agencies commented on how quickly the articulated bus could pull itself straight in such a short distance (a couple of meters longer than the bus length). Finally, a metal utility access cover is clearly identified in front of the stopped bus where a magnet was not installed along the bus docking station. No performance variation was observed during the field test period.

Figure 32 and Figure 33 illustrate the precision docking performance at automated docking Station #2. Figure 32 exemplifies the difficulties for real-world precision docking from many possible sources. When the automated bus reached the final part of the docking S-curve, the front wheel would first pass through several uneven road surfaces including the corner of the storm drain before the bus leaned (at 4.75 degree) toward the East 14th Street curb as marked in Figure 32. The bus then had to rise and level up as it passed the narrow 144th Ave with its own road angles. Right after 144th Ave, the bus then immediately tilted back toward the curb again (first at 4.75 degrees and then 4.15 degrees) following the road crown of the East 14th Street. In between these uneven road surfaces, the bus had to negotiate to avoid hitting the mirror on the sign and pole, and came to a quick complete stop, parallel to the curb as shown in Figure 33.

Figure 34 shows the precision docking performance at Station #3. Similar to those from Station #1 and Station #2, it is clear that the bus was again a parallel to the docking curb after an S-curve lane change. As indicated in the figure, the front distance between the edges of the front door to the curb was about one cm.



Figure 31 Station #1 Precision Docking Performance



Figure 32 Station #2 Docking Precision Performance (Uneven Road Surfaces)

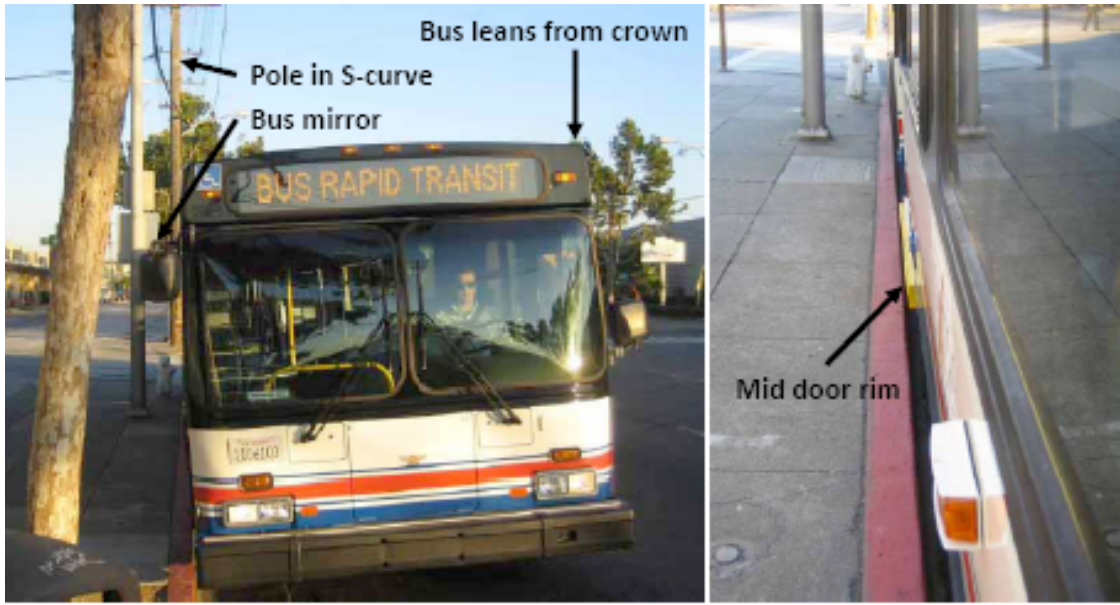

Figure 33 Station #2 Precision Docking Performance



Figure 34 Station #3 Precision Docking Performance

7.4 Demonstrations

The public demonstration served several purposes. Firstly, the successful public demonstration under a real-world operation setting with live traffic and a much more difficult (from control technology point of view) yet popular transit vehicle, a 60 ft articulated bus, shows the maturity of the technology and marks another great step toward

the field operational testing. Secondly, showcasing the technology under real-world operation settings to the audiences from government agencies, public transit agencies and local city planners will promote the adoption of the technology in the future. Thirdly, presenting the technology to the mass media will build interest and support among general public for the future deployment.

Demonstrations were conducted on both September 5, 2008 and September 23, 2008. During the first day of demonstration, several demonstration runs along East 14th Street were provided to the media reporters from different television stations and papers first. A partial collection of media reports can be found in Appendix D. A press release was issued by University of California at Berkeley as in Appendix E. Demonstration participants from government agencies, public transit agencies and local city management were divided into several groups to experience the sensations of riding along on the bus. A detailed list of demonstration participants can be found in Appendix C.

Following the demonstration, a workshop was held beginning with the introduction of VAA technology by Wei-Bin Zhang from California PATH. A discussion on the VAA technology was carried out after the introduction. Following their experience of the first public demonstration of VAA technology on a 60 ft articulated bus in a real-world operation setting, most participants, especially personnel from public transit agencies felt very excited about the potential applications of this technology in their BRT route. Many were very enthusiastic and hoped to include the VAA technology in their future BRT route planning and construction. They generally agreed with the benefits that VAA technology could provide as listed in the Appendix F and were surprised by the superior performance shown by the 60ft automated bus on a public street in live traffic. They also brought out some other benefits such as increasing the property value along the BRT route with VAA technology. They raised some questions regarding the reliability and robustness of the technology, the construction and the maintenance of the magnetic tracks and platforms, driver training and cost/maintenance of the VAA vehicles. Although some questions can be answered by this demonstration, some of them can only be answered by future field operational tests.

In summary, this successful demonstration really impressed audiences with different backgrounds and showed the maturity of VAA technology developed by PATH. The responses from the audiences were very positive. Most people from public transit agencies wanted to include VAA technology in their planning of future BRT route. They did raise some questions which can only be answered after a field operational test. Therefore, it is the perfect time to continue the development of VAA technology and start the field operation test project sponsored by FTA and Caltrans.

8 Data Analysis and Evaluation

One hundred and ninety two test runs with automated steering were safely conducted along the East 14th Street 0.9-mile long test track with three automated precision docking stations between Feb.-Sept. 2008. After the automated system was finalized on July 23, 2008, ninety five runs were conducted on five different days, each with runs from 12 to 24, under the normal bus operational environment including transit ride-along and demonstration. Among these field test runs, thirty five runs had complete data saved for further analysis. Data analysis of these 35 data sets will be presented in this section.

8.1 Single Run Data Examination

In this section, data of two field test runs are presented to help explain how the automated system was operated and performed during the field tests. Figure 35 shows the time traces of the front and rear lateral positions, vehicle speed, as well as the status of the LED lights and that of the auto/manual toggle switch for one automated test run on the East 14th Street on August 14, 2008. The time “0” corresponds to the time when the bus detected the first magnets right before 139th Ave. at 10:46 a.m. and the traces ended just before 150th Ave. at 10:52 a.m.

As shown in Figure 35, the green LED was lit indicating that the automatic system was ready for transition almost immediately when the bus detected the first magnets; the driver switched to “auto” at about two seconds after the first magnet detection and the blue LED lit immediately showing that the system state has become “automated”. The bus then followed the magnetic track, approaching the Station #1 under automated steering control. At about three seconds before the bus arrived at the designated bus stop, the blue LED blinked with short beep sounds informing the bus driver of the final stop location. The bus stopped at the Station #1 for 33 seconds before automatically leaving the station. The bus came to a stop for the traffic light at 143rd Ave for three seconds and then followed the magnets to the docking curve of Station #2. The bus was under steering control at all time between these two stations with the lateral tracking error never exceeding 10 cm. After a 19-second stop at Station #2, the bus continued under automated control until time=194.5 sec when a bicyclist was on the lane and the driver overrode the steering control by first grabbing the steering wheel to the left, followed by the driver manually switching off the automated control. The driver switched back to automated control at time=203 sec. by simply pushing the toggle switch to “auto”. Between time=194.5 to 203 sec, the green LED was always on, indicating that the driver can transition back to “automatic” at any time. It is worthwhile to notice that the vehicle trajectory was smooth before and after the manual/auto transition. The bus again continued under automated steering control to Station #3, and stopped for 8.2 seconds at the traffic light before Bancroft Street. The alarm sounded with short beeps to alert the driver before the bus reached 150th Ave where the magnet trail ends. The driver switched off to manual control at time=306 sec.

Figure 36 - Figure 38 plot the lateral positions, errors, angles, and speeds with respect to the magnet numbers; since the magnets are embedded one meter apart, the x-axis can also be interpreted as the longitudinal displacement in meters. The data are automatically synchronized to facilitate easy comparisons when we elect to use the magnet numbers as the x-axis. The first designated magnet is numbered at -5 and the last number is 1267.

In addition to the front bus positions based on the measurements of the magnetometers, Figure 36 shows also the locations of the magnetic track, as well as both the static and the dynamic trajectories that the bus would follow. The first type of static trajectories as indicated in Figure 36 create object avoidance trajectories for utility or light poles (magnet #95-112 for Station #1 and magnet #403-419 for Station #2), or traffic signs (magnet #403-419 for Station #2). The second type of static trajectories is docking station offsets that compensate for individual station's curb locations. The first dynamic trajectory observed is from magnets #12 to #80 that facilitated smooth transition from driver manual steering to automated steering control. The second such dynamic trajectory (between magnet #697 to #800) is the one that supported smooth transition right after the driver switched back to automatic control after the avoidance manual maneuver for the bicyclist on the lane. One more type of such dynamic trajectory marked in Figure 36 is the dynamic trajectory offsets for automatically leaving the station without the rear hitting the curb or the platform. Such offset (6 cm) will be automatically generated after the bus has stopped at the station, and it will taper down shortly after entering the exit S-curve. Finally Figure 36 also indicates a complete stop before the Station #2 for pedestrian.

Figure 37 illustrates the front and rear positions based on the magnetic sensors' reading as well as the front bus vehicle angle computed by these two measurements. It is interesting to note that the vehicle angles quickly converged to 0 degree (-0.08 degree for Station #1, -0.01 for Station #2 and -0.015 for Station #3) once the bus completed the first S-curve for docking in the straight sections. Because of the object-avoidance trajectories, the initial bus vehicle angles in the final straight section were bigger for Station #1 (-3.7 degree) and #2 (-3.4 degree) than that from Station #3 (-2.1 degree). However, the vehicle angle quickly reduced to 0 (bus parallel to curb) in a relatively short distance (17 m for Station #1, 14 m for Station #2, and 14 m for Station #3). They are all shorter than the length of the articulated bus (~18.5 m).

Figure 38 shows both the steering commands and the resultant steering angles (as well as those when the steering wheel was controlled by the driver). The largest steering angle at hand wheel was around 250 degrees and occurred during the S-curves of Station #2 because it has the sharpest docking curves due to the shortest available space around that bus stop. The only "high-frequency" control occurred at the last 15 meters along the curb before the station (platform). The typical steering commands during lane-guidance between stations were less than 25 degrees with the total steering free-play of 22 degrees.

The steering angles remained smooth from automatic to manual transitions; and the manual override by the driver is observable at around magnet #627.

Similar to Figure 35, Figure 39 shows the time traces of the front and rear lateral positions, vehicle speed, as well as the status of the LED lights and that of the auto/manual toggle switch for one automated test run on the East 14th Street on August 14, 2008. The time “0” corresponds to the time when the bus detected the first magnets right before 139th Ave. at 1:59 p.m. and the traces ended just before 150th Ave. at 2:04 p.m. The performance in Figure 39 is also very similar to that in Figure 35. The only difference is that the driver turned off the automated control and made a complete lane change to avoid a double-parked delivery truck at time=230 to 244 sec; and the green LED was off from time=233 to 240 sec when the magnets were outside the bus sensor range.

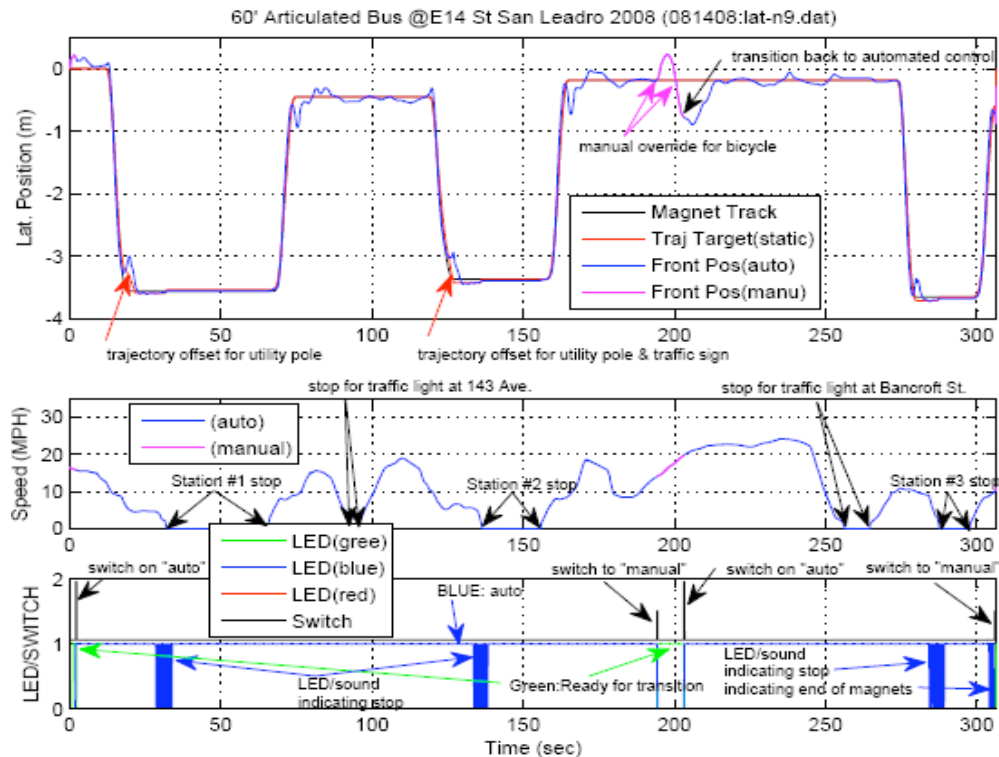

Figure 35 Single Run Example, Time-Based (avoiding bicyclist): front position, speed, LED, switch

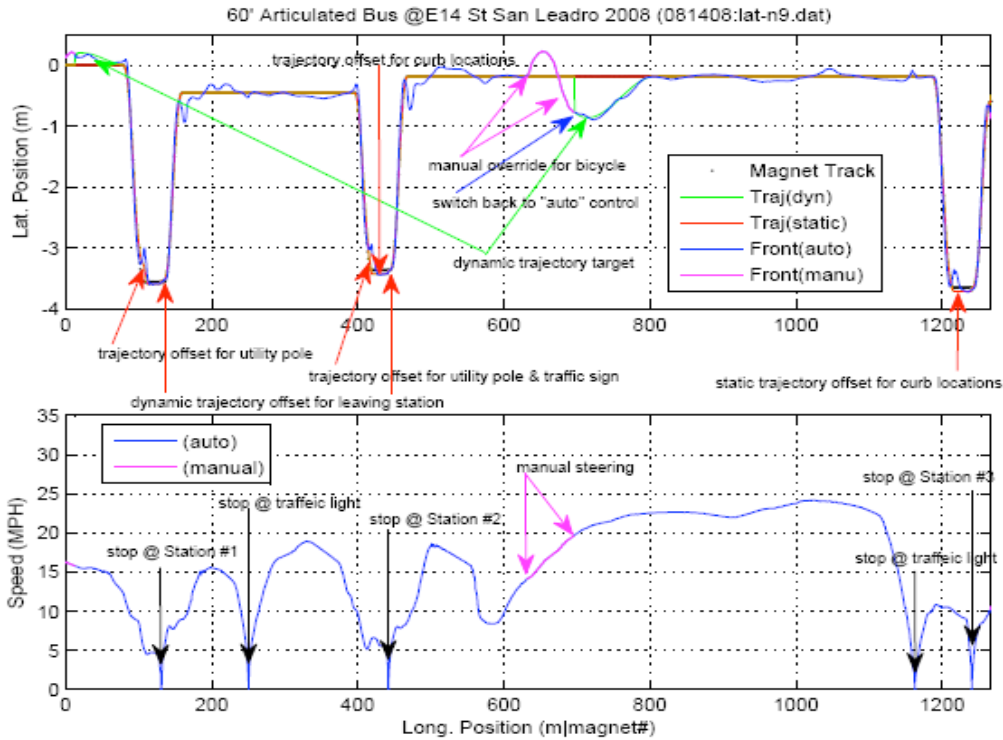

Figure 36 Single Run Example, Magnet-Based (avoiding bicyclist): front/rear position, speed

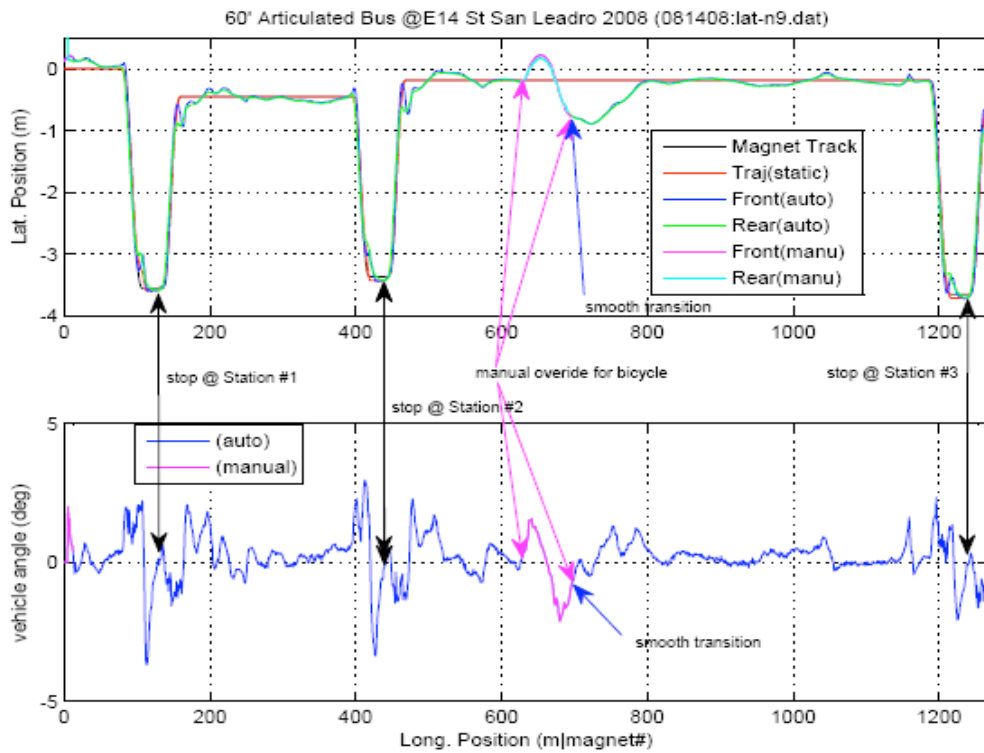

Figure 37 Single Run Example, Magnet-Based (avoiding bicyclist): position, vehicle angle

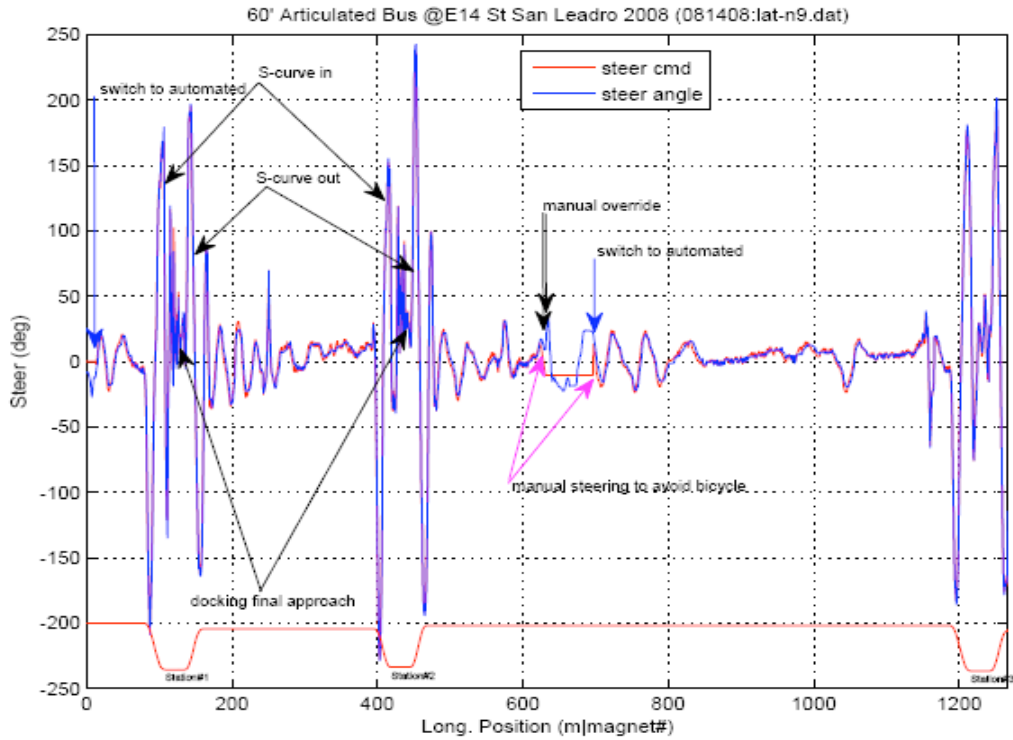

Figure 38 Single Run Example, Magnet-Based (avoiding bicyclist): steering angle/command

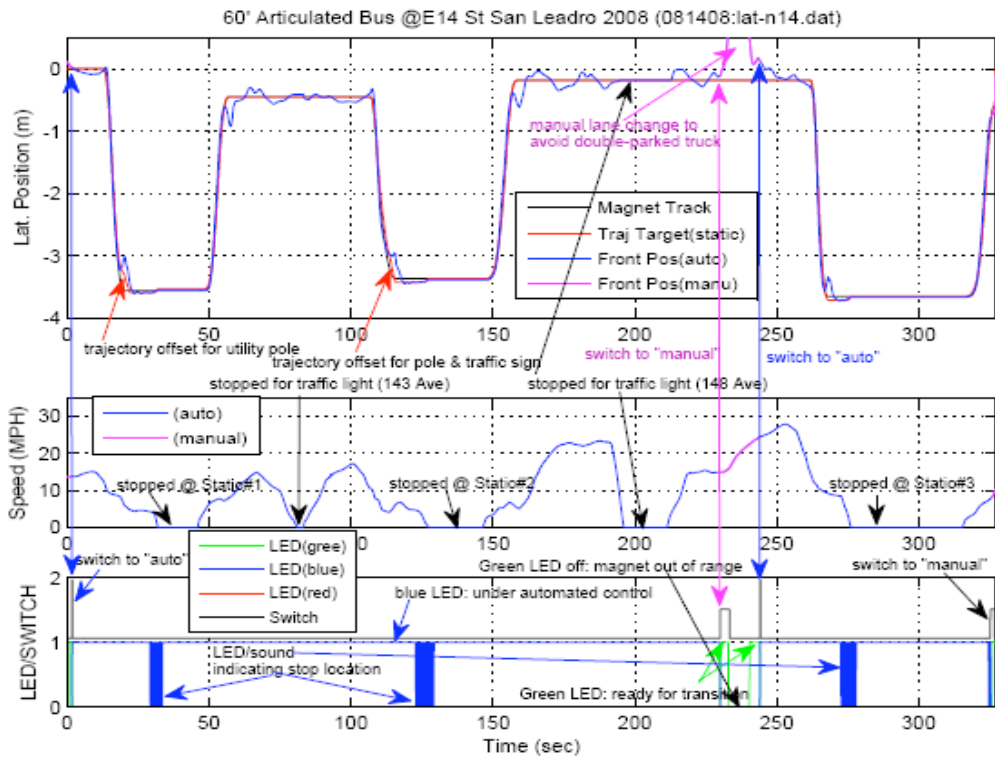

Figure 39 Single Run Example, Time-Based (lane change): front position, speed, LED, switch

8.2 Lane-Guidance Data Evaluation for ALL 35 Field Test Runs

The final field tests were conducted under normal East 14th Street daytime conditions using the same control system after it was finalized on 7-23-2008 with a total of 95 runs on five different days. 35 runs out of the total 95 had data saved for further analysis. This section presents plots that combined all those 35 sets of data; and all figures use magnet numbers as the x-axis so that all the information is on the same scale for easy comparison. We are focusing on the lane-guidance performance in this section; the precision docking performance will be evaluated in the next section.

Figure 40 identifies the locations of the magnetic track, the static and the dynamic trajectories, and the front bus positions (under automatic or manual control). Figure 41 adds rear bus positions (rear sensor bar roughly under the middle door) that basically followed the front positions but typically with somewhat smaller magnitudes. The explanations of the static and dynamic trajectories are the same as those given for Figure 36. It is clear that, when the bus was not executing the S-curve precision docking, the bus positions tracked the magnetic track very well except either when driver steered manually or during the transition process from manual to automatic control.

Figure 42 illustrates further the tracking errors between the desired trajectories and the front bus locations. After combining all the tracking errors from all 35 sets of data, the tracking error standard deviation, when the bus is under automated control, is 10.52 cm. The STD of the tracking error became 7.2 cm when we exclude all tracking data under S-curves. It is therefore fair to access that a typical value of the lane-guidance performance for the East 14th Street field test system is under 7.5 cm. (excluding S-curve maneuvers).

Figure 43 plots all resultant vehicle angles from all 35 data sets with respect to the magnetic track. It is also clear that the vehicle angle followed the magnetic track very well (within one degree) except during the S-curves, or except when either the driver steered manually or the controller transitioned from manual to automatic control.

Figure 44 shows the vehicle speeds from all 35 sets of data. The stops at the three docking stations can be clearly identified in the figure. In addition, the stops for the traffic lights at 143rd Ave, 148th Ave, Bancroft St, and 151st Ave are also visible. As a first impression, the speed variations were likely more complicated and more unpredictable than those from a typical “rail” system. The speeds varied from 0 to 33 mph under normal conditions with a significant number of stop-and-go scenarios. By referencing to Figure 41 and Figure 42, no consistent automated tracking characteristics variations are observable due to the speed variations. It is also quite clear that Station #2, with its pedestrian crosswalk and the frequent 144th Ave vehicular traffic, exhibited the highest speed variations with the lowest average speeds among the three stations.

Figure 45 illustrates the time elapsed from the moment the system detects the first magnet till the last magnet on the track of all 35 runs. The fastest run lasted 221 seconds; all but 6 runs took less than 327 seconds. Three of these 6 runs were ride-along runs where participants were outside the bus measuring or inspecting the docking performance. The slow-down (smaller slopes) between the pedestrian walkway and 144th Ave are also visible in the plot.

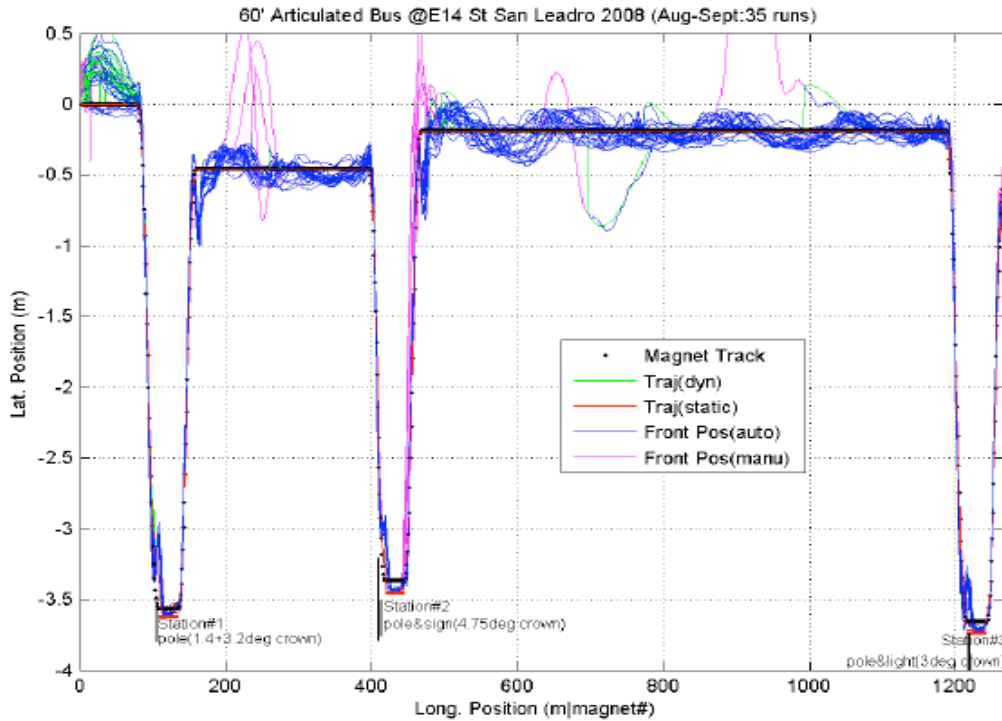

Figure 40 Lateral Positions and Trajectory (35 Field Test Runs) Magnet-Based

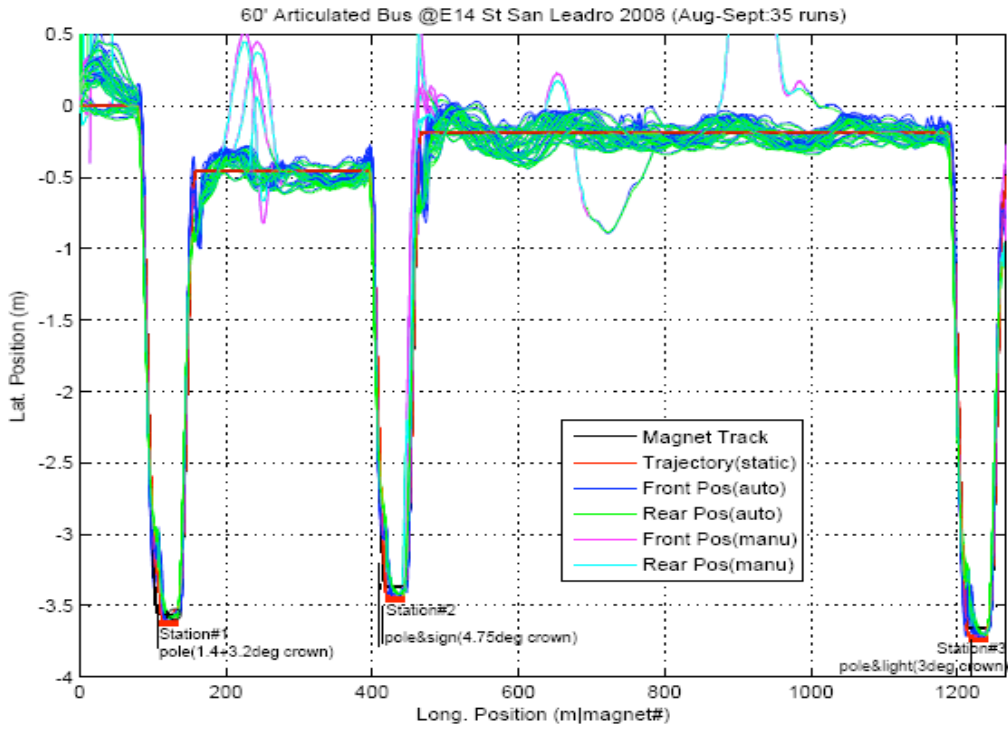

Figure 41 Front/Rear Lateral Positions (35 Field Test Runs) Magnet-Based

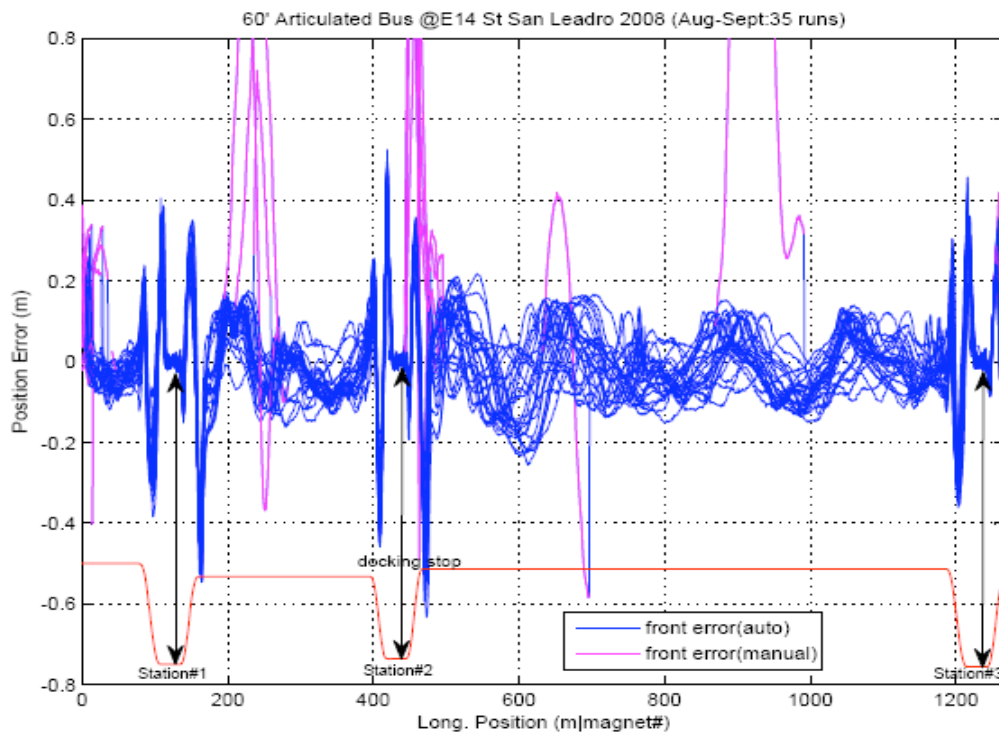

Figure 42 Lateral Position Errors (35 Field Test Runs) Magnet-Based

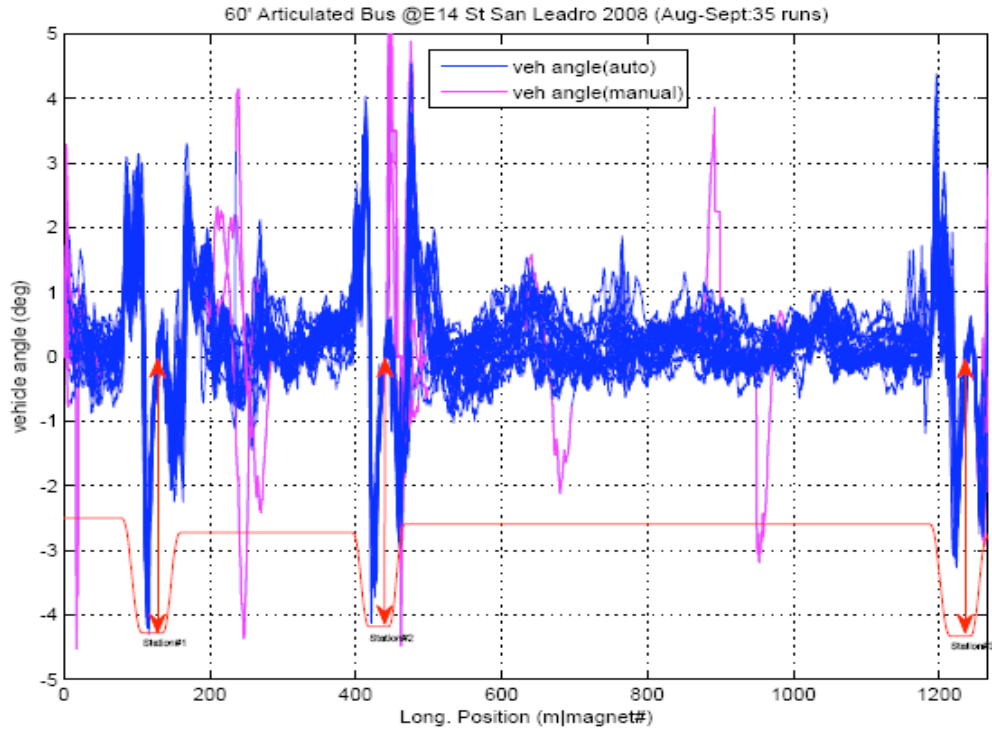

Figure 43 Vehicle Angle (35 Field Test Runs) Magnet-Based

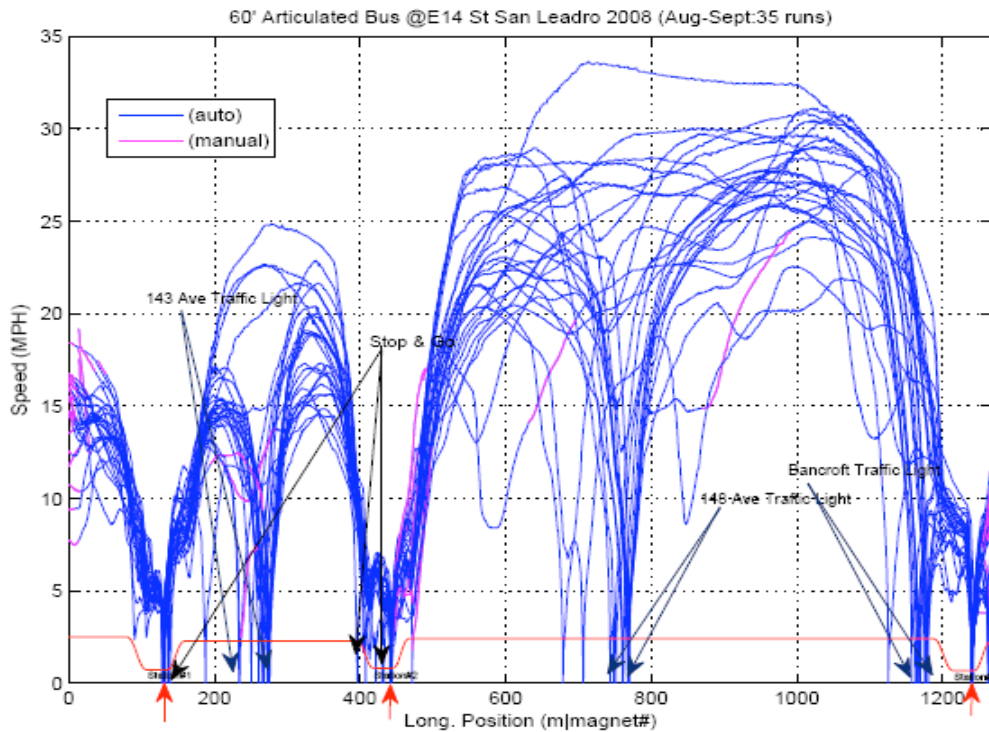

Figure 44 Speed (35 Field Test Runs) Magnet-Based

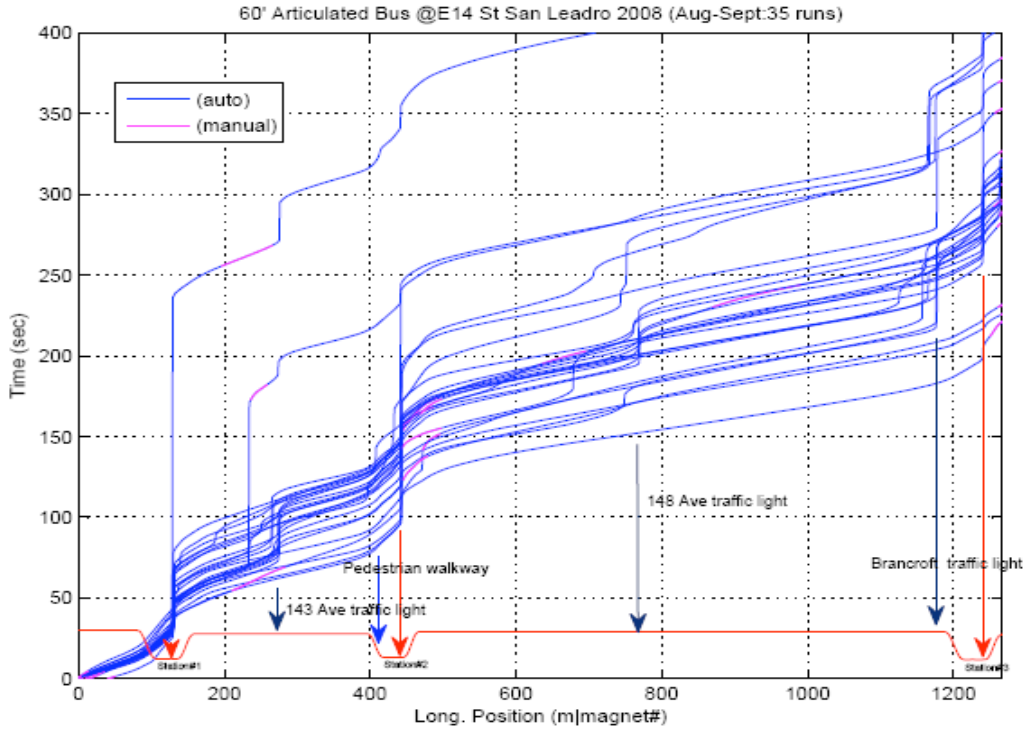

Figure 45 Time from Track Start (35 Field Test Runs) Magnet-Based

8.3 Precision Docking Data Evaluation for All 35 Runs

This section plots the precision docking performances for all 35 recorded runs for the final field test system along the 3 automated docking stations. All figures use magnet numbers as the x-axis to facilitate automatic synchronization for easy comparisons.

Figure 46 shows the locations of the magnetic track, the target trajectories, as well as the front and the rear bus positions (under automatic or manual control) during the bus docking to Station #1. It is clear that the repeatability of the docking performance is good and the bus has never once touched the docking curb during all these runs. The utility pole in Figure 46 is located at the end of the first S-curve at magnet #106. In the plot, the pole location has included the effect from the road crown at the height of the bus mirror. The pole leans toward the street at an angle of 5.6 degrees at the height of the bus mirror, where 3.2 degree of the 5.6 degree angle is attributed to the road crown. By comparing the target trajectory to the magnet track, it is easy to see that the maximum distance (30 cm) between the magnet track and the target trajectory occurs at magnet #106. Furthermore, the distances between the front bus locations of all those runs and the utility pole as indicated in the figure were at about 22 cm; and this space thus provided a ~20 cm safe distance between the mirror and the pole. In fact, the mirror would have hit the pole if there had been no pole avoidance maneuver designated. In addition, the storm drain as well as the utility access cover appeared to have little effect on the docking performance. A 6-cm trajectory offset after the bus has stopped was also visible in the figure.

Figure 46 further illustrates the docking errors between the desired trajectories and the front bus locations. The standard deviation of the tracking error when the bus was at the final approach to the docking station (~magnet #115-#130) after aggregating the 35 sets of data is 0.98 cm. The STD of the tracking error at the bus stop is 0.6 cm.

As shown in Figure 47, the pedestrian sign and the utility pole are located near the end of the first S-curve starting at magnet #414. By comparing the target trajectory to the magnet track, the maximum distance (20 cm) between the magnet track and the target trajectory occurs at magnet #414. Furthermore, the distances between the front bus locations and the utility pole and sign as indicated in the figure were at about 40 cm; and this space thus provided a 40cm safe distance between the mirror and the pole. In fact, the mirror would have just barely missed the sign had there been no sign avoidance static offsets. Similarly, a 6-cm trajectory offset after the bus has stopped was also visible in the figure. Not only did the bus avoid these obstacles, it has also never touched the docking curb during these test runs. Furthermore, the standard deviation of the tracking error when the bus was at the final approach to the docking station (~magnet #426-#439) from all 35 sets of data is 1.0 cm. The STD of the tracking error at the bus stop is 0.69 cm. The driver had switched off the automatic steering control for 4 of the 35 runs because of a parked car that was too close to the exiting S-curve.

Figure 48 shows the standard deviation of the tracking error when the bus was at the final approach to the docking station (~magnet #1225-#1240) from all 35 sets of data is 1.22 cm. The STD of the tracking error at the bus stop is 0.76 cm, demonstrating the good repeatability of the docking performance.

Figure 49, Figure 50 and Figure 51 illustrate the resultant vehicle angles computed from the front and rear positions. It is interesting to notice that the initial vehicle angles were relatively large when the front end of the bus first reached the straight-line section of the docking curve (#113-116 at ~4.2 degree for Station #1; #424-428 at -3.5 degree for Station #2; and #1219-1224 at ~-3 degree for Station #3). Due to the object-avoidance trajectories, these initial bus vehicle angles were generally bigger for Station #1 and #2 than those from Station #3. However, the vehicle angle quickly reduced to virtually 0 degree (bus parallel to curb) in a relatively short distance (~16 m for Station #1, ~14 m for Station #2, and ~15 m for Station #3). They are all shorter than the length of the articulated bus (~18.5 m). The means of the final vehicle angle at the bus stop were 0.09, 0.22 and 0.06 degrees, with the associated STD of 0.15, 0.10 and 0.23 degrees, for Station #1, #2, and #3, respectively.

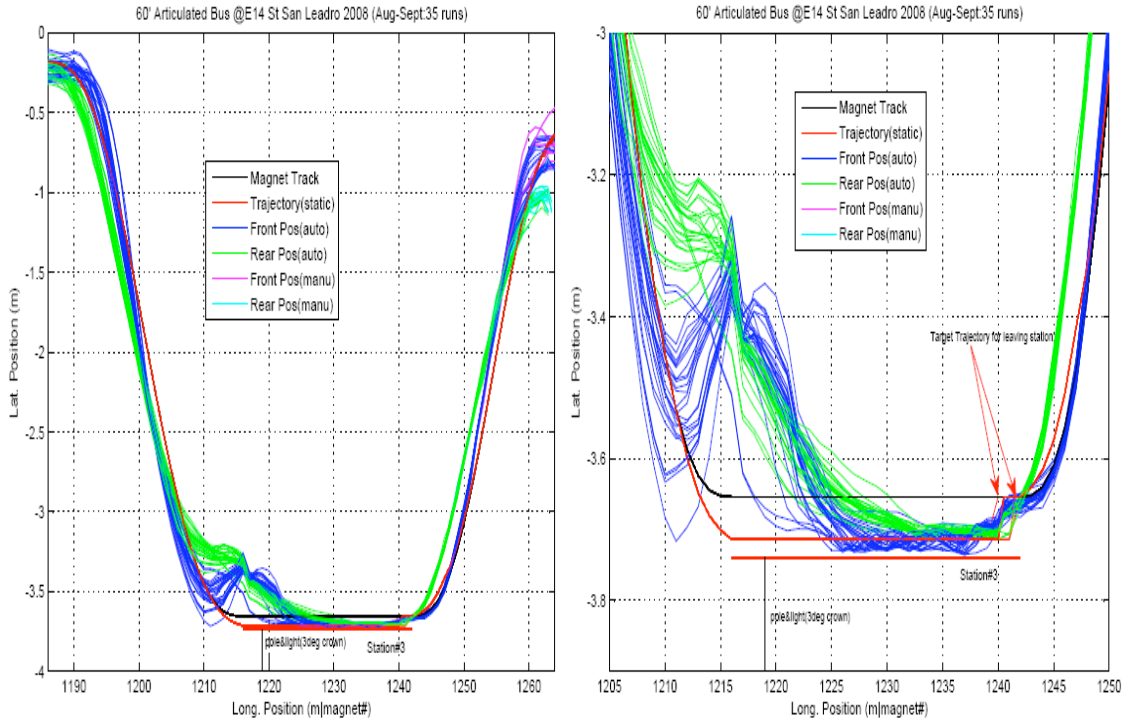

Figure 48 Lateral Positions at Station #3 (35 Field Test Runs) Magnet-Based

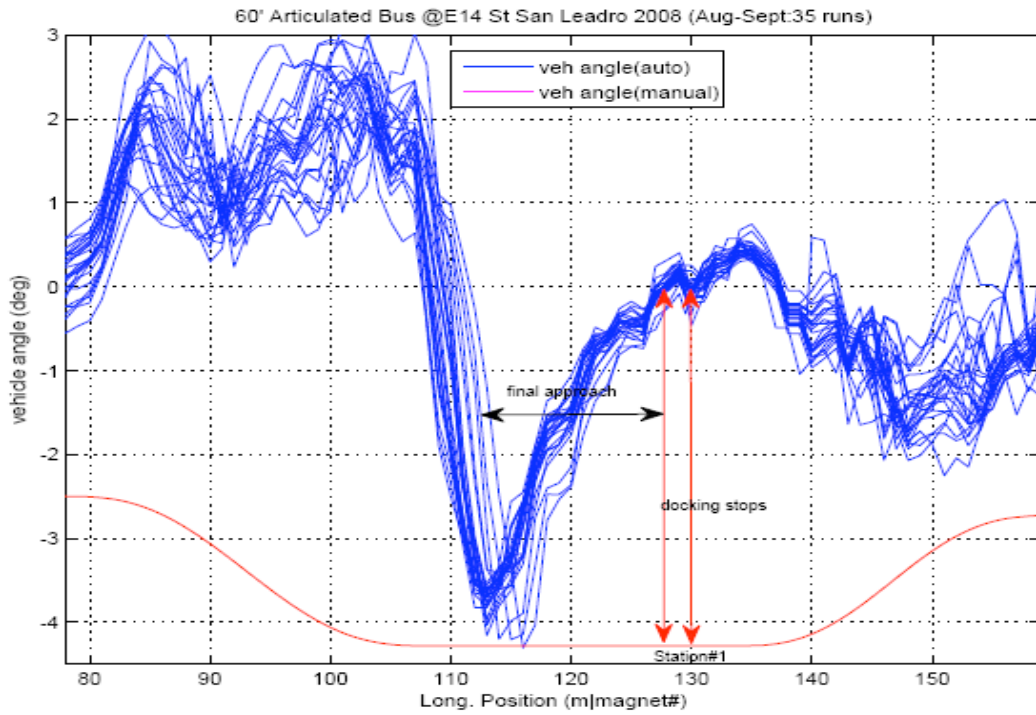

Figure 49 Vehicle Angles at Station #1 (35 Field Test Runs) Magnet-Based

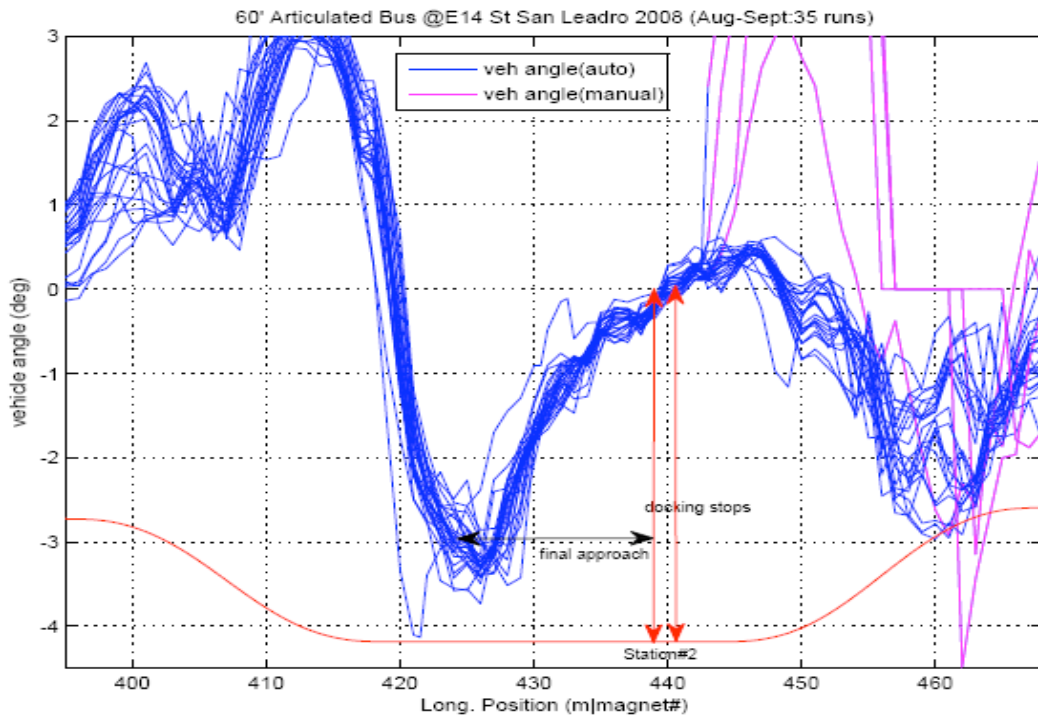

Figure 50 Vehicle Angles at Station #2 (35 Field Test Runs) Magnet-Based

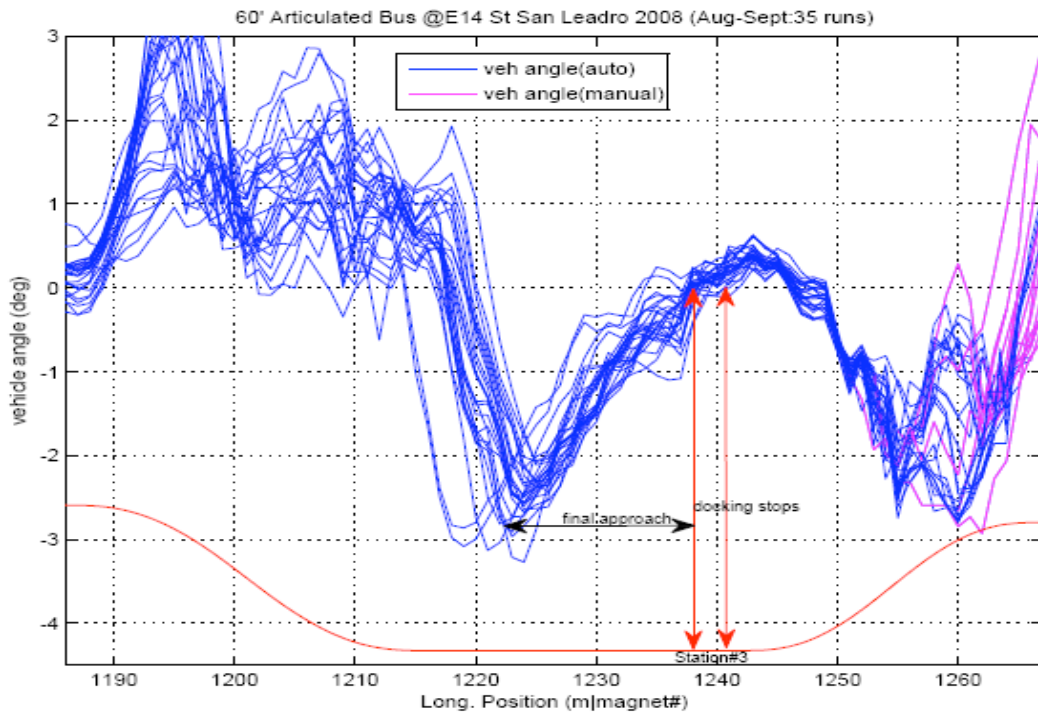

Figure 51 Vehicle Angles at Station #3 (35 Field Test Runs) Magnet-Based

8.4 Manual Override and Stop-and-go Control

The purpose of this section is to highlight two important operational capabilities a real-world lane-assist system should have: simple and robust driver override capability and transparent and reliable stop-and-go capability.

Out of the 35 field tests data sets, 10 of those runs (almost one in three) involved driver interference where he or she either turned off or overrode the automatic steering control and manually steered the bus to avoid some specific obstacles on the “track”. In all those situations, the driver switched back to automatic control successfully once the obstacle was passed. Figure 52 plots the front locations as well as vehicle speeds of these 10 runs that involved 11 transitions from automated to manual steering to avoid roadway obstacles. Twice the driver switched off the automatic system and steered left about 3 feet to give way to a utility truck parked by the roadside. The driver also overrode the automatic system (by forcing the hand wheel) once for a garage truck. Four times the driver switched off after docking at Station #2 and manually pulled out from the station because of a car parked too close to the magnetic track. As explained in Figure 35 and Figure 36, the driver overrode the automated system to pass a bicyclist on the lane, and finally as described in Figure 39, the driver switched off and made a lane change for a double parked delivery truck. In all 11 times, the switching off and on resulted in smooth transitions in and out of automated control.

Figure 53 illustrates the vehicle speeds under automated steering control around Station #2, the shortest Station with a pedestrian walkway and a narrow cross street (144th Ave) right before it. It is clear that the driver generally slowed down (to about 5 mph) for the pedestrian crosswalk as well as for the cross street, which does not have traffic lights. 3 times the bus either stopped or almost stopped for a pedestrian to cross at the crosswalk. The driver did an emergency stop for a car coming out of 144th Ave once, the only such hard brake maneuver during the entire field test period. The bus also slowed down 3 times around the fire hydrant, one time for a pedestrian/passenger standing too close to the curb.

Figure 54 shows the vehicle speeds under automated steering control around Station #3, the longest Station with the widest cross street (Bancroft St/Hesperian Blvd – with traffic signals) before it. Compared to the more complicated environment surrounding Station #2 (Figure 53), the approaching speeds were noticeably higher for docking at Station #3 (final approach typically 6-9 mph) than those for Station #2 (final approach at 4-6 mph). The bus driver rarely significantly slowed down until the bus reached the final stop.

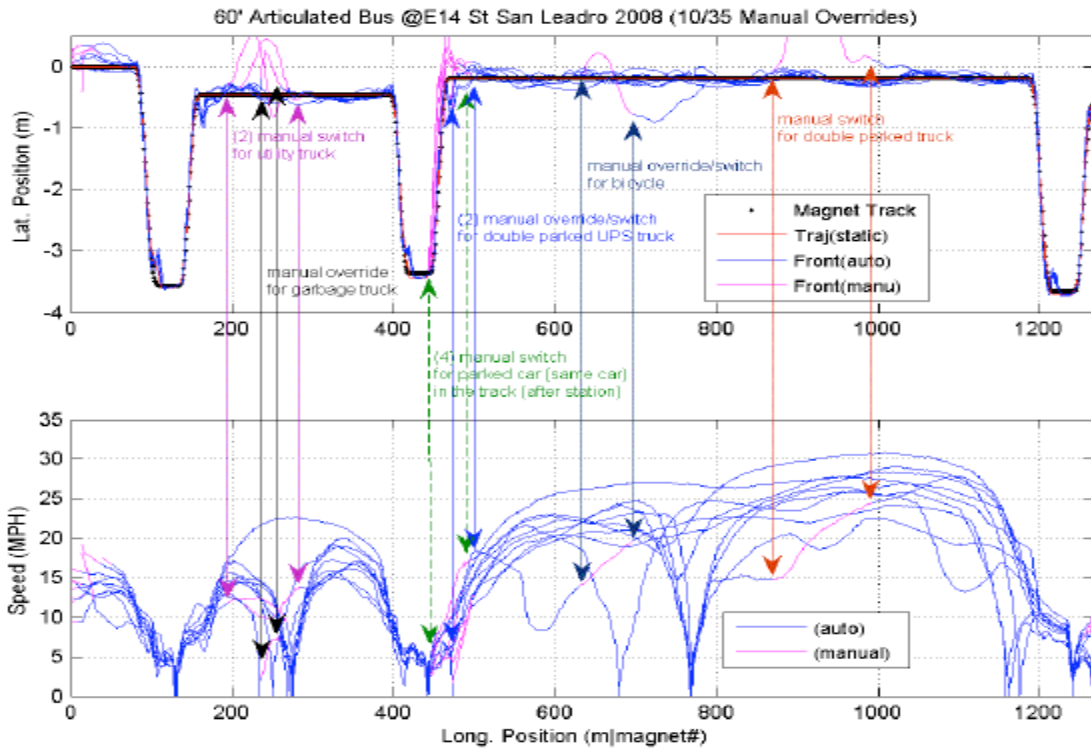

Figure 52 Manual Override or Switching to Manual Steering (10 Field Test Runs) Magnet-Based

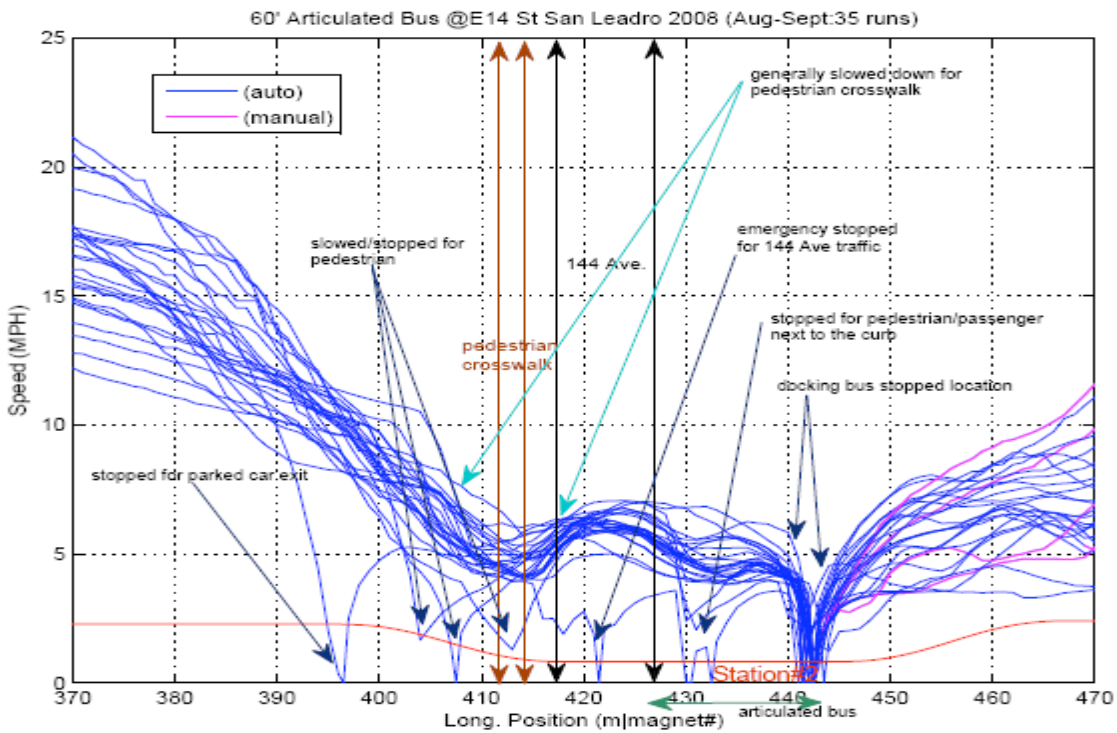

Figure 53 Vehicle Speeds at Station #2 (35 Field Test Runs) Magnet-Based

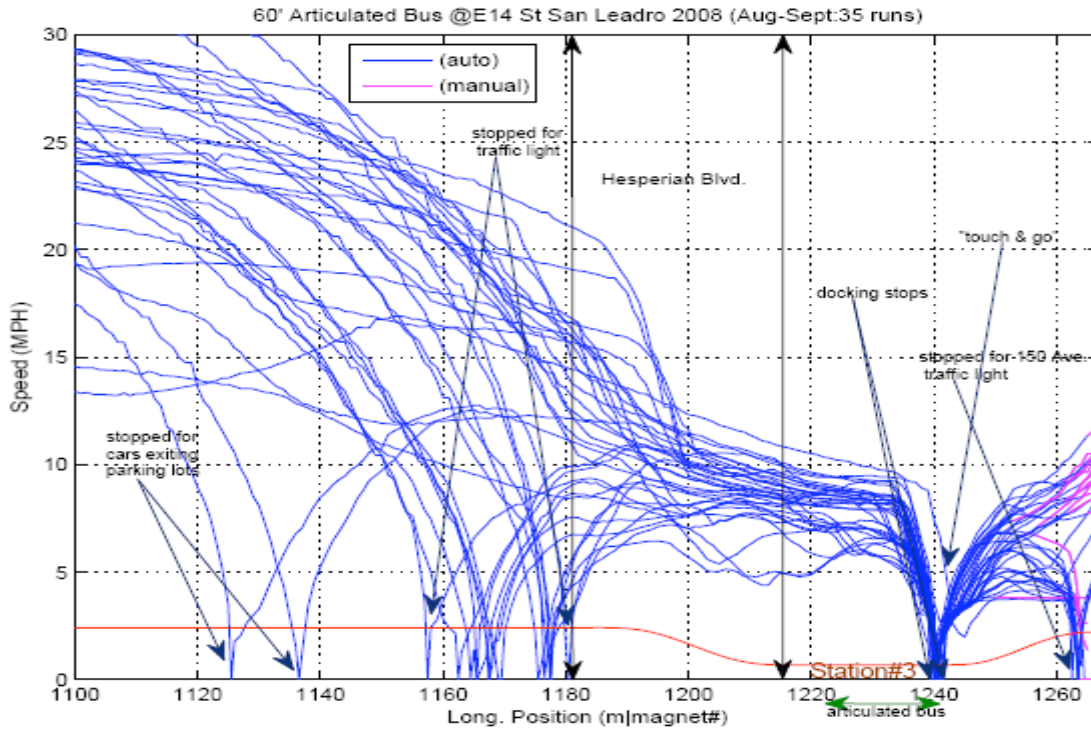

Figure 54 Vehicle Speeds at Station #3 (35 Field Test Runs) Magnet-Based

8.5 Data Statistics

This section presents the following performance statistics computed from the 35 sets of data saved during the final field tests on 5 different days along East 14th Street test track under normal day-time bus operational environment. Table 4 - Table 8 list the statistics calculated from the 35 recorded runs for tracking accuracies, docking accuracies, as well as docking times and docking average speeds (from lane-change to stop).

Table 4 Tracking Accuracy (Tracking error STD) Based on 35 Recorded Runs

Tracking Accuracy Scenarios	STD (cm)
Under automated steering control	10.52
Under automated steering control (excluding S-curves)	7.20
Final docking approach (along stations)	1.10
Docking (stopped) accuracy	0.067

Table 5 Docking Accuracy (Tracking error STD) Based on 35 Recorded Runs

Station #	Tracking Accuracy Scenarios	STD (cm)
1	Final docking approach (along stations)	0.98
1	Docking (stopped) accuracy	0.60
2	Final docking approach (along stations)	1.00
2	Docking (stopped) accuracy	0.69
3	Final docking approach (along stations)	1.22

3	Docking (stopped) accuracy	0.76
All	Final docking approach (along stations)	1.07
All	Docking (stopped) accuracy	0.67

Table 6 Final Docking Accuracy (Vehicle Angle at Stop) Based on 35 Recorded Runs

Station #	Vehicle Angle at Final Docking	
	Mean (deg)	STD (deg)
1	0.090	0.151
2	0.220	0.096
3	0.059	0.234
All	0.140	0.134

Table 7 S-Curve Docking Time Based on 35 Recorded Runs (From Lane-Change to Stop at Station)

Station #	S-Curve Docking Time		
	Mean (sec)	STD (sec)	MIN (sec)
1	18.51	2.67	15.47
2	20.92	7.23	15.67
3	14.60	2.71	9.77
All	18.01	5.34	9.77

Table 8 Final Docking Speed Based on 35 Recorded Runs (From Lane-Change to Stop at Station)

Station #	Vehicle Speed at Final Docking	
	Mean (mph)	STD (mph)
1	6.39	0.77
2	5.13	1.03
3	8.24	1.54
All	6.59	1.72

9 Conclusion

For every newly developed technology, field demonstrations and tests are a crucial step in determining its capability in the real world. The demonstrations conducted for the lane-assist/guidance and precision docking technologies is an important milestone in the progress of vehicle guidance technology. Research, development and now testing for operational deployment for these technologies have been supported by Caltrans from their commencement. Success in this test/demonstration will help contribute toward commercialization of lane-assist and precision docking technologies by showing the viability of the technology in a real-world setting.

The project has successfully improved the existing magnetic lane-guidance and precision docking system on a 60ft articulated bus and conducted extensive testing on a 0.9 mile test track installed with magnets 1 meter apart along south bound East 14th Street, San Leandro, CA between 139th and 150th Ave on a real-world operation setting. The track follows a regular AC Transit's bus route and is also part of a planned AC Transit's BRT route. Three regular bus stations had magnets installed for curbside precision docking with S-curves. Testing out the bus extensively in a real-world environment provided valuable opportunities to observe the system's performance in great detail. As a result, a number of issues that could have affected the system adversely in future deployment on a large scale were identified and resolved. Successful demonstrations to government agencies, public transit agencies, local city planner, as well as mass media under a real-world operation setting with live traffic showcased the maturity of the technology and brought the technology to the public eye, generating interest and support among general public for the future deployment.

One hundred and ninety-two test runs on 17 days with automated steering were safely conducted along the East 14th Street 0.9-mile long test track with 3 automated precision docking stations between Feb.-Sept. 2008. After the automated system was finalized on July 23, 2008, 95 runs were conducted on 5 different days, each with runs from 12 to 24, under the normal bus operational environment including transit ride-along and demonstration. Among these field test runs, 35 runs had complete data saved for analysis. Data analysis of these 35 data sets shows that the tracking error standard deviation when the bus is under automated control is 10.52cm. The STD of the tracking error became 7.2 cm when we exclude all tracking data under S-curves. The standard deviation of the tracking error when the bus was at the final approach along the curb to the docking station after is 1.10cm. The STD of the tracking error at the bus stop is 0.67cm. The mean of the final vehicle angle at the bus stop is 0.14 degrees, with the associated STD of 0.13 degrees – in other words, the bus parks itself, under automated control, virtually parallel to the curb line every time.

Demonstrations and riding-along were conducted on both September 5, 2008 and September 23, 2008. During the first day of demonstration, several demonstration runs along East 14th Street were provided to the media reporters from different television stations and print journalists first, and a press release was issued by University of California at Berkeley. Participants in the demonstration included personnel from government agencies, public transit agencies and local city management. Following the demonstration, a workshop was held with extensive exchanges among all participants. Many were very enthusiastic about the potential applications and hoped to include the VAA technology in their future BRT route planning and construction. They generally agreed with the benefits that VAA technology could provide and were surprised by the superior performance shown by the 60ft automated bus on a public street in live traffic.

They raised some questions regarding the reliability and robustness of the technology, the construction and the maintenance of the magnetic tracks and platforms, driver training and cost/maintenance of the VAA vehicles that warrant additional larger-scoped field operational tests.

Several important real-world lessons were learned during this period of real-world operations:

- Busway (electronic guidance) is different from a railroad
 - Irregular road surfaces such as various road crowns (3-5 degrees on road side), road crown changes at intersections, storm drains along curb, utility access covers under the roadway, crack and pot holes are important distinctions between a true “rail” system and the “electronic rail” system. Such irregularities will likely require large and smart nonlinear control to compensate if high precision is required
 - Roadside infrastructural objects can come very close to bus mirror along stations, especially when the bus or the objects are tilted at an angle. Examples of such objects are utility poles, pedestrian and traffic signs, light poles, as well as trees
- Operation flexibility is important
 - Stop-and-go at will, and consistent steering control performance for any possible operational speeds from inching forward to high speeds are all critical real-world operation modes for BRT, especially under mixed traffic conditions
 - Easy, reliable, and possibly multiple methods of transitioning between manual and automated control to is a must, especially under mixed traffic conditions
 - Speed (especially for sharp curves), as well as stop location advisories would be helpful

The successful delivery of the field demonstration and tests of lane-assist/guidance and precision docking technology at East14th Street provides a solid foundation for the FTA’s/ITS JPO’s Vehicle Assist and Automation (VAA) demonstration where the VAA deployment issues will be addressed and the cost and benefits will be assessed in revenue-service operations. The following are several future improvements that will be recommended for the magnetic guidance system, and modifications to prepare for the demonstration have already started:

- Simultaneously detecting and processing multiple magnetic tracks will facilitate “track transition”
- Implementing virtual docking trajectory will facilitate more flexible docking operations
- Strategically selected redundancy will further improve operational safety

Appendix A Track Design and Survey

Once the test route and the station locations were decided, the next step was to design a detailed test track for the surveyor, especially in the areas around the bus stations based on site measurements. The following is the initial design, which includes the drawings, requirements, and concerns for the three docking stations in the "East14th street" magnetic track. Those initial drawing were created according to the on-site measurements conducted by PATH engineers. The accuracies were within 1 inch or 1 foot for the respectively small relative distances, and within 1 meter for larger distances. These requirements then became the guidelines for the detailed survey.

The initial site survey suggested that each station has its own limitations and constraints as described below:

Station #1:

1. Docking straight line section should start at least 1m passing the utility pole (~6.5" from the curb), to keep the bus mirror (~10"-12" extended from the bus) from hitting the pole (with large road crown). However, specific automated maneuver (designed in the control software) might need to be designed later to provide a sufficient safe distance.
2. One magnet should be positioned right at the utility access cover in the docking straight section.

Station #2:

1. The station is simply too short for an S-curve docking (2 m longer than 3 articulated bus length combined – 1 bus length for S-curve-in, 1 bus length for docking straight line, and another 1 for S-curve-out). For an S-curve docking, at least one more car parking space would need to be added. The design assumed a 1-car length no-parking extension.
2. There is a tree trunk leaning toward the curb (the trunk is only 10" to the curb at the bus mirror height) located in front of the bus stop, and the mirror is about 10-12" extended from the bus body. The bus needs to stop before this tree to avoid hitting the trunk and software will need to be added to avoid hitting the tree trunk while exiting the docking station. In addition, there is a large road crown (road inclination angle) that can potentially extend the bus mirror more than a foot into the curb as the bus passes through the road.
3. The S-curve-in part of the docking curve gets very close to the pedestrian sign just before the sidewalk (before 144th Ave). A specific automated maneuver would need to be designed to provide a safe distance with respect to the bus mirror.

Station #3:

1. The bus will stop before the utility pole (3.5 m before the Rapid Sign).

Based on the initial site measurements, PATH researchers developed the initial test track drawings that took into account the above constraints and provided them to the surveyor as the design guidelines shown in Figure 55, Figure 56 and Figure 57 for Stations 1, 2, and 3 respectively.

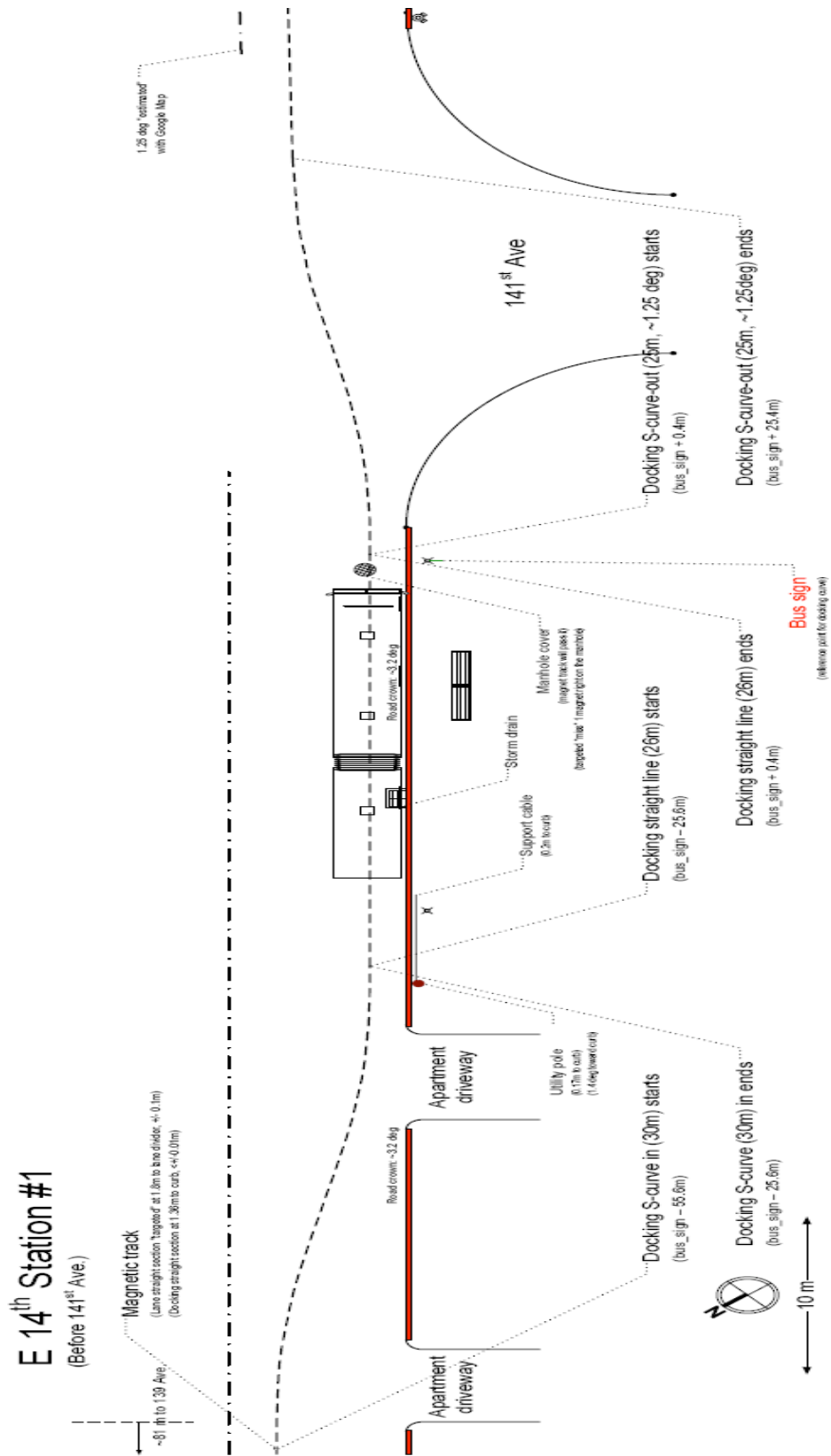

Figure 55 Initial Test Track Design for Station #1

E 14th Station #2 (After 144th Ave.)

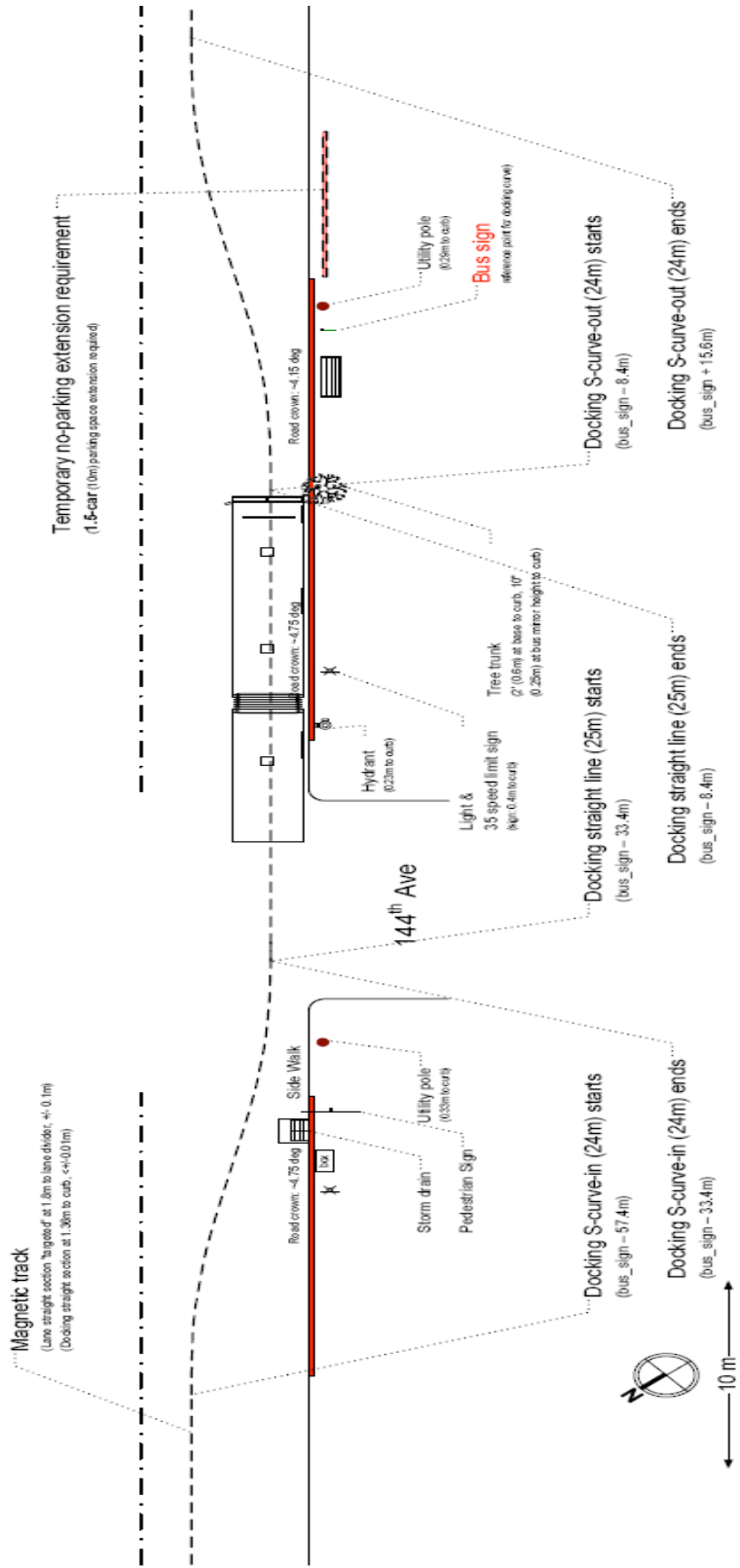

Figure 56 Initial Test Track Design for Station #2

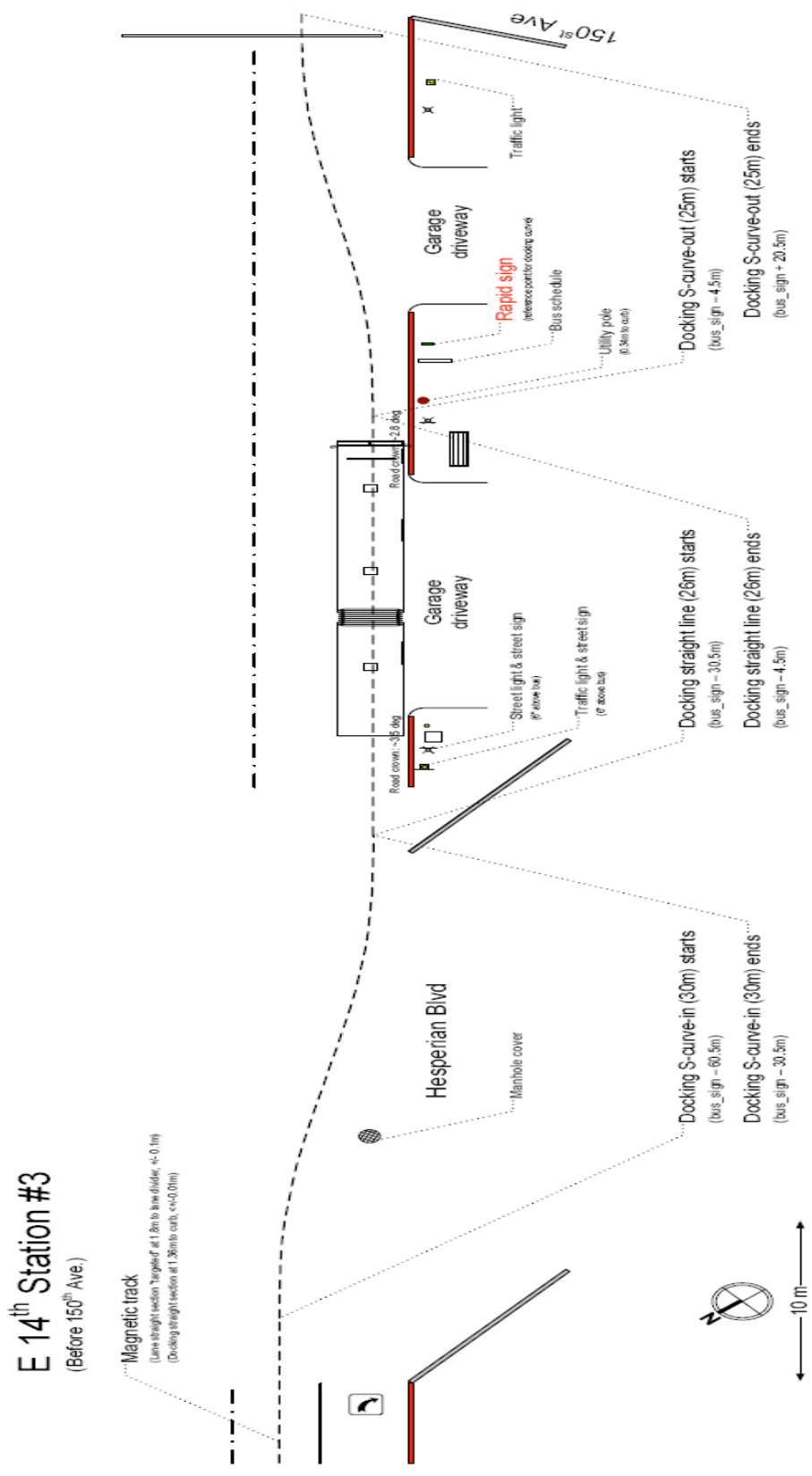

Figure 57 Initial Test Track Design for Station #3

Detailed descriptions of Figure 55, Figure 56 and Figure 57 are listed below:

Target lateral distances:

- Lane straight section magnet line is “targeted” at 1.8 m to lane divider; design tolerance: +/- 0.1 m
- Docking straight section magnet line is at 1.36 m to curb; accuracy should be better than 0.01 m

Station #1:

S-curve-in:

- 5th order polynomials: (24 m long; ~2.84 m lateral offset), from (bus_sign – 57.4 m) to (bus_sign – 33.4 m)

Straight docking line:

- straight line: (26m long, 1.36m to the curb), from (bus_sign – 25.6 m) to (bus_sign + 0.4 m)
- second last magnet on the utility access cover, NOT installed
- road crown: ~3.2 deg; tire will run through storm drain; need to double-check the distance between the support cable to the bus mirror

S-curve-out:

- 5th order polynomials: (25 m long; ~2.9 m lateral offset; ~1.25 deg final angle), from (bus_sign + 0.4 m) to (bus_sign + 25.4 m)

Station #2:

S-curve-in:

- 5th order polynomials: (24m long; ~2.84 m lateral offset), from (bus_sign – 57.4 m) to (bus_sign – 33.4 m)

Straight docking line:

- straight line: (25 m long, 1.36 m to the curb), from (bus_sign – 33.4 m) to (bus_sign – 8.4 m)
- road crown: ~4.7-4.1 deg; need to double-check distance between the “35 mph” sign to the bus mirror, and the distance between the trailer and the hydrant while the bus pulls out

S-curve-out:

- 5th order polynomials: (24 m long; ~2.84 m lateral offset), from (bus_sign – 8.4 m) to (bus_sign + 15.6 m)
- requires a 7 m “no-parking zone” extension (1-car parking space) after the current bus stop
- ends 3 m parallel into the new parking zone

Station #3:

S-curve-in:

- 5th order polynomials: (30 m long; ~3.6 m lateral offset), from (bus_sign – 60.5 m) to (bus_sign – 30.5 m)

Straight docking line:

- straight line: (26 m long, 1.36 m to the curb), from (bus_sign – 30.5 m) to (bus_sign – 4.5 m)
- road crown: ~3.5-2.8 deg; need to double-check distances from signs to the bus mirror

S-curve-out:

- 5th order polynomials: (25 m long; ~2.73 m lateral offset), from (bus_sign – 4.5 m) to (bus_sign + 20.5 m)

Those initial designs were given to the survey contractor and the track layouts were finalized with two iterations with the PATH engineers. Figure 58 and Figure 59 are two examples of the final layouts for Stations #2 and #3, respectively. As shown in these two figures, the survey points are 1m apart for docking curves, and 10 meters apart for other areas. In addition, the in-pavement obstacles such as traffic loop detectors are also indicated in the map (e.g., Figure 58) were marked on the pavement accordingly to facilitate movement of the magnet location forward and backward along the track to provide sufficient distance between the loop and the magnet during the installation procedure. The total number of magnets installed in this test track is 1272, and the associated final “magnet numbers” for docking curves are shown in Figure 59 where the first magnet number is designated to be -5.

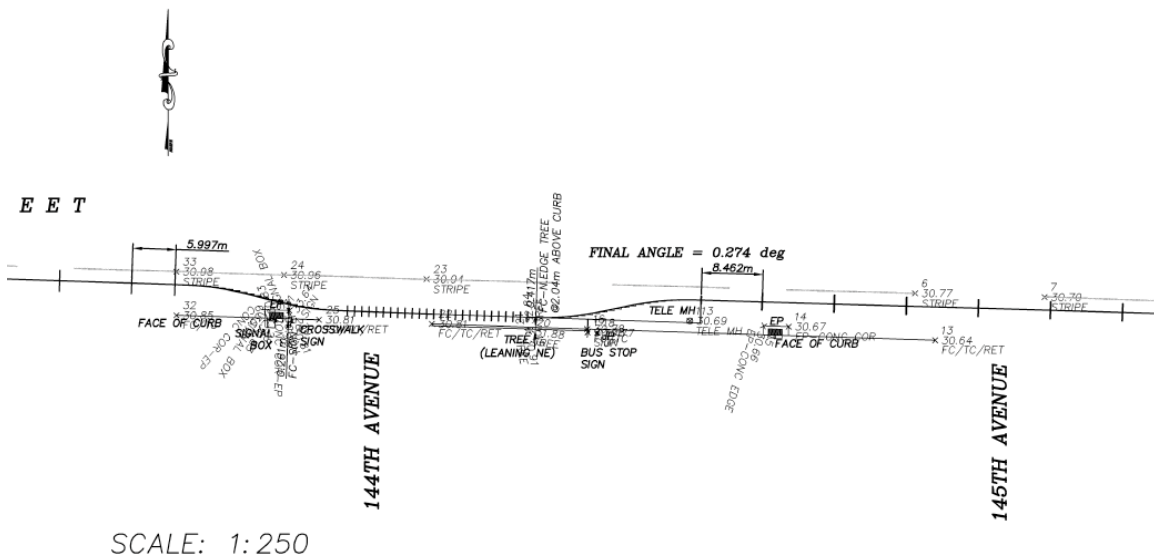

Figure 58 Example of Final Survey Map (Station #2)

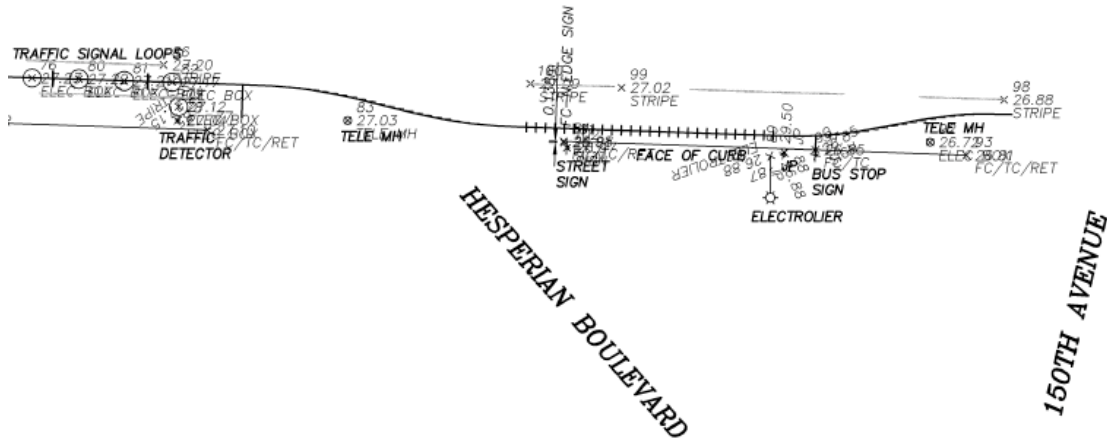

Figure 59 Example of Final Survey Map (Station #3)

Table 9 Final Docking Station Parameters

Station #	Section	Start #	End #	Length (m)	Lat. Dist.	Final Deg.
1	S-curve in	78	108	30	-3.56	0.0369
1	straight	108	134	26	0	
1	S-curve out	134	159	25	3.11	0.806
2	S-curve in	395	419	24	-2.91	0
2	straight	419	444	25	0	
2	S-curve out	444	468	24	3.18	0.247
3	S-curve in	1186	1216	30	-3.47	0
3	straight	1216	1242	26	0	
3	S-curve out	1242	1267	25	3.06	0

Appendix B Magnet Installation Methodology

The following are the general specifications of the roadway modifications for installing the magnetic markers on the proposed East 14th Street test route:

Magnets:

1. Ceramic magnet: Four stacked disc magnets with one inch diameter and one inch height with a total height of four inches.
2. Rare earth magnet: One disc with one inch diameter and one inch thickness. Because the rare earth magnet has a stronger field, only one magnet is used in comparison to the four stacked ceramic magnets. These magnets were only for

use near dynamic loop coils or in areas where other obstructions might cause them to be buried in asphalt. Less than 20 will be used over the entire track.

Holes to Install the Magnet:

1. Location: center of lane two
2. Spacing: every 1.0 meter between two markers.
3. Diameter: slightly larger than that of the magnets (1.0625” for ceramic magnet).
4. Depth: 1/4 inch deeper than the magnet (4.25” for ceramic magnet).
5. Lateral accuracy: maximum error less than 1 centimeter.
6. Longitudinal accuracy: maximum error less than 4 centimeters.
7. Approximately 1600 magnets over the entire track.
8. Magnets will be installed no closer than 2 feet from dynamic loop counter coils.

These rules on magnet longitudinal spacing were slightly modified and relaxed during survey in order to avoid gaps between the concrete blocks and coils of the loop detectors on the roadway. During survey, certain roadway marks, for example, location of the beginning of new roadway curvature were identified on the roadway to facilitating marking of the coding.

Polarity of the Magnets:

The polarity of the magnets is changed in a pattern (binary code) in some segments of the magnet track to provide information to the vehicle about upcoming curves or what portion of the track the vehicle is on. The magnets were placed in the holes in such a way that the polarity of each magnet is in accordance with that of a given code map shown in Table 10.

Table 10 Code Table at East 14th Street Test Track (Excluding header and trailer)

Code #	bit 1	bit 2	bit 3	bit 4	bit 5	bit 6	bit 7	Start#	End#
1	1	1	0	1	0	0	1	15	25
2	0	1	0	1	0	1	0	40	50
3	1	0	0	0	0	1	1	67	77
4	1	0	0	1	1	0	0	180	190
5	0	1	0	0	1	0	1	310	320
6	1	1	0	0	1	1	0	350	360
7	0	0	0	1	1	1	1	384	394
8	1	1	1	0	0	0	0	520	530
9	0	0	1	1	0	0	1	640	650
10	1	0	1	1	0	1	0	705	715
11	0	1	1	0	0	1	1	810	820
12	0	1	1	1	1	0	0	924	934
13	1	0	1	0	1	0	1	1054	1064
14	0	0	1	0	1	1	0	1144	1154
15	1	1	1	1	1	1	1	1181	1191

The magnetic track design, survey and installation were conducted once the testing site was fully evaluated by all parties involved (Caltrans, City of San Leandro, AC Transit, and PATH) and all agreed that the site was suitable. The track installation included the following detailed tasks:

- 1) The team determined the survey and installation contractors
- 2) The University and the traffic management contractor got lane closure permits from Caltrans District 4 for:
 - a) Work in lanes between intersections
 - b) Work in lanes inside intersections
- 3) PATH engineers took preliminary measurements of the test site based on the known bus dimensions and dynamics behavior, and provided a tentative design to the survey company.
- 4) The survey contractor conducted a simple initial survey on the test site to provide a map including the layout of the magnets in all straight-line sections of the test track.
- 5) Based on the initial survey results, PATH worked with a survey contractor to determine the design of the connection curves between straight lines, entrance curve and departure curve of each station. A magnetic code table was then designed and generated. The design process took a couple of iterations.
- 6) The survey contractor conducted the final survey based on the detailed design of magnetic track, and marked them appropriately on the ground, making note of certain polarity marks on the ground as well. In order to speed up the survey process, PATH and the survey contractor has developed a process that requires marks on the ground only for every 10 points, except the critical ones. Those critical points include the start and the end points of a straight line portion, as well as each point of the S-curves. The points in between the two mark points were marked using chalk lines and wooden templates. The final survey was conducted parallel to the magnet installation on 2 weekend days.
- 7) The contractor conducted the magnet installation with following procedure:
 - a) Drilling a 1 1/16 inch hole to the desired depth every 1.0 meter during straight track segments and at every magnetic marker position during curved segments;
 - b) Preparing the hole for the magnet installation, i.e., cleaning the hole with either a vacuum or compressed air;
 - c) Setting the magnet to the required vertical position, depth and polarity according to the code table;
 - d) Sealing the hole with appropriate adhesive/sealant and clean level surface;The contractor and the installation procedure adhered to other operational and safety procedures required by Caltrans or the City.
For each magnet installation, once a hole was drilled, the magnet installation was performed shortly. During magnet installation, traffic along that lane was closed.

- 8) The traffic management contractor removed the lane closure for the completed section of the track after the other contractors and the PATH cleared the area.
- 9) PATH tested and verified the correctness of installation before and after sealing the magnets. The contractor would be required in order to correct an installation error; however, it was not necessary through the course of this installation.

Appendix C Workshop and Demonstration Participant List

- California Department of Transportation
 - Division of Research and Innovation
 - Larry Orcutt, Division Chief
 - Don Dean, Chief of Transit and Modal Research
 - Sonja Sun
 - Nancy Chinlund
 - Division of Mass Transportation
 - Scott Sauer
 - Elaine Houmani
 - District 4
 - Bijan Sartip, Director
 - Sean Nozzari, Deputy Director
 - Paul Chu, Senior traffic manager
- AC Transit
 - Chris Peebles, President
 - Jim Cunradi, BRT Manager
 - Nancy Skowbo
 - Kathleen Kelly
 - Jaimie Levin
- BART
 - David Lehrer
 - Ken Schwartz
 - Eugene Nishinaga
- Golden Gate Transit
 - David Davenport
- Sacramento RT
 - Don Smith, Senior Planner
 - Chris Pair
- SAMTRANS
 - Frank Burton, Communications Manager
- San Francisco MUNI
 - Paul Bignardi
 - Darton Ito
- San Joaquin RTD
 - Norm Tuitavuki, Transportation Superintendent
 - Mark Fairbanks
 - Chris Durant
 - Sid Plummer

- VTA
 - Kevin Connolly, BRT Manager
 - Andrew Ittigson
- City of San Leandro
 - Uche Udemezue, Engineering & Transportation Director
 - Ron May, Street Maintenance Manager
 - Reh-Lin Chen, Senior Transportation Engineer
 - Ofc. Agraviador Jeff
 - Sgt. Randy Hudson
 - Captain Ian Willis

Appendix D Media Report Collections

- CNET: http://cnettv.cnet.com/9742-1_53-50003840.html?tag=api
- ABC: <http://abclocal.go.com/kgo/story?section=news/technology&id=6374046>
- Wired: <http://blog.wired.com/cars/2008/09/look-ma-no-hand.html>
- Berkeley News: http://www.berkeley.edu/news/in_news
- Contra Costa Times: http://www.contracostatimes.com/search/ci_10393928?IADID=Search-www.contracostatimes.com-www.contracostatimes.com
- Science Daily: <http://www.sciencedaily.com/releases/2008/09/080910142425.htm>
- Automobile Magazine: <http://blogs.automobilemag.com/6279202/tech-talk/uc-berkeley-automated-bus-steers-itself/index.html>
- Daily Cal: http://www.dailycal.org/article/102559/magnets_not_drivers_guide_campus_researchers_bus_p
- Media Newswire: http://media-newswire.com/release_1072099.html
- Mercury News: http://www.mercurynews.com/business/ci_10393928
- Mass Transit Magazine: <http://www.masstransitmag.com/online/article.jsp?siteSection=3&id=6910>
- Traffic Technology Today: <http://www.traffictechnologytoday.com/news.php?NewsID=7873>

Appendix E Press Release of Demonstration

9/5/08 – File #17908

Contact: Sarah Yang

(510) 643-7741

scyang@berkeley.edu

Transportation researchers demo magnetic guidance technology that steers buses in right direction

FOR IMMEDIATE RELEASE

Berkeley — The thought of a bus moving along city streets while its driver has both hands off the wheel is alarming. But a special bus introduced today (Friday, Sept. 5), steered not by a driver, but by a magnetic guidance system developed by engineers at the University of California, Berkeley, performed with remarkable precision.

The 60-foot research bus was demonstrated along a one-mile stretch of East 14th Street in San Leandro that was embedded with a series of magnets. Special sensors and processors on board the bus detected the magnets in the pavement and controlled the steering based upon the information it received. The driver maintained control of braking and acceleration, but the steering was completely automated, allowing the bus to pull into stops to within a lateral accuracy of 1 centimeter, or about the width of an adult pinky finger.

Researchers say such precision docking would help shave precious seconds off of the time to load and unload passengers at each stop, adding up to a significant increase in reliability and efficiency over the course of an entire bus route. For example, precision docking could potentially negate the need to deploy wheelchair ramps and make passenger queuing more efficient.

Moreover, the ability to more precisely control the movement of the bus reduces the width of the lane required for travel from 12 feet – the current standard – to 10 feet, researchers say.

The California Department of Transportation (Caltrans) has provided \$320,000 to fund this Automated Bus Guidance System demonstration project, conducted by the California Partners for Advanced Transit and Highways (PATH) program based at UC Berkeley.

"Today's demonstration marks a significant step in taking the technology off of the test track at UC Berkeley's Richmond Field Station towards deployment onto real city

streets," said Wei-Bin Zhang, PATH transit research program leader at UC Berkeley. "We have seen increasing interest among transit agencies in this technology because of its potential to bring the efficiency of public bus service to a level approaching that of light rail systems, but at a much lower overall cost."

California PATH researchers have been studying magnetic guidance systems as a means of controlling vehicle movement for nearly 20 years with significant funding from Caltrans and the U.S. Department of Transportation. They have showcased how the technology can control a platoon of passenger cars speeding along high occupancy vehicle (HOV) lanes in Southern California, as well as industrial vehicles such as snowplows and tractor trailers in Northern California and Arizona. Today's test run along East 14th Street marks the first application of magnetic guidance technology for use in transit buses on a public road.

"It is our mission to improve mobility across California, and maximizing transportation system performance and accessibility through this technology helps us to achieve our mission," said Larry Orcutt, chief of the Caltrans Division of Research and Innovation. "The rising cost of fuel has created greater interest in public transit. This technology could convince more people to get out of their cars and onto buses, and as a result, reduce congestion."

In the system demonstrated today, sensors mounted under the bus measured the magnetic fields created from the roadway magnets, which were placed beneath the pavement surface 1 meter apart along the center of the lane. The information was translated into the bus's lateral and longitudinal position by an on-board computer, which then directed the vehicle to move accordingly. For a vehicle traveling 60 miles per hour, data from 27 meters (88 feet) of roadway can be read and processed in 1 second.

Zhang added that the system is robust enough to withstand a wide range of operating conditions, including rain or snow, a significant improvement to other vehicle guidance systems based upon optics. Researchers also pointed out that magnetic guidance technology allows for a bus to safely follow closely behind another. Extra vehicles, much like extra cars on light rail trains, could thus be added during peak commute times.

In the East 14th Street demonstration, the magnetic guidance system was only used to control the steering for the bus, but on test tracks it has been used for full vehicle control – including braking and accelerating – creating a true "auto-pilot" system for the bus. At any time, the driver can resume manual control of the bus.

Potential applications for the system include automating bus passage through narrow tollbooths and vehicle routing in bus maintenance yards. The system could be integrated into traditional bus routes, as shown on East 14th Street, or used as part of more advanced bus rapid transit (BRT) systems that could include a dedicated traffic lane.

Many cities throughout the world, including 20 in the United States, have deployed some form of BRT, although only a few include dedicated bus-only lanes.

Today's demonstration included a special industry presentation attended by dozens of representatives from California transit agencies interested in whether PATH's magnetic guidance technology might fit with their own BRT plans.

On some routes in the Bay Area, AC Transit currently operates a version of bus rapid transit that includes electronic signs informing riders of when to expect the next bus. However, the transit agency is currently in the midst of preparing an Environmental Impact Report for a proposed BRT project that could include bus-only lanes along an 18-mile stretch from downtown Berkeley near the UC Berkeley campus south to San Leandro's Bay Fair BART station.

"AC Transit is a leader promoting advanced technologies for transit buses. As such, we are continually investigating new technologies to improve the performance, safety and comfort of buses," said Chris Peeples, president of AC Transit's board of directors. "The magnetic guidance system developed at UC Berkeley can both improve safety and provide a smoother ride for our passengers. The system has the potential to make bus rapid transit routes – particularly those that involve bus-only lanes – as efficient as light rail lines, which in turn will make buses more effective in getting people out of their cars."

AC Transit puts the cost of its BRT proposal at \$273 million, while a comparable light rail system would cost around \$2 billion. Zhang said that adding the magnetic guidance technology to AC Transit's proposed BRT project would help it run more like a light rail system for an additional \$5 million. The Valley Transportation Agency has also compared the costs of BRT and light rail systems for its planned Santa Clara Alum Rock Transit Improvement Project. The estimated cost for BRT came in at \$128 million, compared with \$393 million for light rail.

AC Transit is joining Caltrans and the U.S. Department of Transportation in funding the next stage of the Automated Bus Guidance System project as it becomes part of the federal Vehicle Assist and Automation Program. The project will expand to AC Transit routes along Interstate 880 and the San Mateo Bridge, and to a dedicated BRT route in Eugene, Ore.

"Ultimately, it's up to the community to decide which transit option is best for its members," said Zhang. "Our job is to develop the technology that can help improve whatever form of transportation is used."

NOTE: To reach Wei-Bin Zhang, call (510) 665-3515 or e-mail wbzhang@path.berkeley.edu. The media contact for Caltrans is Lauren Wonder, at (510)

286-6120 and lauren_wonder@dot.ca.gov. The AC Transit media contact is Clarence Johnson, at (510) 891-4745 and cljohnson@actransit.org.

Appendix F FAQ Handout of Demonstrations

AUTOMATED BUS GUIDANCE SYSTEMS

Frequently Asked Questions

1. What are we looking at here today?

On September 5, 2008, media and transit-agency guests will observe and ride on a conventional 60-foot PATH research bus that is instrumented with sensing, actuator-based processors and computer-based processors to perform automated, lane keeping and precision docking. The one-mile demo track runs along AC Transit's service route on East 14th St. between 138th and 150th avenues in San Leandro, and has three bus stations. The pilot-assisted bus will automatically transition to magnet control.

The demo bus will accurately following the predetermined trajectory defined by an array of magnetic markers embedded in the roadway. At bus stop, the demo bus will follow an S-curve, like a skillful driver would, and will stop/dock at a bus stop, just like BART stops at a station.

2. Who is behind the project?

The Automated Bus Guidance System research project is sponsored by the California Department of Transportation (Caltrans) and the Federal Transit Administration (FTA), and conducted by the California PATH Program. AC Transit is a partner in the project.

3. How does the technology work?

This technology is based on the use of low cost, simple permanent magnets buried beneath the pavement surface in the center of the lane (or the intended vehicle path). Using simple magnetometers mounted on the vehicle and a data processing algorithm, it is possible to determine the vehicle's position relative to the lane/path center to within an accuracy of about 5 mm (less than ¼ inch). An on-board computer processes the data and steers vehicles accurately through the steering actuator.

4. What makes this better than regular buses?

The automated bus guidance system is an application of Vehicle Assist and Automation (VAA) technologies. VAA technologies enable a new form of transportation that offers the efficiencies and quality of service of railway at a much lower cost.

- Has much lower infrastructure costs than rail: magnets in the road and simple street-side docking stations rather than track systems and major stations.
- Improves lateral ride smoothness, particularly at higher speeds.
- Makes it possible for buses to dock precisely at stations, so passengers can load and unload quickly.
- Allows wheelchair-bound riders to roll on or off the buses with just a small gap between the bus floor and the loading platform at the station.
- Allows buses to operate in lanes that are only slightly wider than the buses are themselves—taking up minimal road space and achieving rail-like space efficiency without major construction costs.
- Regular place for docking and boarding allows passengers to queue (as on BART), further enhancing operational efficiency.
- Buses can platoon (convoy), allowing capacity to grow or shrink according to ridership
- Numerous studies show more people ride public transit when it is faster and more efficient.

5. What is BRT?

Bus rapid transit (BRT) is a generic term that describes an advanced bus system rather than a conventional one. BRT is “A flexible, rubber-tired rapid transit mode that combines stations, vehicles, services, running ways, and intelligent transportation systems (ITS) elements into a permanently integrated system with a quality image and strong identity.” BRT systems seek to make service faster, more reliable, and more comfortable. It typically includes:

- Giving the bus its own traffic lane so it can run faster with fewer impediments
- Giving the bus priority at traffic signals so it spends less time stopped at red lights
- Providing real-time information to riders so they know when the next bus is coming to allow them to manage their time better
- Building bus stops that improve passenger safety, access, and comfort

6. Is BRT the only application for this guidance technology?

PATH is demonstrating an automated guidance system that helps automate BRT, which results in service closer to the quality of light rail.

The automated guidance technology has many transit and transportation applications:

- Urban BRT systems with dedicated right of way (i.e., dedicated lane)
- Automated urban bus lines integrated with regular traffic
- Feeder lines to BART, Caltrain, or any major transit line
- Lower-cost extensions to and from extant transit lines
- Automating/accelerating bus passage through toll booths
- Dedicated truck and freight lanes

7. Is magnetic guidance new?

PATH invented the magnetic guidance system using permanent magnetic markers in 1988. Since then, PATH has developed and extensively tested a precision lateral control system using magnetic guidance technology. PATH has implemented the technology on various vehicles, including passenger cars, Caltrans snowplows, buses, a snowblower, and a class-8 tractor-trailer rig. It has been used to provide completely automated steering control at highway speeds, providing a smooth, comfortable ride with high steering accuracy. On the passenger cars, it has been tested at speeds up to 160 km/h (100 mph). It has also been used for precision low-speed maneuvering on buses precision docking at a curbside bus stop with millimeter accuracy. The magnetic guidance technology has been demonstrated by PATH for automobile, snowplow and now bus applications. It has also been adopted by Japan and Europe.

8. What is the next step for this technology—when can we ride it?

The technology could be deployed in U.S. cities as soon as three years. As part of the newly funded Vehicle Assist and Automation (VAA) Program, also funded by the U.S. DOT and Caltrans in partnership with AC Transit, guidance technologies will be instrumented on two AC transit buses, which operate in revenue service with passengers along I-880 and onto San Mateo Bridge in 2009 and 2010. One additional transit bus with similar technologies will be demonstrated along the BRT route in Eugene, Oregon. In addition, the technology will be transferred to commercial vendors, making products available to bus manufacturers to integrate it onto BRT buses or other transit buses.

For more information: <http://www.path.berkeley.edu>

Reference:

- [1]. H.-S. Tan, B. Bougler and W.-B. Zhang, “Automatic Steering Based on Roadway Markers - From Highway Driving to Precision Docking,” *Vehicle System Dynamics*, vol. 37, no. 5, March, 2002, pp. 315-339
- [2]. H.-S. Tan, B. Bougler, “Vehicle Lateral Warning, Guidance and Control Based on Magnetic Markers – PATH Report on AHSRA Smart Cruise 21 Proving Tests,” *California PATH Working Paper*, UCB-ITS-PWP-2001-6
- [3]. H.-S. Tan, J. Guldner, S. Patwardhan, C. Chen, and B. Bougler, “Development of an Automated Steering Vehicle Based on Roadway Magnets—A Case Study of Mechatronic System Design” *IEEE/ASME TRANSACTIONS ON MECHATRONICS*, Vol. 4, No. 3, 1999, pp258-272
- [4]. R. Rajamani, H.-S. Tan, B. K. Law, and W.B. Zhang, “Demonstration of Integrated Longitudinal and Lateral Control for the Operation of Automated Vehicles in Platoons” *IEEE TRANSACTIONS ON CONTROL SYSTEMS TECHNOLOGY*, Vol. 8, No. 4 2000
- [5]. H.-S. Tan, B. Bougler, and A. Steinfeld, “Snowplow Steering Guidance with Gain Stabilization,” *Vehicle System Dynamics*, vol. 36, no. 4-5, November, 2001, pp. 279-305
- [6]. http://www-1.expo2005.or.jp/en/newsttopics/2003/030708_01.html
- [7]. T. Suzuki, M. Aso, H. Tominaga, T. Doi, M. Mio, “Automated bus control for the intelligent multi-mode transit system” *ITS World Congress* 1999
- [8]. K. Aoki and T. Suyama, “A concept of intelligent multimode transit system based on automated bus”, *ITS World Congress* 1999
- [9]. K. Aoki, T. Suyama, “A concept of intelligent multi-mode transit system based on automated bus” *IEEE Intelligent Vehicles Symposium* 2000, pp. 590 – 595
- [10]. <http://www.apt-phileas.com>
- [11]. Jay Farrell, Tony Givargis and Matthew Barth, “Real-Time Differential Carrier Phase GPS-Aided INS”, *IEEE Transactions on Control Systems Technology* , Vol. 8, No.4 709-721, 2000
- [12]. “Validation Report, Intelligent Vehicle Initiative, Specialty Vehicle Field Operational Test”, *MN/DOT – US DOT Cooperative Agreement* DTFH61-99-X-00101, July 2002

- [13]. Jay Farrell, Matthew Barth, Randy Galijan and Jim Sinko. “GPS/INS Based Lateral and Longitudinal Control Demonstration: Final Report”. **California PATH research report**, ITS, UC Berkeley, no UCB-ITS-PRR-98-28
- [14]. Jay Farrell, Mathew Barth. “Integration of GPS-aided INS into AVCSS”. **California PATH research report**, ITS, UC Berkeley, no UCB-ITS-PRR-2000-22
- [15]. Jay Farrell, Mathew Barth, “Integration of GPS/INS and Magnetic Markers for Advanced Vehicle Control”. **California PATH research report**, ITS, UC Berkeley, no UCB-ITS-PRR-2001-38
- [16]. Jay Farrell, Mathew Barth. “Integration of GPS/INS and Magnetic Marker for Advanced Vehicle Control: Final Report for MOU 391”. **California PATH research report**, ITS, UC Berkeley, no UCB-ITS-PRR-2002-32
- [17]. J. Farrell, H.-S. Tan and Y. Yang, “Carrier Phase GPS-aided INS based Vehicle Lateral Control”. **ASME Journal of Dynamics Systems, Measurement, and Control**, 2003
- [18]. Y. Yang, J. Farrell and H.-S. Tan, “GPS-aided INS based Control State Calculation for AHS,” **Proceedings of American Control Conference**, Arlington, VA, USA, June 2001, pp. 2321-2326
- [19]. Y. Yang, J. Farrell and H.-S. Tan, “Carrier Phase Differential GPS-aided INS based Vehicle Control: Experimental Results,” **Proceedings of the Institute of Navigation**, 2001 National Technical Meeting, Long Beach, CA, January 2001
- [20]. H.-S.Tan, B. Bougler, J. Farrell and Y. Yang, “Automatic Vehicle Steering Controls: DGPS/INS and Magnetic markers,” **Proceedings of American Control Conference**, 2003
- [21]. Lee Alexander, Max Donath. “Differential GPS Based Control of Heavy Vehicles”. **Proceedings of the IEEE/IEEJ/JSAI International Conference on Intelligent Transportation Systems**, Tokyo, Japan, pp. 662-7, October, 1999
- [22]. Lee Alexander, Max Donath. “Differential GPS Based Control of a Heavy Vehicle”. **Minnesota DOT research report**. MN/RIC-2000-05, 1999
- [23]. “Detailed Design, Intelligent Vehicle Initiative, Specialty Vehicle Field Operational Test” , **MN/DOT – US DOT Cooperative Agreement DTFH61-99-X-00101**, March 2001
- [24]. “Validation Report, Intelligent Vehicle Initiative, Specialty Vehicle Field Operational Test”, **MN/DOT – US DOT Cooperative Agreement DTFH61-99-X-00101**, July 2002

- [25]. “Bus Rapid Transit Lane-assist Technology Systems Volume I Technology Assessment” FTA-MN-26-7003, Feb. 2003
- [26].] E. Dickmanns and V. Graefe, V. “Application of Dynamic Monocular Machine Vision,” *Machine Vision and Applications*, vol.1., no. 4, pp.241-261, 1988
- [27]. T. Jochem, D. Pomerleau, B. Kumar and J. Armstrong, “PANS: A Portable Navigation Platform,” *Proceedings of Intelligent Vehicles Symposium*, Detroit, MI, USA, pp.107-112, 1995
- [28]. Q. T. Luong, J. Weber, D. Koller, and J. Malik, “An Integrated Stereo-Based Approach to Automatic Vehicle Guidance,” *Proceedings of the 5th ICCV*, pp. 52-57, 1995
- [29]. A. Broggi, M. Bertozzi, A. Fascioli, C. Guarino Lo Bianco and A. Piazzzi, “The ARGO Autonomous Vehicle’s Vision and Control Systems,” *International Journal of Intelligent Control Systems*, vol. 3, no. 4, 1999, pp. 409-441
- [30]. M. Bertozzi, A. Broggi, A. Fascioli, “Vision-based intelligent vehicles: State of the art and perspectives,” *Robotics and Autonomous Systems*, Vol. 32, no 16, 2000, pp. 1-16
- [31]. “Rouen, France Brief: TEAR Optically Guided Bus”