

Submitted to  
Physical Review (D)

L. Yu

UCRL-20803  
Preprint c.2

RECEIVED  
LAWRENCE  
RADIATION LABORATORY

AUG 2 1971

LIBRARY AND  
DOCUMENTS SECTION

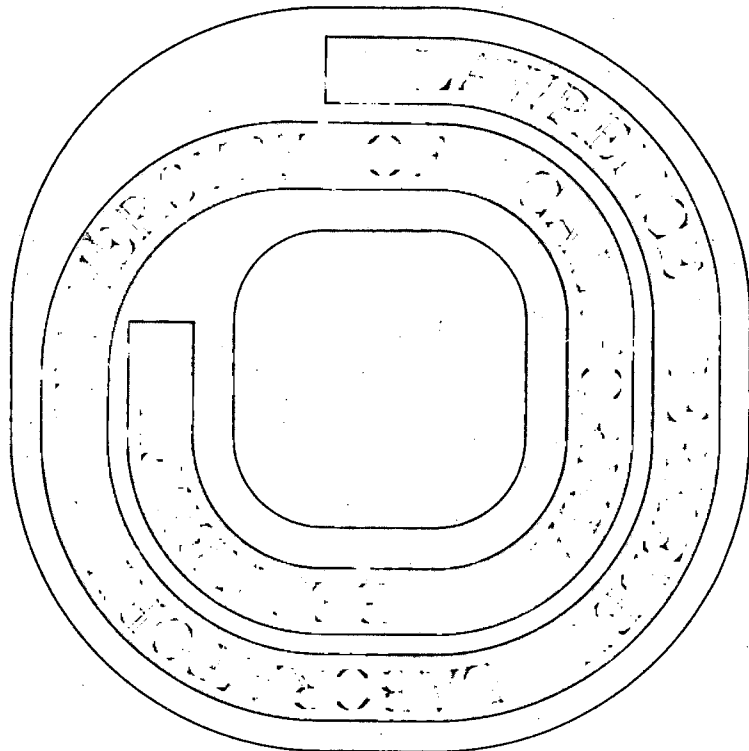

PARTON DUAL RESONANCE MODEL FOR THE  
LEPTON-HADRONIC AND THE  
COLLIDING-BEAM INCLUSIVE REACTIONS

Loh-ping Yu

June 23, 1971

AEC Contract No. W-7405-eng-48

**TWO-WEEK LOAN COPY**

*This is a Library Circulating Copy  
which may be borrowed for two weeks.  
For a personal retention copy, call  
Tech. Info. Division, Ext. 5545*

## **DISCLAIMER**

This document was prepared as an account of work sponsored by the United States Government. While this document is believed to contain correct information, neither the United States Government nor any agency thereof, nor the Regents of the University of California, nor any of their employees, makes any warranty, express or implied, or assumes any legal responsibility for the accuracy, completeness, or usefulness of any information, apparatus, product, or process disclosed, or represents that its use would not infringe privately owned rights. Reference herein to any specific commercial product, process, or service by its trade name, trademark, manufacturer, or otherwise, does not necessarily constitute or imply its endorsement, recommendation, or favoring by the United States Government or any agency thereof, or the Regents of the University of California. The views and opinions of authors expressed herein do not necessarily state or reflect those of the United States Government or any agency thereof or the Regents of the University of California.

PARTON DUAL RESONANCE MODEL FOR THE LEPTON-HADRONIC  
AND THE COLLIDING-BEAM INCLUSIVE REACTIONS\*

Loh-ping Yu

Lawrence Radiation Laboratory  
University of California  
Berkeley, California 94720

June 23, 1971

ABSTRACT

A unified representation of  $\nu W_2$  and  $W_1$  for both the electroproduction,  $e^- + N \rightarrow e^- + \text{anything}$ , and the colliding-beam reaction,  $e^+ + e^- \rightarrow \bar{N} + \text{anything}$ , is presented. We then generalize the model to the case of detecting one more hadronic final-state particle, and obtain formulas for all four structure functions for both the reaction  $l + h_1 \rightarrow l + h_2 + \text{anything}$  and the reaction  $l + \bar{l} \rightarrow \bar{h}_1 + h_2 + \text{anything}$ . The explicit formulas further unify the generalized Bjorken scaling law with the Feynman scaling law. We then discuss the fragmentation of the target hadron, the fragmentation of the heavy virtual photon, the two triple-reggeon limits, the two pionization (nucleonization) limits, the "four-reggeon" limit, the "fixed-angle" limits, and the generalized threshold behaviors of Bloom and Gilman. The pionization region again shows a universal cut-off of  $\exp(-4p_{\perp}^2)$  in the transverse momentum, and predicts the average multiplicity distribution  $\langle n \rangle = a + b \ln s$ , where  $s$  is the square of missing masses. Formulas for all structure functions for further generalization to arbitrary number of detected final-state particles are also given.

I. SUMMARY OF THE PHYSICS AND THE MATHEMATICS  
OF THE PARTON DUAL RESONANCE MODEL

In the construction of the parton dual resonance model<sup>1</sup> for the electroproduction  $e^- + N \rightarrow e^- + \text{anything}$ , and the colliding-beam reaction  $e^+ + e^- \rightarrow \bar{N} + \text{anything}$ , two crucial assumptions have been made: (a) the heavy virtual photon has point-like coupling to the partons, (b) the parton which absorbs the heavy virtual photon is not to be observed experimentally.

The assumption (b), takes into account the final-state interaction among the partons and resolves the puzzle why the parton is not observed experimentally. By virtue of these two assumptions, a heavy virtual photon is naturally pictured as a parton-antiparton pair whenever it participates in the strong interaction processes.

The idea of the parton, in this model, is defined to be the unobserved field that mediates the electromagnetic interaction with the strong interaction. Being a mediator, the parton possesses both the properties of the electromagnetic interaction and the strong interaction. The electromagnetic properties that the parton possesses are (a) the fundamental coupling to the heavy virtual photon is point-like and three-leg, (b) the parton is an unobserved field theoretical particle having an off mass shell Feynman propagator. The strong interaction properties that the parton has, are best stated by saying that the parton leg can be regarded as one of the legs in the  $n$ -point Veneziano formula, i.e., two partons (or a parton-antiparton pair) can form a tower of resonances in the same sense as in the ordinary dual resonance model.

The physical picture of this model can be visualized as follows. To the heavy virtual photon's eyes, the target hadron is a complicated,

extended object, composed of infinite many tightly bound partons, and so the heavy virtual photon interacts at a point constituent (the parton) inside the hadron. After the interaction, the constituent absorbs huge amounts of energy, hence decays by bremsstrahlung into low-energy partons through parton-parton interaction. The number of partons inside the hadron thus increases, and so, the hadron is excited to a resonance state. The excited resonance state then subsequently decays into final-state particles via the strong interaction.

Therefore, we have proposed a six-point dual resonance model for the virtual forward Compton scattering, depicted in Fig. 1. The results of the model are given by the following representative formulas for the structure functions  $W_1^{(i)} \rightarrow F_1^{(i)}$ ,  $vW_2^{(i)} \rightarrow F_2^{(i)}$ , ( $i = 1$  for spin-0 partons,  $i = 2$  for spin- $\frac{1}{2}$  partons) over the whole range  $0 < \omega < \infty$ :

$$\left\{ \begin{array}{l} F_1^{(1)} \\ F_1^{(2)} \\ F_2^{(1)} = F_2^{(2)} \end{array} \right\} \underset{\substack{s \rightarrow +\infty \\ q^2 \rightarrow +\infty}}{\sim} \frac{\pi^4}{\ln|q^2|} \int_0^1 d\alpha_1 \int_0^{1-\alpha_1} d\alpha_1' \int_{\hat{\alpha}}^{\infty} d\alpha \left(1 - \frac{a}{\alpha}\right)$$

$$\times \left\{ \begin{array}{l} \frac{2}{\alpha q^2} \\ 1 \\ \frac{2M\omega}{\alpha^2} \ln^2(Z) \end{array} \right\} \frac{1}{\left[1 - \frac{\omega}{\alpha} \ln(Z)\right]^2} \exp \left\{ -m^2(\alpha-a) - P^2 \left[ \frac{\ln(Z)}{\alpha} - 1 \right] \ln(Z) \right\}$$

Equation (1) continued

Equation (1) continued

$$\times \left\{ \frac{(1 - \alpha_1 - \alpha_1')}{\alpha_1 \alpha_1' \left(\alpha_1 + \alpha_1' + \frac{1}{\omega - 1}\right)} \left[ \frac{\left(\alpha_1 + \alpha_1' + \frac{1}{\omega - 1}\right)^2}{\alpha_1 \alpha_1'} \right]^{\alpha_{23}} \right. \\ \left. \times \left[ \frac{\left(\frac{1}{\omega - 1}\right) \left(\alpha_1 + \alpha_1' + \frac{1}{\omega - 1}\right)}{\left(\alpha_1 + \frac{1}{\omega - 1}\right) \left(\alpha_1' + \frac{1}{\omega - 1}\right)} \right]^{-\alpha_t} \right\}, \quad (1)$$

where

$$\omega \equiv \frac{2P \cdot q}{-q^2} = 1 - \frac{(P+q)^2 - P^2}{q^2}, \\ a \equiv \ln \left[ \frac{\left(\alpha_1 + \alpha_1' + \frac{1}{\omega - 1}\right)^2}{\alpha_1 \alpha_1'} \right] \quad (2)$$

and

$$Z \equiv \left[ 1 + \frac{1}{(\omega - 1)\alpha_1} \right] \left[ 1 + \frac{1}{(\omega - 1)\alpha_1'} \right]$$

The three parameters in Eq. (1) are the parton's mass  $m$ , the parton-hadron channel intercept  $\alpha_{23}$  ( $= \alpha_{234}$ ), and the usual t-channel intercept  $\alpha_t$  ( $= \alpha_{34}$ ).

In obtaining Eq. (1), we have combined the electroproduction range  $1 < \omega < \infty$  with the colliding-beam range  $0 < \omega < 1$  into one set of formulas, by explicitly putting the  $\theta$ -function constraint to the range of integrations of  $\alpha_1$  and  $\alpha_2$  in Eq. (17), of Ref. 1. We then make a change of variables such that the range of integrations is independent of  $\omega$ .

A simple inspection of Eq. (1), then predicts (consider  $i = 2$ , spin- $\frac{1}{2}$  parton case only):

(a) the regge limit,  $\omega \rightarrow \infty$ ,

$$\begin{Bmatrix} F_1^{(2)} \\ F_2^{(2)} \end{Bmatrix} \sim \frac{\alpha_t}{\omega \ln|q^2|} \begin{Bmatrix} C \\ C' \omega^{-1} \end{Bmatrix} \quad (3a)$$

(b) the "fixed-angle" limits,  $\omega = 1 \pm \epsilon$ ,

$$\begin{Bmatrix} F_1^{(2)} \\ F_2^{(2)} \end{Bmatrix} \sim \frac{\ln|\omega - 1|}{\ln|q^2|} |\omega - 1|^{-2\alpha_{23}+1} \begin{Bmatrix} C \omega^{-2} \\ C' \omega^{-1} \end{Bmatrix}, \quad (3b)$$

(c) the threshold behaviors,  $\omega \rightarrow 1^\pm$ ,

$$\begin{Bmatrix} F_1^{(2)} \\ F_2^{(2)} \end{Bmatrix} \sim |\omega - 1|^{-2\alpha_{23}+1} \begin{Bmatrix} C \omega^{-2} \\ C' \omega^{-1} \end{Bmatrix}, \quad (3c)$$

which is correlated to the asymptotic, hadronic form factors

$$G(q^2) \underset{|q^2| \rightarrow \infty}{\sim} C \left( \frac{1}{q^2} \right)^{-\alpha_{23}+1}, \quad (3d)$$

by the relation  $p = -2\alpha_{23} + 1 = n - 1$ , where  $\frac{n}{2}$  is the power fall-off of the asymptotic form factors. And

(d) the pionization (nucleonization) limit,  $\omega \rightarrow 0$ ,

$$\begin{Bmatrix} F_1^{(2)} \\ F_2^{(2)} \end{Bmatrix} \sim \frac{\alpha_{23}+1}{\omega \ln|q^2|} \begin{Bmatrix} C \ln^{-1} \omega \\ C' \omega \ln^{-3} \omega \end{Bmatrix}. \quad (3e)$$

Taking  $\alpha_{23} = -1$  from the threshold behaviors in Eq. (3c), we predict that  $F_1^{(2)}$  behaves like  $\ln^{-1} \omega$ , and  $F_2^{(2)}$  vanishes like  $\omega \ln^{-3} \omega$ .

On examination of the predictions, Eqs. (3a) - (3e), shows that the representation, Eq. (1), is quite independent of the diseases of the dual resonance model, namely, the problems of ghosts, spins and internal symmetries, off mass shell extrapolations, and even the lack of complete unitarity. This is not surprising, since what is essential here, in the Bjorken limit, are the regge behaviors in various channels ( $\cong$  duality), together with a factorizable (pomeron) pole of intercept unity<sup>2</sup> [ $\alpha_{16} \equiv 1$  in Eq. (1)].

In this paper, we generalize this model to the deep inelastic inclusive reaction

$$l + h_1 \rightarrow l + h_2 + \text{anything}, \quad (4a)$$

and its cross reaction, that is, the colliding-beam reaction with the detection of two final-state particles

$$l + \bar{l} \rightarrow \bar{h}_1 + h_2 + \text{anything}. \quad (4b)$$

The mathematical work is straightforward, though slightly complicated, but the physics is quite fruitful. The outcome of this generalization unifies the electromagnetic scaling law (the generalized Bjorken scaling law) and the hadronic scaling law (the Feynman scaling law) into one set of formulas, describing all four structure functions for the two processes, Eqs. (4a) and (4b). The predictions of the model are analogous to the pure hadronic inclusive results,<sup>3</sup> as expected, but we would like to stress the essence of the strong interaction duality in obtaining these results.

## II. FORMULATION OF THE MODEL

Consider the spin-averaged, generalized virtual forward Compton scattering, depicted in Fig. 2. Particles 1, 2, 7, and 8 are the off-shell partons of field theoretical type, particle 3 is the final-state particle that we are going to detect, and particle 4 is the target hadron (in the electroproduction region). In the colliding-beam region, both the particles 3 and 4 are the detected final-state particles. Particles 5, 6 are the antiparticles of 4, 3; they have four-momenta of same magnitude but opposite signs to particles 4, 3. The dotted line in Fig. 2, indicates the correct imaginary part in the missing mass square variable that one should take, in order to obtain the structure functions.

Throughout this work, we are going to omit the discussion of the diagrams corresponding to the orderings (1, 2, 4, 3, X) and (3, 1, 2, 4, X), where X is the "anything." They can be calculated similarly to the ordering (1, 2, 3, 4, X), Fig. 2. The ordering (1, 2, 4, 3, X) cannot contribute to the fragmentation of the virtual photon, while the ordering (3, 1, 2, 4, X) cannot contribute to the fragmentation of the target. We also neglect the nonplanar loop diagrams throughout this paper.

We specify the kinematic variables

$$\omega_i \equiv \frac{2k_i \cdot q}{-q^2}, \quad i = 3, 4,$$

$$\tau \equiv \frac{2k_3 \cdot k_4}{-q^2}, \quad (5)$$

$$s_3 = (q + k_3)^2, \quad s_4 = (q + k_4)^2,$$

Equation (5) continued.

Equation (5) continued

$$s_{34} = (k_3 + k_4)^2,$$

$$s = (q + k_3 + k_4)^2 = M^{*2}, \quad (\text{the missing mass square}).$$

In the generalized Bjorken limit  $q^2 \rightarrow +\infty$ ,  $s_3 \rightarrow +\infty$ ,  $s, s_4 \rightarrow +\infty$ , but  $\omega_3, \omega_4$ , and  $\tau$  fixed, we have the relations

$$\begin{aligned} s_3 &\approx q^2(1 - \omega_3), \\ s_4 &\approx q^2(1 - \omega_4), \\ s &\approx q^2(1 - \omega_3 - \omega_4 - \tau). \end{aligned} \quad (6)$$

We now write down the model for the spin-averaged, generalized virtual forward Compton scattering

$$T_{\mu\nu}^{(i)} = \int d^4k_2 d^4k_7 \frac{K_{\mu\nu}^{(i)} \bar{B}_8(q-k_2, k_2, k_3, k_4; -k_4, -k_3, k_7, -q-k_7)}{[(k_2-q)^2 - m^2][(k_2)^2 - m^2](k_7^2 - m^2)[(q+k_7)^2 - m^2]}, \quad (7)$$

where<sup>1</sup>

$$K_{\mu\nu}^{(i)} = \begin{cases} -(2k_2 - q)_\mu (2k_7 + q)_\nu, & i = 1, \text{ for spin-0 partons,} \\ -(2k_2 - q)_\mu (2k_7 + q)_\nu + q^2 \left( g_{\mu\nu} - \frac{q_\mu q_\nu}{q^2} \right), & i = 2, \text{ for} \\ & \text{spin-}\frac{1}{2} \text{ partons.} \end{cases} \quad (8)$$

The four leg off-shell eight-point dual amplitude, in its standard form, is

$$\begin{aligned}
\bar{B}_8 &= \int_0^1 \frac{dx_1 dx_2 dz dy_1 dy_2}{(1-x_1)(1-x_2)(1-z)(1-y_1)(1-y_2)} (x_1 y_1)^{-\alpha_{12}(q)-1} \\
&\times (x_2 y_2)^{-\alpha_{123}(s_3)-1} z^{-\alpha_{1234}(s)-1} \\
&\times \left[ \left( \frac{1-x_1}{1-x_1 x_2} \right)^{-\alpha_{23}(k_2+k_3)} \left( \frac{1-x_1 x_2}{1-x_1 x_2 z} \right)^{-\alpha_{234}(k_2+k_3+k_4)} \right. \\
&\times \left. \left( \frac{1-x_1 x_2 z}{1-x_1 x_2 z y_2} \right)^{-\alpha_{2345}(k_2+k_3)} \left( \frac{1-x_1 x_2 z y_2}{1-x_1 x_2 z y_1 y_2} \right)^{-\alpha_{26}(k_2)} \right] \\
&\times \left[ \left( \frac{1-y_1}{1-y_1 y_2} \right)^{-\alpha_{23}(k_7-k_3)} \left( \frac{1-y_1 y_2}{1-z y_1 y_2} \right)^{-\alpha_{234}(k_7-k_3-k_4)} \right. \\
&\times \left. \left( \frac{1-z y_1 y_2}{1-x_2 z y_1 y_2} \right)^{-\alpha_{2345}(k_7-k_3)} \right. \\
&\times \left. \left( \frac{1-x_2 z y_1 y_2}{1-x_1 x_2 z y_1 y_2} \right)^{-\alpha_{26}(k_7)} \right] (1-x_1 x_2 z y_1 y_2)^{-\alpha_{18}(k_2+k_7)} \\
&\times \left[ \frac{(1-x_2)(1-x_1 x_2 z)(1-y_2)(1-z y_1 y_2)}{(1-x_1 x_2)(1-x_2 z)(1-y_1 y_2)(1-z y_2)} \right]^{-\alpha_{34}(k_3+k_4)} \\
&\times \left[ \frac{(1-x_2 z)(1-x_1 x_2 z y_2)(1-z y_2)(1-x_2 z y_1 y_2)}{(1-x_1 x_2 z)(1-x_2 z y_2)(1-z y_1 y_2)(1-x_2 z y_2)} \right]^{-\alpha_{345}(k_3)} \\
&\times \left[ \frac{(1-x_2 z y_2)(1-x_1 x_2 z y_1 y_2)}{(1-x_1 x_2 z y_2)(1-x_2 z y_1 y_2)} \right]^{-\alpha_{3456}(0)} \left[ \frac{(1-z)(1-x_2 z y_2)}{(1-x_2 z)(1-z y_2)} \right]^{-\alpha_{45}(0)}.
\end{aligned} \tag{9}$$

Because we use the generalized optical theorem to make a model for the cross section, all invariant variables belonging to the legs 1, 2, 3, and 4 must be analytically continued in opposite directions<sup>3,1</sup> to those belonging to the legs 5, 6, 7, and 8. We indicate this by a "bar" over  $B_8$ . We assign different regge intercepts to the following channels: the parton-hadron channels,  $\alpha_{23}$  ( $= \alpha_{234} = \alpha_{2345} = \alpha_{26}$ ); the parton-parton channel  $\alpha_{18}$ ; the hadron-hadron channels  $\alpha_0$  ( $= \alpha_{34} = \alpha_{345} = -k_3^2 = -k_4^2$ ); and the two channels having the quantum number of the vacuum,  $\alpha_{3456}$  and  $\alpha_{45}$ .

Carrying out the double-loop integrals over  $k_2$  and  $k_7$ , we get

$$\begin{aligned}
T_{\mu\nu}^{(i)} &= \int_0^\infty da_1 da_2 da_7 da_8 d(\ln \frac{1}{x_1}) d(\ln \frac{1}{x_2}) d(\ln \frac{1}{z}) d(\ln \frac{1}{y_1}) d(\ln \frac{1}{y_2}) \\
&\times K_{\mu\nu}^{(i)}(G) \frac{\pi^4}{C^2} \exp(-J) \exp[q^2 \ln(\frac{1}{x_1 y_1}) + s_3 \ln(\frac{1}{x_2 y_2}) + s(\ln \frac{1}{z}) \\
&\quad + q^2(a_1 + a_8)F],
\end{aligned} \tag{10}$$

where  $K_{\mu\nu}^{(i)}$ ,  $(G)$ ,  $C$ ,  $J$ , and  $F$  have explicit forms, but we only mention that  $F$  is a function of  $\omega_3$  and  $\omega_4$ .

As  $q^2$ ,  $s_3$ , and  $s \rightarrow -\infty$ , we require the sum of terms in the last exponent of Eq. (10) to be negative definite. This can be so, if  $\omega_3 < 1$  and  $s/q^2 > 0$ . Because  $q^2$  and  $s_3$  go to infinity in the same order as  $s$ , and because later on we only want to take the imaginary part across the variable  $s$ , we have to disentangle the extra pieces of imaginary parts that will be contributed from  $s_3$  and  $F$ . In other words, we need to factorize the  $s$ -dependent factor from the

$s_3$ - and  $F$ -dependent factors. The unique way to perform the scale transformation, therefore, is

$$\begin{aligned}
a'_1 &= a_1 F, \\
a'_8 &= a_8 F, \\
\ln \frac{1}{x_1} &= \rho \beta_1, & \ln \frac{1}{y_1} &= \rho \beta'_1, \\
\ln \frac{1}{x_2} &= \left(\frac{q^2}{s_3}\right) \rho \beta_2, & \ln \frac{1}{y_2} &= \left(\frac{q^2}{s_3}\right) \rho \beta'_2, & \left(\frac{q^2}{s_3}\right) &> 0, \\
\ln \frac{1}{z} &= \rho \beta_3, \\
a'_1 &= \rho \beta_4, \\
a'_8 &= \rho(1 - \beta_1 - \beta'_1 - \beta_2 - \beta'_2 - \beta_3 - \beta_4), \\
1 - \beta_1 - \beta'_1 - \beta_2 - \beta'_2 - \beta_3 - \beta_4 &> 0.
\end{aligned} \tag{11}$$

Then the last exponential factor in Eq. (10), becomes

$$\exp\left\{q^2 \rho \left[1 - \left(1 - \frac{s}{q^2}\right) \beta_3\right]\right\}. \tag{12}$$

We then expand everything else in terms of  $\rho$ ,  $\beta_i$ , and  $\beta'_i$ , set  $\ln \rho^{-1} \approx \ln |q^2|$ , and do the  $\rho$  integral. We further set  $\alpha_{18} \equiv 1$ .

Now we can keep  $q^2$  at  $-\infty$ , and analytically continue  $s$  to  $+\infty$ , and take the imaginary part in  $s$ , which amounts to setting  $\beta_3 = \left(1 - \frac{s}{q^2}\right)^{-1}$  in the integrand, together with the  $\Theta$ -function constraint  $\Theta\left[1 - \beta_1 - \beta'_1 - \beta_2 - \beta'_2 - \left(1 - \frac{s}{q^2}\right)^{-1}\right]$ . We thus obtain the structure tensor of electroproduction (because  $s/q^2 < 0$ ), defined by

$$\begin{aligned}
W_{\mu\nu}^{(i)} &= \text{Im}_s T_{\mu\nu}^{(i)} = \frac{1}{2} \sum_{\ell, j=3,4} \\
&\times \left[ \left( k_\ell - \frac{k_\ell \cdot q}{q^2} q \right)_\mu \left( k_j - \frac{k_j \cdot q}{q^2} q \right)_\nu + (\ell \leftrightarrow j) \right] \frac{W_2^{(i)}(\ell j)}{M^2} \\
&\quad - \left( g_{\mu\nu} - \frac{q_\mu q_\nu}{q^2} \right) W_1^{(i)}, \tag{13}
\end{aligned}$$

where  $M$  is the mass of the nucleon target.

We can now further analytically continue  $W_{\mu\nu}^{(i)}$  into the colliding-beam region, by keeping  $s$  at  $+\infty$  and continuing  $q^2$  (through the complex  $q^2$ -plane) to  $+\infty$ , i.e., to the region  $1 > \frac{s}{q^2} > 0$ . This amounts to putting the  $\Theta$ -function constraint to the upper limit of the range of integrations of  $\beta_1$ ,  $\beta'_1$ ,  $\beta_2$ , and  $\beta'_2$ , namely  $1 - \beta_1 - \beta'_1 - \beta_2 - \beta'_2 - \left(1 - \frac{s}{q^2}\right)^{-1} \geq 0$ . We then make the change of variables

$$\begin{aligned}
\beta_i &= \left[ 1 - \left(1 - \frac{s}{q^2}\right)^{-1} \right] \alpha_i, \\
\beta'_i &= \left[ 1 - \left(1 - \frac{s}{q^2}\right)^{-1} \right] \alpha'_i, \quad i = 1, 2,
\end{aligned} \tag{14}$$

such that the range of integrations of  $\alpha_1$ ,  $\alpha'_1$ ,  $\alpha_2$ , and  $\alpha'_2$  is independent of  $s/q^2$ , and satisfies the relation

$1 - \alpha_1 - \alpha'_1 - \alpha_2 - \alpha'_2 \geq 0$ . In this way, we obtain a single set of formulas covering the whole range  $0 < \left(1 - \frac{s}{q^2}\right) < \infty$ , of which  $0 < \left(1 - \frac{s}{q^2}\right) < 1$  is the colliding-beam range, and  $1 < \left(1 - \frac{s}{q^2}\right) < \infty$  is the electroproduction range.



We further reduce<sup>1</sup> the double integrals over  $a_2$  and  $a_7$  into a single integral over  $\alpha \equiv a_2 + a_7$ . Then we introduce two new "hadronic" scaling variables  $y_1$  and  $y_2$ :

$$y_1 \equiv \frac{s}{-q^2} \underset{bj.}{\rightsquigarrow} (\omega_3 + \omega_4 + \tau - 1), \quad (15)$$

$$y_2 \equiv \frac{s}{-s_3} = \frac{y_1}{1 - \omega_3} \underset{bj.}{\rightsquigarrow} \left( \frac{\omega_3 + \omega_4 + \tau - 1}{1 - \omega_3} \right).$$

Now we can compare the result with the gauge invariant form, Eq. (13), near the point of fixed missing mass,<sup>1</sup> i.e.,  $\frac{s}{-q^2} \rightarrow 0$ . We finally obtain the explicit formulas for the structure functions

$$[(k_\ell + k_j) \cdot q] W_2^{(i)}(\ell j) \rightarrow 2M F_2^{(i)}(\ell j), \quad \ell, j = 3, 4, \\ W_1^{(i)} \rightarrow F_1^{(i)}.$$

They are

$$\left\{ \begin{array}{l} F_1^{(1)} \\ F_1^{(2)} \\ F_2^{(1)}(33) = F_2^{(2)}(33) \\ F_2^{(1)}(44) = F_2^{(2)}(44) \\ F_2^{(1)}(34) = F_2^{(2)}(34) \end{array} \right\} = \frac{\pi}{\ln|q^2|} \int_0^{1 - \alpha_1 - \alpha_1' - \alpha_2 - \alpha_2' \geq 0} d\alpha_1 d\alpha_1' d\alpha_2 d\alpha_2'$$

Equation (17) continued

Equation (17) continued

$$\times \left\{ \begin{array}{l} \frac{2}{\alpha q^2} \\ 1 \\ \frac{2M}{\alpha^2} \omega_3 \ln^2(Z_3) \\ \frac{2M}{\alpha^2} \omega_4 \ln^2(Z_4) \\ \frac{2M}{\alpha^2} (\omega_3 + \omega_4) \ln(Z_3) \ln(Z_4) \end{array} \right\} \\ \times \frac{1}{\left[1 - \frac{1}{\alpha} [\omega_3 \ln(Z_3) + \omega_4 \ln(Z_4)]\right]^2} \\ \times \exp\{-m^2(\alpha - a) - \frac{1}{\alpha} [k_3 \ln(Z_3) + k_4 \ln(Z_4)]^2\} \\ \times \left\{ \frac{y_1 (1 - \alpha_1 - \alpha_1' - \alpha_2 - \alpha_2')}{\alpha_1 \alpha_1' \alpha_2 \alpha_2' [1 + y_1 (\alpha_1 + \alpha_1') + y_2 (\alpha_2 + \alpha_2')]} \left[ \frac{(1 + y_1 (\alpha_1 + \alpha_1') + y_2 (\alpha_2 + \alpha_2'))^2}{(y_1 \alpha_1) (y_1 \alpha_1')} \right]^{\alpha_{23}} \right. \\ \times \left[ \frac{(1 + y_1 \alpha_1 + y_2 (\alpha_2 + \alpha_2')) (1 + y_1 \alpha_1' + y_2 (\alpha_2 + \alpha_2'))}{(y_1 \alpha_1) (y_1 \alpha_1')} \right]^{-\alpha_0} \left[ \frac{(1 + y_2 \alpha_2) (1 + y_2 \alpha_2')}{(y_2 \alpha_2) (y_2 \alpha_2')} \right]^{\alpha(k_3 + k_4)} \\ \times \left[ \frac{(1 + y_2 (\alpha_2 + \alpha_2')) (1 + y_1 (\alpha_1 + \alpha_1') + y_2 (\alpha_2 + \alpha_2'))}{(1 + y_1 \alpha_1 + y_2 (\alpha_2 + \alpha_2')) (1 + y_1 \alpha_1' + y_2 (\alpha_2 + \alpha_2'))} \right]^{-\alpha_{3456}} \\ \left. \times \left[ \frac{(1 + y_2 (\alpha_2 + \alpha_2'))}{(1 + y_2 \alpha_2) (1 + y_2 \alpha_2')} \right]^{-\alpha_{45}} \right\}, \quad (17)$$

where

$$a \equiv \ln \left\{ \frac{[1 + y_1(\alpha_1 + \alpha'_1) + y_2(\alpha_2 + \alpha'_2)]^2}{(y_1\alpha_1)(y_1\alpha'_1)} \right\}, \quad (18)$$

$$Z_3 \equiv \frac{[1 + y_1\alpha_1 + y_2(\alpha_2 + \alpha'_2)][1 + y_1\alpha'_1 + y_2(\alpha_2 + \alpha'_2)]}{(y_1\alpha_1)(y_1\alpha'_1)},$$

and

$$Z_4 \equiv \frac{(1 + y_1\alpha_1 + y_2\alpha_2)(1 + y_1\alpha'_1 + y_2\alpha'_2)}{(y_1\alpha_1 + y_2\alpha_2)(y_1\alpha'_1 + y_2\alpha'_2)}.$$

We see that, apart from the factor  $\ln^{-1}|q^2|$ , Eq. (17) is a function of the scaling variables  $\omega_3$  and  $\omega_4$ , or  $y_1$  and  $y_2$ , together with  $p_{\perp}^2$  and  $p_{\parallel}^2$  in  $s_{34} \equiv (k_3 + k_4)^2$ . In deriving Eq. (17), we have kept the momentum transfer  $s_{34}$  fixed.

Equation (17) is true for both  $q^2 > 0$  and  $q^2 < 0$ , i.e., it holds for both the electroproduction and the colliding-beam reactions.

### III. PREDICTIONS FOR THE INCLUSIVE REACTIONS

We consider the spin- $\frac{1}{2}$  partons case only. We adopt the experimental fact that the scaling behavior sets in at finite  $q^2$  (of the order  $1 \text{ GeV}^2$ ), we will assume Eq. (17) is valid for large but finite  $q^2$ .

We first discuss the electroproduction process

$\ell + h_4 \rightarrow \ell + h_3 + \text{anything}$ . Since  $q^2 < 0$  in this process, the incident energy  $s_4 \approx q^2(1 - \omega_4) > 0$ , the first momentum transfer  $s_3 \approx q^2(1 - \omega_3) < 0$ , the second momentum transfer  $s_{34} = (k_3 + k_4)^2 < 0$ , and the missing mass square  $s \approx q^2(1 - \omega_3 - \omega_4) + s_{34} > 0$ .

A. The Fragmentation of the Target,  $0 < x < 1$ .

This is the limit

$$\left. \begin{array}{l} s_4 \rightarrow +\infty \\ s_3 \rightarrow -\infty \end{array} \right\}, \quad x \approx \frac{-s_3}{s_4}, \quad (19)$$

$$\frac{s}{s_4} \approx 1 - x,$$

$$s_{34} \approx -\frac{(1-x)^2}{x} M^2 - \frac{p_{\perp}^2}{x} = \text{fixed},$$

where  $x \equiv 2p_{\parallel}^c / (s_4)^{\frac{1}{2}}$  is the Feynman's scaling variable. By the finite assumption of  $q^2$ , the limit is equivalent to

$$\left. \begin{array}{l} \omega_4 \rightarrow +\infty \\ \omega_3 \rightarrow -\infty \end{array} \right\}, \quad x \approx \frac{-\omega_3}{\omega_4}, \quad 0 < x < 1, \quad (20)$$

$$\left. \begin{array}{l} y_1 \equiv \frac{s}{-q^2} \rightarrow +\infty \\ y_2 \equiv \frac{s}{-s_3} = \frac{y_1}{1 - \omega_3} \approx \frac{1 - x}{x} \end{array} \right\}, \quad \frac{y_1}{y_2} \rightarrow +\infty.$$

Hence, from Eq. (17), we get

$$\left\{ \begin{array}{l} F_1^{(2)} \\ F_2^{(2)}(33) \\ F_2^{(2)}(44) \\ F_2^{(2)}(34) \end{array} \right\} \sim \frac{1}{\ln|q^2|} \left\{ \begin{array}{l} g_1(x, p_\perp^2) \omega_4^{\alpha_{3456}} \\ g_2(x, p_\perp^2) \omega_3^{\alpha_{3456}-1} \\ g_3(x, p_\perp^2) \omega_4^{\alpha_{3456}-1} \\ g_4(x, p_\perp^2) (\omega_3 + \omega_4)^{\alpha_{3456}-1} \end{array} \right\}. \quad (21)$$

We see that,  $F_2^{(2)}(33)$ ,  $F_2^{(2)}(44)$ ,  $F_2^{(2)}(34)$  approach limit distributions if  $\alpha_{3456} \equiv 1$ . The dominant duality diagram is Fig. 3.

B. The First Triple-reggeon Limit,  $x \rightarrow 1$ .

From Eq. (20), taking  $y_2 \approx 1 - x \rightarrow 0$  in Eq. (17), we find

$$\left\{ \begin{array}{l} F_1^{(2)} \\ F_2^{(2)}(33) \\ F_2^{(2)}(44) \\ F_2^{(2)}(34) \end{array} \right\} \sim \frac{1}{\ln|q^2|} (1-x)^{-2\alpha(s_{34}) + \alpha_{3456}} \left\{ \begin{array}{l} C_1 \omega_3^{\alpha_{3456}} \\ C_2 (1-x)^{-2} \omega_3^{\alpha_{3456}-1} \\ C_3 (1-x)^{-2} \omega_4^{\alpha_{3456}-1} \\ C_4 (1-x)^{-1} \omega_3^{\alpha_{3456}-1} \end{array} \right\}, \quad (22)$$

where  $C_i$  have explicit forms. The dominant duality diagram is Fig.

4.

C. The First Pionization Limit,  $x \rightarrow 0$ .

From Eqs. (19) and (20), taking  $x \rightarrow 0$  in Eq. (17), shows that we need to consider the region  $\alpha_2 \approx \frac{1}{2}$ ,  $\alpha_2' \approx \frac{1}{2}$ . Hence we get

$$\left\{ \begin{array}{l} F_1^{(2)} \\ F_2^{(2)}(33) \\ F_2^{(2)}(44) \\ F_2^{(2)}(34) \end{array} \right\} \sim \frac{p_\perp^{-3}}{\ln|q^2|} x^{\alpha_{3456} - \alpha_{45}} \exp \left[ \frac{2}{x} (p_\perp^2 + M^2) \ln \left( \frac{1+x}{1-x} \right) \right]$$

$$\times \left\{ \begin{array}{l} C_1 \omega_4^{\alpha_{3456}} \\ C_2 x^{-1} \omega_4^{\alpha_{3456}-1} \\ C_3 \omega_4^{\alpha_{3456}-1} \\ C_4 \omega_4^{\alpha_{3456}-1} \end{array} \right\}. \quad (23)$$

We see that  $F_2^{(2)}(44)$  and  $F_2^{(2)}(34)$  have finite pionization limits, if  $\alpha_{3456} = \alpha_{45} = 1$ , while  $F_2^{(2)}(33)$  diverges like  $\frac{1}{x}$ . This divergent behavior shows that the average multiplicity distribution is  $\langle n \rangle = a \ln s + b$ , which disagrees with the conclusion  $\langle n \rangle \approx \ln \left| \frac{s}{2} \right|$ , in the naive parton model and the multiperipheral model. The reason for this disagreement can be understood by the fact that the above-mentioned models do not have the final-state interactions, which should give a "form factor" to the photon-partons vertex, hence produces

extra  $\ln|q^2|$  multiplicities. Another important feature in Eq. (23) is that the transverse momentum  $p_{\perp}^2$  has the universal cut-off of  $\exp(-4p_{\perp}^2)$ , (if  $p_{\perp}^2 \gg M^2$ ), as in the hadronic case.<sup>3</sup> The dominant duality diagram is Fig. 5.

D. The Fragmentation of the Heavy Virtual Photon,  $0 < x' < 1$ .

This is the limit

$$\left. \begin{array}{l} s_4 \rightarrow +\infty \\ s_{34} \rightarrow -\infty \end{array} \right\}, \quad x' \approx \frac{-s_{34}}{s_4}, \quad 0 < x' < 1, \quad (24)$$

$$\frac{s}{s_4} \approx 1 - x',$$

$$s_3 = \text{fixed}.$$

Strictly speaking, Eq. (17) is not applicable to this limit, since in the derivation of Eq. (17), we have assumed  $s_3 \rightarrow -\infty$ , and  $s_{34} = \text{finite}$ . However, because of the finite assumption of  $q^2$ , we nevertheless still assume that we can take  $s_{34} \rightarrow -\infty$  in Eq. (17). In Appendix A, we give an ad hoc alternative derivation of this limit, by first letting  $s, s_{34} \rightarrow +\infty$ , then take  $q^2 \rightarrow -\infty$ . It gives similar results.

The limit of Eq. (24), is equivalent to

$$\left. \begin{array}{l} \omega_4 \rightarrow +\infty \\ \omega_3 = \text{fixed} < 1 \end{array} \right\}, \quad x' \approx \frac{-\tau}{\omega_4}, \quad 0 < x' < 1,$$

$$\left. \begin{array}{l} y_1 \rightarrow +\infty \\ y_2 \rightarrow +\infty \end{array} \right\}, \quad \frac{y_1}{y_2} = 1 - \omega_3 > 0, \quad (25)$$

$$\frac{\omega_4}{y_2} \approx \frac{1 - \omega_3}{1 - x'}.$$

From Eqs. (17) and (25), we then find

$$\left\{ \begin{array}{l} F_1^{(2)} \\ F_2^{(2)}(33) \\ F_2^{(2)}(44) \\ F_2^{(2)}(34) \end{array} \right\} \sim \frac{1}{\ln|q^2|} \left\{ \begin{array}{l} h_1(x', \omega_3, p_{\perp}^2) y_2^{\alpha_{45}} \\ h_2(x', \omega_3, p_{\perp}^2) y_2^{\alpha_{45}} \\ h_3(x', \omega_3, p_{\perp}^2) y_2^{\alpha_{45}-1} \\ h_4(x', \omega_3, p_{\perp}^2) y_2^{\alpha_{45}} \end{array} \right\}. \quad (26)$$

The relation among  $q^2$ ,  $x'$ ,  $\omega_3$ ,  $p_{\perp}^2$  is

$$s_3 \approx q^2(1 - \omega_3) \approx -\frac{(1 - x')^2}{x'} M^2 - \frac{p_{\perp}^2}{x'}. \quad (27)$$

We see that  $F_2^{(2)}(44)$  has limit distribution, if  $\alpha_{45} \equiv 1$ . The dominant duality diagram is Fig. 6.

E. The "Four-reggeon" Limit  $\omega_3 = 1 - \epsilon$ ,  $0 < x' < 1$ .

Take  $\omega_3 = 1 - \epsilon$ ,  $\epsilon = \text{finite}$ , in Eqs. (25) and (17), we get

$$\left\{ \begin{array}{l} F_1^{(2)} \\ F_2^{(2)}(33) \\ F_2^{(2)}(44) \\ F_2^{(2)}(34) \end{array} \right\} \sim \frac{\ln\left(\frac{1}{1 - \omega_3}\right)}{\ln|q^2|} (1 - \omega_3)^{-2\alpha_{23}+1}$$

$$\times \left\{ \begin{array}{l} h_1(x', p_{\perp}^2) y_2^{\alpha_{45}} \\ h_2(x', p_{\perp}^2) y_2^{\alpha_{45}} \\ h_3(x', p_{\perp}^2) y_2^{\alpha_{45}-1} (1 - \omega_3) \ln^{-2}\left(\frac{1}{1 - \omega_3}\right) \\ h_4(x', p_{\perp}^2) y_2^{\alpha_{45}} (1 - \omega_3) \ln^{-1}\left(\frac{1}{1 - \omega_3}\right) \end{array} \right\}. \quad (28)$$

The dominant duality diagram is Fig. 7.

F. The Second Triple-reggeon Limit,  $x' \rightarrow 1$ ,

Taking the limit  $x' \rightarrow 1$ ,  $\omega_3 \rightarrow 1$  ( $s_3$  is fixed at resonance masses), but  $(1 - \omega_3)/(1 - x') = \text{fixed}$ , in Eqs. (25), (28), and (17), we get

$$\left\{ \begin{array}{l} F_1^{(2)} \\ F_2^{(2)}(33) \\ F_2^{(2)}(44) \\ F_2^{(2)}(34) \end{array} \right\} \sim (1 - x')^{-2\alpha_{23}+1} \left\{ \begin{array}{l} \alpha_{45} \\ C_1 y_2 \\ \alpha_{45} \\ C_2 y_2 \\ \alpha_{45}^{-1} \ln^{-2} \left( \frac{1}{1 - x'} \right) \\ C_3 y_2 \\ \alpha_{45} \\ C_4 y_2 \ln^{-1} \left( \frac{1}{1 - x'} \right) \end{array} \right\} \quad (29)$$

The dominant diagram is Fig. 8.

Now we discuss several limits for both the electroproduction and the colliding-beam reactions.

G. The "Fixed-angle" Limits,  $y_1 \equiv \frac{s}{-q^2} = \pm \epsilon$ ,

These are the limits  $s/(-q^2) = \pm \epsilon$ ,  $\epsilon$  finite, and  $s_{34} = \text{fixed}$ .

Both  $y_1$  and  $y_2$  are small in these limits, we then get, from Eq. (17),

$$\left\{ \begin{array}{l} F_1^{(2)} \\ F_2^{(2)}(33) \\ F_2^{(2)}(44) \\ F_2^{(2)}(34) \end{array} \right\} \sim \frac{\ln |y_1|}{\ln |q^2|} y_1^{-2\alpha_{23}+1} \left\{ \begin{array}{l} C_1(s_{34}) \\ C_2(s_{34})\omega_3 \\ C_3(s_{34})\omega_4 \\ C_4(s_{34})(\omega_3 + \omega_4) \end{array} \right\} \quad (30)$$

The dominant duality diagram is Fig. 9.

H. The Generalized Threshold Behaviors of Bloom and Gilman,

$$y_1 \rightarrow 0^\pm.$$

Taking the limit  $y_1 \rightarrow 0^\pm$  in Eqs. (30) and (17), we get

$$\left\{ \begin{array}{l} F_1^{(2)} \\ F_2^{(2)}(33) \\ F_2^{(2)}(44) \\ F_2^{(2)}(34) \end{array} \right\} \sim y_1^{-2\alpha_{23}+1} \left\{ \begin{array}{l} C_1(s_{34}) \\ C_2(s_{34})\omega_3 \\ C_3(s_{34})\omega_4 \\ C_4(s_{34})(\omega_3 + \omega_4) \end{array} \right\} \quad (31)$$

Because the missing masses  $s$  are fixed at resonances, the dominant duality diagram is Fig. 10. These generalized threshold behaviors still correctly connect with the asymptotic form factors<sup>1</sup> (also generalized)

$$G(q^2, s_{34}) \underset{|q^2| \rightarrow \infty}{\sim} \left( \frac{1}{q^2} \right)^{-\alpha_{23}+1} C(s_{34}), \quad (32)$$

by the relation  $p = -2\alpha_{23} + 1 = n - 1$ , (in the  $q^2$ -dependent factors).

Finally, we consider the colliding-beam region ( $q^2 > 0$ ).

I. The Second Pionization Limit,  $y_1 \rightarrow -1$ .

Since  $q^2 > 0$ ,  $s_{34} = \text{fixed}$ , and  $\omega_3 > 0$ , we need to consider  $\omega_3, \omega_4, \tau \rightarrow 0$ , i.e.,  $y_1 \approx y_2 \approx -1$ . The behavior is enhanced by the pinch of  $\alpha_1$ ,  $\alpha'_1$ ,  $\alpha_2$ , and  $\alpha'_2$  at the upper limit of the range of integrations of Eq. (17). We find

$$\left\{ \begin{array}{l} F_1^{(2)} \\ F_2^{(2)}(33) \\ F_2^{(2)}(44) \\ F_2^{(2)}(34) \end{array} \right\} \sim \frac{1}{y_1 \rightarrow -1} \frac{1}{\ln|q^2|} \frac{1}{\ln(1+y_1)} (1+y_1)^{-2\alpha(s_{34})+\alpha_{23}+1}$$

$$\times \left\{ \begin{array}{l} C_1 \\ C_2 \omega_3 \ln^{-1}(1+y_1) \\ C_3 \omega_4 \ln^{-2}(1+y_1) \\ C_4 (\omega_3 + \omega_4) \ln^{-2}(1+y_1) \end{array} \right\} \quad (33)$$

We see that  $F_2^{(2)}(34)$  behaves like  $(\omega_3 + \omega_4)^{-2\alpha(s_{34})+1} \times \ln^{-3}(\omega_3 + \omega_4)$ , if  $\alpha_{23} = -1$  (i.e., the target hadron is a nucleon).  
The dominant duality diagram is Fig. 11.

IV. FURTHER GENERALIZATION

Further generalization to the reactions

$$l + h_{n+2} \rightarrow l + h_3 + h_4 + \dots + h_{n+1} + \text{anything}, \quad (34a)$$

$$l + \bar{l} \rightarrow h_3 + h_4 + \dots + h_{n+1} + \bar{h}_{n+2} + \text{anything}, \quad (34b)$$

are straightforward. We define the kinematic variables

$$\begin{aligned} s_2 &\equiv q^2 \\ s_i &\equiv (q + k_3 + \dots + k_i)^2, \quad i = 3, \dots, n+1, \\ s_{ij} &\equiv (k_i + k_{i+1} + \dots + k_j)^2, \quad 3 \leq i < j \leq n+2, \\ s &\equiv (q + k_3 + \dots + k_{n+2})^2 = M^{*2}, \end{aligned} \quad (35a)$$

the scaling variables

$$\begin{aligned} \omega_i &\equiv \frac{2k_i \cdot q}{-q^2}, \quad i = 3, 4, \dots, n+2, \\ \tau_{ij} &\equiv \frac{2k_i \cdot k_j}{-q^2}, \quad 3 \leq i < j \leq n+2, \end{aligned} \quad (35b)$$

and the hadronic scaling variables

$$y_i \equiv \frac{s}{-s_{i+1}} \approx \frac{\left( \sum_{j=3}^{n+2} \omega_j + \sum_{3 \leq j < l \leq n+2} \tau_{jl} - 1 \right)}{\left( 1 - \sum_{j=3}^i \omega_j - \sum_{3 \leq j < l \leq i} \tau_{jl} \right)}, \quad i = 1, \dots, n. \quad (35c)$$

Further define the structure functions

$$W_{\mu\nu}^{(i)} = \frac{1}{2} \sum_{\ell, j=3}^{n+2} \left[ \left( k_\ell - \frac{k_\ell \cdot q}{q^2} \right)_\mu \left( k_j - \frac{k_j \cdot q}{q^2} \right)_\nu + (\ell \leftrightarrow j) \right] \frac{W_2^{(i)}(\ell j)}{M^2} - \left( g_{\mu\nu} - \frac{q_\mu q_\nu}{q^2} \right) W_1^{(i)}, \quad i = 1, 2, \quad (35d)$$

with

$$W_1^{(i)} \rightarrow F_1^{(i)}, \quad (35e)$$

$$[(k_\ell + k_j) \cdot q] W_2^{(i)}(\ell j) \rightarrow 2MF_2^{(2)}(\ell j), \quad \ell, j = 3, \dots, n+2.$$

We then write down the representation

$$\left\{ \begin{array}{l} F_1^{(1)} \\ F_1^{(2)} \\ F_2^{(1)}(\ell j) = F_2^{(2)}(\ell j) \end{array} \right\} = \frac{\pi^4}{\ln|q|^2} \int_0^{Z \geq 0} \prod_{i=1}^n \left( \frac{d\alpha_i d\alpha'_i}{\alpha_i \alpha'_i} \right) \times \left\{ \begin{array}{l} \frac{2}{\alpha q^2} \\ 1 \\ \frac{2M}{\alpha^2} (\omega_\ell + \omega_j) \ln Z_\ell \ln Z_j \end{array} \right\}$$

Equation (36) continued

Equation (36) continued

$$\begin{aligned} & \times \frac{1}{\left[ 1 - \frac{1}{\alpha} \left( \sum_{i=3}^{n+2} \omega_i \ln Z_i \right) \right]^2} \exp \left[ -m^2(\alpha - a) - \frac{1}{\alpha} \left( \sum_{i=3}^{n+2} k_i \ln Z_i \right)^2 \right] \\ & \times \left\{ \frac{y_1 [1 - \sum (\alpha_i + \alpha'_i)]}{[1 + \sum y_i (\alpha_i + \alpha'_i)]} \left[ \frac{(1 + \sum y_i (\alpha_i + \alpha'_i))^2}{(y_1 \alpha_1)(y_1 \alpha'_1)} \right]^{\alpha_{23}} \right. \\ & \times \left[ \frac{(1 + y_1 \alpha_1 + \sum_{i=2}^n y_i (\alpha_i + \alpha'_i))(1 + y_1 \alpha'_1 + \sum_{i=2}^n y_i (\alpha_i + \alpha'_i))}{(y_1 \alpha_1)(y_1 \alpha'_1)} \right]^{-\alpha_0} \\ & \times \prod_{i=4}^{n+2} \left[ \frac{(y_1 \alpha_1 + \dots + y_{i-2} \alpha_{i-2})(Y_1 + 1 + Y'_i)}{(y_1 \alpha_1 + \dots + y_{i-1} \alpha_{i-1})(Y_1 + 1 + Y'_i)} (\alpha \leftrightarrow \alpha') \right]^{-\alpha(s_{3i})} \\ & \times \prod_{3 \leq i < j \leq n+2} \left[ \frac{(y_{i-1} \alpha_{i-1} + \dots + y_{j-2} \alpha_{j-2})(y_{i-2} \alpha_{i-2} + \dots + y_{j-1} \alpha_{j-1})}{(y_{i-2} \alpha_{i-2} + \dots + y_{j-2} \alpha_{j-2})(y_{i-1} \alpha_{i-1} + \dots + y_{j-1} \alpha_{j-1})} (\alpha \leftrightarrow \alpha') \right. \\ & \times \left. \left. \frac{(Y_{i-1} + 1 + Y'_j)(Y_{i-2} + 1 + Y'_{j-1})}{(Y_{i-2} + 1 + Y'_j)(Y_{i-1} + 1 + Y'_{j-1})} (\alpha \leftrightarrow \alpha') \right]^{-\alpha(s_{ij})} \right. \\ & \times \left. \left. \prod_{i=1}^n \frac{(1 + \sum_{j=i+1}^n y_j (\alpha_j + \alpha'_j))(1 + \sum_{j=1}^n y_j (\alpha_j + \alpha'_j))}{(1 + y_i \alpha_i + \sum_{j=i+1}^n y_j (\alpha_j + \alpha'_j))(1 + y_i \alpha'_i + \sum_{j=i+1}^n y_j (\alpha_j + \alpha'_j))} \right]^{-\alpha_t(0)} \right\}, \quad (36) \end{aligned}$$

where

$$Z \equiv 1 - \sum_{i=1}^n (\alpha_i + \alpha'_i) = 1 - \sum (\alpha_i + \alpha'_i),$$

$$\alpha_{n+1} y_{n+1} \equiv \alpha'_{n+1} y_{n+1} \equiv 1,$$

$$Y_i = y_i \alpha_i + y_{i+1} \alpha_{i+1} + \dots + y_n \alpha_n, \quad i \leq n,$$

$$Y'_i = y_n \alpha'_n + y_{n-1} \alpha'_{n-1} + \dots + y_i \alpha'_i, \quad i \leq n,$$

$$1 + Y'_i \equiv 1, \quad \text{if } i > n,$$

$$a \equiv \ln \left\{ \frac{\left[ 1 + \sum_{i=1}^n y_i (\alpha_i + \alpha'_i) \right]^2}{(y_1 \alpha_1)(y_1 \alpha'_1)} \right\}, \quad (37)$$

$$Z_i \equiv \frac{(Y_1 + 1 + Y'_{i-1})(Y'_1 + 1 + Y_{i-1})}{(y_1 \alpha_1 + \dots + y_{i-2} \alpha_{i-2})(y_1 \alpha'_1 + \dots + y_{i-2} \alpha'_{i-2})},$$

$$k_i \equiv -k_{2n+5-i}, \quad 3 \leq i \leq n+2.$$

Various limiting cases again can be discussed in a similar way to the previous section. Different duality diagrams will play different dominant roles. We will not elaborate further. We also omit the discussion of the permutations of external legs, since they can be calculated in similar ways.

## V. CONCLUSION

This paper shows that the parton dual resonance model unifies the electroproduction and the colliding-beam reactions. It further unifies the (generalized) Bjorken scaling law with the Feynman scaling law. The fragmentation of the target, as well as the fragmentation of the heavy virtual photon, are predicted to exist. Intuitively, this means that there are "slow" particles in the lab. system, as well as "fast" particles travelling in the direction of the virtual photon's three momentum  $\vec{q}$ . The central region (the pionization limit) again shows an exponentially cut-off of  $\exp(-4p_{\perp}^2)$ , as in the hadronic inclusive case,<sup>3</sup> and the average multiplicity is predicted to be  $\langle n \rangle = a \ln s + b$ , where  $s$  is the missing mass square. Different duality diagrams are shown to dominate different limiting regions. The important role of duality in the dynamical part of these reactions is clearly demonstrated.

The usual diseases of the dual resonance model, namely, the ghost problem, the incorporation of spins and internal symmetries, the problem of off mass shell extrapolation, and even the lack of complete unitarity, all in all, do not play any fundamental roles in this model. This is because, in the Bjorken limits, it is the regge behaviors in various channels (duality  $\cong$  regge behaviors in all channels), together with (factorizable) pomeron poles of intercept unity that sufficiently determine the theory. The unitarity corrections, or the higher order loop corrections, may modify the numerical value of the exponentially cut-off behavior in the central region. Hopefully, the nonplanar loop contributions may provide us a sounder foundation for the model of the pomeron.



APPENDIX. ALTERNATIVE DERIVATION OF THE FRAGMENTATION  
OF THE HEAVY VIRTUAL PHOTON

Instead of the parametrization of the eight-point dual amplitude as in Eq. (9), it is convenient to write (see Fig. 2)

$$\begin{aligned} \bar{B}_8 &= \int_0^1 \frac{dx_1 dx_2 dz dy_1 dy_2}{(1-x_1)(1-x_2)(1-z)(1-y_1)(1-y_2)} (x_1 y_1)^{-\alpha_{34}(s_{34})-1} \\ &\times x_2^{-\alpha_{234}(k_2+k_3+k_4)-1} y_2^{-\alpha_{234}(k_7-k_3-k_4)-1} z^{-\alpha_{1234}(q+k_3+k_4)-1} \\ &\times \left( \frac{1-x_1}{1-x_1 x_2} \right)^{-\alpha_{23}(k_2+k_3)} \left( \frac{1-x_1 x_2}{1-x_1 x_2 z} \right)^{-\alpha_{123}(q+k_3)} \\ &\times \left( \frac{1-x_1 x_2 z}{1-x_1 x_2 z y_2} \right)^{-\alpha_{2345}(k_7-k_3)} \left( \frac{1-x_1 x_2 z y_2}{1-x_1 x_2 z y_1 y_2} \right)^{-\alpha_{345}(k_3)} \\ &\times \left( \frac{1-y_1}{1-y_1 y_2} \right)^{-\alpha_{23}(k_7-k_3)} \left( \frac{1-y_1 y_2}{1-y_1 y_2 z} \right)^{-\alpha_{123}(q+k_3)} \\ &\times \left( \frac{1-y_1 y_2 z}{1-x_2 z y_1 y_2} \right)^{-\alpha_{2345}(k_2+k_3)} \left( \frac{1-x_2 z y_1 y_2}{1-x_1 x_2 z y_1 y_2} \right)^{-\alpha_{345}(k_3)} \\ &\times (1-x_1 x_2 z y_1 y_2)^{-\alpha_{45}(0)} \left( \frac{(-z)(1-x_2 z y_2)}{(1-z x_2)(1-z y_2)} \right)^{-\alpha_{18}(k_2+k_7)} \end{aligned}$$

Equation (A.1) continued

Equation (A.1) continued

$$\begin{aligned} &\times \left[ \frac{(1-x_2)(1-x_1 x_2 z)(1-y_2)(1-z y_1 y_2)}{(1-x_1 x_2)(1-x_2 z)(1-z y_2)(1-y_1 y_2)} \right]^{-\alpha_{12}(q)} \\ &\times \left[ \frac{(1-x_2 z y_2)(1-x_1 x_2 z y_1 y_2)}{(1-x_1 x_2 z y_2)(1-x_2 z y_1 y_2)} \right]^{-\alpha_{3456}(0)} \left[ \frac{(1-x_2 z)(1-x_1 x_2 z y_2)}{(1-x_1 x_2 z)(1-x_2 z y_2)} \right]^{-\alpha_{26}(k_7)} \\ &\times \left[ \frac{(1-z y_2)(1-x_2 z y_1 y_2)}{(1-z y_1 y_2)(1-x_2 z y_2)} \right]^{-\alpha_{187}(k_2)}. \quad (A.1) \end{aligned}$$

We are interested in the limit  $s \rightarrow +\infty$ ,  $s_{34} \rightarrow -\infty$ ,  $q^2 \rightarrow -\infty$ , but  $s_3 = \text{fixed}$ . The first step, before taking this limit, is of course to do the double loop integrations over  $k_2$  and  $k_7$ . However, since the model is a convergent model (regge behaviors in all channels), we prefer an ad hoc and short-cut derivation, on the ground of mathematical simplicity.

We will first take the limit  $s, s_{34} \rightarrow -\infty$ , by a scale transformation, then we rotate  $s$  to  $+\infty$ , and take the imaginary part in  $s$ . After which, we then take the limit  $q^2 \rightarrow -\infty$ , leaving the double loop integrals undone to the end.

As  $s, s_{34} \rightarrow -\infty$ , the scale transformation is determined by examining the factor in Eq. (A.1):

$$\begin{aligned} &\exp \left[ s_{34} \ln \left( \frac{1}{x_1 x_2 y_1 y_2} \right) + s \ln \frac{1}{z} \right] \\ &= \exp \left\{ s \left[ \ln \frac{1}{z} + \frac{s_{34}}{s} \ln \left( \frac{1}{x_1 x_2 y_1 y_2} \right) \right] \right\}. \quad (A.2) \end{aligned}$$

We make the scale transformation in Eq. (A.1)

$$\begin{aligned} \ln \frac{1}{x_1} &= y\rho\beta_1, & \ln \frac{1}{y_1} &= y\rho\beta'_1, \\ \ln \frac{1}{x_2} &= y\rho\beta_2, & \ln \frac{1}{y_2} &= y\rho\beta'_2, \\ \ln \frac{1}{z} &= \rho(1 - \beta_1 - \beta'_1 - \beta_2 - \beta'_2), \\ & & 1 - \beta_1 - \beta'_1 - \beta_2 - \beta'_2 &\geq 0, \end{aligned} \quad (\text{A.3})$$

where

$$y \equiv \frac{s}{s_{34}} \approx \frac{1}{1-x'} > 0. \quad (\text{A.4})$$

Expanding everything else in Eq. (A.1) in terms of  $\rho$  and  $\beta_i, \beta'_i$ , we find the  $\rho$  integral

$$\int_0^\infty d\rho \rho^{-1-\alpha_{45}(0)} \exp(s\rho) = \Gamma(-\alpha_{45}(0)) s^{\alpha_{45}(0)}. \quad (\text{A.5})$$

Rotating  $s$  to  $+\infty$ , and taking the imaginary part in  $s$ , we get

$$\text{Im}_s \left[ \Gamma(-\alpha_{45}(0)) s^{\alpha_{45}(0)} \right] = \frac{1}{\Gamma(1 + \alpha_{45}(0))} s^{\alpha_{45}(0)}. \quad (\text{A.6})$$

Thus the eight-point function in Eq. (A.1) becomes

$$\begin{aligned} \bar{B}_8 &\sim \frac{s^{\alpha_{45}(0)}}{\Gamma(1 + \alpha_{45}(0))} \int_0^{z>0} \frac{d\beta_1 d\beta'_1 d\beta_2 d\beta'_2}{\beta_1 \beta'_1 \beta_2 \beta'_2 z} [z + y(\beta_1 + \beta'_1 + \beta_2 + \beta'_2)]^{-\alpha_{45}(0)} \\ &\times \left( \frac{\beta_1}{\beta_1 + \beta_2} \right)^{-\alpha_{23}(k_2 + k_3)} \left[ \frac{y(\beta_1 + \beta_2)}{z + y(\beta_1 + \beta_2)} \right]^{-\alpha_{123}(q + k_3)} \\ &\times \left[ \frac{z + y(\beta_1 + \beta_2)}{z + y(\beta_1 + \beta_2 + \beta'_2)} \right]^{-\alpha_{25}(k_7 - k_3)} \left[ \frac{z + y(\beta_1 + \beta_2 + \beta'_2)}{z + y(\beta_1 + \beta'_1 + \beta_2 + \beta'_2)} \right]^{-\alpha_{345}(k_3)} \\ &\times \left( \frac{\beta'_1}{\beta'_1 + \beta'_2} \right)^{-\alpha_{23}(k_7 - k_3)} \left[ \frac{y(\beta'_1 + \beta'_2)}{z + y(\beta'_1 + \beta'_2)} \right]^{-\alpha_{123}(q + k_3)} \\ &\times \left[ \frac{z + y(\beta'_1 + \beta'_2)}{z + y(\beta_2 + \beta'_1 + \beta'_2)} \right]^{-\alpha_{25}(k_2 + k_3)} \left[ \frac{z + y(\beta_2 + \beta'_1 + \beta'_2)}{z + y(\beta_1 + \beta'_1 + \beta_2 + \beta'_2)} \right]^{-\alpha_{345}(k_3)} \\ &\times \left[ \left( \frac{\beta_2}{\beta_1 + \beta_2} \right) \left( \frac{z + y(\beta_1 + \beta_2)}{z + y\beta_2} \right) \left( \frac{\beta'_2}{\beta'_1 + \beta'_2} \right) \left( \frac{z + y(\beta'_1 + \beta'_2)}{z + y\beta'_2} \right) \right]^{-\alpha_{12}(q)} \\ &\times \left[ \frac{(z + y\beta_2)(z + y(\beta_1 + \beta_2 + \beta'_2))}{(z + y(\beta_1 + \beta_2))(z + y(\beta_2 + \beta'_2))} \right]^{-\alpha_{26}(k_7)} \\ &\times \left[ \frac{(z + y\beta'_2)(z + y(\beta_2 + \beta'_1 + \beta'_2))}{(z + y(\beta_2 + \beta'_2))(z + y(\beta'_1 + \beta'_2))} \right]^{-\alpha_{26}(k_2)} \left[ \frac{z(z + y(\beta_2 + \beta'_2))}{(z + y\beta_2)(z + y\beta'_2)} \right]^{-\alpha_{18}(k_2 + k_7)} \\ &\times \left[ \frac{(z + y(\beta_2 + \beta'_2))(z + y(\beta_1 + \beta'_1 + \beta_2 + \beta'_2))}{(z + y(\beta_1 + \beta_2 + \beta'_2))(z + y(\beta_2 + \beta'_1 + \beta'_2))} \right]^{-\alpha_{3456}(0)}, \end{aligned} \quad (\text{A.7})$$

where

$$Z = 1 - \beta_1 - \beta_1' - \beta_2 - \beta_2'. \quad (\text{A.8})$$

Now we take the limit  $q^2 \rightarrow -\infty$  in  $T_{\mu\nu}^{(i)}$ , defined by Eq. (7) in the text. The two parton propagators of leg 1 and leg 8, contribute a factor  $(q^2)^{-2}$ , while the  $q^2$ -dependent factors in Eq. (a.7) can be written as

$$\begin{aligned} & \exp \left\{ q^2 \ln \left[ \left( \frac{\beta_1 + \beta_2}{\beta_2} \right) \left( \frac{Z + y\beta_2}{Z + y(\beta_1 + \beta_2)} \right) \left( \frac{\beta_1' + \beta_2'}{\beta_2'} \right) \left( \frac{Z + y\beta_2'}{Z + y(\beta_1' + \beta_2')} \right) \right] \right. \\ & \left. + q^{2(1-\omega_3)} \left[ \ln \left( \frac{Z + y(\beta_1' + \beta_2')}{y(\beta_1' + \beta_2')} \right) + \ln \left( \frac{Z + y(\beta_1 + \beta_2)}{y(\beta_1 + \beta_2)} \right) \right] \right\}. \quad (\text{A.9}) \end{aligned}$$

As  $q^2 \rightarrow -\infty$ ,  $\omega_3 < 1$ , the important region is when  $Z$  is small, thus we expand the logarithms in the expression (A.9) to

$$\exp \left\{ q^2 \left( \frac{Z}{y} \right) \left[ \frac{\beta_1}{\beta_2(\beta_1 + \beta_2)} + \frac{\beta_1'}{\beta_2'(\beta_1' + \beta_2')} + \frac{1-\omega_3}{\beta_1 + \beta_2} + \frac{1-\omega_3}{\beta_1' + \beta_2'} \right] \right\}. \quad (\text{A.10})$$

Further putting  $\frac{Z}{y} \approx \frac{1}{q^2}$  everywhere else in Eq. (A.6), we therefore get, from Eqs. (7), (A.7), and (A.10),

$$W_{\mu\nu}^{(i)} \equiv \text{Im}_s T_{\mu\nu}^{(i)} \approx \frac{\alpha_{45}(0)}{\Gamma(1 + \alpha_{45}(0))} \left( \frac{1}{q^2} \right)^{2-\alpha_{18}(0)} \int d^4 k_2 d^4 k_7 K_{\mu\nu}^{(i)}$$

$$\times W(\ln |q^2|, \omega_3, x', p_1^2; k_2, k_7). \quad (\text{A.11})$$

Set  $\alpha_{18}(0) \equiv 1$ , we immediately see that the corresponding structure functions, from Eqs. (A.11) and (13), have the form given in Eq. (26) of the text.

#### ACKNOWLEDGMENTS

I thank M. B. Einhorn, F. J. Gilman, D. J. Levy, S. S. Shei, and M. A. Virasoro for helpful discussions. I also thank W. Rarita for reading the manuscript.

## FOOTNOTES AND REFERENCES

- \* This work was done under the auspices of the U. S. Atomic Energy Commission.
1. L. P. Yu, A Simple Parton Dual Resonance Model for the Electro-production and the Lepton-Pair Annihilation Processes with the Incorporation of the Final-State Interaction, Lawrence Radiation Laboratory Report UCRL-20610, March, 1971.
  2. We have interpreted this by saying that the final-state interaction among partons is diffractive in nature, see Ref. 1. Professor H. Harari pointed out to me that this interpretation is not incompatible with the Harari-Freund conjecture, since setting the intercept  $\alpha(0) \equiv 1$  in the eight-point Veneziano formula, means the pomeron is generated from unitarity through the generalized optical theorem. I would like to thank Professor Harari for this very attractive interpretation.
  3. M. A. Virasoro, Phys. Rev. D3, 2834 (1971); C. E. DeTar et al., Phys. Rev. Letters 26, 675 (1971); C. E. DeTar, K. Kang, C. I. Tan, and J. H. Weis, Duality and Single Particle Production, MIT-Brown preprint, to be published in Phys. Rev; D. Gordon and G. Veneziano, Phys. Rev. D3, 2116 (1971).

## FIGURE CAPTIONS

- Fig. 1. The six-point function parton dual resonance model for the reactions  $l + h_3 \rightarrow l + \text{anything}$ , and  $l + \bar{l} \rightarrow \bar{h}_3 + \text{anything}$ .
- Fig. 2. The eight-point function parton dual resonance model for the reactions  $l + h_4 \rightarrow l + h_3 + \text{anything}$ , and  $l + \bar{l} \rightarrow h_3 + \bar{h}_4 + \text{anything}$ .
- Fig. 3. The fragmentation of the target.
- Fig. 4. The first triple-reggeon limit.
- Fig. 5. The first pionization limit.
- Fig. 6. The fragmentation of the heavy virtual photon.
- Fig. 7. The "four-reggeon" limit.
- Fig. 8. The second triple-reggeon limit.
- Fig. 9. The "fixed-angle" limits.
- Fig. 10. The threshold behaviors.
- Fig. 11. The second pionization limit.

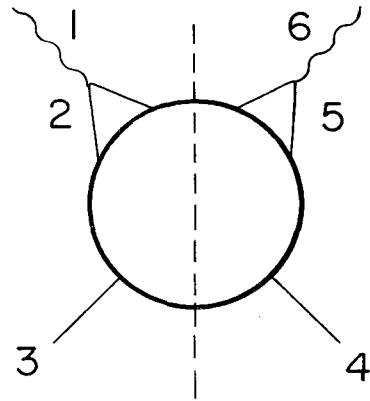

XBL 715-3445

Fig. 1

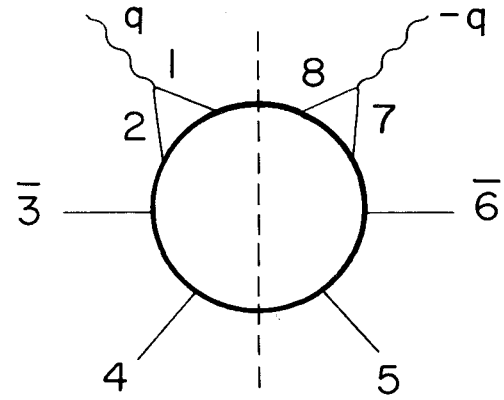

XBL 715-3444

Fig. 2

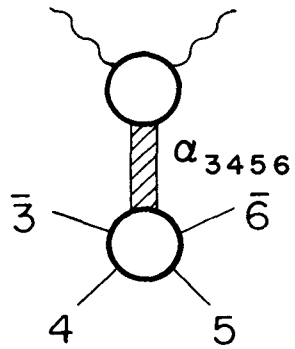

XBL715-3446

Fig. 3

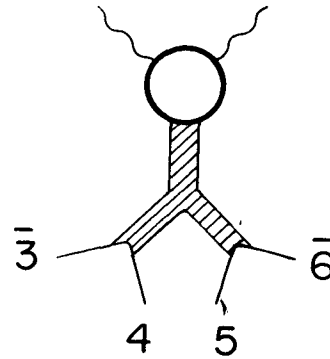

XBL715-3447

Fig. 4

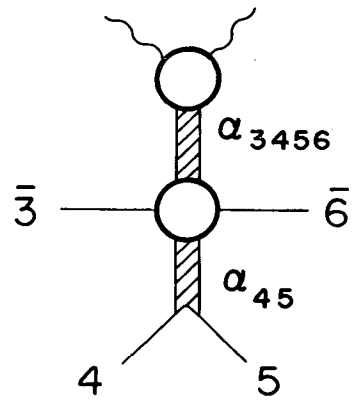

XBL715-3448

Fig. 5

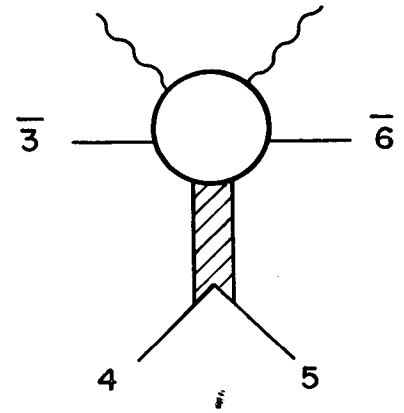

XBL715-3536

Fig. 6

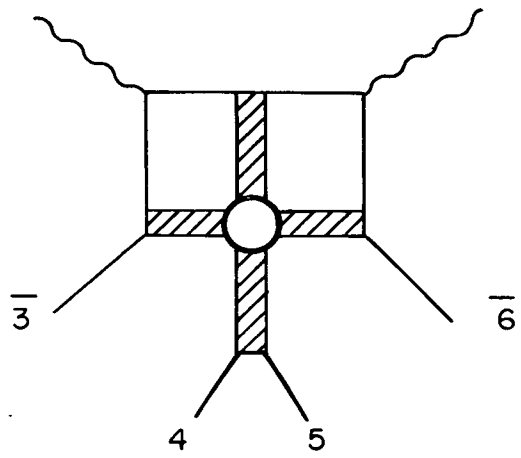

XBL715-3534

Fig. 7

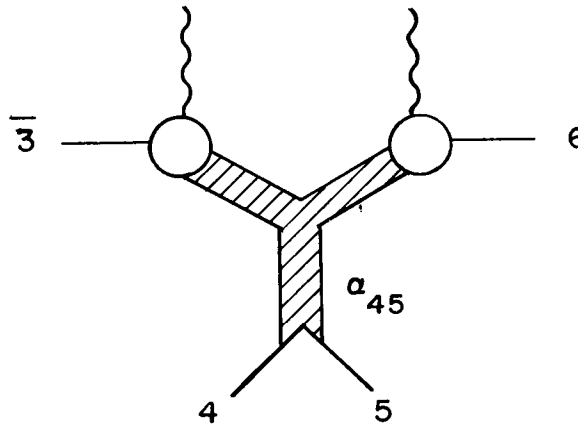

XBL715-3537

Fig. 8



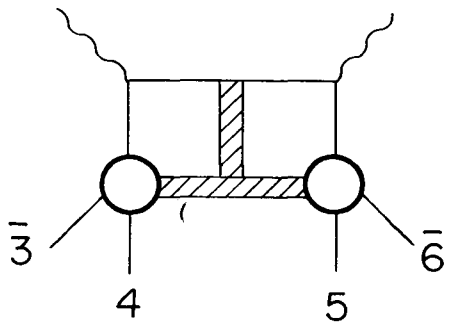

XBL715-3449

Fig. 9

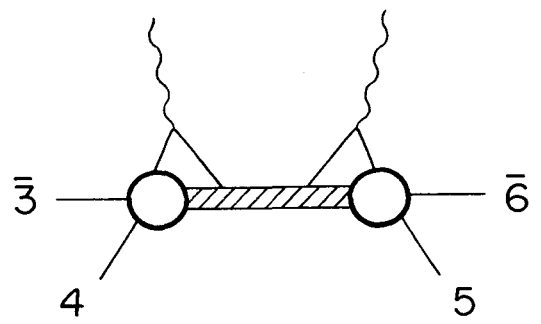

XBL715-3450

Fig. 10

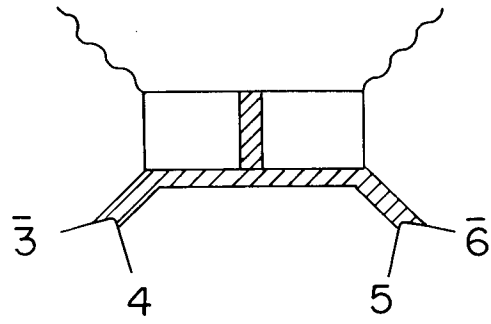

XBL715-3451

Fig. 11

LEGAL NOTICE

*This report was prepared as an account of work sponsored by the United States Government. Neither the United States nor the United States Atomic Energy Commission, nor any of their employees, nor any of their contractors, subcontractors, or their employees, makes any warranty, express or implied, or assumes any legal liability or responsibility for the accuracy, completeness or usefulness of any information, apparatus, product or process disclosed, or represents that its use would not infringe privately owned rights.*

TECHNICAL REPORT 7-1117-1150  
LAWRENCE BERKELEY LABORATORY  
UNIVERSITY OF CALIFORNIA  
BERKELEY, CALIFORNIA 94720