

Lawrence Berkeley National Laboratory

Recent Work

Title

MEASUREMENT OF H AND H₂ POPULATIONS IN SITU IN A LOW-TEMPERATURE PLASMA BY VACUUM-ULTRAVIOLET LASER-ABSORPTION SPECTROSCOPY

Permalink

<https://escholarship.org/uc/item/8p54t4q4>

Authors

Schlachter, A.S.
Young, A.T.
Stutzin, G.C.

Publication Date

1988-12-01

c.2



Lawrence Berkeley Laboratory

UNIVERSITY OF CALIFORNIA

Accelerator & Fusion Research Division

RECEIVED
LAWRENCE
BERKELEY LABORATORY

JUN 6 1989

LIBRARY AND
DOCUMENTS SECTION

Presented at the Society of Photo-Optical Instrumentation
Engineers (SPIE) Conference, Los Angeles, CA,
January 15-20, 1989, and to be published in the Proceedings

Measurement of H and H₂ Populations *In situ* in a Low-Temperature Plasma by Vacuum-Ultraviolet Laser-Absorption Spectroscopy

A.S. Schlachter, A.T. Young, G.C. Stutzin, J.W. Stearns,
H.G. Döbele, K.N. Leung, and W.B. Kunkel

December 1988

TWO-WEEK LOAN COPY

*This is a Library Circulating Copy
which may be borrowed for two weeks.*

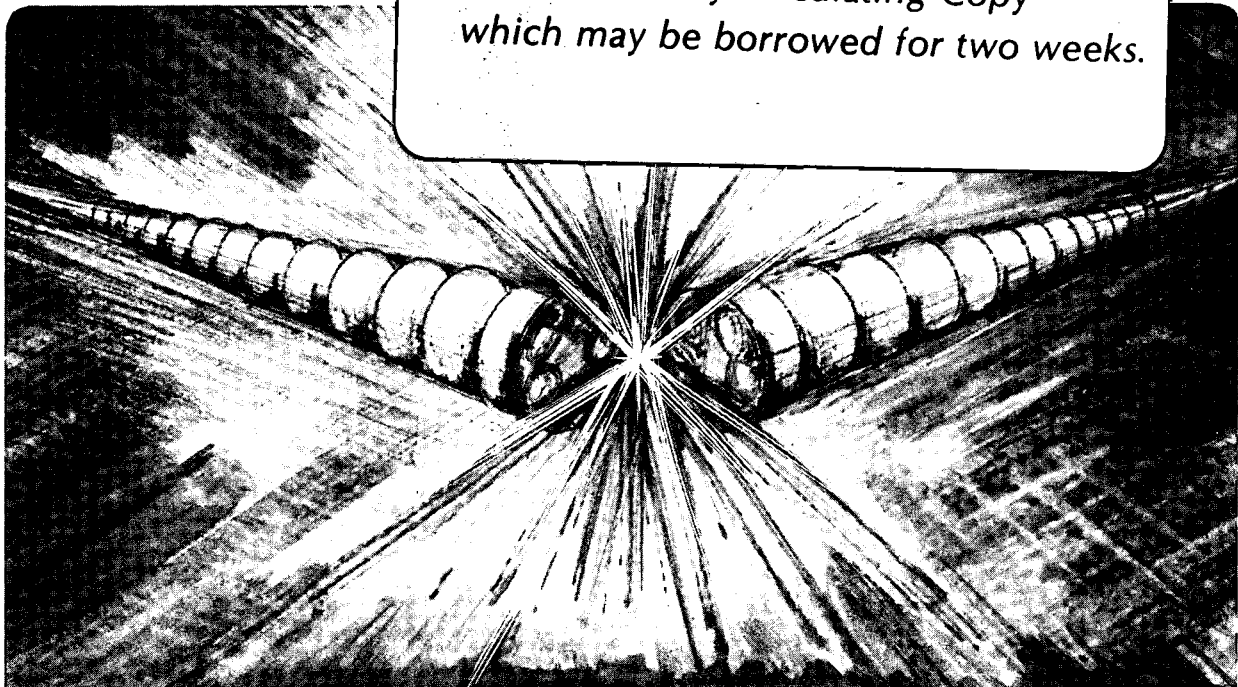

LBL-26430

c.2

DISCLAIMER

This document was prepared as an account of work sponsored by the United States Government. While this document is believed to contain correct information, neither the United States Government nor any agency thereof, nor the Regents of the University of California, nor any of their employees, makes any warranty, express or implied, or assumes any legal responsibility for the accuracy, completeness, or usefulness of any information, apparatus, product, or process disclosed, or represents that its use would not infringe privately owned rights. Reference herein to any specific commercial product, process, or service by its trade name, trademark, manufacturer, or otherwise, does not necessarily constitute or imply its endorsement, recommendation, or favoring by the United States Government or any agency thereof, or the Regents of the University of California. The views and opinions of authors expressed herein do not necessarily state or reflect those of the United States Government or any agency thereof or the Regents of the University of California.

Measurement of H and H₂ populations *in-situ* in a low-temperature plasma by vacuum-ultraviolet laser-absorption spectroscopy

A.S. Schlachter, A.T. Young, G.C. Stutzin, J.W. Stearns,
H.F. Döbele,[†] K.N. Leung, and W.B. Kunkel

Accelerator and Fusion Research Division
Lawrence Berkeley Laboratory
1 Cyclotron Road
Berkeley, California 94720

SPIE (Society of Photo-Optical Instrumentation Engineers)

Los Angeles, CA
January 20, 1989

This work was supported by the Director, Office of Energy Research, MFE Division, of the U.S. Department of Energy under Contract No. DE-AC03-76SF00098.

Measurement of H and H₂ populations *in-situ* in a low-temperature plasma by vacuum-ultraviolet laser-absorption spectroscopy

A.S. Schlachter, A.T. Young, G.C. Stutzin, J.W. Stearns,
H.F. Döbele,* K.N. Leung, and W.B. Kunkel

Lawrence Berkeley Laboratory
Berkeley, California 94720

ABSTRACT

A new technique, vacuum-ultraviolet laser-absorption spectroscopy, has been developed to quantitatively determine the absolute density of H and H₂ within a plasma. The technique is particularly well suited to measurement in a plasma, where high charged particle and photon backgrounds complicate other methods of detection. The high selectivity and sensitivity of the technique allows for the measurement of the rotational-vibrational state distribution of H₂ as well as the translational temperature of the atoms and molecules. The technique has been used to study both pulsed and continuous H⁺ ion-source plasma discharges. H₂ state distributions in a multicusp "volume" H⁺ ion-source plasma show a high degree of internal excitation, with levels up to $v = 5$ and $J = 8$ being observed. The method is applicable for a very wide range of plasma conditions. Emission measurements from excited states of H are also reported.

1. INTRODUCTION

The measurement of atomic and molecular hydrogen density and temperature is of crucial importance to the understanding of the chemistry occurring in hydrogen plasmas. In particular, for plasmas with a low electron temperature, the formation of H⁺ is thought to be sensitive to the density and temperature of the H atoms present as well as the vibrational state distribution of the H₂ molecules. Many of the current laser-based detection schemes of H and H₂ are difficult to apply to plasma measurements *within the discharge volume* because of the large background of photons and charged particles produced by the plasma. A new technique, vacuum-ultraviolet laser-absorption spectroscopy, has been developed to measure H and H₂ density and temperature *in situ* in a plasma. The method allows for the direct absolute measurement of the density of atomic and molecular hydrogen in the plasma. The high sensitivity and selectivity of the technique makes possible internal state distribution measurements on the molecules and translational energy distribution measurements on both atoms and molecules. These results can be compared with emission measurements from excited states of hydrogen atoms in the discharge.

2. EXPERIMENTAL ARRANGEMENT

The VUV laser spectrometer has been previously described in detail.¹ A schematic diagram is shown in Fig. 1. Briefly, four-wave sum-frequency mixing is used to produce narrow-bandwidth pulses of coherent VUV. Two excimer-pumped dye lasers provide photons at frequencies ω_1 and ω_2 . Mercury vapor is used as the mixing medium, with VUV output occurring at $2\omega_1 + \omega_2$. The relevant energy levels of Hg are shown in Fig. 2. To enhance the efficiency, $2\omega_1$ is chosen to be resonant with a mercury transition, with continuous tunability of the VUV provided by tuning ω_2 . By varying the resonant state, VUV has been produced from 97 to 128 nm, encompassing portions of the atomic Lyman series and the molecular Lyman (B-X) and Werner (C-X) bands. Bandwidth of the VUV is 0.27 cm^{-1} , and an estimated 10^9 photons are produced. The VUV is directed through the plasma; transmitted VUV is detected with a microchannel-plate detector.

The data are recorded as absorbance spectra, defined as $-\ln(I_p/I_0)$, where I_p is the VUV signal measured with the plasma discharge on, and I_0 the VUV signal measured with the discharge off. Using published values of the absorption line strength, the average density of the H or H₂ can be determined absolutely. Analysis of the width and shape of the absorption profile provides information on the translational temperature of the species of interest.

* On leave from Universität Gesamthochschule Essen

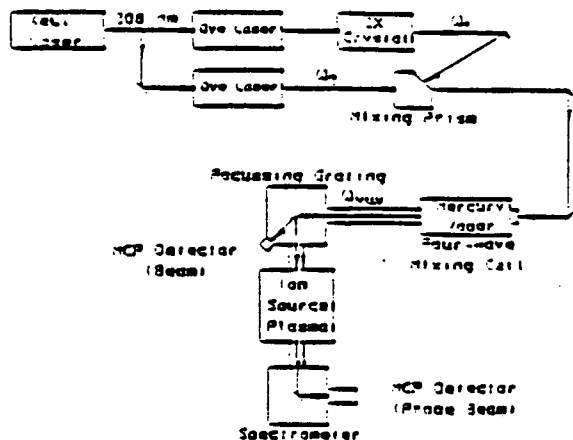

Fig.1 Schematic diagram of VUV laser-absorption spectrometer. The VUV is produced by four-wave sum-frequency mixing in the mercury vapor.

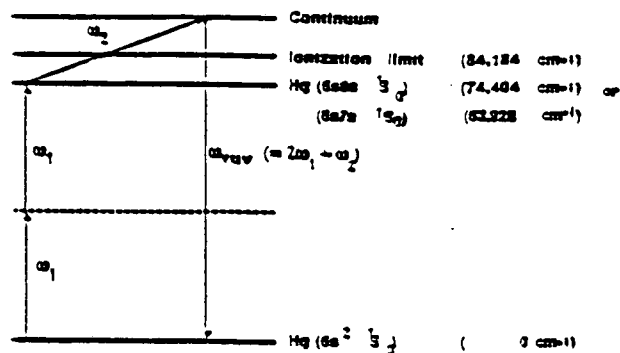

Fig. 2 Resonant four-wave sum-frequency mixing in mercury. VUV generation occurs at a frequency of $\omega_{VUV} = 2\omega_1 + \omega_2$.

3. ATOMIC HYDROGEN MEASUREMENTS: LYMAN-GAMMA ABSORPTION

Figure 3 shows a representative absorption profile¹ for atomic hydrogen in a multicusp "volume" H⁺ ion source. This spectrum was obtained with a continuous discharge using the Lyman-gamma transition and corresponds to a hydrogen atom density of 9.4×10^{12} atoms cm⁻³. The lineshape is best fit by the sum of two Gaussians, leading to a velocity distribution characterized by two temperatures: approximately 60% of the atoms have a temperature of 0.06 eV (700 K), while the remaining 40% of the atoms could be assigned a temperature in excess of 0.6 eV (7300 K).

The same techniques have been applied² to a pulsed Penning H⁺ ion source, in which it is believed that H⁺ ions are produced on a cesium-coated surface. Figure 4 shows a VUV absorption profile for hydrogen atoms in the vicinity of Lyman gamma for two ion-source plasmas: a steady-state multicusp volume source (same as Fig. 3) and a pulsed Penning source. The H-atom density and temperature are 9.4×10^{12} cm⁻³ and 0.06 eV for the volume source (with an admixture of atoms at 0.6 eV), and 8×10^{14} cm⁻³ and 1.7 eV (20,000 K) for the Penning source. Note that the H atoms in the Penning source are both hotter and more dense than in the volume source, and that the VUV absorption method is capable of *in-situ* measurement over a very wide range of hydrogen-atom density and temperature.

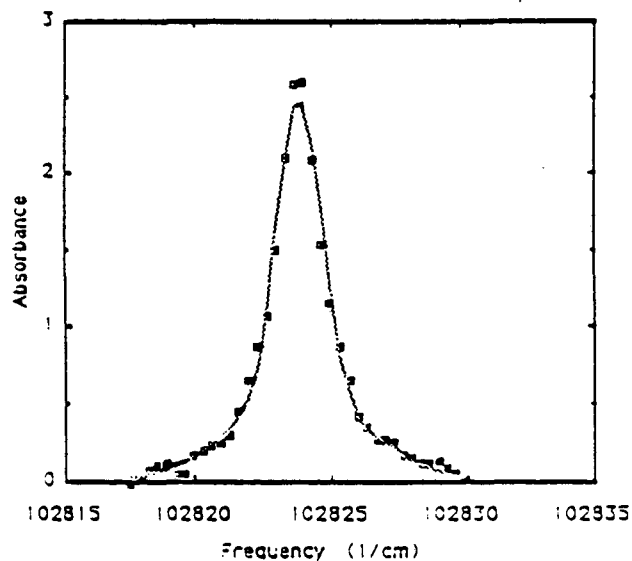

Fig. 3 Absorption profile of atomic hydrogen in a multicusp "volume" H⁺ ion source in the vicinity of Lyman-gamma. The line is a double-Gaussian fit to the data. Discharge parameters are 7 mTorr H₂ and 25 A at 140 V.

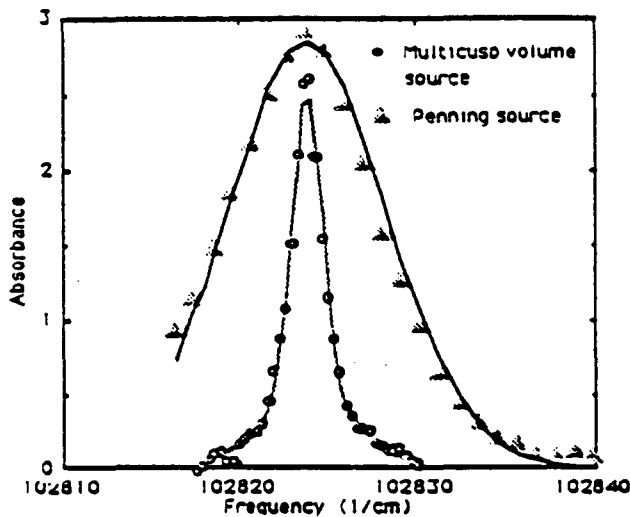

Fig.4 Absorption profile of atomic hydrogen in a multicusp "volume" H^+ ion source and in a Penning H^+ ion source, in the vicinity of Lyman-gamma. The lines are a Gaussian fit to the Penning source data and a double-Gaussian fit for the multicusp volume source data.

Preliminary measurements have been reported over a range of operating conditions for the volume H^+ source.¹ The parameters varied include arc current, arc voltage, and gas pressure. Hydrogen-atom density was observed to vary linearly with gas pressure. The density variations with respect to current and voltage were not so simple, however. With arc current, the density plateaued at a dissociation fraction $[H]/[H_2] = 0.05$. With increasing arc voltage, the H-atom density decreased. No systematic variations in the atom temperature were observed. These studies, on both continuous discharges and higher-power pulsed discharges, are continuing, with comparisons to the extracted H^+ to be made.

4. ATOMIC HYDROGEN MEASUREMENT: BALMER-ALPHA EMISSION

Another technique to determine the hydrogen atom temperature is to measure the Doppler broadened linewidths of the atomic Balmer emission lines. In particular, Balmer- α ($n = 3 - 2$, $\lambda = 656.3$ nm) and Balmer- β ($n = 4 - 2$, $\lambda = 486.1$ nm) have been used to study tokamaks³ and ion sources.^{4, 5} In contrast to the measurements discussed above, these emission measurements describe the *excited state* atom populations, e.g., the population in $n = 3$ for Balmer- α and $n = 4$ for Balmer- β , whereas the absorption measurements probe H atoms in the $n = 1$ state. To compare the temperature of atoms in an excited state to that of atoms in the ground state, the linewidth of the Balmer- α emission from the multicusp source has been measured using a scanning Fabry-Perot Interferometer (FPI).

The experimental apparatus is shown schematically in Fig. 5. Briefly, visible light emitted by the ion source was collected and collimated with a lens, and then directed through the scanning FPI. After transmission through the FPI, the emission was sent through a monochromator and then detected with a

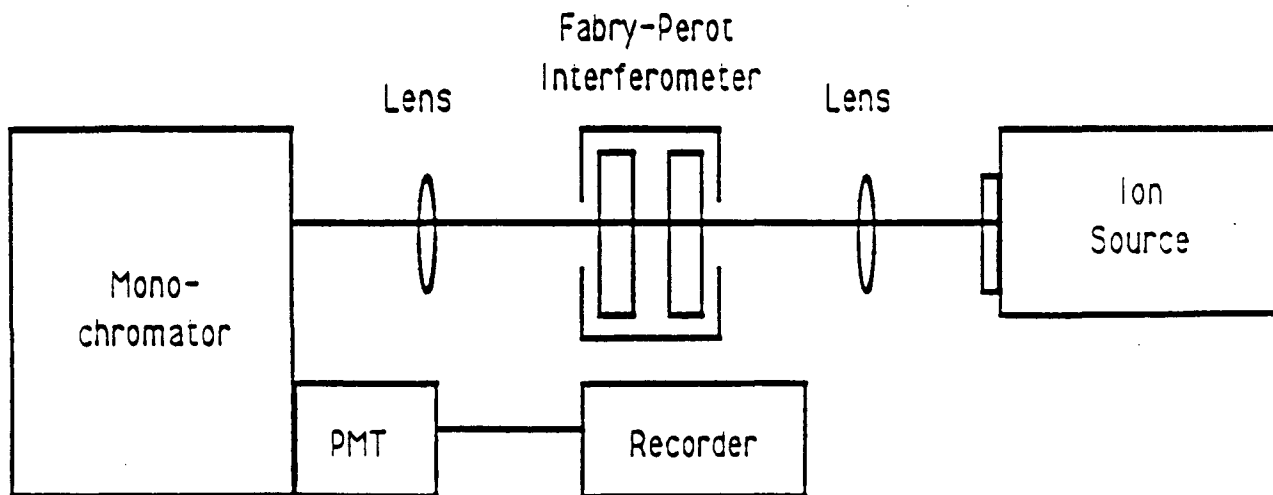

Fig. 5 Experimental apparatus for measuring the linewidth of Balmer- α emission from the multicusp ion source.

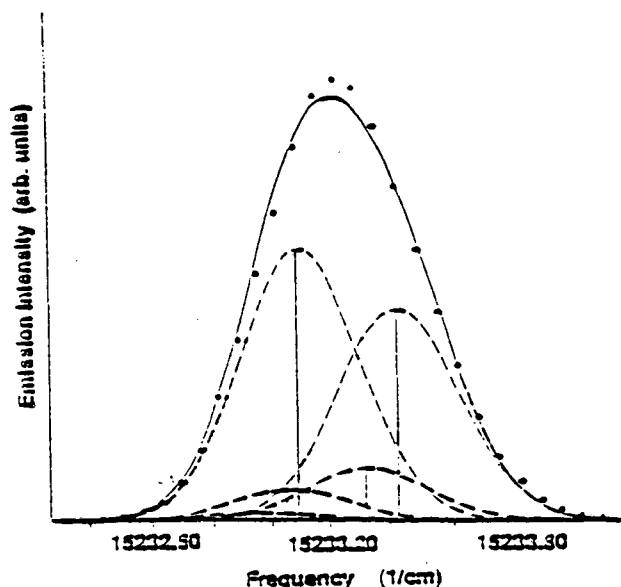

Fig. 6 Balmer- α emission spectrum from the multicusp ion source. Circles denote data points. Also shown are the spectral position and relative intensities of the five fine-structure components. The dashed lines are the Doppler broadened lineshapes of each component; the sum of the five components is given by the solid line.

photomultiplier tube. The FPI plates were coated for the red region of the spectrum and had a measured finesse of 15 at Balmer- α . With a plate separation of 2 mm., the instrumental bandwidth was 0.08 cm^{-1} . The wavelength setting of the monochromator was centered at Balmer- α . The purpose of this instrument was to reject emission which was not Balmer- α ; the FPI provided the requisite high resolution necessary to accurately determine the atomic linewidth.

Figure 6 shows the emission lineshape, denoted by the circles, obtained from the ion-source plasma. In order to derive the atomic temperature from this measurement, it is necessary to take into consideration the fine structure of this transition. The position of each of these components is indicated by the vertical lines in Fig. 6, with the relative strength denoted by the height.⁶ The data is therefore fit by the sum of five Gaussians, each with its own center frequency, weighted using the theoretical values shown in Fig. 6, and having a common width. This width is then varied to provide the best fit to the data. The result of the least-squares fitting procedure is shown on Fig. 6, where the individual Gaussians and their sum are depicted.

From this analysis we obtain, after taking into consideration the residual instrumental bandwidth, an atomic linewidth (halfwidth at half maximum) of 0.19 cm^{-1} , which leads to a translational temperature of 0.11 eV (1300 K) for the $n = 3$ atoms. This can be contrasted to the population distribution observed for the $n = 1$ atoms, i.e., 60% at $T_{\text{trans}} = 0.06 \text{ eV}$ and 40% at $T_{\text{trans}} = 0.6 \text{ eV}$. The emission lineshape is reasonably well fit by the single-width fitting routine, indicating that a majority of the excited atoms are described with a single tem-

perature. It should be noted that neither the low or high-temperature ground-state atoms have $T_{\text{trans}} = 0.11 \text{ eV}$. Although models relating the ground-state and excited-state populations exist, they are, in general, difficult to apply to the low-electron-temperature plasmas found in ion-source discharges, as the electron energy distribution function is not well characterized. Thus, a complete and accurate description of the processes occurring in these plasmas requires the direct measurement of the density and temperature of the ground-state atoms.

5. MOLECULAR HYDROGEN ROTATIONAL-VIBRATIONAL STATE DISTRIBUTIONS

H^- ions are believed^{7, 8} to be created predominantly by dissociative attachment of slow ($< 1 \text{ eV}$) electrons to vibrationally-excited hydrogen molecules, $\text{H}_2(v)$, in "volume" H^- ion sources. The vibrationally-excited H_2 may be created by several mechanisms, including direct excitation via low-energy ($\leq 10 \text{ eV}$) electron impact, indirect excitation via electron impact ($\geq 30 \text{ eV}$) excitation of high-lying electronic levels which radiatively decay to vibrationally-excited states of the electronic ground state, and neutralization of H_2^+ and H_3^+ , which can occur in electron collisions and on surfaces. There are also several destruction processes for $\text{H}_2(v)$, including collisional deactivation and wall relaxation, none of which have been measured experimentally. The dissociative-attachment cross sections have been studied theoretically^{9, 10} and, over a limited range, experimentally¹¹, with good agreement. An *in-situ* diagnostic for vibrationally-excited H_2 in a plasma is required to study their role in plasma processes.

Several methods exist for detection of vibrationally-excited hydrogen molecules. Resonantly Enhanced Multi-Photon Ionization (REMPI) has been used to obtain relative measurements of $\text{H}_2(v)$ in a heated gas cell¹² and in the gas effusing from a discharge chamber.¹³ The highest vibrational level observed in the latter case was $v = 3$. Vibrationally-excited hydrogen has also been detected by collection of H^- ions created by colliding a low-energy electron beam with the $\text{H}_2(v)$ effus-

ing from a chamber containing heated filaments.¹⁴ Laser-Induced Fluorescence (LIF) is another technique which has been used to detect $H_2(v)$.¹⁵ REMPI and LIF are very sensitive; for *in-situ* plasma measurements, however, the large background of charged particles and photons within the discharge volume prevents REMPI and LIF from achieving the ultimate sensitivity demonstrated in zero background environments. Until now, the only method used for *in-situ* measurement of $H_2(v)$ in a plasma has been Coherent Anti-Stokes Raman Scattering (CARS)¹⁶; sensitivity was limited to $v = 3$ in the plasma studied. The technique described here, VUV laser absorption spectroscopy, provides a new way of measuring the density and temperature of $H_2(v)$ in a plasma.¹⁷

The final H_2 states for these measurements are specific rovibrational levels of either the B $^1\Sigma_u^+$ (for $v = 1-3$) or C $^1\Pi_u$ ($v = 4, 5$) electronic states. These transitions were selected for their relatively large oscillator strengths, which permits higher sensitivity to be achieved. The absolute density of a given state can be determined using the measured absorption profile and the oscillator strength, which, to a good approximation, is the product of an electronic-vibrational term and a rotational term.

Figure 7 shows a typical absorption spectrum of H_2 . This figure depicts the Lyman B $^1\Sigma_u^+ - X^1\Sigma_g^+$ ($v' = 3 - v'' = 1$) R(2) transition; hence, the state being measured is $v'' = 1, J'' = 2$. The absorption illustrated corresponds to a density of $1.1 \times 10^{12} H_2$ molecules cm^{-3} in this state. Also shown in Fig. 7 is a least-squares Gaussian fit to the data points. From the measured line width, we obtain a translation temperature of 0.037 eV (450 K) from the measured line width.

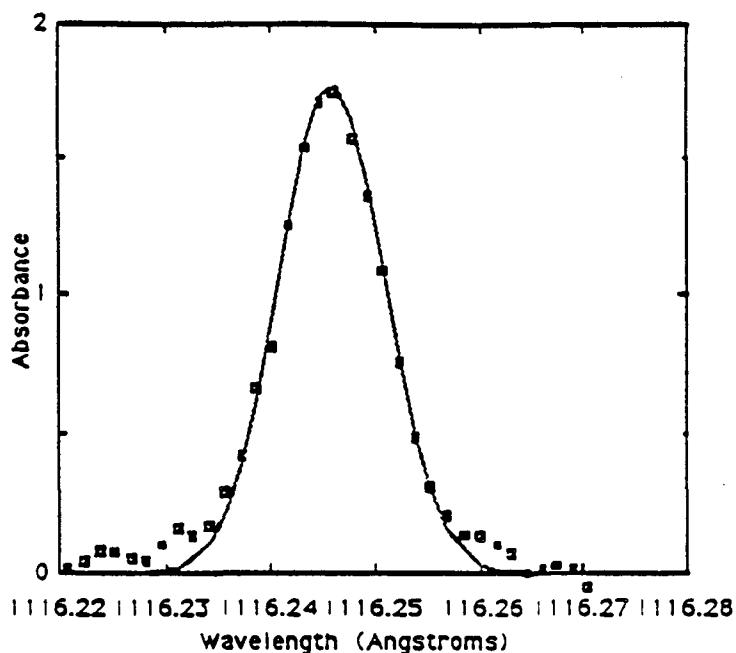

Fig. 7 Molecular hydrogen absorption profile, using the (B - X) (3 - 1) R(2) transition. The line is a Gaussian fit to the data. Discharge parameters are 25 A and 140 V with H_2 pressure of 8 mTorr.

The rotational distribution of each vibrational level was measured for $v = 1$ to 5. A plot of the density divided by the rotational and nuclear spin degeneracies for all measured states is shown in Fig. 8. As can be seen, the rotational distribution of each vibrational state is non-Boltzmann. However, the lower J states of each vibrational level lie approximately on a line, and thus have a quasi-temperature, which was determined by a least-squares fit. The rotational temperatures are almost the same for each vibrational level, approximately 0.04 eV (470 K); all subsequent discussion of rotational temperature refers to these low- J determinations only.

The vibrational state distribution is shown in Fig. 9. The points lie approximately on a line, which indicates that the vibrational state populations can be described by a temperature. A least-squares fit to the data yields a vibrational temperature of 0.35 eV (4000 K). The population of each level was defined as the sum of the rotational populations for $J = 0$ to 7 of that level, which involved estimating the populations of a few of the less populated higher J states (see Fig. 3).

Translational temperatures were determined by a least-squares fit of a Gaussian to the absorbance spectral profile for each transition. Many of the profiles are poorly fit by a Gaussian, implying a non-thermal translational-energy distribution. The translational temperatures cited here are therefore only meaningful in an approximate fashion. Temperatures were in the range of 0.03 to 0.14 eV, with the average being 0.06 eV. Considerable scatter exists among the data, but one trend was clear: states of low J (≤ 3) had lower translational temperatures than states of high J (≥ 5). This may indicate that the rotationally excited H_2 is also formed with an excess of translational energy. Both distributions are collisionally relaxed leading to a correlation between rotational and translational energy. No correlation to vibrational quantum number was observed.

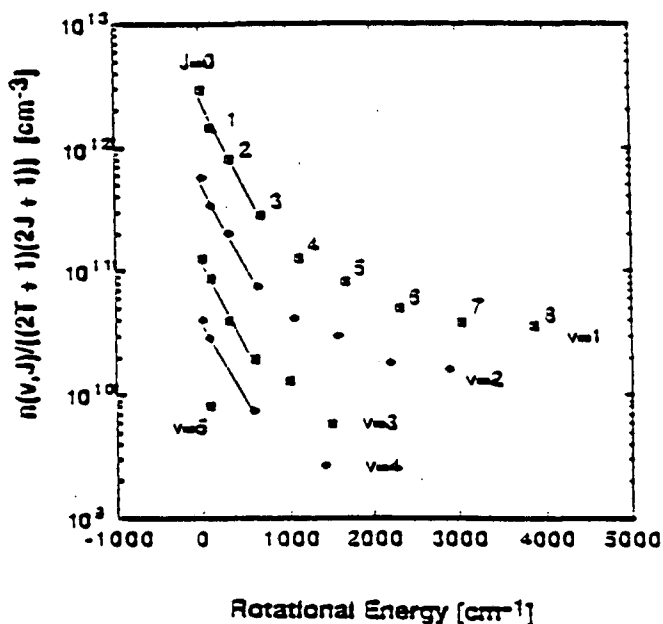

Fig. 8 Measured density for all $H_2(v, J)$ states, divided by degeneracy factors, vs. rotational energy. T is the nuclear spin. The line shown for each vibrational level is a linear least-squares fit to the population of the first four rotational levels.

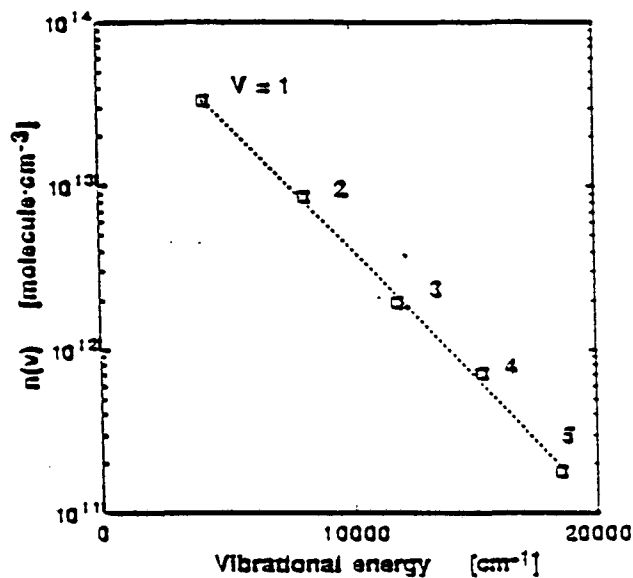

Fig. 9 Total density for each vibrational level vs. vibrational energy. The line shown is a linear least-squares fit to this distribution which yields a vibrational temperature of 0.35 eV.

Several different temperatures describing the rovibrationally-excited molecules in the plasma studied were determined, i.e., translational, rotational, and vibrational. The vibrational temperature is much higher than the translational or rotational temperatures; it is most likely influenced by the walls of the chamber at this low pressure. Further study is needed on relaxation of vibrationally-excited H_2 on surfaces. The fact that the low J states were generally cooler translationally than the high J states suggests that the rotational and translational temperature equilibration occurs on time scales that are at least somewhat comparable, and that these times are small compared to the time for vibrational relaxation.

The detection sensitivity for the present experimental apparatus is $\sim 5 \times 10^{10} \text{ cm}^{-3}$ per quantum state. This assumes an absolute oscillator strength of 0.06 (typical of the Q branch of C-X transitions in which the Franck-Condon factor is most favorable), a translational temperature of 0.04 eV, a minimum peak absorbance of 0.1, and a pathlength of 31 cm. It should be possible to reduce this limit to $\sim 1 \times 10^{10} \text{ cm}^{-3}$ with only moderate improvement of the experimental system. The highest sensitivity achieved with CARS is $\sim 10^{11} \text{ cm}^{-3}$, in which colinear CARS was employed. Crossed-beam CARS provides enhanced spatial resolution, with a loss of a factor of 10 in sensitivity. REMPI has much higher sensitivity,¹² about 10^3 cm^{-3} , in a region with no background photons, ions, or metastable molecules, i.e., *not in a plasma*. The minimum density in a plasma measurable by detection of effusing molecules is, however, not known.

6. SUMMARY

VUV laser-absorption spectroscopy has been used to quantitatively determine the hydrogen atom density and the rotational-vibrational state distribution of hydrogen molecules *in situ* in a plasma. In addition, the translational temperature of both species has been measured. A large fraction of the atoms possess a translational temperature in excess of 0.6 eV (7300 K), while the H_2 shows a high degree of internal excitation.

7. ACKNOWLEDGEMENT

This work has been supported by the U.S. Department of Energy under contract DE-AC03-76SF00098, the Air Force Office of Scientific Research under contract AFOSR-155A-88-003, and Los Alamos National Laboratory.

8. REFERENCES

1. G.C. Stutzin, A.T. Young, A.S. Schlachter, J.W. Stearns, K.N. Leung, W.B. Kunkel, G.T. Worth, and R.R. Stevens, *Rev. Sci. Instrum.* **59** (1988) 1364; *Rev. Sci. Instrum* **59** (1988) 1479.
2. H.V. Smith, G.T. Worth, E. Pitcher, R.R. Stevens, G.C. Stutzin, A.T. Young, A.S. Schlachter, K.N. Leung, and W.B. Kunkel, article in preparation.
3. D.M. McNeill, M.G. Bell, B. Grek, and B. LeBlanc *J. Vac. Sci. Tech.* **A2** (1984) 689.
4. C.F. Chan, C.F. Burrell, and W.S. Cooper *J. Appl. Phys.* **54** (1983) 6119.
5. M. Pealet, J-P.E. Taran, M. Bacal, and F. Hillion *J. Chem. Phys.* **82** (1983) 4943.
6. E.U. Condon and G.H. Shortley "The Theory of Atomic Spectra" Cambridge University Press, 1964, Cambridge, England.
7. M. Bacal, A.M. Bruneteau, W.G. Graham, G.W. Hamilton, and M. Nachman, *J. Appl. Phys.* **52** (1981) 1247.
8. K.N. Leung and W.B. Kunkel, *Phys. Rev. Lett.* **59** (1987) 787.
9. J.M. Wadehra, *Phys. Rev. A* **29** (1984) 106.
10. J.P. Gauryacq, *J. Phys. B* **18** (1985) 1859.
11. M. Allan and S.F. Wong, *Phys. Rev. Lett.* **41** (1978) 1791.
12. E.E. Marinero, C.T. Retner, and R.N. Zare, *Phys. Rev. Lett.* **48** (1982) 1323.
13. J.H.M. Bonnie, P.J. Eenshuijstra, and H.J. Hopman, *Phys. Rev. A* **37** (1988) 1121.
14. R.I. Hall, I. Cadez, M. Landau, F. Pichou, and C. Schermann, *Phys. Rev. Lett.* **60** (1988) 337.
15. T.J. Butenhoff, K.L. Carleton, M.C. Chuang, and C.B. Moore, *J. Chem. Soc. Faraday Trans 2*, **85** (1989), (in press).
16. M. Pealet, J.P.E. Taran, M. Bacal, and A.M. Bruneteau, *J. Chem. Phys.* **82** (1985) 4943.
17. G.C. Stutzin, A.T. Young, A.S. Schlachter, K.N. Leung, and W.B. Kunkel, *Chem. Phys. Letters* (accepted for publication).

LAWRENCE BERKELEY LABORATORY
TECHNICAL INFORMATION DEPARTMENT
1 CYCLOTRON ROAD
BERKELEY, CALIFORNIA 94720