

Lawrence Berkeley National Laboratory

Lawrence Berkeley National Laboratory

Title

Optimal Model of Distributed Energy System by Using GAMS and Case Study

Permalink

<https://escholarship.org/uc/item/8qp8c10b>

Authors

Yang, Yongwen
Gao, Weijun
Ruan, Yingjun
et al.

Publication Date

2005-11-30

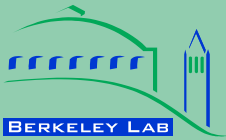

ERNEST ORLANDO LAWRENCE BERKELEY NATIONAL LABORATORY

Optimal Model of Distributed Energy System by Using GAMS and Case Study

*Yongwen Yang, Weijun Gao, Yingjun Ruan, Ji Xuan, Nan Zhou, and
Chris Marnay*

Environmental Energy
Technologies Division

November 2005

http://eetd.lbl.gov/ea/EMS/EMS_pubs.html

*In the conference proceedings of the International Symposium on Sustainable Development of the
Asian City Environment (SDACE) 2005.*

The work described in this report was funded by the Office of Electricity Delivery and Energy Reliability, Distributed Energy Program of the U.S. Department of Energy under Contract No. DE-AC02-05CH11231.

Disclaimer

This document was prepared as an account of work sponsored by the United States Government. While this document is believed to contain correct information, neither the United States Government nor any agency thereof, nor The Regents of the University of California, nor any of their employees, makes any warranty, express or implied, or assumes any legal responsibility for the accuracy, completeness, or usefulness of any information, apparatus, product, or process disclosed, or represents that its use would not infringe privately owned rights. Reference herein to any specific commercial product, process, or service by its trade name, trademark, manufacturer, or otherwise, does not necessarily constitute or imply its endorsement, recommendation, or favoring by the United States Government or any agency thereof, or The Regents of the University of California. The views and opinions of authors expressed herein do not necessarily state or reflect those of the United States Government or any agency thereof, or The Regents of the University of California.

Ernest Orlando Lawrence Berkeley National Laboratory is an equal opportunity employer.

Optimal Model of Distributed Energy System by Using GAMS and Case Study

Yongwen Yang¹, Weijun Gao², Yingjun Ruan³, Ji Xuan¹, Nan Zhou, Chris Marnay⁵

¹ Master candidate, Graduate School, The University of Kitakyushu

² Associate Professor, Faculty of Environment Engineering, The University of Kitakyushu

³ Doctor Candidate, Graduate School, The University of Kitakyushu

⁴ Research, Lawrence Berkeley National Laboratory and The University of Kitakyushu

⁵ Staff scientist, Lawrence Berkeley National Laboratory

Abstract

This paper adopts optimal model which used GAMS to develop methods and tools for conducting an integrated assessment of DER system. Three cases were studied. Energy-saving, environmental and economic efficiency were evaluated. The results of the simulation can be summarized as follows:

- 1) For the current system, optimal operating time is about 4,132 hours per year., and from 8 am to 22 pm every day.
- 2) It is economical when electricity price increases or gas price decreases.
- 3) According to the load function of system, energy-saving, environmental and economic efficiency will have a maximum value at optimal operating time.
- 4) Compared with exhaust heat efficiency, power generation efficiency has more influence to the economic efficiency and CO₂ reduction when the total efficiency is fixed.

Keywords: GAMS, DER-CAM, distributed energy system, optimal model, KSRP

1. Introduction

In recent years as a supplement for regular large-scale power generation system, Distributed Energy Resources (DER) system has got more comprehensive attention. This attention is built on the vision that future electric power system will not be organized solely as centralized systems as they are today. One possible adjunct to the traditional paradigm is the microgrid (μ Grid), a localized network of DER system matched to local energy

demands. Under this background, DER system, such as natural power system (wind, solar) and co-generation, also know as CHP (Combined heat and power), has been developed greatly during the last 20 years.

In order to improve the environment of introducing of DER, it is necessary to have a study on operation effects and adoption decision of DER system.

In previous research^[1], Distributed Energy Resources Customer Adoption Model (DER-CAM)

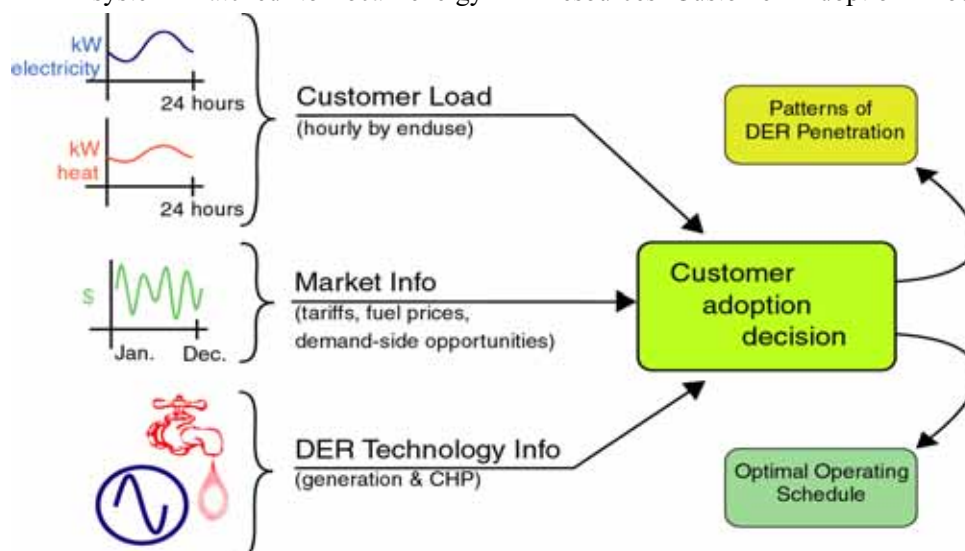

Figure 1 Image chart of GAMS model

Contact Author: Yongwen Yang, Master Candidates,
The University of Kitakyushu, Hibikino1-1, Wakamatsu-Ku
in Kitakyushu, Japan
Tel: 0081-93-6953715 Fax: 0081-93-6953335
E-mail: m4641601@hibikino.ne.jp

developed by Lawrence Berkeley National Laboratory in U.S.A has been discussed. However, it is necessary to consider the difference in climate condition and price structure between Japan and U.S.A. Therefore

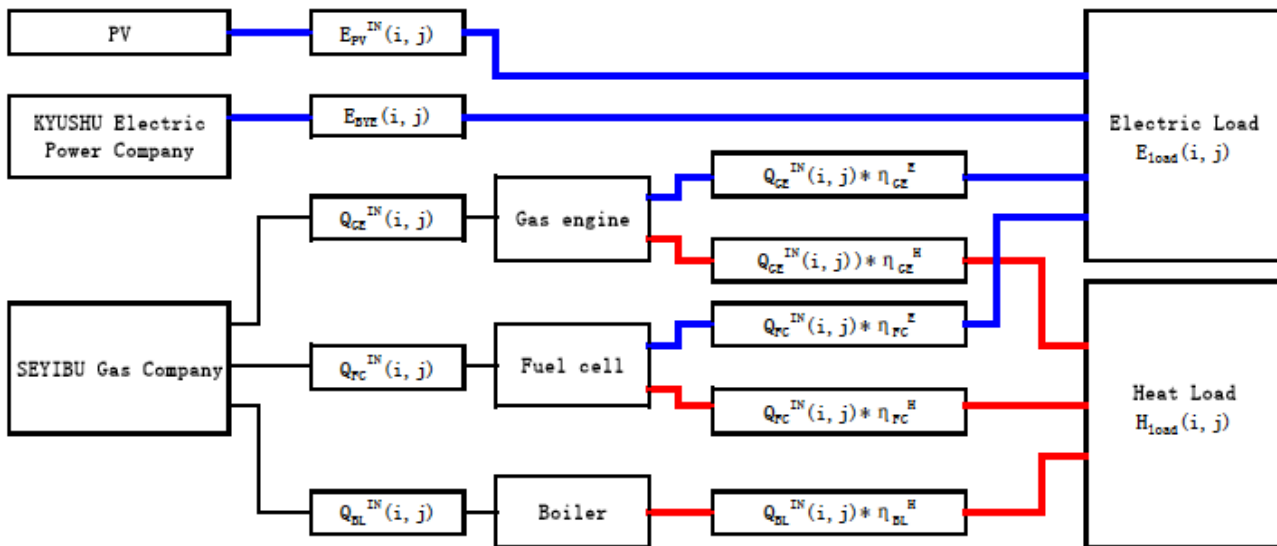

Figure 2 GAMS Model of KSRP

we adopt an optimal model which used The General Algebraic Modeling System (GAMS) to design methods and tools for conducting an integrated assessment of DER.

In this research, as a sample the environmental energy center at Kitakyushu Science and Research Park (KSRP) is selected and three cases of this pattern are utilized to analyze the operation effects of DER system on the different electricity price, gas price and machine efficiency.

2 . Concept of Optimization

Firstly, in order to introduce DER system, regional features including demand side, electricity load and heat load, technique and investment must be comprehensively estimated. Figure 1 shows the optimal model. By this model, requirement, market information (gas price and electricity price, etc) and technical information (co-generation, PV, etc.) could be comprehensively estimated to get a customer adoption decision of DER system.

3 . Outline of GAMS

In generally speaking, GAMS is a high-level modeling system for mathematical programming and optimization. The actual mathematical program is modeled via user-defined algebraic equation. GAMS then compiles them and applies standard solvers to the resulting problem. The features can be mainly described as follows:

- 1) GAMS lets the user concentrate on modeling. By eliminating the need to think about purely technical machine-specific problems such as address calculations, storage assignments, subroutine linkage, and input-output and flow control, GAMS increases the time available for conceptualizing and running the model, and analyzing the results.
- 2) Using GAMS, data are entered only once in familiar list and table form. Models are described in concise algebraic statements which are easy for both

humans and machines to read.

With the two features, we designed an optimal model as tool for study of DER system by GAMS

4 Optimal Model of DER System

In this paper, the energy center at Kitakyushu Science and Research Park (KSRP) is selected to be an object what we study. From Figure 2, as a description of energy system of KSRP, new energy systems such as fuel cell (200kW), gas engine (160kW) and PV (150kW) have been introduced. And the energy system not only can supply electricity, but also can recover exhaust heat by absorption chiller or heat exchanger.

4.1 Hypothesis of System

The hypotheses of selected system are shown as follows:

- 1) The benefit of distributed energy system is from the reducing of electricity rate and gas rate.
- 2) Owing to the reason of no extra of electric power, we have never considered the limit of technology on electrical power selling system
- 3) Total power generation only supply to Kitakyushu Science and Research Park (KSRP), not for the other consumer.
- 4) When demand exceeds supply, it is admitted to purchase more power from power company.
- 5) Price and function of equipment are assumed according to what manufactory offer to. Moreover, setting and other cost are not considered in the basic investment.
- 6) At the same status of technique, the difference of capacity is not to be considered in the economy.

4.2 Object Function

In this paper, the optimal model's function is based on minimizing the cost of operation of DER system. As shown in figure 2, the relationship can be expressed by the following formula:

$$\begin{aligned}
 \text{Minimum Zcost} = & \sum_{i,j} [\underbrace{\text{InMe} \times (1 + \text{InMeRate})^{\text{Life}}}_{\text{GE+FC+BL+PV+Other}} \div \text{life}] + \text{SerCost} \\
 & + \sum_i \sum_j [\underbrace{E_{\text{BYE}}(i,j) \times C_{\text{Ele}}^{\text{Vol}}(i,j)}_{\text{Purchased power}} + \sum_m [\underbrace{E_{\text{Use}}(m) \times C_{\text{Ele}}^{\text{Month}}(m)}_{\text{PV power generated}}]] \\
 & + \sum_i \sum_j [\underbrace{Q_{\text{GE}}^{\text{IN}}(i,j) + Q_{\text{FC}}^{\text{IN}}(i,j) + Q_{\text{BL}}^{\text{IN}}(i,j)}_{\text{Contract quantity of purchased power}}] \times C_{\text{Gas}}^{\text{Vol}}(i,j) \\
 & + \sum_m C_{\text{Gas}}^{\text{Month}}(m) + \sum_m [\underbrace{\text{Gas}_{\text{Max}}(m) \times C_{\text{Gas}}^{\text{Con}}}_{\text{Maximum of electricity load}}] \quad 1)
 \end{aligned}$$

Expression 1 is object function, which can be able to make a minimum cost. The item of this expression is composed of as following four factors. initial investment personnel cost and cost of operation cost of purchased power (basic charge and unit rate) cost of purchased gas (basic charge, unit rate and contract rate). The character of i and m are the meaning of month, and j is time.

4.3 Constraint conditions

It must be satisfy the following aspects such as heating supply and electric power.

$$\begin{aligned}
 \sum_i \sum_j E_{\text{load}}(i,j) \leq & \sum_i \sum_j E_{\text{BYE}}(i,j) + \sum_i \sum_j Q_{\text{GE}}^{\text{IN}}(i,j) \times \eta_{\text{GE}}^{\text{E}} \\
 & + \sum_i \sum_j Q_{\text{FC}}^{\text{IN}}(i,j) \times \eta_{\text{FC}}^{\text{E}} + \sum_i \sum_j E_{\text{PV}}^{\text{IN}}(i,j) \quad 2)
 \end{aligned}$$

$$\begin{aligned}
 \sum_i \sum_j H_{\text{load}}(i,j) \leq & \sum_i \sum_j Q_{\text{GE}}^{\text{IN}}(i,j) \times \eta_{\text{GE}}^{\text{H}} + \sum_i \sum_j Q_{\text{FC}}^{\text{IN}}(i,j) \times \eta_{\text{FC}}^{\text{H}} \\
 & + \sum_i \sum_j Q_{\text{BL}}^{\text{IN}}(i,j) \times \eta_{\text{BL}}^{\text{H}} \quad 3)
 \end{aligned}$$

$$E_{\text{load}}^{\text{MAX}} \leq E_{\text{GE}}^{\text{MAX}} + E_{\text{FC}}^{\text{MAX}} + E_{\text{BL}}^{\text{MAX}} \quad 4)$$

Expression 2 shows the balance in the power demand and supply, and the expression 3 shows the balance in the heat demand and supply. Expression 4 means the demand must be less than the supply in present model.

5. Case description and setting of database

5.1 Case description

In this paper, based on the present model, three cases will be discussed as follow:

Case 1 is about the effects to operating condition of DER system when energy prices (gas price and electricity price) separately change.

Case 2 is about the effects to energy-saving, environmental and economic efficiency when operating time of DER system changes.

Case 3 is about the effects to energy-saving, environmental and economic efficiency when efficiency of gas engine changes.

Table1 Sign list

Title	Item	Units
H_{load}	Heat load	kJ
E_{load}	Electricity load	kJ
$Q_{\text{GE}}^{\text{IN}}$	Energy input of gas engine	kJ
$\eta_{\text{GE}}^{\text{E}}$	Dynamolectric efficiency of gas engine	%
$\eta_{\text{GE}}^{\text{H}}$	Emission heat efficiency of gas engine	%
$Q_{\text{FC}}^{\text{IN}}$	Energy input of fuel cell	kJ
$\eta_{\text{FC}}^{\text{E}}$	Dynamolectric efficiency of fuel cell	%
$\eta_{\text{FC}}^{\text{H}}$	Emission heat efficiency of fuel cell	%
$Q_{\text{BL}}^{\text{IN}}$	Dynamolectric efficiency of boiler	kJ
$\eta_{\text{BL}}^{\text{H}}$	Heat efficiency of boiler	%
E_{BYE}	Purchased power	kJ
$E_{\text{PV}}^{\text{IN}}$	PV power generated	kJ
E_{Max}	Contract quantity of purchased power	kW
$E_{\text{Load}}^{\text{Max}}$	Maximum of electricity load	kW
$E_{\text{PV}}^{\text{Max}}$	Fixed content of PV	kW
$E_{\text{FC}}^{\text{Max}}$	Fixed content of FC	kW
$E_{\text{GE}}^{\text{Max}}$	Fixed content of gas engine	kW
$C_{\text{Ele}}^{\text{Month}}$	Basic fee of electricity	Yen/kW
$C_{\text{Ele}}^{\text{Vol}}$	vol. fee of electricity	Yen
Gas_{Max}	contract quantity of gas engine	m ³
$C_{\text{Gas}}^{\text{Con}}$	Gas basic service fee	Yen/kJ
$C_{\text{Gas}}^{\text{Month}}$	Fixed fee of gas engine	Yen
$C_{\text{Gas}}^{\text{Vol}}$	Scale	Yen/m3
SerCost	Administrative and maintenancefee	Yen
InMeRate	Investment interest rate of equipment	
life	Using year of equipment	Year

5.2 Setting of system

In this paper, in DER System of KSRP, due to the fuel cell which usually operates 24 hours every day, it can be regarded as a constant; moreover, data of PV is assumed according to the data measured in 2003.

5.3 Electricity and Heat Load Demand

In this study, the hourly load demand of 8760 hours for electricity and heat load demand were according to data measured in 2003

5.4 Setting of gas price, electricity price and efficiency of gas engine

It is clearly that electricity price refer to Kyushu electric power company, just as shown in figure 3. Structure of electricity price is made up of basic charge, daytime unit rate, night unit rate and peak charge. In this research we mainly analyze correlative effect when unit rate of electricity changes

Figure 4 shows the system of gas price. In generally speaking, basic charge is made up of gas basic service fee, fixed fee of gas and maximum season basic charge. Also as electricity price, we mainly analyze correlative effect when unit rate of gas changes

For the efficiency of gas engine, while power generation efficiency and exhaust heat recovery efficiency change in the range of 30% to 45%, energy-saving rate is estimated.

6. Analysis of simulation result

6.1 Effects of energy price

Case 1 is about the effects to operating condition of DER system when energy prices (gas price and electricity price) separately change. In this DER system, fuel cell usually operates 24 hours every day, only the operating time of gas engine is variable.

Based on the simulation of minimizing the cost of operation of DER system, figure 5 shows the relationship between electricity price and operating time of gas engine. It can be found that with the rise of electricity price, operating time of gas engine stage by stage increases from 0 hour to 8760 hours p.a. At present price structure (shown in Figure 3), Optimal operating time is 4,132 hours p.a. which approach to the current operating time (4,745 hours).The character of structure of electricity price can be used to explain the reason for the former. According to the structure, electricity price in the nighttime is half of the price in the daytime.

Based on the result of simulation, we can see from the point of view on economy, the right operating time should be from 8 am to 22 pm every day, and while electricity price increases, competitiveness of DER system becomes stronger. For instance, operating time of gas engine will get to 5,801 hours, when the electricity price have a 5% rise. Also, if the price is increase to 20%, operating time will get to 6,774 hours. By contrast, it is difficult to introduce DER system when electricity price reduces.

In short, for the current system, it is not economical

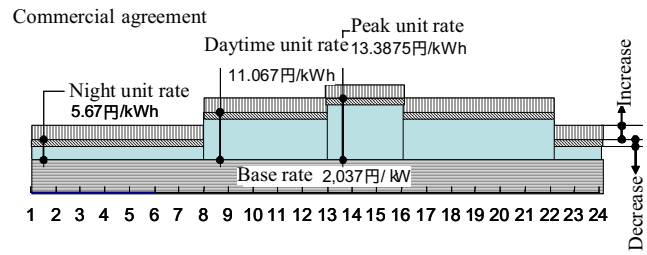

Figure 3 Structure of Electricity Price

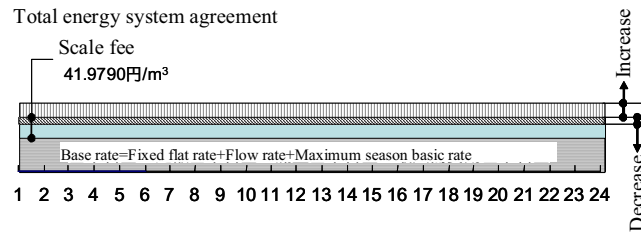

Figure4 Structure of Gas Price

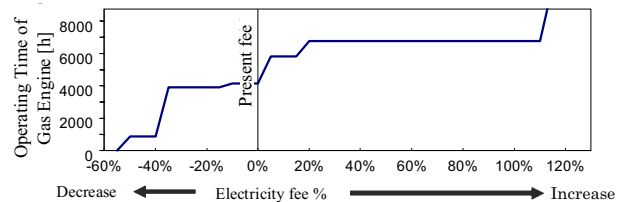

Figure 5 Increasing and Decreasing Situation of Electricity Price and Operating Time of Gas Engine

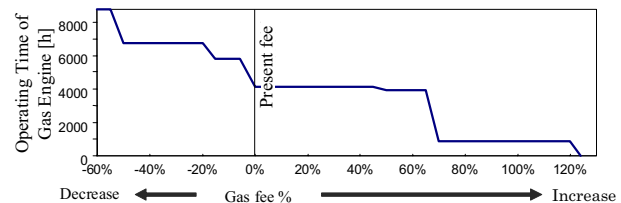

Figure 6 Increasing and Decreasing Situation of Gas Price and Operating Time of Gas Engine

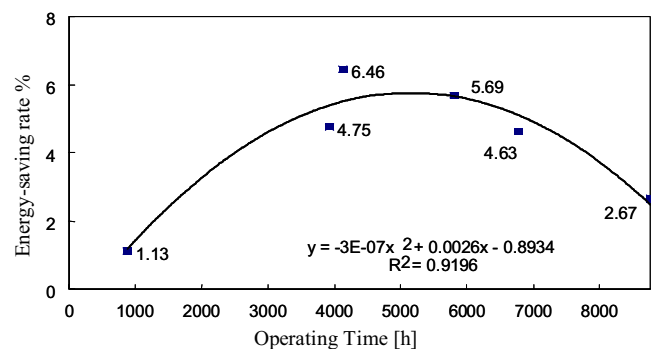

Figure 7 Operating Time of Gas Engine and Energy Saving

when operating time is throughout whole day and electricity price reduces.

Figure 6 shows the relationship between gas price and operating time of gas engine. Because the decrease of gas price has the same influence to the rise of electricity price, the profile of gas price is opposite to electricity price's.

6.2 Effects of operating time

Case 2 is about the effects to energy-saving, environmental and economic efficiency when operating time of DER system changes. Based on the simulation of minimizing the cost of operation of DER system, figure 7 shows the relationship between operating time of gas engine and energy-saving in current system. With the rise of operating time, efficiency of energy-saving can be enhance to maximum energy-saving efficiency, but when the operating time is more than 4000 hours, it will begin to reduce. The reason is heat emission has not been utilized completely, which is based on the load function of system. From the point of view on energy-saving, figure 7 shows that the best operation time is about 4,333 hours. Compared with the traditional system (the energy-saving efficiency of traditional system is considered to be 0%), the DER system have a maximum energy-saving efficiency with 6.46%.

As for environmental efficiency, figure 8 shows the relationship between operating time of gas engine and CO₂ reduction. Although it is almost as same as the energy-saving shown in figure 7, in short, compared with the traditional system, for CO₂ reduction, the DER system has a maximum value with 3.99% and a minimum value with -3.97%. The minimum is less than it is in the traditional system.

The profile of economic efficiency is also as same as energy-saving, just as figure 9 shows the best operating time is approximately 4500 hours, and compared with the traditional system, have a maximum with 1.88% and a minimum at 8760 hours with -0.15%. It is not economical when operating time is throughout whole year.

6.3 Effects of efficiency of gas engine

Case 3 is about the effects to energy-saving, environmental and economic efficiency when efficiency of gas engine changes. The efficiency of gas engine includes power generation efficiency and exhaust heat efficiency. In generally speaking, compared with exhaust heat efficiency, power generation efficiency has more influence to the economic efficiency.

For example, when power generation efficiency and exhaust heat efficiency separately occupied 45% and 35% which can save energy about 6.7% more than the other case of 50% and 30%. As shown in figure 10, the maximum of economic efficiency is mainly according to the maximum of power generation efficiency when the total efficiency is 80% always.

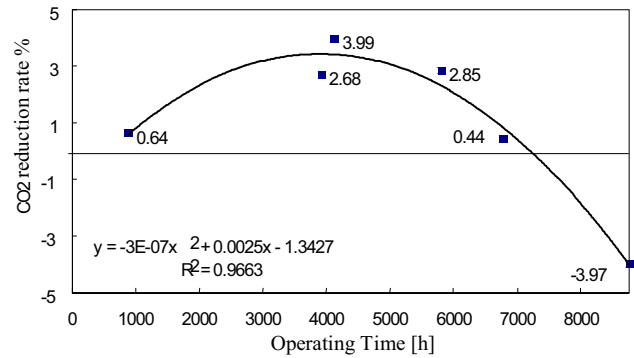

Figure 8 Driving Time of Gas Engine and Rating CO₂ decrease

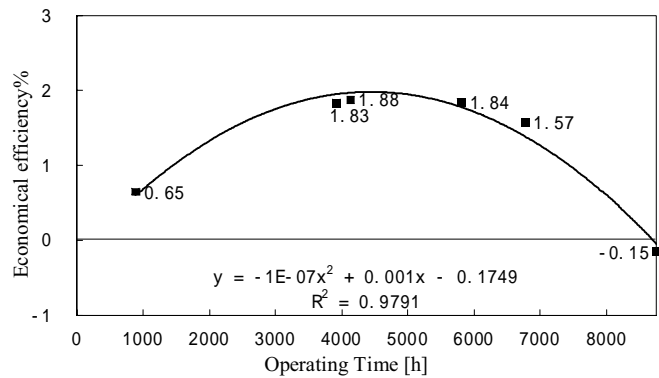

Figure 9 Driving Time of Gas Engine and Economy

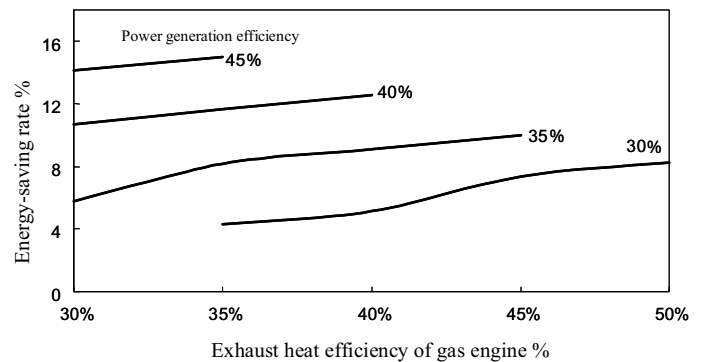

Figure 10 Gas Engine Efficiency and Energy Saving

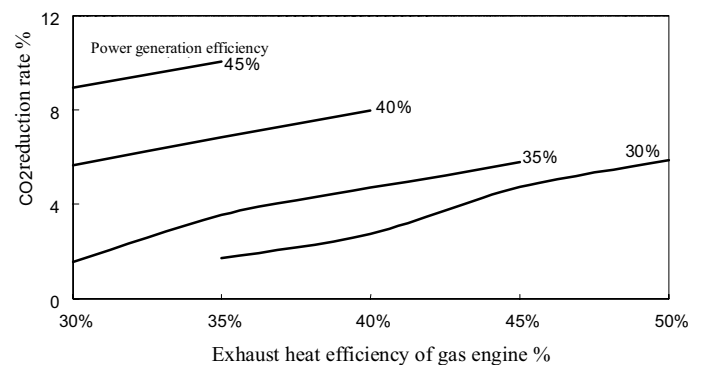

Figure 11 Gas Engine Efficiency and Rating of CO₂ decrease

Figure 11 shows the relationship between efficiency of gas engine and CO₂ reduction, the profile of it is almost as same as figure 10.

7. Conclusion

This paper adopts optimal model used the theory of GAMS to develop methods and tool for conducting an integrated assessment of DER system. Three cases were studied. Energy-saving, environmental and economic efficiency were evaluated. The results of the simulation can be summarized as follows:

- 1) For the current system, optimal operating time is about 4,132 hours p.a., and it is should be from 8 am to 22 pm per day.
- 2) It is economical when electricity price increases or gas price decreases.
- 3) According to the load function of system, energy-saving, environmental and economic efficiency will have a maximum value at optimal operating time.
- 4) Compared with exhaust heat efficiency, power generation efficiency has more influence to the economic efficiency and CO₂ reduction when the total efficiency is fixed.

Reference

- [1] Weijun Gao,Nan Zhou,Yingjun Ruan, Analysis on tool for conducting an integrated assessment of DER and integration of district system of electrical source and heat source, p.1349, D-2 fascicule, 2004.
- [2]. Chris Marnay,Jennifer L.Edwards,Ryan M.Firestone,Srijay Ghosh,Afzal S.Siddiqui, and Michael Stadler; Effect of a Carbon on Combined Heat and Power Adoption by a Microgrid, <http://eetd.lbl.gov/EA/EMP/>
- [3] Anthony Brooke,David Kendrick,Alexander Meeraus,Ramesh Raman;GAMS user's guide, <http://www.gams.com>
- [4] F.Javier Rubio,Afzal S.Siddiqui,Chris Marnay and Kristina S.Hamachi; Consortium for Electric Reliability Technology Solution;Certs Customer Adoption Model
- [5]http://www.kyuden.co.jp/agreement_rate_gyomukijia
- [6].[http //www.saibugas.co.jp/ryokin/yakkan/s_010.pdf](http://www.saibugas.co.jp/ryokin/yakkan/s_010.pdf)

Acknowledgement- This research is partly supported by JSPS "Grants-in-Aid for Scientific Research" (KibanC14550591) and the Sasakawa Scientific Research Grant from The Japan Science Society (No.17-269).