

# UC Riverside

## UC Riverside Previously Published Works

### Title

Evaluation of water movement and nitrate dynamics in a lysimeter planted with an orange tree

### Permalink

<https://escholarship.org/uc/item/8wc2n5z9>

### Journal

Agricultural Water Management, 127(C)

### ISSN

0378-3774

### Authors

Phogat, V  
Skewes, MA  
Cox, JW  
[et al.](#)

### Publication Date

2013-09-01

### DOI

10.1016/j.agwat.2013.05.017

Peer reviewed

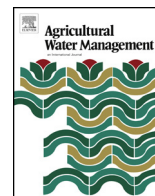

## Evaluation of water movement and nitrate dynamics in a lysimeter planted with an orange tree



V. Phogat<sup>a,\*</sup>, M.A. Skewes<sup>a</sup>, J.W. Cox<sup>a,b</sup>, J. Alam<sup>c</sup>, G. Grigson<sup>a</sup>, J. Šimůnek<sup>d</sup>

<sup>a</sup> South Australian Research and Development Institute, GPO Box 397, Adelaide, SA 5001, Australia

<sup>b</sup> The University of Adelaide, PMB1, Glen Osmond, SA 5064, Australia

<sup>c</sup> Rural Solutions SA, GPO Box 1671, Adelaide, SA 5001, Australia

<sup>d</sup> Department of Environmental Sciences, University of California, Riverside, CA 92521, United States

### ARTICLE INFO

#### Article history:

Received 10 October 2012

Accepted 26 May 2013

#### Keywords:

Modelling

Lysimeter

Drip irrigation

Fertigation

Orange

Deep drainage

Nitrate leaching

### ABSTRACT

Adoption of high input irrigation management systems for South Australian horticultural crops seeks to provide greater control over timing of irrigation and fertilizer applications. The HYDRUS 2D/3D model was used to simulate water movement in the soil under an orange tree planted in a field lysimeter supplied with 68.6 mm of irrigation water over 29 days. Simulated volumetric water contents statistically matched those measured using a capacitance soil water probe. Statistical measures (*MAE*, *RMSE*,  $t_{cal}$ ) indicating the correspondence between measured and simulated moisture content were within the acceptable range. The modelling efficiency (*E*) and the relative efficiency (*RE*) were in the satisfactory range, except *RE* at day 19. Simulated daily and cumulative drainage fluxes also matched measured values well. Cumulative drainage flux was 48.9% of applied water, indicating large water losses even under controlled water applications. High drainage losses were due to light texture of the soil and high rainfall (70 mm) during the experimental period. Simulated root water uptake was 40% of applied water.

The calibrated HYDRUS model was also used to evaluate several scenarios involving nitrate fertigation. The numerical analysis of  $\text{NO}_3\text{-N}$  dynamics showed that 25.5% of applied fertilizer was taken up by the orange tree within 15 days of fertigation commencement. The rest of the applied  $\text{NO}_3\text{-N}$  (74.5%) remained in the soil, available for uptake, but was also vulnerable to leaching later in the growing season. The seasonal simulation revealed that  $\text{NO}_3\text{-N}$  leaching accounted for 50.2% of nitrogen applied as fertilizer, and plant N recovery amounted to 42.1%. The scenario analysis further revealed that timing of a nitrogen application in an irrigation event had little impact on its uptake by citrus in the lysimeter. However, slightly higher  $\text{NO}_3\text{-N}$  uptake efficiency occurred when fertigation was applied late in the daily irrigation schedule, or was spread out across all irrigation pulses, rather than being applied early or in the middle. Modelling also revealed that pulsing of irrigation had little impact on nitrate leaching and plant uptake. Applying less irrigation (50% or 75% of  $ET_C$ ) resulted in higher nitrate uptake efficiency. This study showed that timing of water and fertilizer applications to an orange crop can be better regulated to enhance the efficiency of applied inputs under lysimeter conditions.

© 2013 Elsevier B.V. All rights reserved.

### 1. Introduction

High frequency irrigation systems involve fastidious planning and complex designs, so that timely and accurate additions of water and fertilizer can result in sustainable irrigation. At the same time these production systems are becoming more intensive, in an effort to optimise the return on expensive and scarce resources such as water and nutrients. Advanced fertigation systems combine drip irrigation and fertilizer application to deliver water and nutrients directly to the roots of crops, with the aim of synchronising the

applications with crop demands (Assouline, 2002), and maintaining the desired concentration and distribution of ions and water in the soil (Bar-Yosef, 1999). Hence a clear understanding of water dynamics in the soil is important for the design, operation, and management of irrigation and fertigation under drip irrigation (Li et al., 2004). However, there is a need to evaluate the performance of these systems, because considerable localised leaching can occur near the driplines, even under deficit irrigation conditions (Hanson et al., 2008). The loss of nutrients, particularly nitrogen, from irrigation systems can be expensive and pose a serious threat to receiving water bodies (Van der Laan et al., 2010).

Citrus is one of the important horticultural crops being grown under advanced fertigation systems in Australia. Fertigation delivers nutrients in a soluble form with irrigation water directly into

\* Corresponding author. Tel.: +61 8 83039567; fax: +61 8 8303 9473.

E-mail address: [vinod.phogat@sa.gov.au](mailto:vinod.phogat@sa.gov.au) (V. Phogat).

the root-zone, thus providing ideal conditions for rapid uptake of water and nutrients. Scholberg et al. (2002) demonstrated that more frequent applications of a dilute N solution to citrus seedlings doubled nitrogen uptake efficiency compared with less frequent applications of a more concentrated nutrient solution. Delivery of N through fertigation reduces N losses in the soil-plant system by ammonia volatilisation and nitrate leaching (Alva et al., 2008). However, poor irrigation management, i.e., an application of water in excess of crop requirements, plus the storage capacity of the soil within the rooting depth, can contribute to leaching of water and nutrients below the rootzone. Therefore, optimal irrigation scheduling is important to maximise the uptake efficiencies of water and nutrients (Alva et al., 2005).

Most of the citrus production along the Murray River corridor is on sandy soils, which are highly vulnerable to rapid leaching of water and nutrients. Nitrogen is the key limiting nutrient and is therefore a main component of fertigation. An increasing use of nitrogenous fertilizers and their subsequent leaching as nitrate from the rootzone of cropping systems is recognised as a potential source of groundwater contamination, because the harvested crop seldom takes up more than 25–70% of the total applied fertilizer (Allison, 1996). Several researchers have reported substantial leaching (6–45%) of applied N under citrus cultivation in field conditions (Wang and Alva, 1996; Paramasivam et al., 2002; Sluggett, 2010). Similarly, in lysimeter experiments, Boaretto et al. (2010) showed 36% recovery of applied nitrogen by orange trees, while Jiang and Xia (2008) reported N leaching of 70% of the initial N value, and found denitrification and leaching to be the main processes for the loss of N. These studies suggest that knowledge of the nitrogen balance in cropping systems is essential for designing and managing drip irrigation systems and achieving high efficiency of N fertilizer use, thereby limiting the export of this nutrient as a pollutant to downstream water systems.

Quantifying water and nitrogen (N) losses below the root zone is highly challenging due to uncertainties associated with estimating drainage fluxes and solute concentrations in the leachate, even under well-controlled experimental conditions (Van der Laan et al., 2010). Moreover, direct field measurements of simultaneous migration of water and nitrogen under drip irrigation is laborious, time-consuming and expensive (Bar-Yosef and Sheikholami, 1976; Kachanoski et al., 1994). Hence simulation models have become valuable research tools for studying the complex and interactive processes of water and solute transport through the soil profile, as well as the effects of management practices on crop yields and on the environment (Pang and Letey, 1998; Li et al., 2003). In fact, models have proved to be particularly useful for describing and predicting transport processes, simulating conditions which are economically or technically impossible to carry out in field experiments (Li and Liu, 2011).

Several models have been developed to simulate flow and transport processes, nutrient uptake and biological transformations of nutrients in the soil (Subbaiah, 2011). HYDRUS 2D/3D (Šimůnek et al., 2008, 2011) has been used extensively for evaluating the effects of soil hydraulic properties, soil layering, dripper discharge rates, irrigation frequency and quality, timing of nutrient applications on wetting patterns and solute distribution (e.g., Cote et al., 2003; Gårdenäs et al., 2005; Assouline et al., 2006; Hanson et al., 2006; Ajdary et al., 2007; Patel and Rajput, 2008; Šimůnek and Hopmans, 2009; Phogat et al., 2009, 2010, 2012, 2013; Li and Liu, 2011; Ramos et al., 2012) because it has the capability to analyse water flow and nutrient transport in multiple spatial dimensions (Cote et al., 2003).

In the absence of experimental data we can use multidimensional models solving water flow and nutrient transport equations to evaluate the multi-dimensional aspect of nitrate movement under fertigation (Cote et al., 2003; Gårdenäs et al., 2005; Hanson



Fig. 1. Drainage pipes and a filter sock placed at the bottom of the lysimeter.

et al., 2006). However, earlier simulation studies have reported contradictory results on nitrate distribution in soils. For example, Cote et al. (2003) reported that nitrate application at the beginning of an irrigation cycle reduced the risk of leaching compared to fertigation at the end of the irrigation cycle. On the other hand, Hanson et al. (2006) reported that fertigation at the end of an irrigation cycle resulted in a higher nitrogen use efficiency compared to fertigation at the beginning or middle of an irrigation cycle. These studies very well outlined the importance of numerical modelling in the design and management of irrigation and fertigation systems, especially when there is a lack of experimental data on nutrient transport in soils. However, there is still a need to verify the fate of nitrate in soils with horticultural crops and modern irrigation systems.

Therefore, a lysimeter was established to observe water movement and drainage under drip irrigated navel orange, and to calibrate the HYDRUS 2D/3D model against collected experimental data. The model was then used, in the absence of experimental data on nitrate, to develop various modelling scenarios to assess the fate of nitrate for different irrigation and fertigation schemes.

## 2. Materials and methods

### 2.1. Lysimeter setup

The study was conducted on a weighing lysimeter assembled and installed at the Loxton Research Centre of the South Australian Research and Development Institute. The lysimeter consisted of a PVC tank (1 m diameter  $\times$  1.2 m height) located on 1.2 m  $\times$  1.2 m pallet scales fitted with 4  $\times$  1 tonne load-cells, and connected to a computerised logging system which logged readings hourly. A specially designed drainage system placed at the bottom of the lysimeter consisted of radially running drainage pipes, which were connected to a pair of parallel pipes, which facilitated a rapid exit of drainage water from the lysimeter (Fig. 1). These pipes were covered in a drainage sock and buried in a 25-cm layer of coarse washed river sand at the base of the lysimeter, which ensured easy flushing of water through the drainage pipe. A layer of geo-textile material was placed over the top of the sand layer to prevent roots growing down into it, as this layer was intended to be only a drainage layer.

A healthy young citrus tree (about 3 years old) was excavated from an orchard at the Loxton Research Centre and transplanted into the lysimeter. A soil profile approximately 85 cm deep was transferred to the tank with the tree and saturated to remove air pockets and to facilitate settling. The final soil surface was around 10 cm below the rim of the tank. Soil samples were collected from

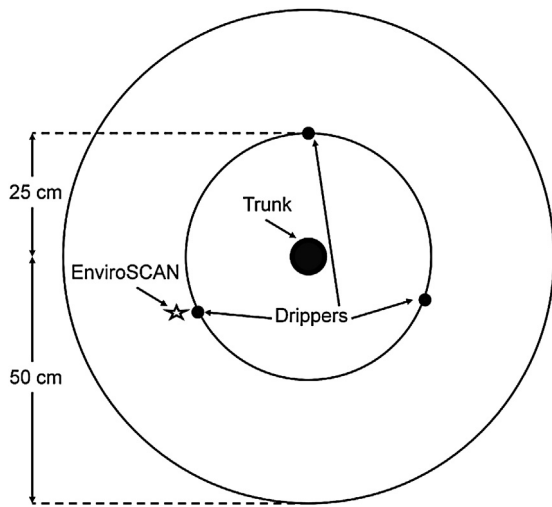

Fig. 2. Layout of drippers and location of EnviroSCAN soil moisture sensors in the lysimeter.

0 to 20, 20 to 40, 40 to 60, 60 to 85, and 85 to 110 cm depths to measure bulk density and to carry out particle size analysis.

Two months after transplanting, the lysimeter was installed amongst existing trees in the orchard. Measurements were initiated after about six months, in order to enable the plant to adjust to the lysimeter conditions. The lysimeter was equipped with Sentek® EnviroSCAN® logging capacitance soil water sensors installed adjacent to the drip line (approximately 15 cm away from the dripper) at depths of 10, 20, 40, 60, and 80 cm to measure changes in the volumetric soil water content. Drainage water was directed through flexible piping into a large bin installed below ground level. The experimental site was approximately 240 m from an established weather station, which measured air temperature, relative humidity, wind speed (at 2-m height), rainfall, and net radiation.

## 2.2. Irrigation

Irrigation was applied using 3 pressure compensated emitters with a discharge rate of  $4 \text{ L h}^{-1}$ . Emitters were located on a circle 25 cm away from the tree trunk at an equal distance from each other (Fig. 2). The irrigation schedule was based on the average reference evapotranspiration ( $ET_0$ ) during the last 10 years at the site, multiplied by the crop coefficient (0.7) taken from Sluggett (2010). The cumulative crop evapotranspiration ( $ET_C$ ) during the 29 day experimental period was equal to 65.3 mm, and daily  $ET_C$  varied from 1.68 to 3.39 mm. Irrigation was initiated on 16 August 2010 and terminated on 13 September, 2010. Irrigation and rainfall were recorded daily and drainage volume was measured 3 times per week throughout the trial period. Daily irrigation was applied in 5 short pulses (1–3 min long) using an automated irrigation controller, with 2 h breaks between irrigation pulses. The amount of irrigation water applied (68.6 mm) was slightly higher than  $ET_C$  for the period. A total of 70 mm of rainfall fell during the experimental period, including a single event of 52 mm on 3 September 2010.

## 2.3. HYDRUS software

Soil water content and nitrate dynamics were simulated using version 2.01 of the computer simulation model HYDRUS 2D/3D (Šimůnek et al., 2011). This programme numerically solves Richards' equation for variably-saturated water flow, and advection–dispersion equations for both heat and solute transport. The model additionally allows specification of root water uptake, which affects the spatial distribution of water and nitrate

between irrigation cycles. The solute transport equation considers advective–dispersive transport in the liquid phase, as well as diffusion in the gaseous phase. The theoretical part of the model is described in detail in the user (Šejna et al., 2011) and technical (Šimůnek et al., 2011) manuals.

## 2.4. Estimation of soil hydraulic parameters

The van Genuchten–Mualem model of soil hydraulic properties (Mualem, 1976; van Genuchten, 1980) was selected for numerical simulations:

$$\theta(h) = \theta_r + \frac{\theta_s - \theta_r}{[1 + (\alpha h)^n]^m} \quad h < 0 \quad (1)$$

$$\theta(h) = \theta_s \quad h \geq 0 \quad (2)$$

$$K(h) = K_s S_e^l [1 - (1 - S_e^{1/m})^m]^2 \quad (3)$$

$$S_e = \frac{\theta - \theta_r}{\theta_s - \theta_r} \quad (4)$$

where  $S_e$  is the effective fluid saturation (dimensionless),  $\theta_r$  and  $\theta_s$  are the residual and saturated water contents [ $\text{L}^3 \text{ L}^{-3}$ ], respectively,  $K(h)$  is the unsaturated hydraulic conductivity function [ $\text{L T}^{-1}$ ],  $K_s$  is the saturated hydraulic conductivity [ $\text{L T}^{-1}$ ],  $\alpha$  [ $\text{L}^{-1}$ ],  $n$ , and  $m$  (both dimensionless) are empirical shape parameters where  $m = 1 - (1/n)$ , and  $l$  is the pore connectivity parameter (dimensionless). The  $l$  parameter was estimated by Mualem (1976) to be about 0.5 as an average for many soils and this value was adopted in this study. Hysteresis was not considered in this study even though alternating drying and wetting cycles occurred during the experimental period. By calibrating the  $\alpha$  parameter, we obtained an average single retention curve somewhere between the main drying and wetting curves.

Since direct measurement of soil hydraulic parameters (i.e.,  $\theta_r$ ,  $\theta_s$ ,  $K_s$ ,  $\alpha$ ,  $n$  and  $l$ ) in the field or laboratory is time consuming and costly, they were estimated using the ROSETTA model (Schaap et al., 2001), using particle size and bulk density data determined on soil samples taken from lysimeter depths of 0–20, 20–40, 40–60, 60–85, and 85–110 cm. Values of selected hydraulic parameters ( $\alpha$  and  $K_s$ ) for different soil layers were further fine-tuned using an inverse modelling technique. The calibration of the saturated hydraulic conductivity  $K_s$  and the  $\alpha$  parameter was done using selected values (17) of experimental water contents and leaching data. Final values of soil hydraulic parameters utilised in the model are shown in Table 1.

## 2.5. Crop evapotranspiration

HYDRUS requires separate values of potential evaporation ( $E_p$ ) and potential transpiration ( $T_p$ ) as inputs. These inputs were calculated on a daily basis from values of reference evapotranspiration ( $ET_0$ ), collected at the Loxton Meteorological Station, following the dual crop coefficient method (Allen et al., 1998). In this approach, evapotranspiration of the crop ( $ET_C$ ) is estimated using the following equation:

$$ET_C = (K_{cb} + K_e) \times ET_0 \quad (5)$$

where  $K_{cb}$  is the basal crop coefficient and  $K_e$  is the evaporation coefficient. Unpacking this equation into its component parts gives two further equations:

$$T_p = K_{cb} \times ET_0 \quad (6)$$

$$E_p = K_e \times ET_0 \quad (7)$$

**Table 1**  
Soil hydraulic parameters (van Genuchten parameters) used in the model.

Soil depth (cm)	Soil Texture	$\theta_r$ (cm <sup>3</sup> cm <sup>-3</sup> )	$\theta_s$ (cm <sup>3</sup> cm <sup>-3</sup> )	$\alpha^a$ (cm <sup>-1</sup> )	$n^b$	$K_s^a$ (cm h <sup>-1</sup> )	$l^c$
0–20	Loamy sand	0.06	0.37	0.0294	1.92	4.87	0.5
20–40	Loamy sand	0.06	0.36	0.0268	1.91	4.46	0.5
40–60	Loamy sand	0.05	0.34	0.0308	1.99	4.72	0.5
60–85	Sandy loam	0.05	0.33	0.0300	1.85	3.30	0.5
85–110	Coarse sand	0.03	0.40	0.0950	2.68	29.70	0.5

<sup>a</sup> Optimised during calibration.

<sup>b</sup> Obtained from ROSETTA data base.

<sup>c</sup> Assumed a fixed value.

where  $T_p$  is potential transpiration; and  $E_p$  is potential soil evaporation.

The  $K_{cb}$  values for different months were taken from Allen et al. (1998), assuming 70% canopy cover and no ground cover, since the lysimeter was placed in a well-grown citrus orchard, and the lysimeter soil surface was kept free of weeds during the experimental period. Estimated  $T_p$  and  $E_p$  values during the experimental period varied from 1.5 to 3.2 mm day<sup>-1</sup> and from 0.5 to 1.1 mm day<sup>-1</sup>, respectively. The total  $T_p$  and  $E_p$  during the experimental period were 59.3 and 21.1 mm, respectively. Note that the potential  $ET_C$  (80.4 mm) was larger than the 10-year average, which was used for irrigation (68.6 mm). However, since additional rainfall occurred during the experiment, no shortage of water was expected.

HYDRUS reduces the potential transpiration ( $T_p$ ) to the actual transpiration ( $T_a$ ) by integrating actual water uptake over the entire root zone, while considering water and salinity stresses. HYDRUS implements a scheme whereby the actual evaporation ( $E_a$ ) remains equal to the potential evaporation ( $E_p$ ) as long as the pressure head at the boundary is higher than a critical pressure head  $h_{CritA}$ , considered to be  $-10,000$  cm in our study. When the pressure head on the soil surface boundary falls below  $h_{CritA}$ , the potential evaporation is reduced.

The total rainfall was considered to be equal to the effective rainfall for the purpose of modelling, and canopy interception was not considered because throughfall and stemflow account for about 90–95% of precipitation in citrus (Li et al., 1997). Runoff was also not considered as the lysimeter was a closed system, which does not allow for surface runoff.

## 2.6. Root distribution and water uptake functions

A citrus tree has a relatively shallow, well branched framework of woody laterals and fine fibrous roots. Root density decreases substantially below a depth of 60 cm, with very few roots at 120 cm (Castle, 1980; Paramasivam et al., 2001). Mikhail and El-Zeftawi (1979) reported that the citrus root depth in the Murray Darling Basin in Australia ranges from 60 to 90 cm, depending on the soil type (being deeper in deep sandy soils). However, in a closed system like a lysimeter, where lateral growth is constrained, roots are expected to grow further in the vertical direction compared to lateral growth. Hence, the root distribution for an orange tree in a lysimeter was described using the Vrugt et al. (2001) model, with most roots extending 50 cm radially and 85 cm vertically. The two-dimensional root water uptake model adapted in HYDRUS is expressed as:

$$\beta(r) = \left[ 1 - \frac{z}{z_m} \right] \left[ 1 - \frac{r}{r_m} \right] e^{-(p_z/z_m|z^* - z| + p_r/r_m|r^* - r|)} \quad (8)$$

where the parameters used in the model for citrus were as follows: the maximum rooting depth ( $z_m$ ) was taken equal to the maximum depth of the lysimeter (85 cm) and  $r_m$  was fixed equal to the radius of the lysimeter, i.e., 50 cm. The visual observation of roots while transferring the plant to the lysimeter also suggested

similar values for these parameters. Based on the visual observation,  $z^*$  was considered to be 30 cm and  $r^*$  was taken as 25 cm. These values depict the zone of the maximum water availability (just below the drippers). Empirical coefficients  $p_z$  and  $p_r$  were assumed to be 1.5 and 2, respectively, to correspond to the optimum uptake in the lysimeter conditions, considering the above listed parameters. Similar root distributions were used in all simulations, although in reality the spatial root distribution may differ depending on water availability and inherent soil variability.

In the HYDRUS software, a sink term is used to account for water uptake by plant roots using the water stress response function  $\alpha(h)$  (Feddes et al., 1978). This function includes five variables that describe the dependence of the extraction of water from the soil on pressure head. The values used for these parameters ( $h_1 = -10$ ,  $h_2 = -25$ ,  $h_{3max} = -200$ ,  $h_{3min} = -1000$ , and  $h_4 = -8000$  cm) were taken from Taylor and Ashcroft (1972) for orange.

Even though the root distribution was the same in all scenarios, the spatial distribution of root water uptake may vary in different scenarios, because the variable distribution of moisture (pressure head) in the soil profile affects root water uptake.

## 2.7. Flow domain and its discretization

The simulation domain was represented by a 110-cm deep and 100-cm wide cylindrical cross section. Drip irrigation was modelled as a circular line source 25 cm from the centre of the lysimeter with a uniform water flux ( $q_0$ ) along the drip line. This simplification was made to enable HYDRUS to model this problem in a 2D axi-symmetrical mode (Fig. 3), rather than in a full 3D mode, which would be computationally much more demanding. Additionally, since the surface wetted area and input flux densities under drippers were dynamic, an option that we would not be able to model with HYDRUS in a 3D mode, we assumed that the simplification of the problem to axi-symmetrical 2D was adequate. Moreover, the drainage system laid out in the lysimeter (Fig. 1) also supported the use of an axi-symmetrical domain as the drainage pipes run in a circular fashion to collect and flush drainage water out of the lysimeter. The transport domain was discretized into 3294 finite elements, with a very fine grid (1 cm) around the dripper and near the outflow (seepage face), with gradually increasing element spacing farther from these two locations (up to 4 cm). Simulations were carried out over a period of 29 days.

## 2.8. Initial and boundary conditions

The variable water flux ( $q_0$ ) representing drip irrigation was represented by the water application rate over the modelled drip line surface area:

$$q_0 = \frac{3 \times 4000}{(\pi r_2^2 - \pi r_1^2)} = 7.636 \text{ cm h}^{-1} \quad (9)$$

where  $r_1$  and  $r_2$  are the inner and outer radii of the circular dripline discharge boundary, assumed to be 20 and 30 cm, respectively,



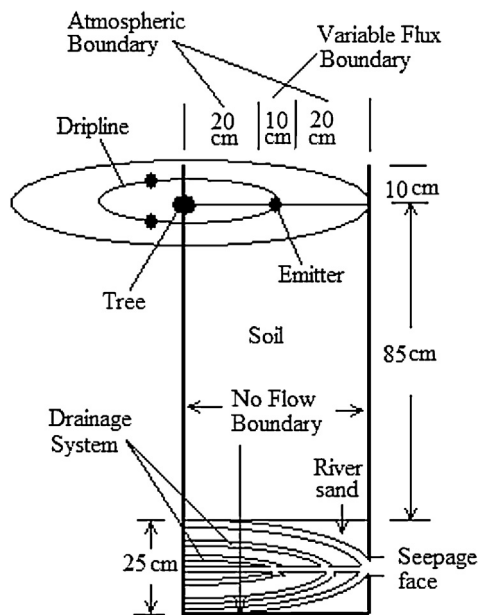

Fig. 3. Schematic of a lysimeter with boundary conditions used in numerical simulations.

4000 is the dripper recharge rate ( $\text{cm}^3 \text{h}^{-1}$ ), and 3 is the number of drippers.

The remainder of the soil surface was subjected to the atmospheric boundary condition, defined by potential evaporation ( $E_p$ ), potential transpiration ( $T_p$ ), and rainfall. Vertical sides were no flow boundaries except for a seepage face (5 cm) at the right bottom boundary, which represents a water outlet allowing drainage from the lysimeter. Cauchy and Neumann solute transport boundary conditions were imposed at the soil surface and the seepage face, respectively. The initial soil water content distribution (Fig. 4) was based on EnviroSCAN measured values and varied from 0.07 to  $0.4 \text{ cm}^3 \text{ cm}^{-3}$  from the top to the bottom of the lysimeter, having a positive downward gradient. The soil profile was assumed to be initially solute free.

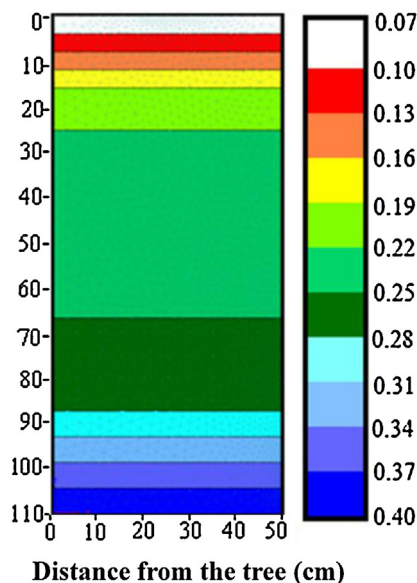

Fig. 4. Initial distribution of volumetric soil water content ( $\text{cm}^3 \text{ cm}^{-3}$ ) in the lysimeter.

## 2.9. Nitrate modelling

Since most soils on which citrus is grown in South Australia are coarse textured soils with good drainage, high oxygen levels, low organic matter, and low microbial populations, denitrification and mineralisation was assumed to be negligible in this study. Similarly, the soil adsorption of nitrate was also considered to be negligible since both nitrate and solid surfaces are negatively charged. Plant uptake of non-adsorbing nutrients like nitrate is controlled mainly by mass flow of water uptake (Barber, 1995). Therefore, it was assumed that nitrate was either passively taken up by the tree with root water uptake (Šimůnek and Hopmans, 2009) or moved downward with soil water. Spatial distribution of nitrate in the transport domain was thus simulated using the convection–dispersion equation for a nonreactive tracer. Molecular diffusion was neglected as it was considered negligible relative to dispersion. The longitudinal dispersivity was considered to be 5 cm, with the transverse dispersivity being one-tenth of this (i.e. 0.5 cm). Similar values of these parameters have been used in other studies (Gårdenäs et al., 2005; Hanson et al., 2006).

## 2.10. Fertigation scenarios

Citrus trees in this region are fertilised from early September till March, and in drip systems fertilizers are mostly applied with the second irrigation pulse for the day. All fertigation scenarios reported here are hypothetical. Fertigation was assumed to be supplied with the same quantity of water as in irrigations without fertigation and to conform to the 2D axi-symmetrical domain. For the initial scenario, 5 fertigation pulses were applied from 30 August 2010 at the rate of one fertigation pulse each day. These were followed by 2 days without fertigation and then another 5 daily fertigation pulses. The resultant dose of N ( $144 \text{ g KNO}_3$  or  $20 \text{ g N per tree}$ ) for the period from 16 August till 13 September (1 month) was calculated based on recommended fertilizer application practices for 5–6 year old orange tree. The seasonal recommended dose of nitrogen for an orange tree of this age is  $139 \text{ g N}$  applied from September to March (Treeby et al., 2012). Hence for the seasonal simulation, nitrogen was assumed to be applied in equal monthly doses ( $20 \text{ g N}$  for 7 months), in similar pulses as described for the experimental period. The simulation was run for 300 days in order to evaluate the fate of seasonally applied nitrogen ( $140 \text{ g N}$ ) fertilizer in citrus.

Further scenarios examining the impact of timing of nitrogen application on the efficiency of nitrogen uptake simulated a fertilizer application either at the beginning (PF1), middle (PF2), or end (PF3) of the daily irrigation scheme. Since the daily irrigation consisted of 5 pulses, fertigation was applied during the 2, 3 and 4 irrigation pulse in the PF1, PF2 and PF3 scenarios, respectively. It is a common practice that the initial and final irrigation pulses are fertilizer free to ensure a uniform fertilizer application and flushing of the drip lines.

In addition to these simulations, two continuous fertigation scenarios were also performed to compare pulsed and continuous fertigation. The first scenario consisted of applying the same amount of fertilizer (as applied in single pulse fertigation) spread across all irrigation pulses (PF), except for the last irrigation pulse to enable flushing. The second scenario consisted of continuous irrigation of the same duration and irrigation amount as under pulsed treatments, with fertigation at all times (CF), except for the same period of flushing at the end of irrigation. The fertigation scheme in PF1, PF2, PF3 and continuous scenarios was assumed to start from 17 August 2010. All fertigation simulations were run as for the irrigation experiment, that is for 29 days (from 16 August, 2010 to 13 September, 2010).

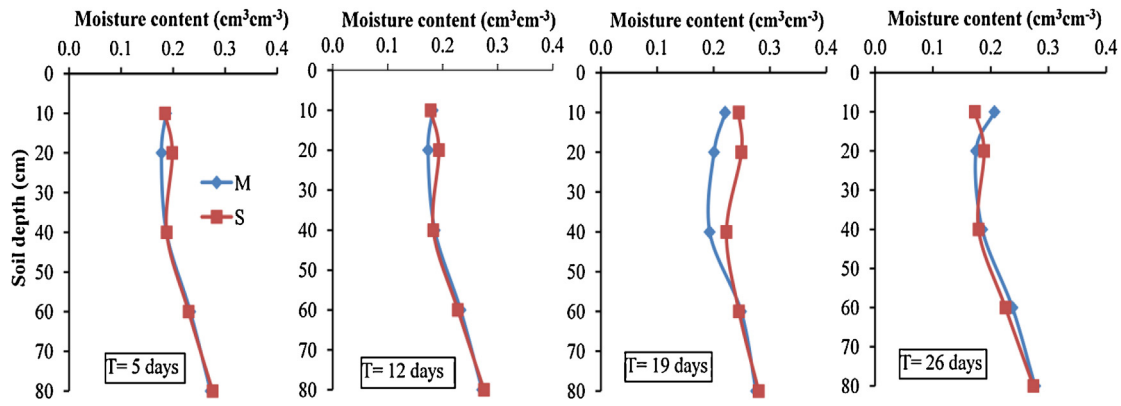

Fig. 5. Comparison of measured (M) and simulated (S) water contents in the soil at selected times (T).

To evaluate the impact of the quantity of irrigation water on nitrate leaching, additional simulations were run for all scenarios with 50% ( $I_{50}$ ), 75% ( $I_{75}$ ), and 125% ( $I_{125}$ ) of irrigation water applied in the field experiment ( $I_{100}$ ).

### 2.11. Statistical analysis

The performance of the model was evaluated by comparing measured (M) and HYDRUS-2D simulated (S) values of moisture distribution in the soil at different times using various quantitative measures of the uncertainty, such as, the mean absolute error (MAE), the root mean square error (RMSE), and the paired  $t$ -test ( $t_{cal}$ ) given by:

$$MAE = \frac{1}{N} \sum_{i=1}^N |M_i - S_i| \quad (10)$$

$$RMSE = \sqrt{\frac{1}{N} \sum_{i=1}^N (M_i - S_i)^2} \quad (11)$$

$$t_{cal} = \frac{d}{S_m \sqrt{1/n_1 + 1/n_2}}; \quad d = \bar{x}_1 - \bar{x}_2 \text{ and } S_m = \sqrt{\frac{n_1 s_1^2 + n_2 s_2^2}{n_1 + n_2 - 2}} \quad (12)$$

Here,  $n$  and  $s$  are the number of comparable paired points and standard deviation, respectively; subscripts 1 and 2 are indicative of their respective measured and predicted values,  $d$  is the difference between measured ( $x_1$ ) and simulated ( $x_2$ ) mean values,  $S_m$  is the standard deviation of the mean, and  $t_{cal}$  are the calculated  $t$ -test values. For a perfect match between measured and simulated values  $MAE = RMSE = 0$ . Differences between mean measured and simulated values are significant if the  $t_{cal} > t_{tab}$  at  $(n_1 + n_2 - 2)$  degrees of freedom.

In addition to the error indices listed above, other efficiency measures evaluating the model performance investigated in this study were the coefficient of determination ( $r^2$ ), the model efficiency ( $E$ ), and the relative model efficiency ( $RE$ ). The coefficient of determination  $r^2$  is defined as the squared value of the coefficient of correlation according to Bravais-Pearson. It is calculated as:

$$r^2 = \left( \frac{\sum_{i=1}^N (M_i - \bar{M})(S_i - \bar{S})}{\sqrt{\sum_{i=1}^N (M_i - \bar{M})^2} \sqrt{\sum_{i=1}^N (S_i - \bar{S})^2}} \right)^2 \quad (13)$$

The range of  $r^2$  lies between 0 and 1, which describes how much of the observed dispersion is explained by the prediction. A value of zero means no correlation at all, whereas a value of 1 means that the dispersion of the predictions is equal to that of the observations (Krause et al., 2005). The model efficiency ( $E$ ) proposed by Nash and Sutcliffe (1970) is calculated as:

$$E = 1 - \frac{\sum_{i=1}^N (M_i - S_i)^2}{\sum_{i=1}^N (M_i - \bar{M})^2} \quad (14)$$

The criteria described above ( $r^2$ ,  $E$ ) quantify the difference between observations and predictions with respect to the absolute values. As a result, an over- or under-prediction of higher values has, in general, a greater influence than those of lower values (Krause et al., 2005). To counteract this, efficiency measures based on a relative deviation can be derived from  $E$  as:

$$RE = 1 - \frac{\sum_{i=1}^N (M_i - S_i/M_i)^2}{\sum_{i=1}^N (M_i - \bar{M}/\bar{M})^2} \quad (15)$$

where  $RE$  represents the relative efficiency. The purpose of considering a range of statistical parameters was to evaluate the relative importance of various tests for assessing the model performance.

The value of  $E$  and  $RE$  in Eqs. (14) and (15) may range from minus infinity to one, with one representing a perfect fit of the data.  $E \leq 0$  means that the mean value of the observations (measurements) would have been a better predictor than the model, and efficiency values between 0 and 1 are generally viewed as acceptable levels of performance (Moriassi et al., 2007).

## 3. Results and discussion

### 3.1. Soil water distribution and water balance

The water content distribution in the soil reflects water availability to plants, and plays a crucial role in water movement through and out of the root zone. Volumetric water contents simulated by HYDRUS 2D/3D are compared in Fig. 5 with the measured values obtained using EnviroSCAN probes 15 cm away from the dripper. Simulated values matched measured values well, both spatially and temporally. However, deviations between simulated and measured values were observed at day 19 of simulation, particularly in the upper 50 cm of the soil profile; at later times this difference was not observed.

Simulated and observed daily and cumulative drainage are compared in Figs. 6 and 7, respectively. Both variables showed a close match between simulated and measured values. It can be seen that simulated daily drainage remained slightly below observed values (Fig. 6), except for the initial higher leaching on day 1. However, the

**Table 2**  
Statistical estimates between measured and simulated values of moisture content at different time of simulation.

Statistical parameters	Days of simulation									
	2	5	9	12	16	19	22	26	29	
MAE	0.006	0.006	0.007	0.007	0.011	0.022	0.005	0.014	0.014	
RMSE	0.011	0.009	0.011	0.009	0.014	0.028	0.007	0.018	0.017	
$t_{cal}$ ( $P=0.05$ )	-0.209	-0.152	-0.205	-0.095	0.164	-1.158	0.020	0.313	0.392	
$r^2$	0.93	0.94	0.93	0.94	0.88	0.68	0.96	0.84	0.86	
$E$	0.91	0.93	0.91	0.94	0.86	0.17	0.96	0.78	0.78	
$RE$	0.88	0.90	0.88	0.91	0.82	-0.05	0.95	0.75	0.76	

MAE: Mean absolute error; RMSE: Root mean square error;  $t_{cal}$ : Calculated value of paired  $t$ -test;  $r^2$ : Coefficient of determination;  $E$ : Nash and Sutcliffe efficiency;  $RE$ : Relative efficiency.

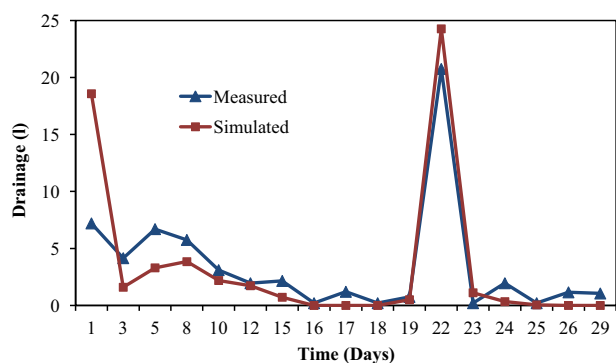

**Fig. 6.** Temporal changes in observed and simulated daily drainage volumes.

total drainage observed in the lysimeter was matched closely by the model. The high peak on day 21 represents the effect of high rainfall on that day, which also was very well predicted by the model. However, the cumulative drainage (Fig. 7) remained slightly over-predicted during the initial 15 days, after which the simulated and observed values matched well.

Model evaluation was performed using a number of model performance parameters calculated using measured and model-generated soil water contents (Table 2). The mean absolute error (MAE) varied from 0.006 to 0.22 cm<sup>3</sup> cm<sup>-3</sup> and the root mean square error (RMSE) ranged between 0.007 and 0.028 cm<sup>3</sup> cm<sup>-3</sup>, which indicated small deviations between measured and simulated values. However, the maximum values of MAE and RMSE were observed at day 19, confirming the deviations shown in Fig. 5 at this time. However, the values of paired  $t$ -test ( $t_{cal}$ ) between measured and simulated water contents showed insignificant differences at 5% level of significance at all times. Values of the coefficient of determination ( $r^2$ ) varied between 0.68 and 0.96, indicating a reliable generation of water contents by the model at all days of simulations. Similarly, the Nash and Sutcliffe efficiency coefficient ( $E$ ) values ranged from 0.17 to 0.96, indicating a good performance of the model for the prediction of water contents in this study.

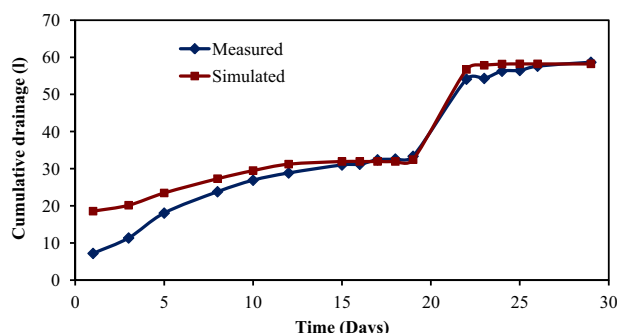

**Fig. 7.** Evolution of observed and simulated cumulative drainage.

However, the relative efficiency ( $RE$ ) value at day 19 (-0.05) reveals unsatisfactory performance of the model at that point according to the criteria suggested by Moriasi et al. (2007). The values of MAE, RMSE,  $r^2$ ,  $E$ , and  $RE$  for the drainage flux were 2.87, 4.14, 0.97, 0.94, and 0.78 (not shown here), respectively, which also showed a robust performance of the model for drainage fluxes from the lysimeter.

The close match of both water contents (except at day 19) and drainage fluxes indicates that the HYDRUS 2D/3D software can be successfully used to predict water movement and drainage fluxes in a lysimeter planted with a citrus tree. Other studies have also reported good performance of this software for various soil, water, and crop conditions under pressurised irrigation systems (e.g., Assouline et al., 2006; Ajdary et al., 2007; Patel and Rajput, 2008; Phogat et al., 2012, 2013; Ramos et al., 2012).

Simulated water balance components over the 29 day experimental period are shown in Table 3. It can be seen that simulated drainage, which is similar to the amount measured in the lysimeter, represents 48.9% of the total water balance. A much higher seasonal drainage (58.4–67.8% of the total water applied) has been reported for a lysimeter planted with an orange tree in a fine sandy soil (Boman and Battikhi, 2007). High drainage is bound to occur in highly permeable, coarse textured soils, such as the sand/loamy soil used in this study, where water drains easily and quickly from the root zone because gravity dominates over capillarity (Cote et al., 2003). However, Sluggett (2010) estimated deep drainage in the range of 6.1–37.2% under citrus trees growing in light textured soils in the Sunraysia region of Australia. A major contributor to the high drainage measured in this experiment was the high amount of water applied, mostly as a result of large rainfall events.

Simulated plant water uptake was estimated to be 40% of the water application, indicating low irrigation efficiency of the drip system. The daily plant uptake varied from 1.2 to 3.14 mm (not shown here). However, plant uptake is a very complex process, and depends on a number of parameters describing the root and canopy development. Since the HYDRUS model does not support a dynamic behaviour of the root system and considers only the static root parameters, root uptake was optimised on the basis of a changing transpiration rate over time. Additionally, since in the present study we dealt with a tree, for which the root distribution development over time is not as fast as observed for seasonal crops like

**Table 3**  
Simulated components of the water balance after 29 days.

	Components	(mm)	(%)
Sources	Irrigation	68.6	46.4
	Rainfall	70.2	47.5
	Soil depletion	9.1	6.1
Sinks	Root uptake	59.2	40.0
	Drainage	72.3	48.9
	Evaporation	16.4	11.1



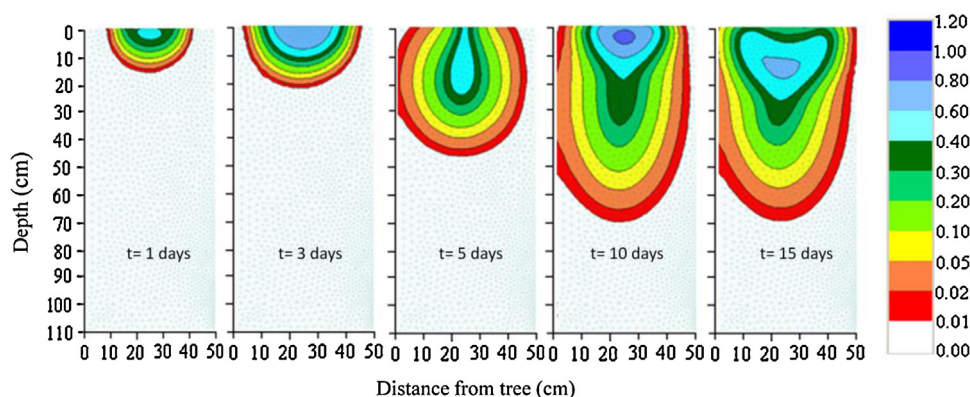

**Fig. 8.** Spatial distribution of soil solution nitrate ( $\text{mg cm}^{-3}$ ) around an orange tree at selected times after commencement of fertigation, up to the end of applications (15 days).

**Table 4**

Simulated components of nitrogen balance, at 15 and 285 days of fertigation commencement.

Time	15 days		285 days	
	(g)	(%)	(g)	(%)
Root uptake	5.13	25.5	58.84	42.1
Leaching	0	0.0	70.05	50.2
Soil storage	14.88	74.5	10.75	7.7

cereals, the root development was considered relatively constant for the modelling purpose. Hence, a static root distribution and variable atmospheric conditions produced a good approximation of plant uptake, as has been revealed in a number of earlier studies that used HYDRUS for modelling purposes (Sansoulet et al., 2008; Phogat et al., 2012, 2013; Ramos et al., 2011, 2012; Tournéville et al., 2012)

### 3.2. Nitrate distribution and uptake

Simulated distribution of nitrate ( $\text{NO}_3\text{-N}$ ) at selected times after commencement of fertigation is shown in Fig. 8. Concentration of  $\text{NO}_3\text{-N}$  was maximum at the centre of the plume below the dripper, with a gradual decrease in N concentration towards the outer boundaries of the plume. Subsequent irrigation and fertigation pulses resulted in enlargement of the plume, with a rapid lateral and vertical movement of  $\text{NO}_3\text{-N}$ . It is worth noticing that after 15 days of fertigation (29 days of simulation) all nitrate still remained in the lysimeter, reaching a depth of 70 cm. The maximum nitrate concentration at this time was at 20 cm. The simulated  $\text{NO}_3\text{-N}$  uptake accounted only for 25.5% of applied nitrogen (Table 4). The remaining nitrogen was still available in the soil for

plant uptake, provided it was not transformed by soil biological processes. No nitrate leaching was predicted by the model within this initial 15 day period. The total seasonal recovery of applied N (applied through 70 daily fertigation pulses) amounts to 42.1% by the orange tree, while 7.7% of added  $\text{NO}_3\text{-N}$  was retained in the soil at the end of the season. These results agree with the findings of Paramasivam et al. (2002) who reported 40–53% nitrogen uptake in a field experiment on citrus. Similarly, Boaretto et al. (2010) showed 36% recovery of applied nitrogen by an orange tree in a lysimeter.

The seasonal distribution of nitrate in the soil at 30-day intervals after the fertigation commencement is shown in Fig. 9. It can be seen that nitrate rapidly moved downwards and dispersed in the lysimeter, reaching a depth of 95 cm after 30 days. However, the zone of the maximum concentration remained close to the soil surface. Subsequent fertigation pulses further pushed N near to the leaching outlet at 60 days and N dispersed throughout the lysimeter, beyond which regular N leaching was observed with subsequent fertigations. However, the concentration of N remained much higher in the upper soil depth (30 cm) till 180 days of fertigation, enabling its continued uptake by the orange tree. The nitrogen concentration thereafter reduced drastically in the upper zone (0–30 cm) as a result of the withdrawal of fertigation after 195 days of simulation (180 days of fertigation). At 210 days after commencement of fertigation (30 days after fertigation ceased), the  $\text{NO}_3\text{-N}$  concentration in the domain ranged between 0 and  $0.4 \text{ mg cm}^{-3}$ , and continued to decline until it completely moved out of the upper 40 cm soil depth at 270 days. At the end of the simulation (285 days after fertigation began and 105 days after fertigation ceased), only a very small amount of nitrate (7.7%) remained in the lysimeter, with higher concentration occurring at the bottom of the lysimeter (Table 4), indicating higher vulnerability of this N to leaching. Major leaching of  $\text{NO}_3\text{-N}$  took place after 90 days of simulation, amounting to 61%

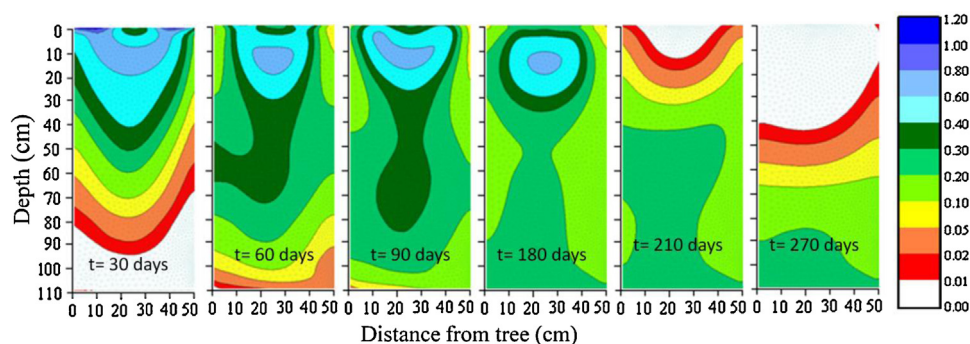

**Fig. 9.** Distribution of  $\text{NO}_3\text{-N}$  ( $\text{mg cm}^{-3}$ ) in the lysimeter at indicated days of fertigation commencement.

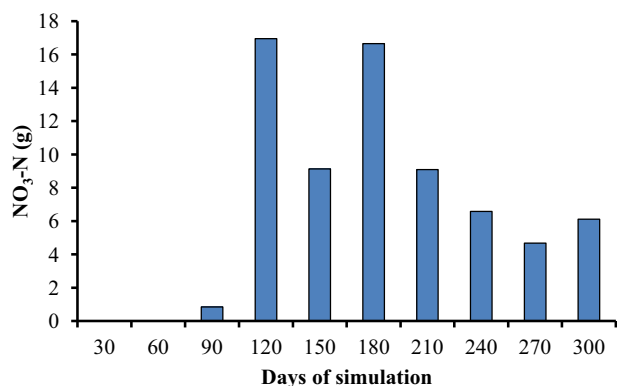

**Fig. 10.** Seasonal leaching of applied nitrogen ( $\text{NO}_3\text{-N}$ ) at 30-days interval of simulation.

of total N leaching between 90 and 180 days (Fig. 10), which corresponds to heavy precipitation of 95 mm on day 115 and 68 mm on day 152 of simulation. Paramasivam et al. (2001) and Nakamura et al. (2008) also reported that unexpectedly prolonged irrigation or high rainfall following fertilizer applications led to higher  $\text{NO}_3\text{-N}$  leaching losses.

Total nitrate leaching amounted to 50.2% of the N applied as fertilizer (Table 4). Nitrate losses of similar magnitude (35–53%) have also been reported by Syvertsen and Sax (1999) and Boman and Battikhi (2007) in a lysimeter grown orange tree. On the other hand, low  $\text{NO}_3\text{-N}$  leaching losses ranging from 2 to 16% of the applied nitrogen have been reported in some studies on citrus (Paramasivam et al., 2001; Syvertsen et al., 1993). The migration of nitrate to deeper layers is highly dependent on the amount of irrigation and rainfall, as this is the driving force moving nitrate out of the root zone. Lower nitrate leaching estimated in this study may have been a consequence of improved irrigation and fertilizer management through the drip system. Hence improved water efficiency under drip irrigation, by reducing percolation and evaporation losses, can contribute considerably towards environmentally safer fertilizer applications (Mmolawa and Or, 2003).

In addition to the factors discussed above, a choice of appropriate source, amount, frequency, and timing of fertilizer applications and the rate of N transformation into  $\text{NO}_3$  are other important factors that determine the amount of  $\text{NO}_3\text{-N}$  leaching out of the vadose zone (Alva et al., 2006).

### 3.3. Scenario analysis

Temporal distribution of nitrate for different fertigation scenarios is presented in Fig. 11. Although nitrate movement appears to be similar in all scenarios, small differences can be observed in nitrate distribution in the soil for some scenarios. In scenarios PF and PF3, in which fertilizer was applied with all pulses in low concentrations or towards the end of irrigation, the N concentration after 2, 7, and 14 days was slightly higher in the centre of the plume where root activity was at a maximum. However, the nutrient uptake varied within a narrow range (46.8–47.4%) under normal irrigation ( $I_{100}$ ), indicating an insignificant impact of fertigation timing under conditions experienced in our lysimeter study. Contrary to this, Hanson et al. (2006) reported 14% higher nitrate uptake when fertilizer was applied at the end of the irrigation event in a HYDRUS simulation that was based on historical irrigation and fertigation data. A similar observation was also made by Paramasivam et al. (2002) and Alva et al. (2006) in field experiments. Gärdenäs et al. (2005) also concluded that fertigation applied towards the end of the irrigation cycle generally reduces the potential for nitrate leaching under micro-irrigation systems, with the exception of clayey soils.

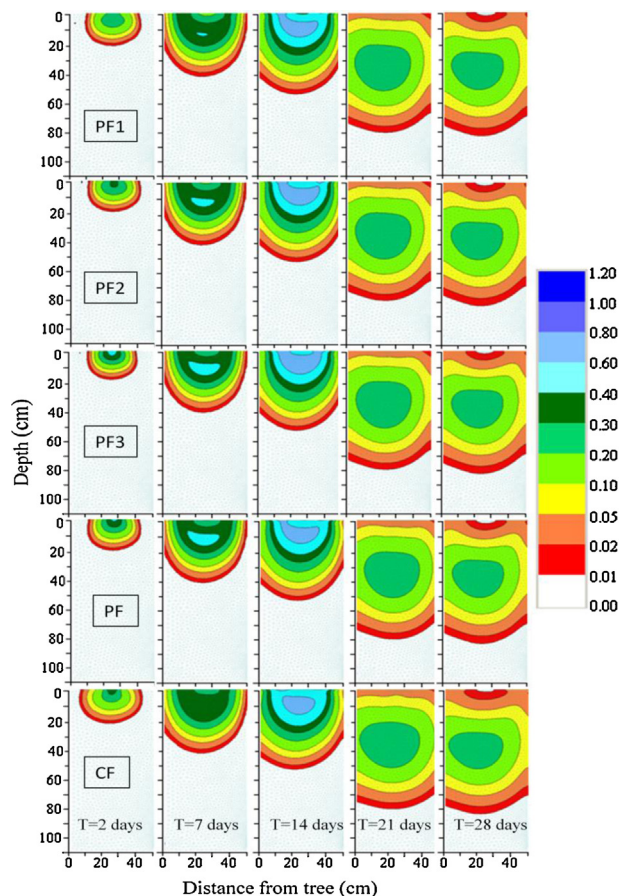

**Fig. 11.** Spatial distribution of nitrate ( $\text{mg cm}^{-3}$ ) at selected times for different pulsed fertigation scenarios [fertigation at the beginning of irrigation (PF1), fertigation in the middle of irrigation (PF2), fertigation towards the end of irrigation (PF3), fertigation in all pulses (PF)] and for continuous irrigation with fertigation (CF).

A short fertigation pulse (1–3 min) used in our study, as compared to the other studies, may have reduced differences among various scenarios. However, these results imply that fertigation in a short pulse towards the end of the irrigation event or low concentration fertigation with all pulses could increase the efficiency of nitrogen fertigation as compared to other options.

Nitrate distribution in the domain after 21 and 28 days were similar in all scenarios (Fig. 11), and all differences disappeared by 21 days of simulation. It can be shown that while nitrate distribution varied during one application phase, they were similar for all scenarios at the end of each irrigation cycle. Also, nitrate moved to a similar soil depth (60 cm) after 28 days in all scenarios. These scenarios did not produce any  $\text{NO}_3\text{-N}$  leaching because of the short simulation period.

A comparison of nitrate uptake between pulsed (PF) and continuous (CF) irrigations revealed that scenarios with pulsed irrigation (PF) had almost alike nitrate uptake (47.4%) as fertigation with continuous irrigation (CF) (47.2%) (Table 5). Similar results were obtained in scenarios with different irrigation quantities (50%, 75%, and 125% of normal irrigation). A negligible impact of pulsing on moisture distribution pattern and drainage has been reported in earlier studies for different dripper discharge rates and spacings (Skaggs et al., 2010; Phogat et al., 2012). This observation further confirms that pulsing has little impact on solute distribution in the soil under optimal irrigation applications as compared to continuous irrigation.

**Table 5**  
Nitrogen ( $\text{NO}_3\text{-N}$ ) balance under variable irrigation application [50% of  $ET_C$  ( $I_{50}$ ); 75% of  $ET_C$  ( $I_{75}$ ); 100% of  $ET_C$  ( $I_{100}$ ); and 125% of  $ET_C$  ( $I_{125}$ )] for different fertigation scenarios.

Components of $\text{NO}_3\text{-N}$ balance	Fertigation scenarios <sup>a</sup>				
	PF1	PF2	PF3	PF	CF
<b><math>I_{50}</math> Treatment</b>					
Applied (g)	20.01	19.99	19.99	19.99	19.96
Root uptake (g)	11.08	11.05	11.13	11.07	11.22
Leaching (g)	0	0	0	0	0
Uptake efficiency (%)	55.38	55.25	55.67	55.37	56.21
<b><math>I_{75}</math> Treatment</b>					
Applied (g)	19.99	19.99	19.99	19.99	19.97
Root uptake (g)	10.11	10.11	10.20	10.17	10.27
Leaching (g)	0.01	0.01	0.01	0.01	0.01
Uptake efficiency (%)	50.55	50.55	51.01	50.88	51.44
<b><math>I_{100}</math> Treatment</b>					
Applied (g)	19.99	19.99	19.99	19.98	19.96
Root uptake (g)	9.36	9.38	9.45	9.53	9.42
Leaching (g)	0.10	0.09	0.08	0.08	0.11
Uptake efficiency (%)	46.83	46.92	47.28	47.72	47.21
<b><math>I_{125}</math> Treatment</b>					
Applied (g)	19.99	19.99	19.99	19.99	19.99
Root uptake (g)	8.64	8.70	8.74	8.74	8.71
Leaching (g)	0.86	0.79	0.71	0.80	0.88
Uptake efficiency (%)	43.22	43.52	43.69	43.72	43.57

<sup>a</sup> P: Pulsed irrigation, C: Continuous irrigation, F: Fertigation at all times, F1: Fertigation pulse at the beginning of irrigation, F2: Fertigation pulse in the middle of irrigation, F3: Fertigation pulse towards the end of irrigation.

Modelling simulations were also performed to evaluate the impact of variable irrigation applications on nitrate movement for scenarios discussed above (Table 5). It can be seen that plant  $\text{NO}_3\text{-N}$  uptake gradually reduced as the amount of irrigation increased. The nitrogen uptake efficiency for the 50% irrigation ( $I_{50}$ ) treatment varied from 55.3 to 56.2% for all scenarios of fertilizer applications, which was about 8.5% higher than uptake recorded for the normal irrigation ( $I_{100}$ ). On the other hand, a higher amount of irrigation (125%) than normal reduced nitrate uptake of an orange tree by further 3.4–3.6%. At the same time, the zone of maximum nitrate concentration moved to a depth of 40–60 cm (not shown here), where root uptake decreased exponentially due to the reduction in root density. Nitrate at this depth is neither available for trees, since the majority of active fibrous roots of orange trees are in the top 15–30 cm depth (Alva and Syvertsen, 1991; Zhang et al., 1996), nor can it be easily transformed because of the limited microbial population and available carbon at this depth (Paramasivam et al., 1999; Alva et al., 2006). This can potentially lead to eventual leaching losses to receiving water bodies. Hence over-irrigation not only led to a profound water loss, but also brought about a reduction in plant nitrogen uptake and an increase in potential danger of appreciable  $\text{NO}_3\text{-N}$  leaching losses in all fertigation scenarios. Therefore, the combination of inadequate management of irrigation and nitrogen fertilizers in commercial agriculture may lead to considerable nitrate losses out of the root zone, and may increase the risk of nitrate contamination of ground water aquifers.

#### 4. Conclusions

In the past, models have proved to be particularly useful for describing and evaluating transport processes, simulating conditions which are too difficult economically or impossible technically to be tested in controlled field experiments. In this study, modelling was combined with a lysimeter study to calibrate the HYDRUS model against water content and drainage measurements under an orange tree. Additional simulations were run to evaluate nitrate

leaching under long term conditions, and the impact of timing of fertigation on the fate of applied nitrogen.

Moisture content distributions and leaching volumes predicted by HYDRUS 2D/3D matched well with the measured values in the lysimeter, with a very low mean absolute error (MAE), root mean square error (RMSE) and paired *t*-test values. The performance of HYDRUS was robust, as revealed by high values of  $r^2$ , Nash and Sutcliffe efficiency (*E*) and relative efficiency (*RE*) analysis. Numerical simulations and the lysimeter study showed huge drainage losses (48.9%) in a lysimeter with a sandy soil irrigated with surface drippers. Model simulations were further used to evaluate nitrate uptake by an orange tree for various fertigation scenarios. Simulations showed that the timing of fertigation in scenarios with pulsed irrigation and continuous irrigation (CF) had little impact on nitrate uptake by an orange tree. Predicted seasonal nitrate losses accounted for 50.2% of the fertilizer applied in the lysimeter. Nitrate uptake by an orange tree in a lysimeter was regulated by the amount of irrigation applied. Higher uptake efficiency (55.6%) was obtained with the application of less water (50% of normal) than normal (47.1%). On the other hand, the uptake efficiency decreased by 3.5% with the application of 25% higher amount of irrigation than normal.

Results of this study suggest that in sandy soils, leaching losses and nitrate uptake by an orange tree in lysimeter were driven by amount of water application, either through irrigation or unexpected rainfall. However, there is a need to extend the modelling study over a full season or multiple years to assess total nitrate leaching and plant uptake under field conditions.

#### Acknowledgements

Financial support of the National Programme for Sustainable Irrigation, Agriculture NSW and SARDI is gratefully acknowledged.

#### References

- Ajdary, K., Singh, D.K., Singh, A.K., Khanna, M., 2007. Modelling of nitrogen leaching from experimental onion field under drip fertigation. *Agricultural Water Management* 89, 15–28.
- Allen, R.G., Pereira, L.S., Raes, D., Smith, M., 1998. Crop evapotranspiration guidelines for computing crop water requirements. In: *FAO Irrigation and Drainage Paper No. 56*. FAO, Rome, Italy.
- Allison, F.E., 1996. The fate of nitrogen applied to soils. *Advances in Agronomy* 18, 219–258.
- Alva, A.K., Paramasivam, S., Fares, A., Delgado, J.D., Mattos Jr., D., Sajwan, K.S., 2005. Nitrogen and irrigation management practices to improve nitrogen uptake efficiency and minimize leaching losses. *Journal of Crop Improvement* 15, 369–420.
- Alva, A.K., Paramasivam, S., Obreza, T.A., Schumann, A.W., 2006. Nitrogen best management practice for citrus trees I. Fruit yield, quality, and leaf nutritional status. *Scientia Horticulturae* 107, 233–244.
- Alva, A.K., Paramasivam, S., Mattos Jr., D., Quaggio, J.A., 2008. Advances in nitrogen fertigation of citrus. *Journal of Crop Improvement* 22, 121–146.
- Alva, A.K., Syvertsen, J.P., 1991. Irrigation water salinity affects soil nutrient distribution, root density, and leaf nutrient levels of citrus under drip fertigation. *Journal of Plant Nutrition* 14, 715–727.
- Assouline, S., 2002. The effects of microdrip and conventional drip irrigation on water distribution and uptake. *Soil Science Society of America Journal* 66, 1630–1636.
- Assouline, S., Moller, M., Cohen, S., Ben-Hur, M., Grava, A., Narkis, K., Silber, A., 2006. Soil-plant system response to pulsed drip irrigation and salinity: Bell pepper-Case study. *Soil Science Society of America Journal* 70, 1556–1568.
- Barber, S.A., 1995. *Soil Nutrient Bioavailability: A Mechanistic Approach*. John Wiley & Sons, New York.
- Bar-Yosef, B., 1999. Advances in fertigation. *Advances in Agronomy* 65, 1–77.
- Bar-Yosef, B., Sheikholeslami, M.R., 1976. Distribution of water and ions in soils irrigated and fertilized from a trickle source. *Soil Science Society of America Journal* 40, 575–582.
- Boaretto, R.M., Junior, D.M., Quaggio, J.A., Cantarella, H., Trivelin, P.C.O., 2010. Nitrogen-15 uptake and distribution in two citrus species. In: *19th World Congress of Soil Science, Soil Solutions for a Changing World, August 1–6, 2010, Brisbane, Australia*, pp. 156–159.
- Boman, B.J., Battikhi, A.M., 2007. Growth, evapotranspiration, and nitrogen leaching from young lysimeter grown orange trees. *Journal of Irrigation and Drainage Engineering* 133 (4), 350–358.



- Castle, W.S., 1980. Citrus root systems: their structure, function, growth, and relationship to tree performance. In: Proceedings of 4th International Citriculture Conference, Sydney, Australia, August 15–23, 1980. International Society of Citriculture, Sydney, Australia, pp. 62–69.
- Cote, C.M., Bristow, K.L., Charlesworth, P.B., Cook, F.J., Thorburn, P.J., 2003. Analysis of soil wetting and solute transport in subsurface trickle irrigation. *Irrigation Science* 22, 143–156.
- Feddes, R.A.P., Kowalik, J., Zaradny, H., 1978. Simulation of field water use and crop yield. Simulation Monographs Pudoc, Wageningen, The Netherlands.
- Gärdenäs, A.I., Hopmans, J.W., Hanson, B.R., Šimůnek, J., 2005. Two-dimensional modeling of nitrate leaching for various fertigation scenarios under microirrigation. *Agricultural Water Management* 74, 219–242.
- Hanson, B.R., Hopmans, J.W., Šimůnek, J., 2008. Leaching with subsurface drip irrigation under saline shallow groundwater conditions. *Vadose Zone Journal* 7, 810–818.
- Hanson, B.R., Šimůnek, J., Hopmans, J.W., 2006. Evaluation of urea–ammonium–nitrate fertigation with drip irrigation using numerical modelling. *Agricultural Water Management* 86, 102–113.
- Jiang, C., Xia, Z., 2008. Lysimeter studies on nitrogen transport and transformation as affected by contaminated water irrigation. *Journal of Hydrologic Engineering* 13 (5), 341–346.
- Kachanoski, R.G., Thony, J.L., Vauclin, M., Vachaud, G., Laly, R., 1994. Measurement of solute transport during constant infiltration from a point source. *Soil Science Society of America Journal* 58, 304–309.
- Krause, P., Boyle, D.P., Base, F., 2005. Comparison of different efficiency criteria for hydrological model Assessment. *Advances in Geosciences* 5, 89–97.
- Li, Y.C., Alva, A.K., Calvert, D.V., Zhang, M., 1997. Stemflow, throughfall and canopy interception of rainfall by citrus tree canopies. *Horticulture Science* 32, 1059–1060.
- Li, J., Liu, Y., 2011. Water and nitrate distributions as affected by layered-textural soil and buried dripline depth under subsurface drip fertigation. *Irrigation Science*, <http://dx.doi.org/10.1007/s00271-010-0255-z>.
- Li, R., Ma, J., Zhang, R., 2003. Estimating nitrate leaching with a transfer function model incorporating net mineralization and uptake of nitrogen. *Journal of Environmental Quality* 32, 1455–1463.
- Li, J., Yoder, R.E., Odhiambo, L.O., Zhang, J., 2004. Simulation of nitrate distribution under drip irrigation using artificial neural networks. *Irrigation Science* 23, 29–37.
- Mikhail, E.H., El-Zeftawi, B.M., 1979. Effect of soil type and rootstocks on root distribution, chemical composition of leaves and yield of Valencia oranges. *Australian Journal of Soil Research* 17, 335–342.
- Mmolawa, K., Or, D., 2003. Experimental and numerical evaluation of analytical volume balance model for soil water dynamics under drip irrigation. *Soil Science Society of America Journal* 67, 1657–1671.
- Moriassi, D.N., Arnold, J.G., Van Liew, M.W., Bingner, R.L., Harmel, R.D., Veith, T.L., 2007. Model evaluation guidelines for systematic quantification of accuracy in watershed simulations. *Transactions of the ASABE* 50, 885–900.
- Mualem, Y., 1976. A new model for predicting the hydraulic conductivity of unsaturated porous media. *Water Resources Research* 12, 513–522.
- Nakamura, K., Watanabe, S., Hirono, Y., 2008. Applications and problems of numerical modeling of Nitrogen transport in agricultural soils using HYDRUS. In: Saito, H., Sakai, M., Toride, N., Šimůnek, J. (Eds.), Proceedings of Third HYDRUS Workshop. Tokyo, Japan, June 28.
- Nash, J.E., Sutcliffe, J.V., 1970. River flow forecasting through conceptual models part I—A discussion of principles. *Journal of Hydrology* 10, 282–290.
- Pang, X.P., Letey, J., 1998. Development and evaluation of ENVIRO-GRO, an integrated water, salinity, and nitrogen model. *Soil Science Society of America Journal* 62, 1418–1427.
- Paramasivam, S., Alva, A.K., Fares, A., Sajwan, K.S., 2001. Estimation of nitrate leaching in an Entisol under optimum citrus production. *Soil Science Society of America Journal* 65, 914–921.
- Paramasivam, S., Alva, A.K., Fares, A., Sajwan, K.S., 2002. Fate of nitrate and bromide in an unsaturated zone of a sandy soil under citrus production. *Journal of Environmental Quality* 31, 671–681.
- Paramasivam, S., Alva, A.K., Prakash, O., Cui, S.L., 1999. Denitrification in the vadose zone and in surficial groundwater of a sandy entisol with citrus production. *Plant and Soil* 208, 307–319.
- Patel, N., Rajput, T.B.S., 2008. Dynamics and modeling of soil water under subsurface drip irrigated onion. *Agricultural Water Management* 95 (12), 1335–1349.
- Phogat, V., Malik, R.S., Kumar, S., 2009. Modeling the effect of canal bed elevation on seepage and water table rise in a sand box filled with loamy soil. *Irrigation Science* 27, 191–200.
- Phogat, V., Yadav, A.K., Malik, R.S., Kumar, S., Cox, J., 2010. Simulation of salt and water movement and estimation of water productivity of rice crop irrigated with saline water. *Paddy Water and Environment* 8, 333–346.
- Phogat, V., Mahadevan, M., Skewes, M., Cox, J.W., 2012. Modelling soil water and salt dynamics under pulsed and continuous surface drip irrigation of almond and implications of system design. *Irrigation Science* 30 (4), 315–333.
- Phogat, V., Skewes, M.A., Mahadevan, M., Cox, J.W., 2013. Evaluation of soil plant system response to pulsed drip irrigation of an almond tree under sustained stress conditions. *Agricultural Water Management* 118, 1–11.
- Ramos, T.B., Šimůnek, J., Goncalves, M.C., Martins, J.C., Prazeres, A., Castanheira, N.L., Pereira, L.S., 2011. Field evaluation of a multicomponent solute transport model in soils irrigated with saline waters. *Journal of Hydrology* 407, 129–144.
- Ramos, T.B., Šimůnek, J., Goncalves, M.C., Martins, J.C., Prazeres, A., Pereira, L.S., 2012. Two-dimensional modelling of water and nitrogen fate from sweet sorghum irrigated with fresh and blended saline waters. *Agricultural Water Management* 111, 87–104.
- Sansoulet, J., Cabidoche, Y.M., Cattani, P., Ruy, S., Šimůnek, J., 2008. Spatially distributed water fluxes in an arid soil under banana plants: experiments and three-dimensional modelling. *Vadose Zone Journal* 7, 819–829.
- Schaap, M.G., Leij, F.J., van Genuchten, M.Th., 2001. ROSETTA: a computer program for estimating soil hydraulic parameters with hierarchical pedotransfer functions. *Journal of Hydrology* 251, 163–176.
- Scholberg, J.M.S., Parsons, L.R., Wheaton, T.A., McNeal, B.L., Morgan, K.T., 2002. Soil temperature, nitrogen concentration, and residence time affect nitrogen uptake efficiency in citrus. *Journal of Environmental Quality* 31, 759–768.
- Šejna, M., Šimůnek, J., van Genuchten, M.Th., 2011. The HYDRUS software package for simulating two- and three-dimensional movement of water, heat, and multiple solutes in variably-saturated media. User Manual, Version 2. PC Progress, Prague, Czech Republic, pp. 280.
- Šimůnek, J., van Genuchten, M., Šejna, Th.M., 2008. Development and applications of the HYDRUS and STANMOD software packages and related codes. *Vadose Zone Journal* 7, 587–600.
- Šimůnek, J., Hopmans, J.W., 2009. Modeling compensated root water and nutrient uptake. *Ecological Modelling* 220, 505–521.
- Šimůnek, J., van Genuchten, M.Th., Šejna, M., 2011. The HYDRUS software package for simulating two- and three-dimensional movement of water, heat, and multiple solutes in variably-saturated media. Technical Manual, Version 2. PC Progress, Prague, Czech Republic, pp. 258.
- Skaggs, T.H., Trout, T.J., Rothfuss, Y., 2010. Drip irrigation water distribution pattern: Effects of emitter rate, pulsing and antecedent water. *Soil Science Society of America Journal* 74, 1886–1896.
- Sluggett, A.F., 2010. Solute dynamics in advanced fertigated horticulture. In: Thesis. School of Chemistry, Physics and Earth Science, Flinders University, SA, Australia.
- Subbaiah, R., 2011. A review of models for predicting soil water dynamics during trickle irrigation. *Irrigation Science*, <http://dx.doi.org/10.1007/s00271-011-0309-x> (published online).
- Syvertsen, J.P., Sax, S.M., 1999. Fertigation frequency, wetting patterns, and nitrate leaching from lysimeter grown citrus trees. *Proceedings of Florida State Horticultural Society* 112, 9–14.
- Syvertsen, J.P., Smith, M.L., Boman, B.J., 1993. Tree growth, mineral nutrition and nutrient leaching losses from soil of salinized citrus trees. *Journal of Agriculture, Ecosystem and Environment* 45, 319–334.
- Taylor, S.A., Ashcroft, G.M., 1972. *Physical Edaphology*. Freeman and Co, San Francisco, CA, USA, pp. 434–435.
- Tournebise, J., Gregoire, C., Coupe, R.H., Ackerer, P., 2012. Modelling nitrate transport under row intercropping system: Vines and grass cover. *Journal of Hydrology* 440–441, 14–25.
- Treeby, M., Falivene, S., Phogat, V., Skewes, M., 2012. Knowledge and tools to manage fertigation technologies in highly productive citrus orchards for minimal environmental footprint. Final Report to National Program for Sustainable Irrigation. NSW DPI, Dareton, Australia, pp. 41.
- Van der Laan, M., Stirzaker, R.J., Annandale, J.G., Bristow, K.L., du Preez, C.C., 2010. Monitoring and modelling draining and resident soil water nitrate concentrations to estimate leaching losses. *Agricultural Water Management* 97, 1779–1786.
- van Genuchten, M.Th., 1980. A closed form equation for predicting the hydraulic conductivity of unsaturated soils. *Soil Science Society of America Journal* 44, 892–898.
- Vrugt, J.A., Hopmans, J.W., Šimůnek, J., 2001. Calibration of a two dimensional root water uptake model. *Soil Science Society of America Journal* 65, 1027–1037.
- Wang, F.L., Alva, A.K., 1996. Leaching of nitrogen from slow release urea sources in sandy soils. *Soil Science Society of America Journal* 60, 1454–1458.
- Zhang, M., Alva, A.K., Li, Y.C., Calvert, D.V., 1996. Root distribution of grapefruit trees under dry granular dry broadcast vs. fertigation method. *Plant and Soil* 183, 79–84.