

ERNEST ORLANDO LAWRENCE BERKELEY NATIONAL LABORATORY

Vacuum Improvements for Ultra High Charge State Ion Acceleration

Z.Q. Xie, C.M. Lyneis, D.J. Clark,
A. Guy, and S.A. Lundgren

Nuclear Science Division

June 1998

Presented at the
*15th International
Conference on*

*Cyclotrons and
Their Applications*

Caen, France,

June 14-19, 1998,

and to be published in
the Proceedings

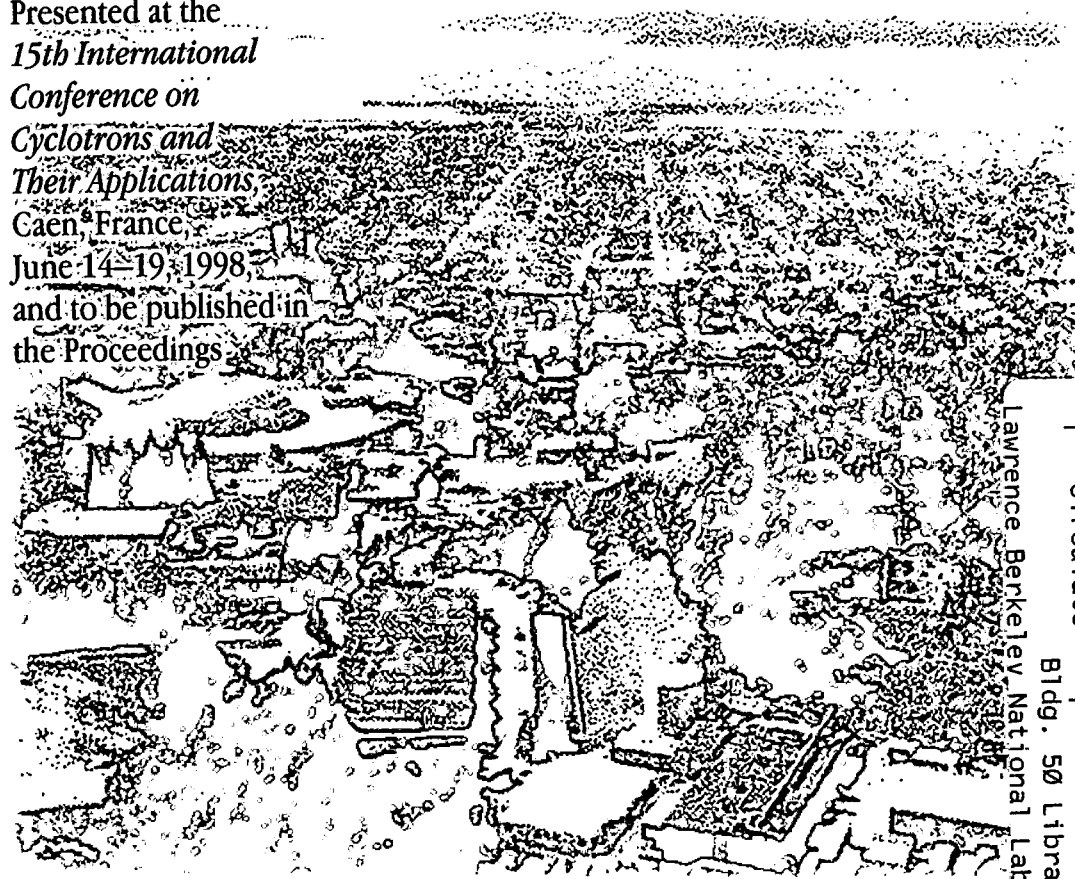

Lawrence Berkeley National Laboratory

REFERENCE COPY
Does Not
Circulate

Bldg. 50 Library - Ref.

Copy 1

LBLN-41991

DISCLAIMER

This document was prepared as an account of work sponsored by the United States Government. While this document is believed to contain correct information, neither the United States Government nor any agency thereof, nor the Regents of the University of California, nor any of their employees, makes any warranty, express or implied, or assumes any legal responsibility for the accuracy, completeness, or usefulness of any information, apparatus, product, or process disclosed, or represents that its use would not infringe privately owned rights. Reference herein to any specific commercial product, process, or service by its trade name, trademark, manufacturer, or otherwise, does not necessarily constitute or imply its endorsement, recommendation, or favoring by the United States Government or any agency thereof, or the Regents of the University of California. The views and opinions of authors expressed herein do not necessarily state or reflect those of the United States Government or any agency thereof or the Regents of the University of California.

**Vacuum Improvements for Ultra High
Charge State Ion Acceleration**

Z.Q. Xie, C.M. Lyneis, D.J. Clark, A. Guy, and S.A. Lundgren

Nuclear Science Division
Ernest Orlando Lawrence Berkeley National Laboratory
University of California
Berkeley, California 94720

June 1998

VACUUM IMPROVEMENTS FOR ULTRA HIGH CHARGE STATE ION ACCELERATION

Z.Q. XIE, C.M. LYNEIS, D.J. CLARK, A. GUY, S.A. LUNDRÉN
*Nuclear Science Division, Lawrence Berkeley National Laboratory
Berkeley, CA, 94720, USA*

The installation of a second cryo panel has significantly improved the vacuum in the 88-Inch Cyclotron at Lawrence Berkeley National Laboratory. The neutral pressure in the extraction region decreased from 1.2×10^{-6} down to about 7×10^{-7} Torr. The vacuum improvement reduces beam loss from charge changing collisions and enhances the cyclotron beam transmission, especially for the high charge state heavy ions. Tests with improved vacuum show the cyclotron transmission increased more than 50% (from 5.7% to 9.0%) for a Xe^{27+} at 603 MeV, more than doubled for a Bi^{41+} beam (from 1.9% to 4.6%) at 904 MeV and tripled for a U^{47+} beam (from 1.2% to 3.6%) at 1115 MeV. At about 5 MeV/nucleon 92 enA (2.2 pA) for Bi^{41+} and 14 enA (0.3 pA) for U^{47+} were extracted out of the 88-Inch Cyclotron. Ion beams with charge states as high as U^{64+} have been produced by the LBNL AECR-U ion source and accelerated through the cyclotron for the first time. The beam losses for a variety of ultra high charge state ions were measured as a function of cyclotron pressure and compared with the calculations from the existing models.

1 Introduction

Since it began operation more than three decades ago, the 88-Inch Cyclotron has evolved from a light ion cyclotron into a very versatile accelerator capable of accelerating ions from hydrogen to the heaviest natural element--uranium.[1,2] The cyclotron maintains its light ion capability, and its heavy-ion performance has continued to improve. The installation of electron cyclotron resonance (ECR) ion sources and the continued source development have greatly enhanced capability of the 88-Inch Cyclotron.[3] Prior to the operation of the LBNL ECR in late 1984, heavy ions were available up to mass 40 only, due to limitations in the performance of the PIG sources as indicated as PIG-84 in Fig. 1. Also shown in Fig. 1 are the present performance with the recently upgraded Advanced ECR (AECR-U) and the improved vacuum and the performance just prior to most recent improvements in source performance and vacuum. These curves are drawn for beams of at least 1 particle nA extracted current and the dashed line at 5 MeV/nucleon indicates the approximate cutoff in energies useful for many nuclear science experiments at this facility. As well as beams indicated by the curves, much higher intensity beams, up to a few particle micro amps, can be produced for masses below 90 and energies in the 4 to 10 MeV/nucleon range. Above about mass 100, the cyclotron vacuum plays an increasingly important role in the beam intensity, since higher charge states are required to produce these beam energies and the charge change mechanisms increase with charge state.

In these tests, the ultra high charge state heavy ion beams were directly injected from an ion source at low energy into the cyclotron and were accelerated to a few MeV/nucleon. The beam loss by electron capture is orders of magnitude higher than by electron stripping in the low energy region.[4] This differs from the production of high charge states by stripping as is done in coupled cyclotrons where the ultra high charge states are created at relatively high energies.[5] At higher energies the electron stripping process dominates the beam loss.[6,7] It also differs from other investigations on the cyclotron beam losses with low charge state ions where both electron capture and stripping play important roles in reducing transmission.[8,9]

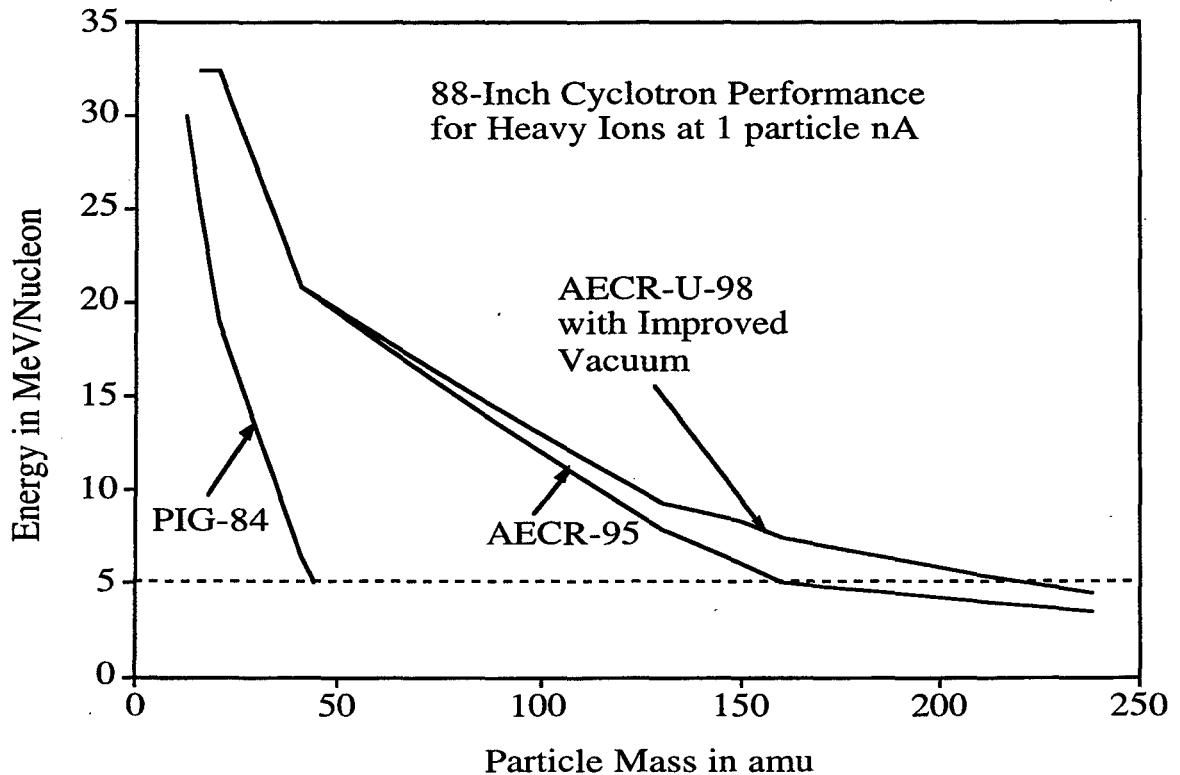

Fig. 1. This shows the energy-mass curves for the cyclotron at an intensity of 1 particle nA.

2 AECR-U Ion Source

Prior to its upgrade, the LBNL AECR had produced record beams of many high charge state heavy ions with techniques of two-frequency plasma heating and aluminum oxide coatings, even though its magnetic fields were lower than other ECR ion sources operating at 14 GHz.[10] This ion source was upgraded in 1996 (AECR-U) by increasing its magnetic field to improve the plasma confinement.[11] The goal of the AECR-U is to extend the mass range of heaviest ion beams and increase the intensities of lighter ion beams thereby providing new research opportunities at the cyclotron facility.

An elevation view of the AECR-U ion source is shown in Fig. 2. Its general design is similar to that of its predecessor but with some significant differences. Its axial length was shortened 20 cm by eliminating the space set aside in the earlier design for a microwave-driven first stage. The plasma chamber is made from aluminum to provide more secondary electrons from the walls. A new set of NdFeB permanent sextupole magnets with a remanence B_r of 1.3 Tesla was installed to raise the maximum radial field strength at the plasma chamber surface from 0.62 to 0.85 Tesla. The 5 cm thicker iron yokes in outer diameter help concentrate more magnetic field flux inside the plasma chamber. The overall source magnetic field strengths increased by about 50% with no increase in ac power. While the center field remains at about 0.4 Tesla, the maximum mirror ratios increase from 2.4 to 4.3 at the injection side and from 1.8 to 2.8 at the extraction aperture.

The plasma in the AECR-U source is still driven by two-frequency heating (14 and 10 GHz) and the microwaves are launched off axis with the rectangular wave guides terminated at the injection bias plate. After a few months of testing and careful optimization, the source reached its full potential with the production of many record charge states and beam intensities. The production of 1.1 μA of $^{238}\text{U}^{48+}$ with the AECR-U, for the first time from an ECR ion source, represents a milestone in ECR ion source development in which more than half of the electrons were removed from the heaviest natural element at the mentioned intensity. Table 1 shows a few

ion beams produced with the AECR-U ion source. As high a charge state as uranium 55+ ions at a few tens of enA were measured with the ion source beam analysis system. Higher charge states up to 64+ of uranium ions were also produced with the AECR-U at lower intensities as confirmed by the beam acceleration through the 88-Inch Cyclotron which will be discussed in this article.

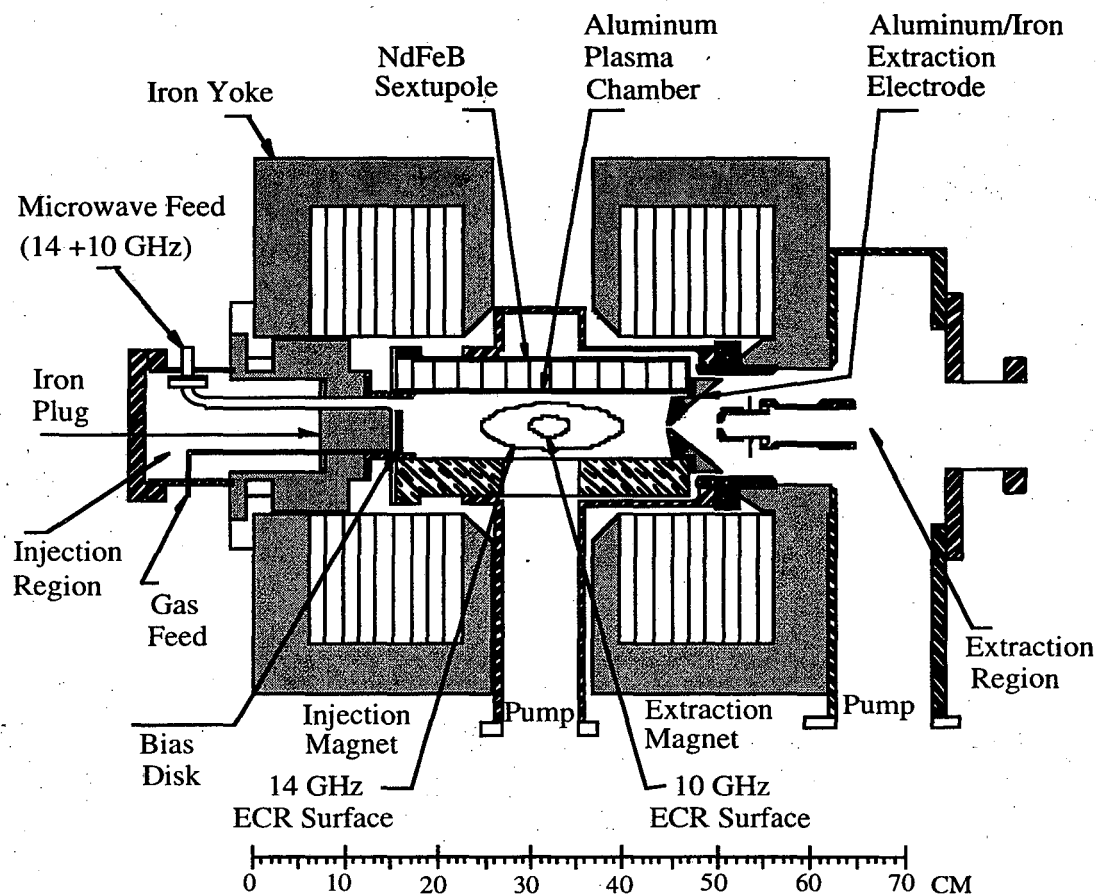

Fig. 2: An elevation view of the LBNL AECR-U ion source.

Table 1: A few of the ion beams produced with AECR-U
Currents are in units of e μ A.

ION	¹¹ Ba	¹⁶ O	⁴⁰ Ar	⁸⁶ Kr ^b	ION	¹³⁶ Xe ^b	¹⁹⁷ Au	²⁰⁹ Bi	²³⁸ U
4+	100				30+	10.2	35.5		
5+	45				31+	7	33.4	29.3	24.5
6+		845			36+	1	13.5	16	13.3
7+		315			41+		3.2	4.4	5
11+			270		46+		1	1.2	1.8
14+			77		47+		0.5	0.9	1.4
16+			21		48+			0.6	1.1
17+			1.35	116	50+			0.15	0.5
18+			0.06	100	55+				0.02
21+				50					
26+				18					
29+				0.4					

a: Mixture gases of B₂H₆ (15%) in helium were used. b: 99% enriched isotopes were used.

3 Cyclotron Vacuum System

The 88-Inch Cyclotron is nominally a K140 cyclotron and has been operating with beams of higher energy and intensity and greater variety since the application of the ECR ion sources. The RF frequency can be varied from 5.53 MHz to 16.2 MHz and both first and 3rd harmonic beams are routinely accelerated. Minimum and maximum energies in first harmonic are 6.1 and 55 MeV/nucleon and in third harmonic .7 to 6 MeV/nucleon. Beams have also been accelerated using 5th, 7th and 9th harmonic, although the transmission efficiency decreases rapidly with the high harmonic numbers due to poor RF capture in the center region. The vacuum in the cyclotron limits the acceleration efficiency, especially for the ultra high charge state heavy ion beams.

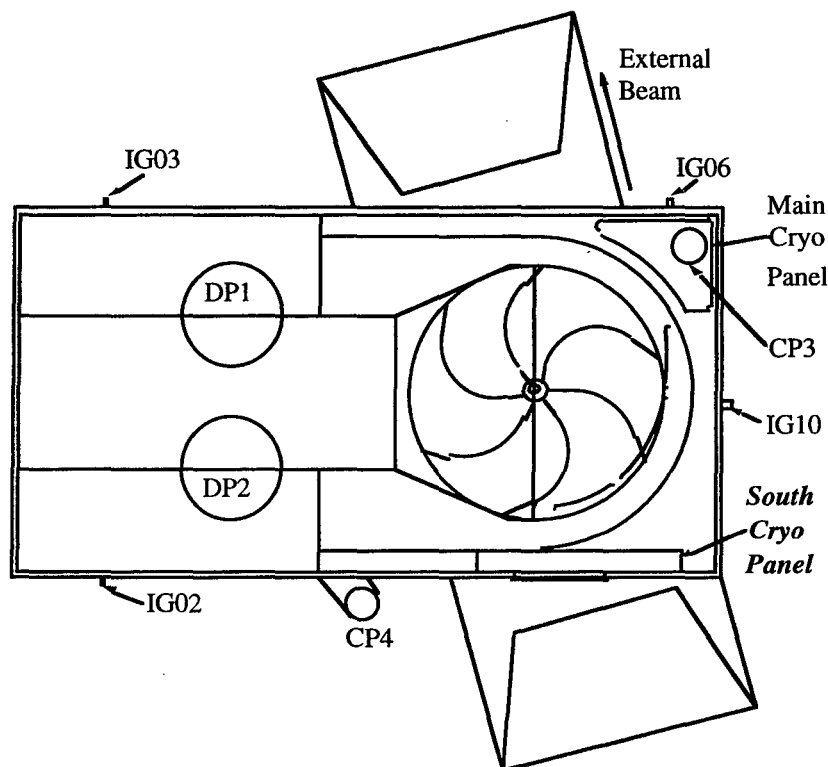

Fig. 3. A plan view of the 88-Inch Cyclotron with the current pumping layout showing the newly installed "South Cryo Panel" and ion gauge IG10 located in between the two cryo panels.

The volume of the vacuum chamber of the 88-Inch Cyclotron is about 25000 l. Until December 1997, the pumping system consisted of two LN₂-trapped diffusion pumps in the RF tank and two cryopumps and a cryo panel in the accelerator tank as schematically indicated in the plan view of the 88-Inch Cyclotron in Fig. 3. There are four ion gauges (labeled as IG02, IG03, IG06 and IG10) to measure the pressure in various peripheral locations. The pressure in the horizontal and axial beam lines from the ECR ion sources to the cyclotron is typically $\sim 2 \times 10^{-8}$ Torr. So unlike the case with the PIG source, there is no source gas flow into the cyclotron. The IG10 is believed to give a good pressure measurement from a radius of 5 inches to the extraction radius of 40 inches.[8,12] The total pumping speed on the accelerator tank was calculated to be 15000 - 20000 l/s while the nominal air leak rate was estimated to be about 0.02 Torr l/s. The pressure measured was typically of 1.2×10^{-6} Torr at the ion gauge IG10. A new cryo panel (indicated as South Cryo Panel in Fig. 3) to improve the cyclotron vacuum began operation recently. The pumping speed of this new cryo panel is calculated to be 14000 l/s. With this new cryo panel in operation, the pressure at ion gauge IG10 can decrease down to about 6.5×10^{-7} Torr under the best conditions.

4 Transmission Versus Pressure

The high charge state ions are produced in the AECR-U, selected by a 90 degree magnet and transported through the horizontal and axial beam lines to the mid plane of the cyclotron. An electrostatic gridded mirror is used to deflect the beam into the horizontal plane where the ions are captured by the RF and accelerated. For these tests the source voltage was at 10 kV, so the resulting energy of the ions in the injection line was about 0.002 MeV/nucleon.

Measurements of acceleration of the ultra high charge state heavy ion beams were done in the following way. The measured transmission (defined as the ratio of the extracted current to the current on the mirror inflector) was optimized for all measured beams with the South Cryo Panel off. The South Cryo Panel was turned on while the cyclotron settings were kept fixed. The transmission was then recorded as a function of the pressure at IG10. We have done this measurement for $^{136}\text{Xe}^{27+}$, $^{209}\text{Bi}^{41+}$ and $^{238}\text{U}^{47+}$ ion beams. All of these beams were accelerated to roughly 4.5 MeV/nucleon (3rd harmonic beams) and at about the same Dee voltages so the ions have essentially the same acceleration path. The beam transmission versus the pressure at IG10 is plotted in Fig. 4. It clearly shows that the beam vacuum loss for these ultra high charge state heavy ions was greatly reduced when the neutral pressure decreased by about one third from 1.1×10^{-6} Torr to about 7×10^{-7} Torr. The transmission increased about 58% for Xe^{27+} , more than a factor of two for Bi^{41+} and up to a factor of three for U^{47+} .

A final optimization of the cyclotron tuning was carried out after the cyclotron pressure reached its lowest value. At the lowest cyclotron pressure, higher charge state uranium ions up to 64+ at low intensities were accelerated through the cyclotron while only up to 60+ were detected before the vacuum improvement.[11] Since the AECR-U performance was unchanged, the acceleration of uranium 64+ ion beam is another clear demonstration of the increased transmission of the cyclotron with the improved vacuum. Listed in Table 2 are the extracted intensities of these ultra high charge state heavy ion beams.

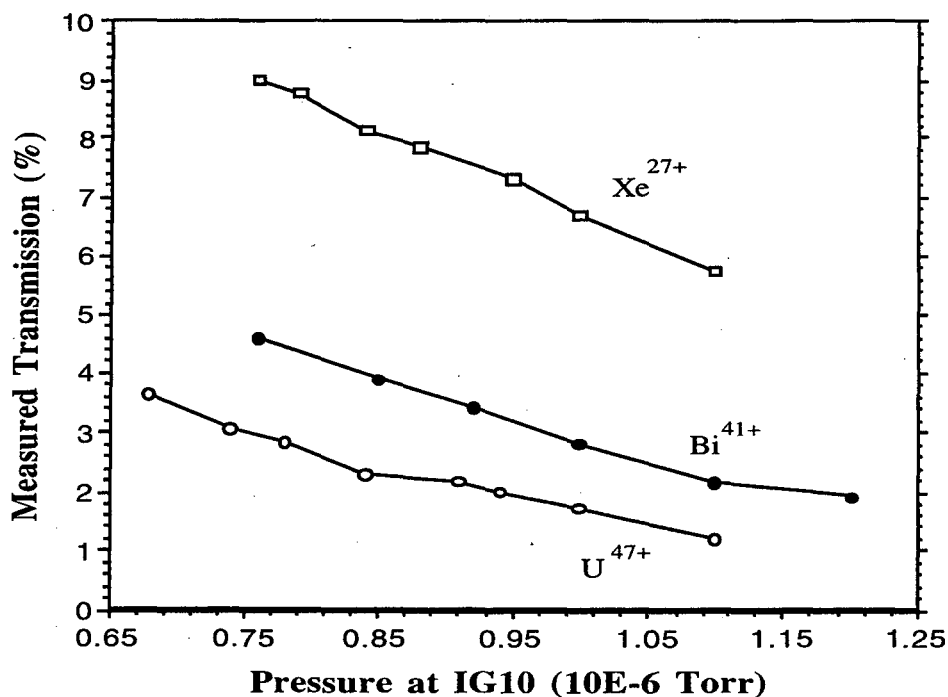

Fig. 4. Measured acceleration transmission versus pressure in the 88-Inch Cyclotron for Xe^{27+} , Bi^{41+} and U^{47+} ion beams.

Table 2: Ultra high charge state heavy ion beams accelerated by the 88-Inch Cyclotron.

ION	E/A (MeV/n)	E (MeV)	I _{ex} (enA)
²⁰⁹ Bi ⁴¹⁺	4.31	904	92
²³⁸ U ⁴⁷⁺	4.68	1115	14
²³⁸ U ⁴⁹⁺	5.09	1211	4
			(pps)
²³⁸ U ⁶⁰⁺	7.62	1814	507
²³⁸ U ⁶¹⁺	7.88	1875	427
²³⁸ U ⁶²⁺	8.13	1936	110
²³⁸ U ⁶³⁺	8.40	1999	24
²³⁸ U ⁶⁴⁺	8.67	2063	10

Note: A particle detector was used to identify the ultra high charge state ions.

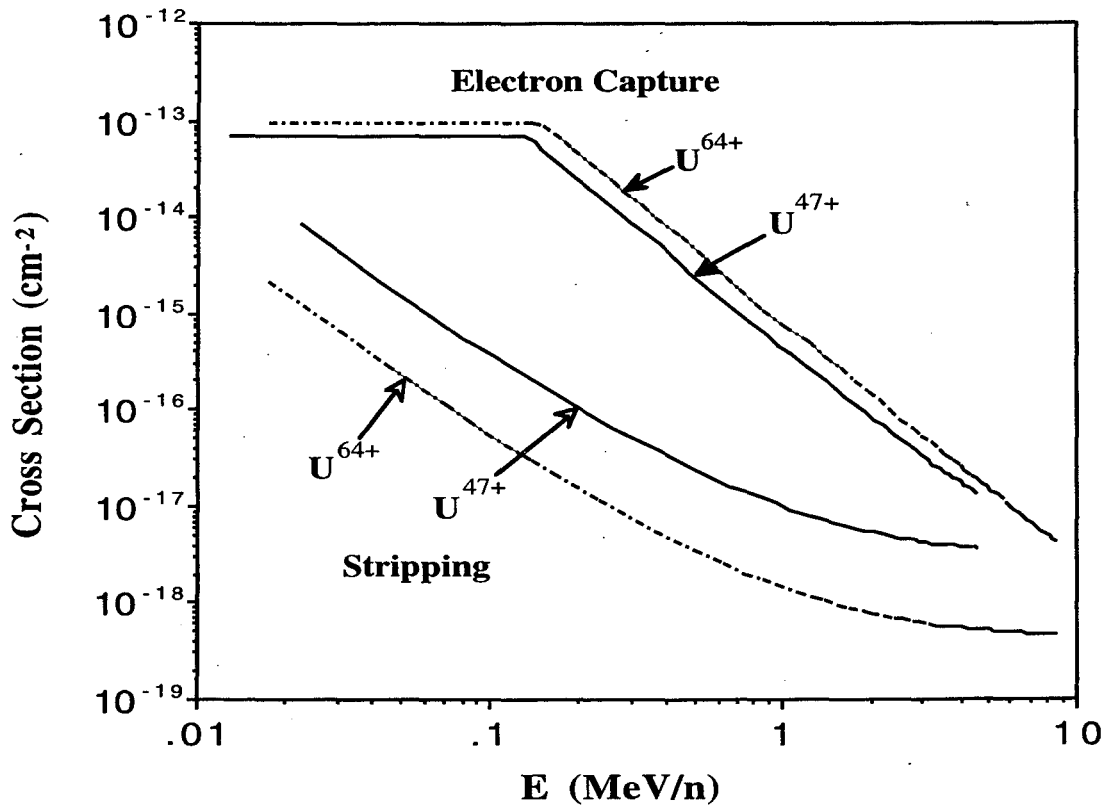

Fig. 5. Calculated electron capture and stripping cross sections for U⁴⁷⁺ and U⁶⁴⁺ ions versus beam energies.

Fig. 5 shows the electron capture and stripping cross sections for U⁴⁷⁺ and U⁶⁴⁺ calculated with the NSCL/MSU computer code.[9] With these high charge state ions injected at very low energy the electron capture dominates the losses. The largest cross sections are at low energy and much of the beam loss occurs in the first 10 turns before the beam reaches 0.2 MeV/u. In this region the beam losses are proportional to Q^{1.17} while at higher energies the overall cross section decreases with energy but scales as Q² to Q³. [6,7]

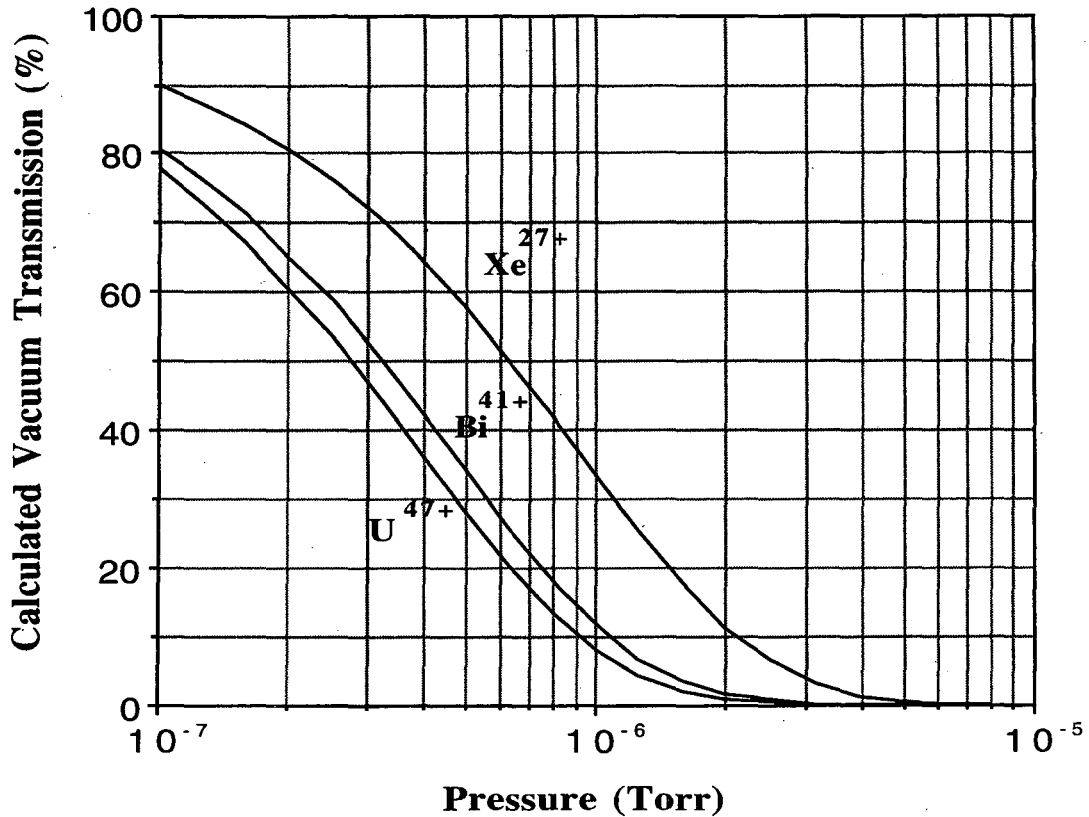

Fig. 6. Calculated beam vacuum transmission versus pressure for Xe²⁷⁺, Bi⁴¹⁺ and U⁴⁷⁺ ion beams accelerated by the 88-Inch Cyclotron. Improvement ratios are in good agreement with the measured data.

The transmission through the cyclotron can be written as a product of two factors. The first, the vacuum transmission factor, describes the beam loss from charge changing collisions. The second factor includes beam loss due to phase acceptance, emittance mismatch and extraction. In Fig. 6, the calculated vacuum transmission factors for Xe²⁷⁺, Bi⁴¹⁺ and U⁴⁷⁺ are shown as a function of pressure. The calculated transmission increases by factors of 1.47, 2.45 and 2.85 for beams of Xe²⁷⁺, Bi⁴¹⁺ and U⁴⁷⁺ when the pressure goes from 1.1 × 10⁻⁶ to about 7 × 10⁻⁷ Torr. Over the same pressure range, the measured transmission increased by factors of 1.58, 2.42 and 3.04 for Xe²⁷⁺, Bi⁴¹⁺ and U⁴⁷⁺ showing reasonable agreement between calculations and measurements. The calculations also show that most of the beam vacuum loss happens before the ions reach a radius of 25 cm of the 88-Inch Cyclotron. The curves of Fig. 6 show that if the vacuum of the 88-Inch Cyclotron can be further improved to 1 to 2 × 10⁻⁷ Torr, the transmission for the heaviest ion beams could be again tripled.

Acknowledgments. The authors wish to thank the 88-Inch Cyclotron operator group for their great support on acceleration of the ultra high charge state heavy ion beams. The authors are also grateful to Dr. P. Miller, NSCL/MSU, for his help in calculating the beam vacuum losses. This work was supported by the Director, Office of Energy Research, Division of Nuclear Physics of the Office of High Energy and Nuclear Physics of the U.S. Department of Energy under Contract DE ACO3-76SF00098.

References

- [1] E.L. Kelly, Nucl. Instr. & Meth. **18, 19**, 33 (1962).
- [2] C.M. Lyneis, Z.Q. Xie and D.J. Clark, Proc. of the 14th Conf. on Cyclotrons and Their Applications, Cape Town, South Africa, Oct. 8 -13, 1995, pp. 173-176.
- [3] C.M. Lyneis, Proc. of the Int'l Conf. on ECR Ion Sources and their applications, NSCL Report #MSUCP-47, East Lansing, Michigan, 1987, pp. 42-56.
- [4] A. Müller and E. Salzborn, Phy. Letters **62A**, 391 (1977).
- [5] E. Baron, M. Bajard and Ch. Ricaud, Nucl. Instrum. Meth. Phys. Res. A **238**, 177 (1993).
- [6] A.S. Schlachter, Proc. of the 10th Conf. on Cyclotrons and Their Applications, E. Lansing, Michigan, April 29 - May 3, 1984, pp. 563-570.
- [7] H.-D. Betz and Ch. Schmelzer, Charge Exchange Cross Sections of Fast Heavy Ions, UNILAC 1-67 (1967).
- [8] R.A. Gough and M.L. Mallory, IEEE Trans. Nucl. Sci. NS-26, no. 2, 2384 (1979).
- [9] P. Miller, D. Lawton and F. Marti, Proc. of the 14th Conf. on Cyclotrons and Their Applications, Cape Town, South Africa, Oct. 8 -13, 1995, pp. 269-272.
- [10] Z.Q. Xie and C.M. Lyneis, Rev. Sci. Instrum. **66**, 4281 (1995).
- [11] Z.Q. Xie and C.M. Lyneis, Proc. of the 13th Int'l Workshop on ECR Ion Sources, College Station, Texas, 1997, p. 16.
- [12] D. Elo, D. Morris, D.J. Clark and R.A. Gough, IEEE Trans. Nucl. Sci. NS-26, no. 2, 2179 (1979).

**ERNEST ORLANDO LAWRENCE BERKELEY NATIONAL LABORATORY
ONE CYCLOTRON ROAD | BERKELEY, CALIFORNIA 94720**