

**MARINE PLANKTON DIATOMS
OF THE WEST COAST OF
NORTH AMERICA**

BY

EASTER E. CUPP

**UNIVERSITY OF CALIFORNIA PRESS
BERKELEY AND LOS ANGELES
1943**

BULLETIN OF THE SCRIPPS INSTITUTION OF OCEANOGRAPHY
OF THE UNIVERSITY OF CALIFORNIA
LA JOLLA, CALIFORNIA

EDITORS: H. U. SVERDRUP, R. H. FLEMING, L. H. MILLER, C. E.
ZoBELL

Volume 5, No.1, pp. 1-238, plates 1-5, 168 text figures
Submitted by editors December 26, 1940
Issued March 13, 1943
Price, \$2.50

UNIVERSITY OF CALIFORNIA PRESS
BERKELEY, CALIFORNIA

CAMBRIDGE UNIVERSITY PRESS
LONDON, ENGLAND

[CONTRIBUTION FROM THE SCRIPPS INSTITUTION OF OCEANOGRAPHY, NEW SERIES, No. 190]

PRINTED IN THE UNITED STATES OF AMERICA

Taxonomy and taxonomic names change over time. The names and taxonomic scheme used in this work have not been updated from the original date of publication. The published literature on marine diatoms should be consulted to ensure the use of current and correct taxonomic names of diatoms.

CONTENTS

	PAGE
Introduction	1
General Discussion	2
Characteristics of Diatoms and Their Relationship to Other Classes of Algae	2
Structure of Diatoms	3
Frustule	3
Protoplast	13
Biology of Diatoms	16
Reproduction	16
Colony Formation and the Secretion of Mucus	20
Movement of Diatoms	20
Adaptations for Flotation	22
Occurrence and Distribution of Diatoms in the Ocean	22
Associations of Diatoms with Other Organisms	24
Physiology of Diatoms	26
Nutrition	26
Environmental Factors Limiting Phytoplankton Production and Populations	27
Importance of Diatoms as a Source of food in the Sea	29
Collection and Preparation of Diatoms for Examination	29
Preparation for Examination	30
Methods of Illustration	33
Classification	33
Key	34
Centricae	39
Pennatae	172
Literature Cited	209
Plates	223
Index to Genera and Species	235

MARINE PLANKTON DIATOMS OF THE WEST COAST OF NORTH AMERICA

BY
EASTER E. CUPP

INTRODUCTION

For more than twenty years, investigations have been conducted at the Scripps Institution of Oceanography on the distribution and abundance of marine plankton diatoms at several stations along the Pacific coast from Scotch Cap, Alaska, to La Jolla, California. Besides these regular series of collections, numerous short series have been taken on cruises of the research vessel of the Scripps Institution, Navy vessels, and private yachts, covering routes from Alaska to Callao, Peru, and in the Gulf of California. In the course of examining the thousands of samples collected, many perplexing problems of identification of species have arisen. In an effort to help solve some of these problems and to fill a need for a taxonomic paper on the plankton diatoms of our region, a need evident from the many requests received at the Scripps Institution, the present paper has been prepared.

Although the main emphasis has been placed on the pelagic diatoms found in waters off southern California, pelagic species present along the Pacific coast from Alaska to the Canal Zone and in the Gulf of California, as well as some littoral species frequently found in plankton collections, have been included. A small number of species listed on the Scripps Institution records but not verified by the author have been omitted, and without doubt some species have been overlooked. A serious attempt has been made to include a large number of drawings of many species to show variations that commonly occur in size and structure, since much of the confusion in quantitative enumeration arises because of the departure of species from their "typical" appearance as sketched in the usual papers and books on the diatoms.

Synonyms have been omitted for the most part because of the availability of several excellent recent publications (Boyer, 1926–1927; Hustedt, 1930–1937; Mills, 1933–1934). Only a brief general discussion of the group as a whole has been included for the same reason. The aim has been to produce a usable manual for the rapid and easy identification of species commonly found in plankton collections.

Statements concerning the distribution and abundance of species are based mainly upon the author's observations (Cupp, 1930, 1934, 1937; Cupp and Allen, 1938; and unpublished data) and those of Professor W. E. Allen of the Scripps Institution of Oceanography (1922, 1923, 1924, 1927*a*, 1927*b*, 1927*c*, 1928*a*, 1928*b*, 1928*c*, 1929*a*, 1929*b*, 1930, 1933, 1934*a*, 1936, 1937, 1938, 1939; Allen and Lewis, 1927; and unpublished records). Other helpful sources of information have been accounts published by Bigelow and Leslie (1930), Gran and Angst (1931), and Phifer (1933) for this coast and by Lebour (1930) and Hustedt (1930–1937) for general distribution and abundance.

GENERAL DISCUSSION

CHARACTERISTICS OF DIATOMS AND THEIR RELATIONSHIP TO OTHER CLASSES OF ALGAE

Diatoms are microscopic unicellular algae characterized by the large quantity of silica with which the cell wall is impregnated and by the fact that the skeleton consists of two parts which are not firmly united but fit into each other like the halves of a box. Each half of the cell wall consists of a valve and a connecting or girdle band between which one or more ringlike or scalelike intercalary bands may appear. The valves are marked in various ways by pores, poroids, knobs, areolae, and ribs. The protoplast enclosed within the valves of the cell wall contains a nucleus and from one to several platelike or many disk-shaped chromatophores usually of a yellowish or greenish-brown color. The product of assimilation is predominantly fatty oil. Most diatoms are autotrophic; a few are colorless and live as saprophytes. Many are capable of rather active locomotion.

Diatoms live in fresh, salt, and brackish water and in ice, moist soil, and other damp places. Some species are epiphytic and live attached to other plants, often to the smaller seaweeds in the ocean. A few attach themselves to animals. Most species live as single cells, free in the water; many become attached to the substrate by a gelatinous stalk; others form free or attached colonies of various shapes; and still others live in gelatinous tubes or in irregular gelatinous masses.

Reproduction is predominantly by simple cell division always in the same direction. Less often multiplication is by sexual or asexual auxospore formation. In a few species microspores have been observed. Resting spores or similar resting stages are present in many species.

Diatoms were at one time included among the brown algae or Phaeophyceae. Modern knowledge of their structure and life history shows them to be far removed from the brown seaweeds. West (1916) stated that "up to the present time little if any light has been thrown on the affinities of diatoms. Their characters are so distinctive, and the group as a whole exhibits such a uniformity of structure, that there is every justification for treating them as a distinct class, the affinities of which are very obscure." Holman and Robbins (1939) described them as probably related to the green algae, a statement common in textbooks of botany. Fritsch (1935) distinguished eleven classes of algae as follows:

Chlorophyceae	Chloromonadineae
Xanthophyceae	Euglenineae
Chrysophyceae	Phaeophyceae
Bacillariophyceae (diatoms)	Rhodophyceae
Cryptophyceae	Myxophyceae (Cyanophyceae)
Dinophyceae (Peridinieae)	

There is evidence indicating a closer relationship between some of Fritsch's classes. Grounds for regarding Xanthophyceae (Heterokontae), Chrysophyceae,

and Bacillariophyceae as having originated from a common ancestry have been given. It has been proposed to group them in the division Chrysophyta (Pascher, (1914), 1921, 1931). Pascher's opinion was based on a number of similarities—preponderance in all three classes of carotinoid yellow or brown pigments in the chromatophores, the associated absence of starch and occurrence of oil as one of the usual products of assimilation, and certain resemblances in the structure of the cell envelopes. Silica is deposited in the membrane of all three classes. These facts may well indicate a significant physiological relationship.

The diatoms form a highly specialized class, and although the points of similarity to the Xanthophyceae and the Chrysophyceae are significant the absence of any clear connecting forms makes it seem most logical to follow Fritsch at the present time and leave the Bacillariophyceae as a separate class of algae.

STRUCTURE OF DIATOMS

FRUSTULE

Mangin (1908) described the *cell walls* of diatoms as composed of pectin impregnated throughout with silica except for an outer often mucilaginous portion, found especially in plankton diatoms, consisting of pectin only and frequently visible by slight staining with anilin dyes. The silica can be extracted by the action of hydrofluoric acid, leaving the soft organic pectin membrane, or the pectin can be removed by calcination or maceration, leaving only the siliceous constituent.

Liebisch (1928, 1929) showed, however, that in many forms, perhaps in all, there is no interpenetration of the silica and pectin. The diverse parts of the diatom membrane, according to his interpretation, consist of an inner pectin layer and an outer layer probably of hydrated silica, similar to opal and without any admixture of organic material. The inner layer is closely applied to the outer and consequently shows the impressions of all the markings found on the siliceous shell. In the coarser forms the pectin layer is often thicker than the siliceous one, whereas in thin-walled plankton diatoms it may be very hard to recognize.

The individual diatom cell, the *frustule*, possesses a characteristic cell wall in that it always consists of four or more segments, the two largest of which, the *valves*, are exactly opposite each other (figs. A and B, *vs1*, *vs2*). The edges of the valves are always bent at right angles to the valve face to form a flange. When an appreciable part of the edge of the valve is bent over and is consequently seen from the girdle view, this part of the valve is known as the *valve mantle* (fig. A, 1, *vm1*, *vm2*; fig. B, 1 and 3, *vm1*, *vm2*). Closely united to the flange or valve mantle of each valve is a *connecting band* or *girdle band* (fig. A, 1, *cb1*, *cb2*; fig. B, 1 and 3, *cb1*, *cb2*). The wall of the diatom consequently consists of two halves, each half made up of a valve and a connecting band. The two connecting bands together form the *girdle* (fig. A, 1, *g*; fig. B, 1 and 3, *g*). The connecting bands are not closed hoops. Each band is a two-ended

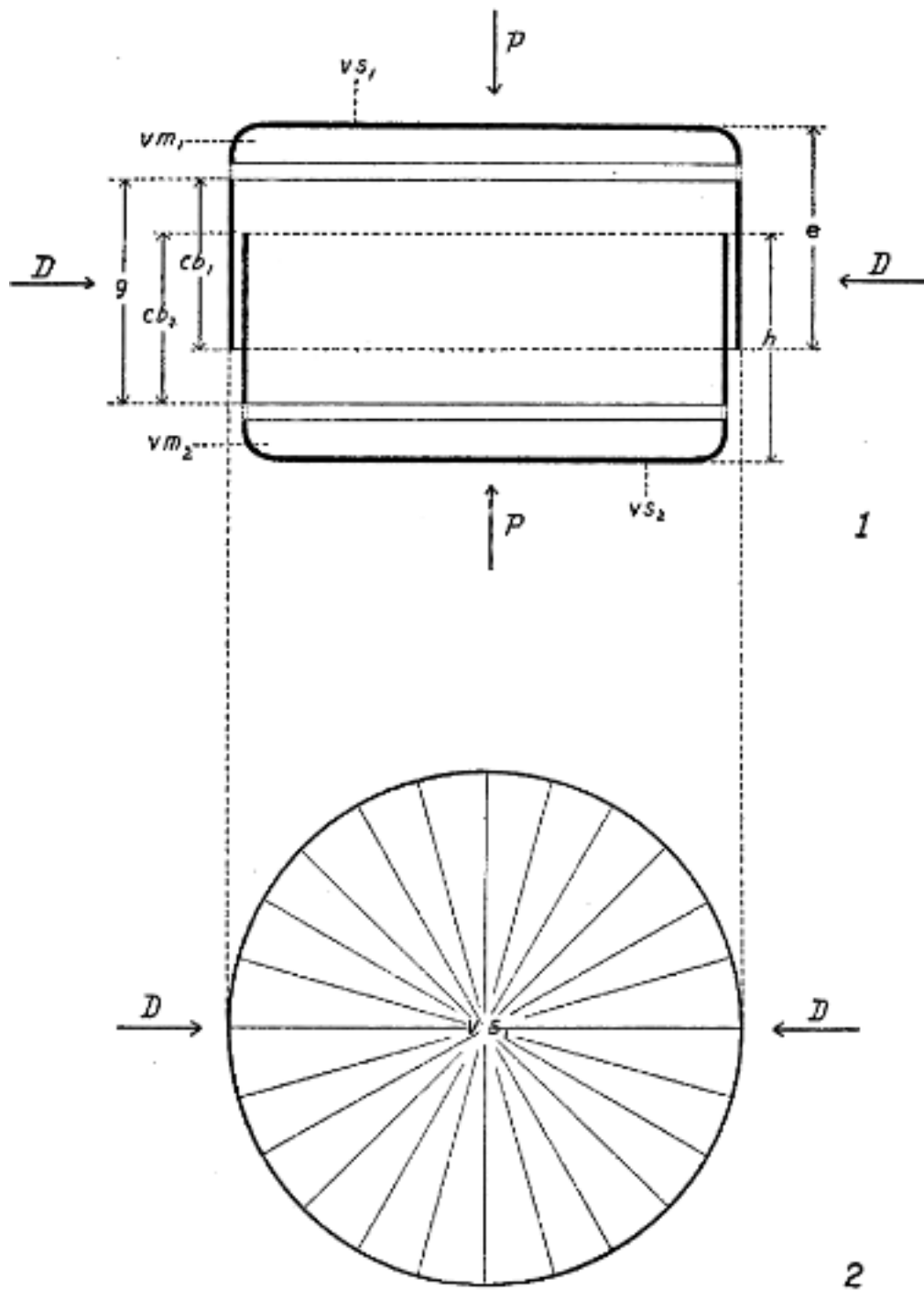

Fig. A. Diagrammatic representation of a diatom frustule of the Centricae type (*Coscinodiscus*): (1) girdle view; (2) valve view. Axes: P , pervalvar axis; D , diameter. Structure: e , epivalve; h , hypovalve; $cb1$, connecting band of epivalve; $cb2$, connecting band of hypovalve; g , girdle; $vs1$, valve surface of epivalve; $vs2$, valve surface of hypovalve; $vm1$, valve mantle of epivalve; $vm2$, valve mantle of hypovalve.

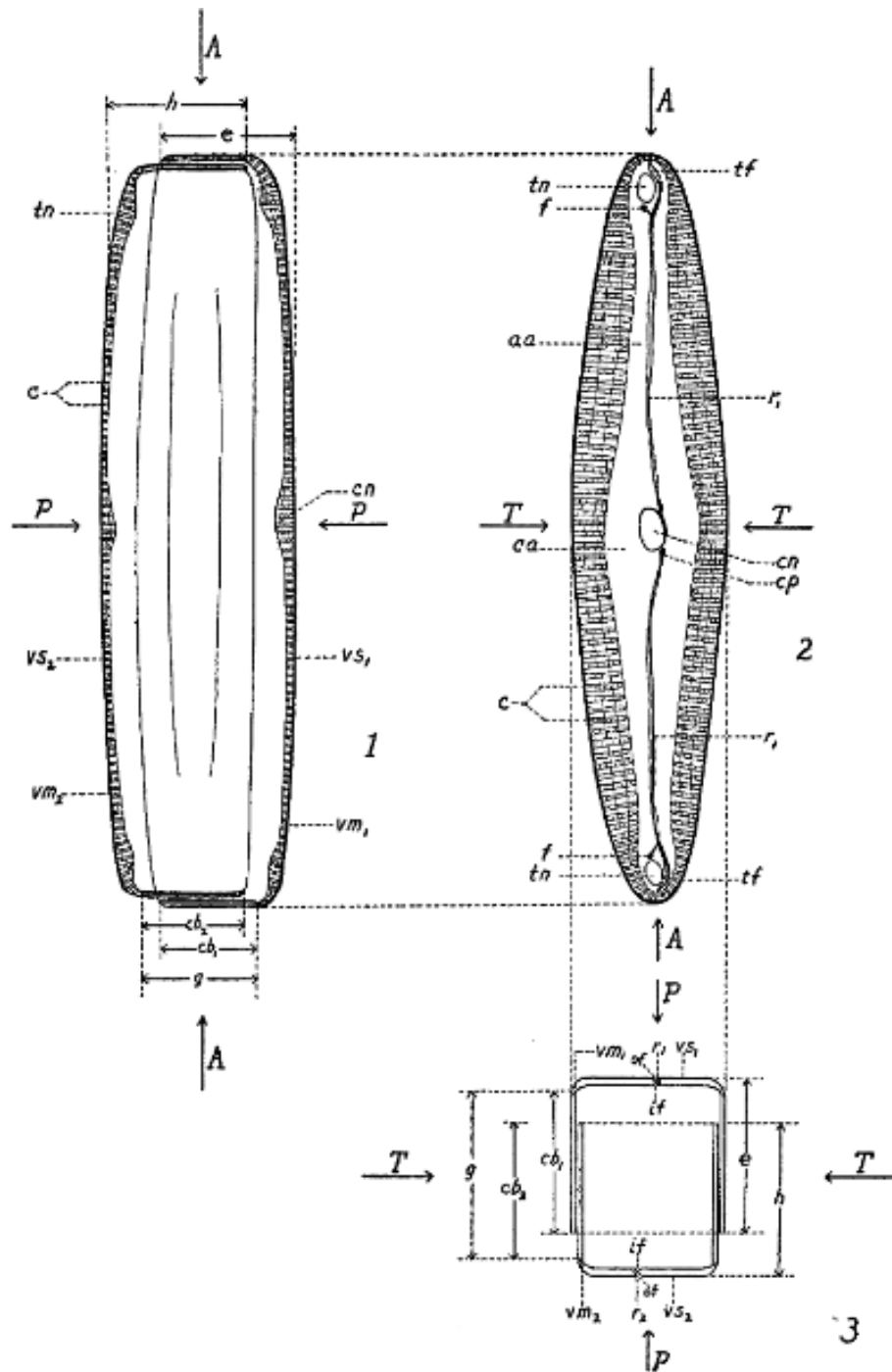

Fig. B (see opposite page). Diagrammatic representation of a diatom frustule of the Pennatae type (Naviculoideae): (1) broad girdle view; (2) valve view; (3) transverse section (narrow girdle view). Axes: A , apical axis; P , pervalvar axis; T , transapical axis. Structure: e , epivalve; h , hypovalve; $cb1$, connecting band of epivalve; $cb2$, connecting band of hypovalve; g , girdle; tn , terminal nodule; cn , central nodule; cp , central pore; $r1$, raphe of epivalve; $r2$, raphe of hypovalve; tf , terminal fissure or polar cleft; f , funnel-shaped body; aa , axial or longitudinal area; ca , central area; $vs1$, valve surface of epivalve; $vs2$, valve surface of hypovalve; $vm1$, valve mantle of epivalve; $vm2$, valve mantle of hypovalve; c , costae; of , outer fissure of raphe; if , inner fissure of raphe.

strip with overlapping ends. Because of the method of cell division, one valve of the cell is older than the other and is very slightly larger. The older valve is known as the *epivalve* or *epitheca* (fig. A, 1, *e*; fig. B, 1 and 3, *e*), the younger valve as the *hypoalve* or *hypotheca* (fig. A, 1, *h*; fig. B, 1 and 3, *h*). The connecting band of the older, larger valve fits over the connecting band of the younger, smaller valve like the lid of a box. The valves correspond to the top and the bottom of a box, the connecting bands to the sides. Between the valve and the connecting band one or more ringlike or scalelike intermediate bands, the *intercalary bands* (fig. C, 1–9, *ib*), may occur. These bands are really secondary connecting bands and are usually easily seen in girdle view. Like the connecting bands, the intercalary bands are in many forms only imperfectly closed hoops. The openings in adjacent bands are not in the same line and are always covered by some portion of a neighboring band.

The axis through the center point of the two valves is the *pervalvar* or *cell axis* (fig. A, 1, *P*; fig. B, 1 and 3, *P*; fig. C, 1 and 9, *P*; fig. D, 1, *P*; fig. E, 4, *P*). The longitudinal axis of the valve is called the *apical axis* (fig. B, 1 and 2, *A*); the transverse axis of the valve, the *transapical axis* (fig. B, 2 and 3, *T*). The *length* of the cell is the distance along the pervalvar or cell axis from valve to valve; the *breadth* or *width*, the diameter or the distance along the apical axis. Most diatoms consequently are considerably wider than they are long.

Three axial planes correspond to the axes. The plane of cell division, the *valvar plane*, is at right angles to the pervalvar axis; the *apical plane*, perpendicular to the transapical axis; and the *transapical plane*, perpendicular to the apical axis. These planes can be considered as planes of symmetry in most diatoms, but many forms have unequal poles due to twisting or bending of the cells and are consequently more or less asymmetrical.

The diatom cell is seen from one of two aspects, the *valve view*, in which the valve surface is visible (fig. A, 2; fig. B, 2), or the *girdle view*, in which the girdle is exposed (fig. A, 1; fig. B, 1). Except in circular diatoms, the girdle view can be further divided into the *broad girdle view* (fig. B, 1), in which the transapical axis of the cell is parallel to the axis of the microscope, and the *narrow girdle view* (fig. B, 3), in which the apical axis is turned toward the observer.

Diatoms are extremely variable in form. They may be symmetrical or asymmetrical. The various degrees of symmetry or asymmetry are brought about by unequal growth of either the valves or the girdle. Some are circular or oval, others linear or club-shaped, or more or less crescentic or arcuate; some are biangular, triangular, or polygonal, others are wedge-shaped in one or both aspects, or sigmoid, or undulate. The most common form in the entire group is naviculoid, resembling the horizontal section of a boat or canoe with the two ends alike; a very large number are circular or elliptical. Many species have *spines* (fig. C, 8, *s*; fig. D, 4, *s*), *horns* (fig. D, 4, *pr*), *keels* (fig. E, 4, *k1*, *k2*), *setae* (fig. H, 1, 2, 3, *s*, *ts*) (the long, delicate, often threadlike bristles arising from the corners of the valves in the genus *Chaetoceros*), or other specialized protuberances or structures. In some species the cells become very long because

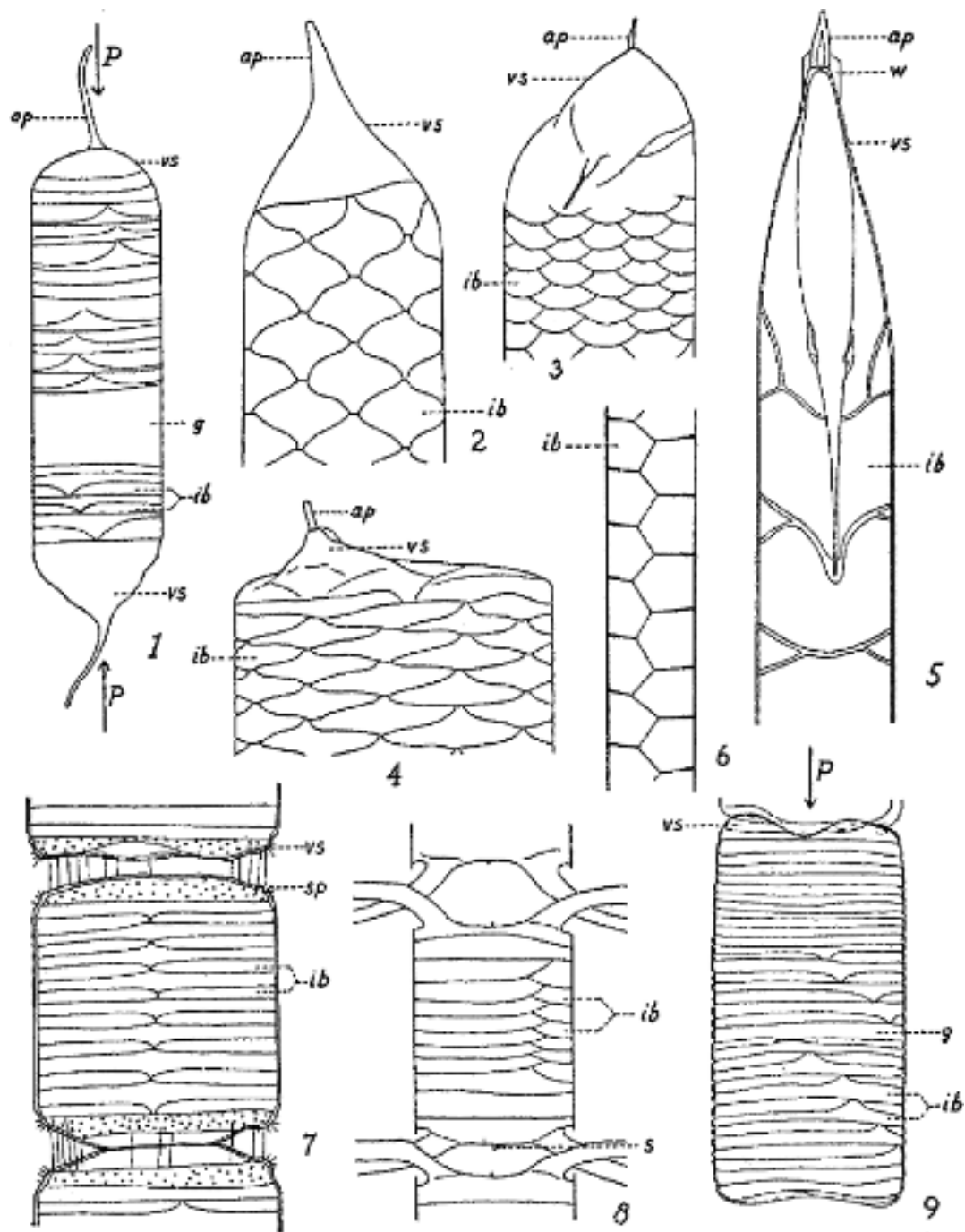

Fig. C. Types of intercalary bands: (1) *Rhizosolenia cylindrus* Cl.—numerous ring-shaped bands; (2) *R. arafurensis* Castr.—scale-shaped, rhombic to almost square bands with undulating margins; (3) *R. clevei* Osten.—numerous scale-shaped bands with smooth margins; (4) *R. castracanei* H. Pér.—numerous scalelike, moderately flat rhombic bands with slightly wavy borders; (5) *R. styliformis* var. *longispina* Hust.—scalelike bands; (6) *Dactyliosolen mediterraneus* H. Pér.—half-collar-shaped bands (the ends are in a nearly straight line); (7) *Lauderia annulata* Cl.—numerous collar-shaped bands; (8) *Chaetoceros eibenii* Grun.—ring-shaped bands (the same type is found in *C. costatus* Pav., as is shown in fig. 79); (9) *Guinardia flaccida* (Castr.) H. Pér.—small, numerous collar-shaped bands (the ends are spirally placed). All figures are in girdle view. *P*, pervalvar axis; *ap*, apical process; *vs*, valve (calyptra) surface; *g*, girdle; *ib*, intercalary bands; *w*, winglike expansion; *sp*, spinule; *s*, spine on valve surface.

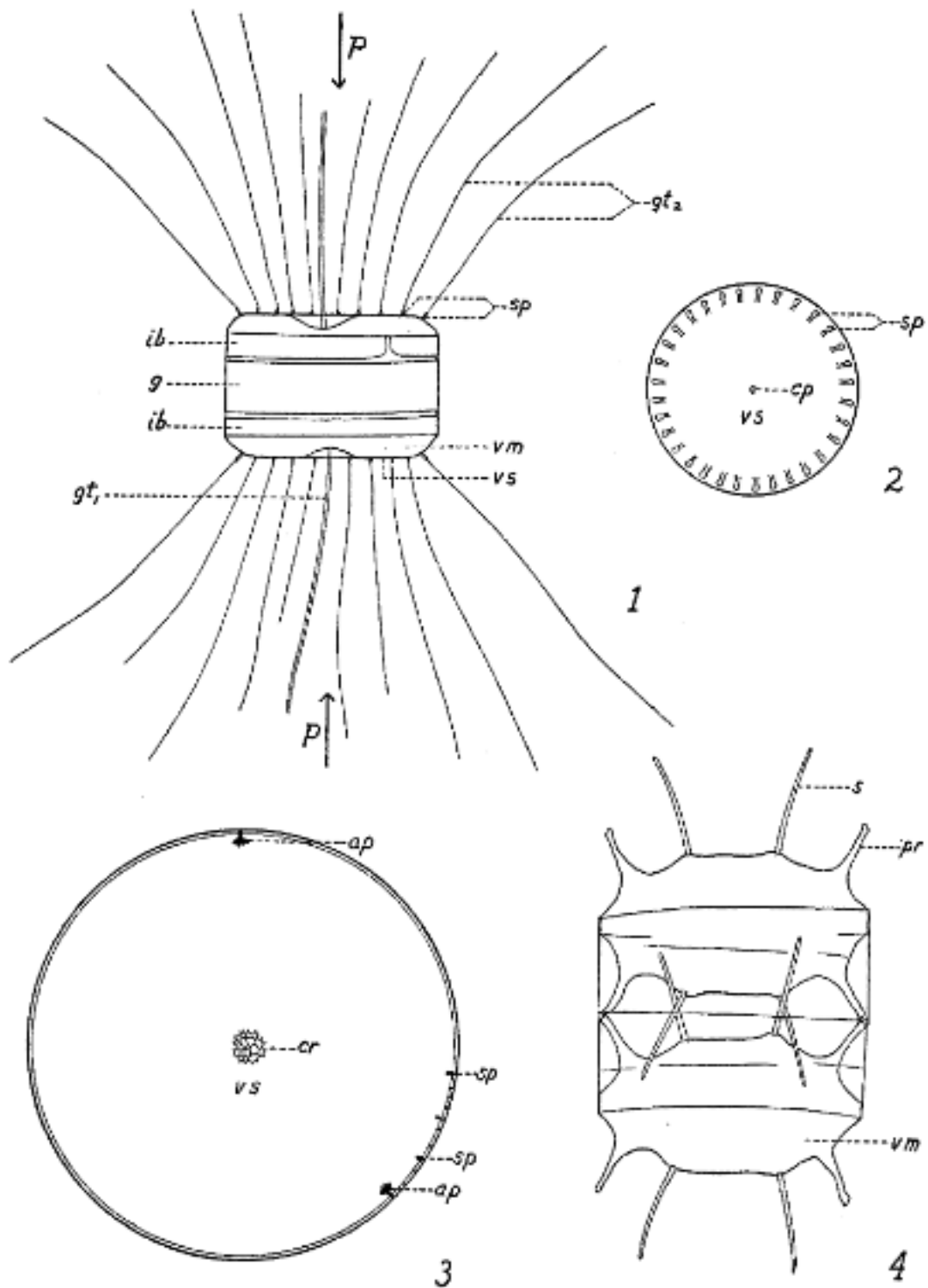

Fig. D. Diagrams of special structures: (1 and 2) *Thalassiosira aestivalis* Gran and Angst—(1) girdle view and (2) valve view; (3) *Coscinodiscus centralis* var. *pacifica* Gran and Angst—valve view; (4). *Biddulphia mobiliensis* Bail.—girdle view (recently divided cells). *P*, pervalvar axis; *gt1*, heavy gelatinous thread connecting cells into chains; *gt2*, delicate gelatinous threads extending from marginal spinulae (*sp*); *sp*, marginal spinulae; *ib*, intercalary band; *g*, girdle; *vm*, valve mantle; *vs*, valve surface; *cp*, central mucilage pore; *ap*, apiculus; *cr*, center rosette; *s*, spine; *pr*, process or horn.

of the large number of intercalary bands that are present. In the genus *Rhizosolenia*, for example, the great elongation of many of the species makes it virtually impossible ever to see the entire valve surface (fig. C, 1–5).

Longitudinal *septa* (fig. E, 1, *se*), ingrowths from the intercalary bands, are present in some diatoms. These are always more or less perforated and nearly parallel to the valve face. In *Climacosphenia moniligera* each septum has a series of numerous perforations (fig. E, 2, *se*). The number of septa depends upon the number of intercalary bands. The septa are usually plane but may be undulate, as in the genus *Grammatophora* (fig. E, 1, *se*).

Small internal thickenings or *nodules* of a rounded or conical shape and generally containing a cavity are found in the siliceous walls of the valves of many pennate diatoms, especially in the naviculooid species. They occur in the center as a *central nodule* (fig. B, 1 and 2, *cn*) and at each end of the valve as *terminal nodules* (fig. B, 1 and 2, *tn*). In many of the pennate diatoms the nodules are connected by a line or slit known as a *raphe* (fig. B, 2 and 3, *r1*, *r2*) through which the protoplasm comes in contact with the water. It is in those forms which possess a raphe that movement is possible.

Smooth areas frequently occur on valves otherwise striated. If the hyaline area is around the central nodule, it is known as the *central area* (fig. B, 2, *ca*); if along each side of the raphe, as the *axial* or *longitudinal area* (fig. B, 2, *aa*).

The raphe, although usually median in position, may be at the side or along the margin. It is typically a straight, undulating, or sigmoid line. In the Naviculoideae the cleft of the raphe is not in a vertical plane but is always bent, and is often V-shaped in cross section (fig. B, 3, *r1*, *r2*). In many species the cleft is closed in the middle region along the bend or point of the V. Consequently there are two cleftlike fissures, one on the inner side, the *inner fissure* (fig. B, 3, *if*), and one on the outer side, the *outer fissure* (fig. B, 3, *of*), of each valve. The central nodule is perforated by two canals each of which joins together the outer and inner fissures of one half of the valve. A canal runs along the inner side of the nodule joining both halves of the inner fissure. At each end of the valve the inner fissure ends in a funnel-shaped structure (fig. B, 2, *f*) which projects into the cavity of the terminal nodule. The outer fissure ends in a terminal or polar fissure (fig. B, 2, *tf*), a curved slit in the terminal nodule. Usually the terminal fissures of the same valve are curved in the same direction, although a few species are known in which they are curved in opposite directions. The corresponding fissures of the two valves of single individuals are always curved in opposite directions.

The raphe of other pennate diatoms differs from that found in the Naviculoideae. In *Surirella* the lateral margins of each valve are extended as winglike expansions, four to each cell. Near the free edge of each wing is a fine raphe-canal, with a longitudinal fissure extending the whole length and placing it in communication with the exterior. Cross canals connect it with the interior of the cell. In *Nitzschia* a raphe-canal with a longitudinal fissure similar to that of *Surirella* extends along the whole length of the keel (fig. E, 4, *k1*, *k2*) of each valve.

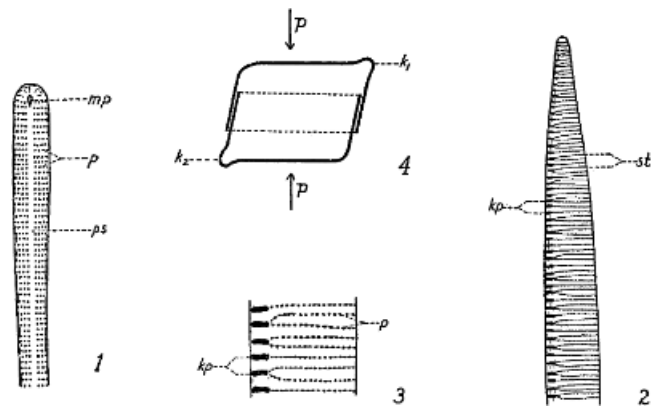

Fig. E. Diagrams of special structures: (1) *Thalassiothrix mediterranea* var. *pacifica* Cupp—valve view (*mp*, mucilage pore; *p*, puncta on striae; *ps*, pseudoraphe); (2–4) *Nitzschia pacifica* Cupp—(2) valve view and (3) valve view, with the section more highly magnified (*st*, striae; *kp*, keel puncta; *p*, puncta on striae); (4) diagrammatic transverse section (*P*, perivalvar axis; *k1*, keel of epivalve; *k2*, keel of hypovalve).

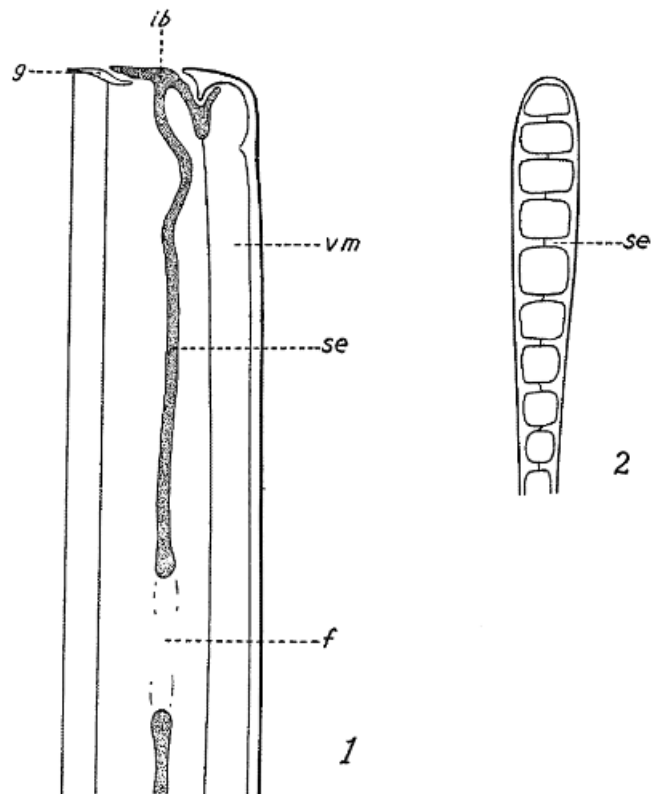

Fig. F. Diagrams showing the structure of septa in *Grammatophora* and *Climacosphenia*: (1) *Grammatophora oceanica* (Ehr.) Grun.—diagrammatic section in girdle view (*ib*, intercalary band; *g*, girdle; *vm*, valve mantle; *se*, septum; *f*, foramen); (2) *Climacosphenia moniligera* Ehr.—*se*, perforated septum.

In some diatoms a narrow, hyaline axial area without a central nodule, a *pseudoraphe* (fig. E, 1, *ps*), is present. This is not a true raphe because there is no cleft in the valve. It may be present on both valves of a cell or on only one. In *Achnanthes* one valve has a pseudoraphe, the other a true raphe; in *Fragilaria* both valves have a pseudoraphe.

The cell walls of diatoms are variously sculptured, in the great majority of forms more or less symmetrically. A few diatoms are known in which the valves are apparently smooth. The markings consist of small cavities within the cell wall, most often arranged in regular rows to give the appearance of

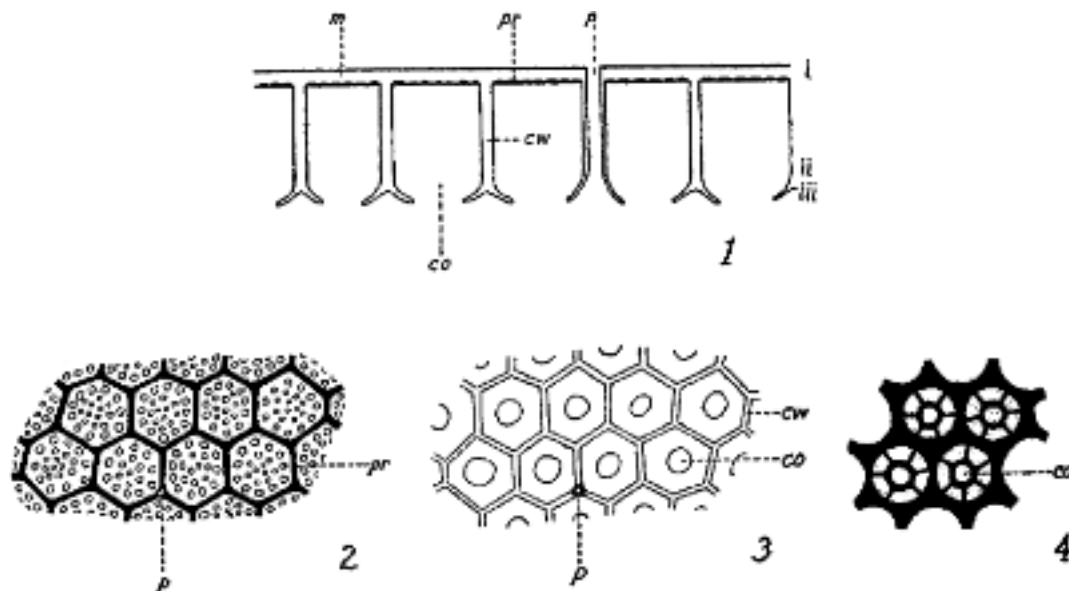

Fig. G. Structure of the cell wall of *Coscinodiscus centralis* var. *pacifica* Gran and Angst: (1) diagrammatic section through the wall; (2) section with the focus on the poroid outer closing membrane (on the region marked i in diagram 1); (3) section with the focus on the chamber openings of the areolae (on the region marked ii in diagram 1); (4) section with the focus slightly lower (on the region marked iii in diagram 1). *m*, outer closing membrane; *pr*, poroid; *p*, pore; *cw*, chamber wall of areola; *co*, chamber opening of areola in inner membrane layer.

striations or areolations. Usually both real pores and poroids are present. The *pores* (fig. D, 2, *cp*; fig. E, 1, *mp*; fig. G, 2 and 3, *p*) are actual perforations, from 0.1 to 0.6 μ in diameter (1 μ or micron = 0.001 millimeter), and are often found at the corners of the cell, over the whole surface of the valves, or near the margin. A large number may be grouped near the ends of the valves (the corners of the cell in broad girdle view), forming "pore plates" through which a gelatinous substance is secreted to form cushions or stalks to hold the cells to the substrate. The marginal pores often form *spinulae* (fig. C, 7, *sp*; fig. D, 1, 2, 3, *sp*), raised points frequently produced as small spines and penetrated by a pore channel. They may secrete a gelatinous material in the form of long, delicate, radiating threads (fig. D, 1, *gt2*) or as an amorphous mass visible only when stained. *Apiculi*, single, large, marginal nodules penetrated by a pore channel, are present in some genera near the margin of the valve. Often two

are placed on the margin of the valve asymmetrically about 120° apart (fig. D, 3, *ap*; fig. 22, *a, d*).

The *poroids* (fig. G, 1 and 2, *pr*) are thinner areas surrounded by thicker ones. They are larger than 0.6μ in diameter.

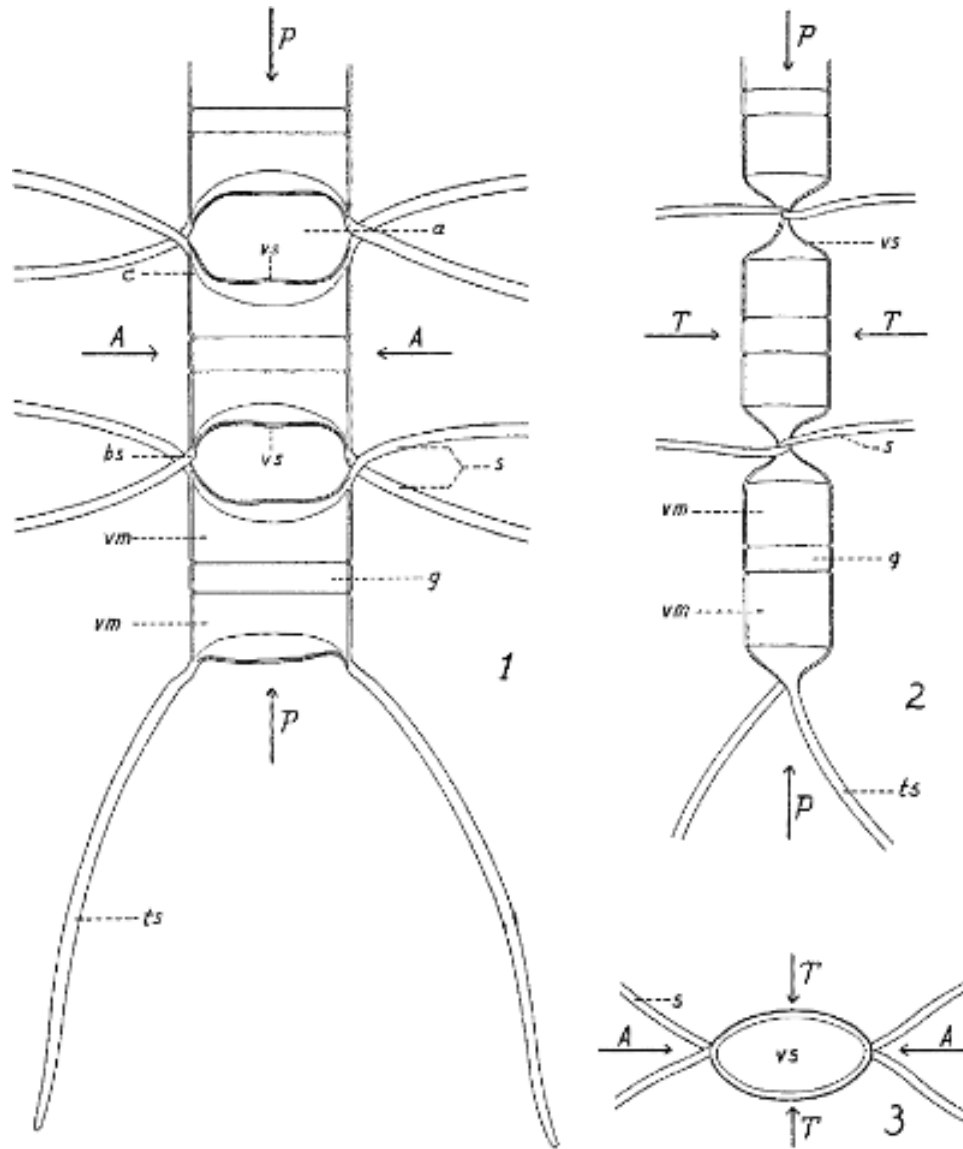

Fig. H. Diagrammatic representation of the genus *Chaetoceros*: (1) broad girdle view; (2) narrow girdle view; (3) valve view. *Axes*: *A*, apical axis; *T*, transapical axis; *P*, perivalvar axis (chain axis). *Structure*: *vs*, valve surface; *vm*, valve mantle; *g*, girdle; *c*, corner of valve; *s*, seta (setae, plural); *ts*, terminal seta; *bs*, base of seta; *a*, aperture or foramen.

The *striae* (Fig. E, 2, *st*) are prolonged furrows closed on the outside and open on the inside. They vary in strength from conspicuous ribs or *costae* (fig. B, 1 and 2, *c*) to lines so fine as readily to escape detection. Most striae are actually linear series of small dots, *puncta* (fig. E, 1, and 3, *p*), due to

cavities situated within more or less pronounced ridges of the walls which project either toward the outside or the inside. The costae are not always composed of series of puncta.

Areolae are polygonal or rounded areas or cavities closed by a thin siliceous membrane and framed by partitions (fig. G, 1–4). They are open either toward the exterior or toward the interior. In the great majority of species the closing membrane (fig. G, 1, *m*) is at the outside of the areolae, whereas the inside is open or only partly closed (fig. G, 1, 3, 4, *co*). In a few genera with very thick walls, the areolae may be open at the outside (*Triceratium*). The closing membrane may be traversed by fine pores or minute poroids (fig. G, 1, 2, 3, *p*, *pr*). Gran and Angst (1931) classed both striae and areolae as poroids. Thorough discussions of cell-wall structure may be found in Hustedt (1930) and in Fritsch (1935).

In the Centricae or centric diatoms, chiefly marine species, the markings on the valve faces are generally radially arranged (fig. A, 2). In the Pennatae or pennate diatoms the sculpturing is arranged in connection with a longitudinal line (fig. B, 2).

PROTOPLAST

The inner wall of the diatom cell is lined with a thin layer of colorless *cytoplasm* which goes into the various extensions of the cell cavity and into the chambers, pores, and canals in the cell wall. In the majority of diatoms the principal mass of the cytoplasm lies in the middle of the cell forming a cytoplasmic bridge between the opposite walls. The nucleus lies embedded in this bridge. Many variations of this arrangement are found, however, depending upon the symmetry of the cells. The general form and position of the bridge is fairly constant within a given species. In many species it is displaced to one side determined by the form of the cell; in others, instead of a cytoplasmic bridge, we find only a cone-shaped projection running from one wall toward the center. In many centric diatoms a central mass lies in the middle of the cell suspended by cytoplasmic threads, whereas in others a lens-shaped cytoplasmic mass lies along one valve. The central part of the cell is occupied by one large *vacuole*, which may be divided into two approximately similar vacuoles by the central cytoplasmic bridge or into several smaller vacuoles by more or less numerous cytoplasmic threads or bands if the central bridge is lacking. Protoplasmic streaming is conspicuous only in the genus *Rhizosolenia*.

The *chromatophores* of diatoms vary greatly in shape and position, but are characteristic for each species. In some species only one is present, in others many. They may be small and discoidal or large and platelike, or they may be large anastomosing structures occupying a large proportion of the cytoplasm. Many are irregular in shape, bandlike, or decidedly lobed. In some species they appear to be perforated plates. They usually extend into the chambers of cells that have incomplete partitions.

The naviculoid diatoms usually have platelike chromatophores. These have a very similar form and disposition in closely related species. Most of the Centricae have rounded or lobed disklike chromatophores, usually numerous

in each cell. Exceptions occur frequently. Variations often appear within a given genus. For example, in *Chaetoceros* some species with one or several plates are known, whereas many have numerous disklike or granulelike chromatophores. Both types occur in the genus *Synedra*.

Chromatophores usually lie along the girdle-band side or along the valve and often overlap from one side to the other, but seldom lie in the center of the cell. In the Centricae that live as single cells, the disks or granules usually lie along the valve, whereas in the colony-building species of this group the chromatophores usually lie on the girdle-band side. In a number of species of *Chaetoceros* the chromatophores are also present in the setae.

Early systems of classification were based upon the disposition and mode of division of the chromatophores. Such systems are not practicable because of the difficulty of studying the normal shape and distribution of chromatophores except in very fresh, living or very carefully handled and prepared material and because of the necessity of including fossil forms in our classification. Nevertheless, both the form of chromatophores and their disposition in the cell are of importance in classification. Mereschkowsky (1901) added a great deal to our knowledge of their structure.

The chromatophores appear to be yellow, golden brown, greenish brown, or in some forms true green. Some confusion still exists concerning the true nature of the *pigments* present in diatoms. Early investigators regarded the color of diatoms as due to a single pigment, which Nägeli (1849) called "diatomin." Askenasy (1867) used the name for the brownish-yellow pigment which could be extracted with alcohol. He described it as having a strong absorption of the blue half of the spectrum and showing a characteristic intense blue-green color on addition of H₂SO₄ or HCl to the alcoholic solution. Nebelung (1878) extracted a yellow pigment from *Melosira* species with petroleum ether. He called the pigment phycoxanthin, but the principal pigment extracted may have been carotin.

Tammes (1900), Zopf (1900), Kohl (1902), and Molisch (1905) gave further proof of the carotinoid nature of diatom pigments. Kohl (1902) concluded that the pigment known as "diatomin" is actually carotin. Molisch (1905) observed that the species which he studied gave the so-called leucocyan reaction, which is apparently specific for fucoxanthin. Askenasy (1867) had observed the same reaction for alcoholic extracts of diatoms.

Kohl (1906), studying the pigments spectroscopically, concluded that the following three pigments are present: (1) *chlorophyll*, with an absorption spectrum the same as that of chlorophyll from the higher plants; (2) *carotin*, the principal carotinoid present in the diatoms; and (3) probably *β-xanthophyll*. Palmer (1922) summarized his review of work on diatom pigments by saying that "carotin appears to be the principal carotinoid present in the diatoms. There is a possibility, also, that xanthophylls and fucoxanthin are present." He substantiated Kohl's observations.

Gillam, El Ridi, and Wimpenny (1939) found, upon examination of a large phytoplankton sample containing *Rhizosolenia styliformis* and *Biddulphia*

sinensis only, that carotin and xanthophyll were present in the ratio of 1: 1.82. This is comparable with the ratio typical of land plants. The total carotinoids equaled 0.1 per cent calculated on dry weight.

In many species of diatoms the chromatophores contain lens-shaped or nearly spherical, bright, glistening bodies, known as *pyrenoids*, which are variable in number and disposition. Only one may be present in a chromatophore, or several. Some lie near the center of the chromatophore, others near the margin. Frequently they are grouped in clusters. They may even partially or entirely emerge from the chromatophores and appear as free colorless bodies. Pyrenoids are not commonly found in the Centricae, and are variable in their occurrence, even among species of the same genus, in the Pennatae. Their exact function is not known, but they seem to act as special reservefood bodies.

Drops of *fatty* oil occur in most, or probably in all, diatoms. These vary in size but are usually more conspicuous than the pyrenoids. This oil is soluble in ether and is blackened by osmic acid. It has been shown to be a food reserve. Fatty oil is the principal product of assimilation in the diatoms.

Other cytoplasmic inclusions, *Butschli's red corpuscles or granules*, often called "oil drops," are sometimes present. They are larger than the fatty oil drops, are not soluble in alcohol or ether, and are not blackened by osmic acid. Stained with Delafield's hematoxylin, methylene blue, or gentian violet, they become intense red or red-violet, but even when not stained the granules can be distinguished from the fatty oil drops by their characteristic dull luster and faintly bluish color. In many diatoms the corpuscles are scattered throughout the entire cell, in others they seem to have a definite location. Meyer (1904) interpreted them as *volutin granules* and concluded that they consist of nucleic acid combined with an organic base. The real function of the granules is not known, but it is possible that they serve as nitrogenous reserve material. During nuclear division they gradually disappear, but soon after completion of division appear again in their original place. They are identical with metachromatic granules.

A number of small, rod-shaped structures disposed in pairs, "*double-rods*," are present in the somewhat denser cytoplasm surrounding the nucleus. They have also been described as plates. It is possible that they may be reserve-food material, since they disappear during nuclear division; they also may be used in building the spindle.

The *nucleus* varies in shape depending somewhat upon the form of the cell. In the Pennatae it is narrowly ellipsoidal or lens-shaped, nearly reniform (kidney-shaped), or sometimes almost fusiform (spindle-shaped, tapering at each end), whereas in the Centricae it may be nearly spherical. In the Pennatae it always lies in the central cytoplasmic bridge; in the Centricae, either in the central plasma mass or embedded in the cytoplasmic mass lying near the cell wall. Even without staining, the nucleus in most diatoms is distinct. A very weak solution of methylene blue will make it more prominent in the living diatom, staining it clearly before the rest of the protoplast is colored.

Usually one or more *nucleoli* are present. When the nucleus is stained and a sufficient magnification is used, a framework of fine threads of *linin* can be seen. Chromatin in the form of more or less small granules is embedded in the nodes of the linin network. A *nuclear membrane* surrounds the nucleus.

The presence of a *centrosome*, a small granule in the neighborhood of the nucleus, has been demonstrated in some of the larger species of *Surirella*, *Navicula*, and a few other genera. In *Surirella* and certain others the centrosome lies in a slight hollow at one side of the kidney-shaped nucleus. Two centrosomes have been reported in a few species. Some authors have described the presence of a macronucleus and a micronucleus in certain diatoms. These are probably equivalent to the nucleus and the centrosome.

BIOLOGY OF DIATOMS

REPRODUCTION

Cell division.—The most common method of reproduction in the diatoms is asexual by cell division, the two halves of the cell separating. Preliminary to this separation a new valve to each half is formed. Division is always transverse to the longitudinal axis of the individual, that is, in the valvar plane. A slight increase in the volume of the cell is the first appreciable change indicating approaching division. Nuclear division, probably always mitotic, takes place as the first step in the actual division of the cell. There are some differences of opinion concerning certain details of mitosis (Lauterborn, 1896; Fritsch, 1935). After the nucleus has divided, two new valves are formed within the old cell wall separating the protoplast into two daughter cells. Each daughter cell consists of the protoplast and one new valve encased by a valve of the mother cell. At first the new valves lie free within the mother cell and increase in diameter by growth at the edges. Intercalary bands, if present, and then girdles are formed. Division is complete when the halves of the mother cell slip out of each other. Often the girdle of the mother cell projects as a flange for some distance on the side of the new valve. The diameter of the valve of one daughter cell is necessarily smaller by the double thickness of the cell wall than that of the mother cell. Some authorities claim that there is a certain degree of compensation for this diminution after division by growth of the cells. Some regulation of volume occurs by greater elongation of the girdle zone.

Auxospores.—The formation of auxospores is a process in which the protoplast escapes from its rigid envelope making possible a return of the cells to maximum size. It is both a striking method of increasing the cell volume and a type of rejuvenation. In the Pennatae, auxospore formation takes place only when the individuals have reached a certain reduced size. Below a certain minimum, it likewise fails to occur. Among the Centricae also, formation of auxospores takes place only in individuals of a certain size range. Gross (1940a) found auxospore formation in cultures of *Ditylum brightwellii* taking place only in cells with a diameter of less than 45μ . Decrease in size is not the

only factor influencing auxospore formation, especially among the Pennatae in which a sexual fusion is involved. The factors are no doubt partly environmental. In the sea the period from one auxospore generation to another may last for one year or, in some species, even from two to five years (Fritsch, 1935).

So far, no sexual process has been observed in connection with auxospore formation in the Centricae. It is essentially a relatively simple process for rejuvenation of the protoplast. The two halves of the wall are forced apart by the protoplast, which becomes surrounded by a thin, slightly silicified pectic membrane, the *perizonium*, within which the protoplast rapidly becomes enlarged. Sooner or later valves and connecting bands are secreted within the perizonium and a new individual, larger than the parent, is produced. The new cell may have a diameter from two to three times as great as that of the mother cell. The perizonium may be the stretched pectic layer of the membrane of the parent cell. The pervalvar axis of the rejuvenated cell may be a continuation of that of the mother cell, as in *Thalassiosira rotula* (fig. 12, *e-g*) and *Rhizosolenia alata* (fig. 52-A, *h-l*), or be perpendicular to it, as in *Rhizosolenia bergonii* (fig. 43, *e-g*) and *Chaetoceros compressus* (fig. 74, *f-h*).

In many littoral species auxospore formation is associated with a sexual process. In the Pennatae several different methods of development of the auxospore have been observed. In some groups two auxospores are formed in one mother cell in an asexual or imperfectly sexual method. This occurs in many species of *Synedra*. In most of the *Navicula* and *Nitzschia* species, formation is sexual by the conjugation of two parent cells. Each mother cell divides into two daughter cells, the four then conjugate in pairs, and two auxospores are formed from the two zygotes. This is the most common type in the Pennatae. In *Surirella* and certain other genera two parent cells blend together to form one auxospore. In *Nitzschia paradoxa* and *N. palea*, one auxospore is formed from a single mother cell. This is also perhaps the only type of auxospore formation in the Centricae, as described above. Other variations of these methods have been reported. (See Taylor, 1929, Hustedt, 1930, and Fritsch, 1935, for general discussions; and Gross, 1940*a*, for recent experimental investigations.)

Microspores.—Investigators have observed the occurrence of more or less numerous, successive, nuclear divisions without cell division in a number of the centric pelagic marine and fresh-water diatoms. The resulting products, *microspores*, have the character of small cells within the mother cell, ordinarily contain chromatophores, and are usually supplied with two flagella. As a rule the number of microspores within each cell is a power of two, the final number varying with the size of the cell. In *Bacteriastrum delicatulum*, Gran and Angst (1931) recorded the presence of only from four to eight microspores arranged in a single row. Thirty-two have been reported in *Biddulphia mobiliensis*.

Microspores have been considered to be gametes which come together to

form a zygote. In other words, the formation of microspores has been interpreted as indicating the presence of a sexual method of reproduction in the Centricae. However, the observations and interpretations presented for the various species have been many. Fritsch (1935), after a rather long discussion of the numerous observations, stated: “

The diverse data above taken under review afford little evidence that the microspores are of the nature of gametes, since fusion has so far only been inferred and not actually established. Moreover, it is probable that in various cases a confusion with parasitic organisms has occurred. This statement must not, however, be taken as a denial of the existence of microspores which are clearly established as a method of multiplication in the Centrales. What remains doubtful is their fate. If the occurrence of reduction during their formation were clearly substantiated, the sexual nature of the microspores would be rendered very probable, but their exact role can only be proved by direct observation of living material.

Resting spores.—Resting spores are formed in many neritic species of Centricae after a period of active vegetative life or during periods when conditions are unfavorable for vegetative growth. They have a concentrated nutritive content. The spores have very thick walls which are secreted by the protoplast, and are always made up of two valves, a *primary valve* and a *secondary valve*. No girdle is formed. Either or both valves may be spined. In *Chaetoceros* the spores do not have the characteristic setae of the vegetative cells, although they are often provided with elaborate processes. The usual method of formation is within an ordinary cell, although they are formed in auxospore-like perizonia in only a few species. Only one resting spore is present in a vegetative cell except in *Rhizosolenia setigera*, which has two.

The cell may divide just before formation of the resting spore and the new valves may be thickened to form the primary valves of each resting spore. Two resting spores will then be close to each other, as in the twin spores of *Chaetoceros didymus* (fig. 75-A, c-e). In some species, as in *Stephanopyxis palmeriana* (fig. 4, c, d), the formation of the secondary valve of the resting spore may result from an unequal cell division. One of the daughter cells is the resting spore, the other a rudiment of the cell left in the end of the mother cell. This is a primitive type of resting-spore formation and is considered homologous to the dimorphism found in some species.

Dimorphism refers to the existence of two forms of the same species, one form of which has much thicker walls than the other and is less well adapted to a planktonic existence. It is probable that the thick-walled form represents the means of survival from one period of planktonic activity to another and thus corresponds to the resting spore. In *Rhizosolenia hebetata*, a dimorphic species, form *hiemalis* (fig. 50-A) is the winter (resting ?) or cold-water form with thicker walls; form *semispina* (fig. 50-B), the more delicate summer or warm-water form.

Gross recently reported on some interesting experimental work covering the life histories of diatoms (1937) and the development of isolated resting spores into auxospores in *Ditylum brightwellii* (1940a, 1940b). According to his

description of the formation of resting spores in cultures of *Ditylum* (1937), the plasma membrane retracts from the cell wall and the protoplast gradually shrinks, the protoplasm, nucleus, and chromatophores becoming concentrated to form a compact spherical body. At first this body is connected with the shell by means of a number of protoplasmic filaments, which later become resorbed in the course of shrinkage.

Gross concluded from his first experiments (1937) that three factors were responsible for the formation of resting spores: (1) crowding of the cultures; (2) low light intensity; and (3) low temperatures (below 12° C.). None of these factors alone could bring about resting-spore formation; only the interaction of all three seemed to be effective. Later experiments (1940*b*) showed that the formation and the germination of resting spores are based upon a very peculiar osmotic behavior. He concluded that *Ditylum* does not behave as an osmotic system. Several conditions must be fulfilled to enable *Ditylum* to maintain the turgor of the vegetative cell. The absence of any of these conditions causes loss of water and the shrinkage of the cell membrane, or, briefly, the formation of resting spores. These conditions are: (1) the presence of calcium and sodium; (2) a pH similar to that of sea water; and (3) a metabolic activity of the cells.

Germination of resting spores is a process almost exactly the opposite of that involved in their formation. Fine protoplasmic processes are sent out and connect the spore with the old shell. The spore elongates and the processes or "pseudopodia" become conspicuous. Gradually the expansion of the protoplast is completed and the cell gains its normal appearance.

Gross (1940*a*) also observed the germination of resting spores outside the old cell walls. These isolated spores started germination when they were placed in fresh culture medium. The process is essentially the same as that taking place inside the shell, but, since the shell is absent, the germinating spore has an unusual appearance. Fine protoplasmic processes, similar to those described as connecting the spore to the cell wall, are sent out in all directions. Chromatophores pass along these processes and the protoplasm gradually expands. In from one to two days the cell body becomes larger and the "pseudopodia" shorter until the cell assumes a spherical shape again. These spherical bodies resemble auxospores in every respect. An isolated resting spore regularly passes through this auxospore stage during development. Gross reported that the diameter of the cells which originated from the isolated resting spore was more than twice that of the parental cell.

It is entirely possible that many resting spores become isolated in the sea while the cell is sinking to greater depths. Their germination would also result in the formation of broad cells. Since the isolated resting spores always develop first into auxospores and then into cells of about maximum diameter, it appears that the size of a centric diatom is imposed upon the cell by the structure of its cell wall and the resulting peculiar mode of cell division. The observations of Gross showed that the formation of auxospores by the extrusion of the protoplast from narrow vegetative cells is not necessarily the only method

whereby the size of a diatom may be regulated. The appearance of broad cells in plankton samples may also be due to the germination of isolated resting spores.

COLONY FORMATION AND THE SECRETION OF MUCUS

The attachment of cells to form colonies is accomplished by mucus secreted by the cells themselves. A layer of mucus or gelatinous strands may be formed between the valve faces resulting in ribbon-shaped or threadlike colonies. The cells of zigzag colonies are united by small gelatinous cushions at the corners of the valves. In a few species cells are united by their girdle sides. In certain pelagic species of *Nitzschia* contact is at the ends of the cells only.

Some diatoms secrete simple or branched gelatinous stalks by which they are attached to other plants, animals, or the substrate. Some species secrete a great amount of mucus so that many individuals are embedded in a common mass. Simple or branched gelatinous tubes may be formed to enclose a large number of cells.

Special pores, situated in definite localized positions in the valves of different genera, often secrete mucus. They occur near the middle of the valve in some genera, near the ends of the valves in others. This varying position of the secretory pores is mainly responsible for the many different shapes of colonies. A gelatinous membrane has been described as stretching between the radiating cells in plankton species of *Asterionella*. This would be a special adaptation for flotation.

Secretion of mucus, however, is not the only cause of colony building. Many diatoms are joined into chains or various-shaped colonies by processes such as spines (fig. D, 4), knobs, or more or less long setae (fig. H). In *Stephanopyxis palmeriana* (fig. 4) the cells are bound into chains by spines at right angles to the valve face. However, a fine canal is present in the spines and through this canal the cementing substance is secreted. A similar arrangement is present in *Skeletonema costatum* (fig. 6). In *Chaetoceros* and *Bacteriastrum* the basal parts of the processes or setae, outgrowths on the valves, are joined together and are often more or less strongly twisted, the free ends then running out into the surrounding water (fig. H). In the genera *Lauderia* and *Thalassiosira* a cytoplasmic thread runs between cells from the center of the valves, and often a row of spines or cytoplasmic rays projects from the margins of the cells as well (fig. C, 7; fig. D, 1). Cytoplasmic connections arising from various parts of the cell hold together the chains formed by many truly planktonic species.

MOVEMENT OF DIATOMS

Although various suggestions have been made in the past hundred years or more concerning the method or methods by which diatoms move, even today the matter has not been settled to the satisfaction of all investigators. In some species the movements are relatively slow, in others more rapid. It is an extremely interesting sight to see the individuals propelling themselves backward and forward, but the method used is difficult to explain. Frequently the movement is jerky, sometimes creeping and steady. Single cells may

move about freely, whole colonies may move together as one cell (*Nitzschia pacifica*), or the cells in a colony may move back and forth upon one another (*N. paradoxa*).

It is generally assumed that only those species having a true raphe are capable of spontaneous movement. Usually these are not true plankton species. Diatoms with a highly developed raphe show the quickest motion. Movement may take place when the diatom is in contact with only the surrounding water, contact with a substratum apparently not being necessary. It is entirely possible that one explanation does not cover all cases of spontaneous movement. Probably the most generally accepted opinion is that the basis of movement is the streaming of the cytoplasm through the raphe, which places the cell contents in direct contact with the water and sets up currents of cytoplasm. The resulting friction is considered to be the cause of the movement.

Various suggestions to account for movement include the protrusion of pseudopodia, differences in surface tension, the development of osmotic currents, the presence of rows of cilia (actual organs of locomotion), a lack of synchronism in the chemical action occurring at the two ends of the cell, the presence of fine gelatinous threads proceeding from the central nodule and running obliquely backward to form an acute angle with the surface of the frustule, the presence of an outer coating of protoplasm protruded from the raphe and kept in a state of vibration, or the expulsion of invisible gas molecules (possibly oxygen disengaged by the chromatophores on exposure to strong light). Mann (1905) wrote that "it is not at all improbable that the so-called 'gelatinous sheath' which overlies uniformly the entire external surface and is connected with the living cell contents through numerous minute pores, is the seat of this motion, and by undulatory movements over its surface produces the phenomenon that is so evident and so puzzling. Some explanation based on the external membrane fits the case better than any other".

Recently the presence of cilia has again been claimed. The propelling force, at least in some species of *Pleurosigma*, has been said to be rapid plasmic vibrations, which is the motive force in other low forms of motile water organisms— in other words, exceedingly minute ciliary action. One investigator, A. C. Coles (Taylor, 1929, photographed what he claimed to be cilia. The photographs were of dead specimens, taken after a drastic process of staining with silver. Many diatomists believe that the phenomenon is due to a disintegration or alteration of the plasmic covering of the diatom during this treatment. Taylor (1929) concluded his discussion of this subject as follows: "To sum up the present situation (15.11.28), the cilia have been photographed in dead motile, and perhaps also immotile diatoms, and clearly exhibited. Also under unusually powerful illumination they have been seen on living motile diatoms by three of the most expert microscopists. Their mode of action has not yet been observed."

Good discussions of movement as observed in diatoms are to be found in West (1916), West and Fritsch (1927), Taylor (1929), Hustedt (1930), and Fritsch (1935)

ADAPTATIONS FOR FLOTATION

Diatoms are adapted for flotation in a variety of ways. Gran (1912), following Schütt, who studied the various types of suspension organs carefully, placed the different cell forms with their many adaptations for floating under four headings:

1. The bladder type: Here the cell is relatively large, the cell wall and protoplasm merely thin membranes around a large central cavity. The cavity is filled with fluid of about the same specific gravity as sea water. Species of the genus *Coscinodiscus* are examples of this group.
2. The ribbon type: The cell wall is thin and the cell is flattened to give a greater surface. The cells may be joined into ribbon-shaped colonies. *Climacodium* and *Fragilaria* are examples of this type.
3. The hair type: The cells are very long in one direction or united into narrow, elongated colonies. These long cells may be slightly curved or have sloping terminal faces which help maintain them in a horizontal position and thus keep them floating. *Thalassiothrix* and *Rhizosolenia* are examples.
4. The branching type: The genus *Chaetoceros* with its four long setae from each cell is a good example of this group. The cells are usually found in chains. Other outgrowths such as knobs and spines also help increase the surface.

The secretion of long filaments or masses of mucus from special pores probably aids in flotation. The extrusion of protoplasmic threads or streams probably serves the same purpose by stream friction against the surrounding water and by increase of surface. In *Planktoniella sol* (fig. 27), widely distributed in the oceanic plankton of warmer seas, the epivalve is provided with a broad, hollow, slightly silicified wing divided by septa into a series of chambers. Sometimes this wing extends straight out from the cell, at other times it is bent to resemble an umbrella.

The production of gases and oils by the living diatom cells undoubtedly has a marked effect upon their ability to float. The specific gravity of diatom cells must be very near that of sea water. Any slight variation in amount of oil stored, amount of gas produced, length and number of protoplasm threads extruded, or other factors possibly too unobtrusive to have been considered, may be reflected in the ability of the cells to maintain themselves at a favorable level in the sea. Conditions external to the individual cells themselves, differences in density and viscosity of the surrounding water, abundance of other organisms or inorganic material in their environment, movement of the water, and other factors likewise influence flotation (Gran, 1912; Allen, 1932).

OCCURRENCE AND DISTRIBUTION OF DIATOMS IN THE OCEAN

Diatoms are widespread in their distribution in nature. They live in fresh, brackish, and salt water and in ice, moist soil, and other damp places. Between 8,000 and 12,000 species have been described from all known habitats.

Marine species are either *pelagic* or *littoral*. Pelagic species are those that live near the surface of the ocean during all, or at least during the greater

part, of their existence. Littoral species live exclusively near shore and are either motile or fixed to a substrate. Both motile and fixed littoral species occasionally occur in plankton collections. Parts of chains of fixed bottom-living forms often break away and appear in the plankton. When this occurs, the diatoms are called *tychopelagic* forms. They may float about for some time but do not reproduce in the plankton. Before dividing and starting a new chain, the cell becomes fixed to the substrate. Only a very few species can propagate both in the neritic (pelagic) zone and in the littoral zone. *Biddulphia aurita* (fig. 112-A) is an example. Only a few littoral species that are commonly found in plankton collections will be described here. The present paper deals for the most part with the pelagic marine species.

The pelagic diatoms are further divided into *oceanic* and *neritic* species. Oceanic diatoms are those capable of living and reproducing entirely in the open ocean. Neritic species are those having their origin near the coast and reproducing most efficiently under coastal conditions.

Most of the coastal or neritic species have a special adaptation, the resting spores, which serve as protection against changing conditions. The spores sink into deeper water and may be found there for several months after the species has disappeared from the surface. The majority remain on the bottom in shallow coastal water until conditions favor their germination (Gross, 1937, 1940a). Resting spores must be the means by which many species continue in coastal waters in spite of the fact that conditions are more variable there than in the open ocean and may be favorable to diatoms for only a limited part of each year. Gran (1912) reported the formation of resting spores in neritic species even in the open ocean. They apparently sink slowly and remain in the photosynthetic zone for weeks or even months.

The dividing line between oceanic and neritic species cannot be closely drawn. Oceanic species are frequently collected near shore, whereas neritic species may be found in the open ocean, far from shore, still continuing to increase although seldom in any great quantity.

Both oceanic and neritic species may be further divided into three main groups according to the latitude in which they are most commonly found or have had their origin. Thus we speak of *arctic*, *temperate*, and *tropical oceanic* species and *arctic*, *temperate*, and *tropical neritic* species. Subdividing these again, we have *boreal* (northern but not arctic species), *north temperate*, *south temperate*, and *subtropical* species. This classification is more or less arbitrary. Some species are ubiquitous, others restricted within rather definite regions. There are a number of species which it is still impossible to place in any definite group. The boundaries of the regions are variable and the flora of each locality is continually changing with seasonal changes and movements of the water.

It has been a generally accepted opinion for years that plankton diatoms are more abundant in coastal waters than in the open ocean, in temperate or especially northerly temperate waters than in tropical seas, and in certain seasons of the year than in others. Collections made for the Scripps Institution

during the last twenty years off the west coast of North America and as far south as Callao, Peru, confirm some of these opinions, cast doubt on others (Allen, 1929*b*, 1936). According to the Scripps Institution observations, no large catches have yet been obtained as far as one hundred miles from shore. Almost all the very large collections have been made in enclosed regions or very near shore. In a given locality, seasonal distribution of diatoms has been found to vary widely from year to year. Maximum abundance has tended to occur in spring but may occur at another season in certain years. Abundance has usually been very low in May, August, and December in the localities where regular observations have been made for the Scripps Institution. The largest catches of diatoms have been obtained from rather high latitudes, yet some almost as large have been found along the California coast. Very large catches have been reported from the Gulf of Panama and along the coast of Central America (Cupp, 1934; Allen, 1939). Diatom populations were found to be lower at Scotch Cap, Alaska, than at either La Jolla or Point Hueneme in southern California waters, or at Friday Harbor, Washington (Phifer, 1933; Cupp, 1937). No latitude should be rated as the most productive until we have more evidence collected regularly over a long period of time and treated statistically. As yet we have no series of collections taken regularly throughout a year for tropical regions.

Vertical distribution of autotrophic diatoms is limited to the photosynthetic zone, the depth of which naturally varies with latitude, time of year, and quantity of organic or inorganic material in the water. During the summer off southern California the greatest abundance has been found to occur most frequently at depths of from twenty to thirty-five meters below the surface (Allen, 1929*b*). The individual species appear to show differences in their light requirements. A negative correlation between abundance of diatoms and abundance of sunlight has been demonstrated to exist under certain conditions.

Reports on distribution and abundance of phytoplankton from Alaska to the Gulf of Panama and in the Gulf of California may be found in the following papers: Allen, 1922, 1923, 1924, 1927*a*, 1927*b*, 1927*c*, 1928*a*, 1928*b*, 1928*c*, 1929*a*, 1929*b*, 1930, 1933, 1934*a*, 1936, 1937, 1938, 1939; Allen and Lewis, 1927; Bigelow and Leslie, 1930; Cupp, 1930, 1934, 1937; Cupp and Allen, 1938; Phifer, 1933.

ASSOCIATIONS OF DIATOMS WITH OTHER ORGANISMS

Several different types of associations exist between diatoms and other organisms. True parasites have been reported in some species. The fungus *Olpidium phycophagum*, an encysted parasite, has been found in *Eucampia zoodiacus* and in many other species of diatoms. Other fungi also have been observed. Both *Chaetoceros* and *Rhizosolenia* have been found containing the alga *Richelia intercellularis*, one of the Nostocaceae (fig. 48-A, *c*). The dinoflagellate *Paulseniella chaetocerates* has been found on *Chaetoceros borealis* and *C. decipiens*. The cells are fixed by small stalks inside the setae and appear as round prominences outside.

Commensalism between three tube-building species of the genus *Cymbella* and *Nitzschia dissipata*, fresh-water diatoms, was described by Cholnoky (1929). In this association *Nitzschia* utilizes the metabolic products of *Cymbella*. A number of cases of symbiosis have been reported, but the existence of a true symbiotic condition is difficult to establish in diatoms.

The flagellate *Solenicola setigera* very frequently attaches itself to *Dactyliosolen mediterraneus* (fig. 38). It forms a mass or colony on the outside of the cell wall. The individuals, each with a long flagellum, are often difficult to distinguish as such. Gran, in 1905, recorded the existence of colonies, but the true structure of the cells was made known first in 1916 by Pavillard (1916b). In the same paper Pavillard described *Bicoeca mediterranea*, a flagellate with a vase-like case, found on *Skeletonema costatum*, *Nitzschia seriata*, *Cerataulina bergonii*, *Chaetoceros anastomosans*, *C. lorenzianus*, and *Thalassiothrix frauenfeldii*. His sketch shows a group of six individuals on *Nitzschia seriata*. A similar organism is often found on *N. pacifica* in water off La Jolla (fig. 157, l). Here the cells do not occur in groups but are distributed over the length of the valve. As many as twenty-eight individuals have been seen on one cell of *N. pacifica*. The protozoan *Vorticella oceanica* is often abundant on *Chaetoceros coarctatus* (fig. 62, a). Ostenfeld (1902), in his description of *Palmeria hardmaniana*, stated: "Curious is a curved fissure on the valves; in most specimens which I have seen, this fissure was a place of refuge for a little protist, probably an *Amphorella borealis* (Hensen) Dad., var. nov.; the small, more or less numerous, organisms were fixed to the inner side of the fissure." *Fragilaria parasitica* has been found attached to another diatom, *Nitzschia sigmoidea*. Bacteria are probably among the most important epiphytic organisms which are associated with marine diatoms.

Diatoms themselves may live on animals. *Chaetoceros tetrastichon* and *C. dadayi* (fig. 64, a) both live attached to *Tintinnus inquilinus*, a Tintinnid (Protozoa). *Hemiaulus hauckii* and *Chaetoceros peruvianus* are associated with another Tintinnid, *Tintinnus lusus-undae*. The diatoms are always in definite positions in relation to their hosts.

Antarctic Fin whales and Blue whales are often covered with a buffish colored film easily seen on the white parts of the body. A Blue whale in this condition is known to whalers as a "Sulphur Bottom." Whales with this film are caught off the Shetlands during February and March. E. W. Nelson (1920) examined the film and found it consisted of a new species of *Cocconeis* which he named *Cocconeis ceticola*. Bands of buffish-colored film similar to that on whales often occur on icebergs and sea ice in Antarctic waters.

Many species of diatoms live attached to other plants and occasionally become broken off to be collected with the plankton. Numerous other interesting associations have been recorded.

PHYSIOLOGY OF DIATOMS

NUTRITION

Diatoms are predominantly *autotrophic* or *holophytic* organisms. They build organic matter from inorganic materials present in their environment. By means of the pigments present in the chromatophores, the cells are able in the presence of sunlight to fix the carbon dioxide dissolved in the sea water and use the carbon to build up complex foods, or, in other words, to carry on photosynthesis. Fatty oil is the principal product of assimilation in the diatoms. Oil is stored in vacuoles as a reserve-food material. Starch or other carbohydrate synthesis is at a minimum, whereas the droplets of fat as seen in microscopic examination, although actually small, are really large in comparison with the total bulk of the minute diatom cell. Oils prepared by extraction from masses of diatoms have the characteristic odor of fish oil. Fat synthesis in marine plants plays a role in aquatic life somewhat analogous to that of photosynthesis of carbohydrates by green plants in terrestrial life. Fat production may be indirectly dependent upon photosynthesis, since all great accumulations of fat in the plant world are found in green or at least in pigmented plants.

A few species with a complete absence of pigment have been described as saprophytic. Such forms are found usually where decaying organic matter is abundant in the water. Most of the known saprophytic forms are extremely motile. Karsten (1901) produced a saprophytic form of *Nitzschia palea* by growing it in a favorable nutritive medium of glycerine, dextrose, and tap water. Experimentally it has been found that most of the species cultured for nutritional studies have been capable of living as heterotrophic individuals.

The nutritional requirements of autotrophic diatoms resemble those of other green plants. Certain differences, however, have been demonstrated. Calcium is essential to the growth and development of all green plants. It is not essential for some of the lower algae including at least some of the diatoms. Sodium, not one of the essential elements for the normal development of seed-bearing plants, is required by diatoms. Silica is of course necessary for the building of the diatom frustules and may be necessary for normal nutrition. Bachrach and Lefèvre (1929) reported that in culture experiments certain marine and fresh-water diatoms lived without a siliceous frustule, and retained their ability to move and divide, although the determination of the species became impossible because of their loss of normal shape. Harvey (1933) and ZoBell (1935) reported that the addition of a little silicate to culture media improves the growth of diatoms. Harvey (1939) found that *Ditylum brightwellii* required manganese. A concentration of one part per thousand million parts was sufficient for vigorous growth. Iodine does not appear to be necessary for the growth and development of diatoms. Nitrogen, phosphorus, potassium, magnesium, oxygen, hydrogen, carbon, sulfur, and iron are as essential to the normal development of diatoms as to that of higher plants.

A number of investigators have demonstrated experimentally that diatoms and certain other algae utilize ammonium nitrogen as readily as, or even in preference to, nitrate nitrogen (Schreiber, 1927; Cooper, 1933; ZoBell, 1935; Harvey, 1940). Many data suggest that in the sea much more ammonium than nitrate is used by diatoms. Harvey (1940) reported that diatoms also use urea, uric acid, and possibly certain amino acids as sources of nitrogen.

ENVIRONMENTAL FACTORS LIMITING PHYTOPLANKTON PRODUCTION AND POPULATIONS

For many years attention has been attracted to the problem of limiting factors in the production of marine phytoplankton—factors that account for the variation in abundance of cells at different seasons of the year, in various localities, and at different depths in the ocean. Many factors are involved and interrelated. Chemical factors influencing production include the presence of phosphate, nitrate or ammonium, silica, oxygen, carbon dioxide, numerous other secondary elements such as iron, sulfur, sodium, and manganese, and the salinity and hydrogen ion concentration. Light, its intensity and duration, temperature, viscosity, and density make up the physical factors involved. Upwelling and vertical mixing are factors in the circulation of the water that have a great effect upon the supply of nutritive salts. (Gran, 1930, 1931; Atkins, 1926*a*; Moberg, 1928.)

Brandt (1902) first advanced the theory that certain indispensable nutritive substances occur in such small amounts that, according to Liebig's minimum law, they act as limiting factors. Nathansohn (1906) was the first to record that vertical currents are intimately bound up with the circulation of these nutritive substances. The importance of upwelling and vertical mixing has been emphasized by recent investigations. Bigelow and Leslie (1930) concluded that upwelling is the chief agent in bringing new supplies of nutrients to the surface in Monterey Bay, as off southern California (Moberg, 1928). Moberg also discussed the effect of the rate of upwelling and its importance in bringing nutrients to the diatom zone at a favorable time.

Gran (1933) stated that it is now well known that most of the differences in the productivity of the various areas in the sea can be explained from the distribution of the nitrates and phosphates acting as limiting factors. (See also Atkins, 1923*a*, 1926*b*, 1926*c*, 1928, 1930; Gran, 1929; Harvey, 1926, 1928, 1933; Harvey, Cooper, Lebour, and Russell, 1935; Marshall and Orr, 1927; Moberg, 1928; ZoBell, 1935.) There is some indication that soluble iron may be present in sea water in insufficient quantities to support a rapid growth, particularly of the neritic diatoms (Harvey, 1937). Silica may possibly be a limiting factor in some localities but definite proof is not yet available. (See Atkins, 1923*b*, 1926*a*, 1928, 1930; Harvey, 1933; Marshall and Orr, 1927; Moberg, 1928.) In different regions or at different times of the year in the same region, different salts may be the limiting factors for plant production. For example, Atkins (1928) found the surface water of the English Channel depleted of phosphates during periods of mass production of diatoms, whereas in

southern California coastal waters Moberg (1928) found the upper 25 meters of water entirely denuded of nitrates but containing measurable amounts of phosphates. Under either condition a large production of diatoms in the upper layers of water would be prevented. It is possible that some substances that are washed out from land (humus compounds or other organic matter) alone or in combination with iron or manganese ions may increase production (Gran, 1933; Harvey, 1939).

The production and growth of phytoplankton in temperate and higher latitudes is limited by lack of light during the short winter days with little sunshine. The intensity of light at the surface, together with the transparency of the water, controls the thickness of the water layer in which photosynthesis takes place. In Loch Striven, Marshall and Orr (1930) found that the date of the spring increase is apparently determined chiefly by the total light, which depends on both length of day and brightness.

Oxygen and carbon dioxide are probably never limiting factors in production, at least not under conditions normally found in the sea.

Diatoms probably greatly influence the pH of sea water in which they are growing. Within the range of 7.8–8.8 the pH does not act as a limiting factor, according to Lucas and Hutchinson (1927). Moberg (1928) found that off La Jolla, in water from the surface down to 150 meters, the region of greatest variability of pH was in the photosynthetic zone.

Salinity in itself, within the range occurring normally in the sea, has little direct effect upon production. Diatoms are tolerant of wide variations in salinity as well as in temperature. However, temperature and salinity in combination influence the viscosity, the density, and the vertical stability of the water, which in turn tend to control the activity of its vertical circulation and thus indirectly to favor or hinder the flotation of marine diatoms and the presence of an adequate food supply for them as the seasons change.

The temperature optimum for diatoms is not known. The various species live over a range of several degrees. Off the coast of southern California in the summer of 1926 (Moberg, 1928), diatoms occupied a layer of water in which the temperature varied according to depth from 10° C. or less to 20° C. and were most abundant at depths where the temperature averaged about 13° C. (7° less than at the surface).

The formation and the germination of resting spores are important factors in the seasonal variation in the abundance of plankton diatoms in the sea.

Grazing of the herbivorous zoöplankton may be one of the most important factors in limiting diatom populations (Harvey, 1934*a*, 1934*b*; Harvey, Cooper, Lebour, and Russell, 1935). The following quotation from Harvey 1934*b*) is of interest:

An intimate relation or balance exists between the ever-varying populations of carnivores, herbivores, and vegetable food, which in its turn is sometimes controlled and always affected by the available nutrient salts and illumination. If the proportion of carnivorous to herbivorous animals is displaced for a period by an "abnormally large number of carnivores, then the diatoms are free to flourish and increase their population. If, on the other hand, the balance is displaced for a period by an "abnormally" small proportion of carnivores, then

the herbivores freed from their enemies can flourish, keep the breeding stock of vegetation closely grazed, and by so doing limit their own increase. This would automatically delay the utilisation of nutrient salts.

Harvey (1934*b*) concluded that the sudden decrease in vegetation after the spring maximum of 1933 was due to increased intensity of grazing by the increased numbers of herbivorous zoöplankton. Harvey, Cooper, Lebour, and Russell (1935) also found a relation between the number of animals and plants, an increase in animals being accompanied by a decrease in diatom population. They presented evidence showing that the spring outburst of diatoms is limited in quantity and time by the grazing of herbivorous plankton animals.

IMPORTANCE OF DIATOMS AS A SOURCE OF FOOD IN THE SEA

Diatoms have for many years been recognized as an extremely important source of food for plankton animals. Haeckel (1890), Johnstone (1908), Lohmann (1911), Gran (1912, 1930, 1931), Lebour (1921, 1922, 1923), Herdman (1923), Bigelow (1926), and Allen (1934*b*) have published valuable discussions of the problems involved in the abundance of life in the sea.

Johnstone (1908) stated: "The Diatomaceae are above all the most important organisms in the sea regarded from the point of view of their significance as the producers of organic substance. The diatoms are the 'pastures of the sea' and correspond to the 'grass of the fields' of the land." Gran (1930) wrote: "These enormous quantities of diatoms, without doubt, are the most important food for the pelagic copepods and indirectly for the fish larvae which develop after the great spring spawning period." Phifer (1933) likewise wrote: "Marine plants are the principal source upon which the fauna of the oceans depends for the energy necessary for existence. . . . Undoubtedly the shore algae produce organic material forming nutritive substances for bacteria which in turn are probably consumed by small protozoa. However, the phytoplankton are directly consumed and produce organic food in much larger quantities since the areal extent of their distribution is many times greater than that of the shore forms. Of the groups in the phytoplankton, such as diatoms, dinoflagellates, algal spores, coccolithophores, the first mentioned play the major role in temperate seas."

COLLECTION AND PREPARATION OF DIATOMS FOR EXAMINATION

Although many species of diatoms can be studied and classified directly by examination in water mounts, many others can be identified only by a careful study of the very delicate sculpturing on the frustules. These must be treated by some special method to free the cell of everything except its siliceous skeleton and then examined in a dry condition or mounted in a medium of high refractive index. If we wish to study the cell contents, still other methods of fixing and staining the cells must be used, depending upon the structures to

be examined. Only the methods of collecting, fixing, staining, cleaning, and mounting diatoms used by the author in preparing material for this paper will be described.

The majority of the diatoms described were obtained in regular plankton collections made by methods standard at the Scripps Institution—the pouring of a known quantity of water through a small net of No. 25 silk bolting cloth (mesh openings about 0.040–0.076 mm. on a side) and the gathering of the diatoms in a small bottle attached to the end of the net (Allen, 1921). Some collections were made by simply towing a small net through the water, others by allowing a liter or more of water to stand in a graduated cylinder until the diatoms had settled and then decanting the liquid. Smaller species that might escape through a fine net were collected by centrifuging samples of water.

Approximately 10–15 ml. of formalin (40 per cent solution of formaldehyde in water) were added to each 100 ml. of plankton sample as a preservative for most of the material. A solution made with 5 ml. of 40 per cent formaldehyde, 5 ml. glacial acetic acid, 40 ml. sea water, and diluted to 100 ml. by the plankton sample was used as a preservative for material to be prepared for cytological studies (Gran and Angst, 1931).

PREPARATION FOR EXAMINATION

Cleaning of frustules.—Collections containing principally the delicate plankton species were simply washed in repeated changes of distilled water to free the sample of salt water. A small amount of the material was placed in a homeopathic vial of about 30 ml. capacity, distilled water added to fill the vial, and the material gently distributed by rolling the vial in the hands and allowing the air to pass from end to end. The material was allowed to settle for from four to twelve hours. The supernatant liquid was very gently drawn off by a suction pump, the vial refilled with distilled water and treated as before. This process was repeated from five to ten times, or until all possible preservative and sea water had been removed. The material was then stored in distilled water with a few drops of formalin if Hyrax was to be used as a mounting medium, or transferred through 35 and 70–95 per cent alcohol if Pleurax was to be used. This method leaves the cells and chains of delicate species intact.

Collections containing the larger, more robust species were prepared for mounting by boiling them in acids. The structure of isolated valves is best studied after this treatment has been used to free the cells of all organic matter. The supernatant liquid was removed, from the sample, the diatom material transferred to a beaker, and about ten times its volume of commercial hydrochloric acid was added to bring the organic matter partially into solution and to remove all calcareous shells that might be present. The material was boiled in the acid for about twenty minutes. After the contents of the beaker had settled, the acid was poured away, fresh acid added, and the contents again brought to a boil. Commercial nitric acid was then added to the

boiling solution to bring about the rapid oxidation of the organic matter. This must be done slowly, drop by drop, to prevent the contents from foaming over the edge of the beaker. The addition of nitric acid was continued until the red fumes of nitrous acid produced by the oxidation were no longer given off. The beaker was then filled with distilled water and the sediment washed free of acids by repeated addition of water and decantations after settling. If this double-acid method failed to remove all the organic matter, the material was placed, after washing, in a porcelain evaporating dish or a small distilling flask with as little water as possible. Ten times its volume of commercial sulfuric acid was added and the material boiled for one or more hours over a sand bath under a hood; then, while the acid was still boiling, small particles of sodium nitrate were added cautiously until the blackened mass became colorless or pale yellow. After the sample had cooled, it was poured into a large volume of water and the supernatant liquid decanted after precipitation repeatedly until the diatom material was free of acid.

If there was sand in the residue, it was removed after washing by placing the residue in a deep evaporating dish, three or four inches in diameter, and then gently rotating until the sand collected at the middle of the dish and the diatoms were carried toward the outer margin of the whirling water. The water was decanted repeatedly after this process, the residue being rotated each time. The material was preserved as described above.

If the sample was relatively free of organisms or material other than diatoms, the first step, boiling in hydrochloric acid, was omitted. The material was boiled at once in concentrated nitric acid. If such a sample had been preserved in alcohol, it was first washed with water to prevent the formation of an ester of nitric acid which might cause an explosion resulting in loss of the specimens. After boiling, the acid was diluted with water and the diatoms collected on a filter paper and washed with distilled water, or water was added to the beaker and decanted after settling, as described above. For a detailed description of these methods of cleaning diatoms see Mann (1922) and Conger (1925).

Mounting of frustules.—Strewn mounts (mounts made from a drop of material containing several or many diatoms) were used exclusively. Single-cell mounts have definite value for many types of work, but require much more time to make than strewn mounts. (Conger (1925) has given detailed directions for mounting single chains of plankton diatoms and for general single-cell mounting. Two mounting media were used, Hyrax and Pleurax, both synthetic resins developed by Dr. G. Dallas Hanna of the California Academy of Sciences.

Hyrax is soluble in benzol, xylol, and toluol, but not in alcohol or water. It has an index of refraction of 1.71 when hardened on the slide. Material to be mounted in Hyrax must be stored in distilled water with a few drops of formalin as a preservative.

A drop or two of diatom material was placed on a clean cover glass; distilled water was then added to flood the material so that the diatoms would be evenly distributed. The diatoms were allowed to settle and then as much water as

possible was drawn off with a fine pipette. The remainder of the water was evaporated on a brass plate under which a very small gas burner was placed to supply gentle heat. A drop or two of Hyrax was then placed on the cover glass with the diatoms, warmed, and the solvent evaporated. The cover glass was next placed, diatom side down, in the center of a clean glass microscope slide and the slide warmed gently to melt the resin and permit it to flow evenly about under the cover glass. This took only a few seconds. The temperature must not be too high or bubbles will be formed. Hyrax preparations can be kept for years if sealed with gold size or some other lacquer. Unsealed slides may not last longer than six months.

Pleurax, a synthetic resin developed more recently than Hyrax, was used for most of the slides. It is particularly well suited for mounting delicate plankton diatoms. The index of refraction is above 1.9—higher than that of any other known resin. The depth of focus of the objective is increased in direct proportion to the increase of the index of refraction. *Pleurax* is soluble in 95 per cent alcohol and diatoms are mounted in it directly from 95 per cent alcohol. No clearing processes are necessary.

A drop of the preserved diatom material was mixed with a drop of *Pleurax* on the cover glass. The solvent was partially evaporated by placing the cover glass on a warm brass plate. The cover glass was then reversed on a clean glass slide and gently heated to not over 100° C., care being taken that no bubbles were formed. Higher temperatures must be avoided. Slides mounted for four or five years and not sealed with lacquer have shown excellent keeping qualities.

The use of No. 0 or the thinnest of the No. 1 cover glasses is urged because of the short working distance of the better oil immersion objectives necessary for study of the very fine structure of diatoms.

Additional information concerning Hyrax and *Pleurax* may be obtained from Dr. G. Dallas Hanna, California Academy of Sciences, San Francisco, California.

Cell contents.—The formula recommended by Gran and Angst (1931) as a preservative for material to be used in cytological studies has been given on page 30.

Acid fuchsin (0.5 gram acid fuchsin in 100 ml. distilled water) was used for staining general cytoplasmic structures. A drop of safranin solution (in 50 per cent alcohol) was occasionally added to material which was to be studied in water mounts. Methylene blue in a 0.001 per cent aqueous solution (1:100,000) was used for staining the contents of living cells. In this dilution, the cells can live for a day. Pfitzer's solution of nigrosin and picric acid was used to fix and stain the cell contents at the same time. The nigrosin is dissolved in a saturated solution of picric acid in water.

Chromatophores were best observed in very fresh, living material since they change position and appearance rapidly. When it was impossible to study fresh material, Bouin's solution was used as a fixing agent. After fixation and thorough washing, the material was stained with Delafield's hematoxylin or

acid fuchsin. The nucleus was usually visible in living cells. The inner nuclear structure can be seen only after special fixing and staining. Gelatinous material was made distinct by putting the diatoms in an emulsion of Higgins' India ink. In many cells the pyrenoids could be seen without staining. Detailed study of other structures within the frustule was not essential to the preparation of the present paper.

For excellent and detailed discussions of fixing agents and stains for general use and for use on special structures see Lauterborn (1896) and Hustedt (1930).

METHODS OF ILLUSTRATION

Line drawings are believed to be far superior to photographs for showing detail in the delicate plankton species. For more robust discoid species a combination of both photographs and drawings probably gives the clearest picture of the appearance of the entire cell and of detailed sections of the structure. All sketches were made with a camera lucida. All photographs were made with a Leica camera and Micro Ibsco attachment on Panatomic-X film through a C5 (blue violet) Wratten filter. A ribbon filament lamp was used as the source of illumination.

CLASSIFICATION

The classification followed is based on that of Schütt (1896), with certain modifications introduced by Hustedt (1930–1937). The chief characteristic of this system is the division of the entire group into two main sections: (1) the CENTRICAЕ, or CENTRALES, containing the centric diatoms, those having a concentric or radiating sculpture around a point or points (no raphe or pseudoraphe is present and spontaneous movement does not occur); and (2) the PENNATAЕ, or PENNALES, containing the pennate diatoms, those having their sculpture arranged with relation to a longitudinal line (these often possess a raphe or pseudoraphe and many species are capable of spontaneous movement).

The Centricae are by far the more important group in the plankton. We have here figured and described 121 species and 20 forms and varieties in 31 genera belonging to the Centricae, and 39 species and one variety in 20 genera belonging to the Pennatae.

BACILLARIOPHYCEAE

(Diatomales or Bacillariales)

KEY TO CENTRICAEE

- A. Valves with a concentric or radiating sculpture around a point or points, central or lateral, never arranged in relation to a middle line. Without raphe or pseudoraphe.
Outline circular, oval, or elliptical, sometimes polygonal, rarely crescent-shaped or spindle-shaped.
Processes commonSection **CENTRICAEE**

- I. Cells disk-shaped or cylindrical. Valves circular, their surface flat or convex, some-times hemispherical. Valve sculpture arranged in relation to a central pole. Spines frequent. As a rule without horns or knobs; when present, small.
Subfamily **Discoideae**

1. Valves circular. Not divided into definite sectors by ribs, rays, or undulating sectors. Sculpturing sometimes arranged in bundles. Knobs or eyes absent; more or less long spines often present. Tribe **Coscinodisceae**

- a) Cells lens-shaped, round, or cylindrical. Usually united into more or less long typical chains. Intercalary bands often sculptured. Valve mantle usually strongly developed. Subtribe **Melosirinae**

Genera: I. *Melosira* (p. 39)
II. *Stephanopyxis* (p. 40)

- b) Cells short or elongated-cylindrical, bound into close chains by delicate siliceous projections or gelatinous threads. Cell wall usually weakly siliceous.

Subtribe **Skeletoneminae**
Genera: III. *Skeletonema* (p. 43)
IV. *Coscosira* (p. 44)
V. *Thalassiosira* (p. 45)

- c) Cells disk- or drum-shaped, usually solitary, very seldom bound into chains. Valve surface slightly convex, rarely strongly convex, sometimes nearly flat or slightly concave. Intercalary bands hyaline or rarely very delicately sculptured. Valve mantle not particularly well developed.

Subtribe **Coscinodisceae**
Genera: VI. *Coscinodiscus* (p. 49)
VII. *Planktoniella* (p. 63)

2. Valves circular. Divided into distinct, complete or incomplete sectors by radial ribs or undulations or by wide hyaline rays from a characteristically constructed centrum. Without horns or prominent spines. Tribe **Actinodisceae**

- a) Valves with radial ribs that begin on the margin but often remain very short. Cells disk-shaped with almost flat valves. Solitary.

Subtribe **Stictodiscinae**
Genus: VIII. *Arachnoidiscus* (p. 65)

- b) Valves divided into sharply distinct sectors by radial ridges uniformly running from the margin to the hyaline central area. Small but distinct spines usually at the marginal ends of these ridges. Alternate sectors generally depressed. Subtribe **Actinoptychinae**

Genus: IX. *Actinoptychus* (p.66)

- c) Valves sharply divided into sectors by broad hyaline rays running from a hyaline center toward or to the margin, their outer ends marked with a minute spine; the hyaline center divided into more or less wedge-shaped divisions confluent with the rays. Spaces between the radiating rays marked with fine, closely set puncta arranged in radial or decussating rows. Subtribe

Actinoptychinae
Genera: X. *Asterolampra* (p.68)
XI. *Asteromphalus* (p.68)

3. Valves usually radially waved, eyes or knobs on the elevations, or valves flat and then with singly placed wartlike elevations or circle of needles.
Tribe **Eupodisceae**
- a). Valves with knobs. Only one genus. Subtribe **Aulacodiscinae**
Genus: XII. *Aulacodiscus* (p.69)
- II. Valves oval or circular in cross section. Cells elongate, cylindrical or subcylindrical, with numerous intercalary bands, without internal septa. Valve structure arranged in relation to an excentric pole. Cells united into chains by their valves. Subfamily **Solenioideae**
4. As above. Tribe **Solenieae**
- a) Valves flat or raised, with or without marginal spines. Excentric process or asymmetrical spine absent. Subtribe **Lauderiinae**
Genera: XIII. *Corethron* (p.70)
XIV. *Lauderia* (p.74)
XV. *Schröderella* (p.75)
XVI. *Dactyliosolen* (p.76)
XVII. *Leptocylindrus* (p.77)
- b) Valves with a single often very short spine or process, usually excentrically placed, thus destroying the symmetry of the cell. Valves flat or convex. Subtribe **Rhizosoleniinae**
Genera: XVIII. *Guinardia* (p.78)
XIX. *Rhizosolenia* (p.79)
- III. Cells box-shaped. Pervalvar axis generally shorter, sometimes slightly longer, than the valvar axis. Valves usually oval, sometimes polygonal, circular or semicircular; unipolar, bipolar, or multipolar, each pole represented by an angle or by a horn or spine, or by both angles and horns. .
Subfamily **Biddulphioideae**
5. Valves with long setae, longer than the cells. Cells united into chains by basal part of the setae. Seldom living as single cells. Intercalary bands only seldom present. Valves circular or oval. All species pelagic. Tribe **Chaetocerae**
Genera: XX. *Bacteriastrum* (p.95)
XXI. *Chaetoceros* (p.100)
6. Horns short and thick or, if longer, with claws at the ends. United into chains by the ends of the horns. Valvar plane circular or elliptical, usually with one to several poles. Valves, therefore, elliptical to circular, two- to many-angled. Intercalary bands and septa often present. Live partly in plankton, partly littoral. Majority of species marine. Colony building in chains frequent. Tribe **Biddulphiaceae**
- i. Knobs and horns without claws on the end.
- a) Valves bipolar. Cell wall weakly siliceous. Plankton forms.
Subtribe **Eucampiinae**
Genera: XXII. *Eucampia* (p.145)
XXIII. *Climacodium* (p.146)
XXIV. *Streptothea* (p.147)
- b) Valves tripolar to multipolar, sometimes with bipolar varieties. Angles not bearing domelike protrusions or horns. Intercalary bands frequently present. Marine forms, usually littoral, a few pelagic. Subtribe **Triceratiinae**
Genera: XXV. *Ditylum* (p.148)
XXVI. *Lithodesmium* (p.150)
- c) Valves bipolar, tripolar, or multipolar. Each angle with a domelike protrusion or a horn. Usually strongly siliceous. Mostly large robust marine forms that build chains. Predominantly littoral, but sometimes pelagic. A few species are typically planktonic and are then more weakly siliceous.
Subtribe **Biddulphiinae**
Genus: XXVII. *Biddulphia* (p.151)

- d) Valves unipolar. Cells in broad girdle view rhombic or trapezoid. Large to very large, robust marine forms. Littoral... Subtribe **Isthmiinae**
Genus: XXVIII. *Isthmia* (p.166)
- (ii) Horns with claws on the end.
- e) Valves bipolar, tripolar, or quadripolar. Each angle with a long vertical horn tipped with a claw; or in the bipolar forms either as described or having the angles of only one valve turned vertically upward into short-pointed ends without claws..... Subtribe **Hemiaulinae**
Genera: XXIX. *Cerataulina* (p.167)
XXX. *Hemiaulus* (p.168)
7. Cells without horns. Valves without internal septa. Valves semicircular, broader than long. Intercalary bands very seldom present. Cells in girdle view cuneate Tribe **Euodiace**
Genus: XXXI. *Hemidiscus* (p.170)

KEY TO PENNATAE

- B. Valves not centrally constructed, not arranged in relation to a central point but to a median line. Bilaterally symmetrical. Outline generally boat-shaped or rod-shaped, sometimes oval, cuneate, crescent-shaped, or sigmoid; markings generally pinnate or-transverse. True raphe, or hyaline median line (pseudoraphe), or raphe obscured by lateral wings or keel (cryptoraphe) always present. Processes such as horns, spines, etc., uncommon. Cell capable of spontaneous movement if a true raphe is present. Auxospore formation sexual or reduced. Microspores not certainly found.

Section **PENNATAE**

- B-1. Raphe absent. Pseudoraphe usually present. Subsection **Araphideae**

- IV. Cells in general rod-shaped to tabular-prism-shaped, in valve view usually more or less linear, seldom club-shaped. In girdle view linear to tabular-rectangular. Intercalary bands and septa frequently present. Valves with transapical striae or ribs, sometimes areolated-punctated, often with mucilage pores. Without a true raphe, but usually with a median pseudoraphe. Chromatophores usually more or less numerous small platelets, seldom a single large plate. Auxospore formation, so far as known, asexual.....Subfamily **Fragilarioideae**

8. Cells in valve view usually linear, more seldom wedge-shaped, frequently with transapical inflations or constrictions. In girdle view usually linear to tabular, seldom wedge-shaped. Intercalary bands and septa always present and distinct. Valvar plane not bent in the perivalvar direction, the two valves of a cell usually entirely alike. Cells usually united into bands. Marine and fresh-water forms..... Tribe **Tabellariace**

- a) Cells with both poles of apical axis alike, in neither valve nor girdle view wedge-shaped..... Subtribe **Tabellariinae**
Genera: XXXII. *Striatella* (p.172)
XXXIII. *Grammatophora* (p.173)
- b) Cells with poles of apical axis unlike. In girdle view, as in valve view, wedge-shaped. Intercalary bands and septa present. Cells stalked and often united into strongly branched colonies. Marine..... Subtribe **Licmophorinae**
Genera: XXXIV. *Licmophora* (p.176)
XXXV. *Climacosphenia* (p.177)
9. Cells usually rod-shaped. Usually linear in both valve and girdle view, seldom wedge-shaped or with tabular girdle view. Intercalary bands sometimes present, but always without or with only very rudimentary septa.
Tribe **Fragilariace**
- a) Valves with transapical ribs that are, however, sometimes limited to one valve of a cell or to one single middle rib. Fresh-water or marine forms. Cells as a rule united into closed or zigzag bands..... Subtribe **Diatominiae**
Genus: XXXVI. *Plagiogramma* (p.179)

- b) Valves without special transapical ribs, or the entire membrane provided with a supporting framework of stronger or weaker ribs.

Fresh-water and marine forms. Cells solitary or united into colonies

of various forms. Subtribe **Fragilarinae**

Genera: XXXVII. *Campylosira* (p.180)

XXXVIII. *Fragilaria* (p.180)

XXXIX. *Synedra* (p.181)

XL. *Thalassionema* (p.182)

XLI. *Thalassiothrix* (p.183)

XLII. *Asterionella* (p.188)

XLIII. *Pseudoenotia* (p.190)

- B-2. One valve of the cell always with *Navicula*-like raphe, the other without a raphe or with a rudimentary raphe-knot. Subsection **Monoraphideae**

- V. Cells with linear, lanceolate, or elliptical valvar plane, more or less distinctly bent about the apical or transapical axis. Intercalary bands and septa generally absent, valves, however, sometimes with polar pseudosepta, individual species also with an intercalary ring with rudimentary chamber-formation on the valve margin similar to the septa-chambers in the genus *Mastogloia*. Structure of the membrane: transapical rows of more or less delicate poroids, often in quincunx. The membrane lying between the transapical rows stronger, often thickened, riblike. The two valves of a cell usually considerably differentiated in regard to the structure as well as to the development of the raphe.

Subfamily **Achnantheoideae**

10. Cells bent about the transapical axis, sometimes also about the apical axis; the valve with the raphe, concave; the one without a raphe, convex. One valve always with a developed raphe, the other without, seldom with a very short raphe-knot or with a rudimentary raphe. Outline of valve usually linear-lanceolate, seldom elliptical. Intercalary bands sometimes present, true septa absent. Tribe

Achnantheae

Genus: XLIV. *Achnanthes* (p.191)

- B-3. Both valves with developed raphe Subsection **Biraphideae**

- VI. Cells of various types as regards structure of membrane, cell contents, and general form. All forms with a similar characteristic raphe system: an outer and inner fissure and accompanying end and central knots. Knots often greatly reduced or in many species only slightly developed. Inner and outer fissures often difficult to distinguish from each other. Raphe usually in the valvar plane, generally distinct, not developed as a canal raphe; usually without a keel or strongly developed wings, but when present always without marginal canal and keel puncta. Subfamily **Naviculoideae**

11. Cells as a rule of symmetrical construction, transapical axis only seldom with unlike ends. In girdle view usually rectangular, valves elliptical, linear or lanceolate, often S-shaped, seldom club-shaped or crescent-shaped. Raphe usually in the valvar plane. Not perceptibly keeled. Keel if present not punctate. Intercalary bands and septa sometimes present, usually absent. Cells usually solitary, sometimes in gelatinous tubes or on a gelatinous stalk, seldom united into bands and then often difficult to distinguish from *Fragilaria*. Tribe **Naviculeae**

Genera: XLV. *Navicula* (p.192)

XLVI. *Gyrosigma* (p.194)

XLVII. *Pleurosigma* (p.194)

12. Raphe on a keel or wing that usually lies in the midline of the valve. Cells usually twisted about the apical axis. Tribe **Amphiproreae**

Genera: XLVIII. *Tropidoneis* (p.197)

XLIX. *Amphiprora* (p.197)

VII Keel with canal raphe lying in the valvar plane, often displaced transapically as far as to the valve margin. In this latter case only one margin of each valve with a keel. Both valves with canal raphe. Keel with puncta ... Subfamily **Nitzschoideae**

13. Raphe obscured by punctate marginal keel. Markings always transverse.
Tribe **Nitzschieae**
Genus: *L. Nitzschia* (p.199)

VIII. Keel with canal raphe lying on the valve margin and running around the entire valve. Raphe system consequently apparently doubled. Raphe hidden in lateral winged keel.....Subfamily **Surirelloideae**

14. As above... Tribe **Surireleae**
Genus: *L.I. Surirella* (p.207)

A. CENTRICAE Schütt

1896. Bacill. in Engl.-Prantl, Nat. Pflanzenf., p. 57.

I. DISCOIDEAE Schütt

1896. Bacill. in Engl.-Prantl, Nat. Pflanzenf., p. 58.

1. COSCINODISCEAE Schütt

1896. Bacill. in Engl.-Prantl, Nat. Pflanzenf., p. 58.

a) MELOSIRINAE Schütt

1896. Bacill. in Engl.-Prantl, Nat. Pflanzenf., p. 58.

Genus I. MELOSIRA. Agardh

1824. Syst. alg.

Cells globose, elliptical or cylindrical, closely united in straight, beadlike chains by the centers of the valves. Valves either simply punctate or punctate and areolate. Intercalary bands none or many and narrow. Chromatophores compressed-circular or irregular granules, small, numerous, along the wall of the cell. Nucleus central. Auxospores formed by the ordinary cells parting at their girdles. Resting spores also formed.

All species live near the coast and are not truly planktonic, but frequently occur in plankton catches.

Species: 1. *M. moniliformis* (fig. 1)

2. *M. sulcata* (fig. 2)

1. *Melosira moniliformis* (Müller) Agardh

Figure 1

1783. Müller. Kongl. Vet. Acad. Handl., vol. 4, p. 83, pl. 3, figs. 1–5 (*Conferva moniliformis*).

1824. Agardh. Syst. alg., p. 8.

Cells short, cylindrical, in long chains. Diameter 23–60 μ . Usually in process of division so are united in twos by girdle bands which have not yet separated. Not keeled. Valves and

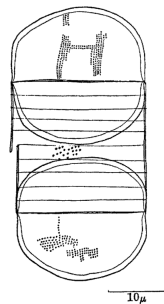

Fig. 1. *Melosira moniliformis* (Müll.) Ag. Part of a chain, girdle view; diameter, 23 μ .

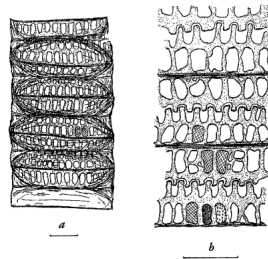

Fig. 2. *Melosira sulcata* (Ehr.) Kütz. a, part of a chain, girdle view; diameter, 40 μ . b, section of (a) showing method of cell connection.

girdle punctated, 22–24 in 10μ on valve, 15 on girdle. In valve view puncta in partly radiating, mostly irregular short lines; on valve mantle and girdle in more regular crossrows. Valves circular, very convex, thick-walled, without local reinforcements on inner side. Chromatophores numerous, edges entire. Nucleus central. Auxospores frequent.

Very common in littoral zone. Occurs in plankton accidentally (tychopelagic). Cold-water species. Not reported off southern California.

2. *Melosira sulcata* (Ehrenberg) Kützing

Figure 2

1838. Ehrenberg. Infus., p. 170, pl. 21, fig. 5 (*Gaillonella sulcata*).

1844. Kützing. Bacill., p. 55, pl. 2, fig. 7.

Cells disk-shaped, small, short, thick-walled, with circular constrictions at each end. Diameter 30–40 μ . Firmly united into short chains. Valves concave. Areolate and punctate. Margin of valve with a double row of cells, the outer row appearing as a crown of teeth. One girdle band usually covering the halves of two cells. Chromatophores, numerous, small. Auxospores known.

Neritic and littoral. Tychopelagic. Found occasionally in plankton catches off southern California and reported as far south as 13°51' north latitude.

Genus II. *STEPHANOPYXIS* Ehrenberg

1845. Ber. Akad. Wiss. Berl. 1844, p. 264, as subgenus; 1846, Ber. Akad. Wiss. Berl. 1845, p.80.

Cells oblong, oval, or nearly circular, with hexagonal areolations. Usually in short chains. Margins rounded, with a crown of stout spines or hollow needles, nearly parallel with the perivalvar axis. Cytoplasm of adjacent cells in contact through hollow spines. No intercalary bands. Chromatophores small, numerous, rounded. Resting spores known.

Species: 3. *S. turris* (fig. 3)

4. *S. palmeriana* (fig. 4)

5. *S. nipponica* (fig. 5)

3. *Stephanopyxis turris* (Greville and Arnott) Ralfs

Figure 3

1857. Greville and Arnott. Trans. Roy. Soc. Edinb., vol. 21, pt. 4, p. 64, pl. 6, fig. 109 (*Creswellia turris*). In note added to Gregory, 1857.

1861. Ralfs. In Pritchard, Infus., p. 826, pl. 5, fig. 74.

Cells circular, oblong, or ellipsoidal. Spines 12–16 at each end of cell, with distinct line of fusion midway between neighboring cells. Spines slightly thickened at the tips. Diameter of cells 36–57 μ . Areolations coarse, 3½–5 in 10μ , all about the same size, not smaller or only very slightly smaller at the valve margin. Girdle between two cells leaving a space between the halves of two alternate cells. Resting spores with thick walls and strong spines at two consecutive ends of adjacent cells.

Neritic. Temperate and subtropical species. Fairly common, but never abundant off southern California and in Gulf of California.

4. *Stephanopyxis palmeriana* (Greville) Grunow

Figure 4 (p. 42)

1865. Greville. Trans. Micr. Soc., N.S., vol. 13, p. 2, pl. 1, fig. 9 (*Creswellia palmeriana*).

1884. Grunow. Denkschr. Kais. Akad. Wissensch. Math.-Naturw. Kl., vol. 48, p. 90.

Cells oblong. In shape much like *S. turris*, from which it is distinguished by the slight narrowing of the cylindrical part of the valve against the margin, and by the hexagonal

areolations which are slightly smaller near the girdle line than on the rest of the valve. Areolae $1\frac{1}{2}$ – $2\frac{1}{2}$ in 10μ at center of valve, $3\frac{1}{2}$ –4 on upper part of mantle, and 5 – $5\frac{1}{2}$ near girdle line. On the newly formed valves 2 – $2\frac{1}{2}$ areolae in 10μ on mantle (fig. 4, b). Diameter of cells 27 – 71μ . Cells united in chains by 10 – 22 hollow spines arranged in a circle at each

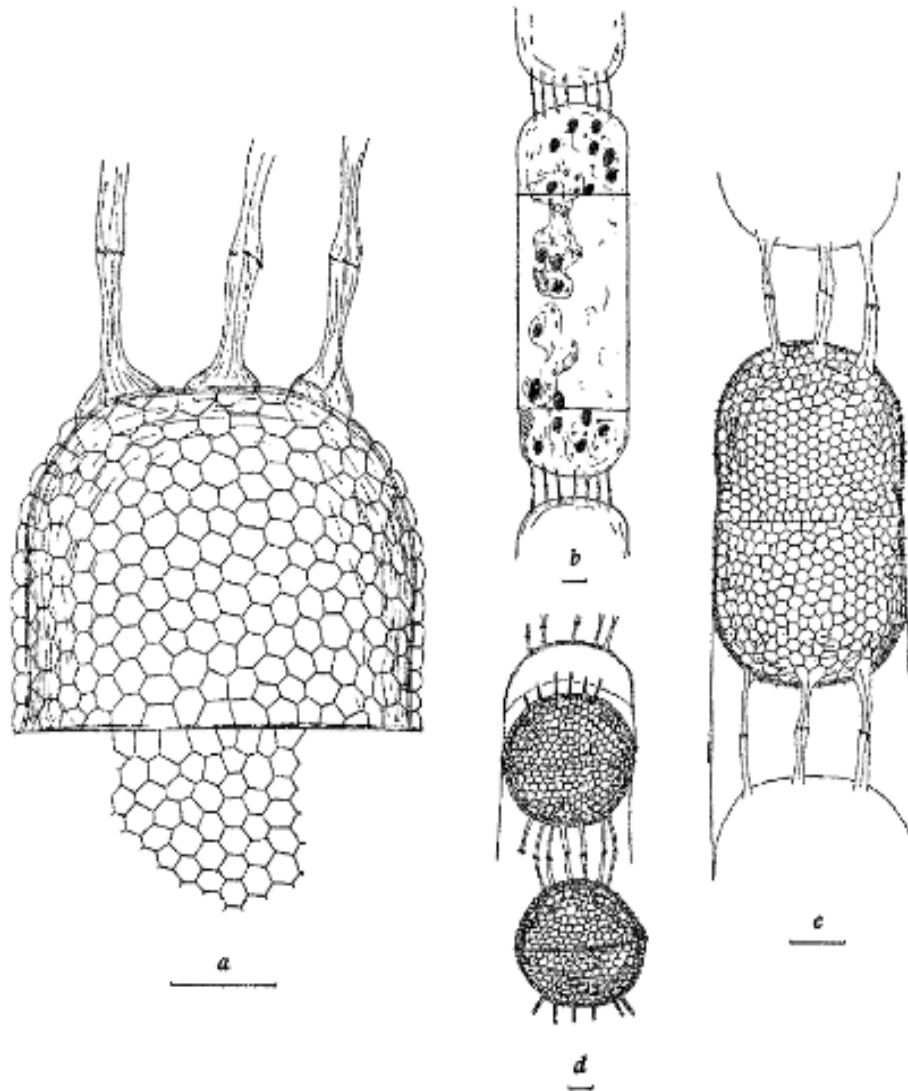

Fig. 3. *Stephanopyxis turris* (Grev. and Arn.) Ralfs. *a*, half of a cell, girdle view, showing areolation; diameter, 36μ . *b*, vegetative cell showing chromatophores; diameter, 45μ . *c*, entire cell shown in (*a*). *d*, resting spores; diameter, 48μ .

end of cell. Chromatophores numerous, platelike. Nucleus central. Twin resting spores large, like vegetative cells but thicker-walled (fig. 4, *c*, *d*); primary valve with uniting spines more radiating than in vegetative cells; secondary valves with acute, diverging spines without connection with another valve.

Neritic. Warmer-water species than *S. turris*. Reported off southern California but more common in Gulf of California.

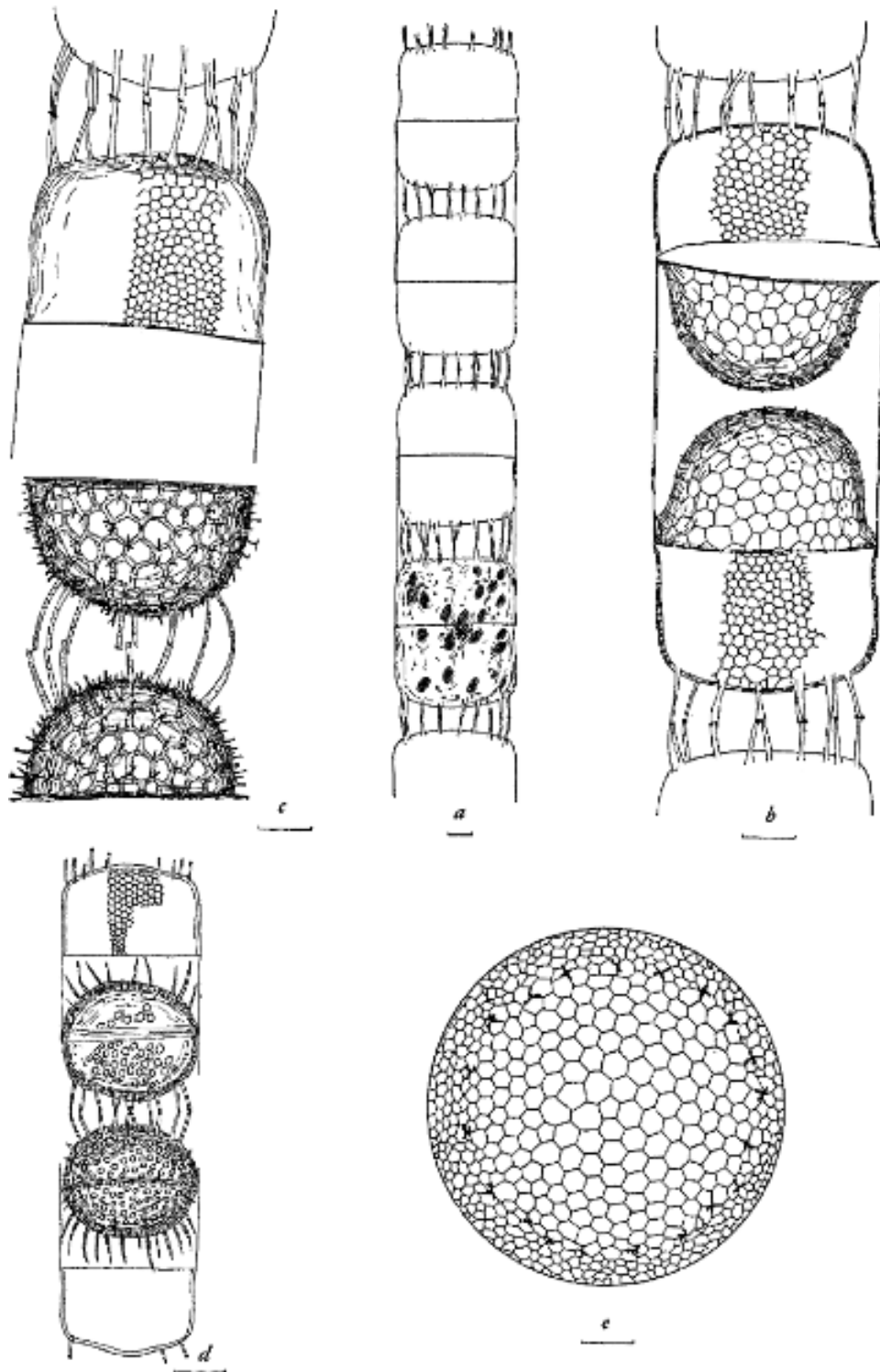

Fig. 4. *Stephanopyxis palmeriana* (Grev.) Grun. *a*, vegetative cells; diameter, 50μ . *b*, vegetative cells just after division; diameter, 45μ . *c* and *d*, resting spores; diameter, 27μ . *e*, valve view; diameter, 71μ .

5. *Stephanopyxis nipponica* Gran and Yendo

Figure 5

1914. Vidensk. Skrifter. I. Mat.-Naturv. Kl. 1913, no. 8, p. 27, fig. 16.

Cells oblong to spherical. Diameter 24–36 μ . Chains short. Spines 6–8, arising at tip of each valve and reaching valve of adjacent cell, no line of fusion as in preceding species. Valves with hexagonal areolae becoming slightly larger toward tip of valve. Areolae 5–6 in 10 μ on center of valve mantle. No intercalary bands. Chromatophores numerous, platelike, somewhat elongated. Nucleus central.

Neritic. North temperate to arctic species. Never abundant.

b) SKELETONEMINAE Schütt

1896. Bacill. in Engl.-Prantl, Nat. Pflanzenf., p. 62.

Genus III. SKELETONEMA Greville

1865. Trans. Micr. Soc., N.S., vol. 13, p. 43.

Cells circular, lens-shaped, oblong, or cylindrical. Valves circular, somewhat arched, without distinct structure, with a row of fine spines at the edge of the valve parallel to longitudinal, perivalvar axis. Spines interlock midway between adjacent cells and unite cells into chains. Cytoplasm of neighboring cells in contact through hollow spines. Chromatophores one or two in a cell. Nucleus central. Auxospores formed.

Species: 6. *S. costatum* (fig. 6)

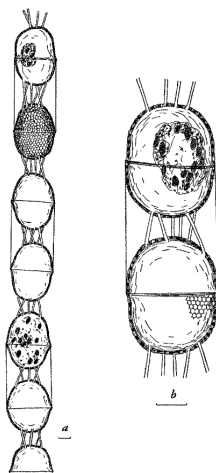

Fig. 5. *Stephanopyxis nipponica* Gran and Yendo. *a*, chain of vegetative cells; diameter, 36 μ . *b*, two cells of a chain more highly magnified; diameter, 32 μ .

6. *Skeletonema costatum* (Greville) Cleve

Figure 6 (p. 44)

1866. Greville. Trans. Micr. Soc., N.S., vol. 14, p. 77, pl. 8, figs. 3–6 (*Melosira costata*).

1878. Cleve. Bih. Kongl. Svensk. Vet.-Akad. Handl., vol. 5, no. 8, p. 18

Cells lens-shaped, elliptical, or cylindrical with rounded ends. Chains long, thin, usually straight. Cells held in chains only by means of spines. Space between cells usually or often longer than cells themselves. Chromatophores two. Nucleus central. Diameter of cells 3–20 μ . Auxospores not uncommon (fig. 6, *h, i, j*). In chains 6 μ in diameter, auxospores are 17–20 μ in diameter.

Neritic. Widely distributed in all seas. One of our most abundant species, particularly from February through April. Recorded up to nearly 2,000,000 cells per liter.

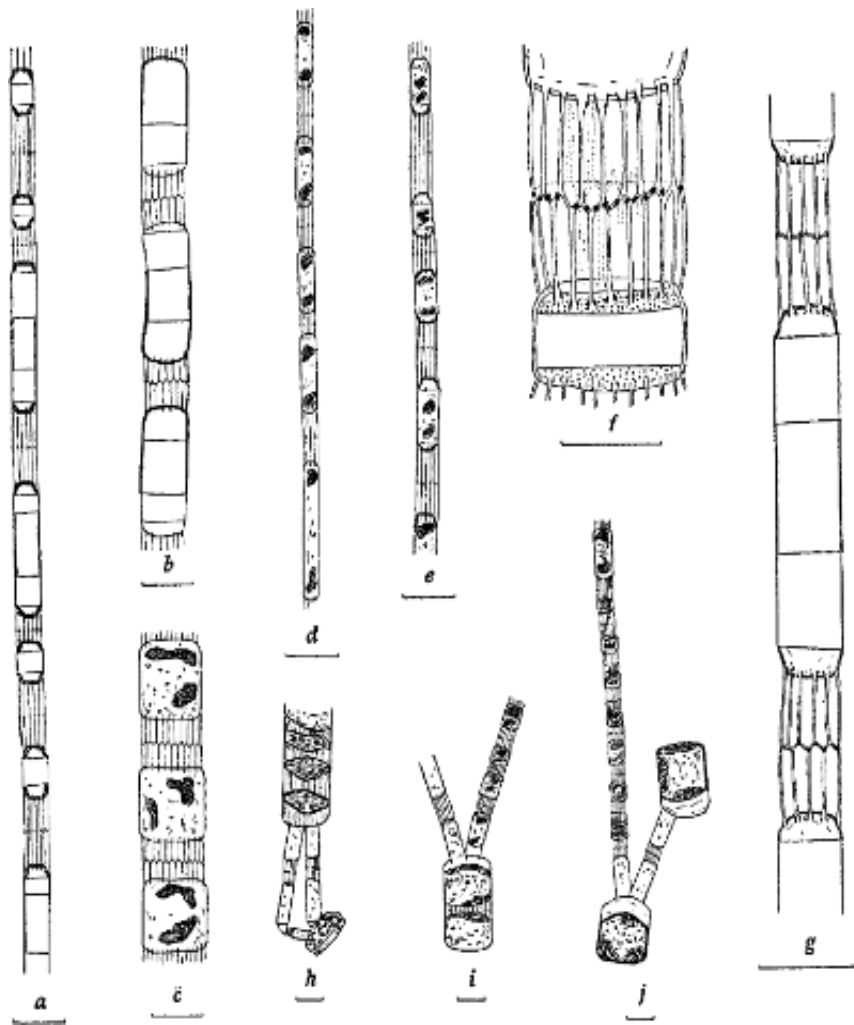

Fig. 6. *Skeletonea costatum* (Grev.) Cl. *a-g*, vegetative cells; diameters: *a*, 5μ ; *b*, 10μ ; *c*, 13μ ; *d*, 3μ ; *e*, 4μ ; *h-j*, parts of chains showing auxospore formation. Diameter of auxospores: *h*, 17μ ; *i*, 18μ ; *j*, 18μ ; diameter of ordinary cells: *h*, *i*, and *j*, 6μ .

Genus IV. COSCINOSIRA Gran

1900. *Nyt Mag. Naturvid.*, vol. 38, pt. 2, p. 115.

Cells drum-shaped to shaped to cylindrical with flat or convex valves. United in loose chains by several gelatinous threads usually of considerable length. Intercalary bands usually distinct. Valves with more or less large areolae. Marginal spinulae and unpaired marginal spines present or absent. Chromatophores numerous small round plates, lying along the valves and girdle bands.

Species: 7. *C. polychorda* (fig. 7)

7. *Coscinosira polychorda* Gran

Figure 7

1900. *Nyt Mag. Naturvid.*, vol. 38, pt. 2, p. 115.

Valves flat, $29-61\mu$ in diameter, with a single row of spines at margin. Four to nine gelatinous threads arising from pores arranged in a circle about the center, reaching the

adjacent cell and thus holding cells in chains. Distinct areolae, arranged in rows parallel to the median radius of the sectors into which the valve sculpture is divided. Cell contents dense and dark.

Neritic. North temperate species. Widely distributed. Not uncommon off southern California, but never in large numbers.

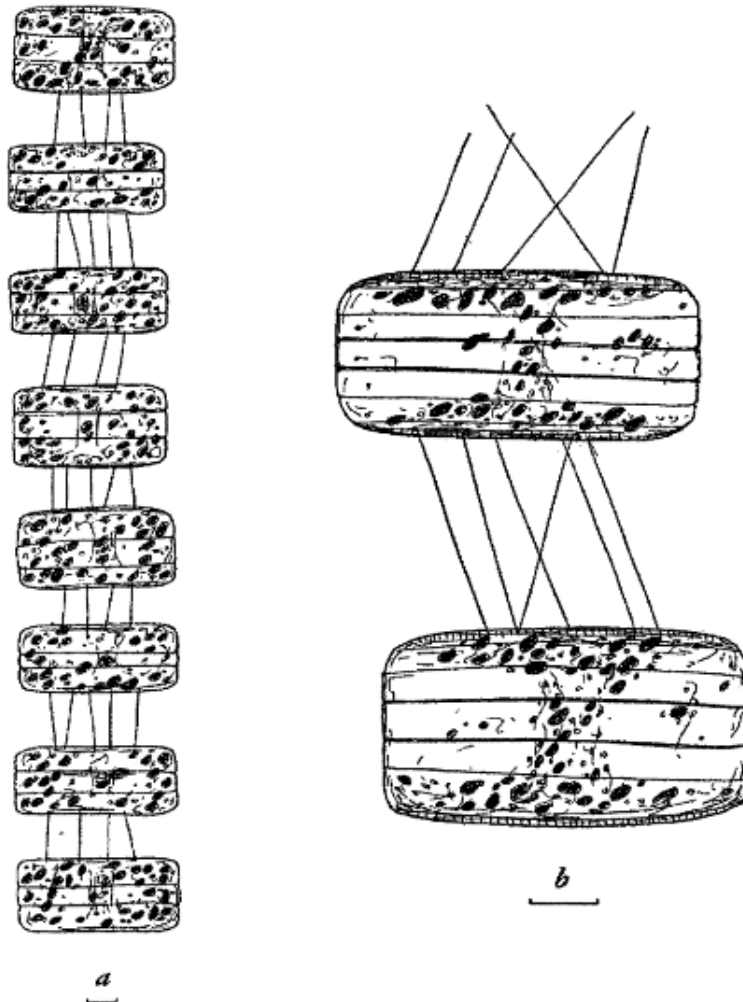

Fig. 7. *Coscinosira polychorda* Gran. *a*, chain of vegetative cells; diameter, 50μ . *b*, two cells of a chain; diameter, 61μ .

Genus V. THALASSIOSIRA Cleve

1873. Bih. Kongl. Svensk. Vet.-Akad. Handl., vol.1, no. 13, p.6.

Cells similar to those of *Coscinodiscus*, usually drum- or disk-shaped, united in flexible chains by a cytoplasmic or gelatinous thread (see fig. D, 1, *gt1*.), or living in formless gelatinous masses, or seldom solitary. One or more intercalary bands (fig. D, 1, *ib*) to each valve. Valves with areolae or delicate radial rows of punctations. Structure often difficult to see. Marginal spinulae (fig. D, 1 and 2, *sp*) or little spines present, usually distinct, sometimes with mucilage threads extruding which may be much longer than the cell itself (fig. D, 1, *gt2*). Valves rounded or flat, in a few species depressed in the center. Chromatophores numerous, small, platelike. Auxospores formed as large bladders by separation of the valves and formation of larger cells in these. Resting spores known in several species, resembling biconvex lenses, formed in regular cells.

A true planktonic genus, principally neritic and characteristically arctic. Mucilaginous

threads help adapt it for floating. Mainly inhabits cold and temperate seas. Some species not uncommon off Lower California and in Gulf of California.

Species: 8. *T. nordenskiöldii* (fig. 8)

9. *T. aestivalis* (fig. 9)

10. *T. decipiens* (fig. 10)

11. *T. gravida* (fig. 11)

12. *T. rotula* (fig. 12)

13. *T. subtilis* (fig. 13)

8. *Thalassiosira nordenskiöldii* Cleve

Figure 8

1873. Bih. Kongl. Svensk. Vet.-Akad. Handl., vol. 1, no. 13, p. 6, pl. 1, fig. 1.

Cells in girdle view octagonal, in long flexible chains. Valves circular, 14–35 μ in diameter, with conical central depression from which mucilage thread extrudes. Otherwise surface of

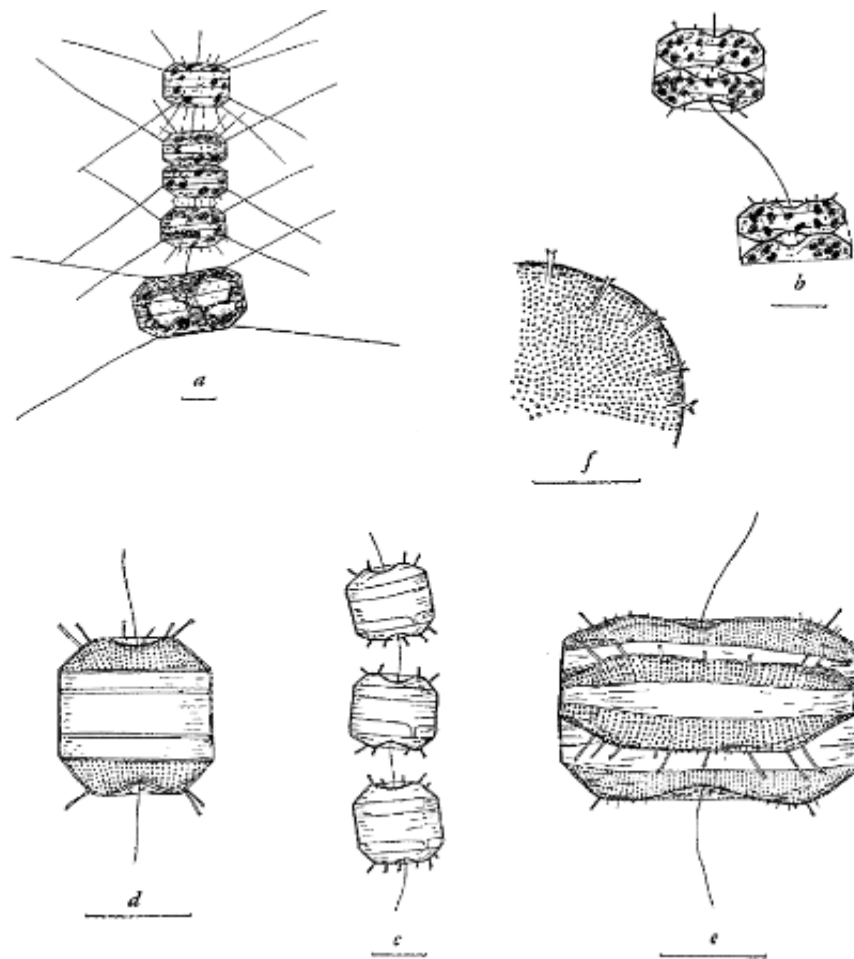

Fig. 8. *Thalassiosira nordenskiöldii* Cl. *a*, chain with an auxospore; diameter of auxospore, 33 μ ; diameter of other cells, 18 μ . *b*, vegetative cells, recently divided; diameter, 20 μ . *c*, vegetative cells; diameter, 17 μ . *d*, cell showing arrangement of sculpturing on valve mantle; diameter, 15 μ . *e*, cell containing a resting spore; diameter, 27 μ . *f*, section of valve showing sculpturing.

valve flat with beveled outer rim. Small spinulae present at junction of flat area with beveled edge of valve, directed obliquely outward, usually with long radiating mucilage threads. Chromatophores many, platelike. Sculpturing on valve very fine, 14-16 puncta in 10μ , irregular in center, in radial rows near margin. Resting spores, one in a cell, with strongly arched primary and flatter secondary valve.

Neritic. Boreal or arctic species. Reported only occasionally off southern California. Very abundant off Scotch Cap; Alaska (Cupp, 1937), especially in the last half of April and early May.

9. *Thalassiosira aestivalis* Gran and Angst

Figure 9

1931. Publ. Puget Sound Biol. Sta., Univ. Wash., vol. 7, p. 436, fig. 10.

Cells quadrangular in girdle view, not octagonal as in *T. nordenskiöldii*. With beveled corners. Radiating spinulae at inner margin. Valve flat inside the spinulae, slight conical depression around central mucilage pore. Cells $20-45\mu$ in diameter. Valve structure very fine, areolae in straight rows parallel to medial line of a relatively large number of sectors, 20-22 areolae in 10μ at margin; coarser areolae around central pore. One intercalary band at each valve. Suture between intercalary band and girdle strongly and evenly thickened around the cell; suture between intercalary band and valve only slightly thickened. Distance between cells as long as perivalvar axis of cells or longer. Easily confused with *T. nordenskiöldii* but has smaller spinulae, narrower marginal zone of valve, and greater distance between cells. (See fig. D, 1 and 2.)

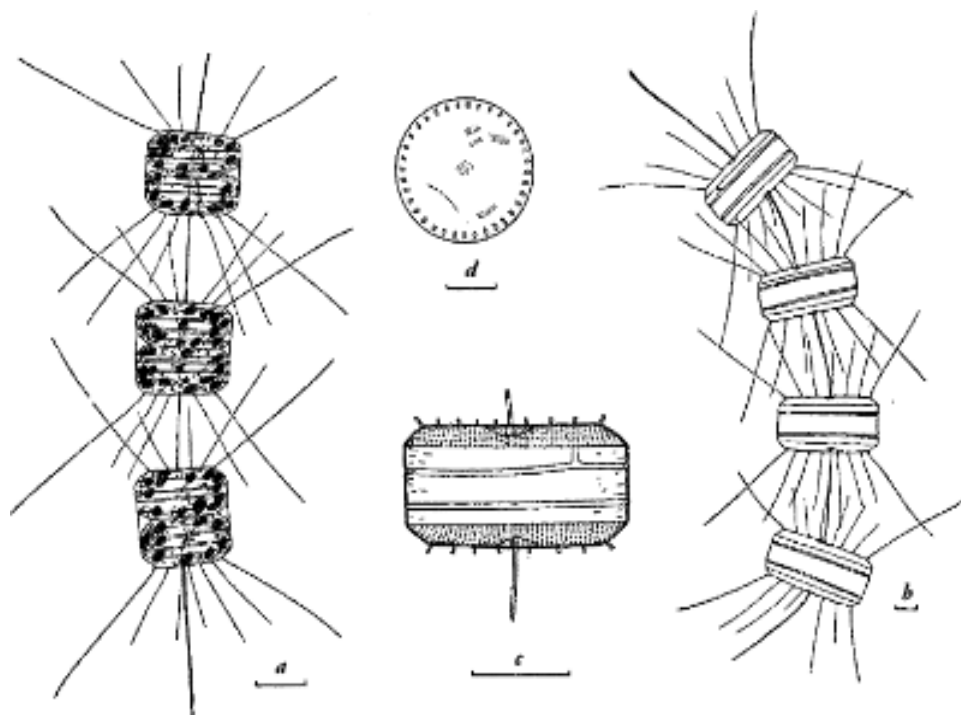

Fig. 9. *Thalassiosira aestivalis* Gran and Angst. *a*, vegetative cells showing chromatophores; diameter, 20μ . *b*, vegetative cells; diameter, 45μ . *c*, cell showing arrangement of sculpturing; diameter, 24μ . *d*, valve view of a cell; diameter, 30μ .

Neritic. Reported off southern California, but distribution in time and abundance not yet known.

10. *Thalassiosira decipiens* (Grunow) Jørgensen

Figure 10

1878. Grunow. In Schneider, Naturwiss. Beitr. Kenntn. Kaukasusländer, p. 125, pl. 4, fig. 18 (*Coscinodiscus excentricus* var. *decipiens*).

1880–85. Grunow. In V. H. Syn., pl. 91, fig. 10 (*Coscinodiscus decipiens*).

1905. Jørgensen. Hydrogr. biol. invest. Norw. fiords, p. 96, pl. 6, fig. 3.

Cells disk-shaped, united in loose chains with very long spaces between cells. Occasionally in gelatinous irregular colonies. Valves flat or slightly curved, with rounded margins. Row of strong curved marginal spines, one apiculus. Diameter of valves 21–54 μ . Sculpturing as in *Coscinodiscus excentricus* with areolae arranged in curved lines, not radiating from the center, more or less irregular near margin. Areolae 8 in 10 μ in center to 13 or 14 in 10 μ at margin. One intercalary band per valve. Chromatophores small, numerous.

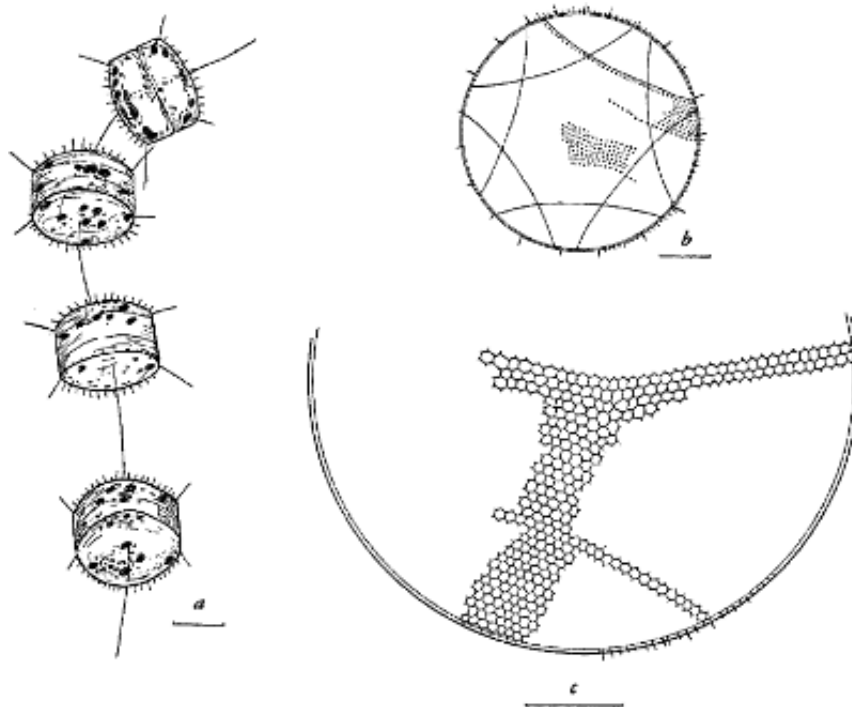

Fig. 10. *Thalassiosira decipiens* (Grun.) Jørg. a, chain of vegetative cells; diameter, 21 μ c. b, valve of a cell with arrangement of sculpturing indicated; diameter, 54 μ . c, section of same valve as in (b).

Neritic. North temperate species. Reported in Gulf of California. Present but never abundant off southern California.

11. *Thalassiosira gravida* Cleve

Figure 11

1896. Bih. Kongl. Svensk. Vet.-Akad. Handl., vol. 22, pt. 3, no. 4, p. 12, pl. 2, figs. 14–16.

Cells disk-shaped, 20–50 μ in diameter. United in close chains by a thick thread. Girdle view oblong with rounded edges. Valves flat. Marginal spines very small, arranged in several irregular rows. One larger spine or apiculus. Valve sculpturing very delicate, not visible in water, areolae in radial rows, about 20 in 10 μ , forming curved, excentric crossing rows.

Secondary rows distinct only on margin of valve. Small central area with irregular but distinct punctation. Resting spores with strongly arched valves, smooth, with coarser areolae. Auxospores not uncommon.

Neritic. Northern species, but not so northern as *T. nordenskiöldii*. Never common off California. Reported by Gran (1912) as an arctic species.

12. *Thalassiosira rotula* Meunier

Figure 12 (p.50)

1910. In Duc d'Orléans, Camp. Arct., p. 264, pl. 29, figs. 67–70.

Cells disk-shaped, united in moderately loose chains by a very thick gelatinous thread. Chains straight or slightly curved. Space between cells moderately wide. Diameter of cells 30–61 μ . Valves flat, only a little rounded at the extreme margin. Sculpturing delicate and regular. Intercalary bands, one per valve, characteristically unevenly thickened so that one side of the circle is heavier than the other (Hustedt, 1930, pp. 327–328, fig. 163). According to the interpretation of Gran and Angst (1931), it is the *suture* uniting the intercalary band with the girdle “which is strongly thickened on one side but quite thin on the other.” Chromatophores small, numerous, around the edge and along the surface of the valve. Auxospores bladderlike, formed by separation of the valves and formation of large cell between valves.

Neritic. Temperate and south temperate species. Moderately common off southern California. Present in Gulf of California and north to Scotch Cap, Alaska.

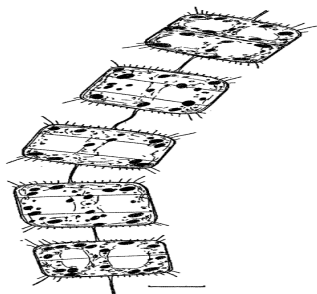

Fig. 11. *Thalassiosira gravida* Cl. Chain of vegetative cells; diameter, 27 μ .

13. *Thalassiosira subtilis* (Ostenfeld) Gran

Figure 13 (p. 51)

1899. Ostenfeld. Iagttag. Overfl. Temp., Salth. Plankt. i 1898, udgivne af Knudsen og Ostenfeld, p. 55 (*Podosira subtilis*).

1900. Gran. Nyt Mag. Naturvid., vol. 38, pt. 2, p. 117.

Cells drum-shaped or boxlike, 18–27 μ in diameter, embedded in irregular gelatinous masses. Valves rounded, with a row of very small marginal spines, not visible in water, and one larger spine or apiculus. Sculpturing very delicate, even in mounted specimens difficult to see, only in the center some distinct scattered puncta.

Oceanic. Temperate species. Not uncommon off southern California.

c) COSCINODISCINAE Schütt

1896. Bacill. in Engl.-Prantl, Nat. Pflanzenf., p. 64.

Genus VI. COSCINODISCUS Ehrenberg

1840. Phys. Abh. Akad. Wiss. Berl. 1838, p. 128.

Cells disk- or box-shaped, single or in twos immediately after cell division. (See fig. A; fig. D, 3; fig. G.) Valves circular, without large knobs or processes, with hexagonal areolae

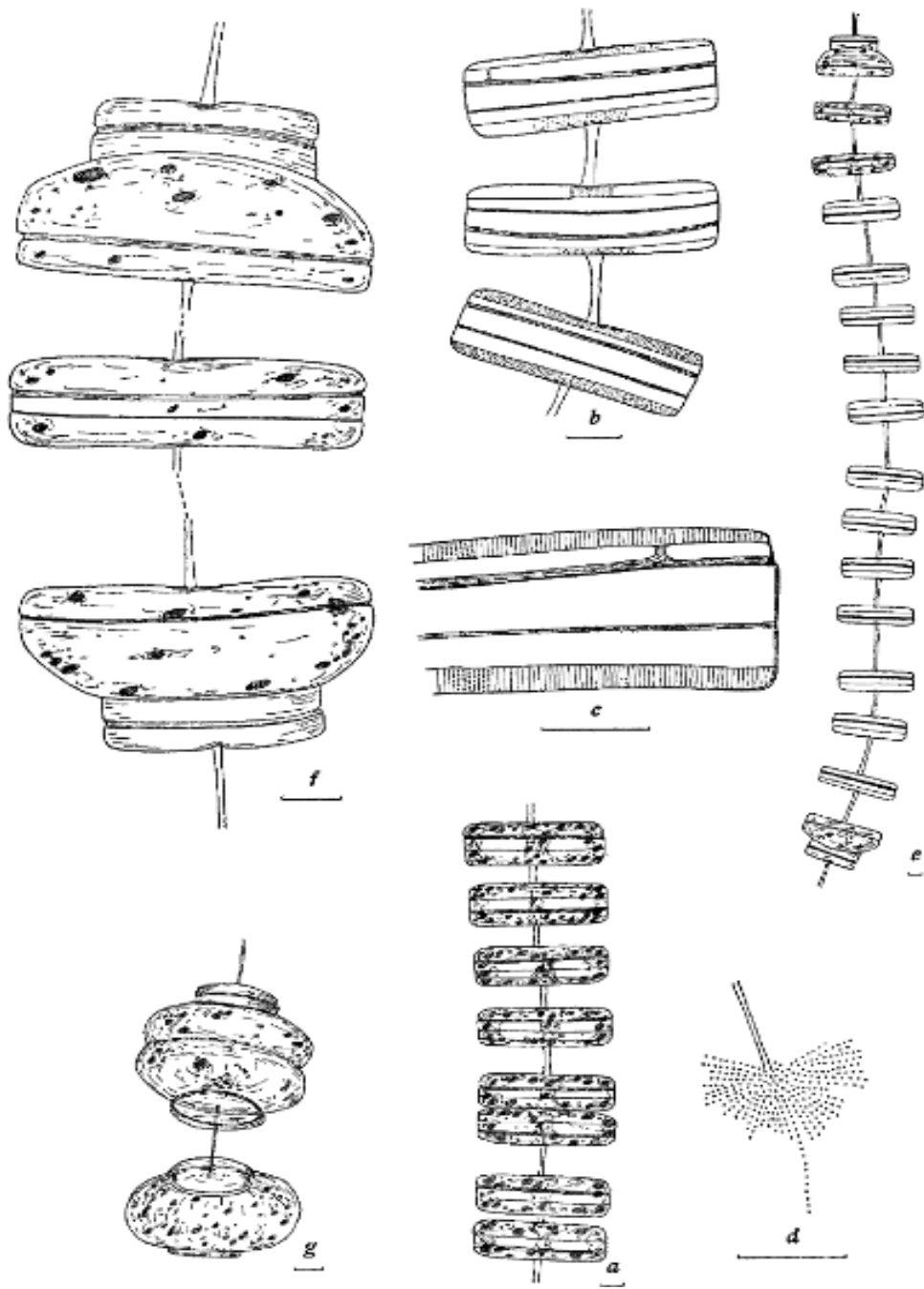

Fig. 12. *Thalassiosira rotula* Meun. *a*, chain of vegetative cells; diameter, 50μ . *b*, part of a chain with sculpturing on valve mantles indicated; diameter, 47μ . *c*, section of a cell from (*b*). *d*, section from center of valve showing connecting gelatinous thread and sculpturing. *e*, *f*, and *g*, chains showing auxospore formation. *e*, long chain formed by division of auxospores; diameter of large cells, 61μ ; diameter of small cells, 37μ . *f*, two end cells and one from near center of chain shown in (*e*). *g*, auxospores; diameter of auxospore, 60μ ; diameter of small cell, 30μ .

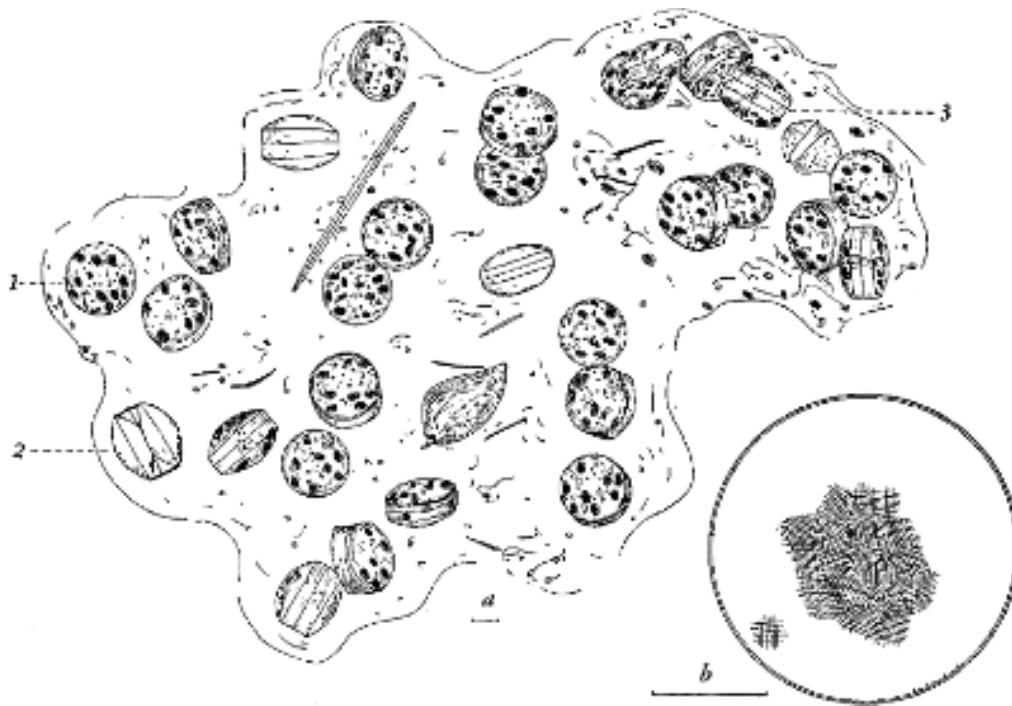

Fig. 13. *Thalassiosira subtilis* (Osten.) Gran. *a*, cells embedded in gelatinous mass: (1) valve view of a cell; (2) girdle view of recently divided cells; (3) girdle view of a cell (mass also contains dinoflagellates and another diatom). *b*, valve view of a cell with sculpturing indicated; diameter, 27μ .

(fig. G, 2 and 3) arranged in various ways or fine round puncta. In the coarser areolated forms two membrane layers are usually clearly distinguishable. These are bound together by pervalvar-directed areolae walls (fig. G, 1, *cw*). The outer layer is either smooth, at least apparently so, or more or less poroid (fig. G, 1, *m, pr*; fig. G, 2, *pr*). In this case the areolae, especially their partitions, appear to be punctated (fig. G, 2, *pr*). The inner layer has usually under each areola a larger or smaller opening toward the cell center (inside) (fig. G, 1, 3, 4, *co*). Upon examination of the valve from the outside, these openings appear to be round "central spots" in the areolae. The areolae are usually in a closed mesh system but in a number of species they are more or less rounded and do not touch one another. The center of the disk is either smooth or sculptured, often with larger areolae forming a rosette (fig. D, 3, *cr*). In some species the rosette may be present or the central area may be clear. In many species distinct but small meshes, interstitial meshes, are present at the beginning of short radial rows of areolae. These may be of systematic importance. Marginal spinulae (fig. D, 3, *sp*) present or absent, usually small and difficult to see. Apiculi, one (apiculus) or two, present or absent. If two present, apiculi are located asymmetrically at an angle of more than 90° and less than 180° on the margin (fig. D, 3, *ap*). Intercalary bands often present. Girdle zone formed of a single girdle band to each valve or of one or more collar-like intercalary bands. Chromatophores numerous small plates. Nucleus usually at center of one valve, or suspended in center of cell by protoplasmic strands. Auxospores formed by separation of the valves. A large bladderlike mass of protoplasm comes from one end. The valves may be perfectly flat, slightly or much rounded, flat or depressed in the center with rounded edges. The cell may be low (almost coin-shaped) to nearly as high as broad, or may be higher on one side than on the other. Positive identification of species in water mounts is frequently difficult because of the inability to see fine details, spinulae, and apiculi without

special preparation. A knowledge of the general contour of the valves and cell as a whole is consequently of great help in deciding upon at least a preliminary identification.

Many species are marine pelagic and form an important part of the plankton. Many are bottom forms only occasionally found in the plankton, and many are heavy, true bottom forms.

The genus *Coscinodiscus* has been divided in various ways to bring about a more logical and useful classification. Three main groups are represented in our material.

Group I. Lineati. Valves flat, usually with marginal spinulae. Areolae regular, hexagonal, in straight or curved rows running across the valve, not radiating from the center.

Species: 14. *C. excentricus* (fig. 14; pl. 1, fig. 1)

15. *C. lineatus* (fig. 15)

Group II. Fasciculati. Valves usually more or less flat. (*C. stellaris*, convex; others flat or nearly flat.) Spinulae and one or two apiculi present or absent. Areolae of the valve in more or less distinct radial sectors, with more or less independent system of parallel rows, curved or straight.

Species: 16. *C. stellaris* (fig. 16)

17. *C. curvatus* (fig. 17; pl. 1, fig. 2)

18. *C. nitidus* (fig. 18)

Group III. Radiati. Valves almost flat, convex or concave; often concave in center. Areolae of the valve radiating from the center, not distinctly divided into sectors. Rows of areolae with a tendency to dichotomous branching. Central rosette present or absent. Spinulae and apiculi present or absent.

Species: 19. *C. marginatus* (fig. 19; pl. 1, fig. 3)

20. *C. radiatus* (fig. 20; pl. 1, fig. 4)

21. *C. granii* (fig. 21)

22. *C. concinnus* (fig. 22)

23. *C. wailesii* (fig. 23)

24. *C. centralis* var. *pacifica* (fig. 24; pl. 2)

25. *C. perforatus* var. *cellulosa* (fig. 25-A; pl. 3, fig. 1)

C. perforatus var. *pavillardii* (fig. 25-B)

26. *C. oculus iridis* (fig. 26; pl. 3, fig. 2)

GROUP I. LINEATI

14. *Coscinodiscus excentricus* Ehrenberg

Figure 14; plate 1, figure 1

1841. Phys. Abh. Akad. Wiss. Berl. 1839, p. 146.

Cells disk-shaped. Diameter 50–8 μ . Valves almost flat, beveled edges, narrow margin. Spinulae arranged in irregular circle. Areolae hexagonal, arranged in slightly curved, nearly parallel rows, based on arrangement of seven divisions. Central areola with seven areolae grouped around it. Areolae 7–8 in 10 μ at center, 9–10 midway, and 10–11 near margin. Girdle zone with collarlike intercalary band and a ringlike girdle in each valve. Edges uniting the different parts of the cell wall thick and finely punctated. Valve margin fine with radial striae, 16–20 in 10 μ . Chromatophores small, numerous.

Oceanic, but often found near coast. Wide distribution. Common but never abundant off California.

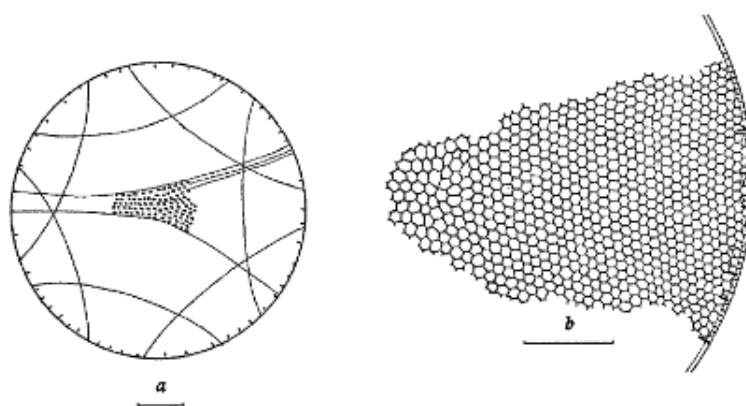

Fig. 14. *Coscinodiscus excentricus* Ehr. *a*, valve view of cell with arrangement of sculpturing indicated; diameter, 67μ . *b*, section of cell illustrated in (*a*) showing areolation.

15. *Coscinodiscus lineatus* Ehrenberg

Figure 15

1840. Phys. Abh. Akad. Wiss. Berl. 1838, p. 129.

Cell of same shape as *C. excentricus* but areolae in straight lines rather than curves. Diameter of valves $35\text{--}60\mu$. Areolae slightly smaller near margins; 6 in 10μ at center, $6\frac{1}{2}\text{--}7$ midway, and 7 at margin. Circular apertures of areolae or "chamber openings" usually distinct. Valve margin radially striated, 7–12 striae in 10μ . Marginal spinulae present and usually strong.

Chiefly oceanic but frequently neritic. Reported occasionally off California. Found in all the oceans.

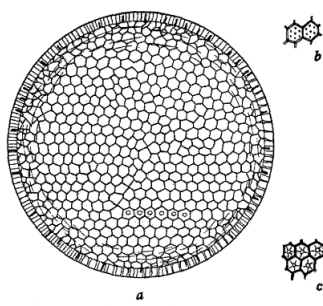

Fig. 15. *Coscinodiscus lineatus* Ehr. *a*, valve view of a cell showing areolation; diameter, 40μ (chamber openings indicated on six areolae). *b*. and *c*, sketches of areolae at two different focuses.

GROUP II. FASCICULATI

16. *Coscinodiscus stellaris* Roper

Figure 16 (p. 54)

1858. Quart. Jour. Micr. Sci., vol. 6, p. 21, pl. 3, fig. 3.

Cells with convex valves, $50\text{--}105\mu$ in diameter, thin-walled. Valve surface areolated, areolae in more or less broad radial sectors within which the middle rows are nearly parallel and tangential secondary rows are concave toward the outside. Areolae 13 in 10μ at center, 15–16 midway, and 17–20 near edge. In the center of the valve there are three to six irregular dark thickenings making a starlike formation. No spinulae or apiculi. No intercalary bands.



Fig. 16. *Coscinodiscus stellaris* Rop. *a*, section of valve of a cell (note four irregular dark thickenings in center of valve); diameter, 105μ . *b*, areolae from near center of valve at slightly different focus from (*a*).

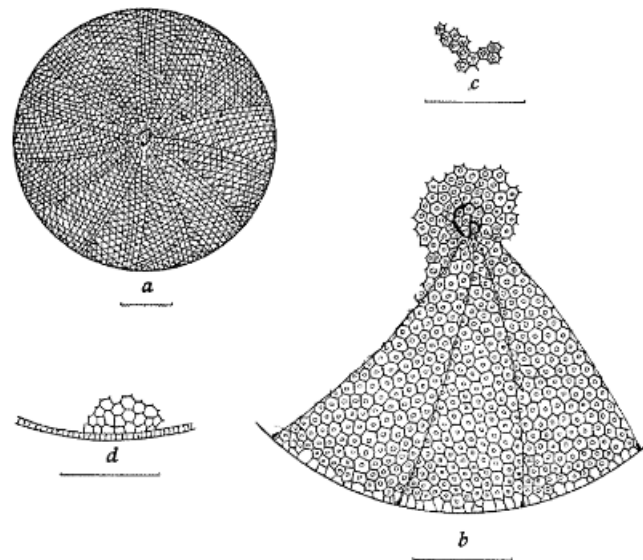

Fig. 17. *Coscinodiscus curvatulus* Grun. *a*, valve view of a cell with arrangement of sculpturing indicated; diameter, 53μ . *b*, section of valve illustrated in (*a*) showing areolae and chamber openings. *c*, areolae from near center of valve, focus slightly higher than in (*b*). *d*, detail of margin.

Oceanic. Temperate species. Rare off California. Recorded from Davis Strait, North Sea, Skaggeak, Irish Sea, Mediterranean Sea, Antarctic, and in the warm currents of the Atlantic.

17. **Coscinodiscus curvatus** Grunow

Figure 17; plate 1, figure 2

1878. In A. Schmidt, Atlas, pl. 57, fig. 33.

Valves nearly flat, 40–75 μ in diameter. Areolae rather fine but distinct. Valve surface divided into sectors bounded by curved rays, the areolae running parallel to the lateral ray of each sector. Areolae about 8 in 10 μ , nearly same size on entire valve. Central area with irregular areolae surrounded by a ringlike groove. Margin small, with short radial striae, 20–23 in 10 μ . Marginal spinulae more or less distinct, situated at the beginning of the long curved row of areolae at each sector.

Neritic. Reported occasionally off California. Found in all the oceans.

18. **Coscinodiscus nitidus** Gregory

Figure 18

1857. Trans. Roy. Soc. Edinb., vol. 21, pt. 4, p. 27, pl. 2, fig. 45.

Valves flat, 16–40 μ in diameter. Areolae free, not in closed meshwork, circular, occasionally roundish-rectangular, smaller near the margin. In some specimens a radial distribution of the areolae is apparent.

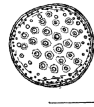

Fig. 18. *Coscinodiscus nitidus* Greg. Valve view of a cell; diameter, 16 μ .

Neritic. In coastal regions of all seas. Not common off California.

GROUP III. RADIATI

19. **Coscinodiscus marginatus** Ehrenberg

Figure 19; plate 1, figure 3

1843. Phys. Abh. Akad. Wiss. Berl. 1841, p. 142.

Cells with almost flat valves that fall off sharply at the margin. Diameter 36–97 μ ; margin 4–8 μ wide. Valves with large areolae, without central area or rosette. Areolae

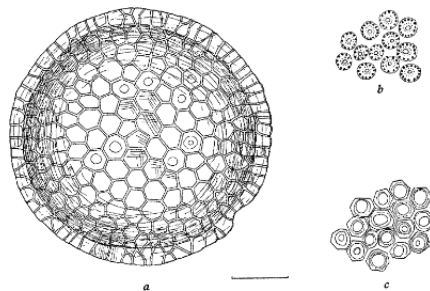

Fig. 19. *Coscinodiscus marginatus* Ehr. *a*, valve view of a cell showing arrangement of areolae; diameter, 45 μ . *b*, part of valve, focus on outer closing membrane. *c*, part of valve near center, focus slightly lower than in (*b*).

2½–3 in 10 μ in the center, 3–4 at the margin. Chamber openings distinct. Outer closing membrane of the areolae with a ring of delicate poroids, otherwise apparently homogeneous. The areolae form irregular radial rows; secondary oblique rows indistinct. In general the structure of the species is inclined toward an irregular arrangement. The margin of the valve is wide and sharply set off, with very coarse radial striae, 4–6 in 10 μ .

Of wide distribution. Found in all oceans sporadically. Not common off California. Fairly numerous in some collections taken at 46°51' north latitude, 122°06' west longitude.

20. *Coscinodiscus radiatus* Ehrenberg

Figure 20; plate 1, figure 4

1841. Phys. Abh. Akad. Wiss. Berl. 1839, p. 148, pl. 3, fig. 1, a–c.

Cells flat, coin-shaped disks. Valves flat or very slightly arched. Diameter 35–60 μ . Valve surface with coarse areolae, without rosette or central area. Areolae nearly same size on whole valve, 3–4 in 10 μ , except at margin where they are smaller, 6–7 in 10 μ . Inner chamber openings rather indistinct, outer membrane of the areolae apparently homogeneous. Radial rows usually distinct, secondary rows in spirals, not always apparent. The structure in this species tends to be irregular. Valve margin small, radially striated, 9–11 striae in 10 μ . No spinulae or apiculi. Girdle zone low. No intercalary bands.

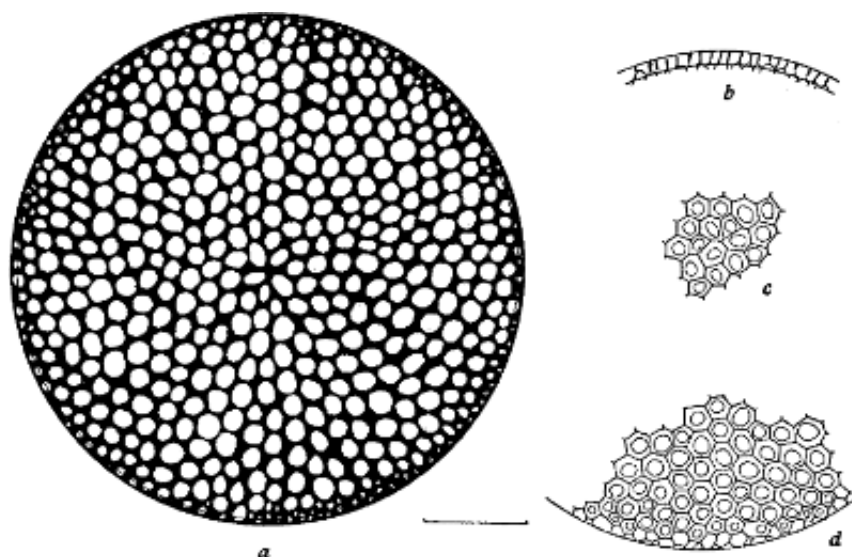

Fig. 20. *Coscinodiscus radiatus* Ehr. a, valve view; diameter, 47 μ . b, part of valve margin. c, areolae near center showing inner chamber openings. d, areolae near margin.

Oceanic and neritic. Ubiquitous. Never in large numbers off California but not uncommon. Recorded by Gran (1912) as an oceanic, temperate species.

21. *Coscinodiscus granii* Gough

Figure 21

1905. North Sea Fish. Invest. Comm. Rep. No. 2, South. Area, on Fish. and Hydrog. Invest. in the North Sea and Adjacent Waters, 1902–03, p. 338, fig. 313.

Cells with excentric arched valves, one side of cell almost twice as high as the other. Diameter 95–190 μ . Central areolae in a definite rosette. About 8 areolae in 10 μ near center, 10 midway to margin, and 11 near margin; on edge of valve mantle 13 in 10 μ . Chamber openings small, dotlike. Outer closing membrane of areolae very delicately poroid. Radial rows and secondary spiral rows distinct. Marginal spinulae and the

hyaline lines radiating from the spinulae toward the center distinct, $5-7\mu$ apart. Two small processes or apiculi on margin at distance of about 120° from each other. Girdle formed from the two similar girdle bands. No intercalary bands.

Neritic. Widely distributed. Not uncommon off California. Greatest abundance in Mission Bay near San Diego. North temperate or boreal species.

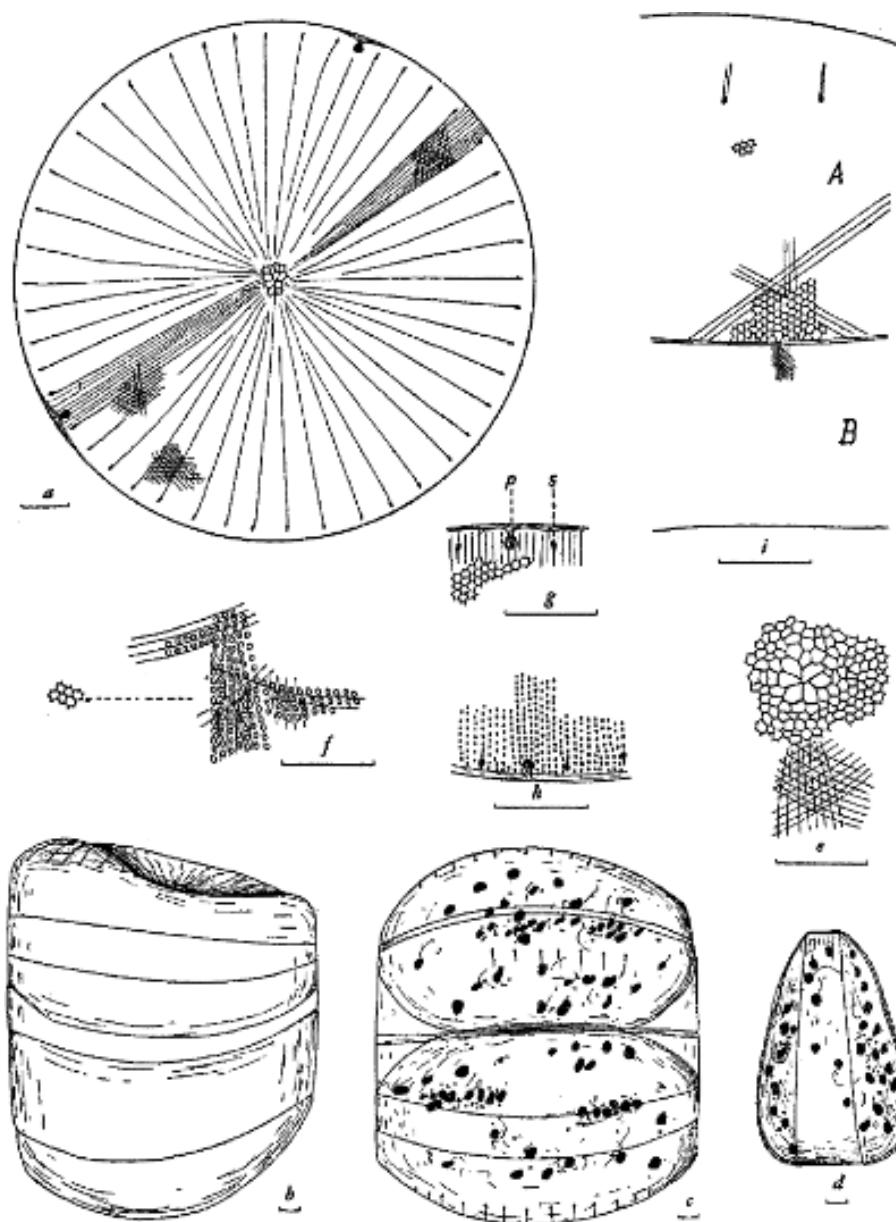

Fig. 21. *Coscinodiscus granii* Gough. *a*, valve view with arrangement of sculpturing indicated; diameter, 120μ . *b* and *c*, girdle views of same cell, recently divided; diameter, 150μ . *d*, girdle view of another cell with chromatophores showing typical shape of cell; diameter, 108μ . *e*, center rosette. *f*, areolae midway between center and margin. *g* and *h*, two views of marginal region showing small processes *p* and marginal spinulae *s*. *i*, section of valve mantle *A* and girdle *B*.

22. *Coscinodiscus concinnus* W. Smith

Figure 22

1856. Syn. Brit. Diat., vol. 2, p. 85.

Cells drum-shaped, large, with convex valves, flat or slightly concave in the center. Diameter 160–200 μ . Thin-walled, areolation delicate. Usually with a central rosette. In our specimens with a transparent central area, rosette absent entirely. Areolae 13–14 in 10 μ just outside central area, 14–15 near margin. Inner chamber openings indistinct; outer closing membrane delicately poroid. Radial rows and secondary spiral rows regular. Marginal spinulae and radiating hyaline lines distinct. Spinulae 10–12 μ apart, 5–10 μ from the margin. Two small asymmetrical processes or apiculi present. Two or more interareolar bands for each valve.

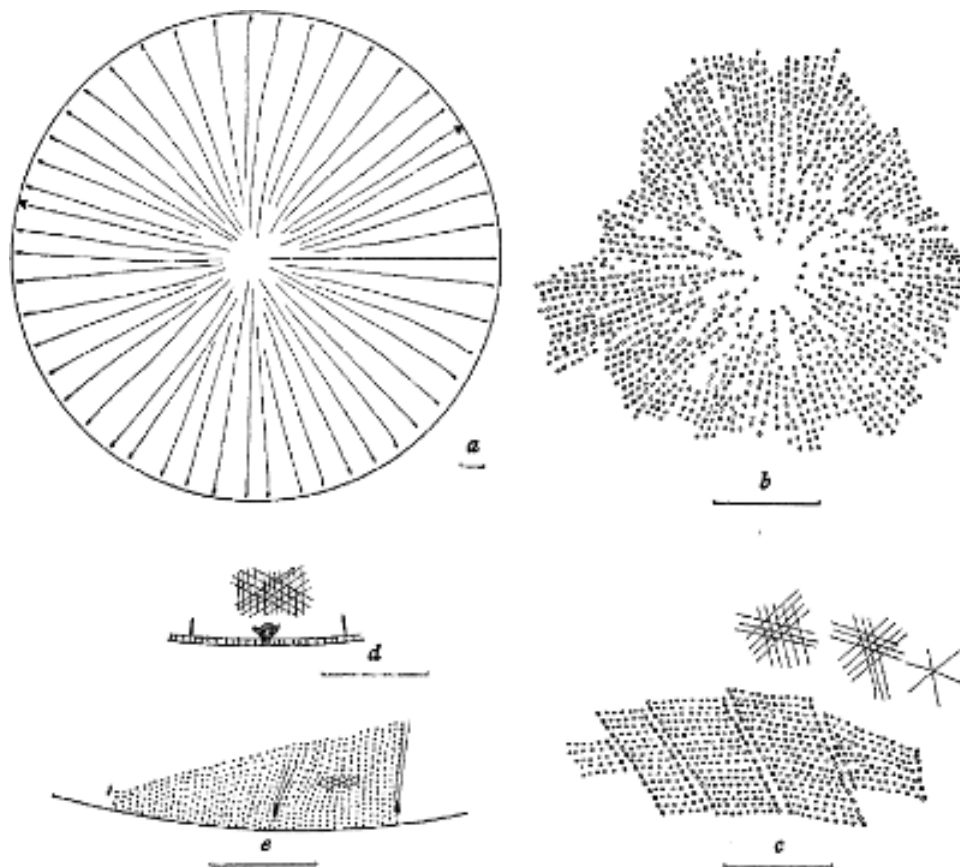

Fig. 22. *Coscinodiscus concinnus* W. Sm. *a*, valve with two asymmetrical processes, marginal spinulae, and radiating lines; diameter, 180 μ . *b*, center of valve. *c*, sculpturing midway between center and margin. *d*, margin of valve with process (apiculus). *e*, section near margin showing arrangement of sculpturing.

Neritic. Temperate species. Not common off California.

23. *Coscinodiscus wailesii* Gran and Angst

Figure 23

1931. Publ. Puget Sound Biol. Sta., Univ. Wash., vol. 7, p. 448, fig. 26.

Cells cylindrical with concave ends, large, 230–350 μ in diameter. Mantle cylindrical,

44–70 μ high. Center of valve hyaline with irregular outline and free areolae. Areolae about 6 in 10 μ , slightly increasing in size from central area outward, farther out decreasing. Outer membrane delicately poroid. Marginal spines not visible in valve view,

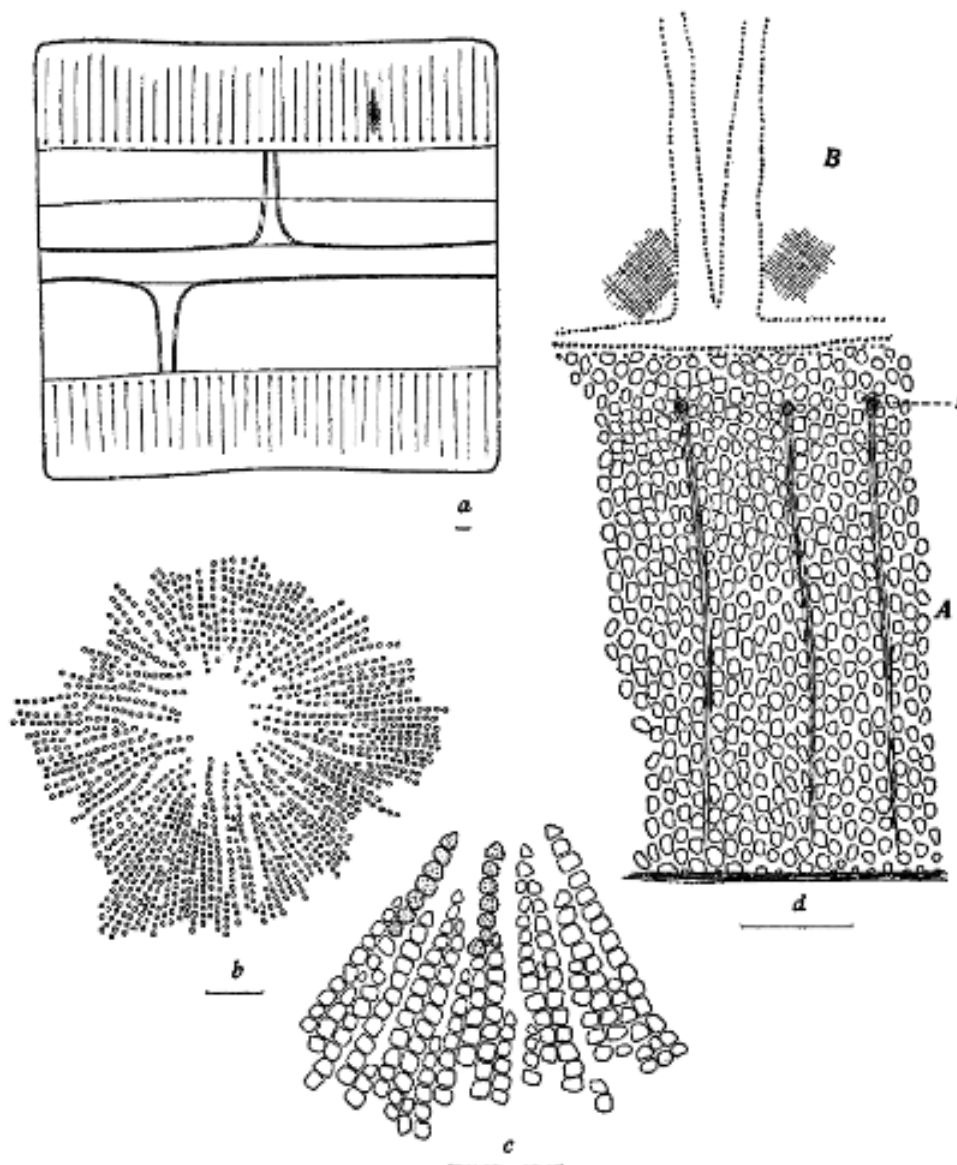

Fig. 23. *Coscinodiscus wailesii* Gran and Angst. *a*, girdle view of a cell; diameter, 350 μ . *b*, center of valve. *c*, section of center showing areolae and outer delicately poroid membrane. *d*, section of valve mantle A and girdle B, showing spinulae *s* and hyaline lines radiating from them.

3–5 μ from edge of mantle, 10–12 μ apart. Distinct hyaline lines radiate inward. Areolae of same size at both sides of spinulae, 6 in 10 μ . Intercalary bands two at each valve, first one broader than the second.

Described from Puget Sound, Washington. Not uncommon off southern California.

24. *Coscinodiscus centralis* Ehrenberg

1840. Phys. Abh. Akad. Wiss. Berl. 1838, p. 129.

Variety *pacifica* Gran and Angst

Figure 24; plate 2

1931. Publ. Puget Sound Biol. Sta., Univ. Wash., vol. 7, p. 446, fig. 23.

Valves with arched sides and nearly flat or slightly concave center. Diameter 145–260 μ . Areolae coarse, visible in water. Rosette in center of valve distinct. Areolae 3½–4

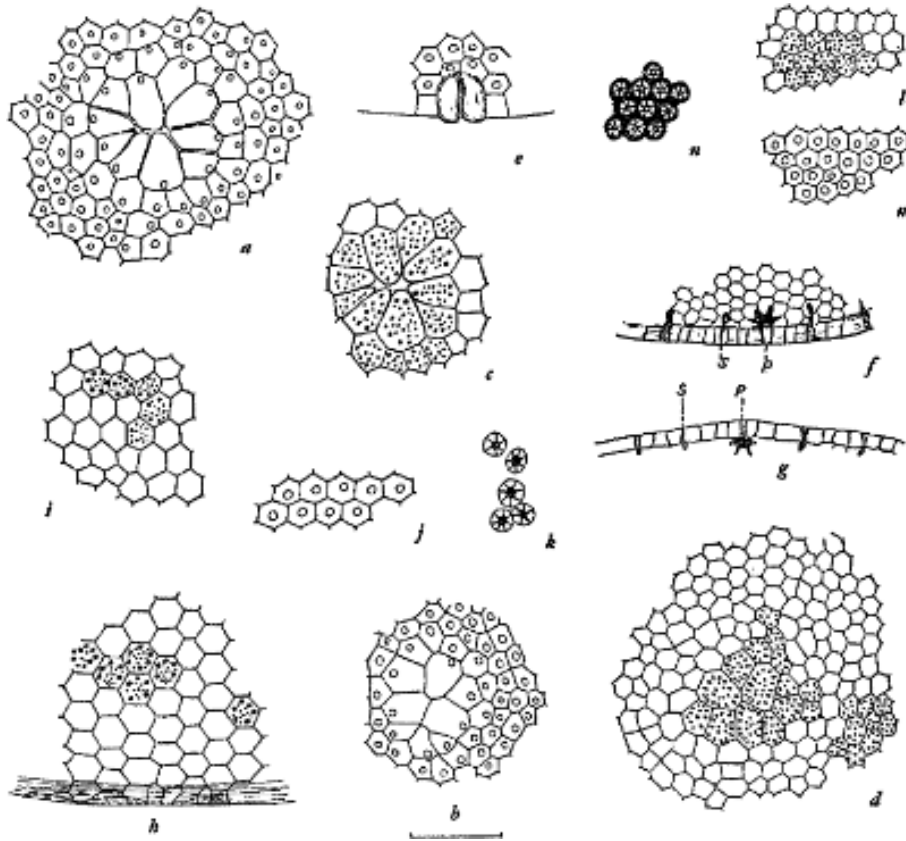

Fig. 24. *Coscinodiscus centralis* var. *pacifica* Gran and Angst. *a–d*, center rosettes of different specimens. *a* and *b*, focus on areolae and chamber openings. *c* and *d*, focus on outer poroid membrane. *e–h*, margins of several individuals. *e*, margin showing process (apiculus). *f* and *g*, margin with process (apiculus) *p*, and spinulae *s*. *h*, section near margin, focus on outer membrane. *i, j, k*, areolae midway between center and margin. *l, m, n*, areolae of another cell midway between center and margin. *i* and *l*, focus on outer membrane; *j* and *m*, focus lower, on chamber openings; *k* and *n*, focus to give starlike appearance around chamber openings.

in 10 μ near center, 4–5 midway to margin, and 5–6 near margin. Spinulae along margin 5–7 μ apart, placed a short distance in from margin. Three to four rows of areolae between spinulae. Spinulae often difficult to see in valve view. Radial lines from spinulae toward center indistinct. Two asymmetrical apiculi, sometimes difficult to see; in some specimens distinct. Two collarlike intercalary bands on each valve, the one nearer the valve broader than the other. Inner chamber openings distinct, outer membrane more or less strongly poroid. Radial rows and secondary curved rows marked. Valve margin radially striated, 6–8 striae in 10 μ . (See fig. D, 3; fig. G.)

The variety is distinguished from the type, according to Gran and Angst (1931), by the flattened center of the valve, the indistinct radiating lines from the spinulae, and the broader marginal zone outside the spinulae.

Probably oceanic. Temperate or north temperate species. Abundance not known in this region, but not uncommon north to Alaska.

25. *Coscinodiscus perforatus* Ehrenberg

1845. Ber. Akad. Wiss. Berl. 1844, p. 78.

Variety *cellulosa* Grunow

Figure 25-A; plate 3, figure 1

1884. Denkschr. Kais. Akad. Wissensch. Math.-Naturw. Kl., vol. 48, p. 75.

Valves flat or slightly convex in the center or sometimes slightly concave. Diameter 90–110 μ . Valves with large areolae forming a closed network unlike the type in which the areolae are free. Rosette present in center of valve in all individuals observed in our material. Areolae become larger from center toward middle of radius, then smaller again; 4½ in 10 μ in center, 4 midway, and 4½–5 near margin. Inner chamber openings distinct, outer closing membrane poroid especially on the margins of the areolae. Radial rows of areolae somewhat more marked than secondary spiral rows. Regular and distinct interstitial mesh placed before the inserted radial rows. Valve margin small, radially striated, striae 8 in 10 μ . Marginal spinulae indistinct, the two asymmetrical processes or apiculi small.

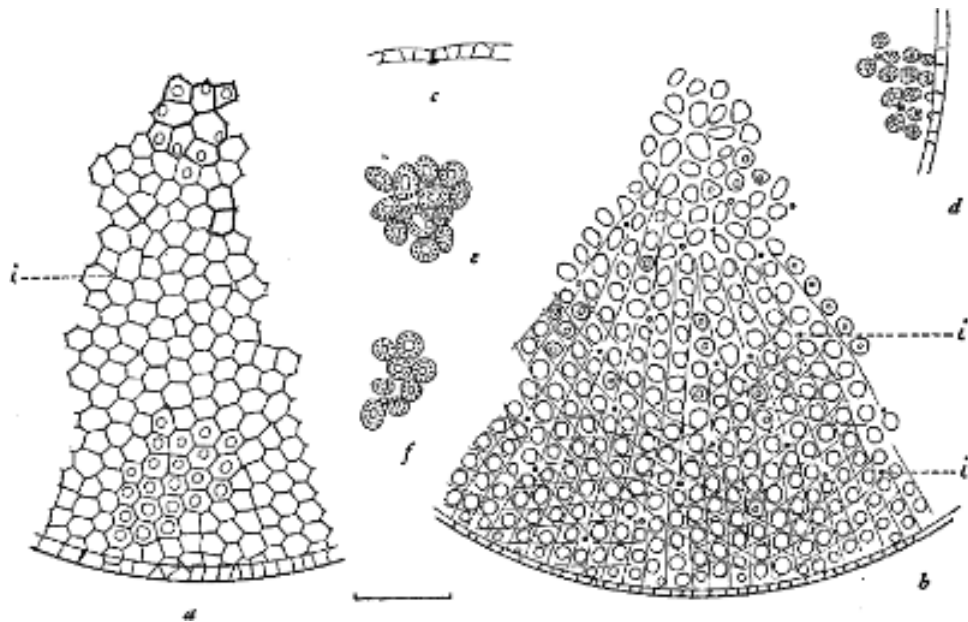

Fig. 25-A. *Coscinodiscus perforatus* var. *cellulosa* Grun. *a*, section of valve showing areolae and chamber openings; diameter, 95 μ . *b*, section of same valve, focus higher (note interstitial mesh *i*). *c*, margin with small process or apiculus. *d*, margin, focus on poroid outer membrane. *e*, areolae at center of valve, focus on poroid outer membrane. *f*, areolae midway between center and margin, focus as in (*d*) and (*e*).

Reported only rarely and so far only in Alaskan waters. Found sporadically in all European seas.

Variety **pavillardi** (Forti) Hustedt
Figure 25-B

1922. Forti. R. Comit. talass. Ital., Mem. 97, p. 124, pl. 8, fig. 143 (*Coscinodiscus pavillardi*).

1930. Hustedt. Kieselalgen, pt. 1, p. 447, fig. 247.

Similar to preceding variety except in the less regular distribution of the interstitial meshes which are not found before all the inserted radial rows of areolae. Central region varies in same material. A rosette formation was found in all specimens examined. Chamber openings distinct. Areolae $4\frac{1}{2}$ in 10μ in center, $3-3\frac{1}{2}$ midway, and 4-5 at margin. Diameter of valves $143-270\mu$. The two asymmetrical apiculi small.

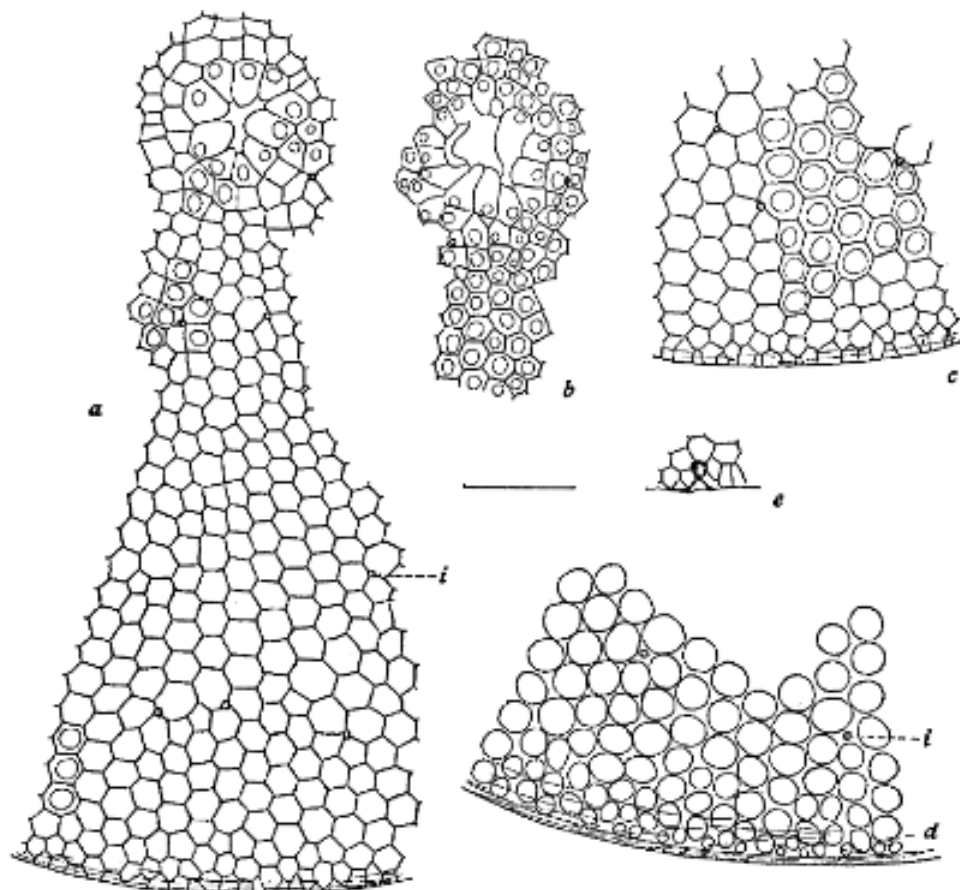

Fig. 25-B. *Coscinodiscus perforatus* var. *pavillardi* (Forti) Hust. *a*, section of valve showing areolae and interstitial mesh *i*; diameter, 143μ . *b*, center of another valve; diameter, 190μ . *c*, areolae near margin of valve shown in (*b*). *d*, same as (*c*), but focus higher. *e*, marginal process.

Abundance and distribution in this region unknown. According to Hustedt (1930), reported so far only in the Mediterranean and in the Gulf of Lion.

26. ***Coscinodiscus oculus iridis* Ehrenberg**
Figure 26; plate 3, figure 2

1841. Phys. Abh. Akad. Wiss. Berl. 1839, p.147.

Cells disk-shaped. Central part of valves slightly concave. Diameter $120-150\mu$. Areolae large. Rosette usually large, sometimes with a small central hyaline area. Areolae $3\frac{1}{2}-4\frac{1}{2}$

in 10μ near center, near marginal region $2\frac{1}{2}$ – $3\frac{1}{2}$ in 10μ . Margin small, with radial striae corresponding to the outer areolae, about 7 in 10μ . Chamber openings distinct. Outer closing membrane with delicate and scarcely visible poroids. Radial and secondary spiral rows well marked. Marginal spinulae not visible in valve view, the two asymmetrical processes small but usually distinct.

A widely distributed species. Not common off California but reported occasionally. Oceanic.

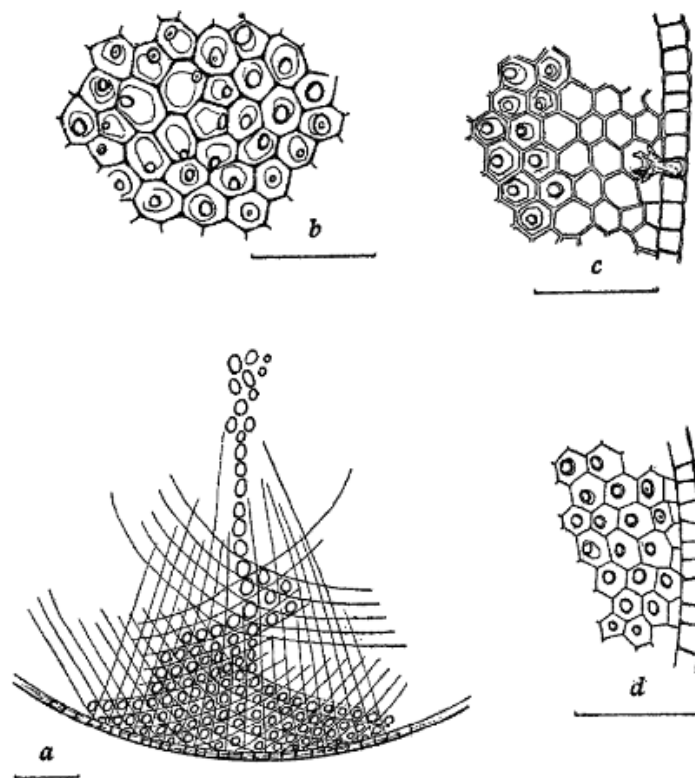

Fig. 26. *Coscinodiscus oculus iridis* Ehr. *a*, section of a valve showing arrangement of sculpturing; diameter, 138μ . *b*, center of valve. *c*, margin with marginal process as seen from inside of valve. *d*, marginal areolae with chamber openings.

Genus VII. PLANKTONIELLA Schütt

1893. Pflanzenleb. Hochsee, p. 20.

Cells single, disk-shaped, with a hyaline winglike expansion all around consisting of extra-cellular chambers strengthened by radial rays. The winglike expansion weakly siliceous, an organ of flotation. Valves areolated like those of *Coscinodiscus excentricus*. Chromatophores numerous small plates which lie along the valve surface.

Species: 27. *P. sol* (fig. 27)

27. *Planktoniella sol* (Wallich) Schütt

Figure 27 (p. 64)

1860. Wallich. Trans. Micr. Soc., N.S., vol. 8, p. 38, figs. 1, 2 (*Coscinodiscus sol*).

1893. Schütt. Pflanzenleb. Hochsee, p. 20, fig. 8.

Valves nearly flat with a structure like that in *Coscinodiscus excentricus*. Cells disk-shaped. Areolae 5–7 in 10μ in center of valve, 7–8 midway to margin, and 8–9 near margin. Central disk varies in diameter from 21 to 81μ , entire cell from 50 to 165μ . According to Karsten (1907, p. 514, pl. 39, figs. 1–11), only one valve of the cell is provided with the wings, so upon division one daughter cell has none. Few wingless cells have been observed, however,

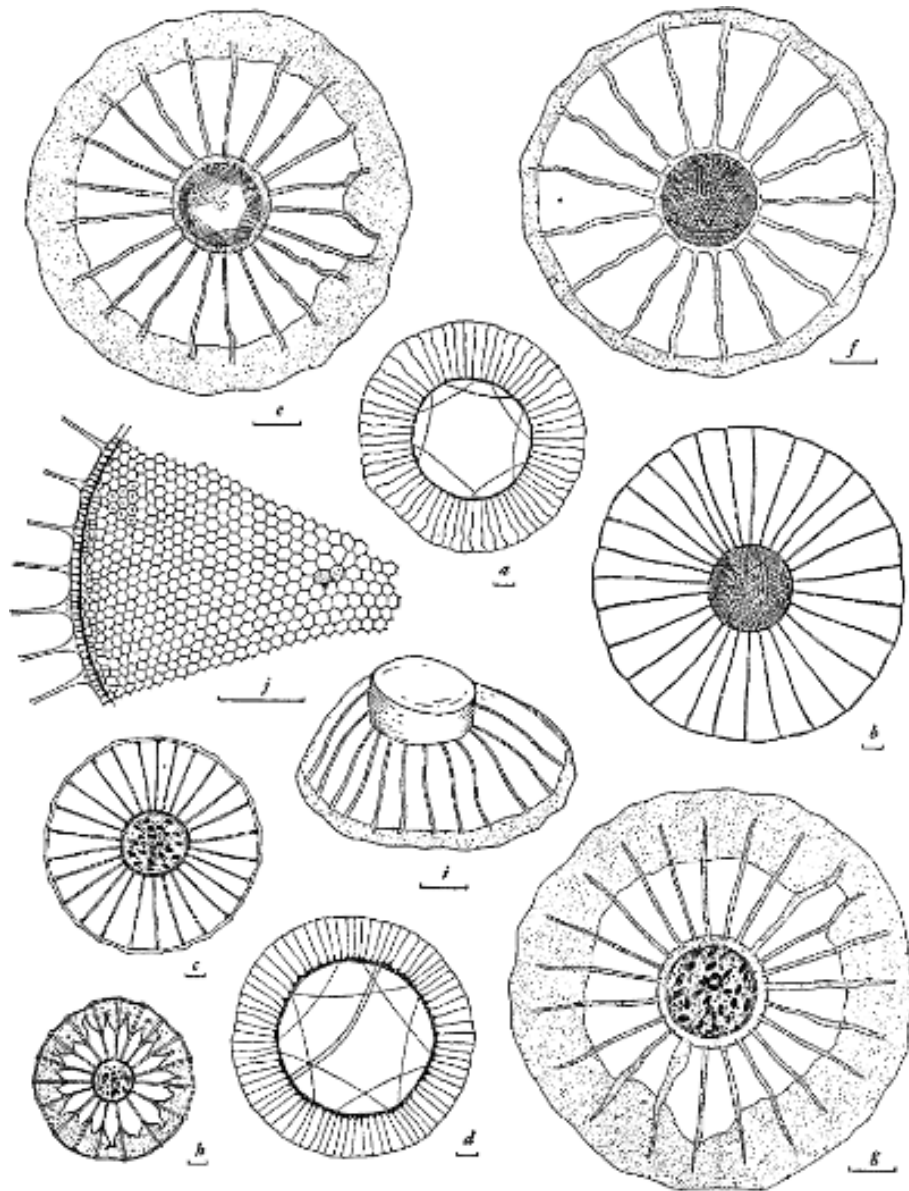

Fig. 27. *Planktoniella sol* (Wall.) Schütt. *a-h*, valve views of various cells. *a*, diameter of entire cell, 113μ ; of center, 61μ . *b*, diameter, 158μ ; of center, 40μ . *c*, diameter, 110μ ; of center, 34μ (note chromatophores). *d*, diameter, 123μ ; of center, 81μ . *e-i*, cells in process of throwing off old wing-expansion. *e*, diameter, 85μ ; of center, 22μ . *f*, diameter, 85μ ; of center, 24μ . *g*, diameter, 95μ ; of center, 28μ . *h*, diameter, 85μ ; of center, 21μ . *i*, semiside or girdle view. *j*, section of valve showing areolae.

perhaps because they sink rapidly, because they are not distinguishable from *Coscinodiscus excentricus*, or because new wings are produced rapidly. Figure 27, *e-i* shows cells in the process of throwing off the old wing-expansion.

Oceanic. Probably living near the bottom. Widely distributed but most common in subtropical or tropical seas. Not uncommon off southern California and in Gulf of California.

2. ACTINODISCEAE Schütt

1896. Bacill. in Engl.-Prantl, Nat. Pflanzenf., p. 68.

a) STICTODISCINAE Schütt

1896. Bacill. in Engl.-Prantl, Nat. Pflanzenf., p. 68.

Genus VIII. **ARACHNOIDISCUS** Ehrenberg1849. *Hemiptychus Ehrenberg*, Ber. Akad. Wiss. Berl. 1848, p. 7.

1850. Ber. Akad. Wiss. Berl. 1849, p. 64.

Cells disk-shaped with circular outline and almost flat valves, slightly concave in the center. Valves with a circular central area and with a strong framework of spokelike ribs or rays on the inside. The ribs run from the margin toward the center, ending a short distance from the center and are there joined together by a fine membrane. Between

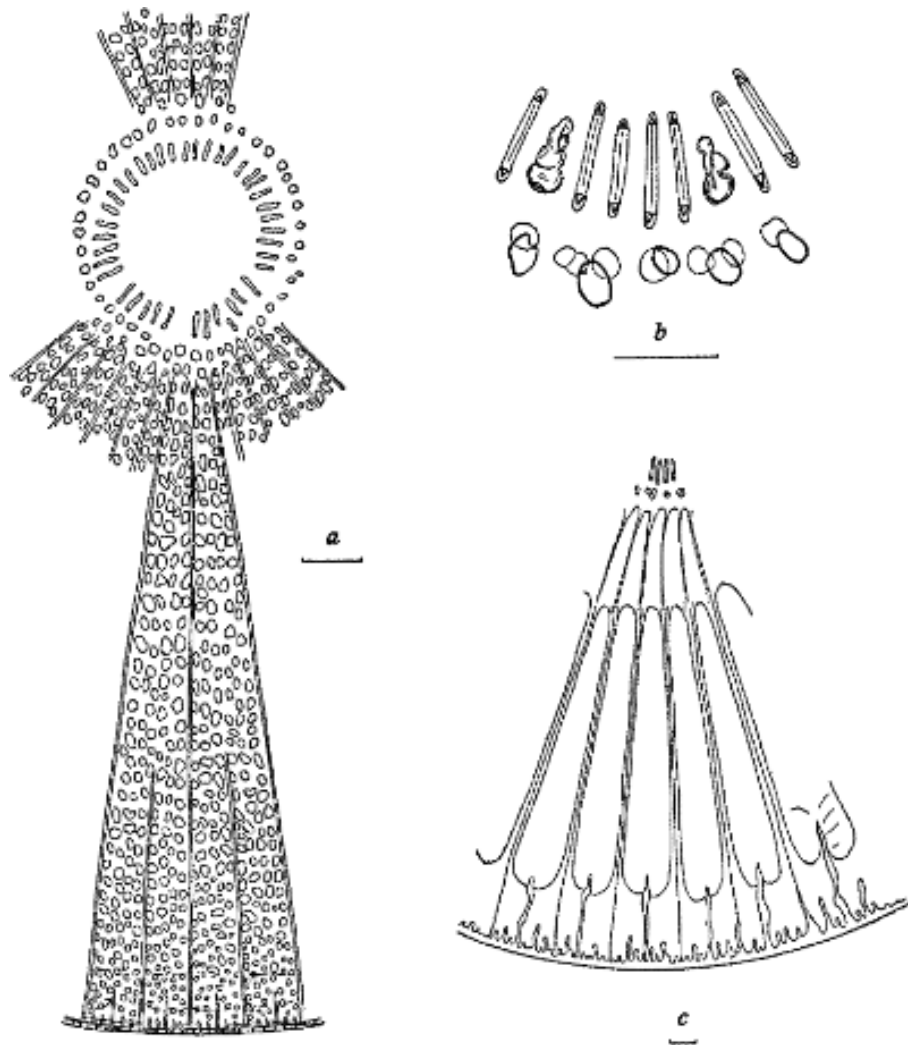

Fig. 28. *Arachnoidiscus ehrenbergii* Bail. *a*, section of a valve; diameter, 310μ . *b*, section of center of valve showing elongated areolae and round ones just outside center as seen from the inner side of the valve. *c*, chambers of the valve from the inner side, same individual as shown in (*b*); diameter, 390μ .

these main rays are more or less short marginal ribs, the shortest forming a chambered ring along the valve margin. In addition to the stronger ribs on the inner side of the outer membrane layer there is a delicate network of tangential and radial thickenings or ribs that in connection with the larger ribs give the valve the appearance of a spider web. The unthickened parts of the membrane, areolae, appear to be more or less poroid. The valve center is distinguished by a special structure.

Species: 28. *A. ehrenbergii* (fig. 28; pl. 4, fig. 1)

28. **Arachnoidiscus ehrenbergii** Bailey

Figure 28; plate 4, figure 1

1850. In Ehrenberg, Ber. Akad. Wiss. Berl. 1849, p. 63.

Cells disk-shaped with flat, in the center slightly concave, valves, 150–390 μ in diameter. Valve surface divided into wedge-shaped sectors by strong radial ribs. Central clear field, 25–45 μ in diameter. Short inserted marginal ribs form a chambered ring 10–14 μ in width along the valve edge. Outer layer of cell wall provided with a fine network of concentric-tangential and radial lines. The entire disk surface, except a more or less wide, often very small hyaline region within the margin and the central field, regularly areolated. The areolae are roundish-angular, decreasing only slightly in size toward the outside and form, except on the outmost part of the valve where the areolae are somewhat irregular, very regular concentric rings and radial rows. Sometimes because of the imperfect formation of the network, the areolae run more or less into one another. The areolae are delicately poroid. The structure of the central field is very variable. Usually there is an outer concentric row of round areolae, and inside these a ring of elongated radial areolae often wedge-shaped from the outside toward the center. The outmost valve margin has coarse radial striae, 5–7 in 10 μ .

Littoral on algae. Found occasionally in the plankton.

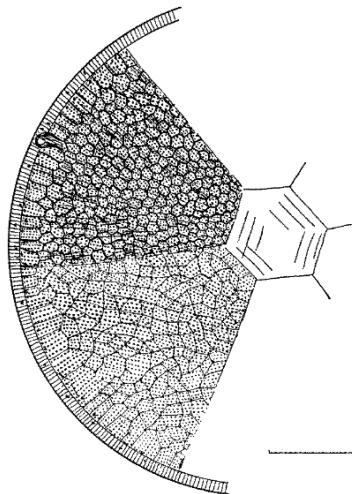

Fig. 29. *Actinoptychus undulatus* (Bail.) Ralfs. Section of valve showing sculpturing on two of the six sectors; diameter, 58 μ .

b) ACTINOPTYCHINAE Schütt

1896. Bacill. in Engl.-Prantl, Nat. Pflanzenf., p. 72.

Genus IX. **ACTINOPTYCHUS** Ehrenberg

1843. Phys. Abh. Akad. Wiss. Berl. 1841, pp. 400, 409, pl. 1, I, fig. 27; III, fig. 22.

Cells disk-shaped, single. Valves divided into sectors which are alternately raised and depressed. Smooth central area. No intercalary bands. Cell wall usually of several layers, the individual membranes punctated—the puncta in crossing lines—and more or less strongly areolated. The areolation is strongest on the outer layer, on the inner membrane often entirely lacking. On outer margin of the sectors, often only on the raised ones, seldom displaced toward the cell center, one or more clawlike processes that

communicate with the inner cell by a pore canal. Valve margin more or less wide and often with numerous marginal spinulae.

All species are marine, preferably living on the coast, often found in the plankton.

Species: 29. *A. undulatus* (fig. 29; pl. 5, fig. 1)

30. *A. splendens* (fig. 30; pl. 5, fig. 2)

29. *Actinoptychus undulatus* (Bailey) Ralfs

Figure 29; plate 5, figure 1

1842. Bailey. Amer. Jour. Sci., vol. 42, pl. 2, fig. 11 (*Actinocyclus undulatus*).

1861. Ralfs. In Pritchard, Infus., p. 839, pl. 5, fig. 88.

Cells disk-shaped with six radial sectors, alternate sectors not in same plane as others. Diameter 40–85 μ . Central smooth field, hexagonal. The raised sectors (seldom all sectors) with a short, blunt process in the middle of the inner edge of the margin, strongly areolated and punctated. Areolae about 7 in 10 μ , toward the outside of the cell in fairly regular parallel radial rows, toward the center irregular. Puncta in more or less regular, crossing oblique lines, 16–18 in 10 μ . The sunken or depressed sectors usually without a process, usually in place of areolae only weakly marked dots that are bound together by a network of delicate lines. Punctuation coarser, radial striation less striking, oblique rows stronger, 13–14 in 10 μ . Valve margin narrow, faintly striated. Numerous small spines on outer part of valve and valve margin. Chromatophores numerous.

Neritic. Bottom form. Frequently found in the plankton. Of very wide distribution.

30. *Actinoptychus splendens* (Shadbolt) Ralfs

Figure 30; plate 5, figure 2

1854. Shadbolt. Trans. Micr. Soc., N.S., vol. 2, p. 16 (*Actinosphaenia splendens*).

1861. Ralfs. In Pritchard, Infus., p. 840.

Cells disk-shaped, single or in irregular colonies. Valves radially undulate, 70–100 μ in diameter. Valves with 10–20 sectors (in the specimen illustrated, 20 sectors); central space nearly circular or star-shaped, hyaline. Areolations of all sectors in most individuals faint, but may be robust. The raised sectors with a spatulate process in the middle of the outer margin from which a more or less sharply marked, structureless hyaline line runs toward the inner end of the sector. The depressed sectors with a slight swelling in place of the processes, without hyaline line but with a hyaline bracket-shaped region the entire width of the sector just in front of the margin. Punctuation on all sectors similar; the puncta in decussating oblique rows and parallel radial rows, 11–14 puncta in 10 μ . Valve margin narrow, with delicate radial striae.

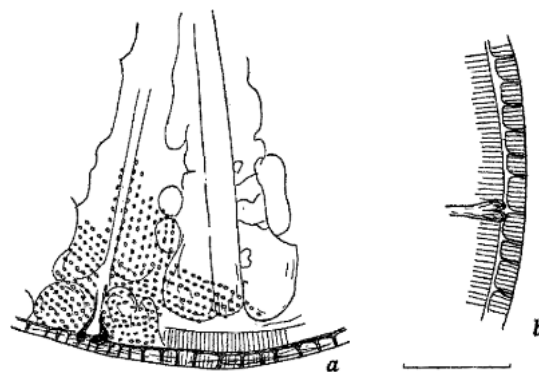

Fig. 30. *Actinoptychus splendens* (Shad.) Ralfs. *a*, section of valve near margin; diameter of entire valve, 85 μ . *b*, section of margin. Both (*a*) and (*b*) show spatulate process.

Neritic, littoral. Found occasionally in the plankton. Not common off southern California. North or south temperate species.

c) ASTEROLAMPRINAE Schütt

1896. Bacill. in Engl.-Prantl, Nat. Pflanzenf., p. 74.

Genus X. **ASTEROLAMPRA** Ehrenberg

1845. Ber. Akad. Wiss. Berl. 1844, pp. 73, 76.

Cells disk-shaped sharply divided into sectors by broad hyaline rays running from the hyaline center toward the margin. Rays all of same width and generally tapering to the margin, outer ends with a minute spine. Hyaline center divided into more or less wedge-shaped divisions. Fine areolation between rays. Central area either reticulated or divided by straight lines into the same number of parts as the rays.

Species: 31. *A. marylandica* (fig. 31)31. **Asterolampra marylandica** Ehrenberg

Figure 31

1845. Ber. Akad. Wiss. Berl. 1844, p. 76, fig. 10.

Cells disk-shaped with hourglasslike arched valves, 31–122 μ in diameter. Valves with large, hyaline middle region, at least one-third the diameter of valve, divided into six or seven sectors. Six or seven narrow, hyaline rays of like size and structure running from central region almost to edge of valve, with a short process on the outer end. Segments between rays regularly areolated, with areolae in three-line system. In small specimen shown in figure 31, a, there were 16–17 areolae in 10 μ along hyaline center, 18 near margin of cell.

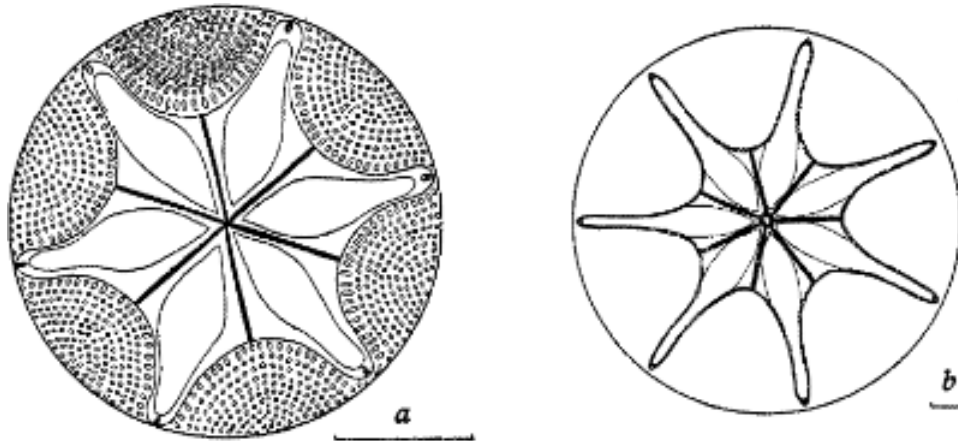

Fig. 31. *Asterolampra marylandica* Ehr. a, valve view of individual with six sectors showing areolae; diameter, 31 μ . b, valve view of cell with seven sectors; diameter, 122 μ .

Oceanic. Tropical species. Very rare in plankton collections off southern California.

Genus XI. **ASTEROMPHALUS** Ehrenberg

1845. Ber. Akad. Wiss. Berl. 1844, pp. 198, 200.

Cells single, disk-shaped, with circular or slightly ovoid outline. Valves flat, with radial undulations. Areolated with a central smooth region and smooth radial rays running from the central smooth area to the margin. Rays raised above plane of the valve more as they progress outward. One ray narrower than others. Girdle zone undulating, following the rays and depressions between them. Chromatophores numerous, often arranged in rays.

Species: 32. *A. heptactis* (fig. 32)

32. *Asteromphalus heptactis* (Brébisson) Ralfs

Figure 32

1857. Brébisson. Bull. Soc. Linn. Normandie, vol. 2, p. 296, pl. 3, fig. 2 (*Spantangidium heptactis*).

1861. Ralfs. In Pritchard, Infus., p. 838, pl. 8, fig. 21.

Usually seven rays of unequal length, the narrow ray somewhat longer than the others. Central field slightly excentric, one-fourth to one-third the diameter of cell. Diameter of cells 38–100 μ . Areolae rather large, 6 or 6½ in 10 μ .

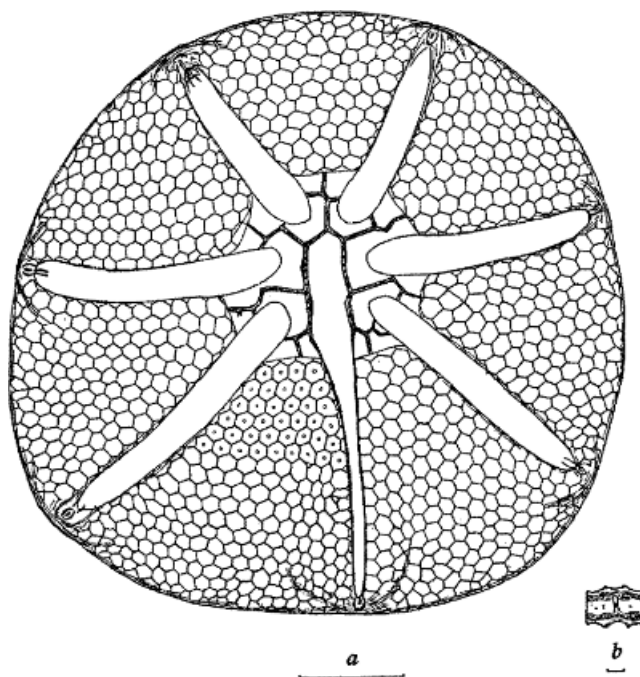

Fig. 32. *Asteromphalus heptactis* (Bréb.) Ralfs. a, valve view; diameter, 58 μ . b, girdle view; diameter, 48 μ .

Oceanic. Temperate species. Occasionally found in large numbers off California but usually not numerous. Reported from Scotch Cap, Alaska (Cupp, 1937), and from Gulf of California (Cupp and Allen, 1938).

3. EUPODISCEAE Schütt

1896. Bacill. in Engl.-Prantl, Nat. Pflanzenf., p. 76.

a) AULACODISCINAE Schütt

1896. Bacill. in Engl.-Prantl, Nat. Pflanzenf., p. 76.

Genus XII. AULACODISCUS Ehrenberg

1845. Ber. Akad. Wiss. Berl. 1844, p. 73.

Cells discoid or box-shaped. Valves with a circular outline, flat or slightly lower in the middle or convex, with four or more conical processes symmetrically arranged near the margin. Areolated. Intercalary bands present. Chromatophores small, numerous.

Species: 33. *A. kittoni* (fig. 33; pl, fig. 2)

33. *Aulacodiscus kittoni* Arnott

Figure 33; plate 4, figure 2

1861. In Pritchard, Infus., p. 844, pl. 8, fig. 24.

Cells box-shaped, with strong radial undulated valves, 60–85 μ in diameter. Valves strongly areolated, the areolae 4 1/2–5 in 10 μ , slightly larger in the center to form a rosette. Areolae in radial and excentric rows, on the margin 6 1/2–7 radial rows in 10 μ . Process in valve view broad—semicircular with a crescent-shaped widening on the outer side, on the base with a long commalike marking and on either side of this marking a lobe-shaped appendage, on the outer side bounded by strong dark concentric lines. In girdle view the processes are short. Usually four elevated regions and four processes (may be up to eight, very seldom less than four). On the crest of the elevated regions run two parallel regular rows of areolae that widen in front of the processes to a relatively large hyaline area.

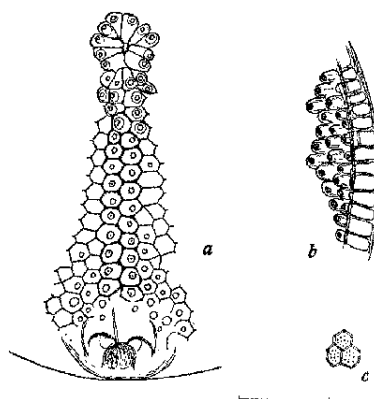

Fig. 33. *Aulacodiscus kittoni* Arn. a, section of valve showing center rosette and marginal process; diameter, 70 μ . b, margin. c, three areolae from midway between center and margin.

Littoral. Occasionally in plankton. Not common off southern California.

II. SOLENOIDEAE Schütt

1896. Bacill. in Engl.-Prantl, Nat. Pflanzenf., p. 82.

4. SOLENIIDAE Schütt

1896. Bacill. in Engl.-Prantl, Nat. Pflanzenf., p. 82.

a) LAUDERIINAE Schütt

1896. Bacill. in Engl.-Prantl, Nat. Pflanzenf., p. 82.

Genus XIII. **CORETHRON** Castracane

1886. Diat. Chall.-Exped., p. 85.

Cells living singly. Cylindrical with rounded valves having a crown of long thin spines or setae at the margin directed outward at an angle. Numerous intercalary bands, scalelike, often very indistinct. Cell wall delicate, weakly siliceous. Chromatophores numerous, small.

Species: 34. *C. hystrix* (figs. 34-A, 34-B, 34-C)

34. *Corethron hystrix* Hensen

Figure 34-A; figure 34-B; figure 34-C

1887. Ber. Komm. wissensch. Untersuch. deutsch. Meere, Kiel, p. 89, pl. 5, fig. 49.

Cells with cylindrical mantle and arched hemispherical valves. Diameter 12–38 μ . In individuals with auxospores (fig. 34-C, a–e), old cells varied from 13 to 24 μ in diameter, auxospores from 33 to 38 μ . Circle of long slender setae at edge of valve. After cell division, while setae are enclosed within the girdle zone, they are parallel to the perivalvar axis. When free, on one valve all radiate out in same direction from center of cell; on other

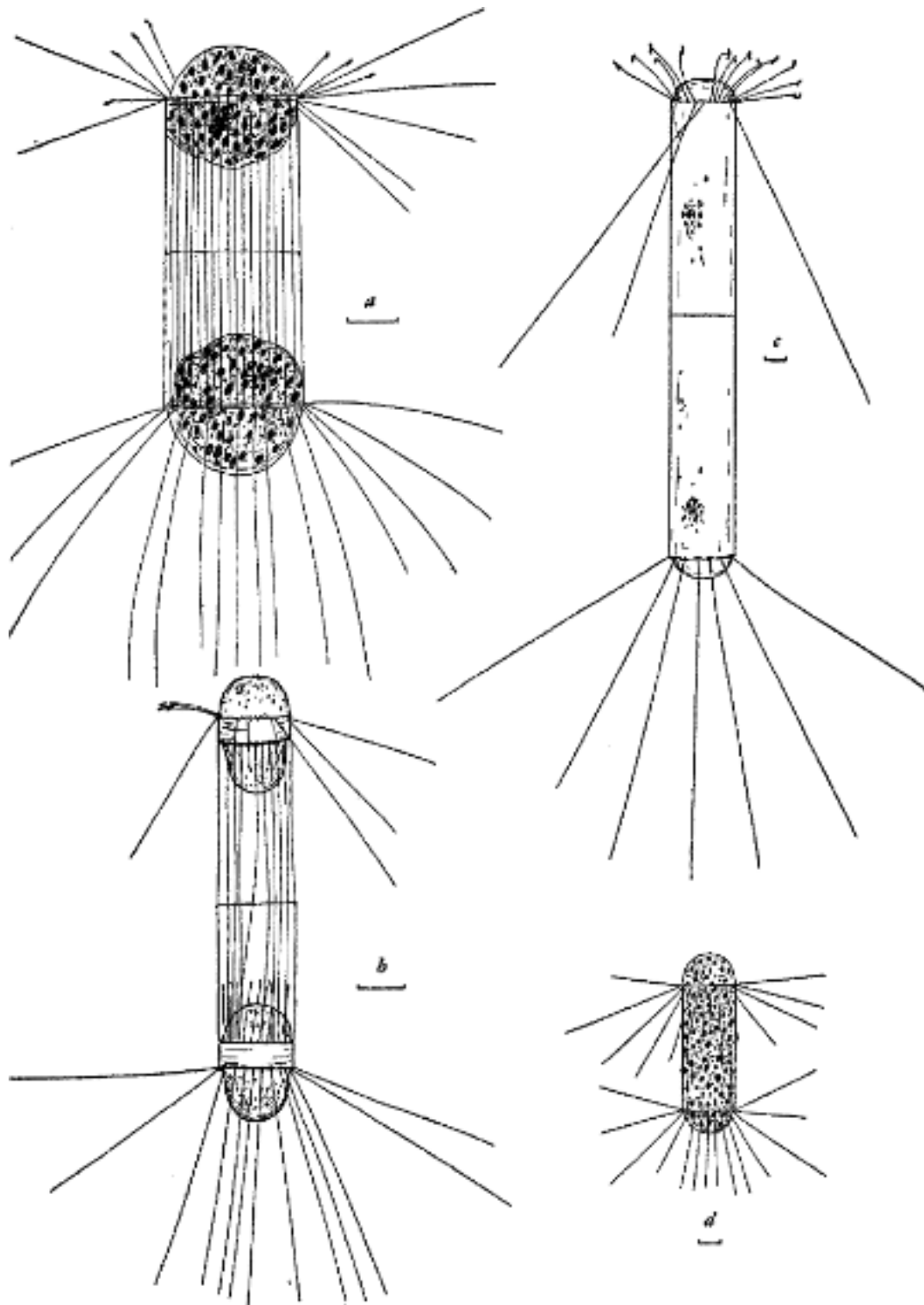

Fig. 34-A. *Corethron hystrix* Hen. *a*, dividing cell; diameter, 30μ . *b*, dividing cell; diameter, 17μ . *c*, cell; diameter, 32μ . *d*, cell with chromatophores; diameter, 24μ .

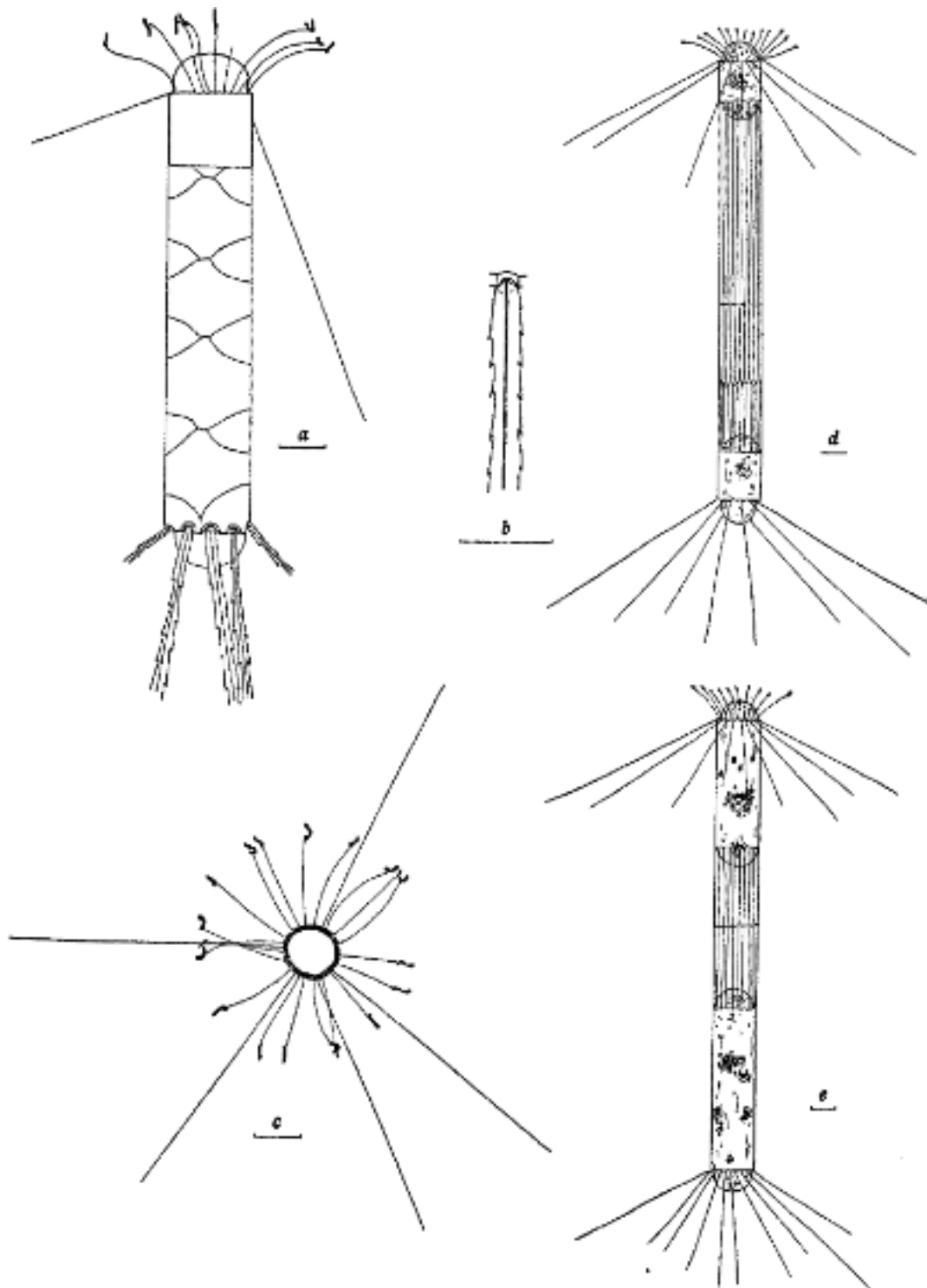

Fig. 34-B. *Corethron hystrix* Hen. *a*, cell showing intercalary bands; diameter, 19μ . *b*, part of seta from (*a*). *c*, valve view of cell; diameter, 12μ . *d* and *e*, two dividing cells; diameters, 18 and 19μ respectively.

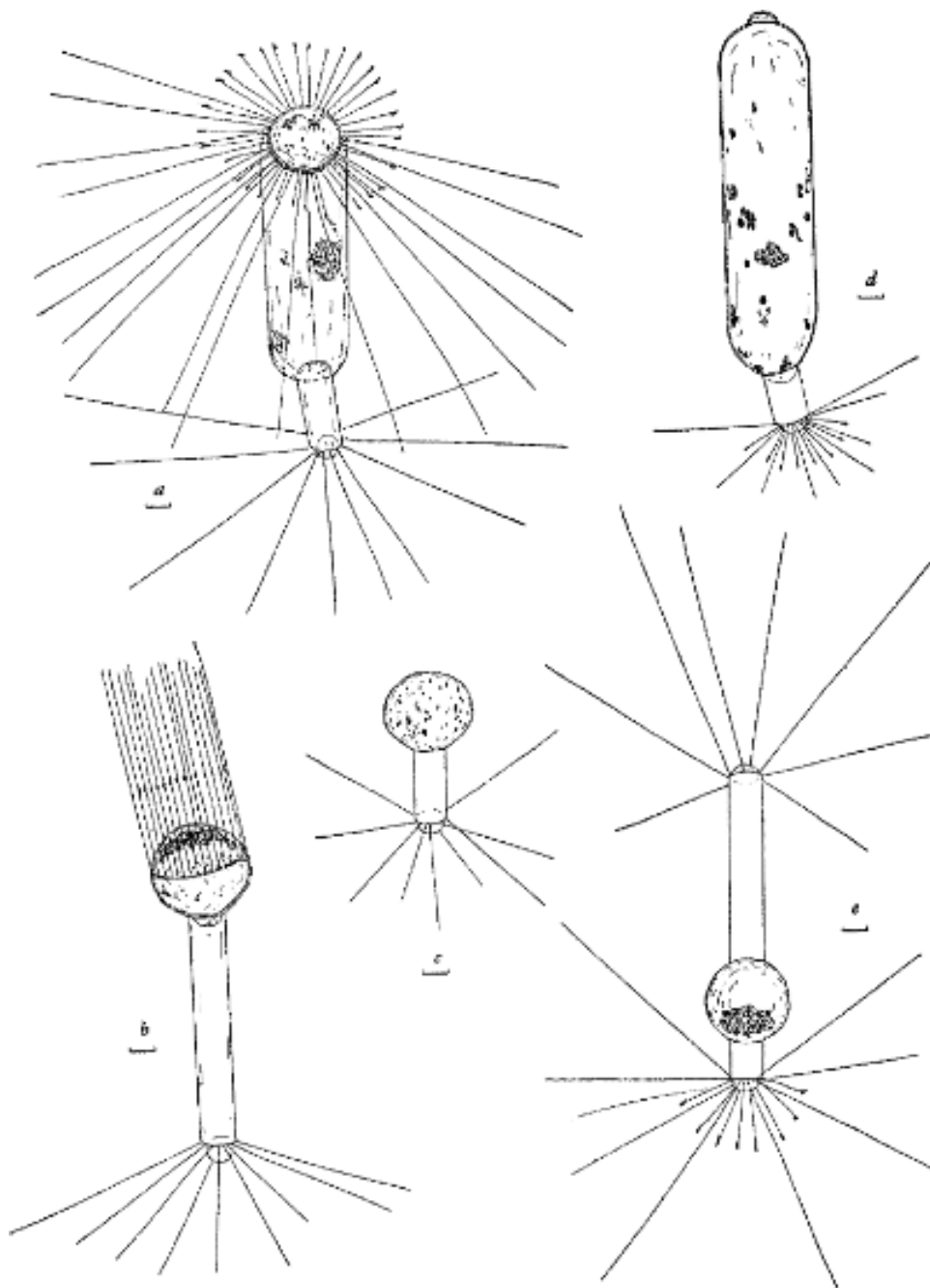

Fig. 34-C. *Corethron hystrix* Hen. *a-e*, cells with auxospores; diameters of auxospore and of original cell: *a*, 33 μ , 14 μ ; *b*, 38 μ , 14 μ ; *c*, 37 μ , 13 μ ; *d*, 36 μ , 16 μ ; *e*, 33 μ , 15 μ .

valve two types of setae are formed, longer ones of uniform width and approximately parallel to those of the first valve, and shorter ones ending in an irregularly twisted knob. These shorter ones radiate forward. Intercalary bands not usually visible in water, collarlike. Chromatophores numerous round or slightly elongated plates. Closely related

to the Antarctic species *C. criophilum* (*C. valdiviae*). Hustedt (1930) distinguished them, but according to Gran and Angst (1931), the question of their identity is still unsettled.

Oceanic. Fairly common off California, in Gulf of California, and north to Scotch Cap, Alaska. Never in large numbers. North temperate species.

Genus XIV. **LAUDERIA** Cleve

1873. Bih. Kongl. Svensk. Vet.-Akad. Handl., vol. 1, no. 11, p. 8.

Cells cylindrical. Valves rounded. Cells united in straight chains by very fine gelatinous threads, cells either touching or separated. An unpaired, oblique, outwardly directed apiculus on each valve, and numerous very small spinulae (see fig. C, 7, *sp*) or slime canals at the margin and over most of the surface. Center of valve slightly concave. Intercalary bands numerous, collarlike, more or less conspicuous (fig. C, 7, *ib*). Chromatophores numerous small plates. Nucleus more or less central, in a cytoplasmic cord which binds the central parts of the valves together. Although the cell wall is thin, it has a distinct structure. The valve surface is radially striated, the mantle surface of the intercalary bands delicately areolated.

Species: 35. *L. borealis* (fig. 35)

35. **Lauderia borealis** Gran

Figure 35

1900. Nyt Mag. Naturvid., vol. 38, p. 110, pl. 9, figs. 5–9.

Cells in thick, straight chains, touching by their valve surfaces. Valves slightly concave in the center, rounded at the margins. Marginal spinulae straight with gelatinous straight, radiating, longer or shorter threads, the longer reaching the adjacent cell. A single unpaired spine, thicker and more robust than the others, occurs near the margin of the valve. Diameter of cells 28–47 μ . Intercalary bands, as in general the entire cell wall, comparatively delicate,

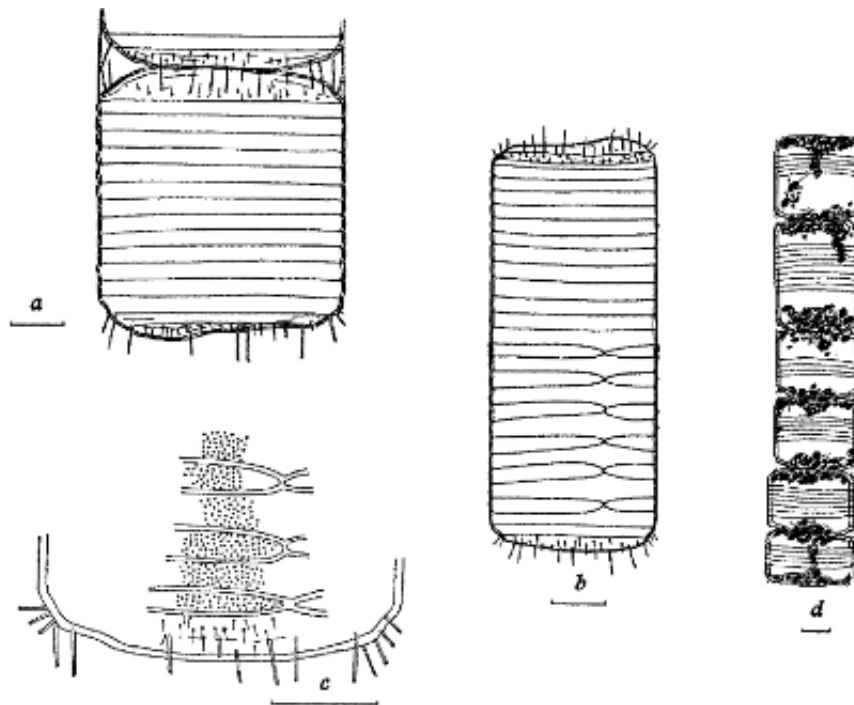

Fig. 35. *Lauderia borealis* Gran. *a*, cell shortly after division; diameter, 47 μ . *b*, cell (note intercalary bands); diameter, 31 μ . *c*, part of cell illustrated in (*b*) showing sculpturing on intercalary bands. *d*, chain with chromatophores grouped at ends of cells; diameter, 30 μ .

indistinct in water except in older cells or on older valve. Mantle surface delicately areolated-punctated, puncta in irregular rows. Intercalary bands with about 16 puncta in 10μ , irregularly arranged. No resting spores known. Chromatophores small, lobed, grouped at ends of cell in strong light.

Neritic. Temperate species. Common but not abundant off California. Reported in Gulf of California and north to Scotch Cap, Alaska.

Genus XV. **SCHRÖDERELLA** Pavillard

1913. Bull. Soc. Bot. France, vol. 60, p. 126.

Cells cylindrical with slightly convex valves, somewhat concave in the center. Chains straight. Cells sometimes occurring singly. Distinct spine in the depression in center of valve which joins spine belonging to adjacent cell. Margin surrounded by a row of small spinulae from each of which arise two gelatinous threads. These diverge and join the corresponding

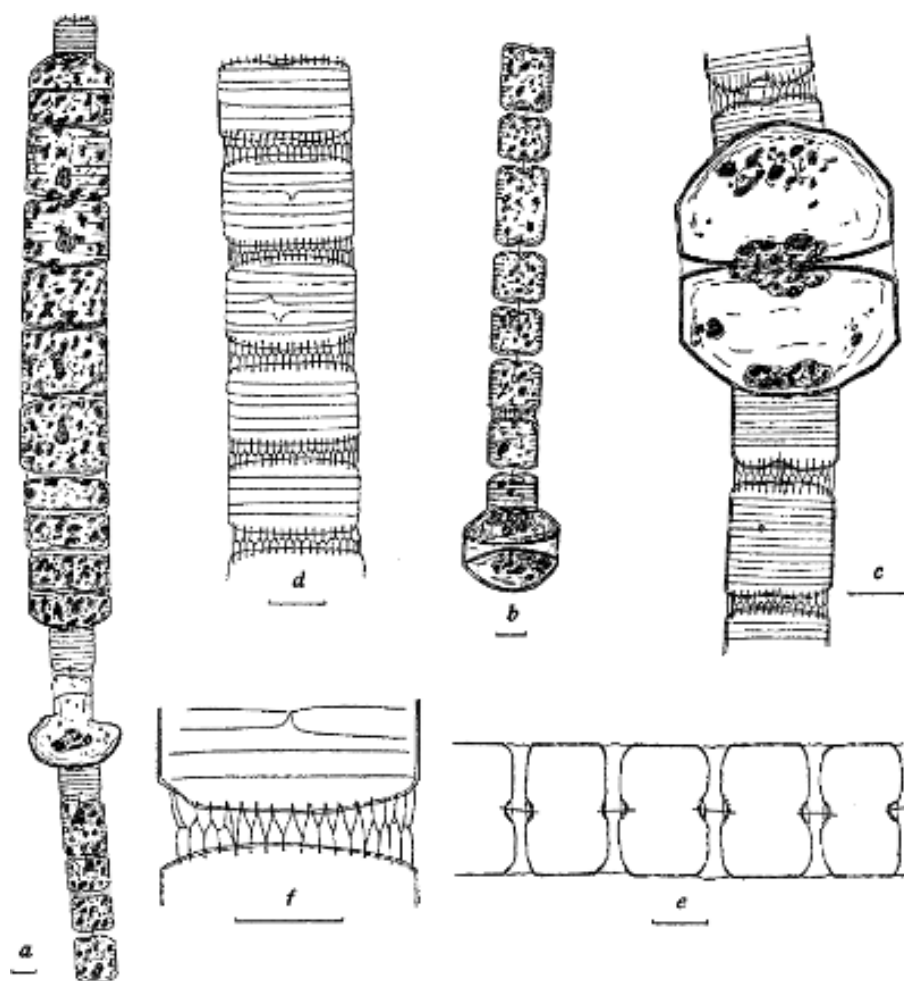

Fig. 36. *Schröderella delicatula* (H. Pér.) Pav. *a*, chain containing large cells formed by division of the auxospore and normal cells; diameter of large cells, 34μ ; diameter of small cells, 17μ . *b*, chain with auxospore; diameter of auxospore, 34μ ; diameter of chain, 18μ . *c*, part of chain with dividing auxospore; diameter of auxospore, 42μ ; diameter of other cells, 20μ . *d*, chain showing intercalary bands and method of chain formation; diameter, 24μ . *e*, same chain as in (*d*), but shown in optical focus (note spines in center depressions). *f*, ends of two cells shown in (*d*) and (*e*) exhibiting zigzag arrangement of connecting threads.

thread of the next cell, thus forming a characteristic zigzag. Sometimes the threads either are straight or appear to be straight. Intercalary bands numerous, forming incomplete hoops. Very small puncta on the bands. Chromatophores small plates, strongly slit, usually with four straight ends. Auxospores elliptical, single, lying in the girdle-band zone, and much greater in diameter than the mother cell. After the first divisions of the auxospore, the colony often still hangs together so that a chain may contain groups of both large and small cells (fig. 36, a). Resting spores also one in a cell but have the same diameter.

Species: 36. *S. delicatula* (fig. 36)

36. **Schröderella delicatula** (H. Péragallo) Pavillard

Figure 36

1888. H. Péragallo. Bull. Soc. Hist. Nat. Toulouse, vol. 22, p. 81, pl. 6, fig. 46 (*Lauderia delicatula*).

1913. Pavillard. Bull. Soc. Bot. France, vol. 60, p. 126.

Cells cylindrical. Valves more or less convex, sometimes almost flat, always with a depression in the middle. Diameter 16–42 μ . Cells bound in straight, more or less stiff or loose chains. Intercalary bands collarlike, varying greatly in number. Mantle surface of the cell delicately areolated, 18–20 areolae in 10 μ , sometimes very difficult to see, arranged in a two-line system with the lines crossing each other. Marginal spines or threads 7–8 in 10 μ . Resting spores and auxospores unknown.

Neritic. Distribution and abundance uncertain because of confusion with *Lauderia borealis*. Known to be fairly common off southern California and in Gulf of California.

Genus XVI. **DACTYLIOSOLEN** Castracane

1886. Diat. Chall.-Exped., p. 75.

Cells cylindrical, living singly or united in long, stiff, closed chains by the flat valve surfaces. Valves circular, without noticeable spines or processes, on the margin sometimes with indistinct little nodules. Intercalary bands numerous, half-collar-shaped, somewhat spirally twisted and with their wedge-shaped thin ends fitting together in a toothlike manner (see fig. C, 6, *ib*). Mantle surface with fine or coarse areolae. The ends of the intercalary bands do not always lie in an even line in the perivalvar direction but sometimes form a spiral line. The girdle band is frequently unilaterally displaced and considerably closer to the younger valve.

Species: 37. *D. antarcticus* (fig. 37)

38. *D. mediterraneus* (fig. 38)

37. **Dactyliosolen antarcticus** Castracane

Figure 37

1886. Diat. Chall.-Exped., p. 75, pl. 9, fig. 7.

Cells usually long, two or more times longer than broad, seldom short cylindrical, bound into close-set, long, and stiff chains by the flat valves. Valves circular, 22–30 μ in diameter, without spines or processes, but with a row of very fine little nodules (rudimentary spines) on the margin. Intercalary bands distinct, numerous, from

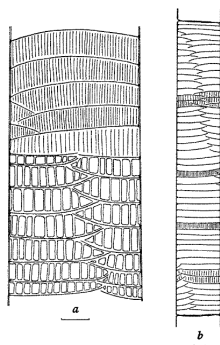

Fig. 37. *Dactyliosolen antarcticus* Castr. a, part of cell shown in (b), lower half, intercalary bands; diameter, 30 μ . b, entire cell.

1½ to 2½ in 10μ, the free ends forming a spiral line around the perivalvar axis. Each intercalary band has a row of large, usually quadrate or somewhat oval areolae, 5–7 in 10μ.

Oceanic. Temperate species. Found off southern California. Not uncommon but never abundant.

38. *Dactyliosolen mediterraneus* H. Pérégallo

Figure 38

1892. Le Diatomiste, vol. 1, p. 104, pl. 13, figs. 8, 9.

Cells cylindrical, with numerous intercalary bands and consequently usually a very long perivalvar axis. Bound in thick, close-set, even, stiff chains. Valves 7–11μ in diameter, with delicate, irregular areolae, without spines or processes. Intercalary bands 1–5 in 10μ, with ends lying in a straight perivalvar line. Intercalary bands with large or small areolae, in two-line system, 6–11 in 10μ. Chromatophores several, not very small, roundish plates. Living cells nearly always found with yellow epiphytic flagellate, *Solenicola setigera*, attached on the chains in the girdle-band zone.

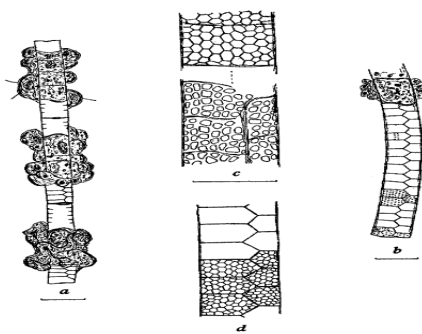

Fig. 38. *Dactyliosolen mediterraneus* H. Pér. *a* and *b*, parts of chains (note epiphytic flagellate, *Solenicola setigera*, attached to girdle-band zone); diameters: *a*, 7μ; *b*, 10μ. *c*, structure of cell; diameter, 11μ. *d*, areolae on intercalary bands of cell shown in (*b*).

Neritic, sporadically oceanic. Widespread. Fairly common off southern California and in Gulf of California.

Genus XVII. **LEPTOCYLINDRUS** Cleve

1889. Pelag. Diat. Kattegat, p. 54.

Cells long, cylindrical, united into chains by whole valve surface. Valves flat, without spines or processes. Intercalary bands present but very difficult to see. Cells thin-walled, hyaline, without visible sculpturing. Chromatophores one or many roundish plates or granules. Resting spores known.

Species: 39. *L. danicus* (fig. 39)

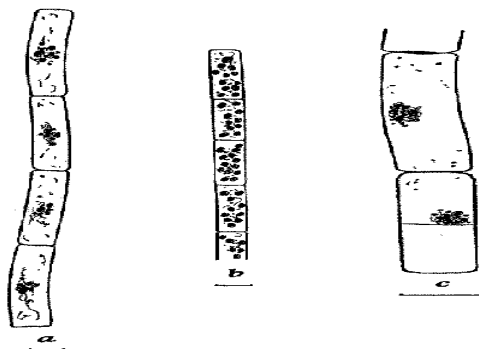

Fig. 39. *Leptocylindrus danicus* Cl. *a*, chain; diameter, 10μ. *b*, chain with chromatophores; diameter, 8μ. *c*, part of another chain; diameter, 10μ.

39. *Leptocylindrus danicus* Cleve

Figure 39

1889. Pelag. Diat. Kattegat, p. 54.

1894. Bih. Kongl. Svensk. Vet.-Akad. Handl., vol. 20, div. 3, no. 2, p. 15, pl. 2, figs. 4, 5.

Cells cylindrical, 7–10 μ . in diameter, two to ten times as long. United in closed, long, stiff chains. Valves flat or convex, occasionally concave, without visible sculpturing. Adjacent cells often with only one cell wall between two valves. Intercalary bands present but very difficult to see. Chromatophores few to numerous, not very small, oval plates, distributed throughout the cell. Resting spores and auxospores known but not observed in this material. Resting spores covered with spicules.

Neritic. Probably a north temperate species. Widespread. Fairly common off southern California. Reported at Scotch Cap, Alaska, and in Gulf of California where it may become even moderately abundant at times.

b) RHIZOSOLENIIN AE Schütt

1896. Bacill. in Engl.-Prantl, Nat. Pflanzenf., p. 84.

Genus XVIII. *GUINARDIA* H. Pérégallo

1892. Le Diatomiste, vol. 1, p. 107.

Cells cylindrical, longer than broad, with a straight or slightly curved perivalvar axis, living singly or united in straight to twisted close-set chains. Intercalary bands numerous, collarlike or with wedge-shaped ends (see fig. C, 9; *ib*). Valves circular, surface flat, with an asymmetrical lateral rudimentary tooth at the valve margin. Chromatophores numerous, roundish, more or less lobed. Nucleus usually lying in a central plasma mass, suspended by cytoplasmic strands extending to the cell walls.

Species: 40. *G. flaccida* (fig. 40)40. *Guinardia flaccida* (Castracane) H. Pérégallo

Figure 40

1886. Castracane. Diat. Chall.-Exped., p. 74., pl. 29, fig. 4 (*Rhizosolenia* (μ) *flaccida* Castracane).

1892. H. Pérégallo. Le Diatomiste, vol.1, p. 107, pl. 13, figs. 3, 4.

Cells typically cylindrical, one and a half to several times longer than broad, single or united in chains by whole valve surface. Valve nearly flat, very slightly concave, with an irregular tooth at the margin. Diameter 30–53 μ . Cell wall weakly siliceous, collapsing when dried, without visible sculpturing. Chromatophores lying near the wall, round to biscuit-shaped, more or less lobed or cleft plates in large numbers, with one pyrenoid. Nucleus more or less central.

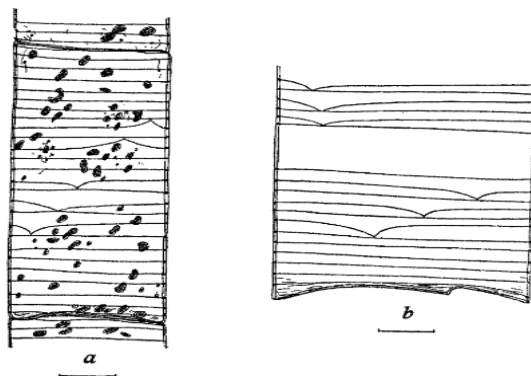

Fig. 40. *Guinardia flaccida* (Castr.) H. Pér. *a*, cell with chromatophores; diameter, 30 μ . *b*, part of a cell (note intercalary bands); diameter, 47 μ .

Neritic. South temperate species. Never Common off southern California. Present more commonly but never abundant in Gulf of California.

Genus XIX. **RHIZOLENIA** (Ehrenberg) Brightwell

1843. Ehrenberg. Phys. Abh. Akad. Wiss. Berl. 1841, pp. 329, 422.

1858. Emended by Brightwell. Quart. Jour. Micr. Sci., vol. 6, p. 93.

Cells cylindrical with greatly elongated perivalvar axis, living singly or in compact or loose chains. Cells usually straight or more rarely curved, forming spirally twisted chains. Cross section elliptical or circular. Intercalary bands (see fig. C, 1, 2, 3, 4, 5, ib) usually very numerous, but in some species difficult to see. Only a few species with ring shaped intercalary bands; in most species they are rhombic, trapeziumlike, or scale-shaped. Their separation lines are called *imbrication lines*. The valves, called calyptrae in the genus *Rhizosolenia*, are in some species almost flat or symmetrically cone-shaped, usually, however, excentric sharp cone-shaped or hood-shaped (fig. C, 1, 2, 3, 4, 5, vs). Likewise the valves have a usually excentric process, short or bristlelike elongated, blunt or sharp, solid or hollow (fig. C, 1, 2, 3, 4, 5, ap). In a few species the process is completely absent and only the valve is more strongly drawn out and thinner to resemble a process. The cells are thin-walled throughout and usually collapse when dried. The membrane structure, frequently difficult to see, consists of puncta or little dots arranged in quincunx or definitely arranged lines. The chromatophores are usually small, numerous, distributed on the entire cell wall, but especially massed in the girdle zone about the nucleus. In some species larger platelike chromatophores are present.

Dimorphic forms occur. These are often classed as separate species. For example, Gran considers *R. hebetata* form *semispina* and form *hiemalis* as one species with two forms, whereas Pavillard considers them as two separate species.

Auxospores, resting spores, and microspores are known. Auxospores are either at right angles to the mother cell or longitudinal. The resting spores occur, as far as is known, singly or in pairs within the mother cell. They are thick-walled and cylindrical, with one valve rounded, the other sharply conical.

The genus *Rhizosolenia* has been variously subdivided according to the form of the valve and the intercalary bands. Three common groupings are those of Gran (1905), who based the classification mainly on the intercalary bands; Karsten, who placed more emphasis on the symmetry of the cell; and more recently Pavillard (1925), whose scheme, however, had the disadvantage of giving intercalary bands and cell symmetry equal emphasis. Lebour (1930) follows Pavillard; Hustedt (1930) uses Karsten's scheme. A more natural grouping may be possible when the auxospore formation of all the groups is known. Here we shall follow Hustedt in using Karsten's divisions:

A. 1. *Simplices*. Valves symmetrical. Process appearing median in the girdle-band positions.

Species: 41. *R. fragilissima* (fig. 41)

42. *R. cylindrus* (fig. 42)

43. *R. bergonii* (fig. 43)

B. ***Eurhizosoleniae***. Process distinctly excentric, hence at least the calyptra, usually the entire cell, of dorsiventral construction.

2. **ANNULATAE**. Intercalary bands annular, collarlike or ring-shaped, of similar width throughout, except for the narrowing at the end.

a) *Lauderioideae*. Valves simple-rounded, not cone-shaped, with excentric spine. Cells building chains.

Species: 44. *R. delicatula* (fig. 44)

45. *R. stolterfothii* (fig. 45)

b) *Robustae*. Valves hood-shaped to tall cone-shaped, with excentric process. Cells mostly living singly.

Species: 46. *R. robusta* (fig. 46)

3. GENUINAE. Intercalary bands scalelike to semi-ring-shaped, sometimes ring-shaped reaching around the entire cell, then, however, wider in the middle and more or less quickly diminishing in breadth toward both sides.

a) *Imbricatae*. Intercalary bands in two longitudinal rows, their middle line in the transapical plane of the cell.

Species: 47. *R. imbricata* var. *shrubsolei* (fig. 47)

b) *Styliformes*. Intercalary bands in two longitudinal (dorsiventral) rows, their middle line in the apical plane of the cell. Valves with distinctly set-off process.

Species: 48. *R. styliformis* (fig. 48-A)

R. styliformis var. *longispina* (fig. 48-B)

49. *R. setigera* (fig. 49)

50. *R. hebetata* form *hiemalis* (fig. 50-A)

R. hebetata form *semispina* (fig. 50-B)

51. *R. calcar avis* (fig. 51)

c) *Alatae*. Intercalary bands also in two dorsiventral rows, seldom more. Valves without especially set-off process, only blunt or tubular.

Species: 52. *R. alata* (fig. 52-A)

R. alata form *gracillima* (fig. 52-B)

R. alata form *indica* (fig. 52-C)

R. alata form *curvirostris* (fig. 52-D)

R. alata form *inermis* (fig. 52-E)

4. SQUAMOSAE. Intercalary bands scalelike-rhombic, in numerous perivalvar rows; at least the calyptra dorsiventral.

Species: 53. *R. acuminata* (fig. 53)

54. *R. castracanei* (fig. 54)

A. 1. SIMPLICES

41. *Rhizolenia fragilissima* Bergon

Figure 41

1903. Bull. Soc. Sci. Arcachon, Sta. Biol., vol. 6, p. 49, pl. 1, figs. 9, 10.

Cells cylindrical with rounded ends, 12–20 μ in diameter, 42–67 μ in length. United in short straight chains. Intercalary bands ring-shaped (collar-shaped) but difficult to see. Small spine present near center of valve, fits into depression in adjacent cell. Chromatophores numerous small plates, distributed over entire cell wall. Nucleus near wall. Cell wall very thin and weakly siliceous.

Neritic. North temperate to boreal species. Moderately common off California, but never in large numbers.

42. *Rhizolenia cylindrus* Cleve

Figure 42

1897. Treat. phytopl. Atl. trib., p. 24, pl. 2, fig. 12.

Cells cylindrical with convex or rounded valves. Comparatively large, more or less S-shaped, curved process on each valve by which adjacent cells are united in chains. Diameter 8–13 μ ; length up to 300 μ . Intercalary bands numerous, ring-shaped, narrowed on both sides. Cell wall thin, without perceptible fine sculpturing. Imbrication lines distinct. Chromatophores numerous, small, round plates, throughout cell, near cell wall. (See fig. C, 1.)

Neritic. Subtropical or tropical species. Found off southern California and Lower California. Never common.

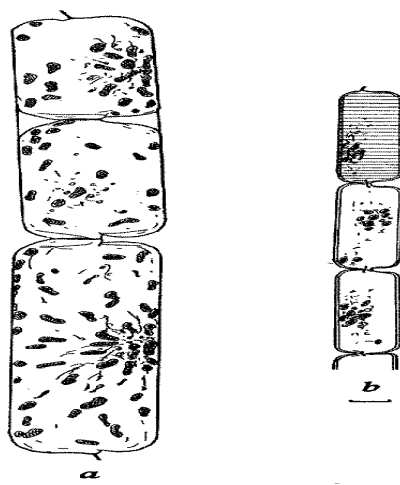

Fig. 41. *Rhizosolenia fragilissima* Berg. *a*, chain; diameter, 17μ *b*, part of a chain (note intercalary bands); diameter, 14μ .

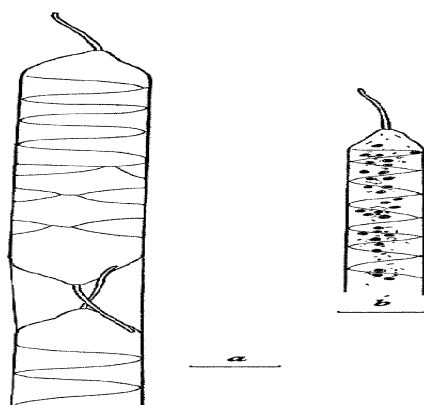

Fig. 42. *Rhizosolenia cylindrus* Cl. *a*, recently divided cells; diameter, 12μ . *b*, part of a cell, with chromatophores; diameter, 8μ .

43. *Rhizosolenia bergonii* H. Pérégallo

Figure 43 (p. 82)

1892. *Le Diatomiste*, vol. 1, p. 110, pl. 15, fig. 5.

Cells with cylindrical central region, elongated cone-shaped valves. Diameter $22-70\mu$; length up to 530μ . Intercalary bands scalelike, usually in four or five rows, with regular bow-shaped margins. Imbrication lines distinct. Apical process short, straight, centrally located, traversed by a canal in center, cut off abruptly at end. Canal enlarged at base, bell-shaped at apex. Walls of valve moderately robust, with rows of punctations beginning somewhat below the process and diverging toward the base of the calyptra, 17-18 puncta in 10μ near apex, 20-22 near base of valve. The membrane of the intercalary

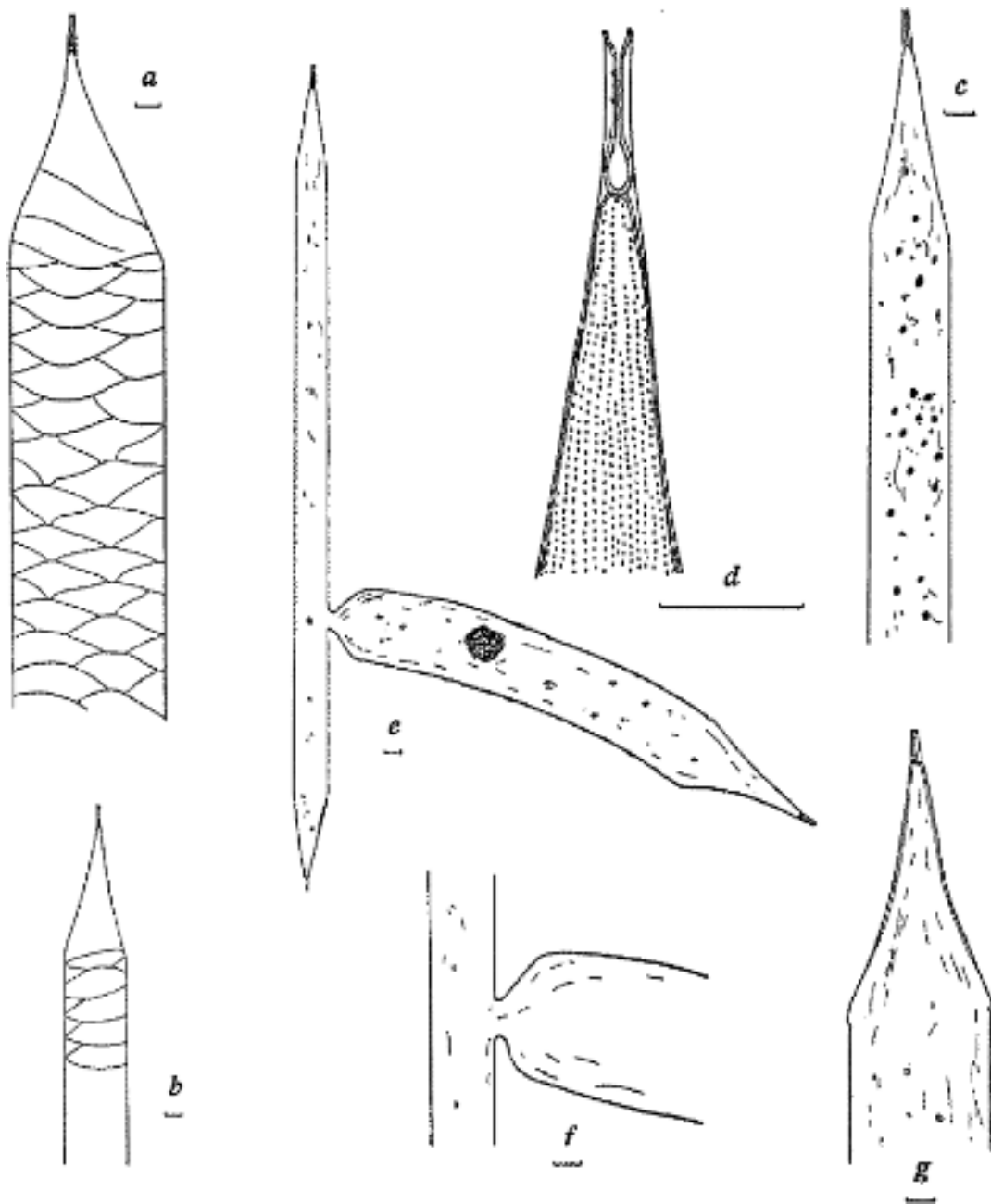

Fig. 43. *Rhizosolenia bergonii* H. Pér. *a*, *b*, and *c*, parts of three cells; diameters: *a*, 70μ ; *b*, 38μ ; *c*, 25μ . *d*, apex of cell showing arrangement of sculpturing. *e*–*g*, cell showing auxospore formation. *e*, diameter of cell, 23μ ; of auxospore, 46μ . *f*, section to show method of connection of auxospore with mother cell. *g*, apex of auxospore.

bands more delicate, with puncta in three crossing systems, 22–24 puncta in 10μ . Chromatophores numerous, small. Auxospores formed at right angles to long (perivalvar) axis of cell (fig. 43, *e*–*g*). Diameter of cell with auxospore 22μ ; of auxospore 46μ .

Oceanic. Warmer-water species, south temperate or subtropical. Found off Lower California and in Gulf of California. Fairly common but never abundant.

B. EURHIZOSOLENIAE

2. Annulatae

a) LAUDERIOIDEAE

44. *Rhizosolenia delicatula* Cleve

Figure 44

1900. Kongl. Svensk. Vet.-Akad. Handl., vol. 32, no. 8, p. 28, fig. 11.

Cells cylindrical, with almost completely flat valves, rounded only slightly on margins. United in closely set, straight chains. Cells 9–16 μ in diameter, usually about three times as long. Intercalary bands usually difficult to see, ring-shaped. Valve with marginal, short spine which fits into a corresponding furrow or depression on the adjacent cell. Chromatophores two or several large plates, near the girdle wall, more or less crenated or lobed.

Neritic. Temperate. Fairly common off California, abundant at times in Gulf of California.

45. *Rhizosolenia stolterfothii* H. Pérageallo

Figure 45 (p. 84)

1888. Bull. Soc. Hist. Nat. Toulouse, vol. 22, p. 82, pl. 6, fig. 44.

Cells cylindrical, 6–30 μ in diameter. Uniformly curved along perivalvar axis. United in curved chains, often spiral. Valves flat, rounded at the edges. Strong spine on valve margin, fits into depression on adjacent cell. Intercalary bands collarlike, numerous. Imbrication lines not always distinct, but very clear sometimes. Cell wall weakly siliceous, without detectable structure. Chromatophores numerous, small, oval. Nucleus near wall.

Neritic. Sometimes regarded as oceanic. Very wide-spread. Common and often abundant.

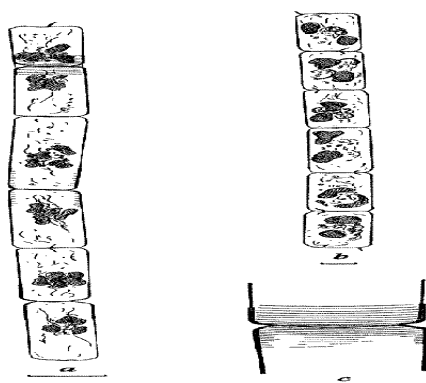

Fig. 44. *Rhizosolenia delicatula* Cl. *a* and *b*, two chains; diameters, 9 and 16 μ respectively. *c*, part of two cells showing intercalary bands; diameter, 11 μ .

b) ROBUSTAE

46. *Rhizosolenia robusta* Norman

Figure 46 (p. 85)

1861. In Pritchard, Infus., p. 866, pl. 8, fig. 42.

Cells cylindrical with deeply convex or conical curved valves, 48–130 μ in diameter, up to 1/2 mm. or even 1 mm. long. Valvar plane elliptical. Cells either crescent-shaped or S-shaped. Usually living singly, or in short chains. Intercalary bands robust, numerous, typically collar-shaped. Calyptrae with distinct longitudinal lines (growth sectors) and excentric process with a fine, bristlelike point and suddenly dilated, hollow base. Cell

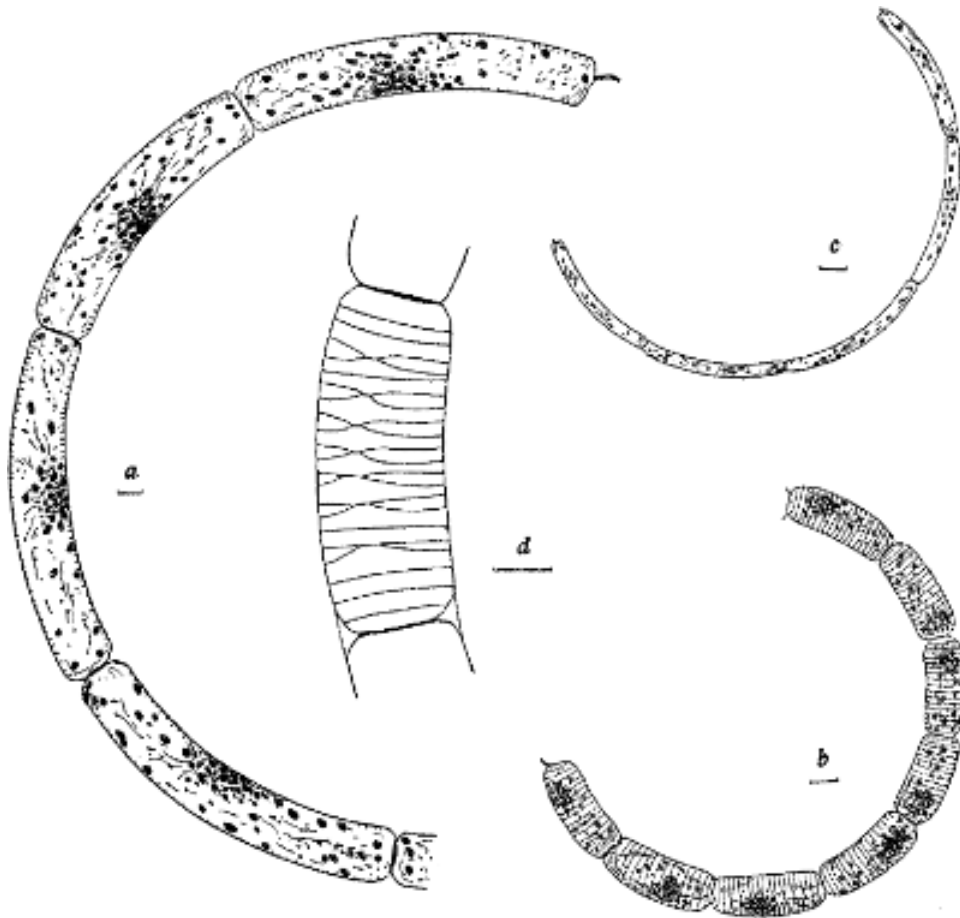

Fig. 45. *Rhizosolenia stolterfothii* H. Pér. *a*, *b*, and *c*, three chains; diameters, 20, 15, and 6 μ respectively. *d*, cell showing intercalary bands; diameter, 23 μ .

Oceanic. Widely distributed, especially in warm water. Frequently found off California but never common or abundant.

wall thin, but more strongly siliceous than in most of the other species of this genus. Membrane delicately punctated, puncta in three-line, self-crossing system (quincunx). Puncta on valve 19–20 in 10 μ ; on intercalary bands 24–26 in 10 μ . Chromatophores numerous, lying along the wall. Nucleus near the wall.

3. Genuinae

a) IMBRICATAE

47. *Rhizosolenia imbricata* Brightwell

1858. Quart. Jour. Micr. Sci, vol. 6, p. 95, pl. 5, fig. 6.

Variety *shrubsolei* (Cleve) Schröder

Figure 47 (p.86)

1881. Cleve. Kongl. Svensk. Vet.-Akad. Handl., vol. 18, no. 5, p. 26 (*Rhizosolenia shrubsolei*). 1906. Schröder. Vierteljahrsh. naturforsch. Ges. Zürich, vol. 51, p. 346.

Cells cylindrical, 12–18 μ in diameter, up to 575 μ in length. Cells single or united in chains. Valves oblique, pointed, the apical process hollow most of the way up, with

small wings at the base, regularly decreasing in size until the point is reached. Small wings run up about a third of the spine, do not extend to valve itself. Intercalary bands numerous, scalelike in two long rows, each band a triangular scale with the corner pointing so that they form an imbricating row on each side of the apex. Intercalary bands with ribs running from the middle line fanlike toward the sides, on an average 17–18 in 10μ , between the ribs coarsely lined with 24 cross lines in 10μ . Girdle bands and valves much more delicate. Girdle bands with 19–22 perivalvar rows of lines and 25–28 puncta

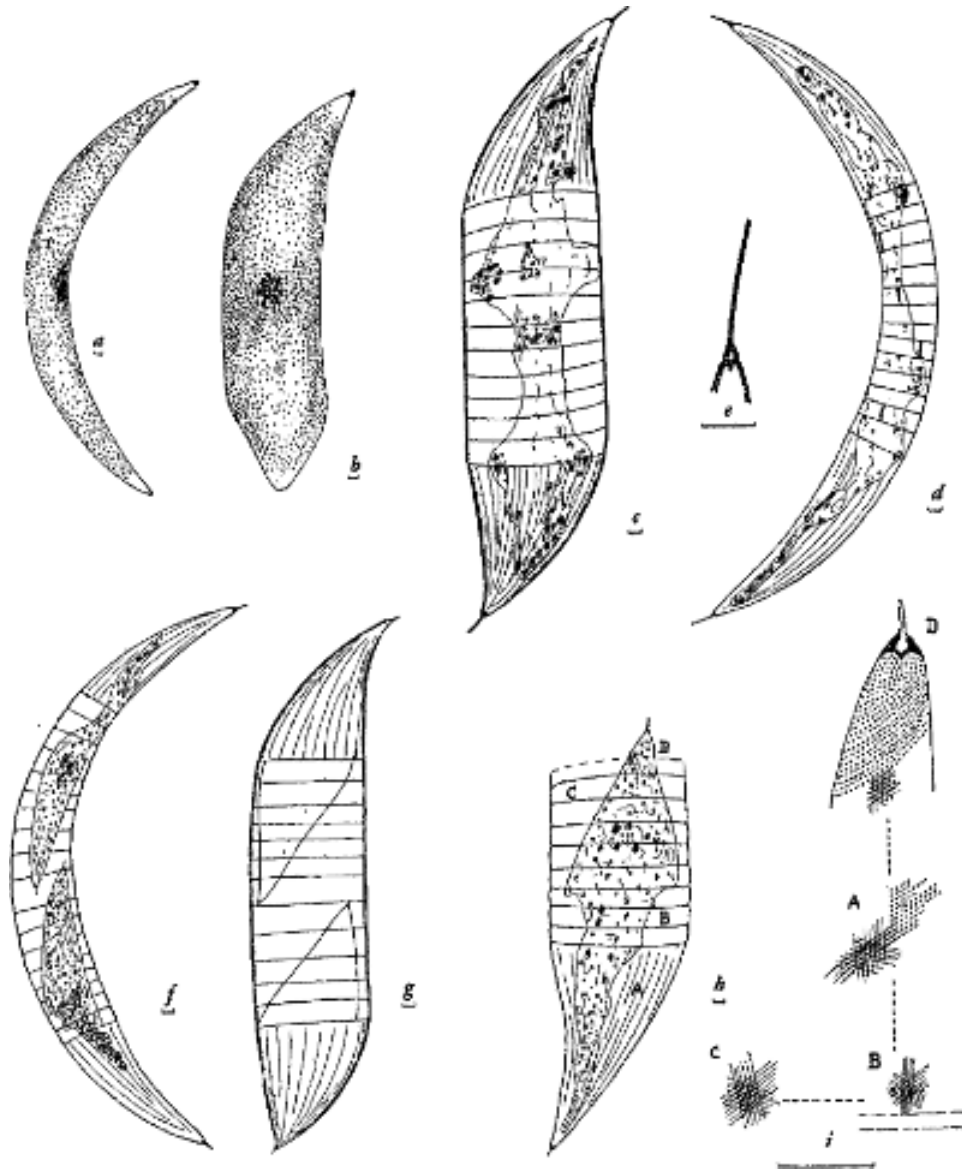

Fig. 46. *Rhizosolenia robusta* Norm. *a* and *b*, same cell. *a*, narrow girdle view; *b*, broad girdle view; widths: *a*, 55μ ; *b*, 130μ . *c* and *d*, another cell. *c*, broad girdle view; *d*, narrow girdle view; widths: *c*, 130μ ; *d*, 48μ . *e*, apex and bristlelike point. *f* and *g*, a dividing cell. *f*, narrow girdle view; *g*, broad girdle view; widths: *f*, 55μ ; *g*, 103μ . *h*, recently divided cell; width, 120μ . *i*, sections of (*h*) showing arrangement of sculpturing in corresponding regions (as indicated by A, B, C, and D).

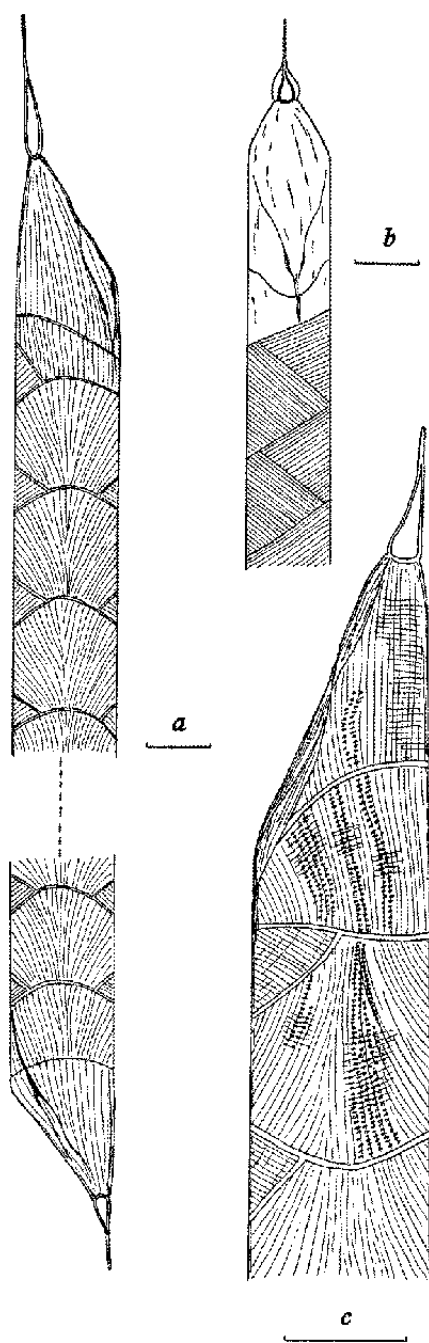

Fig. 47. *Rhizosolenia imbricata* var. *shrubsolei* (Cl.) Schröd. *a*, side view of a cell; diameter, 17μ . *b*, ventral view; diameter, 14μ . *c*, side view showing sculpturing; diameter, 15μ .

in 10μ , lines on the valves from the base toward the excentric point 20–22 in 10μ , with 26–30 puncta in 10μ . Chromatophores numerous, small, lying near the cell wall. Nucleus near wall.

The variety is smaller in diameter than the type, and has somewhat more delicate sculpturing. The valve is much more elongated than in *R. imbricata*. The variety has a more northerly distribution than the type.

Neritic. North temperate species. Fairly common off California and Lower California, and in the Gulf of California. Never in large numbers.

b) STYLIFORMES

48. *Rhizosolenia styliformis* Brightwell

Figure 48-A

1858. Quart. Jour. Micr. Sci, vol. 6, p. 95, pl. 5, fig. 5, *a-d*.

Cells cylindrical, never compressed. Valves obliquely pointed, more sharply than in *R. imbricata* var. *shrubsolei*. Cells 20–70 μ in diameter, 600–1050 μ in length. Apical process pointed, with a long cavity penetrating the tip of the valve. Two winglike expansions beginning on the valve, ending near base of process. Valve with distinct mark for both spine and wings of valve of adjacent cell. Intercalary bands scalelike with very fine reticulated sculpturing. Cell wall thin or moderately strong. Sculpturing in quincunx, 20–25 puncta in 10 μ on intercalary bands, on valves 25–28 in 10 μ . Chromatophores numerous, small, round. The alga *Richelia intercellularis*, first described by Joh. Schmidt in 1901, is often found in and on the cells of *R. styliformis*.

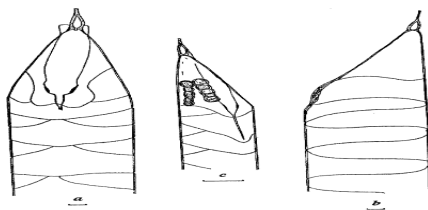

Fig. 48-A. *Rhizosolenia styliformis* Brightw. *a*, ventral view of part of a cell; diameter, 70 μ . *b*, side view of same cell. *c*, side-ventral view of part of a cell; diameter, 20 μ (note *Richelia intercellularis* near apex of cell).

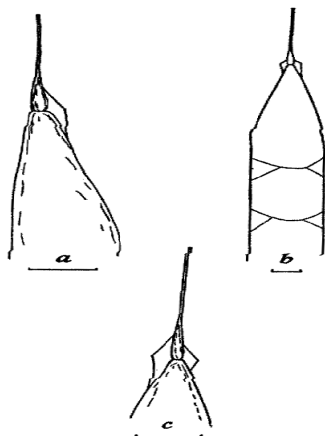

Fig. 48-B. *Rhizosolenia styliformis* var. *longispina* Hust. *a*, side view of part of a cell; diameter, 23 μ . *b*, dorsal view of same cell. *c*, apex of another cell.

Oceanic. North temperate species. Common off California, sometimes fairly numerous. Reported from Gulf of California.

Variety **longispina** Hustedt

Figure 48-B

1914. In A. Schmidt, Atlas, pl. 316, figs. 5–7, 12.

Differs from the type in its longer process, shortly beyond the base suddenly becoming much thinner and spinelike. About 16 puncta in 10 μ on valve. (See fig. C, 5.)

Oceanic. Found off California and in Gulf of California.

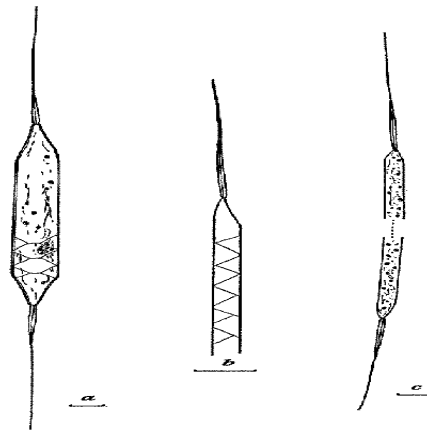

Fig. 49. *Rhizosolenia setigera* Brightw. *a*, entire cell; diameter, 15μ . *b*, part of a cell; diameter, 4μ . *c*, two ends of a long cell (450μ); diameter, 5μ .

49. *Rhizosolenia setigera* Brightwell

Figure 49

1858. Quart. Jour. Micr. Sei, vol. 6, p. 95, pl. 5, fig. 7.

Cells rodlike, cylindrical. Diameter $4\text{--}20\mu$. Valves conical, only slightly oblique. A pical process cylindrical, thickened for some distance from base, solid at base or with a very fine canal in the center, with a very long, fine, straight spine. Intercalary bands scalelike, two long bands pointing toward apex. Cell wall thin, weakly siliceous, without distinct or visible structure. Chromatophores numerous, small, elliptical.

Neritic. North temperate species. Common off California, moderately abundant at times in Gulf of California.

50. *Rhizosolenia hebetata* (Bailey) Gran, emend.

1856. Bailey. Amer. Jour. Sci., ser. 2, vol. 22, pl. 1, figs. 18, 19.

1904. Gran. Fauna Arctica, vol. 3, no. 3, p. 524.

A dimorphic species, two very different forms according to locality and season. May resemble one form at one end of cell, other form at other end.

Form *hiemalis* Gran

Figure 50-A

1904. Fauna Arctica, vol. 3, no. 3, p. 527, pl. 17, figs. 9–12 (form *hiemalis* Gran = *R. hebetata* Bailey).

Cells straight, $18\text{--}20\mu$ in diameter, valves longitudinally drawn out; apical process thick, solid, except for a small, hollow, rounded spine. Junction between scalelike intercalary bands distinct. Intercalary bands in two dorsiventral rows alternating. Cell wall strongly siliceous, with distinct structure. Intercalary bands finely punctated, puncta in quincunx, $24\text{--}26$ in 10μ . On valves punctation coarser, $19\text{--}20$ puncta in 10μ near base, in broken lines and coarser near apex. Chromatophores small, numerous.

Usually a winter and cold-water form. Rarely seen more southerly than Alaska.

Form *semispina* (Hensen) Gran

Figure 50-B

1887. Hensen. 5. Ber. Komm. wissensch. Untersuch. deutsch. Meere, Kiel, p. 84, pl. 5, fig. 39 (*Rhizosolenia semispina*).

1904. Gran. Fauna Arctica, vol. 3, no. 3, p. 527. (Illus. in Gran, 1905, fig. 67, *b*.)

Valves longitudinally drawn out. Process hollow at base and ending in a long, curved, hairlike spine. General construction in agreement with form *hiemalis* except smaller in

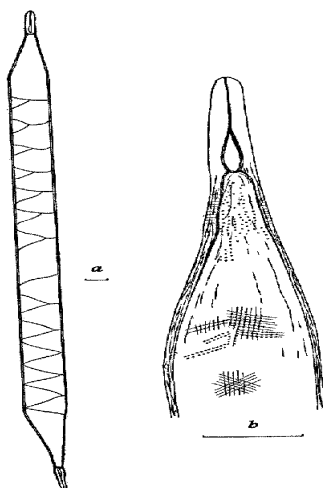

Fig. 50-A. *Rhizosolenia hebetata* form *hiemalis* Gran. *a*, entire cell; diameter, 18μ . *b*, end of cell showing arrangement of sculpturing.

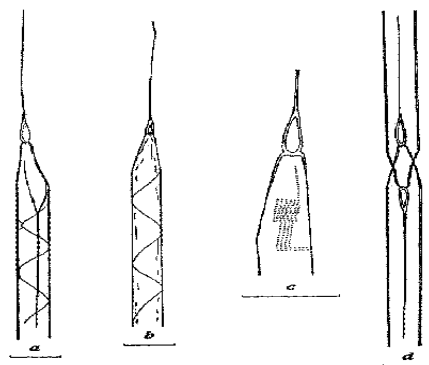

Fig. 50-B. *Rhizosolenia hebetata* form *semispina* (Hen.) Gran. *a*, part of a cell, ventral view; diameter, 7μ . *b*, side view of part of a cell; diameter, 5μ . *c*, end of cell showing arrangement of punctation. *d*, recently divided cells; diameter, 7μ .

diameter, $5-12\mu$. Cell wall much more weakly siliceous and with correspondingly more delicate structure. Near apex of valve, 20–24 puncta in 10μ ; nearer base finer, 25–27 in 10μ ; on intercalary bands, 26–29 in 10μ .

Usually a warm-water and summer form. Common and often abundant off California, especially in July and August. Reported in Gulf of California.

51. *Rhizosolenia calcar avis* M. Schultze

Figure 51 (p. 90)

1858. In Müller's *Archiv Anat., Phys. u. wissenschaft. Med.* 1858, p. 339, pl. 13, figs. 5–10.

Cells rod-shaped cylindrical, like *R. styliformis*, but the valves not so oblique, more regularly conical, curved at the apex. Cells $6-53\mu$ in diameter, up to nearly 1 mm. in length.

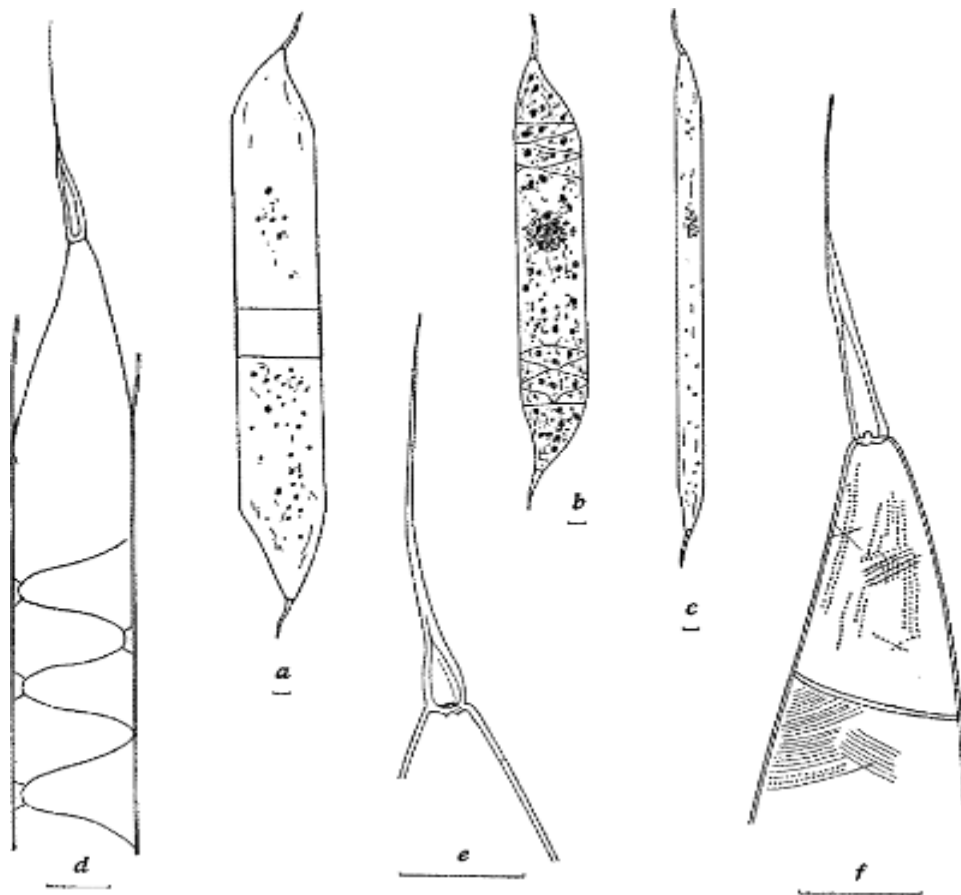

Fig. 51. *Rhizosolenia calcar avis* M. Schultze. *a*, *b*, and *c*, three entire cells; diameters: *a*, 53μ ; *b*, 42μ ; *c*, 18μ . *d*, part of a cell showing intercalary bands. *e*, process. *f*, valve and intercalary band showing arrangement of punctation.

Intercalary bands scalelike, rhombic, in small individuals in two dorsiventral rows, in the widest forms sometimes up to eight or more rows. Imbrication lines difficult to see. Process strong, gradually diminished in size from the base to the point, curved like a claw. No wings on process. Cell wall thin and weakly siliceous. Very delicately punctated. Puncta on valve 22–24 in 10μ ; on intercalary bands 20–23 in 10μ . Chromatophores small, numerous.

Oceanic, Warm-water species, subtropical to tropical. Common and even abundant at times, especially in August, off southern California. Moderately abundant in Gulf of California in 1937.

c) ALATAE

52. *Rhizosolenia alata* Brightwell

Figure 52-A

1858. Quart. Jour. Micr. Sci., vol. 6, p. 96, pl. 5, fig. 8.

Cells rod-shaped, cylindrical, straight; $7\text{--}18\mu$ in diameter, up to 1 mm. in length. Valve shortly conical ending in tubelike, more or less curved oblique process. Depression at base of tube into which apex of adjoining cell fits. Intercalary bands scalelike, rhombic, in two dorsiventral

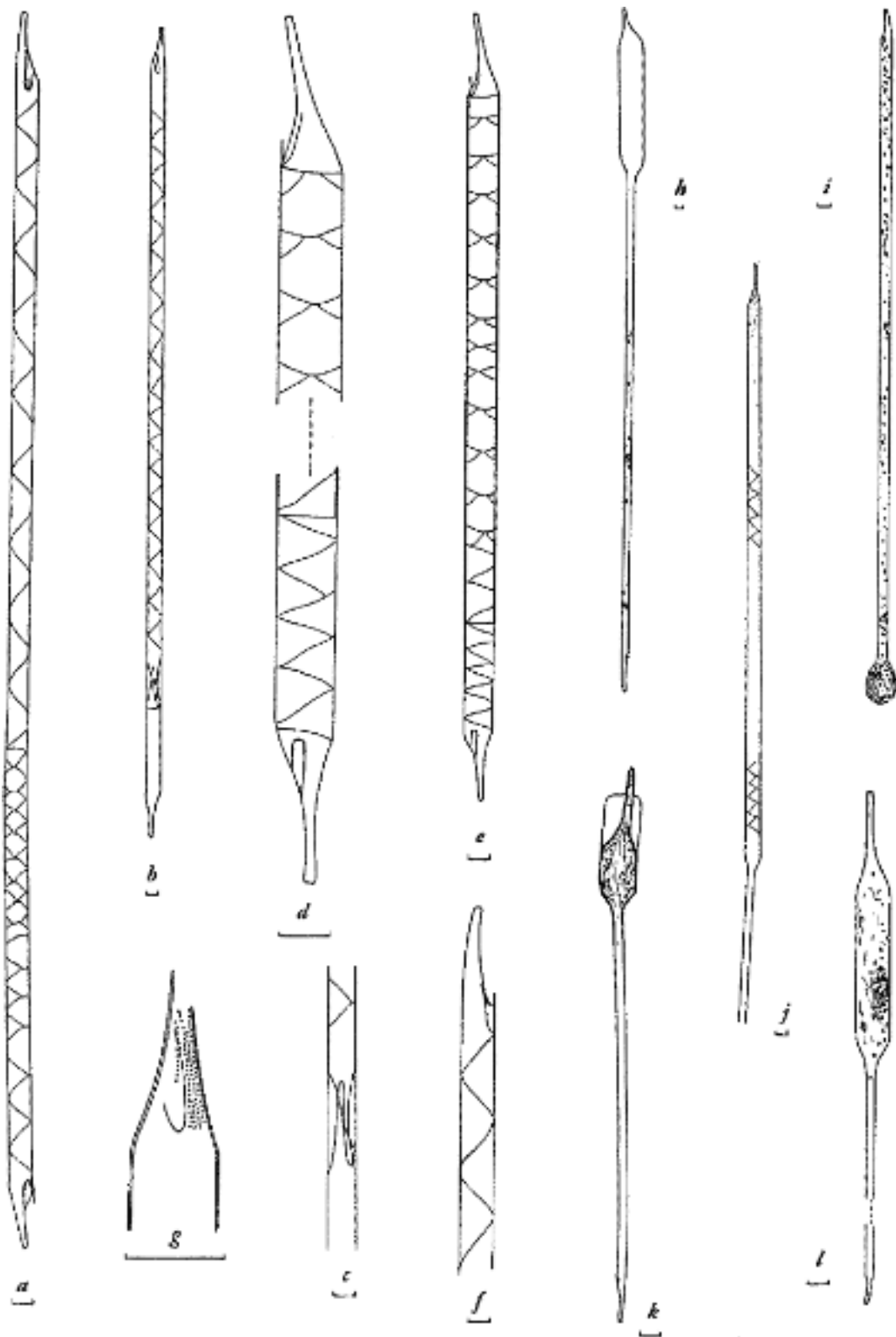

Fig. 52-A. *Rhizosolenia alata* Brightw. *a*, entire cell; diameter, 9μ . *b*, dividing cell; diameter, 11μ . *c*, detail of (*b*), stage of division. *d*, cell ends of (*e*); diameter, 13μ . *e*, entire cell; diameter, 13μ . *f*, side view; diameter, 12μ . *g*, arrangement of punctation on valve. *h-l*, stages in formation of auxospores.

rows. Cell wall thin, weakly siliceous. Finely striated. On valve 21–23 puncta in 10μ . None observed on intercalary bands. Chromatophores numerous, small. Auxospores and resting spores known. Auxospores (fig. 52-A, *h-l*) growing out in the same plane as the main cell.

Oceanic, but often near the coast. Temperate species. Common off California and north to Alaska. Sometimes abundant off southern California and common in the Gulf of California.

Form **gracillima** (Cleve) Grunow

Figure 52-B

1881. Cleve. Kongl. Svensk. Vet.-Akad. Handl., vol. 18, no. 5, p. 26, pl. 6, fig. 78 (*Rhizosolenia [alata var.] gracillima*).

1880–85. Grunow (as variety). In V. H. Syn., pl. 79, fig. 8.

Like the type, but narrower. Diameter $4\text{--}7\mu$. Production of auxospores bring it to same size as the type.

A coastal form, perhaps truly neritic. Usually in northern seas.

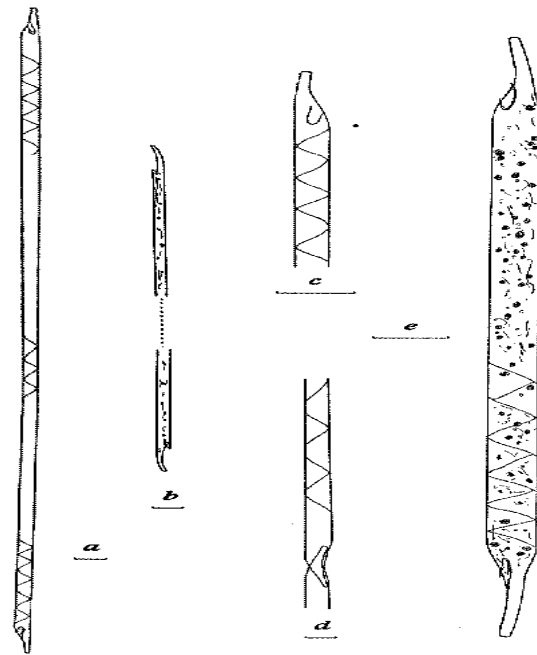

Fig. 52-B. *Rhizosolenia alata* form *gracillima* (Cl.) Grun. *a*, entire cell; diameter, 4μ . *b*, two ends of a cell 428μ long; diameter, 5μ . *c*, side view of one end of a cell 4μ in diameter. *d*, ends of recently divided cells; diameter, 6μ . *e*, entire cell with chromatophores; diameter, 7μ .

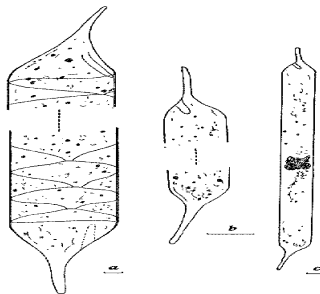

Fig. 52-C. *Rhizosolenia alata* form *indica* (H. Pér.) Osten. Diameters: *a*, 54μ ; *b*, 14μ ; *c*, 16μ .

Form indica (H. Pérégallo) Ostenfeld

Figure 52-C

1892. H. Pérégallo. *Le Diatomiste*, vol. 1, p.116, pl. 18, fig. 16 (*Rhizosolenia indica*).1901. Ostenfeld. *Vidensk. Meddel. naturh. Foren. Kbhvn.*, p. 160 (as variety).

Cells much larger and broader than the type, 16–54 μ in diameter. Calyptrae, because of this greater diameter, more strongly and suddenly attenuated, the process more striking. Structure very delicate; in many individuals, however, coarser than in the type. Cell wall finely punctated, puncta in quincunx, rows short and consequently appear to be irregular.

Usually in warmer seas than the type, but often with it. Occasionally off southern California. More common in Gulf of California.

Form curvirostris Gran

Figure 52-D

1900. *Nyt Mag. Naturvid.*, vol. 38, no. 2, p. 120, pl. 9, fig. 22.

Cells with process of valve drawn out in a long curve, beaklike, sometimes with very small spines on end of process. Diameter 13–24 μ .

Never common. Found off southern California and north to Alaska.

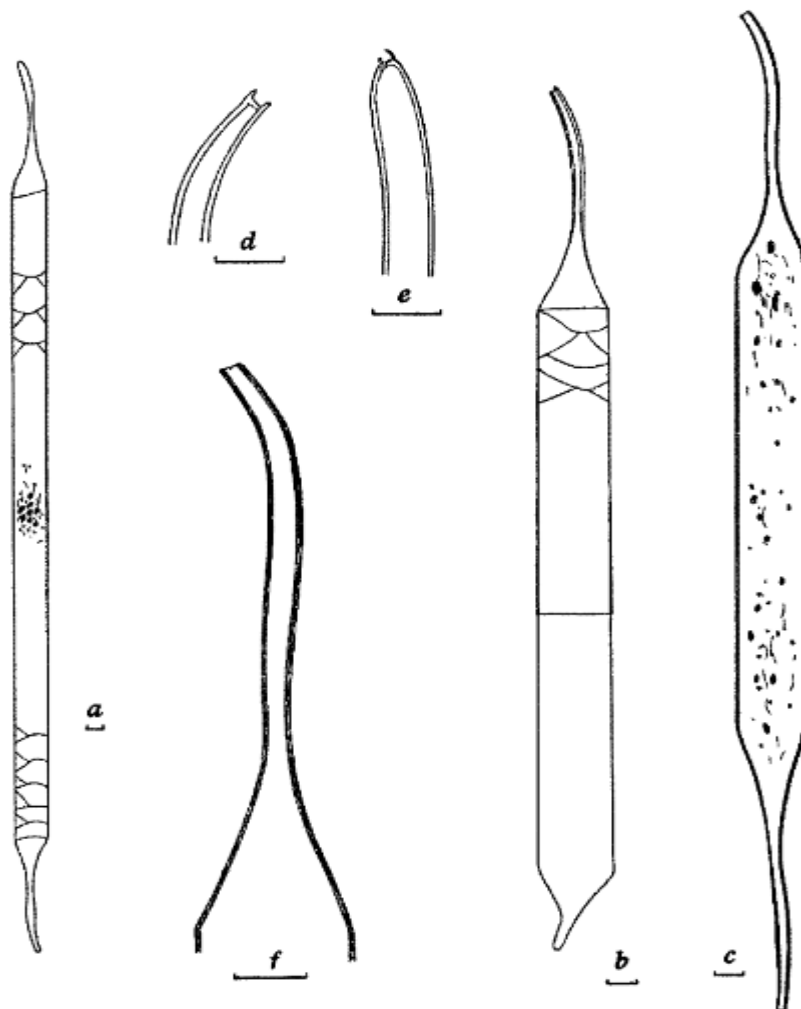

Fig. 52-D. *Rhizosolenia alata* form *curvirostris* Gran. *a*, *b*, and *c*, entire cells; diameters: *a*, 20 μ ; *b*, 22 μ ; *c*, 22 μ ; *d-e*, ends of processes. *f*, process.

Form inermis (Castracane) Hustedt

Figure 52-E

1886. Castracane. Diat. Chall.-Exped., p. 71, pl. 24, figs. 7, 8, 10, 13 (*Rhizosolenia inermis*).

1930. Hustedt. Kieselalgen, pt. 1, p. 602, fig. 348.

Differs from the type in possessing a sharply truncated apex to the drawnout process of the valve. Only slightly curved. The process is only slightly reduced toward the end. Cells 12–13 μ in diameter.

Oceanic. Northern species. Seldom found south of Alaska. Reported off California rarely.

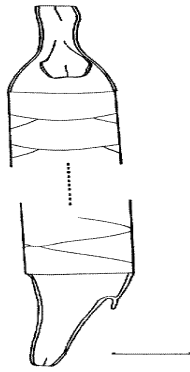

Fig. 52-E. *Rhizosolenia alata* form *inermis* (Castr.) Hust. Diameter, 13 μ .

4. Squamosae**53. Rhizosolenia acuminata** (H. Pérégallo) Gran

Figure 53

1892. H. Pérégallo. Le Diatomiste, vol. 1, p. 110, pl. 15, fig. 4 (*Rhizosolenia temperei* var. *acuminata*).

1905. Gran. Diat. Nord. Plankt., p. 50, fig. 59.

Cells straight, with a long conical valve. Diameter 165–172 μ . Valve with a small process. Process with a small elongated hollow at the base, no wings. Intercalary bands scalelike, in at least four and usually many rows. Cell wall strong. Chromatophores small, numerous.

Oceanic. Subtropical or temperate species. Reported from Gulf of California.

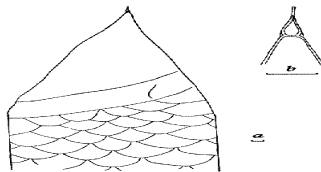

Fig. 53. *Rhizosolenia acuminata* (H. Pér.) Gran. a, part of a cell; diameter, 172 μ b, process.

54. Rhizosolenia castracanei H. Pérégallo

Figure 54

1888. Bull. Soc. Hist. Nat. Toulouse, vol. 22, p. 93, pl. 6, fig. 42.

Cells cylindrical, 135–380 μ in diameter. Valve conical with oblique apex. Intercalary bands in numerous perivalvar rows, scalelike, moderately flat-rhombic with slightly wavy borders. Spine short and fairly blunt, small ears or wings at the base. Cell wall thin, but with relatively strong sculpturing. Intercalary bands coarse areolated-punctated, puncta 10–12 in 10 μ , in three self-crossing line systems. (See fig. C, 4.)

Oceanic. Warm-water species, tropical. Occasionally off southern California.

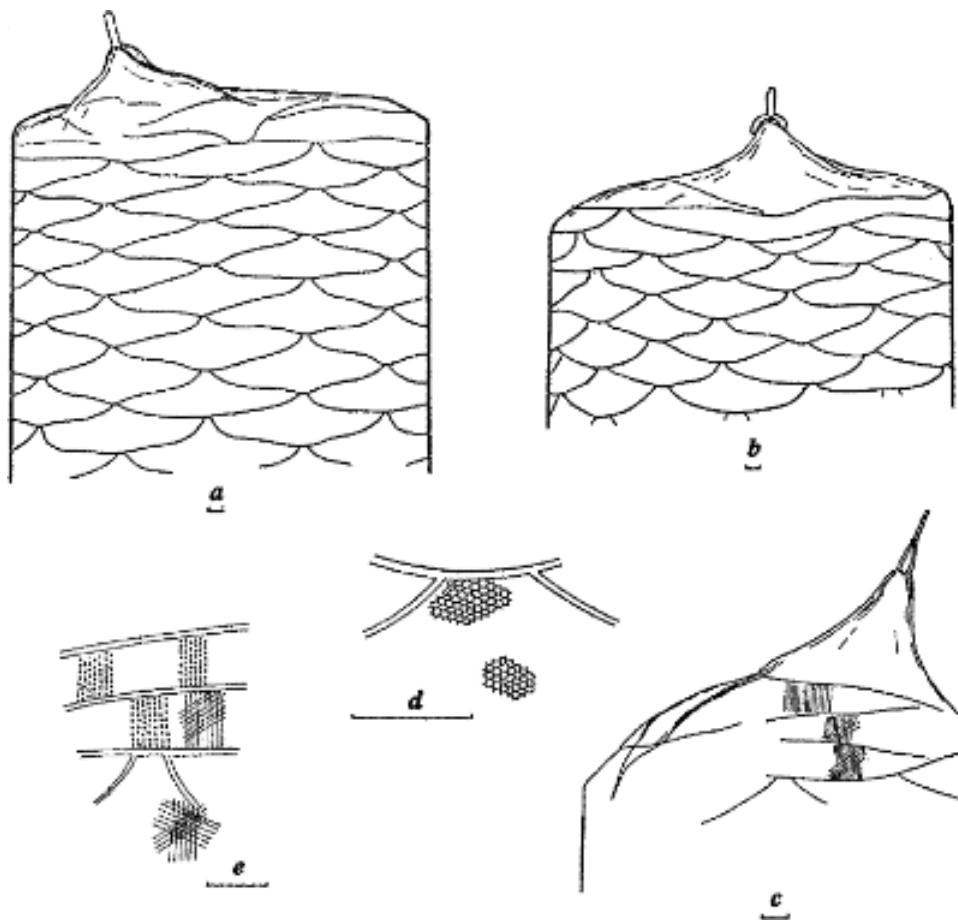

Fig. 54. *Rhizosolenia castracanei* H. Pér. *a*, side view of part of a cell; diameter, 300 μ . *b*, dorsal view; diameter, 280 μ . *c*, side-ventral view; diameter, 140 μ . *d*, section of intercalary band showing areolation. *e*, section of intercalary bands showing arrangement of sculpturing.

III. BIDDULPHIOIDEAE Schütt

1896. Bacill. in Engl.-Prantl, Nat. Pflanzenf., p. 85.

5. CHAETOCERAE Schütt

1896. Bacill. in Engl.-Prantl, Nat. Pflanzenf., p. 85.

Genus XX. BACTERIASTRUM Shadbolt

1854. Trans. Micr. Soc., N.S., vol. 2, p. 14.

Cells cylindrical, in cross section circular. Bound into loose chains by the fusion of the more or less numerous setae that are regularly arranged around the margin of the cells. Setae of two adjacent cells are fused for a certain distance beyond the base, farther out divided again. Terminal setae different from others, often curved, not fused and therefore not bifurcating. Intercalary bands absent as a rule. Apertures between cells of varying widths. Cell wall delicate and hyaline, without clearly visible structure. Chromatophores numerous, small, roundish, more or less lobed. Resting spores near middle of cell with small spines on one valve.

All species are marine pelagic.

Pavillard's (1924–1925) revision of the classification within the genus *Bacteriastrum* has been followed:

I. Isomorpha. Terminal setae of like construction and form on both ends of chain (isomorphic). Setae on both ends directed either outward from chain axis or toward the center. The two outer valves are therefore mirror images.

Species: 55. *B. delicatulum* (fig. 55)

56. *B. hyalinum* (fig. 56-A)

B. hyalinum var. *princeps* (fig. 56-B)

57. *B. elongatum* (fig. 57)

II. Sagittata. Terminal setae on either end of chain different in form and direction (dimorphic). Setae of posterior valve directed outward from chain and running nearly parallel to chain axis, forming a bell-shaped space. Setae of other or *anterior* valve curved toward inner part of chain, or on their ends turned back toward the out-side, or in general deviating little from the valvar plane.

Species: 58. *B. comosum* (fig. 58)

The position of the forked part of the inner setae is also of importance in classification. The forking may be parallel to the perivalvar axis (branches in a plane parallel to the chain axis) or in the direction of the valvar plane (branches transverse to the chain axis).

Pavillard has shown that *B. varians* is a tropical species. It may occur occasionally off Lower California but undoubtedly most records of its presence off the California region refer to *B. delicatulum* or *B. hyalinum*.

I ISOMORPHA

55. *Bacteriastrum delicatulum* Cleve

Figure 55

1897. Fifteenth Ann. Rep. Fish. Board for Scotland, pt. 3, p. 298, fig. 16.

Cells cylindrical, 6–15 μ in diameter. Chains long, straight. Setae 6–12, with strong, long basal part. Apertures usually relatively large. The bifurcation plane of inner setae lies in the valvar plane, transverse to chain axis. Forked parts slightly curved, smooth or somewhat wavy. Terminal setae of both ends directed toward the inside of the chain and in front view of the valve similarly curved. Stronger than inner setae and with fine spines arranged spirally. Chromatophores small, numerous, distributed along cell wall. Oceanic. Temperate species. Fairly common in eastern Pacific.

56. *Bacteriastrum hyalinum* Lauder

Figure 56-A

1864. Trans. Micr. Soc., N.S., vol. 12; p. 6, pl. 3, fig. 7.

Cells cylindrical, 14–28 μ in diameter. Perivalvar axis often shorter than diameter. Chains long, straight or slightly curved. Apertures narrow but distinct. Inner setae 12–25 on each valve, with short basal part. Bifurcations in perivalvar axis (parallel to chain axis) giving cells a hairy appearance. Forked parts slightly curved and usually weakly twisted. Terminal setae differ little from those of *B. delicatulum*, umbrella-shaped, stronger than inner setae, and with spirally arranged tiny spines as in previous species. Chromatophores small, numerous. Resting spores in pairs in adjacent cells, one in each cell. With high arched valves, the primary valve slightly contracted above the base, with fine spines when fully formed, smooth in process of formation. Secondary valve similarly rounded and smooth.

Neritic. Probably much confused with *B. varians*. Common and frequently abundant in eastern Pacific especially in April, May, and June.

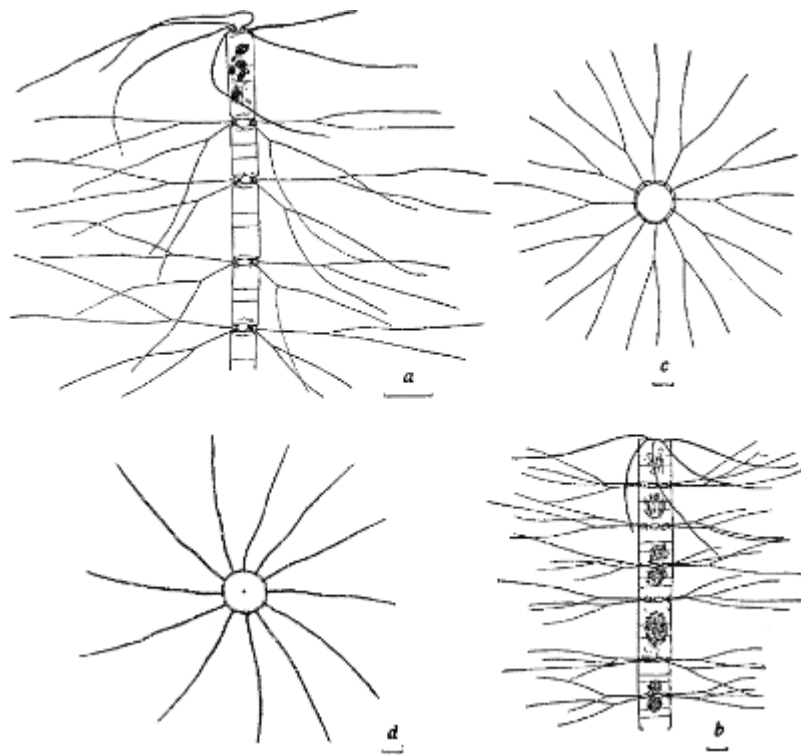

Fig. 55. *Bacteriastrum delicatulum* Cl. *a* and *b*, parts of two different chains in girdle view; diameters: *a*, 6 μ ; *b*, 15 μ . *c*, valve view showing inner setae. *d*, valve view showing terminal setae.

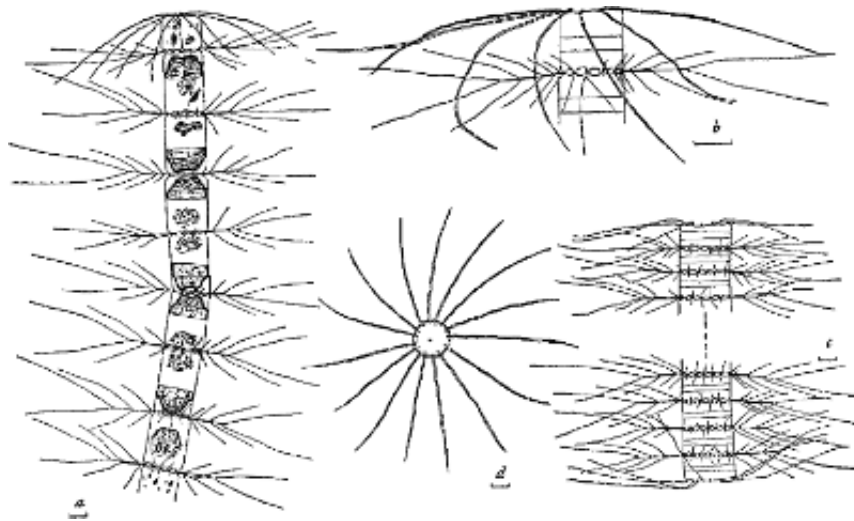

Fig. 56-A. *Bacteriastrum hyalinum* Laud. *a*, girdle view of part of a chain with resting spores; diameter, 24 μ . *b*, girdle view of terminal cell and setae; diameter, 17 μ . *c*, girdle view of a typical chain; diameter, 28 μ . *d*, valve view of terminal cell showing terminal setae; diameter, 20 μ .

Variety **princeps** (Castracane) Ikari

Figure 56-B

1886. Castracane. Diat. Chall.-Exped., p. 84, pl. 14, fig. 2; pl. 29, fig. 3 (*Bacteriastrum varians* var. *princeps*).

1927. Ikari. Bot. Mag. Tokyo, vol. 41, no. 486, p. 423, fig. 3.

Differs from the type in the spirally twisted bifurcations on the inner setae. At first Castracane described the setae as having the two branches of the forked parts different, one being slightly arched, the other with the spiral region, and the curved always alternating with the arched. Ikari pointed out that all the inner setae do not have the special formation and furthermore that two kinds of spiral setae exist—one as described by Castracane, the other with the two branches of the forked part with equal spirals or coils. The number of coils is usually small, from two to three.

Usually found in warmer water than type. Not uncommon off southern California, but abundance difficult to estimate because of confusion with *B. varians* and *B. delicatulum*.

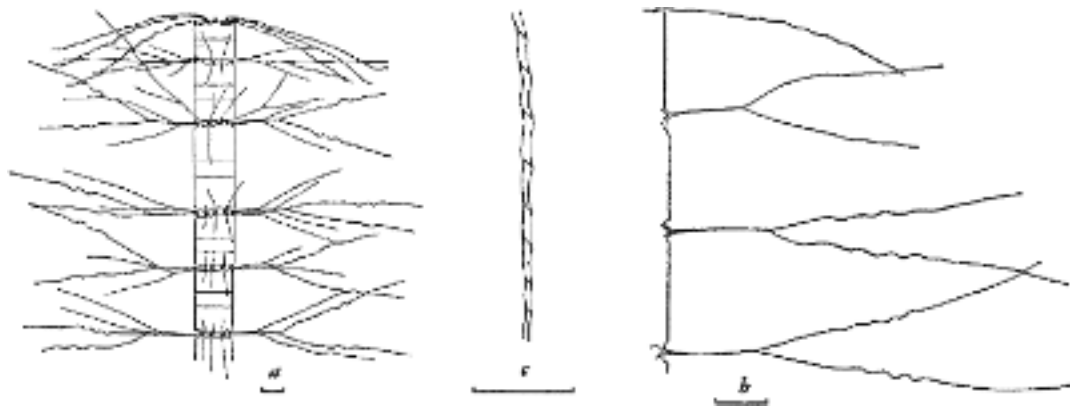

Fig. 56-B. *Bacteriastrum hyalinum* var. *princeps* (Castr.) Ikari. *a*, girdle view of part of a chain; diameter, 18μ . *b*, **inner** setae. *c*, part of a terminal seta.

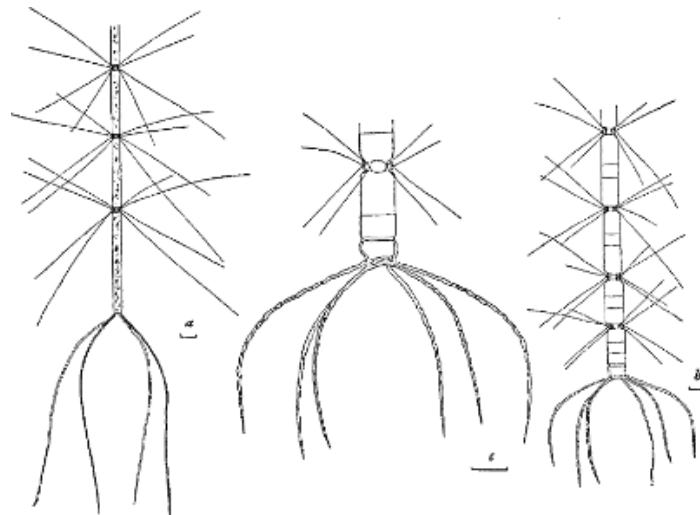

Fig. 57. *Bacteriastrum elongatum* Cl. *a* and *b*, parts of two chains in girdle view; diameters: *a*, 5μ ; *b*, 10μ . *c*, terminal cell of chain shown in (*b*).

57. *Bacteriastrum elongatum* Cleve

Figure 57

1897. Treat. phytopl. Atl. trib., p. 19, pl. 1, fig. 19.

Cells cylindrical, 6–11 μ in diameter. Usually several times longer than broad. Chains straight, usually not very long, isomorphic. Apertures distinct. Inner setae usually six on each valve, with short basal part, outer part bifurcating, with forked plane in pervalvar axis (branches in a plane parallel to chain axis). Forked parts at wide angle, straight and stiff, or only slightly curved. Terminal setae with slightly arched base, then running outward nearly parallel to chain axis, bell-shaped. Stronger than inner setae, with spirally arranged little spines.

Oceanic. Temperate species. Fairly common off California and Lower California, and in the Gulf of California, but never very abundant. Most common during April and May.

II. SAGITTATA

58. *Bacteriastrum comosum* Pavillard

Figure 58

1916. Rech. Diat. pélag. Golfe du Lion, p. 29, pl. 1, fig. 3.

Chains short, straight, dimorphic. Cells cylindrical, 12–17 μ in diameter, much longer than broad. Apertures more or less wide. Inner setae with short basal part. Setae of adjacent cells united for a distance about equal to diameter of cell or less. Bifurcation plane transverse. Forked part very long and already at the point of division curving toward the posterior end of chain, so that the branches run parallel to chain axis and give the chain a very characteristic appearance. Outer valves unlike. Anterior valve

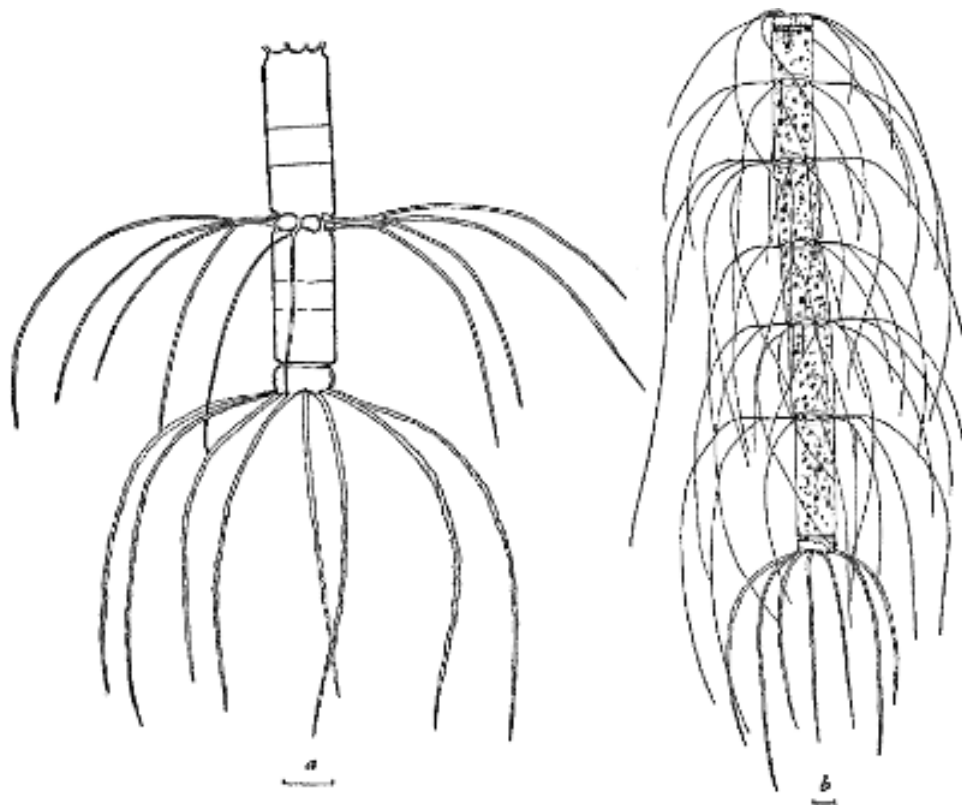

Fig. 58. *Bacteriastrum comosum* Pav. a, posterior cells and setae of a chain in girdle view; diameter, 12 μ . b, entire chain, girdle view; diameter, 17 μ .

with deep furrow, with the setae, usually eight, sometimes six, curved umbrella-like toward the inner part of the chain. Posterior valve also with furrow, the setae stronger than the rest, and with spirally arranged little spines. Posterior setae bell-shaped, with ends slightly converging toward chain axis.

Oceanic. Subtropical species. Reported only occasionally off southern California.

Genus XXI. **CHAETOCEROS** Ehrenberg

1845. Ber. Akad. Wiss. Berl. 1844, p. 198.

Cells with oval section to almost or rarely completely circular in valve view; in broad girdle view quadrangular with straight sides and concave, flat, or slightly convex ends. Valve with a more or less flat end surface or *valve surface* (see fig. H, 1, 2, 3, *vs*) and a cylindrical part or *valve mantle* (fig. H, 1, 2, *vm*) which are bound together without a seam. A long thick or thin *seta*, bristle or awn (fig. H, 1, 2, 3, *s*), at each end of the long or *apical axis* (fig. H, 1 and 3, *A*) of the valve on the corners. The opposite setae of neighboring cells touch one another near their origin, usually directly or sometimes by a bridge, and fuse firmly at a point near their base (fig. H, 1, *bs*) holding the cells in chains, usually with large or small *apertures* or *foramina* (fig. H, 1, *a*) between the cells. Basal portion of the setae parallel to the *pervalvar axis* (fig. H, 1 and 2, *P*) or directed diagonally outward with the outer portion frequently perpendicular to the axis of the chain. In most species the length of the chain is limited by the formation of special end cells, *terminal setae* (fig. H, 1 and 2, *ts*), usually shorter and thicker and more nearly parallel to the chain axis than the others. In relatively few species are cells solitary.

Cell wall formed of two valves and one or two girdle bands (fig. H, 1 and 2, *vs*, *vm*, *g*). Two frequently unequally developed girdle bands always present in most species. Intercalary bands present in some species (fig. C, 8, *ib*; fig. 79), usually difficult to see without special preparations.

Cytoplasm (protoplast) either forms a thin layer along the cell wall or fills the greater part of the cell. Nucleus against the cell wall or central. Chromatophores vary greatly in number, size, form, and position in different species; may be one to several, small or large, but are constant for a given species and consequently indispensable for species demarcation. In many species pyrenoids are distinctly visible.

Resting spores formed in most neritic species. Only one spore formed in a vegetative cell, usually in cylindrical part near the girdle band of the mother cell, in some species near the cell end. Free ends of spores often armed with spines or spicules. Each spore with two valves, but only primary valve provided with a valve mantle. Younger resting spores often smooth. If spore lies near end of cell, one valve may be in common with that of mother cell, with valve mantle rudimentary and setae shorter and thicker than in vegetative cells. Such spores always in pairs; formed in adjacent cells simultaneously.

Auxospores known in only a few species. Contents of cell empty laterally and form a large globule or bladder within which the new daughter cell is formed.

Microspores known in several species. Formed by repeated divisions of nucleus and cytoplasm. Contain organized chromatophores. Locomotion observed in some species.

Great variations may be observed in chains of the same species from different localities and at different times of the year.

The genus *Chaetoceros* includes the greatest number of species of the truly planktonic diatoms, and is by far the most important one in abundance of species and number of cells in the temperate and subtropical eastern Pacific waters. In all, about one hundred forty species are recorded in Mills (1933). There are nearly fifty species included in the Scripps Institution records. A small number of species are oceanic, but the greater number are neritic. No entirely fresh-water species are known.

The genus has been divided into two subgenera *Phaeoceros* and *Hyalochaete*. These two groups are subdivided into sections. The classification is as follows:

Subgenus 1. **Phaeoceros** Gran, 1897 (Den Norske Nordh.-Exped. 1876–1878, Bot. Protoph., p. 10). Almost entirely large robust species with strong, thick, and in many species very long setae usually armed with longer or shorter little spines. Numerous chromatophores, globoid, along cell walls and also crowded in interior of cells and in the setae. Mostly oceanic.

Sec. I. *Atlantica* Ostenfeld, 1903. Direction of all setae alike in one plane except terminal setae which are distinctly different from the others. Small spine usually present in center of valve. Aperture between cells wide.

- Species: 59. *C. atlanticus* (fig. 59-A)
C. atlanticus form *audax* (fig. 59-B, a)
C. atlanticus var. *skeleton* (fig. 59-B, b-c)
C. atlanticus var. *neapolitana* (fig. 59-B, d-e)
 60. *C. dichchaeta* (fig. 60)

Sec. II. *Borealia* Ostenfeld, 1903. Setae usually diverging in all directions, the directions on one valve often differing from those on the other. Terminal setae not distinctly different from others. Apertures between cells narrow. Usually no spine in center of valve.

- Species: 61. *C. eibenii* (fig. 61)
 62. *C. coarctatus* (fig. 62)
 63. *C. tetrastichon* (fig. 63)
 64. *C. dadayi* (fig. 64)
 65. *C. danicus* (fig. 65)
 66. *C. concavicornis*. (fig. 66. a-c)
C. concavicornis form *volans* (fig. 66, d)
 67. *C. convolutus* (fig. 67)
 68. *C. peruvianus* (fig. 68, a-c)
C. peruvianus form *gracilis* (fig. 68, d-f)
 69. *C. pendulus* (fig. 69)

Subgenus 2. **Hyalochaete** Gran, 1897 (Den Norske Nordh.-Exped. 1876–1878, Bot. Protoph., p. 11). Chromatophores one or several plates, more seldom numerous granules. Setae usually thin, only exceptionally with chromatophores in them. Nucleus and chromatophores near the wall. Chiefly neritic. Resting spores known in most of the species.

A. *Each Cell with More than Two Chromatophores*

Sec. I. *Oceanica* Ostenfeld, 1903; emended by Lebour, 1930. Chromatophores rather large, 6–10. Setae coalesced along a short portion of their length. No resting spores known. Oceanic.

- Species: 70. *C. decipiens* (figs. 70-A; 70-B, a-b)
C. decipiens form *singularis* (fig. 70-B, c-d)

Sec. II. *Dicladia* (Ehrenberg) Gran, 1905; emended by Lebour, 1930. Like *Oceanica*, but with setae not always coalesced for a portion of their length. Resting spores with two horns armed with small branches on primary valves. Neritic.

- Species: 71. *C. lorenzianus* (fig. 71)

Sec. III. *Cylindrica* Ostenfeld, 1903. Valves nearly circular. Apertures very narrow. Chromatophores small, numerous. Terminal setae not thicker than others. Resting spores about middle of the cells, smooth or with spines.

- Species: 72. *C. teres*. (fig. 72)
 73. *C. lauderi* (fig. 73)

Sec. IV. *Compressa* Ostenfeld, 1903. Cells compressed. Apertures usually moderately large. Terminal setae little different from others. Inner setae of two forms, thinner normal setae and intercalary thickened and twisted ones. Chromatophores numerous. Resting spores smooth or with a row of spicules.

Species: 74. *C. compressus* (fig. 74)

B. *Each Cell, with One or Two Chromatophores*

Sec. V. *Protuberantia* Ostenfeld, 1903. Two chromatophores, each with a large pyrenoid situated in a protuberance in the middle of the valve surface. Resting spores with two long horns.

Species: 75. *C. didymus* (fig. 75-A)

C. didymus var. *protuberans* (fig. 75-B, a)

C. didymus var. *anglica* (fig. 75-B, b-c)

Sec. VI. *Constricta* Ostenfeld, 1903. Chromatophores one or two. Cells more or less constricted. Valve mantle on girdle-band margin with a concave channel-like sulcus or groove. Girdle at least one-third the length of the cell. Terminal setae mostly thicker than the others. Resting spores about the middle of the cell with numerous spines on both valves.

Species: 76. *C. constrictus* (fig. 76)

77. *C. vanheurcki* (fig. 77)

Sec. VII. *Stenocincta* Ostenfeld, 1903. One chromatophore. Girdle narrow, not one-third the length of the cell. Apertures rather narrow. Terminal setae thicker than others, curved and for the most part diverging greatly. Resting spores about middle of cell, with numerous spines on both valves; the two valves not essentially different-at most the spines of one limited to the middle of the valve, on the other uniformly distributed.

Species: 78. *C. affinis* (figs. 78-A(1) , 78-A(2))

C. affinis var. *circinalis* (fig. 78-B)

C. affinis var. *willei* (fig. 78-C)

79. *C. costatus* (fig. 79)

Sec. VIII. *Laciniosa* Ostenfeld, 1903. Chromatophores one or two. Girdle rather long. Apertures large. Terminal setae usually thicker than the others, not diverging greatly. Resting spores smooth or with minute spines on primary valve, not in the middle of the cell.

Species: 80. *C. laciniosus* (fig. 80)

81. *C. pelagious* (fig. 81)

82. *C. brevis* (fig. 82)

Sec. IX. *Diadema* (Ehrenberg) Ostenfeld, 1903; emended by Gran, 1905. One chromatophore. Chains long with conspicuous terminal setae. Primary valve of resting spore with branched process or crown of spines, or sometimes smooth. Occasionally both valves armed.

Species: 83. *C. subsecundus* (fig. 83)

84. *C. seiracanthus* (fig. 84)

85. *C. holsaticus* (fig. 85)

86. *C. difficilis* (fig. 86)

Sec. X. *Diversa* Ostenfeld, 1903. Short rigid chains. Inner setae of two kinds. Terminal setae less spread out than a special pair of setae in middle of cell. One chromatophore.

Species: 87. *C. diversus* (fig. 87)

88. *C. laevis* (fig. 88)

89. *C. messanensis* (figs. 89-A, 89-B)

Sec. XI. *Brevicatenata* Gran, 1905. One or two chromatophores. Short straight chains, few joints. Terminal setae very thin, more or less different from others. Mostly small or very small forms.

Species: 90. *C. similis* (fig. 90)

91. *C. wighami* (fig. 91)

92. *C. perpusillus* (fig. 92)

Sec. XII. *Curviseta* Ostefeld, 1903; emended by Gran, 1905. One chromatophore. Setae curved, all bent in one direction. Chains usually curved, without special end cells.

Species: 93. *C. curvisetus* (fig. 93)

94. *C. pseudocurvisetus* (fig. 94)

95. *C. debilis* (fig. 95)

Sec. XIII. *Anastomosantia* Ostefeld, 1903, Setae united by a bridge.

Species: 96. *C. anastomosans* (fig. 96)

Sec. XIV. *Furcellata* Ostefeld, 1903. One chromatophore. Terminal setae not differentiated. Resting cells excentrically arranged in mother cell, lying close together two and two, with thick coalesced setae; with smooth valves or with short spines.

Species: 97. *C. radicans* (fig. 97)

98. *C. cinctus* (fig. 98)

99. *C. tortissimus* (fig. 99)

Sec. XV. *Socialia* Ostefeld, 1903. Chains curved, embedded in mucilage, forming irregularly spherical colonies. One chromatophore. Resting spores smooth or with small spines.

Species: 100. *C. socialis* (fig. 100)

Sec. XVI. *Simplicia* Ostefeld, 1903. Cells living singly or two or three together. In case of chain formation without differentiated terminal setae.

Species: 101. *C. gracilis* (fig. 101)

102. *C. vistulae* (fig. 102)

Subgenus 1. **PHAEOCEROS**

Section I. **Atlantica**

59. **Chaetoceros atlanticus** Cleve

Figure 59-A (p. 104)

1873. Bih. Kongl. Svensk. Vet.-Akad. Handl., vol. 1, no. 13, p. 11, pl. 2, fig. 8.

Chains straight, flat, not twisted, 10–26 μ broad (breadth = length along apical axis of cell). Cells in broad girdle view oblong. Valves with a small spine in the center of each cell. Apertures between cells hexagonal, large, but smaller than cells. Valve mantle rather low, one-third the length of cell or less, making three zones nearly equal. Distinct constriction at suture between mantle and girdle. Setae arising slightly within valve margin, base narrow, then usually widened and later tapered. Terminal setae always shorter than others, at first diagonal, farther out bent in so that points are about parallel to chain axis. Inner setae usually almost straight, approximately in apical plane. In some specimens all setae, particularly terminals, definitely clubbed (fig. 59-A, c).

Oceanic. Typically northern, arctic and boreal, but occasionally found off southern California. Never abundant.

Form **audax** (Schütt) Gran

Figure 59-B, a (p. 105)

1895. Schütt. Ber. Deutsch. Bot. Ges., vol. 13, p. 47, fig. 25, a, b (*Chaetoceros audax*).

1904. Gran. Fauna Arctica, vol. 3, no. 3, p. 529, pl. 17, fig. 8.

Occurs singly. With setae more curved than in the type and inclining toward one another at their extremities. According to Hustedt (1930, p. 648), may be only a transient stage and a starting point for a new chain of *C. atlanticus* rather than a separate form and consequently not entitled to an independent name. Doubt remains, however, concerning the origin of this single cell. Width 22 μ .

Rare. Found in Alaskan waters.

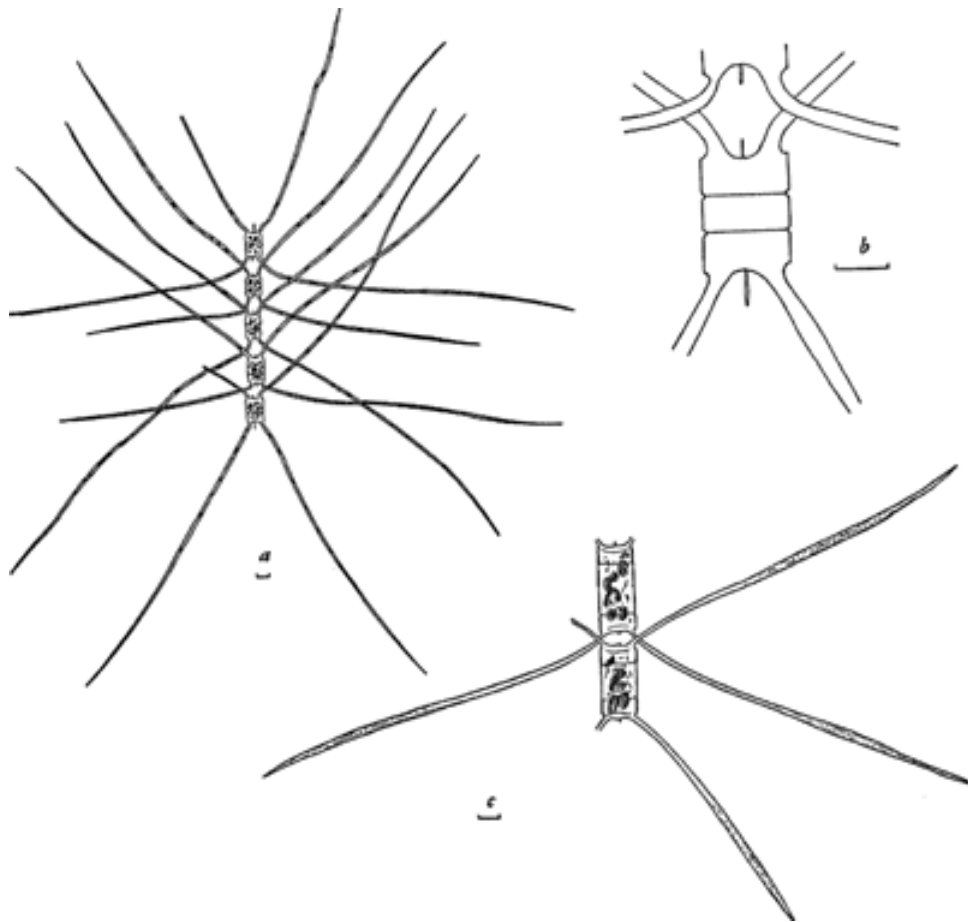

Fig. 59-A. *Chaetoceros atlanticus* Cl. *a*, entire chain, broad girdle view; width 18μ . *b*, end cell of chain shown in (*a*). *c*, part of a chain with clubbed setae (from Scotch Cap, Alaska); width, 15μ .

Variety **skeleton** (Schütt) Hustedt

Figure 59-B, *b, c*

1895. Schütt. Ber. Deutsch. Bot. Ges., vol. 13, p. 45, pl. 5, fig. 19 (*Chaetoceros skeleton*).

1930. Hustedt. Kieselalgen, pt. 1, pp. 643–645, fig. 365.

Differs from the type in greater development of the cell in the apical direction, and in the lower valve mantle which amounts to only about one-tenth the length of the apical axis. Basal part of setae longer than in the type, crossing point farther outside chain, consequently aperture is large in relation to cell. Setae usually thinner than in the type, widening beyond base, less striking or absent. Cells $17\text{--}26\mu$ wide.

Very rare. Found occasionally off southern California.

Variety **neapolitana** (Schröder) Hustedt

Figure 59-B, *d, e*

1900. Schröder. Mitt. Zool. Sta. Neapel, vol. 14, p. 29, pl. 1, fig. 4 (*Chaetoceros neapolitanus*). 1930. Hustedt. Kieselalgen, pt. 1, p. 645, fig. 366.

Chains narrower than in the type, $6\text{--}9\mu$ wide. Basal part (before fusion) of setae longer, greater than diameter of cell. Height of valve almost equal to or even greater than length along apical axis. Aperture considerably lengthened. Valves with (fig.

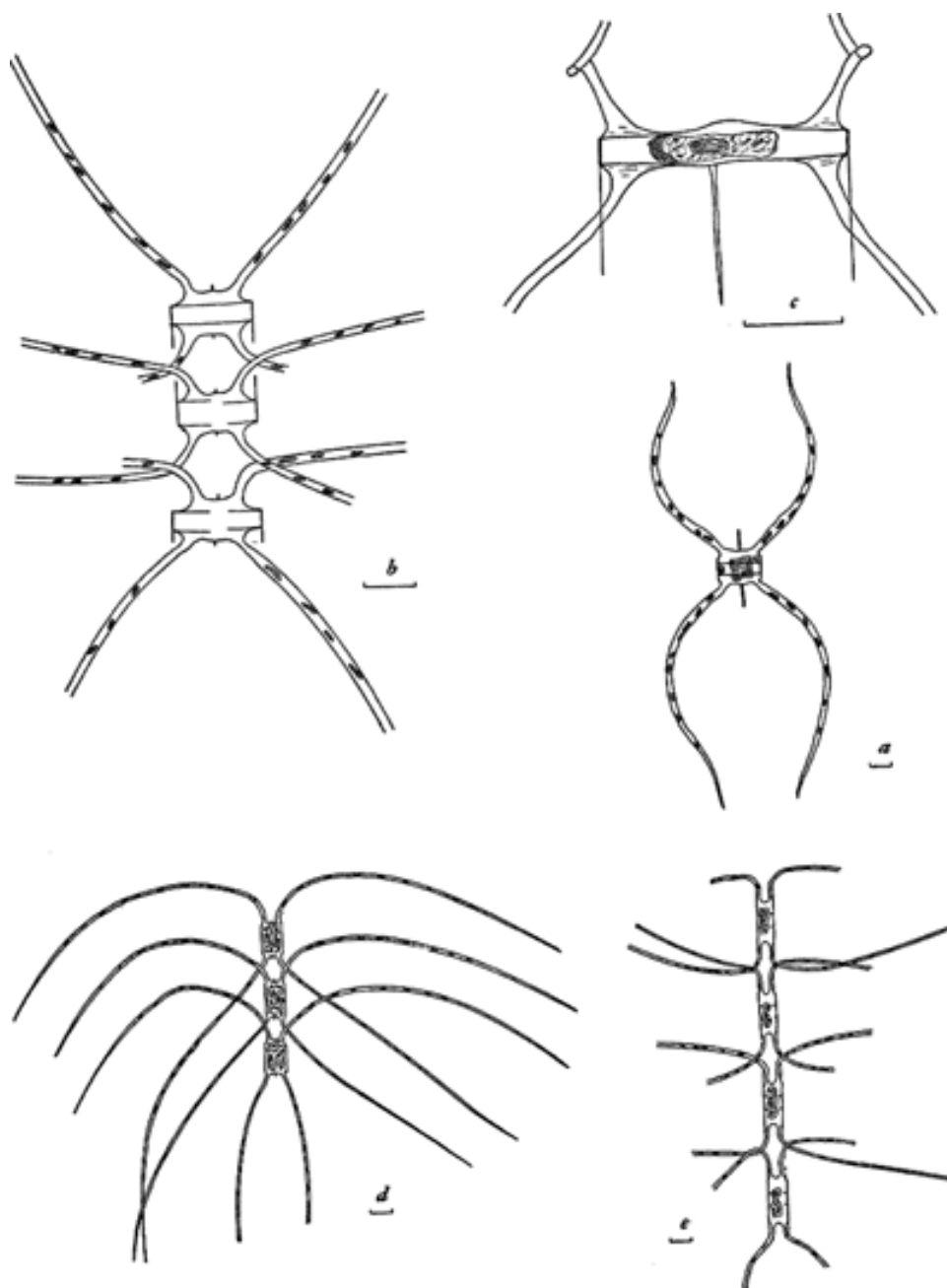

Fig. 59-B. *a*, *Chaetoceros atlanticus* form *audax* (Schütt) Gran; width, 22μ . *b* and *c*, *C. atlanticus* var. *skeleton* (Schütt) Hust. *b*, chain in broad girdle view; width, 17μ . *c*, recently divided cell; width, 26μ . *d* and *e*, *C. atlanticus* var. *neapolitana* (Schröd.) Hust. *d*, chain in broad girdle view; width, 9μ . *e*, chain in broad girdle view; width, 6μ .

59-B, *d*) or without (fig. 59-B, *e*) a small spine in the center. Hustedt (1930) shows a spine in his original drawing, figure 366b, but no spine in figure 366a (after Schröder, 1900) or figure 366c (after Gran and Yendo, 1914).

More southerly in distribution than type. Reported in numbers up to 34,000 cells per liter off southern California in August. Also abundant in February and March.

60. *Chaetoceros dicaeta* Ehrenberg

Figure 60

1845. Ber. Akad. Wiss. Berl. 1844, p. 200.

Valves rounded, with more or less well-developed, often very flat valve mantle. Setae arising rather far inside valve margin. Bases of setae long, at first parallel to chain axis, then bent outward at nearly right angles to chain axis. Terminal setae parallel to chain axis at base, then bent at nearly right angles, later bent again so that they are once more nearly parallel to chain axis. Chain more or less long, straight, not twisted, stiff, and very delicate. Apertures between cells large, six-sided. Cells $7\text{--}13\mu$ wide.

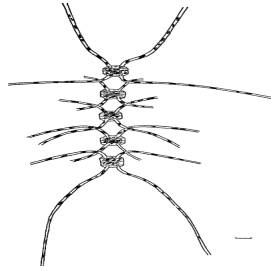

Fig. 60. *Chaetoceros dicaeta* Ehr. Chain in broad girdle view; width, 13μ .

Reported off southern California usually from February to May, occasionally in August. Not common. Oceanic. Temperate species.

Section II. **Borealia**

61. *Chaetoceros eibenii* Grunow

Figure 61

1880–85. In V. H. Syn., pl. 82, figs. 9, 10.

Cells cylindrical, broadly elliptical in valve view. Chains straight, not twisted, $25\text{--}50\mu$ broad. Apertures rather flat, hexagonal. Valve surface flat; mantle moderately low, one-third the length of cell or less with shallow constriction at suture with girdle. Valves with minute, hardly visible spine in center. Setae arising from near corner of cell, crossing each other very near bases, curved outward from apical plane, half of them nearly parallel to transapical axis. Setae

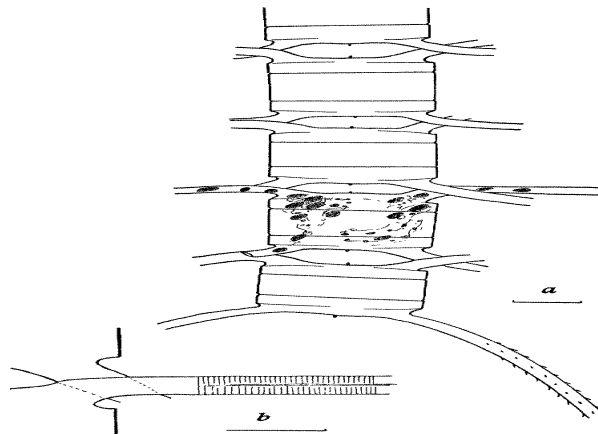

Fig. 61. *Chaetoceros eibenii* Grun. a, chain in broad girdle view; width, 25μ . b, section of a seta showing fine striations.

armed with minute spines, farther out with fine striations, 20–22 in 10μ . Setae reported as hexagonal in cross section by Meunier (1913), four-sided by Hustedt (1930). Found here to be hexagonal. (See fig. C, 8.)

Neritic. Not common. Recorded rarely off southern California and Lower California.

62. *Chaetoceros coarctatus* Lauder

Figure 62

1864. Trans. Micr. Soc., N.S., vol. 12, p. 79, pl. 8, fig. 8.

Cells cylindrical, elliptical in valve view. Chains long, robust in appearance, with two ends markedly different, 30–44 μ wide. Apertures very small. Valve surface flat, with

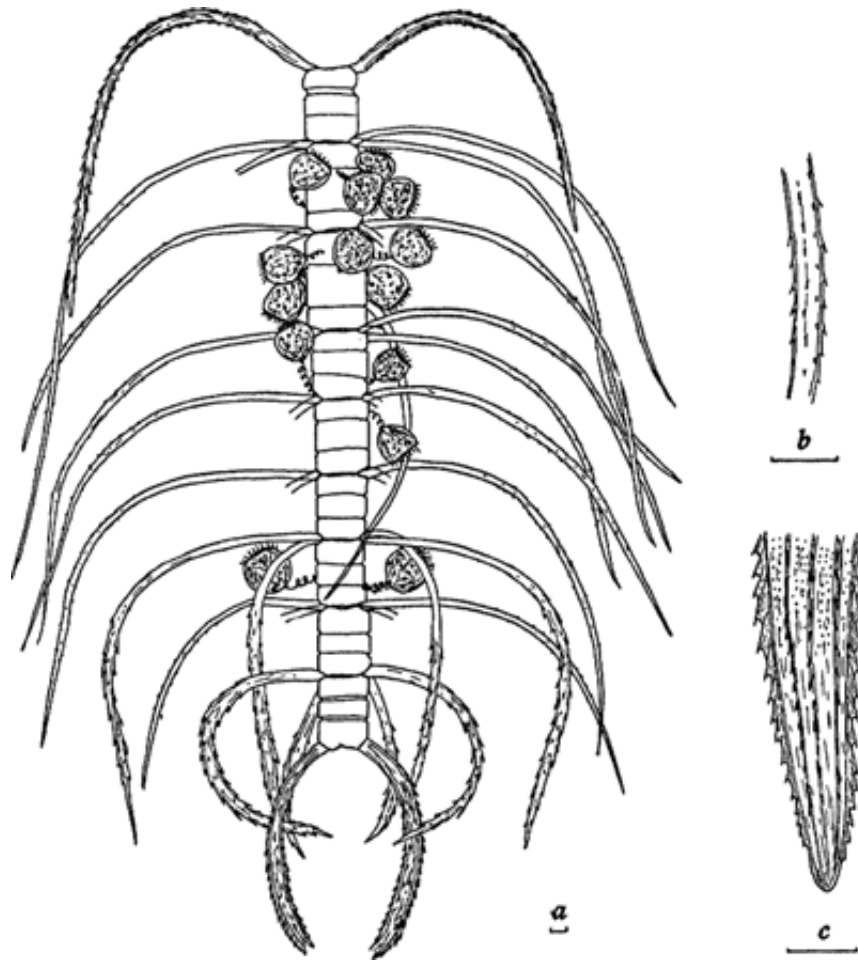

Fig. 62. *Chaetoceros coarctatus* Laud. a, entire chain (note attached *Vorticella oceanica*); width, 33 μ . b, section of inner seta, midway in chain. c, tip of posterior terminal seta.

rather high mantle, one-third to two-thirds the apical axis. More or less deep but always distinct constriction at suture between mantle and girdle band. Posterior terminal setae large, strongly curved, heavily spined, shorter than others; anterior terminal setae less robust, curved toward posterior end, spined less heavily; setae in center of chain curved like anterior terminal setae, spined. Setae with rows of fine puncta running lengthwise visible usually only on posterior terminal setae where they occur in double rows. Usually found with a species of *Vorticella* (probably *Vorticella oceanica*) attached, sometimes in large numbers.

Oceanic. Reported off Lower California in latitude 27°25' north. Not common. A tropical or subtropical species.

63. *Chaetoceros tetrastichon* Cleve

Figure 63

1897. Treat. phytopl. Atl. trib., p. 22, pl. 1, fig. 7.

Chains very short, usually three sometimes four cells long, not twisted, 18–20 μ wide. Apertures very small or almost absent. Valve surface flat with moderately high mantle

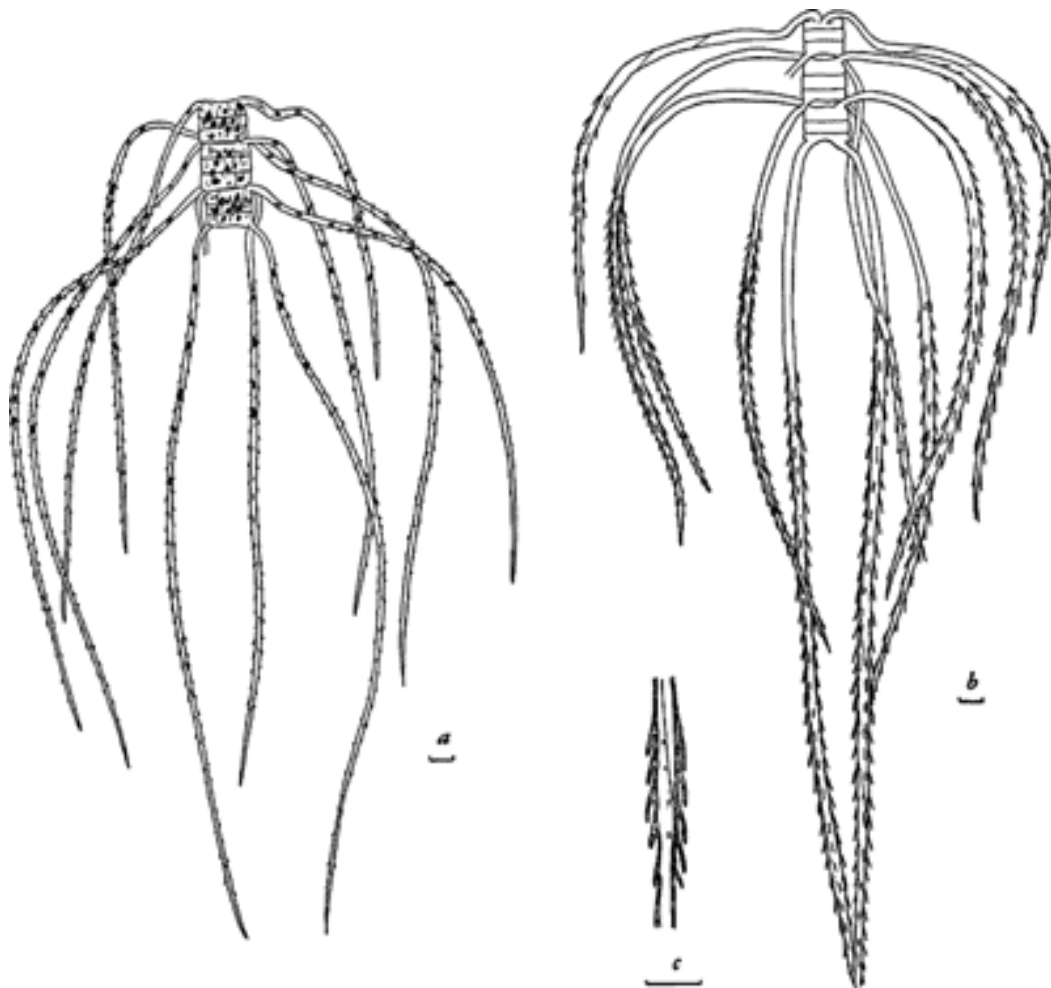

Fig. 63. *Chaetoceros tetrastichon* Cl. a, entire chain, broad girdle view; width, 20 μ . b, entire chain (found off Lower California); width, 18 μ . c, section of posterior terminal seta of (b).

(one-third to one-half the length along apical axis). Shallow sulcus at suture between mantle and girdle. Setae arising from margin of valve, curved outward, almost at right angles to chain, toward ends turned nearly parallel to chain axis. Posterior terminal setae lie nearly in chain axis. All setae nearly equal in size, delicately striated, with spirally arranged spines. Appear to be more heavily spined in warmer waters (as in fig. 63, b) off Lower California (about lat. 24° 40' N.), than off southern California. Often found with *Tintinnus inquilinus* attached to chain.

Oceanic. Tropical and south temperate species. Not common.

64. *Chaetoceros dadayi* Pavillard

Figure 64

1913. Bull. Soc. Bot. France, vol. 60, p. 131, fig. 2B.

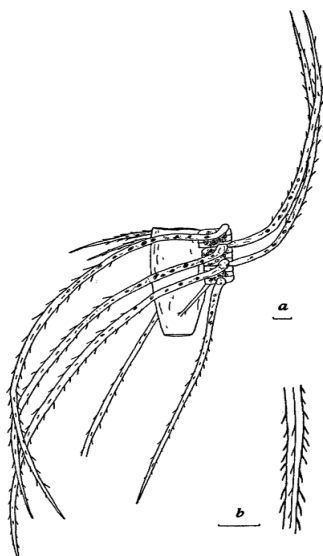

Fig. 64. *Chaetoceros dadayi* Pav. *a*, entire chain; width, 15μ (note *Tintinnus inquilinus* attached). *b*, section of posterior seta.

Very similar to *C. tetrastichon*, in general differentiated only by the formation and direction of the setae. Chains short and straight, usually of three cells, $10\text{--}15\mu$ wide. Apertures very narrow or almost lacking. Setae arising from valve corners without a basal part. On one side of chain setae very short and rudimentary, on the other side well developed, very long, and with fine spines. The two setae of the outer cell run toward one cell end; of the inner setae half are directed toward one end of the chain, half toward the other. Also usually found with *Tintinnus inquilinus* attached.

Oceanic. Tropical and south temperate. Rare. Possibly more common off southern California than *C. tetrastichon*.

65. *Chaetoceros danicus* Cleve

Figure 65 (p. 110)

1889. Pelag. Diat. Kattegat, p. 55.

Cells usually living singly, occasionally in short chains, with very small or no apertures. Width $7\text{--}15\mu$. Valve surface flat, mantle high (about one-third to two-thirds apical axis), with distinct groove on margin near girdle band. Girdle zone rudimentary. Setae arising near edge of valve outside apical plane, extending perpendicular to perivalvar or chain axis, then directed obliquely toward sides of apical plane so that they form a cross in valve view. Small spines on outer portion of setae.

Neritic. North temperate. Never very common off southern California. In June, 1923, recorded as occurring in numbers up to 8,000 cells per liter.

66. *Chaetoceros concavicornis* ManginFigure 66, *a-c* (p. 111)

1917. Compt. rend. séances Acad. Sci., vol. 164, pp. 704 and 770, figs. 5(I), 6, 7.

Described under *Chaetoceros criophilus* Gran, 1905, Diat. Nord. Plankt., p. 71, fig. 85.

Cells in straight broad chains $12\text{--}30\mu$ wide, or single cells. Valves unlike; upper valve with higher cylindrical valve mantle, without a notch at suture, rounded surface, and setae springing from near the center; lower valve with a lower mantle, flat surface, and setae springing from near the margin. Girdle zone rudimentary, but distinct zone formed before

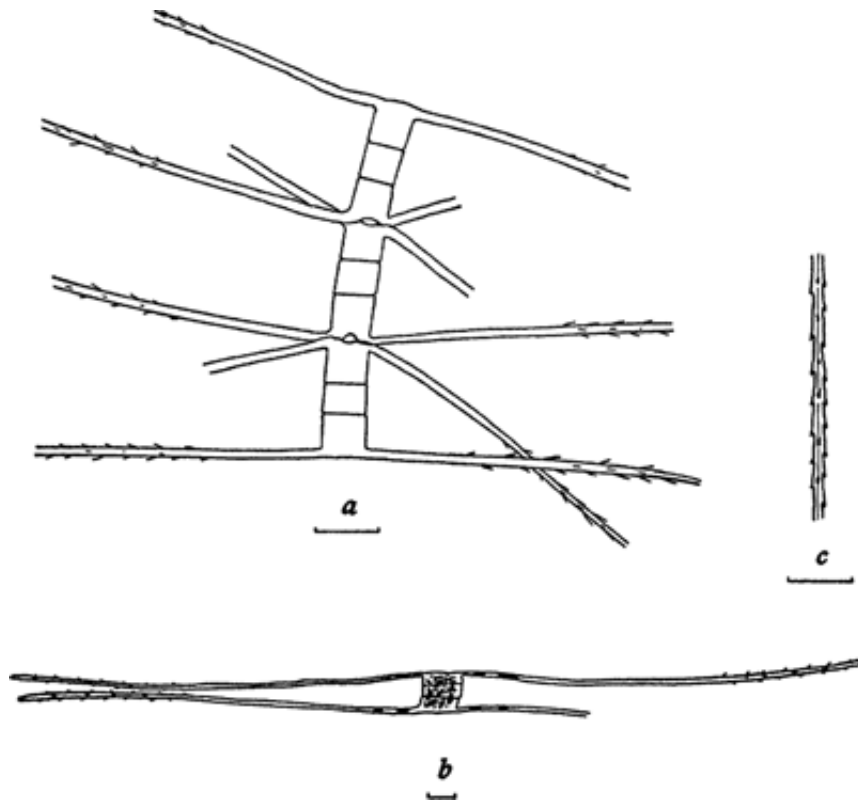

Fig. 65. *Chaetoceros danicus* Cl. *a*, chain in broad girdle view; width, 7μ . *b*, single cell showing chromatophores; width, 13μ . *c*, section of seta of cell shown in (*b*).

cell division. Setae thin at their bases, thicker outward, all bent toward lower end of chain, curving inward so that outside outline is concave; with small spines, more outstanding farther out. Apertures always distinct, broad above, narrow below.

Oceanic. Boreal-arctic form. Fairly common but not abundant off southern California and northward.

Form volans (Schütt) Hustedt

Figure 66, *d*

1895. Schütt. Ber. Deutsch. Bot. Ges., vol. 13, p. 45, fig. 20 (*Chaetoceros volans*).

1930. Hustedt. Kieselalgen, pt. 1, p. 666, fig. 377.

Differs from the type mainly in the direction of the setae of the arched valve. Setae like those in type at base, then bent around semicircularly, for a short distance turned downward, then turned sharply outward, and from there turned almost at right angles to the chain axis. Cells usually solitary, occasionally in short chains. In addition the setae are more slender than in the type, and usually less strongly spined at the base.

More southerly than the type. Common but never abundant.

67. *Chaetoceros convolutus* Castracane

Figure 67 (p. 112)

1886. Diat. Chall.-Exped., p. 78, text fig.

Chains straight or more or less passively bent, $15\text{--}23\mu$ broad. Valves unlike, upper rounded, lower flat. Valve mantle about one-third the height of cell, middle third of cell being girdle zone. Definite conspicuous notch between valve mantle and girdle. Setae relatively thin, arising near center of valve on the upper, near the margin on the lower. From starting point outward, setae curve toward opposite side, from point of fusion all more or

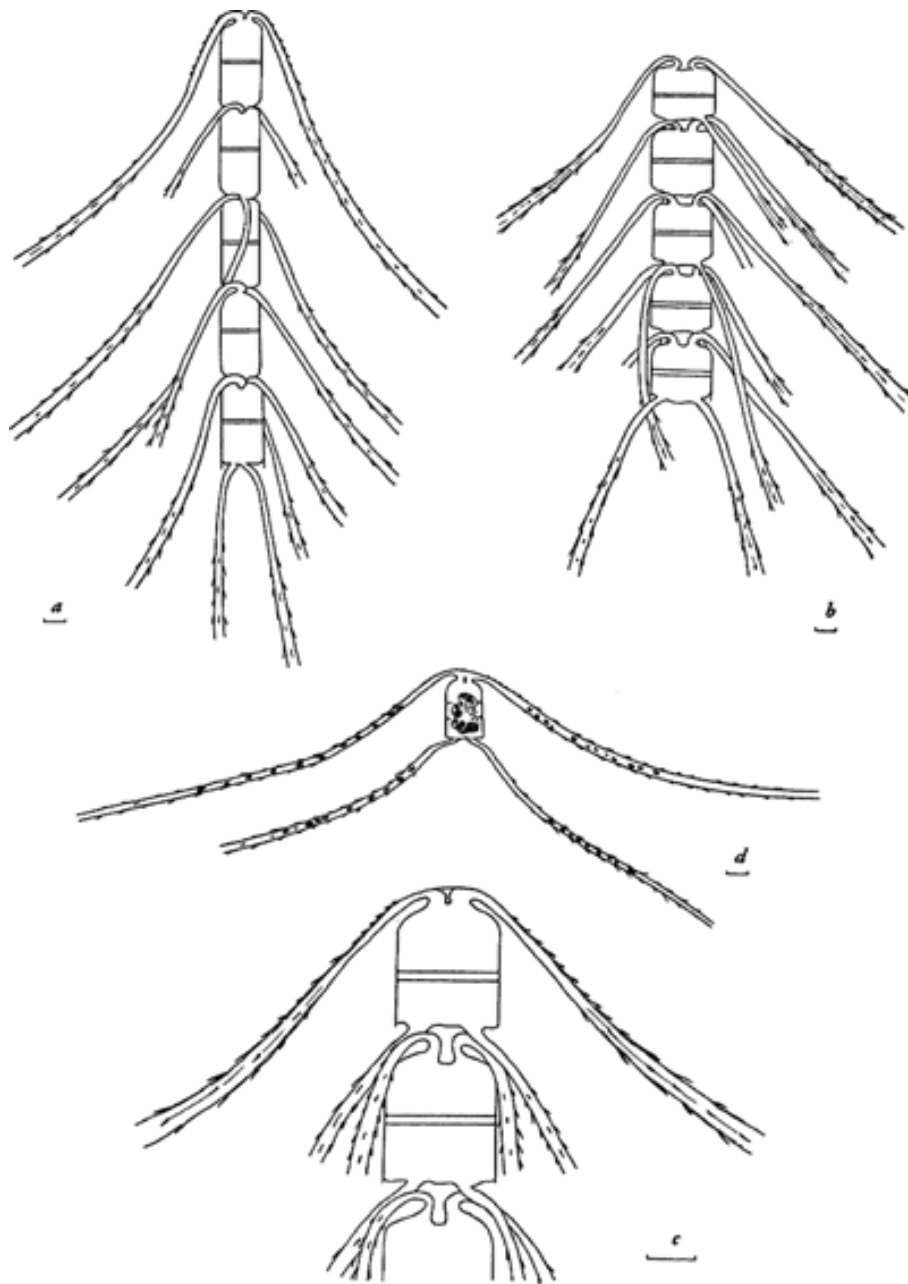

Fig. 66. *a-c*, *Chaetoceros concavicornis* Mang. *a* and *b*, two chains, broad girdle view; widths: *a*, 18μ ; *b*, 28μ *c*, part of a chain; width, 23μ . *d*, *c. concavicornis* form *volans* (Schütt) Hust., solitary cell; width, 16μ .

less strongly bent toward lower end of chain. Armed with slender spines but less strongly than *C. concavicornis*. Apertures between cells partly or wholly covered by the setae.

Oceanic. Arctic and boreal form. Recorded frequently off southern California from late February to middle of June. As many as 1,500,000 cells per liter recorded in one catch, between 100,000 and 500,000 cells per liter being not uncommon.

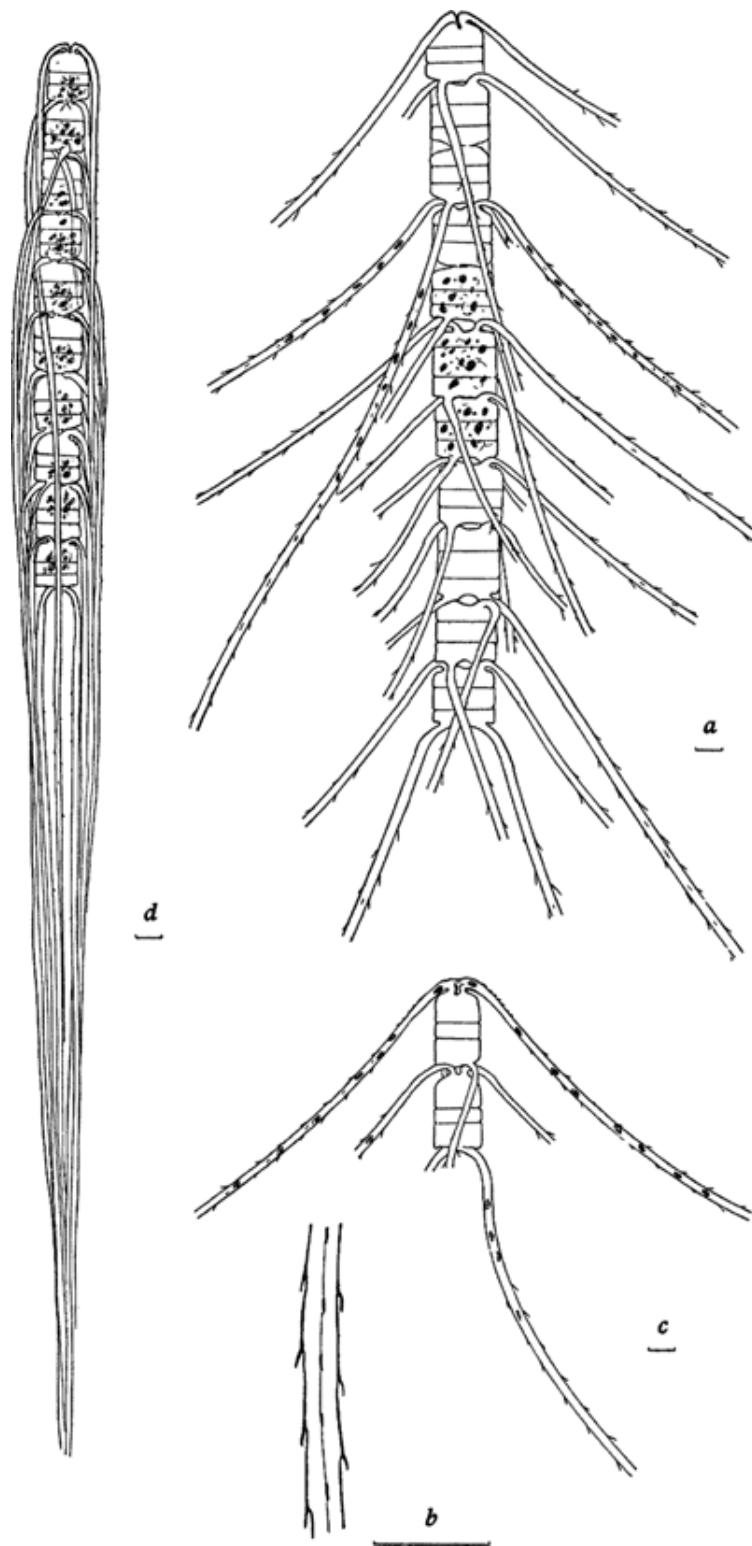

Fig. 67. *Chaetoceros convolutus* Castr. *a*, entire chain, broad girdle view; width, 23μ . *b*, section of a seta from chain shown in (*a*). *c*, short chain, broad girdle view; width, 18μ . *d*, chain with setae close to cells; width, 16μ .

68. *Chaetoceros peruvianus* BrightwellFigure 68, *a-c*1856. Quart. Jour. Micr. Sci., vol. 4, p. 107, pl. 7, figs. 16-18; 1858, *ibid.*, vol. 6, pl. 8, figs. 9, 10.

Cells usually solitary, seldom building short chains, 16–32 μ broad. Valves elliptical. Valves unlike, the upper rounded, lower flat, both with similarly constructed valve mantles which vary greatly from one-sixth to equal the length of the apical axis; on girdle-band margin with hollow channel-like groove of varying size, but always very distinct. Setae of upper valve arising from near center, turning sharply and running backward in more or less wide, outwardly convex curves after short basal region. At the end more or less divergent to convergent. Setae of lower valve springing from near margin, slightly convex toward outside, more nearly parallel to chain axis than those of upper valve. At end more or less divergent or even convergent. All setae strong, 3–5 μ thick, four-sided, with strong spines; striated, 20–22 striae in 10 μ .

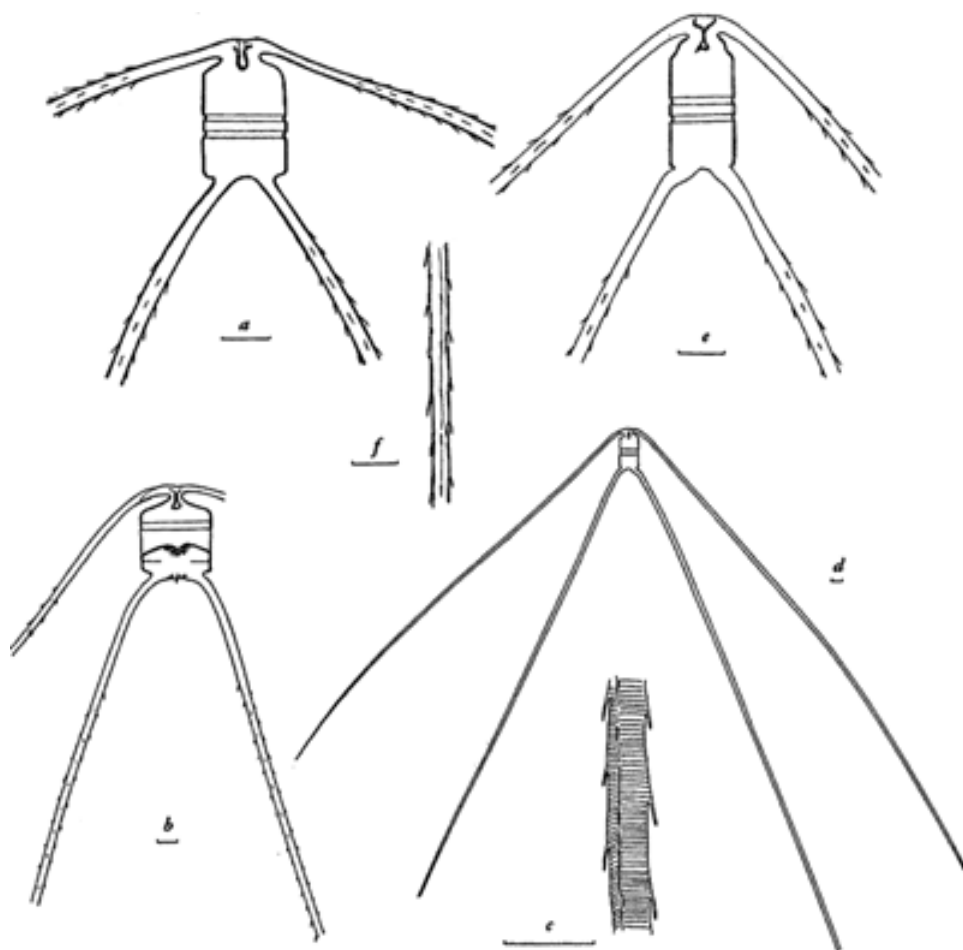

Fig. 68. *a-c*, *Chaetoceros peruvianus* Brightw. *a*, single cell; width, 18 μ . *b*, dividing cell; width, 32 μ . *c*, section of a seta of (*a*). *d-f*, *C. peruvianus* form *gracilis* (Schröd.) Hust. *d*, entire cell; width, 15 μ . *e*, cell shown in (*d*). *f*, section of seta of same cell.

Oceanic. In south temperate to warmer seas. Occasionally recorded in large numbers in August (up to 900,000 cells per liter) off southern California.

Form *gracilis* (Schröder) HustedtFigure 68, *d-f*1900. Schröder. Mitt. Zool. Sta. Neapel, vol. 14, p. 29, pl. 1, fig. 5 (*Chaetoceros peruvianus* var. *gracilis*).1930. Hustedt. Kieselalgen, pt. 1, p. 672, fig. 381*b*.Differs from the type mainly by having more slender cells, 10-15 μ wide, higher valve mantle which exceeds the length of apical axis. Setae only 2-3 μ thick.69. *Chaetoceros pendulus* Karsten

Figure 69

1905. Deutsch. Tiefsee-Exped. "Valdivia," Antarktis., vol. 2, pt. 2a, p. 118, pl. 15, figs. 7, 7*a*.

Cells always solitary, 9-18 μ wide. Valves unlike. Upper with deep depression in the center, lower with projecting corners. Valve mantle about one-third of cell, slight notch at junction with girdle zone. Setae apparently entirely smooth, long, sloping diagonally outward from upper valve slightly beyond basal part, then running in large sweeping curve as in *C. peruvianus*. From lower valve curved much as in *C. peruvianus*; more nearly in chain axis than those on upper valve. Chromatophores very small, distributed far out in the setae. Small spine in depression of upper valve observed in some cells.

Oceanic. Probably fairly common off southern California but easily confused with *C. peruvianus* in water mounts under low magnification.

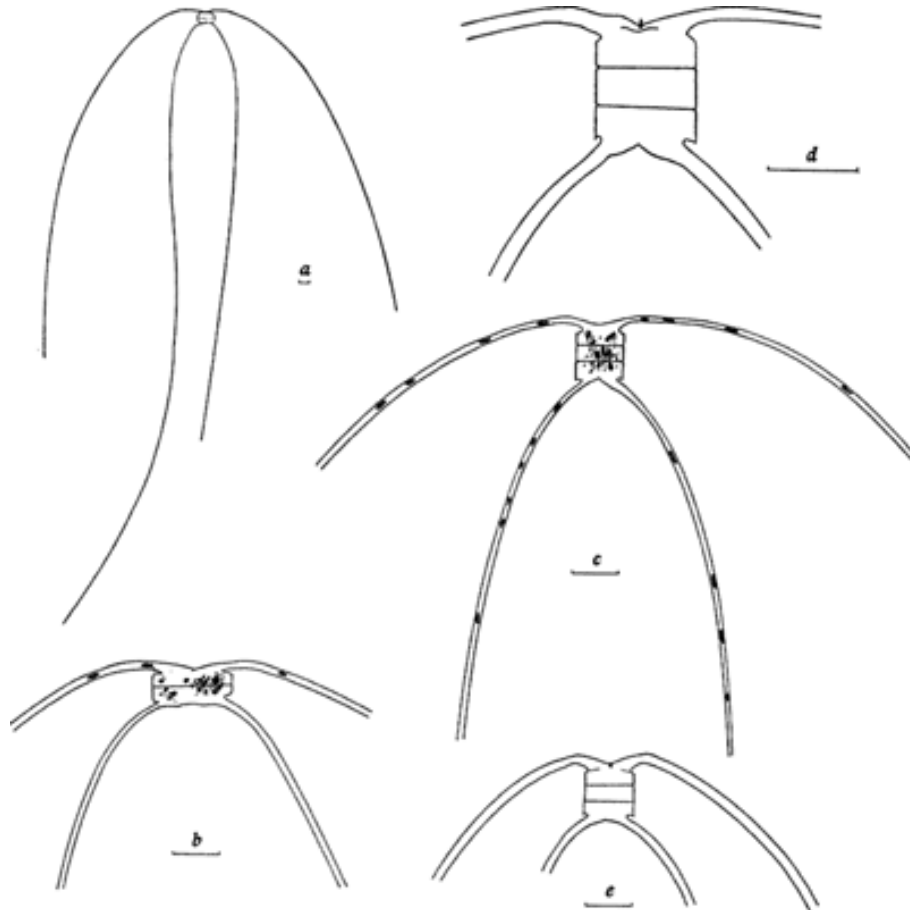

Fig. 69. *Chaetoceros pendulus* Karst. *a*, entire cell, broad girdle view; width, 18 μ . *b*, same cell as in (*a*), more highly magnified. *c*, entire cell (note chromatophores); width, 11 μ . *d*, same cell as in (*c*), more highly magnified. *e*, another cell; width, 11 μ .

Subgenus 2. **HYALCHAETE**Section I. **Oceanica**70. **Chaetoceros decipiens** CleveFigure 70-A; figure 70-B, *a, b*

1873. Bih. Kongl. Svensk. Vet-Akad. Handl., vol. 1, no. 13, p. 11, pl. 1, fig. 5.

Cells $9-84\mu$ wide, four-cornered in broad girdle view, with sharp corners touching those of adjacent cell. Chains straight, stiff, more or less flattened, usually many-celled. Apertures varying in size and shape according to season of year: in winter small, linear to lanceolate; in summer and autumn larger, elliptical or circular. Setae without a basal portion, arising

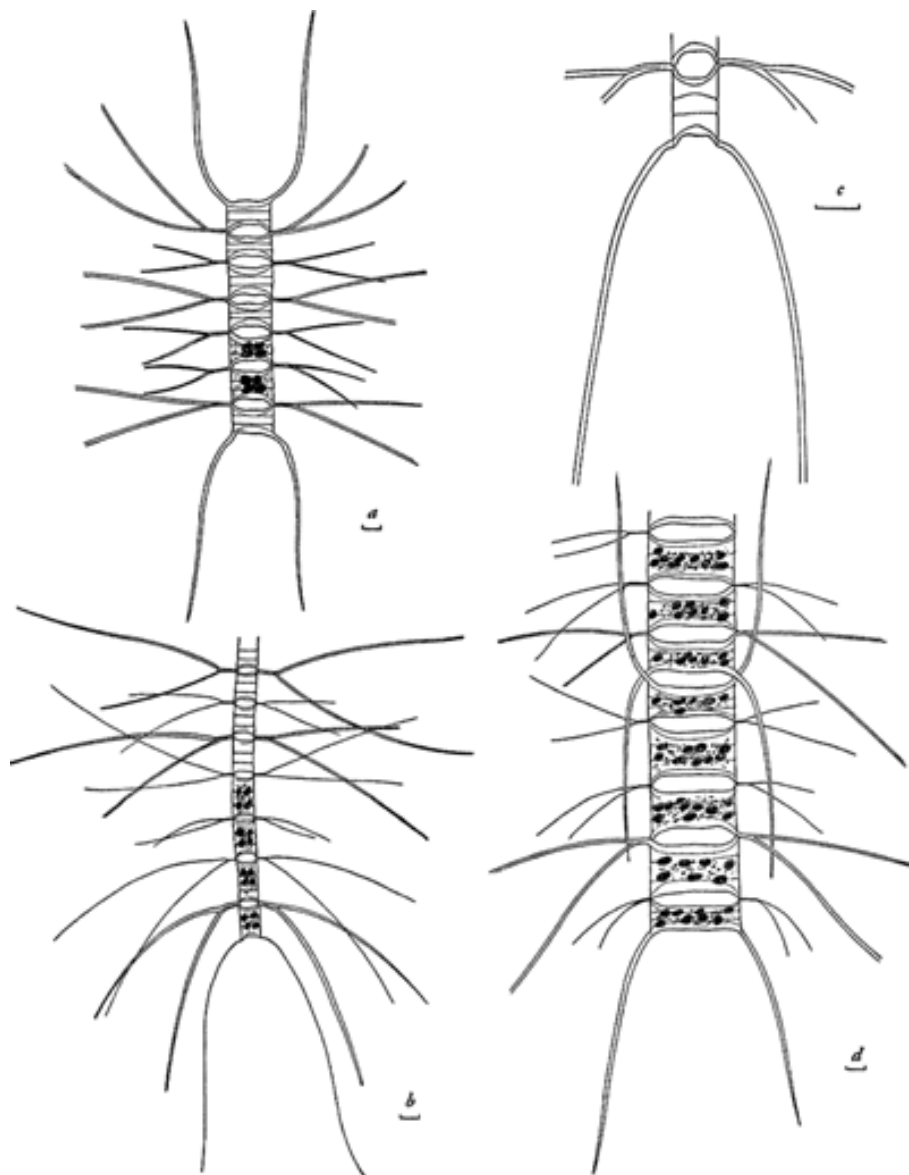

Fig. 70-A. *Chaetoceros decipiens* Cl. *a*, entire chain, broad girdle view; width, 22μ . *b*, part of a chain; width, 10μ . *c*, terminal cell and setae of a chain; width, 10μ . *d*, part of a chain (note large setae resembling terminal setae in center of chain); width, 42μ .

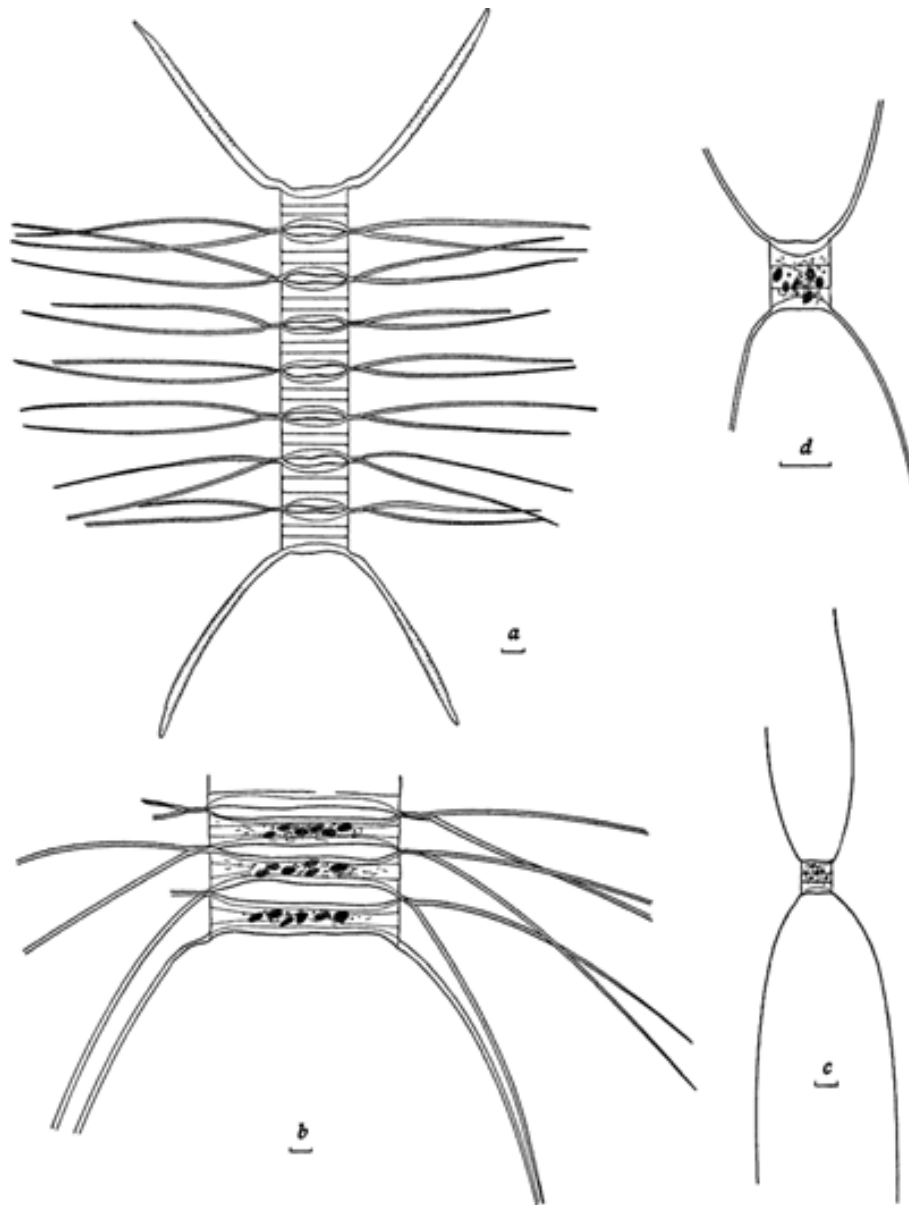

Fig. 70-B. *a* and *b*, *Chaetoceros decipiens* Cl. *a*, entire chain (note sculpturing similar to that found in *C. lorenzianus* on terminal setae); width, 30μ . *b*, part of a wide chain; width, 84μ . *c* and *d*, *C. decipiens* form *singularis* Gran. *c*, entire cell; width, 12μ . *d*, cell shown in (*c*), more highly magnified.

at corners of valves perpendicular to chain axis, fusing together in pairs for some distance, the fused portion two or three times as long as diameter of setae. Terminal setae shorter and thicker than others, first directed obliquely outward, then bent so that outer half is nearly parallel to chain axis. Setae without special sculpturing or with very fine spines and puncta. Sometimes with dots near the extremities. Occasionally so heavily punctated they resemble those of *C. lorenzianus*. Chromatophores 4–10 per cell. No resting spores known.

Oceanic. Arctic and boreal species. Abundant off southern California. Over 1,500,000 cells per liter recorded in May, 1918; about 500,000 cells per liter not uncommon. Large numbers frequently present from middle of March through early June.

Form *singularis* Grun

Figure 70-B, c, d

1904. Fauna Arctica, vol. 3, no. 3, p. 536, pl. 17, fig. 7.

Cells solitary, 12–14 μ broad, or forming short chains of 2–4 cells. Probably merely a stage of *C. decipiens*, possibly developed from microspore. Given as a synonym by Hustedt (1930).

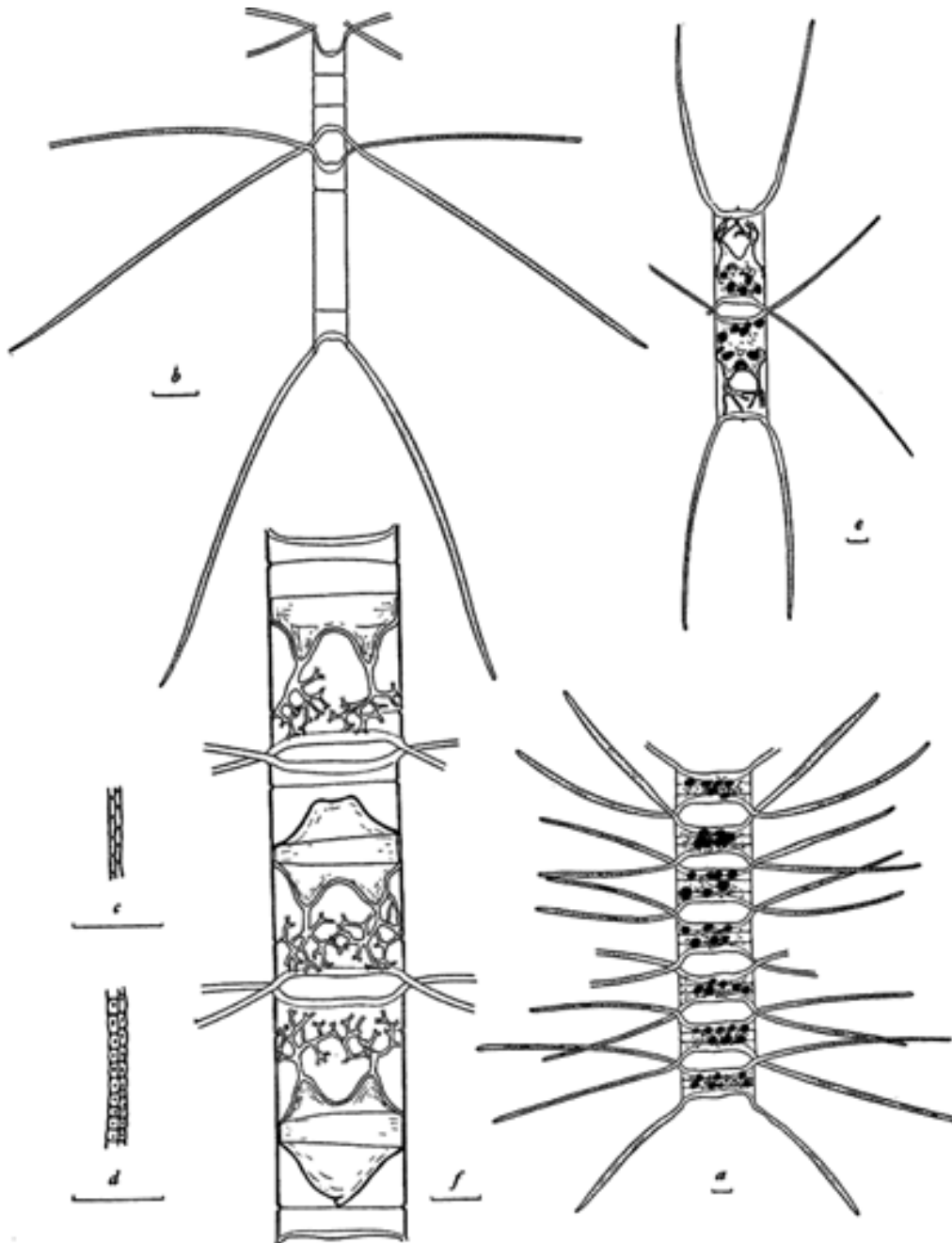

Fig. 71. *Chaetoceros lorenzianus* Grun. *a*, typical chain, broad girdle view; width, 32 μ . *b*, chain with long, narrow cells; width, 7 μ . *c*, section of inner seta. *d*, section of terminal seta. *e*, chain with resting spores in process of formation; width, 24 μ . *f*, chain with resting spores; width, 30 μ .

Section II. **Dicladia**71. **Chaetoceros lorenzianus** Grunow

Figure 71

1863. Verh. Zool.-Bot. Ges. Wien, vol. 13, p. 157, pl. 5, fig. 13.

Cells 7–48 μ wide, rectangular in broad girdle view. Chains straight, stiff. Apertures elliptical to oval. Valve surface flat or slightly elevated in center. Girdle zone usually short except in cells containing resting spores. Setae fused only at point of exit from margin; with very distinct transverse striae. Terminal setae diverging for their entire length. Chromatophores large, platelike, 4–10 per cell. Resting spores with primary valve bearing two conical protuberances each of which terminates in a solid dichotomously branched process. Secondary valve smooth.

Neritic. Tropical and temperate. Common off Lower California and southern California.

Section III. **Cylindrica**72. **Chaetoceros teres** Cleve

Figure 72

1896. Bih. Kongl. Svensk. Vet.-Akad. Handl., vol. 22, pt. 3, no. 5, p. 30, fig. 7.

Chains straight, 22–44 μ wide. Cells in broad girdle view four-cornered, with sharp corners, usually longer than broad. Valve mantle low, girdle zone very high, no constriction between mantle and girdle band. Setae arising from corners of cells, without differentiated basal part, perpendicular to chain axis, and extending obliquely on either side of apical plane. Chromatophores numerous, small. Resting spores in middle of much elongated cells, smooth, with very fine puncta on margin of primary valve from which arise fine fibrils.

Neritic. North temperate or boreal species. Not common off southern California. Most abundant March through May.

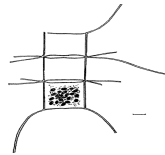

Fig. 72. *Chaetoceros teres* Cl. Chain in broad girdle view; width, 34 μ .

73. **Chaetoceros lauderi** Ralfs

Figure 73

1864. Trans. Micr. Soc., N.S., vol. 12, p. 77, pl. 8, figs. 3, 4.

Somewhat more delicate than *C. teres*, cells 18–24 μ broad, and with somewhat twisted chains. Otherwise differentiated from *C. teres* only by resting spores. Primary valve of resting spore strongly curved, narrowed between apex and cylindrical part, on outside of upper part armed with spines and at margin armed with a circle of parallel needles, directed upward. Lower valve flat. Spores very greatly, may not be narrowed in middle.

Neritic. South temperate form. Not common off southern California.

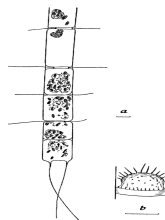

Fig. 73. *Chaetoceros lauderi* Ralfs. a, chain in broad girdle view; width, 24 μ . b, primary valve of resting spore; width, 18 μ .

Section IV. *Compressa*74. *Chaetoceros compressus* Lauder

Figure 74

1864. Trans. Mier. Soe., N.S., vol. 12, p. 78, pl. 8, fig. 6.

Cells 7–24 μ wide, four-cornered in broad girdle view, with rounded corners not touching

Fig. 74. *Chaetoceros compressus* Laud. *a*, typical chain, with thickened setae, broad girdle view; width, 7 μ . *b*, same chain as in (*a*), narrow girdle view. *c*, chain containing resting spores in process of formation; width, 11 μ . *d*, resting spore; width, 12 μ . *e*, another resting spore; width, 12 μ . *f*, chain with three auxospores; width of chain, 10 μ ; width of auxospore, 23 μ , *g*, auxospore from chain shown in (*f*). *h*, chain probably formed from auxospore; width, 26 μ .

those of adjacent cells. Valves slightly convex, or flat. Chains straight, with cells more or less twisted about the axis of the chain. Apertures four- or six-sided, slightly curved in the middle, more or less wide, sometimes only a slit. Setae arising within the margin of the valve, basal part always distinct, outer part perpendicular to chain axis, and then bent. Setae delicate except for some pairs often differentiated, usually near center of chain. These setae are shorter than the others, thickened, twisted and directed toward one end of chain almost parallel to chain axis. Chromatophores small, 4–20 in each cell. Resting spores in the middle of mother cell or at one end, with a thick girdle band fused to it; smooth, without row of small spines on upper margin in primary valve as recorded by Gran.

Neritic. Boreal to south temperate species. Very important species off California and Lower California coasts and in Gulf of California (Cupp and Allen, 1938). Very abundant off southern California from March through June and in some years again in November and December.

Auxospore formation was observed in this species by Meunier (1910) in Arctic material. SchÜtt (1893) figured auxospores of *C. medium* (a synonym of *C. compressus*), formed perpendicular to the chain. These closely resemble the chain shown in figure 74, *h*, which is separated, however, from the parent chain. Figure 74, *f* shows a chain with three auxospores. The chain appears to belong to *C. compressus*. The auxospores formed are approximately the same breadth as the chain in figure 74, *h*. Renee Le Blanc (1935) figured a chain with two auxospores which she placed in the species *C. pseudobreve* (synonym of *C. brevis*). The auxospores in her drawing and those in figure 74, *f* show a marked resemblance.

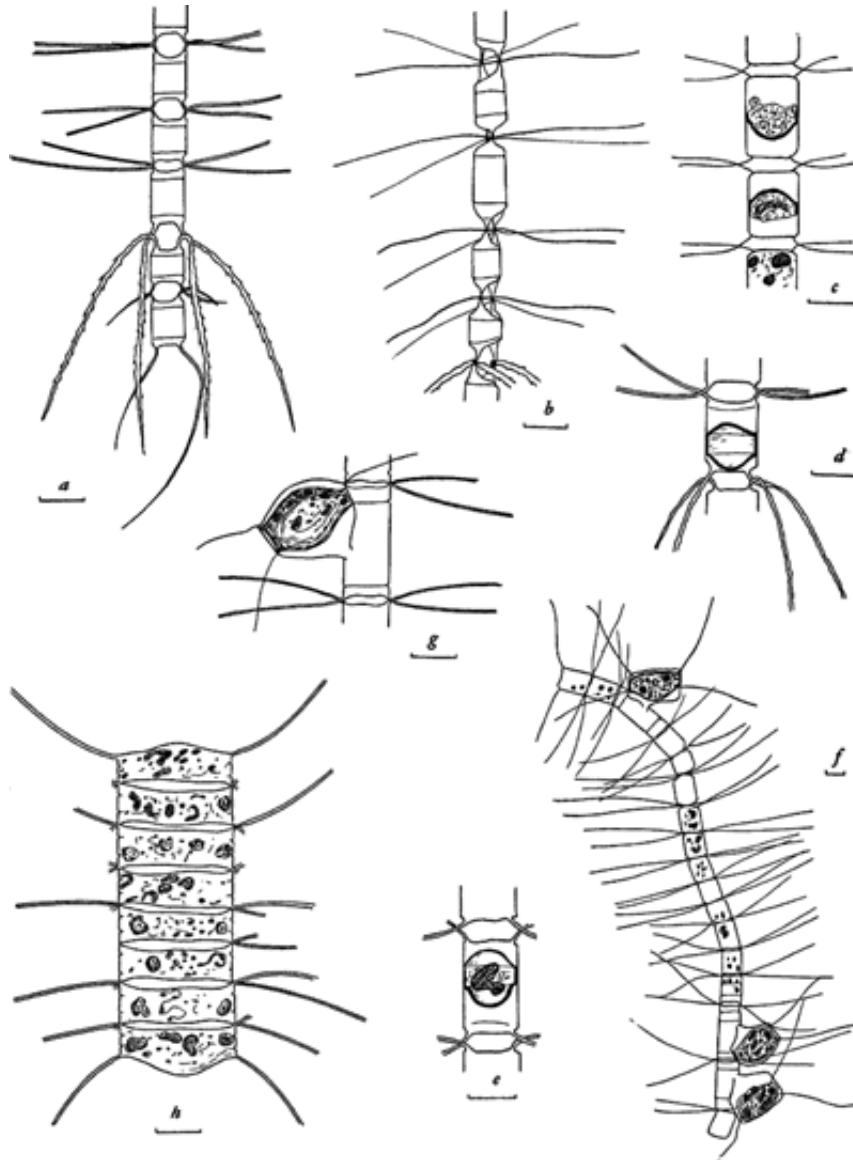
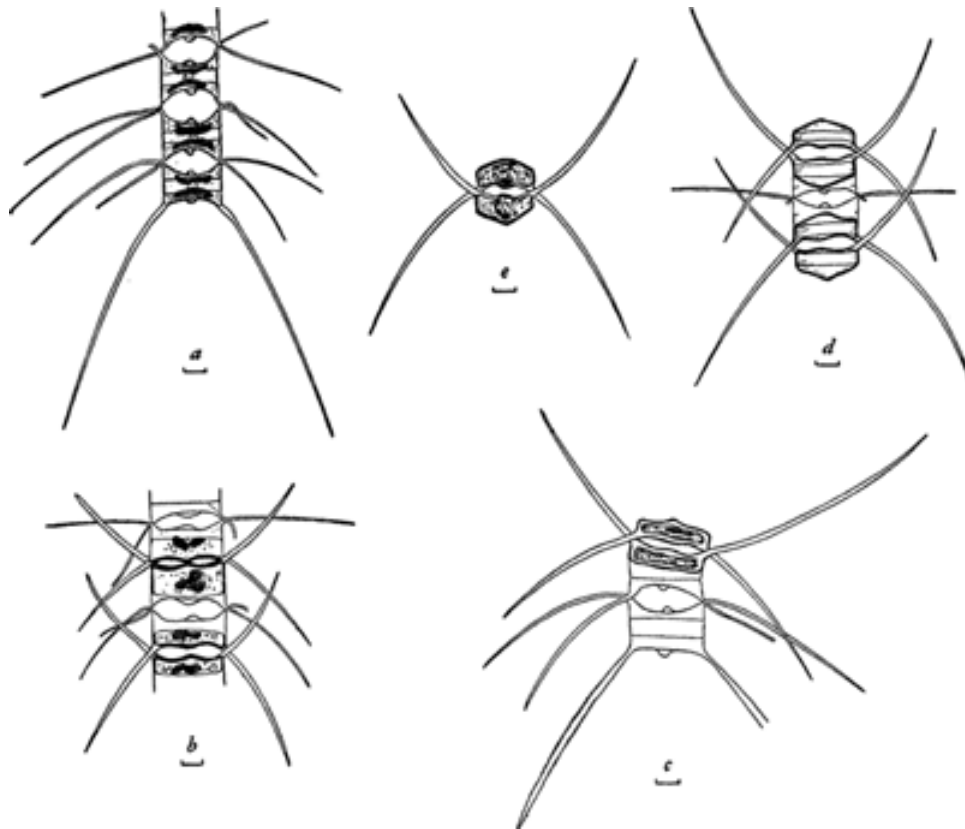

Fig. 75-A. *Chaetoceros didymus* Ehr. *a*, typical chain, broad girdle view; width, 24μ . *b*, section of chain showing beginning of formation of resting spores; width, 32μ . *c* and *d*, resting spores almost completely formed, still within parent cells. *e*, typical resting spores free from parent cells.

Section V. **Protuberantia**75. **Chaetoceros didymus** Ehrenberg

Figure 75-A

1846. Ber. Akad. Wiss. Berl. 1845, p. 75; 1854, Mikrogeol., pl. 35A, fig. XVII, 5; fig. XVIII, 4.

Chains straight, 12–34 μ wide. Cells four-cornered in broad girdle view, with concave surfaces. Apertures large, constricted in the middle. Valves with a semicircular protuberance in the center, visible in broad girdle view. Setae arising from corners of cells, crossing at their base or farther out, sometimes far outside the chain; in the type crossing almost at the base. Chromatophores two per cell, pressed against the valves, each with a pyrenoid located in the protuberance. Resting spores in pairs together, with short, thick setae and smooth valves, formed inside special mother cells without the central protuberance.

Neritic. South temperate species. Common, sometimes abundant off California and Lower California.

Variety **protuberans** (Lauder) Gran and Yendo

Figure 75-B, a

1864. Lauder. Trans. Micr. Soc., N.S., vol. 12, pl. 8, fig. 11 (*Chaetoceros protuberans*). 1914. Gran and Yendo. Vidensk. Skrifter. I. Mat.-Naturv. Kl. 1913, no. 8, p. 12, fig. 5.

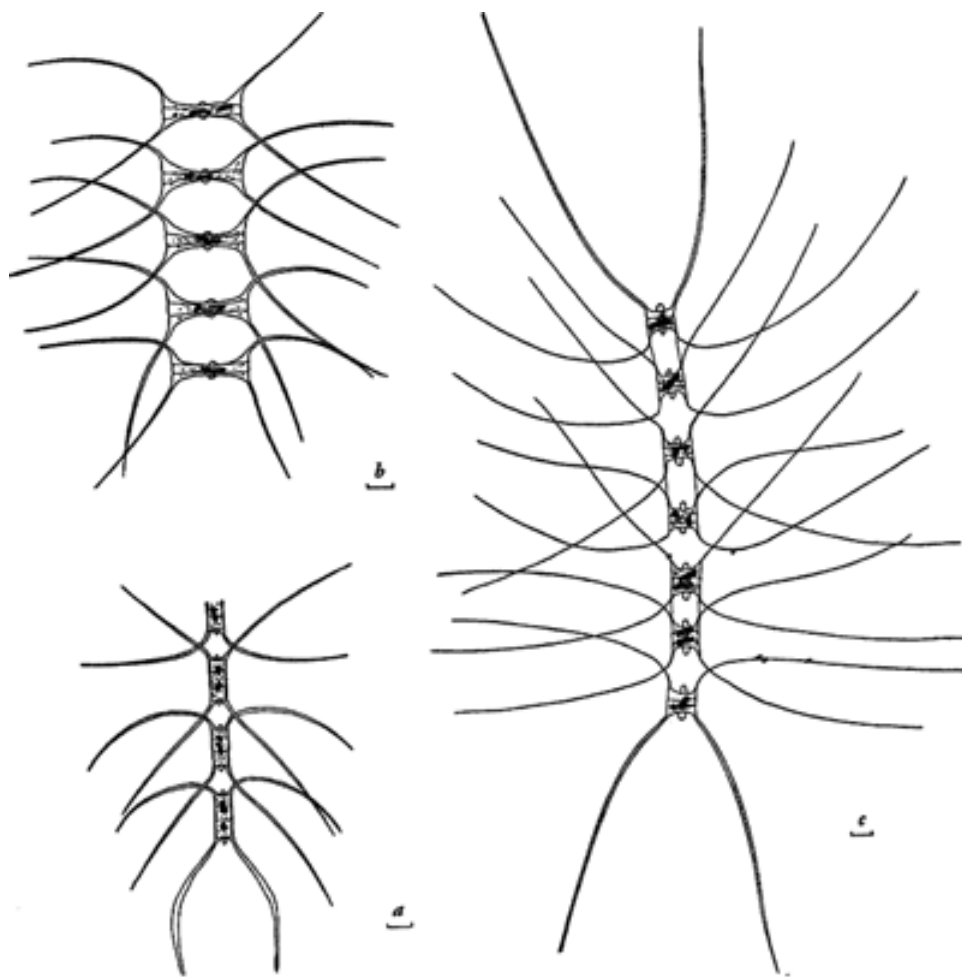

Fig. 75-B. a, *Chaetoceros didymus* var. *protuberans* (Laud.) Gran and Yendo. Chain, 7 μ wide, b and c, *C. didymus* var. *anglica* (Grun.) Gran. b, typical chain; width, 32 μ . c, chain with cells more nearly square, in broad girdle view; width, 14 μ .

Resembles the type closely. Terminal setae as a rule thicker than others, more strongly divergent than in type, convex toward outside, U-shaped. Setae usually crossing farther out from chain than in type. Rare.

Variety **anglica** (Grunow) Gran

Figure 75-B, *b, c*

1880–85. Grunow. In V. H. Syn., pl. 82, fig. 3 (*Chaetoceros furcellatus* var. *anglica*).

1905. Gran. Diat. Nord. Plankt., p. 80, fig. 95.

Differs from the type in shape of apertures. The thin, weakly siliceous setae cross each other far outside chain, producing wide apertures.

Found usually in warm coastal waters. Reported from Gulf of California and off coast of Lower California. Not common.

Section VI. **Constricta**

76. **Chaetoceros constrictus** Gran

Figure 76

1897. Den Norske Nordh.-Exped. 1876–1878, Bot. Protoph., p. 17, pl. 1, figs. 11–13; pl. 3, fig. 42.

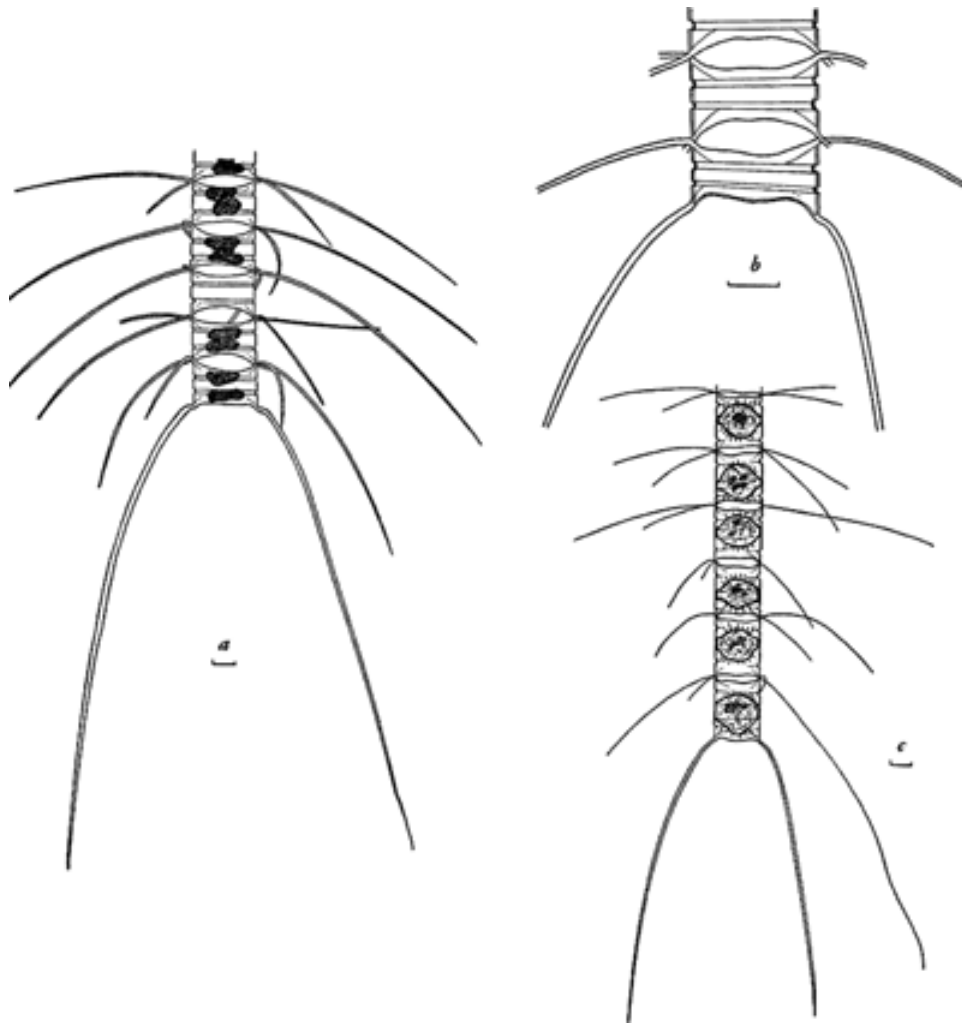

Fig. 76. *Chaetoceros constrictus* Gran. *a*, typical chain; width, 26μ . *b*, part of a chain; width, 27μ . *c*, chain with resting spores; width, 20μ .

Chains straight, 12–36 μ wide. Cells in broad girdle view oblong, with sharp corners. Deep constriction between valves and girdle band. Valves flat or slightly concave, with moderately high valve mantle. Apertures symmetrically lanceolate, slightly narrowing in center. Setae with no basal part, outer part turned at first at right angles to chain axis. Terminal setae diverging at an acute angle, distinctly marked. Resting spores in middle of mother cell, both valves with short spines.

Neritic. North temperate species. Abundant at some times off California. Common throughout eastern Pacific.

77. *Chaetoceros vanheurcki* Gran

Figure 77

1897. Den Norske Nordh.-Exped. 1876–1878, Bot. Protoph., p. 18.

Cells 12–36 μ broad. Distinguished from *C. constrictus* only by the parallel or pallaside spines on the secondary valves of the resting spores. Terminal setae possibly slightly thicker and more spinous.

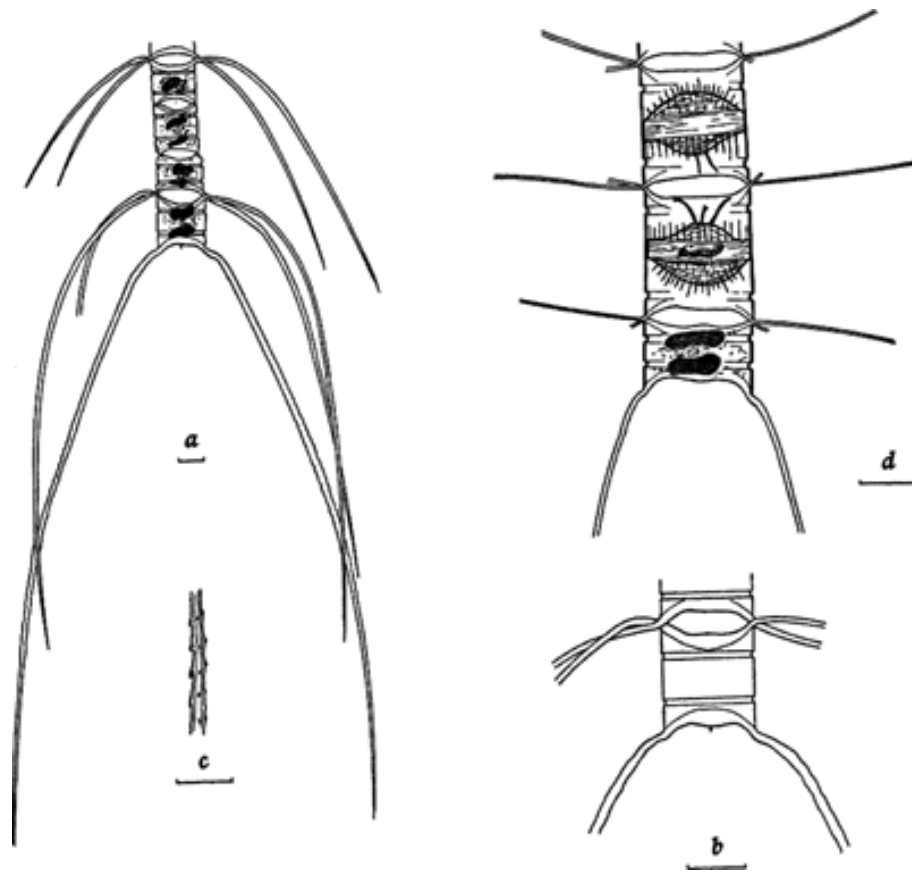

Fig. 77. *Chaetoceros vanheurcki* Gran. *a*, typical chain; width, 16 μ . *b*, terminal cell of chain shown in (*a*). *c*, section of terminal seta of same cell midway between cell and end of seta. *d*, chain with resting spores; width, 18 μ .

Neritic. Common. Probably confused with *C. constrictus*, so that abundance is difficult to estimate from available records.

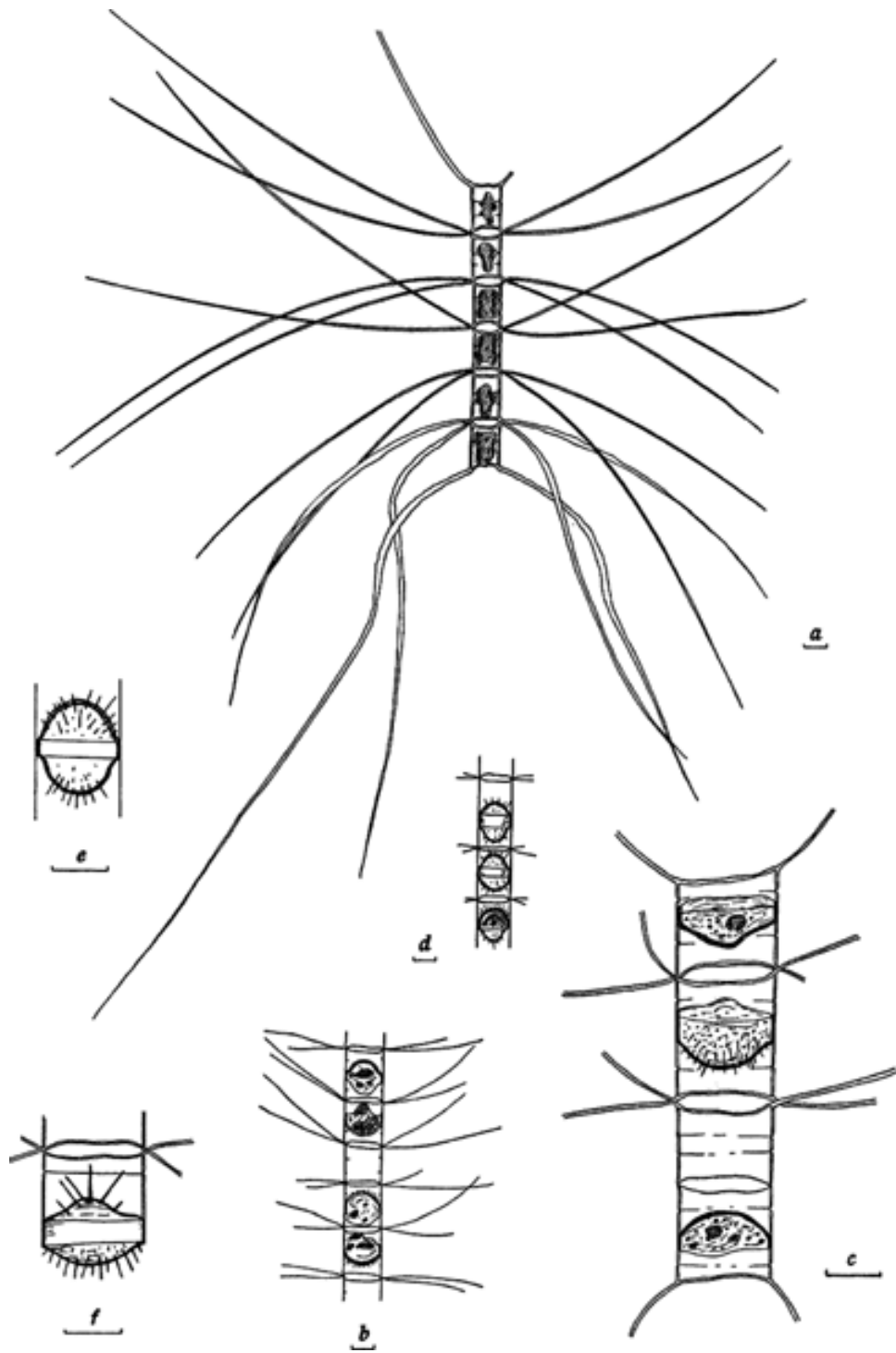

Fig. 78-A (1). *Chaetoceros affinis* Laud. *a*, typical chain, broad girdle view; width, 12μ . *b* and *c*, chains with resting spores in process of formation; widths: *b*, 18μ ; *c*, 18μ . *d*, *e*, and *f*, resting spores; widths: *d*, 14μ ; *e*, 14μ ; *f*, 20μ .

Section VII. *Stenocincta*78. *Chaetoceros affinis* Lauder

Figure 78-A(1); figure 78-A(2)

1864. Trans. Micr. Soc., N.S., vol. 12, p. 68, pl. 8, fig. 5.

Chains straight, 7–27 μ wide. Cells in broad girdle view oblong, with sharp corners which touch those of adjacent cells. Apertures lanceolate, slightly constricted in the middle. Valve mantle high, separated by a small notch from narrow girdle zone. Setae delicate. Terminal setae large, strongly divergent, perpendicular to chain axis then bent parallel to axis, slightly twisted. Chromatophores one in each cell, lying against broad side of girdle; with a large central pyrenoid. Resting spores in center of mother cell. Primary valve arched and

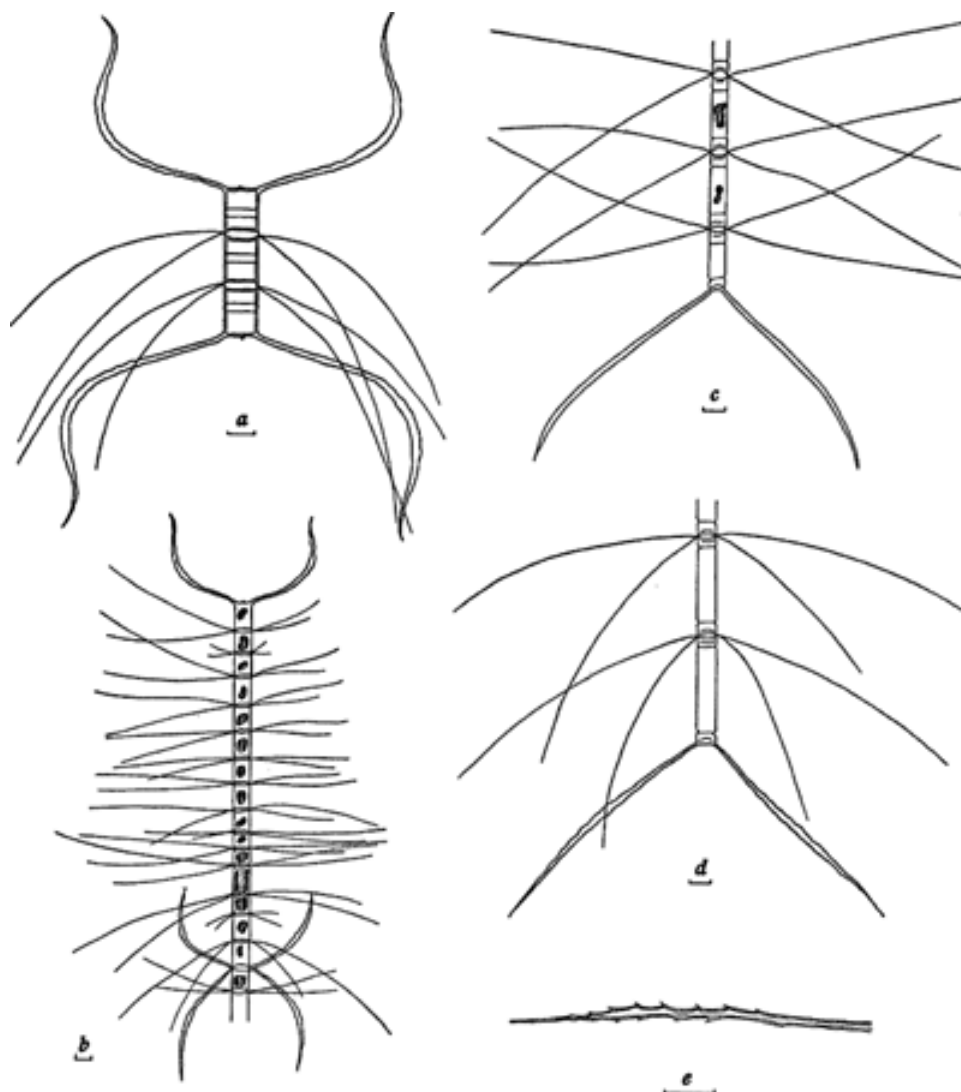

Fig. 78-A (2). *Chaetoceros affinis* Laud. *a*, characteristic chain; width, 13 μ . *b*, chain with terminal-like setae within the chain; width, 10 μ . *c*, narrow chain (7 μ wide) with less curved terminal setae. *d*, narrow chain (8 μ wide) with terminal setae nearly straight. *e*, section of terminal seta shown in (*d*).

covered with small spines, secondary valve flat with a bulge in center and bearing a few rather long, slender, straight spines in the middle.

Neritic. South temperate species. Common. Often numerous from May through August.

Gran and others consider *C. affinis* as a central type of a group of forms all belonging to the same species. Under this head are included *C. ralfsii*, *C. schüttii*, *C. javanicus*, *C. distichus*, *C. angulatus*, *C. procerus*, *C. najadianus*, *C. adriaticus*, *C. paradoxus* var. *schüttii*, *C. clevei*, and *C. schüttii* var. *genuina*.

Variety **circinalis** (Meunier) Hustedt

Figure 78-B

1913. Meunier. Mém. Mus. R. Hist. Nat. Belgique, vol. 7, pt. 2, p. 37, pl. 6, figs. 1–6 (*Chaetoceros schüttii* var. *circinalis*).

1930. Hustedt. Kieselalgen, pt. 1, p. 697, fig. 397.

Differs from the type in characteristic curvature of the setae, which in general lie perpendicular to the chain axis, but are completely bent backward and surround the chain in a more or less semicircle. Rare.

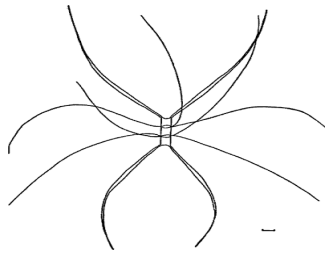

Fig. 78-B. *Chaetoceros affinis* var. *circinalis* (Meun.) Hust. Typical chain; width, 12 μ .

Variety **willei** (Gran) Hustedt

Figure 78-C

1897. Gran. Den Norske Nordh.-Exped. 1876–1878, Bot. Protoph., p. 19, pl. 4, fig. 47 (*Chaetoceros willei*).

1930. Hustedt. Kieselalgen, pt. 1, p. 697, fig. 398.

Cells in general more delicate than in the type. Apertures very small, sometimes almost absent. Terminal setae scarcely thicker than the others, lying close to chain axis, only diverging at an acute angle.

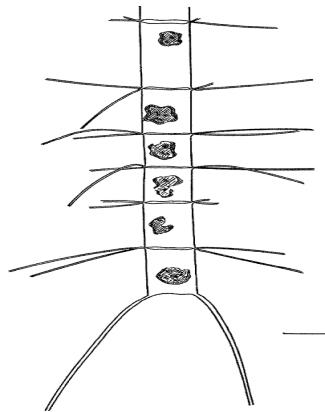

Fig. 78-C. *Chaetoceros affinis* var. *willei* (Gran) Hust. Typical chain; width, 11 μ .

Not common off California.

79. *Chaetoceros costatus* Pavillard

Figure 79

1911. Bull. Soc. Bot. France, vol. 58, p. 24, fig. 1, B, C.

Placed by Lebour (1930) in Sec. XII (*Curviseta*) under the name *Chaetoceros adhaerens* Mangin.

Chains even, more or less twisted. Valves elliptical, with apical axis 12–24 μ long. Valve surface slightly excavated in the center. Each valve has two symmetrical protuberances, a short distance in from the margins. Adjacent cells are joined by these. Apertures small, elliptical in valve view, shorter than the apical axis. Setae arising from the rounded angles on the inner sides of the valves, without basal part, more or less turned toward the chain end and slightly curved, thin throughout. Terminal setae thin as others, at nearly right angles to chain axis. Resting spores near center of cell, secondary valves of adjacent cells facing each other. Primary valves rounded, with short spines. Secondary valves smaller, rounded, without spines in specimens observed. Numerous intercalary bands characteristic, visible in fresh material without artificial preparation. One chromatophore per cell.

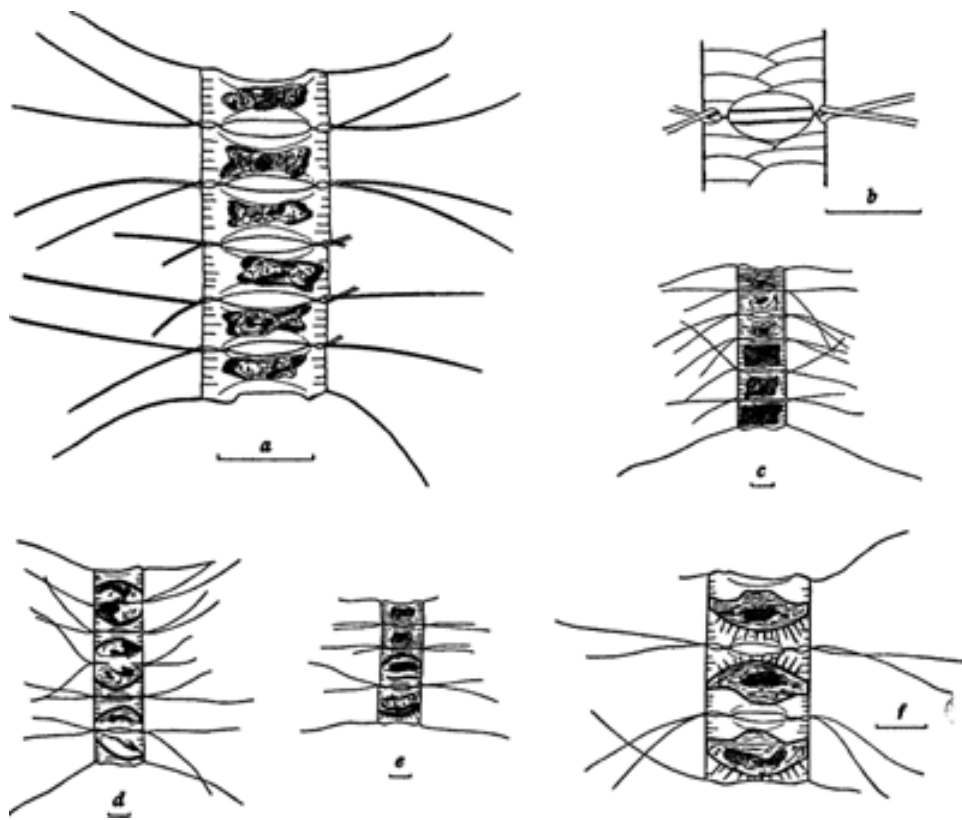

Fig. 79. *Chaetoceros costatus* Pav. *a*, typical chain, in broad girdle view; width, 27 μ . *b*, connection between cells (note intercalary bands); width, 12 μ . *c*, another chain (note intercalary bands); width, 20 μ . *d* and *e*, chains with resting spores in process of formation; widths: *d*, 22 μ ; *e*, 18 μ . *f*, chain with resting spores; width, 23 μ .

Neritic. Warm-water species. Common off southern California, found in great abundance in Gulf of California. Nearly 900,000 cells per liter reported off Lower California in latitude 26°14' north in March, 1937 (Cupp and Allen, 1938), and nearly 2,000,000 cells per liter twenty-two miles south of Point Abrejos in April, 1931 (Allen, 1934a).

Section VIII. *Laciniosa*80. *Chaetoceros laciniosus* Schütt

Figure 80

1895. Ber. Deutsch. Bot. Ges., vol. 13, p. 38, fig. 5.

Chains straight, loose, 10–28 μ wide. Cells in broad girdle view rectangular, with slightly projecting corners rounded at the outside. Valve surface slightly arched in the middle. Apertures large and broad, oblong, with rounded corners, slightly constricted in the middle. Setae thin, basal part parallel to chain axis, then perpendicular to axis, far outer part usually bent toward one end of chain. Terminal setae thick, distinctly different from others, in broad girdle view almost parallel, in narrow girdle view more diverging; armed with small spines. Chromatophores two per cell, more or less lobed plates, situated against valve base, each with a central pyrenoid. Resting spores smooth, not in middle of mother cell but usually nearer younger valve. Neritic. South temperate form. Not very common off California.

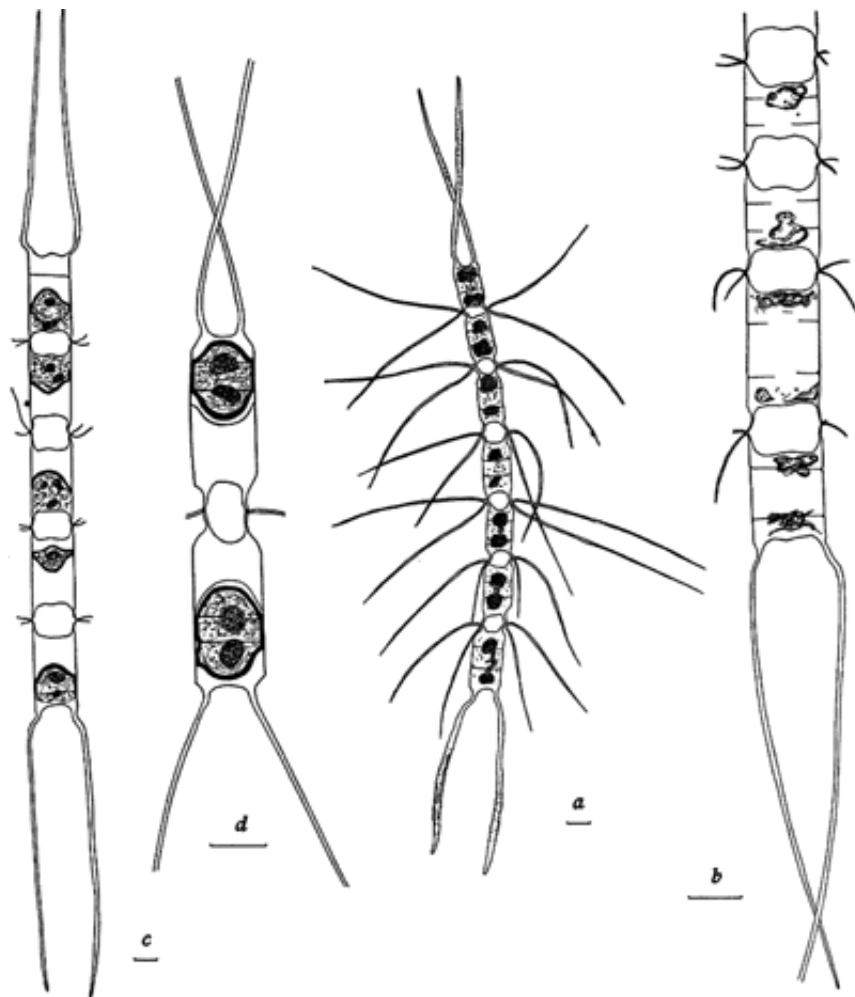

Fig. 80. *Chaetoceros laciniosus* Schütt. *a*, typical chain, in broad girdle view; width, 12 μ . *b*, chain, 14 μ wide, with resting spores in process of formation. *c*, chain, 14 μ wide, with resting spores; width, 12 μ .

81. *Chaetoceros pelagicus* Cleve

Figure 81

1873. Bih. Kongl. Svensk. Vet.-Akad. Handl., vol. 1, no. 13, p. 11, pl. 1, fig. 4.

Resembles *C. lacinosus* and is included in that species by Gran (1915) and Lebour (1930). However, only one chromatophore is present in this species, the chains are more delicate and loose, and the apical axis is 7–8 μ long. Valves flat, with relatively high valve mantles without a notch along girdle zone. Girdle-band zone small in resting cells. Setae very thin and loose with long basal part. Apertures consequently large, rectangular. Outer part of setae perpendicular to chain axis or more or less turned toward the chain end. Terminal setae in apical view at the base slightly divergent, then in general parallel to the chain axis, longer than the others. Resting spores unknown. Neritic. North temperate. Not common off southern California.

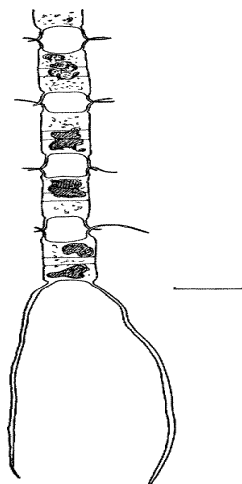

Fig. 81. *Chaetoceros pelagicus* Cl. Chain in broad girdle view; width, 7 μ .

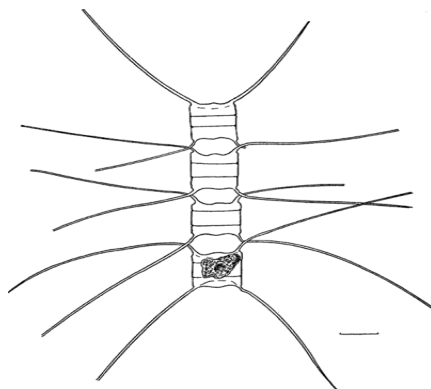

Fig. 82. *Chaetoceros brevis* Schütt. Chain in broad girdle view; width, 13 μ .

82. *Chaetoceros brevis* Schütt

Figure 82

1895. Ber. Deutsch. Bot. Ges., vol. 13, p. 38, fig. 4.

Closely related to *C. lacinosus*, but, as in *C. pelagicus*, only one chromatophore per cell, pressed against one valve. Setae almost straight, not so far from apical plane. Terminal

setae diverging in broad girdle view at angle of about 90° or more. Cells $8\text{--}17\mu$ broad. Resting spores similar to those of *C. lacinosus*, with dissimilarly arched valves, smooth or with fine spicules. Positive identification difficult.

Neritic. Warm-water species, south temperate to subtropical. Not common off southern California.

Section IX. **Diadema**

83. ***Chaetoceros subsecundus*** (Grunow) Hustedt

Figure 83

1880–85. Grunow. In V. H. Syn., pl. 82 bis, figs. 6, 7 (*Chaetoceros distans* var. *subsecundus*). 1930. Hustedt. Kieselalgen, pt. 1, p. 709, fig. 404.

SYNONYM: *Chaetoceros diadema* (Ehr.) Cleve.

Chains straight, may be slightly twisted about central axis, $12\text{--}44\mu$ wide. Cells rectangular, with slightly rounded corners in broad girdle view. Valves slightly convex. Apertures long, oval, slightly narrower in middle. Setae arising near corners of cells, extending outward in valvar plane, fusing with those of adjacent cells at a point beyond their bases. Terminal setae diverging at acute angle. Chromatophores one in each cell, attached to broad side of girdle. Resting spores nearer one valve of mother cell. Primary valve with 4–12 dichotomously branching spines and a narrow valve mantle. Secondary valve smooth.

Neritic. Boreal-arctic species. Fairly common off California but seldom abundant. Recorded by Gran (1912) as a north temperate species.

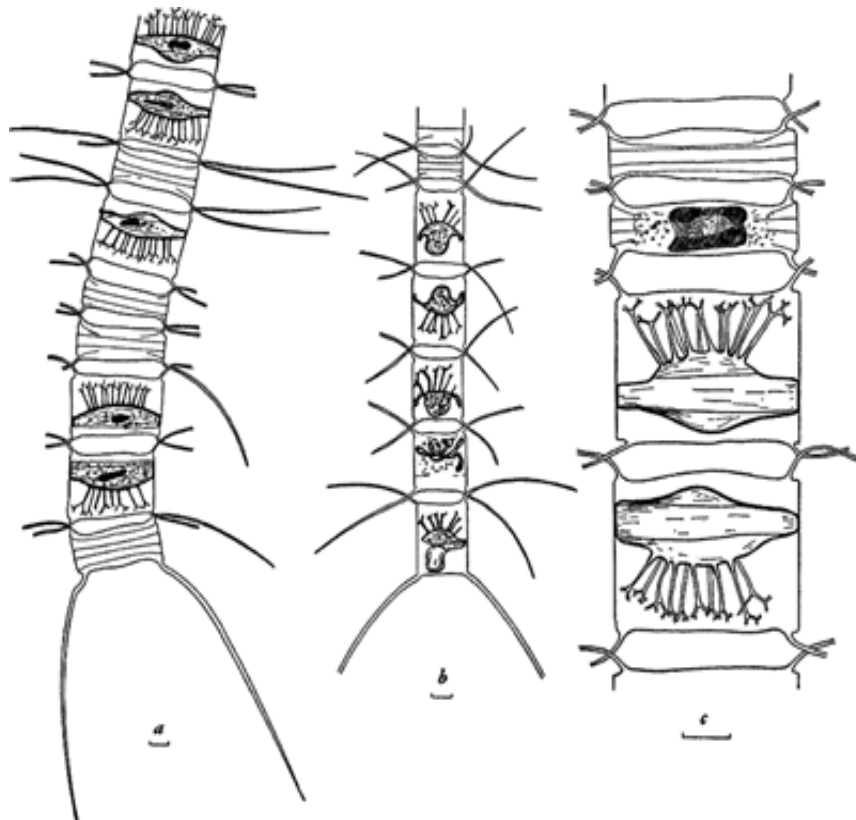

Fig. 83. *Chaetoceros subsecundus* (Grun.) Hust. *a*, typical chain with resting spores; width, 44μ . *b*, chain with resting spores in process of formation; width, 25μ . *c*, chain with completely formed resting spores and two ordinary cells (note chromatophores); width, 40μ .

84. *Chaetoceros seiracanthus* Gran

Figure 84

1897. Den Norske Nordh.-Exped. 1876–1878, Bot. Protoph., p. 21, pl. 3, figs. 39–41.

Chains straight, not twisted, 12–20 μ broad. Cells not touching one another at the corners. Apertures larger than in *C. lacinosus*. Setae thin, arising just inside the slightly rounded corners. Terminal setae diverging from chain axis. Distinct notch between valve and girdle. One chromatophore per cell. Resting spores near center of cell, both valves strongly arched in center, flatter at the margin, with long and thin spines at central part, and a series of parallel spines at the margin of primary valve.

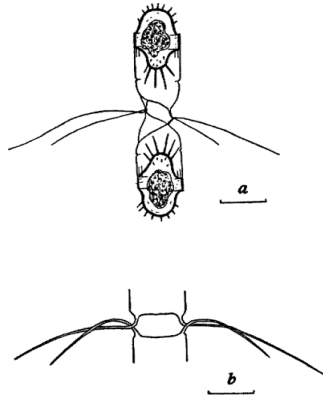

Fig. 84. *Chaetoceros seiracanthus* Gran. *a*, resting spores, narrow girdle view. *b*, part of a chain, broad girdle view; width, 12 μ .

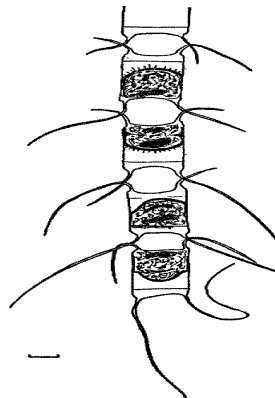

Fig. 85. *Chaetoceros holsaticus* Schütt. Chain with resting spores in process of formation; width, 20 μ .

Neritic. North temperate to boreal species. Rare off California.

85. *Chaetoceros holsaticus* Schütt

Figure 85

1895. Ber. Deutsch. Bot. Ges., vol. 13, p. 40, fig. 9.

Chains straight, fragile, 8–22 μ wide. Cells in broad girdle view oblong, with flat valves. Cell wall thin, delicate. Setae short, arising from inside valve margin. Apertures oblong, at least half as large as the cells. One chromatophore per cell, attached to broad side of girdle. Resting spores central, small spines on both valves. Primary valve distinctly larger than secondary. Secondary valve may be almost smooth.

Neritic. Cold-water species, boreal to arctic. Rare off California.

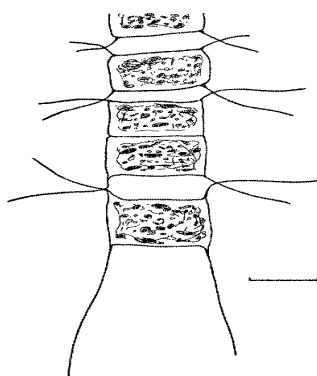

Fig. 86. *Chaetoceros difficilis* Cl. Chain in broad girdle view; width, 15μ .

86. *Chaetoceros difficilis* Cleve

Figure 86

1900. Kongl. Svensk. Vet.-Akad. Handl., vol. 34, no. 1, p. 20, pl. 8, figs. 16–18.

Chains straight but loose and pliable, $7\text{--}15\mu$ broad. Cell wall weakly siliceous. Valves flat with flat valve mantles, without notch between mantle and girdle. Setae very thin, arising from the corners of the cell with short basal part directed diagonally outward. Apertures fairly wide, in apical view six-sided to almost rectangular. Chromatophores one per cell attached to broad side of girdle. Resting spores central, smooth, only slightly arched.

Neritic. Reported off southern California occasionally in fairly large numbers. North temperate species.

Section X. *Diversa*

87. *Chaetoceros diversus* Cleve

Figure 87

1873. Bih. Kongl. Svensk. Vet.-Akad. Handl., vol. 1, no. 11, p. 9, pl. 2, fig. 12.

Chains straight, not twisted, usually short. Cells with elliptical valve surface and apical axis usually $8\text{--}12\mu$ long. Valves flat or slightly raised in the center, with high valve mantle, with small but distinct notch at junction with girdle. Girdle-band zone small in resting

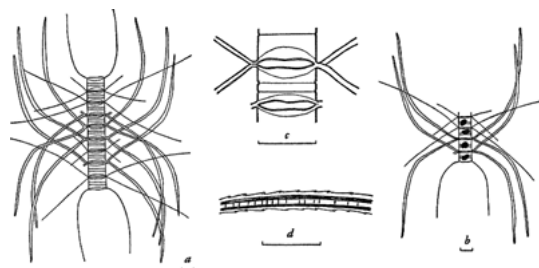

Fig. 87. *Chaetoceros diversus* Cl. *a* and *b*, two typical chains; widths: *a*, 12μ ; *b*, 10μ . *c*, detail of section of a chain. *d*, section of large seta.

cells. Setae arising from the corners of the cell, without basal part. Apertures very narrow, slitlike. Setae within chains of two kinds: (1) thin setae more or less curved, often straight, and usually slightly turned toward the chain ends; and (2) heavy setae almost club-shaped increasing in thickness from the base out, then becoming thinner again near the ends. The first two-thirds of setae almost straight and at a sharp angle from the chain axis, then turning gradually and at obtuse angle toward one or the other end of the chain and running almost parallel to the chain axis in the outer part. The thicker setae are clearly angular and beset on the corners with fine, spirally arranged little teeth. Terminal setae always thin and

differ from others in position—at first more or less U-shaped, in outer part nearly parallel to chain axis. Number of pairs of heavy setae in a chain various and seem to conform to no rule. Chromatophores one in each cell, on girdle side. Resting spores unknown.

Neritic. Tropical and subtropical species. Not common off California. More numerous off Lower California.

88. **Chaetoceros laevis** Leuduger-Fortmorel

Figure 88

1892. Diat. Malaisie, Ann. Jard. Bot. Buitenzorg, vol. 11, p. 38, pl. 6, fig. 2.

Chains straight, usually short, 3–4 cells. Cells in broad girdle view oblong, 5–12 μ wide, adjacent cells touching each other at corners or also by middle part. Apertures very narrow, appear to be lacking under low magnifications. One chromatophore, attached to girdle. Valve mantle high, distinct notch at suture between mantle and girdle. Setae various, terminals and some inner ones thin, hairlike; part of inner ones heavier. Heavy setae fused for a short distance beyond base, then both heavy and terminal setae have same curvature, at first nearly perpendicular to chain axis, then turn abruptly off at right angles, run parallel to chain axis, and then converge slightly toward chain. Small inner setae leave cell at nearly right angles to chain axis and diverge more or less toward ends, may follow same course as heavy setae (Schmidt, Atlas, pl. 339, fig. 4). Small spines present on heavy setae.

Neritic. Tropical species. Rare. Found only south of Lower California.

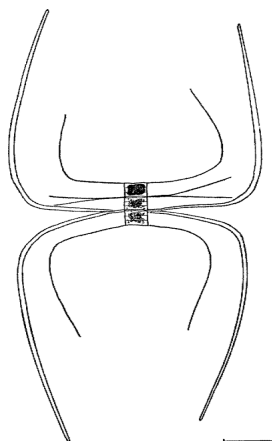

Fig. 88. *Chaetoceros laevis* Leud.-Fort. Typical chain, broad girdle view; width, 5 μ .

Hustedt (1930, p. 718) suggested the possibility that *C. diversus* and *C. laevis* belong to the same species, and that one is a variety of the other since the construction of the setae is so similar. Resting spores have not been found for either, so a decision can hardly be made yet.

89. **Chaetoceros messanensis** Castracane

Figure 89-A (p. 134); figure 89-B (p. 135)

1875. Atti del'Acad. Pont. Nuov. Linc., vol. 28, p. 32, pl. 1, fig. 1a.

Chains straight, not twisted. Elliptical valves. Apical axis 9–33 μ in length. Cells rectangular with conspicuous corners by which adjacent cells touch each other. Apertures fairly wide, linear-six-sided to almost round. Valve mantle low, without distinct notch at junction with girdle band. Setae thin. Terminal setae strongly diverging, unlike, usually one directed backward from the chain. Some inner setae fused for about two-thirds their length, so that basal part is only a single seta which forks at its second third. These forked horns are thicker than the others and with spirals of conspicuous small spines; sometimes with long hairlike extensions. One chromatophore, placed near girdle.

Oceanic. Tropical and subtropical species. Not uncommon off southern California. Recorded by Gran (1912) as a neritic, tropical species (*C. furca*).

Figure 89-A, *d* is a sketch of a specimen with forked setae resembling *C. messanensis*. The fused portion of the setae is much more nearly perpendicular to the chain axis than normal. Chain short, in several individuals examined only three cells, 7–7.5 μ broad. Perhaps a stage of *C. messanensis*.

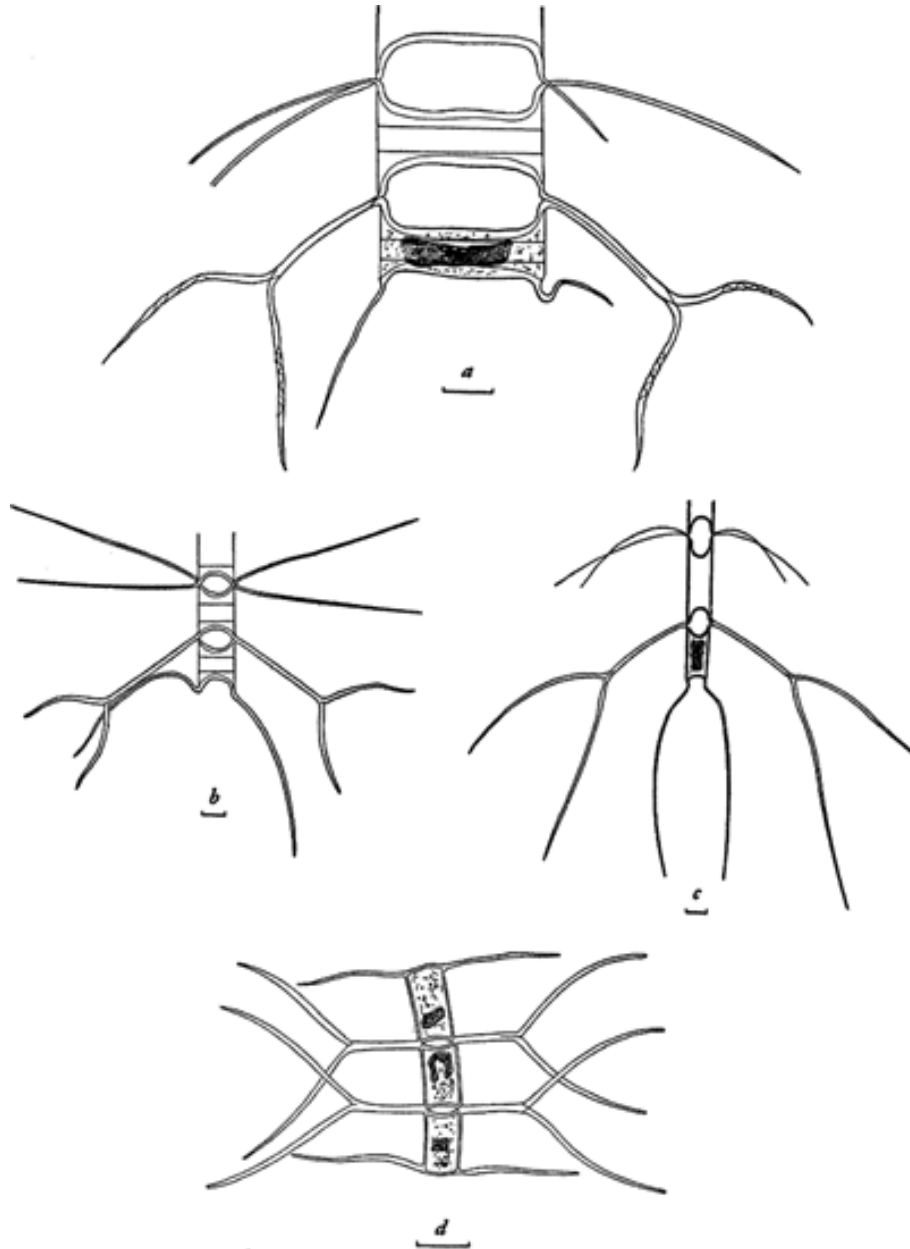

Fig. 89-A. *Chaetoceros messanensis* Castr. *a*, typical chain, broad girdle view (note spirals of small spines on forked setae); width, 33 μ . *b*, narrower chain (12 μ wide). *c*, chain 9 μ wide (note terminal setae unlike typical ones shown in [*a*] and [*b*]). *d*, atypical chain (note long heavy straight fused region of setae); width, 7 μ .

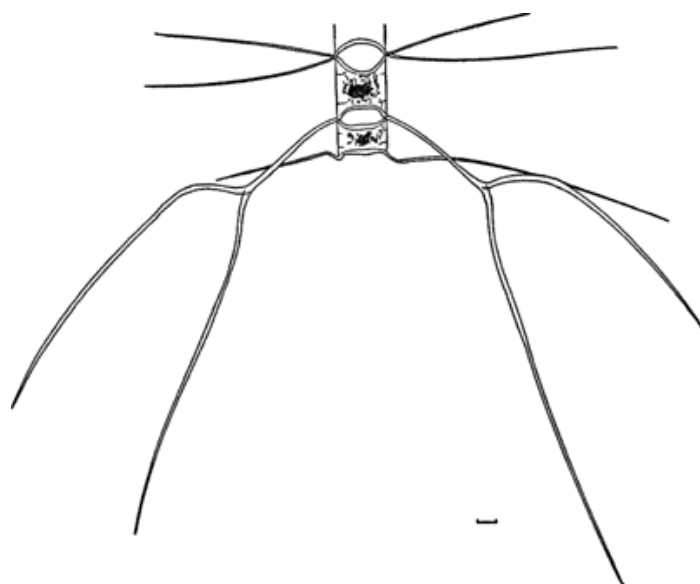

Fig. 89-B. *Chaetoceros messanensis* Castr. Chain in broad girdle view (note long forked setae); width, 25μ .

Section XI. Brevicatenata

90. *Chaetoceros similis* Cleve

Figure 90

1896. Bih. Kongl. Svensk. Vet.-Akad. Handl., vol. 22, pt. 3, no. 5, p. 30, pl. 1, fig. 1.

Chains short, straight, $7-13\mu$, wide. Cells four-cornered in broad girdle view. Valves with central raised region or protuberances causing adjacent cells to touch each other in the middle but not at the sides. Apertures narrow, divided into two parts by the protuberance or knob. Setae arising from the corners of the cells, directed apically outward, crossing

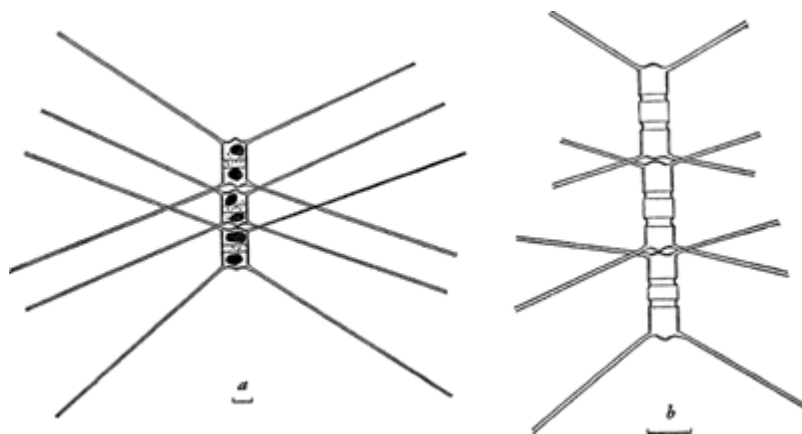

Fig. 90. *Chaetoceros similis* Cl. *a*, typical chain (note chromatophores); width, 13μ . *b*, chain, broad girdle view; width, 7μ .

somewhat outside the chain. Terminal setae usually slightly thicker than others, strongly diverging, parallel to other setae of chain. Valve mantle high, with small but distinct groove at junction with girdle. Girdle-band zone of resting cells small. Two chromatophores. Resting spores pear-shaped, central, armed on both valves with small spicules.

Neritic. North temperate species. Rare off southern California. Found north to Alaska. Never in large numbers.

91. ***Chaetoceros wighami*** Brightwell

Figure 91

1856. Quart. Jour. Micr. Sci., vol. 4, p. 108, pl. 7, figs. 19–36.

Chains delicate, straight, not twisted, usually short. Cells with elliptical valves; apical axis 7–14 μ long. Cells in broad girdle view oblong, with sharp corners by which adjacent cells

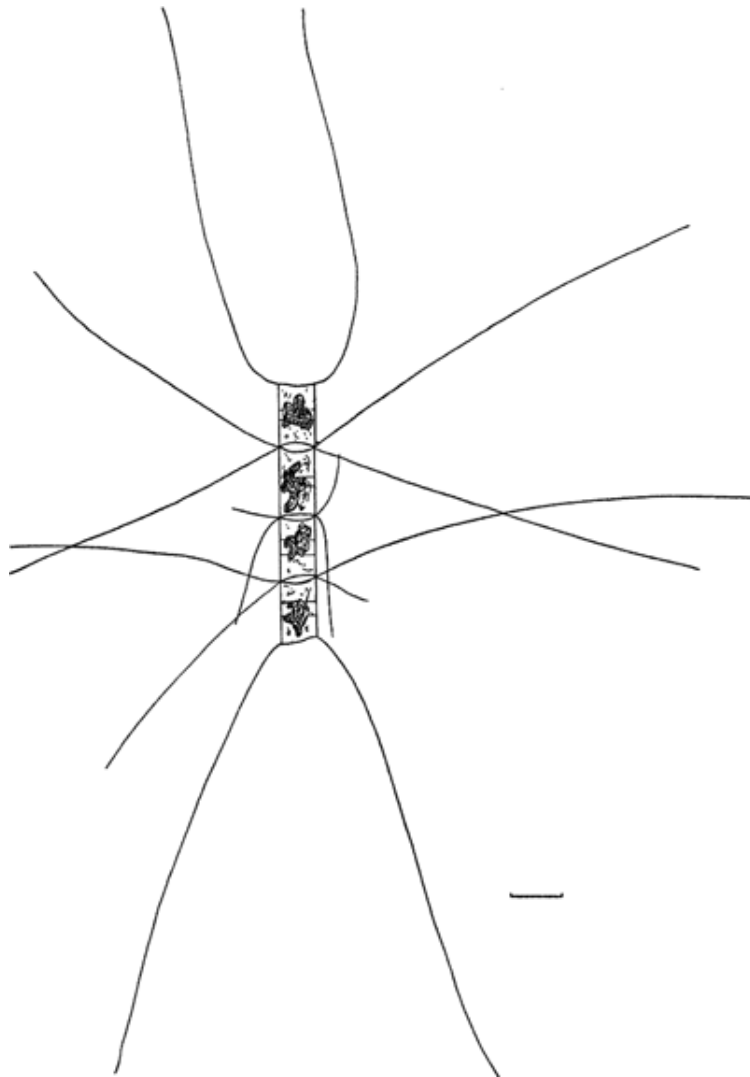

Fig. 91. *Chaetoceros wighami* Brightw. Typical chain in broad girdle view; width, 7 μ .

touch. Valves flat or more or less concave, sometimes with center slightly raised. Apertures linear-oblong to broad lanceolate. Valve mantle moderately high, without distinct groove at girdle-band margin. Girdle-band zone of resting cells slightly less than one-third the length of perivalvar axis. Setae thin, arising from the corners of cell, without basal part. Inner setae at right angles to chain axis or more or less bowed, some about parallel to chain axis. Terminal setae not thicker than the others, nearly parallel to chain axis, as a rule with an S-shaped curve. One chromatophore. Resting spores central, valves unlike. Primary valve convex with fine spines, secondary valve constricted at base, in the middle blunt coneshaped, smooth or with spines.

Neritic. Not common off California. May be easily confused with other species because of its great variability. North temperate species.

92. *Chaetoceros perpusillus* Cleve

Figure 92

1897. Treat. phytopl. Atl. trib., p. 22, pl. 1, fig. 12.

Short chains, usually three-celled, 4–8 μ broad. Apertures very small, slitlike. Valves flat. Setae very thin, arising from the corners of the cells, diverging. Terminal setae more or less S-shaped, nearly parallel to the chain axis, slightly thicker than others. May be a delicate form of *C. wighami*.

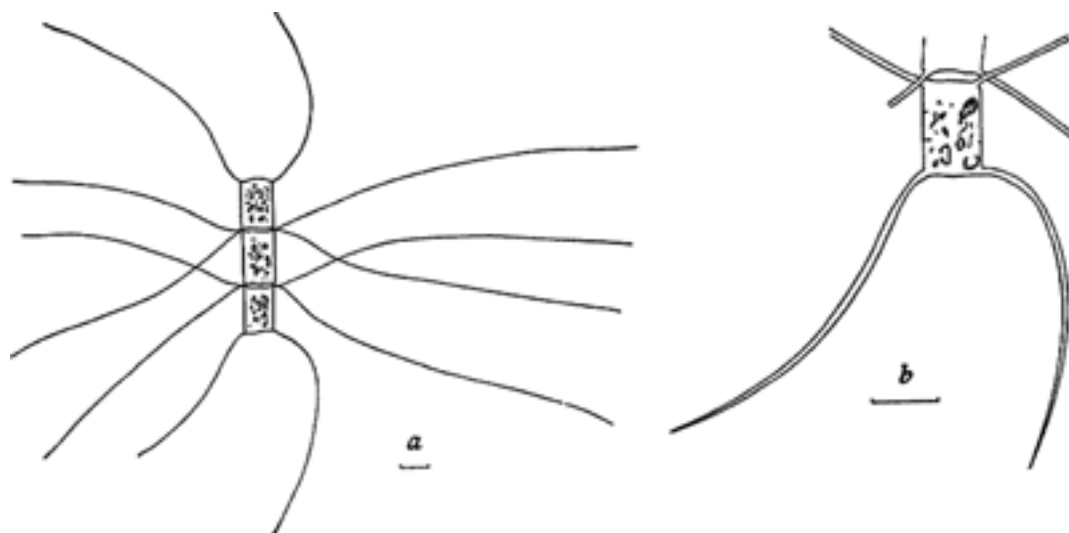

Fig. 92. *Chaetoceros perpusillus* Cl. *a*, typical chain, broad girdle view; width, 8 μ . *b*, terminal cell and setae shown in (*a*) more highly magnified.

Neritic. North temperate species. Not common off southern California.

Section XII. *Curviseta*

93. *Chaetoceros curvisetus* Cleve

Figure 93 (p. 138)

1889. Pelag. Diat. Kattogat, p. 55.

Chains spirally curved, without distinct terminal cells, 7–30 μ wide. Cells four-cornered in broad girdle view, adjacent cells connected by conspicuous corners. Valve mantle usually low, higher at corners of apical axis, very small notch at junction with girdle band. Apertures rhombic, oval, or circular. Setae arising from corners of cells, all bent toward same side of chain—toward outside of curved axis of spiral. Chromatophores one per cell with large central pyrenoid. Resting spores central, smooth, surrounded by thickened girdle of mother cell, more or less rounded valves, without spines; on margin of primary valve a row of delicate puncta.

Neritic. South temperate species. Very abundant off California, especially during February through April and August to October. Also common off Lower California and in the Gulf of California.

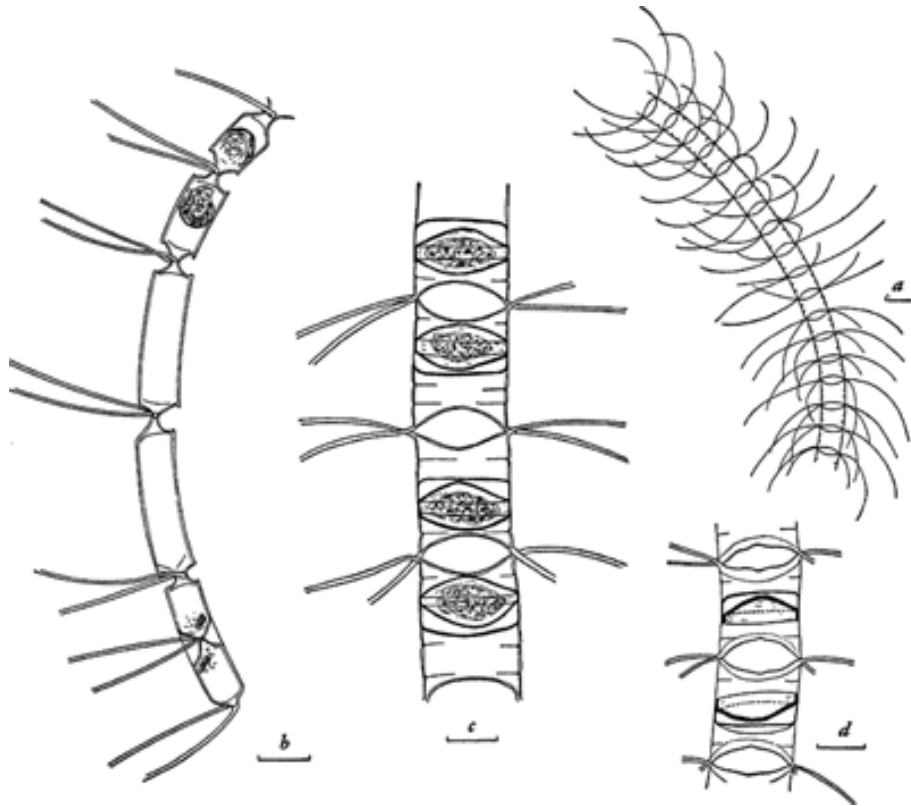

Fig. 93. *Chaetoceros curvisetus* Cl. *a*, typical chain, broad girdle view; width, 7μ . *b*, chain in narrow girdle view. *c*, chain with typical resting spores; width, 20μ . *d*, part of a chain with primary valves of two resting spores (note delicate puncta on margin); width, 17μ .

94. *Chaetoceros pseudocurvisetus* Mangin

Figure 94

1910. Bull. Soc. Bot. France, vol. 57, p. 350, fig. 4, II.

Cells compressed, $13\text{--}19\mu$ broad. Apertures lenticular, slightly fused at insertion of setae. Four protuberances on each valve connected with similar knobs on adjacent cells. Valve face rectangular with bent angles. Setae joined at insertion. Valve mantle high, without definite notch at junction with girdle band. Girdle zone small in resting cells. One chromatophore per cell. In general appearance setae similar to those of *C. curvisetus*.

Neritic. Tropical and subtropical species. Not common off southern California.

95. *Chaetoceros debilis* Cleve

Figure 95

1894. Bih. Kongl. Svensk. Vet.-Akad. Handl., vol. 20, pt. 3, no. 2, p. 13, pl. 1, fig. 2.

Chains long, spirally twisted, without special end cells, $8\text{--}36\mu$ wide. Cells four-cornered in broad girdle view, ends rounded; flat or slightly convex valves which do not touch those of adjacent cells. Apertures long, sides parallel or bent slightly toward each other in the middle. Valve mantle usually low, without notch where joined to girdle band. Setae thin,

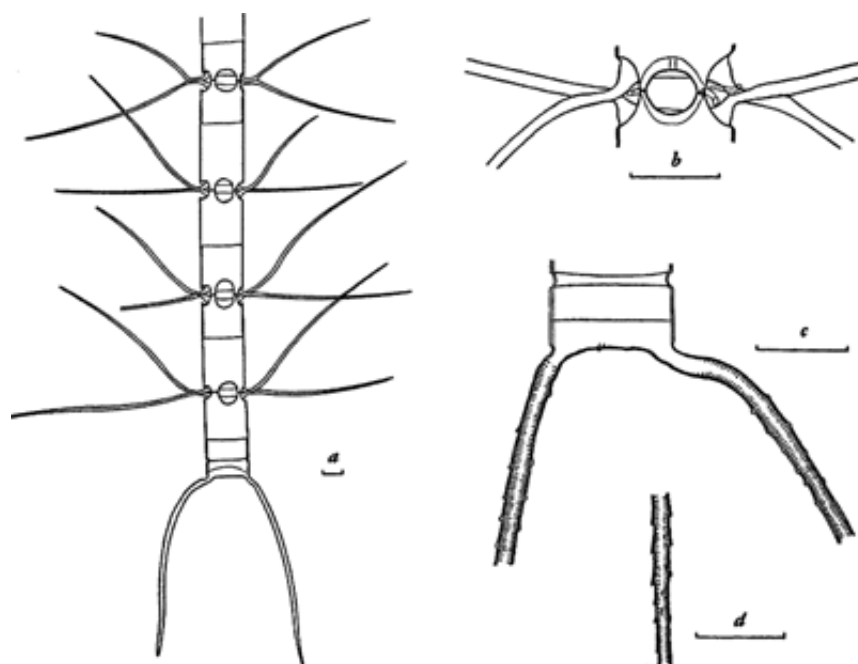

Fig. 94. *Chaetoceros pseudocurvisetus* Mang. *a*, typical chain, broad girdle view; width, 19μ . *b*, detail of region between two cells; width, 13μ . *c*, terminal cell and setae of chain shown in (*b*). *d*, detail of section of terminal seta near the end.

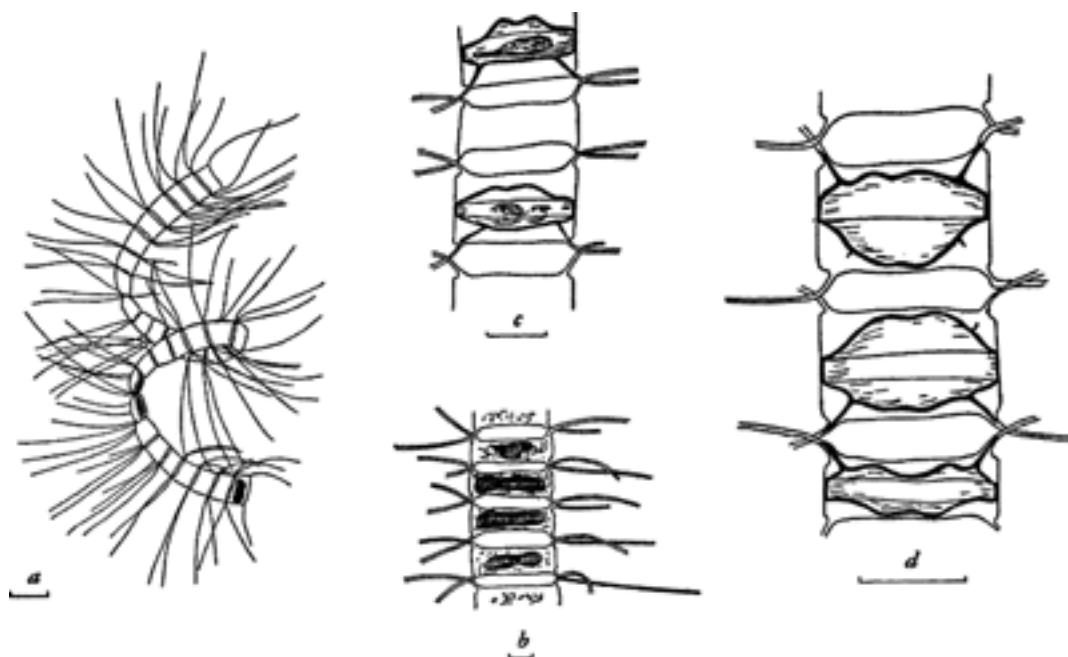

Fig. 95. *Chaetoceros debilis* Cl. *a*, typical chain; width, 8μ . *b*, part of a chain with chromatophores; width, 36μ . *c*, part of a chain with resting spores; width, 18μ . *d*, resting spores; width, 15μ .

arising within corners of cells, crossing outside their base and extending outward from the spiral. Chromatophores one per cell, situated at girdle side. Resting spores central, with two humps on primary valve and two setae extending into the corners of mother cell. Secondary valve smooth.

Neritic. North temperate species. Very common and abundant especially in February, March, and April, and in some years again during October, November, and December. Over 4,500,000 cells per liter reported off La Jolla on April 22, 1922. Probably most abundant species off California. Also plentiful off Lower California.

Section XIII. *Anastomosantia*

96. *Chaetoceros anastomosans* Grunow

Figure 96

1880–85. In V. H. Syn., pl. 82, figs. 6–8.

Chains straight, or slightly curved. Elliptical or nearly circular valves. Apical axis 8–10 μ long. Valves flat or slightly concave. Cells in broad girdle view oblong. Valve mantle moderately high, with slight notch at junction with girdle. Setae arising from corners of cell, thin and loose, hence variously bent but in general at right angles to chain axis. With long base, not directly connected with corresponding seta of next cell but bound to it by a cross piece the same thickness as setae and about 4–7 μ long. Apertures wide. Terminal setae very long, from base diverging in U-shape, then nearly parallel to long axis of chain. Chromatophores two per cell, lying near the valve. Resting spores unknown.

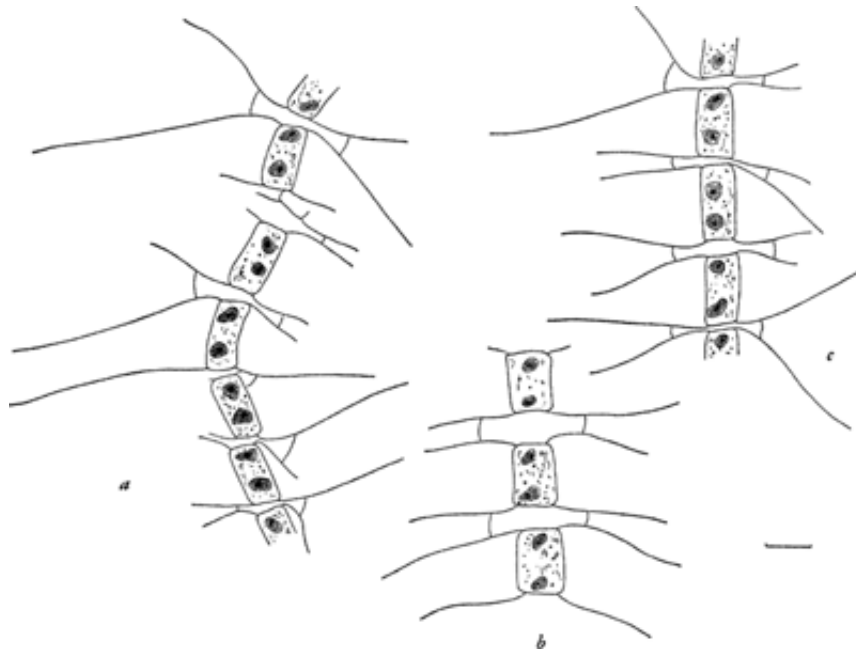

Fig. 96. *Chaetoceros anastomosans* Grun. *a*, *b*, and *c*, parts of three chains, broad girdle view; widths: *a*, 8 μ ; *b*, 10 μ ; *c*, 8 μ .

The variety *externa* (Gran) Hustedt differs from the type by much shorter, 1–2 μ long, cross pieces. Apertures consequently smaller. Resting spores never central. Valves of spores convex but differently arched, both with numerous scattered small spines. Cleve considers the type and variety as the same. Others have made two separate species. They have been much confused. Only the type has been found in the eastern Pacific.

Neritic. South temperate species.

Section XIV. *Furcellata*97. *Chaetoceros radicans* Schütt

Figure 97

1895. Ber. Deutsch. Bot. Ges., vol. 13, p. 48, fig. 21.

Chains straight or slightly curved, strongly twisted on chain axis, without special end cells. Cells 6–20 μ wide, in broad girdle view oblong, with slightly rounded corners which do

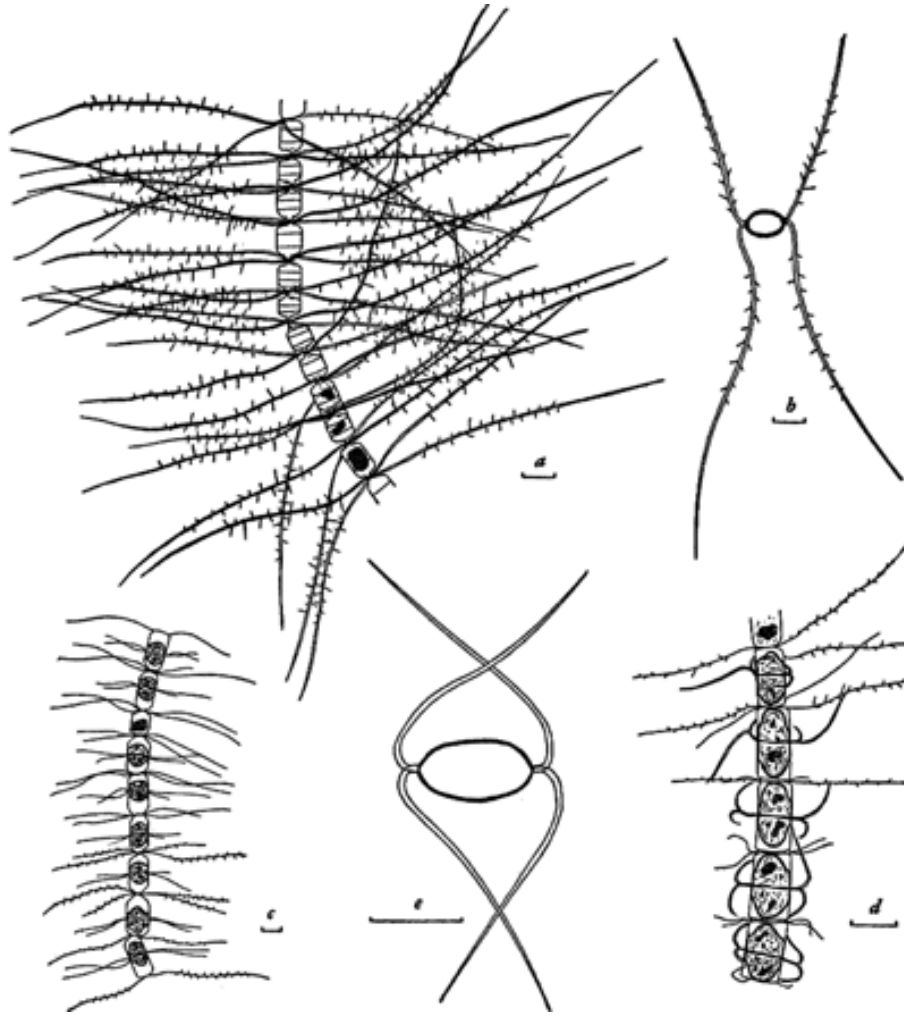

Fig. 97. *Chaetoceros radicans* Schütt. *a*, typical chain; width, 8 μ . *b*, valve view. *c* and *d*, chains with resting spores in process of formation. *e*, valve view of cell with heavier setae from chain shown in (*d*).

not touch adjacent cells. Moderately high valve mantle, without distinct notch on girdle-margin, girdle-band zone high. Apertures rounded-rectangular, slightly compressed in center. Setae arising from just inside corners, all bent out transversely, with many small spines. Terminal setae not especially different from others. One chromatophore. Resting spores in pairs close together on two sister cells, without apertures, with peculiar, smooth, thick setae which fuse for a space and farther out separate to surround the cell like a girdle.

Neritic. North temperate species. Common and often abundant especially from March through May and again in August and September. In 1937 (Cupp and Allen, 1938) very abundant in Gulf of California, reaching 4,500,000 cells per liter on March 22.

98. *Chaetoceros cinctus* Gran

Figure 98

1897. Den Norske Nordh.-Exped. 1876–1878, Bot. Protoph., p. 24, pl. 2, figs. 23–27.

Chains straight or weakly curved, no special terminal cells, 10–15 μ broad. Differs from *C. randicans* in its smaller size and thinner setae which are not so strongly bent and have no spines. Otherwise like the former species. Older resting spores show short spines on both valves. Neritic. South temperate species. Not common off California.

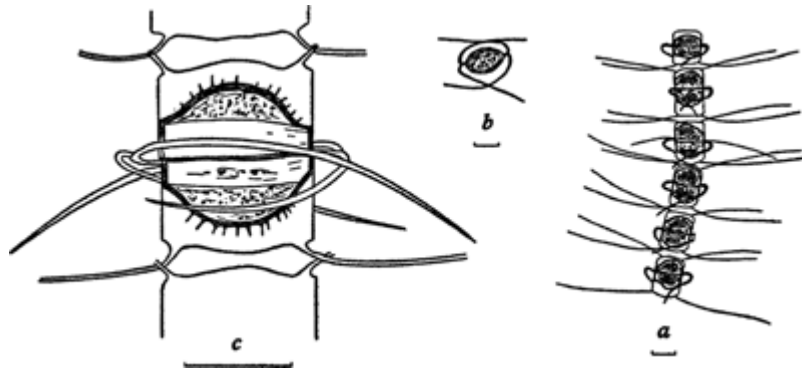

Fig. 98. *Chaetoceros cinctus* Gran. a, chain with resting spores being formed, broad girdle view; width, 12 μ . b, valve view of cell with heavier setae from chain shown in (a). c, resting spores; width, 15 μ .

99. *Chaetoceros tortissimus* Gran

Figure 99

1900. Nyt. Mag. Naturvid., vol. 38, pt. 2, p. 122, pl. 9, fig. 25.

Chains straight or slightly bent, loose, very strongly curved around chain axis, without distinct terminal setae. Cells 14–20 μ broad. Setae thin, arising a little way inside corners, about at right angles to chain axis, going in all directions. Cell wall weakly siliceous. Cells in broad girdle view rounded-rectangular. Valves with slightly convex valve surface, touching in the middle, not at corners, therefore apertures apparent only at corners. No notch at margin of girdle band. Chromatophores one, lying in girdle region. Resting spores unknown. Neritic. North temperate species. Not common.

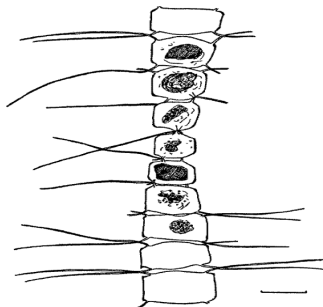

Fig. 99. *Chaetoceros tortissimus* Gran. Typical chain; width in broad girdle view, 17 μ .

Section XV. Socialia

100. *Chaetoceros socialis* Lauder

Figure 100

1864. Trans. Micr. Soc., N.S., vol. 12, p. 77, pl. 8, fig. 1.

Chains short, curved, many united in large, slimy, circular colonies, held together by slime, or mucilaginous-like substance, and often by some very fine long setae which are felted together. Cells 6–12 μ wide, in broad girdle view four-cornered, corners not touching those of adjacent cells. Apertures rather long, slightly narrower in the center. Setae hairlike, arising from corners of the cell, short basal part. Three setae of two adjacent valves short, fourth very long and entwined with long setae of adjacent cells to hold the chains in colonies. Long setae not always present. One chromatophore, on girdle side. Resting spores central or near central, smooth on both valves.

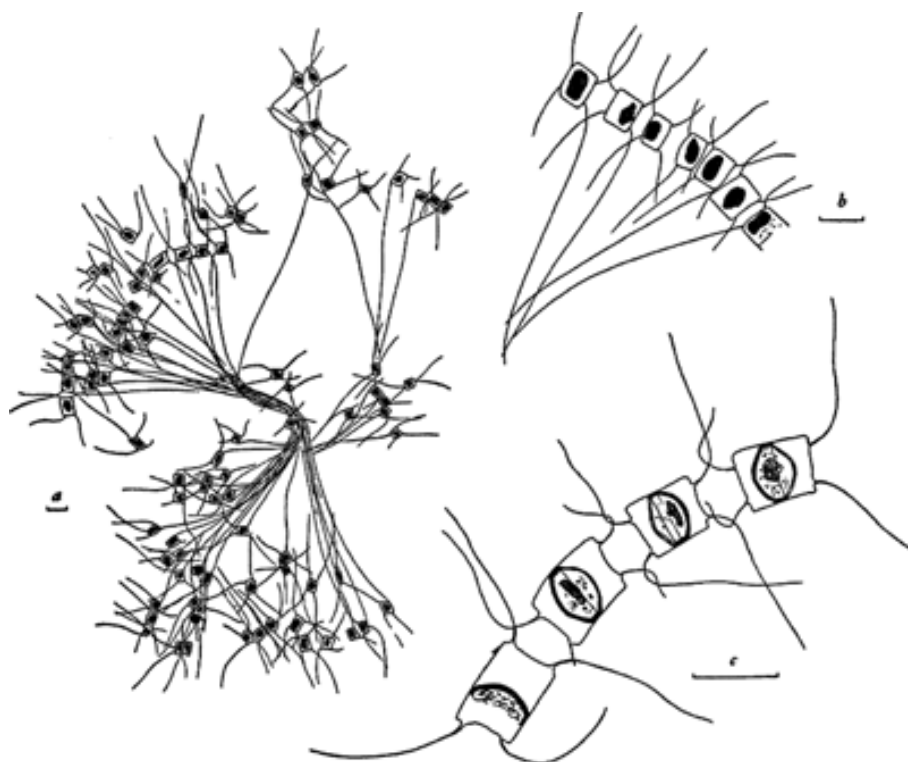

Fig. 100. *Chaetoceros socialis* Laud. a, typical colony. b, part of a chain, broad girdle view; width, 8 μ . c, part of a chain with resting spores; width, 7 μ .

Neritic. North temperate species. Common and often abundant off southern California, especially in March and April, and again from late June through August. One of most prominent species in Gulf of California in March, 1937 (Cupp and Allen, 1938).

Section XVI. Simplicia

101. *Chaetoceros gracilis* Schütt

Figure 101 (p. 144)

1895. Ber. Deutsch. Bot. Ges., vol. 13, p. 42, pl. 5, fig. 13.

Cells single, not in chains. In broad girdle view rectangular with rather conspicuous corners and concave valves. Apical axis 9–12 μ long. Valve mantle high, without distinct groove

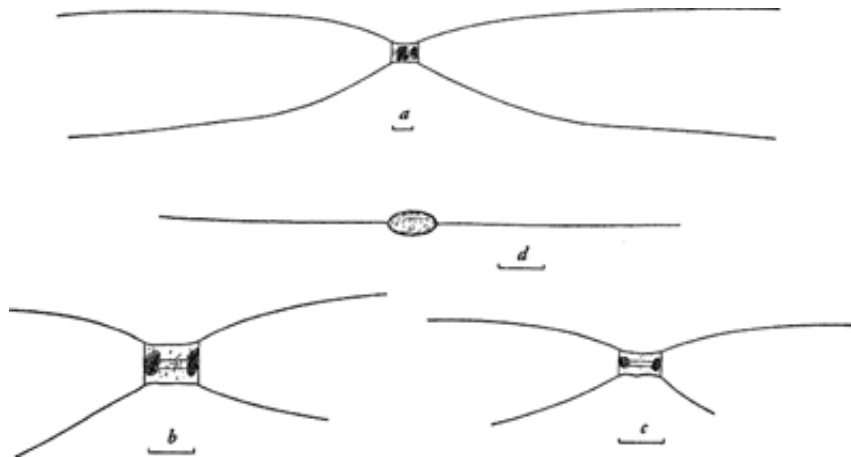

Fig. 101. *Chaetoceros gracilis* Schütt. *a*, *b*, and *c*, typical cells in broad girdle view; widths: *a*, 12 μ ; *b*, 12 μ ; *c*, 9 μ . *d*, valve view of cell shown in (*c*).

on girdle-band margin. Setae arising from a little within corners, curved near origin, later more nearly parallel, in valve view appear as one line. Chromatophores two, attached to narrow side of girdle zone. Resting cells central, ellipsoid, with nearly equally arched valves, finely spined.

Neritic. Present off southern California and Lower California, and in Gulf of California. Not common. Recorded from Arctic seas, Greenland seas, the Baltic, and the Mediterranean.

102. *Chaetoceros vistulae* Apstein

Figure 102

1909. *Wiss. Meeresunters.*, Abt. Kiel, N.F., vol. 11, p. 136, fig. 2.

Cells solitary or in pairs, with small elliptical valve, apical axis 7–8 μ long. Valves strongly concave, drawn out at corners of apical axis. Setae arising from these projecting corners, slightly concave, then almost parallel to perivalvar axis and then slightly diverging, lying in the apical plane. One chromatophore per cell, lying on girdle side. Resting spores unknown. Not well-known species.

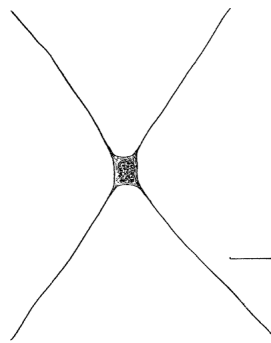

Fig. 102. *Chaetoceros vistulae* Apstein. Typical cell, broad girdle view; width, 7 μ .

Reported only occasionally off southern California. Neritic. Also a brackish-water species.

6. BIDDULPHIEAE Schütt

1896. *Bacill. in Engl.-Prantl, Nat. Pflanzenf.*, p. 87.

a) EUCAMPIINAE Schütt

1896. *Bacill. in Engl.-Prantl, Nat. Pflanzenf.*, p. 88.

Genus XXII. **EUCAMPIA** Ehrenberg

1840. Phys. Abh. Akad. Wiss. Berl. 1838, p. 71.

Valves elliptical in surface view with two blunt processes, without spines or setae. Numerous intercalary bands difficult to see in water mounts. Chains spirally curved. Large apertures between the cells. Chromatophores numerous, small.

Pelagic species.

Species: 103. *E. zodiacus* (fig. 103)104. *E. cornuta* (fig. 104)103. ***Eucampia zodiacus*** Ehrenberg

Figure 103

1840. Phys. Abh. Akad. Wiss. Berl. 1838, p. 71, pl. 4, fig. 8.

Cells flattened, elliptical-linear in valve view, united in chains by two blunt processes. Chains spirally curved, with relatively narrow lanceolate or elliptical apertures. Apertures variable in size and shape. Length of cell along apical axis 10–61 μ . Valves distinctly sculptured,

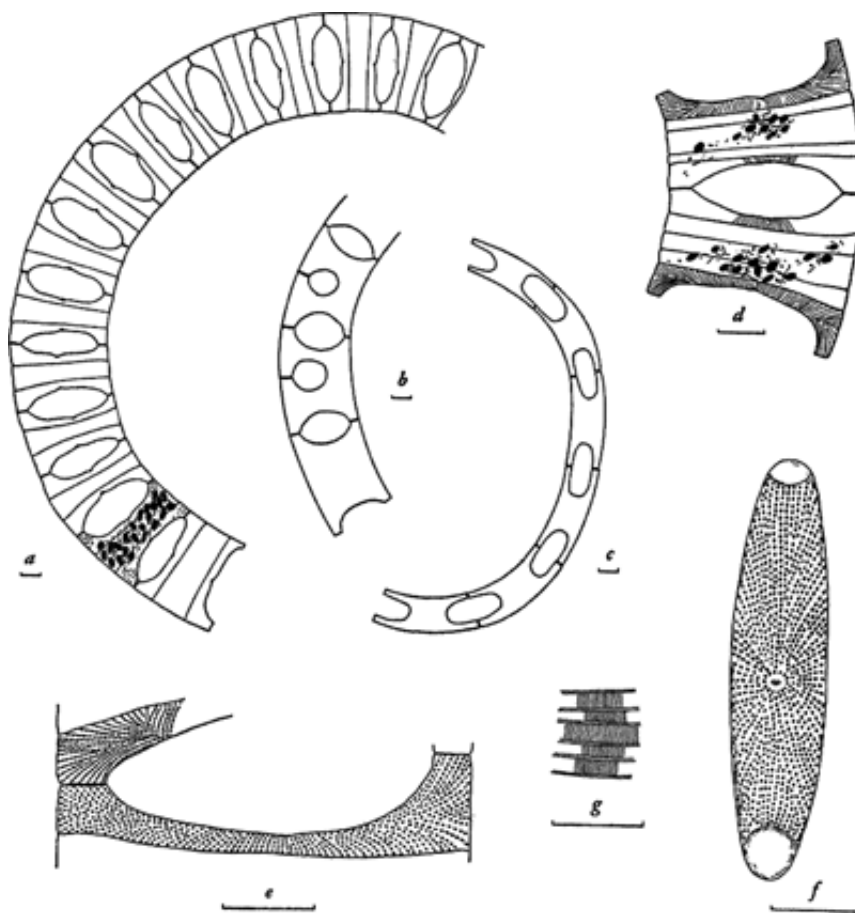

Fig. 103. *Eucampia zodiacus* Ehr. *a*, *b*, and *c*, parts of three chains, broad girdle view; widths: *a*, 46 μ ; *b*, 34 μ ; *c*, 14 μ . *d*, two cells with arrangement of sculpturing indicated width, 43 μ . *e*, valve mantle showing arrangement of puncta. *f*, valve view of cell shown in (*d*) and (*e*). *g*, arrangement of sculpturing on intercalary bands.

with puncta in more or less regular radial rows running outward from center toward processes, 16–20 puncta in 10μ . Sculpturing on intercalary bands visible only under high magnification, 28–33 rows of puncta in 10μ . Chromatophores small, numerous. Minute, highly refractive, colorless granules present in ends of processes.

Neritic. South temperate species. Very widely distributed. Often abundant off southern California, especially from March through July, and in Gulf of California. Common as far north as Scotch Cap, Alaska.

104. *Eucampia cornuta* (Cleve) Grunow

Figure 104

1873. Cleve. Bih. Kongl. Svensk. Vet.-Akad. Handl., vol. 1, no. 11, p. 7, pl. 1, fig. 6 (*Moelleria cornuta*).

1880–85. Grunow. In V. H. Syn., pl. 95 bis, fig. 5.

Similar to *E. zodiacus* in character of chain and general appearance. Differentiated by much more prominent intercalary bands, and longer, thinner processes, so that the apertures are wider. Sculpturing on valves similar but not identical, in more definite rows from center to ends of processes, 18–20 puncta in 10μ . Surface of intercalary bands similarly punctated, very fine puncta in rows, running in direction of pervalvar axis. Length of apical axis 29–36 μ .

Neritic. Warmer-water species than *E. zodiacus*, subtropical to tropical. Found off southern California and southward, but never in large numbers.

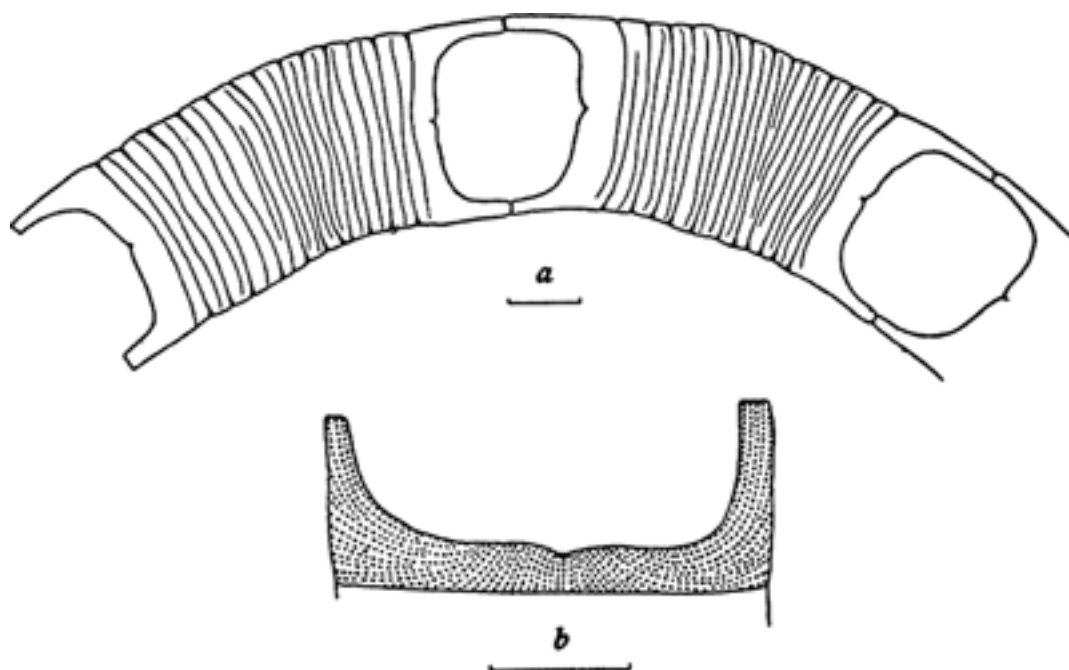

Fig. 104. *Eucampia cornuta* (Cl.) Grun. a, two cells of a chain, broad girdle view; width, 29μ . b, valve mantle showing arrangement of sculpturing; width, 31μ .

Genus XXIII. **CLIMACODIUM** Grunow

1867. Alg. Novara-Exped., p. 102.

Cells straight, but usually forming somewhat twisted chains. Apertures oval, or squarish-oblong as a result of the hammerlike ends of the cells. Cell wall very weakly siliceous, without visible sculpturing. Intercalary bands absent. Pervalvar axis of the cell usually short. Chromatophores numerous, small.

All species marine pelagic.

Species: 105. *C. frauenfeldianum* (fig. 105)

105. *Climacodium frauenfeldianum* Grunow

Figure 105

1867. Alg. Novara-Exped., p. 102, pl. 1a, fig. 24.

Cells straight, flat, often united into long ribbonlike chains. In girdle view with small, linear middle part with more or less long, thin processes on the poles of the apical axis. Length of apical axis $70\text{--}95\mu$, perivalvar axis $12\text{--}15\mu$. Intercalary bands absent; perivalvar axis, therefore, always very short. Cells in valve view small linear-elliptical, valve surface between the processes flat; the apertures, therefore, almost right-angled or very large oblongs, in perivalvar direction usually wider than the cell. Structure of the membrane extremely difficult to see.

Oceanic. Tropical or subtropical species. Reported off Lower California and Central America. Never common.

Genus XXIV. **STREPTOTHECA** Shrubsole

1890. Jour. Quek. Micr. Club, ser. 2, vol. 4, p. 259.

Cells extremely flat, with square outline, sometimes three-cornered. United by valve faces, leaving very little, if any, aperture. Cell wall very weakly siliceous. Chains strongly twisted. Valves narrowly elliptical with a rudimentary central knob. Chromatophores numerous small granules.

Species: 106. *S. thamensis* (fig. 106)

Fig. 105. *Climacodium frauenfeldianum* Grun. a, typical chain; width of cells, 95μ . b, detail of connection of processes of two cells.

106. **Streptotheca thamensis** Shrubsole

Figure 106 (p. 148)

1890. Jour. Quek. Micr. Club, ser. 2, vol. 4, p. 259, pl. 13, figs. 4–6.

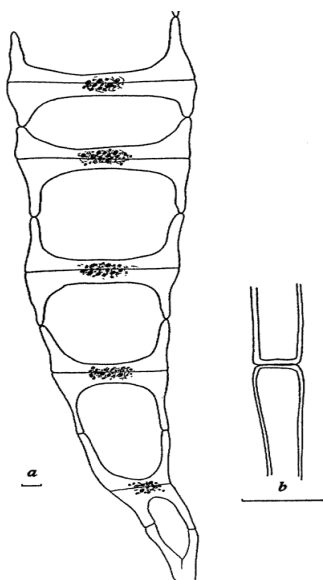
Cells twisted so that chains are spiral, one end of cell in relation to the other twisted about 90° . Cells almost flat, square. Apical axis $60\text{--}98\mu$ long. Valves not quite flat but with two deeply placed knobs which fit into corresponding depressions in the adjacent cells. Nucleus central. Chromatophores numerous small roundish plates, more or less radiate in the cell.

Neritic. Found off southern California and north to Alaska but never common. North temperate species.

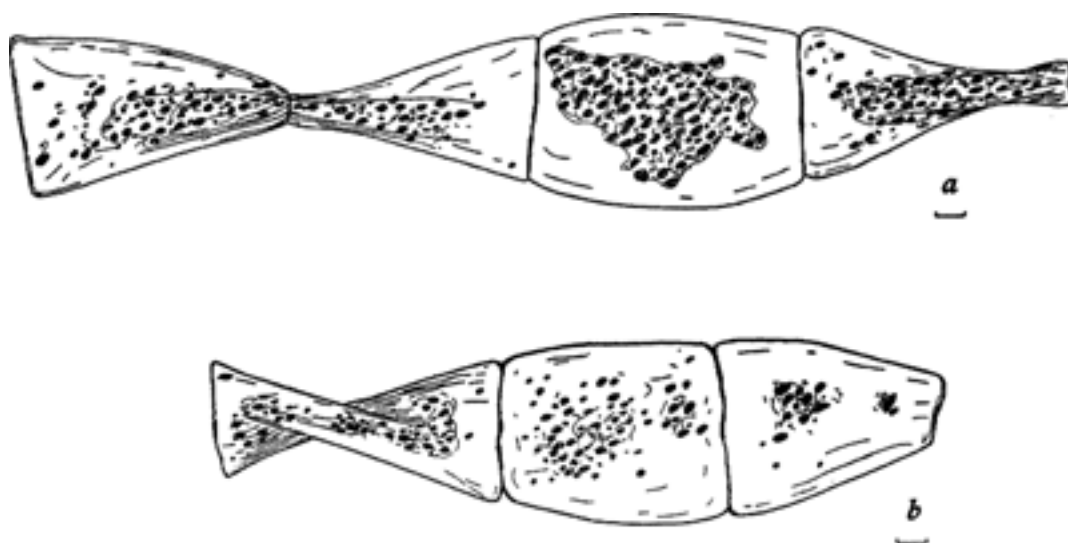

Fig. 106. *Streptotheca thamensis* Shrub. *a* and *b*, two typical chains; width of both, 61μ .

b)TRICERATIINAE Schütt

1896. Bacill. in Engl.-Prantl, Nat. Pflanzenf., p. 89.

Genus XXV. **DITYLUM** Bailey

1862. Boston Jour. Nat. Hist., vol. 7, p. 332.

Cells elongated, prismatic to box-shaped. Solitary except immediately after division. Valves three- to four-cornered, seldom bipolar, with a strong central siliceous hollow spine and a marginal ridge strengthened by ribs. Intercalary bands more or less numerous. Valve surface more or less wavy, with usually poorly developed humps on the corners. In the central part a usually three-cornered elevated region the margin of which often has a circle of short perivalvar-directed spines. Outer valve margin more or less strongly wavy, giving the appearance of lines running from valve to valve. Cell wall weakly siliceous, valve membrane delicately areolated-punctated. Chromatophores numerous, small.

Species: 107. *D. brightwellii* (figs. 107-A, 107-B)

107. **Ditylum brightwellii** (West) Grunow

Figure 107-A; figure 107-B

1860. West. Trans. Micr. Soc., N.S., vol. 8, p. 149, pl. 7, fig. 6 (*Triceratium brightwellii*). 1880–85. Grunow. In V. H. Syn., pl. 114, figs. 3–9.

Cells prism-shaped, with strongly rounded angles to nearly cylindrical, usually three to five times as long as broad. Diameter $14\text{--}85\mu$. Valves triangular to circular with a central hollow spine. Valve rim strengthened by small parallel ribs. Girdle zone very long, not easily distinguishable from the valves. Scalelike intercalary bands visible with special treatment. Cell wall weakly siliceous, valves areolated-punctated, areolae about 10 in 10μ on center of valve, becoming more delicate toward the outside. A central area around the spine is structureless. Areolae in radial rows on valve surface, in perivalvar rows on valve mantle. On base of mantle 16–19 areolae (or puncta) in 10μ . Structure of intercalary bands similar but more delicate. Chromatophores small, numerous. Nucleus central. Resting spores large, excentric or polar. Valves like those of mother cell, primary valve with a long valve mantle and strong spine, secondary valve without a mantle. Microspores reported (Gran and Angst, 1931, p. 494, fig. 80).

Neritic. South temperate species. A common form off southern California, in Gulf of California, and north to Scotch Cap, Alaska. Never in very large numbers.

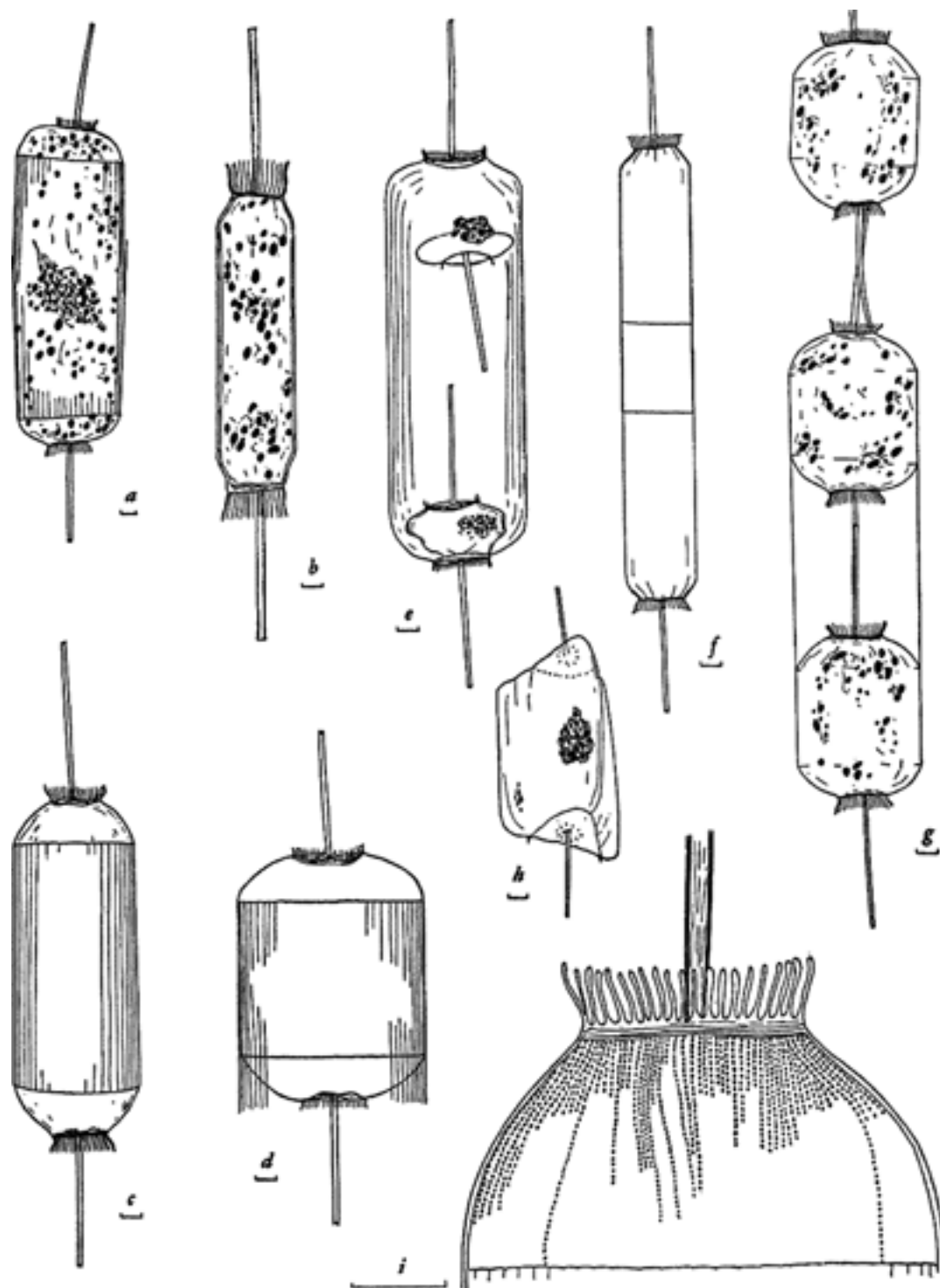

Fig. 107-A. *Ditylum brightwellii* (West) Grun. *a*, typical cell with chromatophores; diameter, 63μ . *b*, cell, 36μ in diameter, with chromatophores. *c*, cell 55μ in diameter. *d*, cell 83μ in diameter. *e*, abnormal cell division; diameter, 61μ . *f*, cell 33μ in diameter. *g*, cell division; diameter, 57μ . *h*, view of cell turned to show actual shape. *i*, valve mantle showing arrangement of sculpturing. *b* from Alaska, others from southern California.

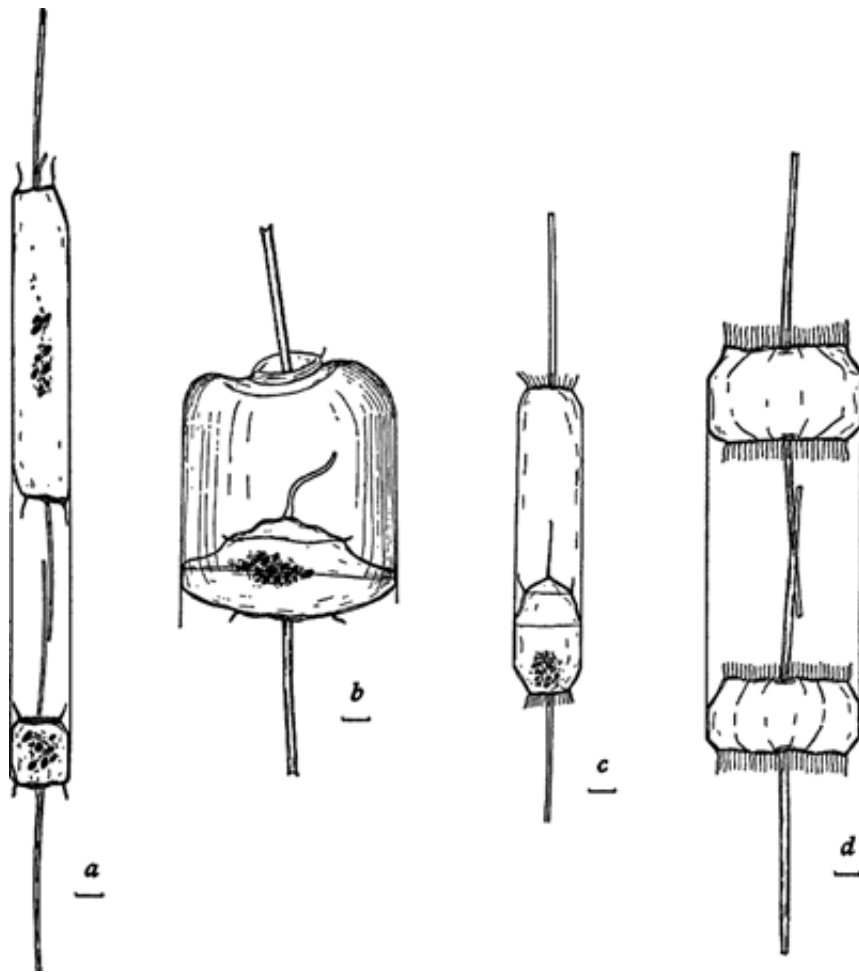

Fig. 107-B. *Ditylum brightwellii* (West) Grun. *a*, cell division; diameter, 18μ . *b*, resting spore in parent cell; diameter, 78μ . *c*, resting spore in parent cell; diameter, 24μ . *d*, cell division; diameter, 50μ . *b* is from southern California; *a*, *c*, and *d* from Alaska.

Genus XXVI. **LITHODESMIUM** Ehrenberg
1841. Phys. Abh. Akad. Wiss. Berl. 1839, p. 75.

Cells united in usually long, straight chains with concealed apertures. Valves three-cornered. Valves with marginal perivalvar-directed membrane by which adjacent cells are joined. Long, thin, hollow spine in center of valve. Intercalary bands present, collarlike. Chromatophores numerous, small.

Species: 108. *L. undulatum* (fig. 108)

108. **Lithodesmium undulatum** Ehrenberg

Figure 108

1841. Phys. Abh. Akad. Wiss. Berl. 1839, p. 75, pl. 4, fig. 13.

Chains straight, $35-68\mu$ broad. Valves three-cornered with undulating margin. Valve mantle high, fairly flat valve surface. Long, thin, hollow spine in center of valve. Cell wall weakly siliceous, areolated-punctated on valves, intercalary bands, girdle bands, and connective membrane. Central hyaline area on valve. On valve surface about 18 radial rows in 10μ , with 17-20 areolae in 10μ on rows. Structure of girdle bands and intercalary bands more delicate, 22-25 areolae in 10μ . Connective membrane usually with coarser areolae, 10-14 in 10μ , often, even in the same colony, more delicate.

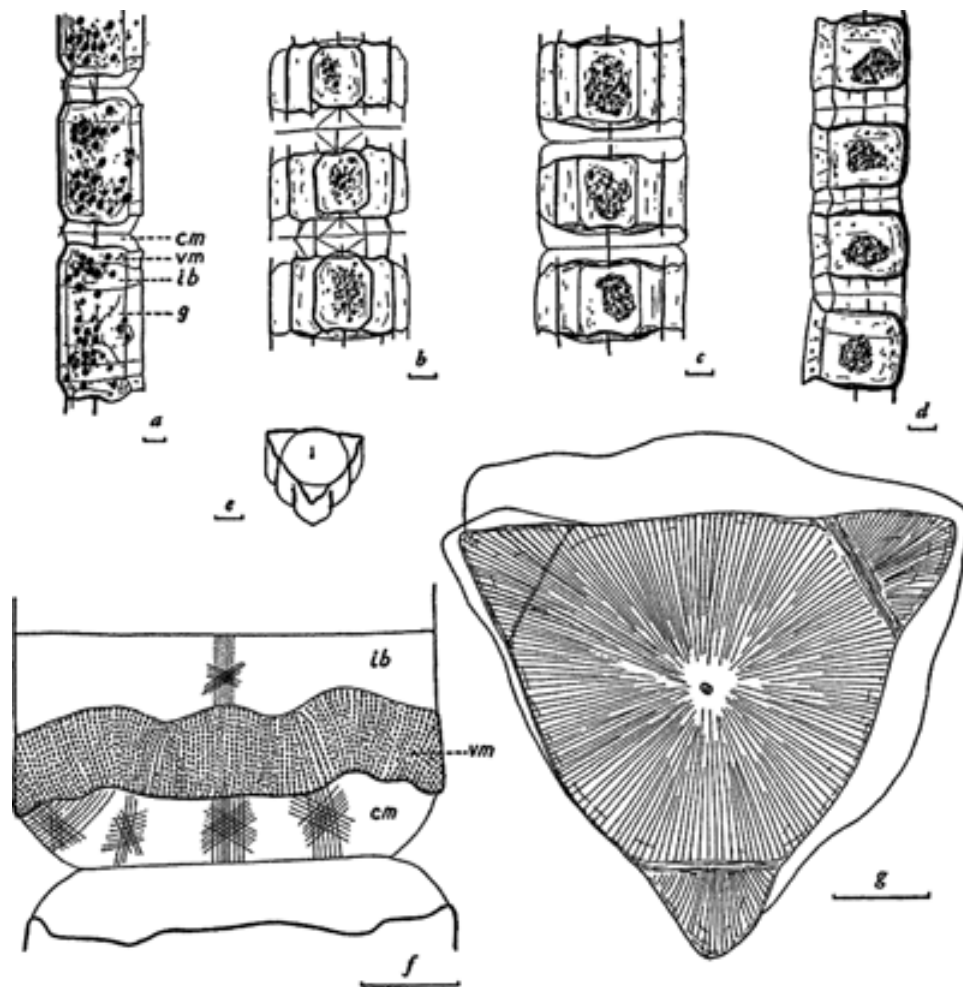

Fig. 108. *Lithodesmium undulatum* Ehr. *a*, girdle view of chain; width, 35μ (see [*f*]). *b* and *c*, same chain at different focuses; width, 55μ . *d*, another chain; width, 40μ . *e*, semi-valve view, to show true shape of cell. *f*, highly magnified section of part of cell illustrated in (*a*) showing sculpturing. *g*, valve view showing sculpturing. *cm*, connecting membrane; *vm*, valve mantle; *ib*, intercalary band; *g*, girdle.

Neritic. South temperate species. Not uncommon off southern California. Occasionally in fairly large numbers (up to 120,000 cells per liter in August, 1927) off La Jolla. Moderately abundant in some catches in Gulf of California in March, 1937.

c) BIDDULPHIINAE Schütt

1896. Bacill. in Engl.-Prantl, Nat. Pflanzenf., p. 92.

Genus XXVII. **BIDDULPHIA** Gray

1821. S. F. Gray. Nat. arr. Brit. plants, vol. 1, p. 294.

Cells box-shaped to cylindrical. Valves elliptical, with two poles or three- or four-sided (rarely five-sided). At the corners or at the ends of the apical axis more or less strongly developed processes or horns may be present (see fig. D, 4, *pr*), or with distinct corners, usually with transapical grooves so that valve surface is more or less strongly humped. Very fine slime pores usually present on end surfaces of processes or on corners

of the valves, forming slime cushions which hold the cells together in straight or zigzag chains. In plankton forms, spines (fig. D, 4, *s*) are usually present which hold the cells in chains or the cells may live singly. Girdle zone sharply differentiated from valve zone, cylindrical or prism-shaped, with numerous cross striations. Intercalary bands indistinct if present. Chromatophores numerous, small, lying against the cell wall. Nucleus central. Cell wall, except in delicate plankton forms, strongly siliceous, usually with distinct areolae or granules. Auxospores formed. Flagellated microspores known in a few species.

Usually coastal forms, often fixed. Certain species truly planktonic, but always neritic.

Species: 109. *B. pulchella* (fig. 109)

110. *B. mobiliensis* (fig. 110)

111. *B. longicuris* (figs. 111-A(1), 111-A(2), 111-A(3))

B. longicuris var. *hyalina* (figs. 111-B(1), 111-B(2), 111-B(3))

112. *B. aurita* (figs. 112-A(1), 112-A(2), 112-A(3))

B. aurita var. *obtusa* (fig. 112-B)

113. *B. rhombus* (fig. 113)

114. *B. dubia* (fig. 114)

115. *B. alternans* (fig. 115)

109. ***Biddulphia pulchella*** Gray

Figure 109

1821. Nat. arr. Brit. plants, vol. 1, p. 294.

SYNONYM: *Biddulphia biddulphiana* (Smith) Boyer.

Valves elliptical, convex, divided transversely by two to six ribs, sides undulating. Length along apical axis 50–70 μ . A globular process at each end of apical axis, constricted

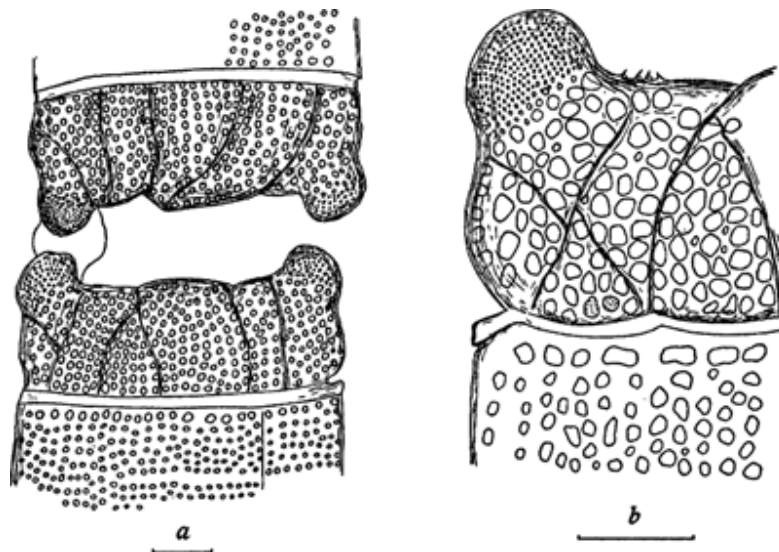

Fig. 109. *Biddulphia pulchella* Gray. *a*, parts of two cells; width (length along apical axis), 60 μ . *b*, section of cell more highly magnified.

at the base. Two or three short spines usually present near center of valve. Very fine pores on rounded corner processes; about 20 areolae or puncta in 10 μ . Valve surface with 3½–5 areolae in 10 μ , smaller near the valve center. Valve mantle high, deep furrow at junction with girdle zone; 4–5 areolae in 10 μ near edge. Girdle band similarly areolated, 5–6 in 10 μ (usually slightly more delicate), in nearly parallel lines.

Found occasionally in plankton samples but a bottom form. Temperate species.

110. *Biddulphia mobiliensis* Bailey

Figure 110

1845. Amer. Jour. Sci., vol. 48, p. 336, pl. 4, fig. 24.

Cells single or rarely united in short straight chains by the long spines. Length of apical axis 45–157 μ . Valves elliptical-lanceolate, convex, with a flat or nearly flat central part. Valve processes slender, arising inside the margin of the valve, directed

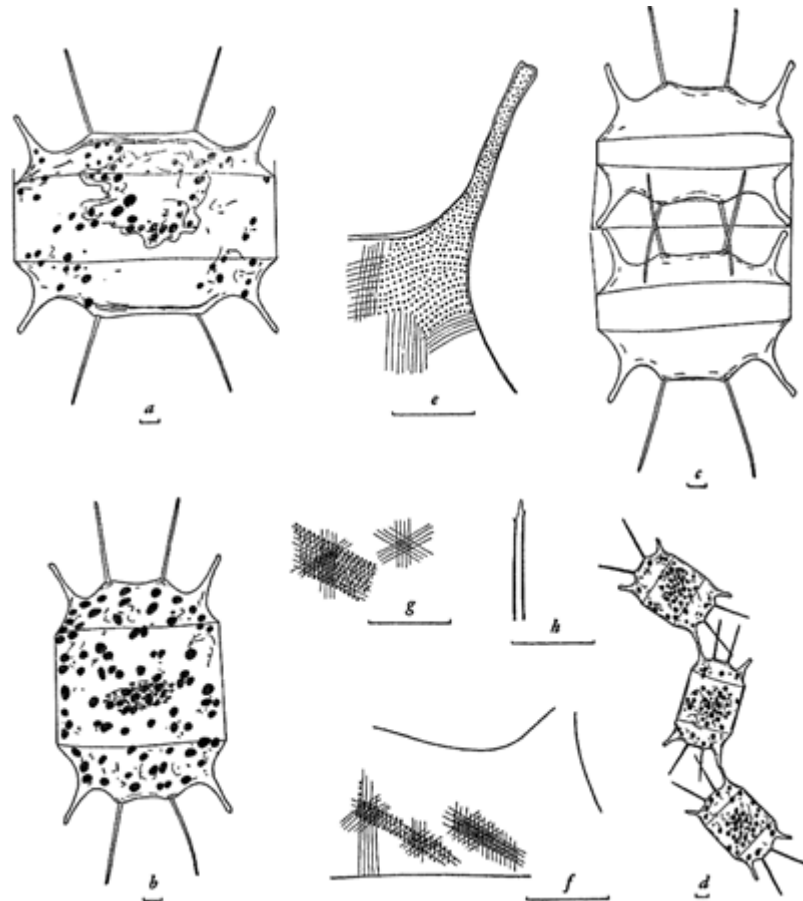

Fig. 110. *Biddulphia mobiliensis* Bail. *a*, typical cell, broad girdle view; width, 157 μ . *b*, typical cell with normal distribution of chromatophores; width, 89 μ . *c*, cell division; width, 100 μ . *d*, chain; width, 45 μ . *e*, sculpturing on valve process. *f*, sculpturing on valve mantle. *g*, sculpturing on girdle band. *h*, end of spine.

diagonally outward. Two long spines placed far apart but about equally far from the processes, directed obliquely outward, straight or often bent abruptly in their outer part. Cells relatively thin-walled, without a sharp constriction between valve and girdle zone. Sculpturing fine, reticulate, 14–16 areolae in 10 μ on valve and valve mantle, 17–18 on girdle band. Auxospores formed as large bladders from the separation of the valves, with much larger cells inside. Microspores observed.

Neritic, truly planktonic. Temperate and south temperate species. Common off southern California but never observed in large numbers.

111. *Biddulphia longicuris* Greville

Figure 111-A(1); figure 111-A(2); figure 111-A(3)

1859. Quart. Jour. Micr. Sci., vol. 7, p. 163, pl. 8, fig. 10.

Valves broad elliptical-lanceolate. Length of apical axis 15–110 μ ; average of 144

Fig. 111-A (1). *Biddulphia longicuris* Grev. *a*, cell in broad girdle view showing sculpturing on valve and band; width, 42 μ . *b*, typical cell with chromatophores; width, 40 μ . *c*, three-celled chain; width, 62 μ . *d*, cell in narrow girdle view showing sculpturing on valve process and intercalary bands. *e*, valve view; length along apical axis (width in broad girdle view), 36 μ ; length of transapical axis, 20 μ .

specimens, 47μ . Surface with a rounded conical elevation in the center from which usually two (sometimes one or three) long spines project obliquely upward and extend past and on either side of the adjacent valve of the neighboring cell. Spines often bent to run

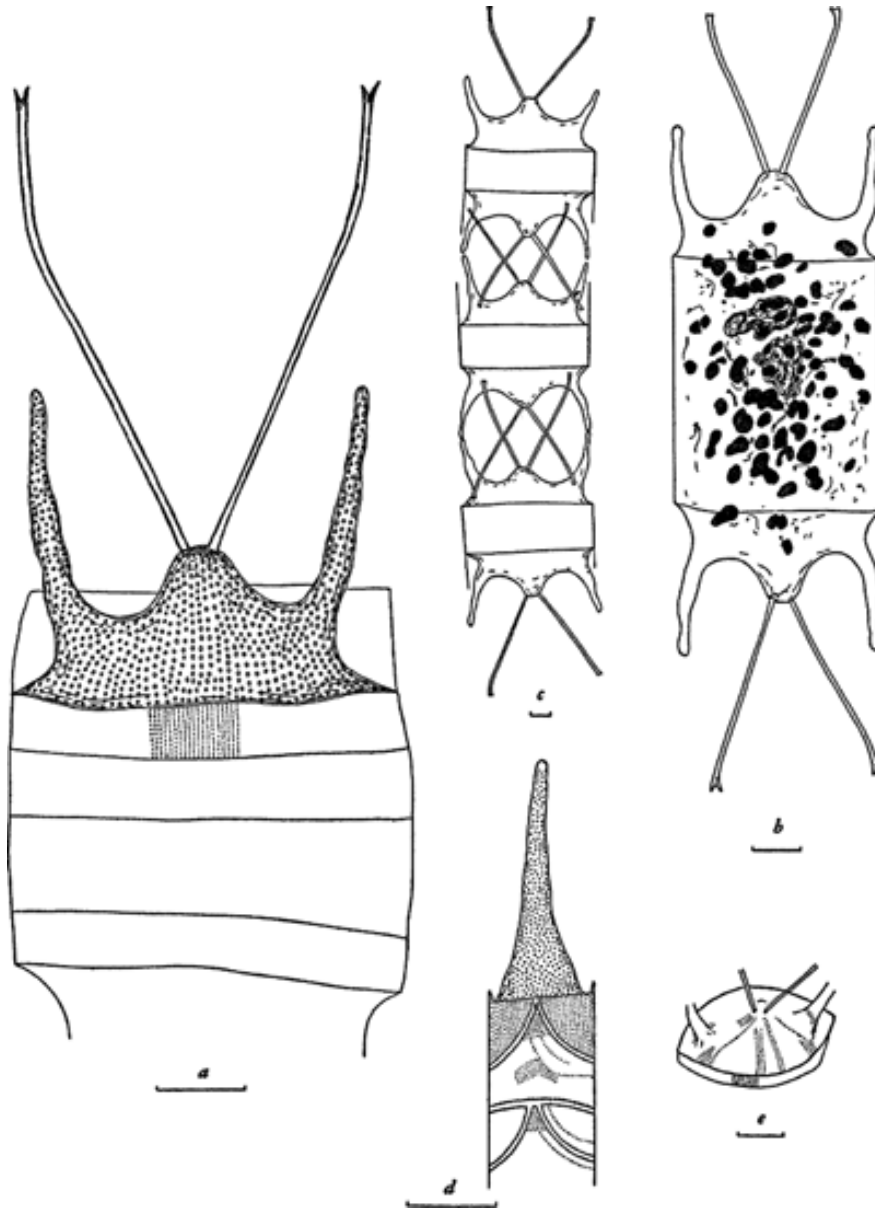
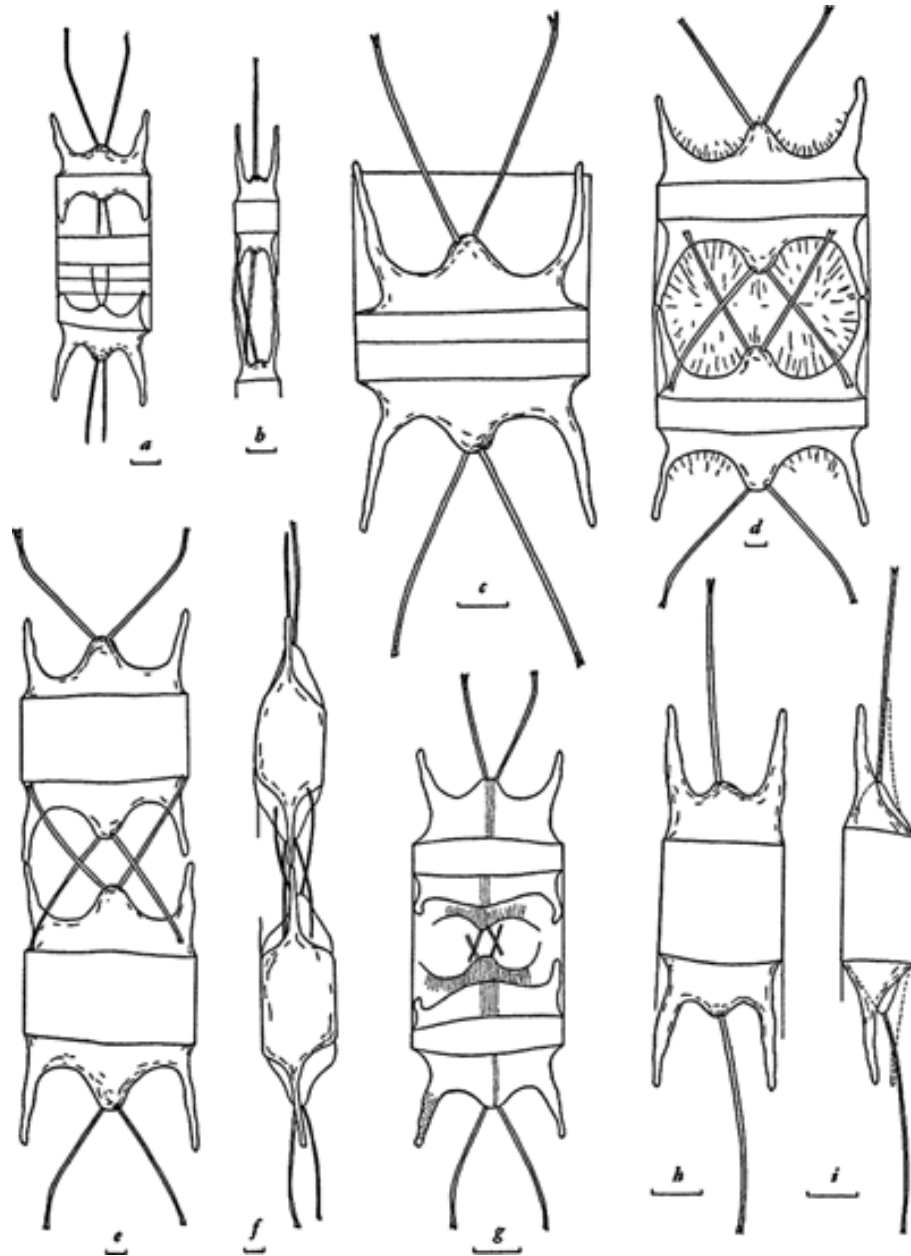

Fig. 111-A (2). *Biddulphia longicuris* Grev. *a*, abnormal cell division; width, 32μ . *b*, individuals with one spine on each valve; width, 15μ . *c*, normal, recently divided cell; width, 48μ . *d*, cell division (note filmlike siliceous membrane between cells); width, 98μ . *e*, chain in broad girdle view; width, 79μ . *f*, same chain as in (*e*), narrow girdle view. *g*, abnormal cell division; width, 33μ . *h*, cell with one spine on each valve, broad girdle view; width, 24μ . *i*, same cell as in (*h*), narrow girdle view.

nearly parallel to pervalvar axis near ends, with cuplike expansion on tips. Processes situated at ends of apical axis, usually long and slender, with rounded ends, slightly inflated at base. Cells joined into chains by ends of processes. Usually a deep indentation or concavity on valve mantle above junction with girdle zone. Girdle zone with straight sides. Valves with puncta radiating from a small hyaline central area, forming concentric

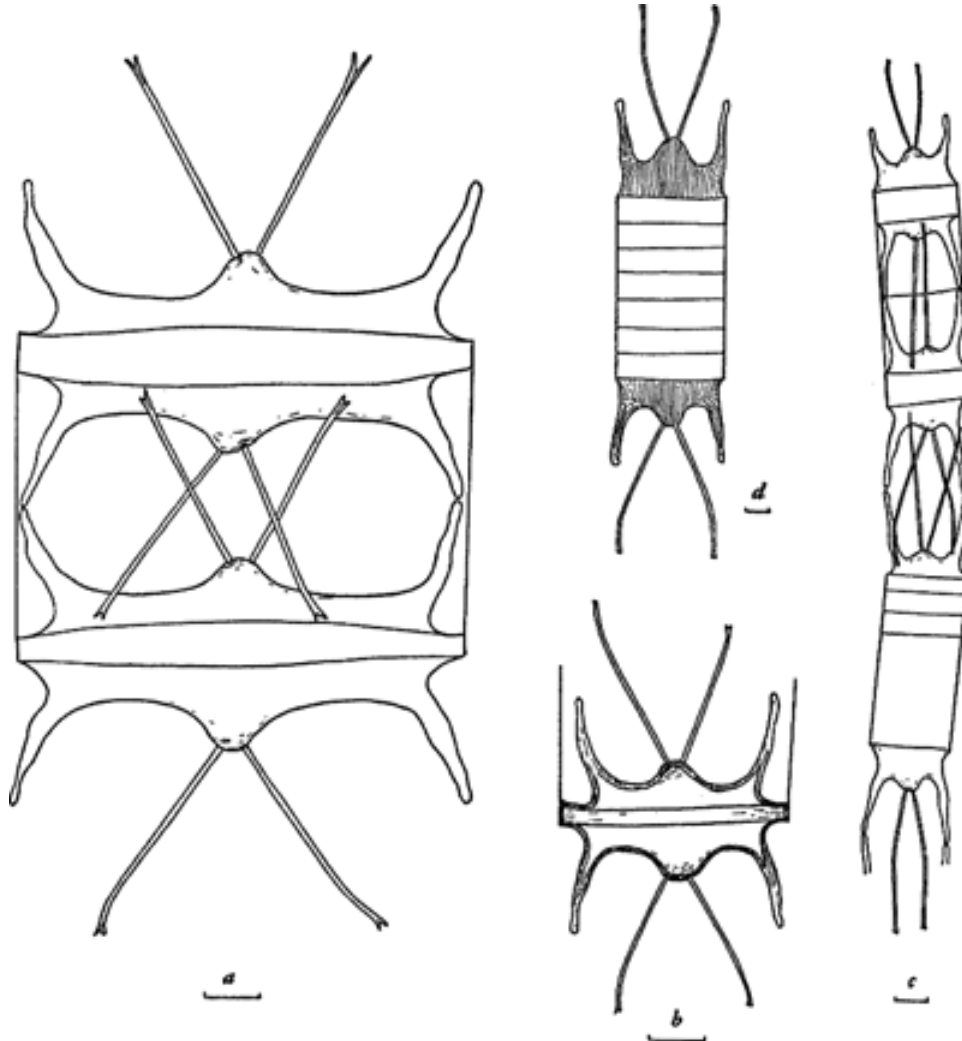

Fig. 111-A (3). *Biddulphia longicuris* Grev. *a*, large cells; 85μ wide. *b*, recently divided cell; width, 41μ . *c*, chain of one long cell with intercalary bands, and a dividing cell (note new valves of daughter cells have one spine only); width, 24μ . *d*, cell with intercalary bands (resembles *B. longicuris* var. *japonica* Grun., figured in Van Heurck, Syn., pl. 100, fig. 7); width, 42μ .

ellipses on each half of the valve, in nearly parallel rows near base of valve mantle. Puncta on valve 12–17 in 10μ . Girdle zone with fine, parallel, vertical rows of puncta, 18–21 puncta in 10μ . Intercalary bands sometimes present, finely punctate, puncta 15–18 in 10μ , in vertical rows. Occasionally with a filmlike siliceous membrane between adjacent cells. Chromatophores small, numerous, near the wall. Nucleus central.

Neritic. Temperate to subtropical species. Reported north to Straits of Juan de Fuca. Most abundant in warmer waters. Common at Point Hueneme and south to $17^{\circ}41'$ north latitude.

Variety *hyalina* (Schröder) Cupp

Figure 111-B(1); figure 111-B(2); figure 111-B(3)

1906. Schröder. Vierteljahrsh. naturforsch. Ges. Zürich, vol. 51, p. 353, fig. 21 (*Biddulphia hyalina*).

Fig. 111-B (1). *Biddulphia longicuris* var. *hyalina* (Schröd.) Cupp. *a*, typical chain (note filmlike siliceous membrane between cells); width, 85μ . *b*, cell division; width, 48μ . *c*, typical chain (note three spines on valve of lowest cell); width, 125μ . *d*, sculpturing on valve mantle; width, 88μ .

SYNONYMS: *Biddulphia extensa* Mann, 1907, Contrib. U.S. Nat. Herb., vol. 10, pt. 5, p. 302. pl. 47, figs. 1, 2.

Biddulphia longicuris Greville, in Gran and Angst, 1931, Publ. Puget Sound Biol. Sta., Univ. Wash., p. 491, fig. 75, a-c.

Valve an elongated ellipse. Length of apical axis 24–184 μ ; average of 80 specimens, 87 μ . General shape of valve as in type. Spines similar to those of type but usually relatively shorter. Often entire spine oblique without ends running parallel to perivalvar

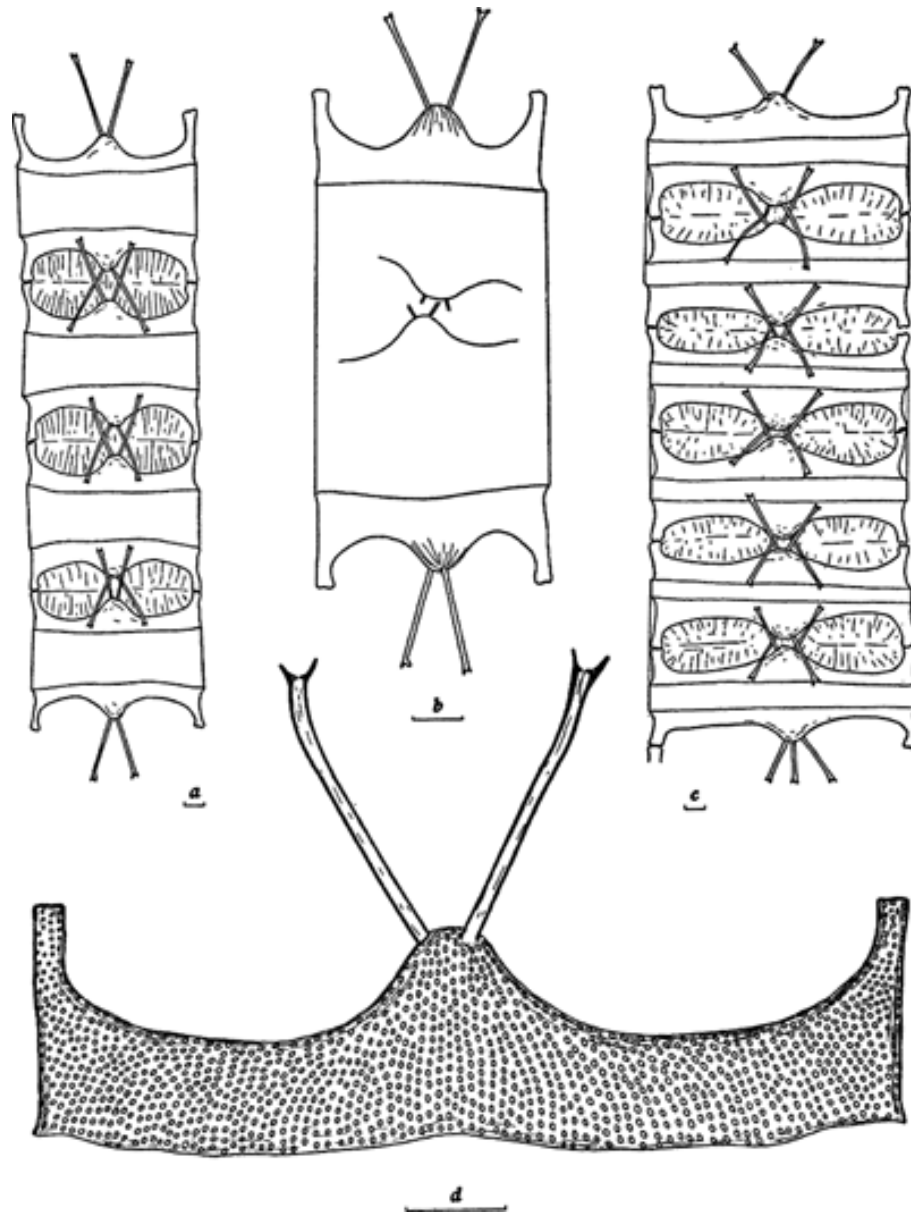
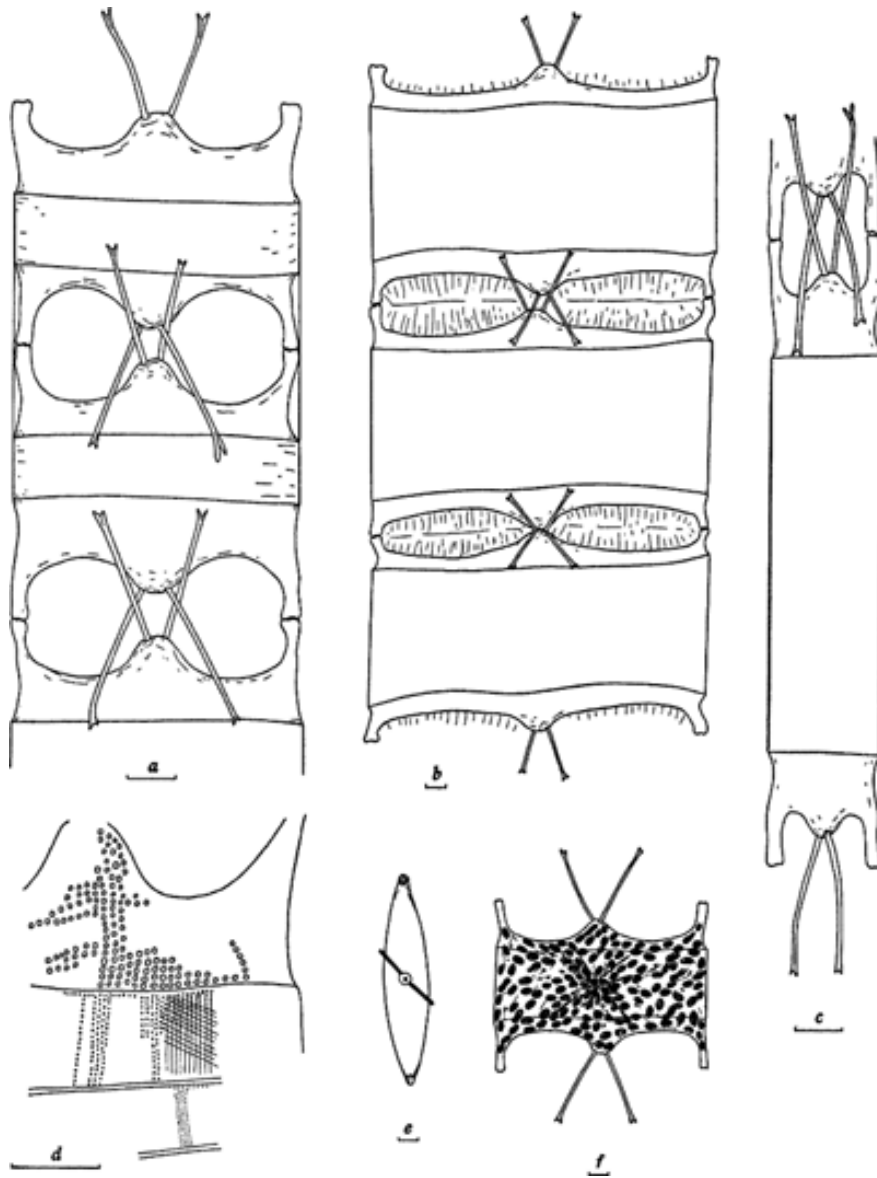

Fig. 111-B (2). *Biddulphia longicuris* var. *hyalina* (Schröd.) Cupp. a, typical chain, filmlike siliceous membrane not present; width, 63 μ . b, wide chain (note siliceous membrane between cells); width, 170 μ . c, long narrow cell; width, 24 μ . d, sculpturing on valve mantle and bands. e, valve view; length along apical axis, 100 μ ; length along transapical axis, 20 μ . f, typical cell with chromatophores; width, 103 μ .

axis. Processes usually much shorter than those in type, more robust, with blunt ends. Girdle zone separated from valve mantle by a shallow groove; only slight concavity above girdle zone. Arrangement of punctation as in type; slightly coarser on valve, 8–12 puncta in 10μ . On girdle 18–22 puncta in 10μ . Intercalary bands usually absent; when present, with 16–20 puncta in 10μ . Filmlike siliceous membrane between adjacent cells found much more commonly than in type. Chromatophores numerous, small. Cells usually in straight, more or less long chains.

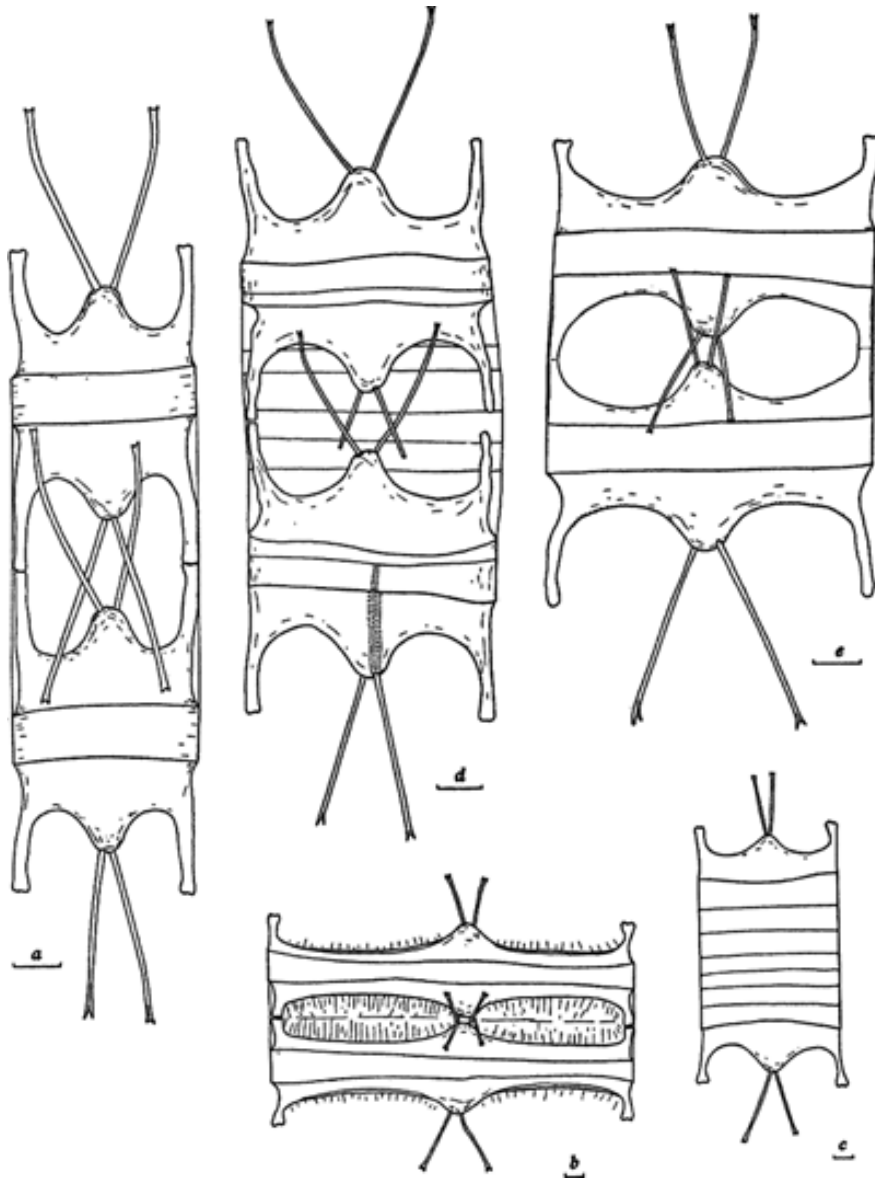

Fig. 111-B (3). *Biddulphia longicruris* var. *hyalina* (Schröd.) Cupp. *a*, two typical cells; width, 42μ . *b*, two wide, flat cells; width, 176μ . *c*, cell with numerous intercalary bands; width, 73μ . *d* and *e*, transition forms between species and variety; widths: *d*, 58μ ; *e*, 73μ . Note differences in length and shape of processes on two ends of same cell, particularly in (*e*).

Found with the type in temperate regions but extends into more northern waters. Common off La Jolla, Point Hueneme, San Francisco, and north to Alaska.

Mann, in 1907, described the species *B. extensa* from specimens found in Monterey Bay, California. A year earlier Schröder had described his new species, *B. hyalina*, from San Francisco Bay, a species which is undoubtedly identical with Mann's *B. extensa*. Gran and Angst (1931) gave *B. extensa* as

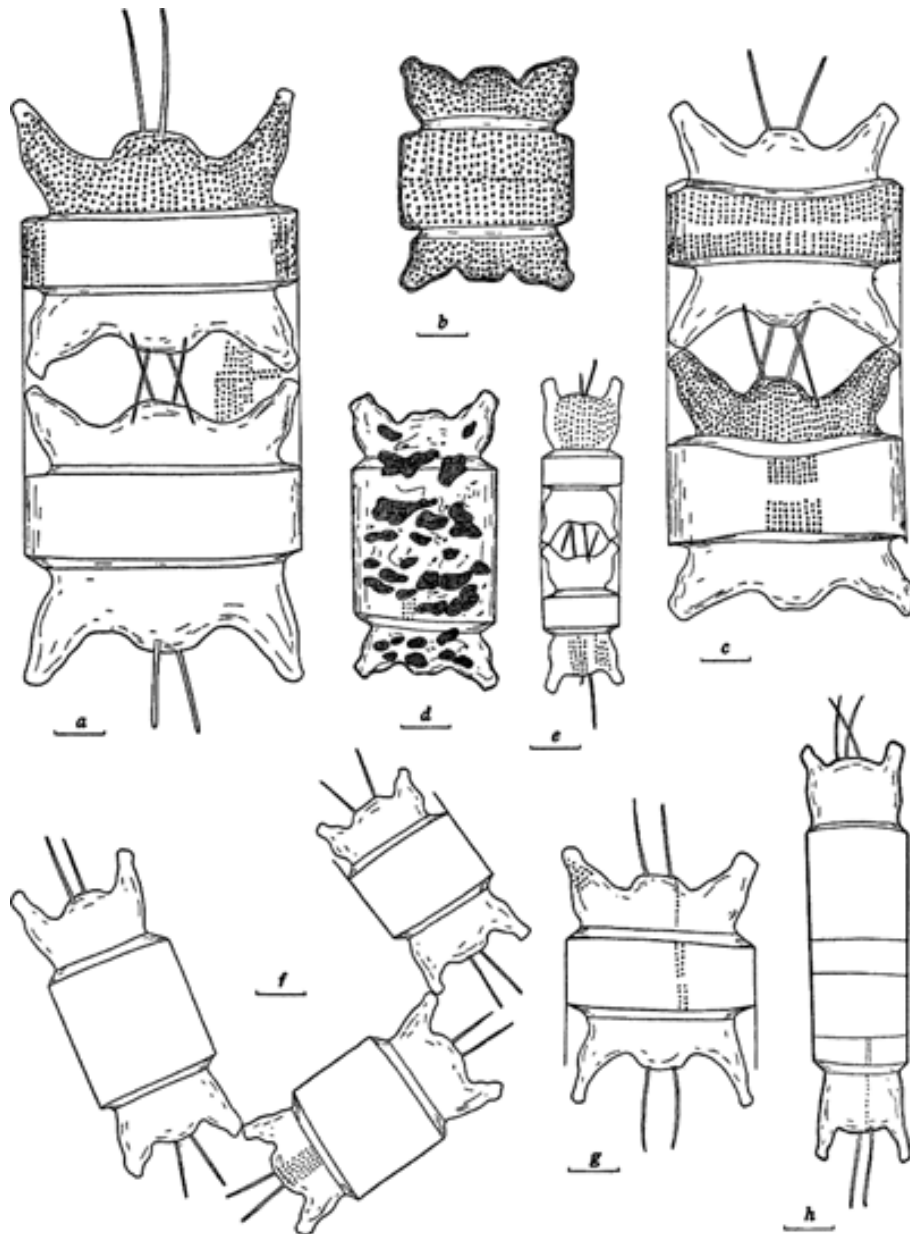

Fig. 112-A (1). *Biddulphia aurita* (Lyng.) Bréb. and God. *a*, typical cells, broad girdle view; width, 61μ . *b*, cell with all sculpturing indicated; width, 36μ . *c*, width, 48μ . *d*, cell with chromatophores; width, 30μ . *e*, width, 16μ . *f*, chain; width, 30μ . *g*, width, 40μ . *h*, width, 24μ . All specimens from Alaskan waters.

a synonym of *B. longicuris* described in 1859 by Greville from specimens found in California guano. On casual examination this synonymy seems unjustified. However, after a study of hundreds of specimens from the Canal Zone to Alaska, it was found impossible to place many individuals definitely in one or the other species. In fact, on several occasions specimens were found in which one end bore a close resemblance to what has been called *B. longicuris*, the other end to *B. hyalina* (fig. 111-B(3), *d, e*). We feel, consequently, that a separation of the group into two species is unjustified. On the other hand, the differences in habitat, average length of apical axis, and shape of processes are too definite to warrant placing all the specimens under *B. longicuris*. The logical disposition of the matter seems to be to make *B. hyalina* a variety under the type *B. longicuris*.

112. ***Biddulphia aurita*** (Lyngbye) Brébisson and Godey

Figure 112-A(1); figure 112-A(2); figure 112-A(3)

1819. Lyngbye. Tent. hydrophyt. dan., p. 182, pl. 62, fig. *D* (*Diatoma auritum*).

1838. Brébisson and Godey. Consid. sur les Diat., p. 12.

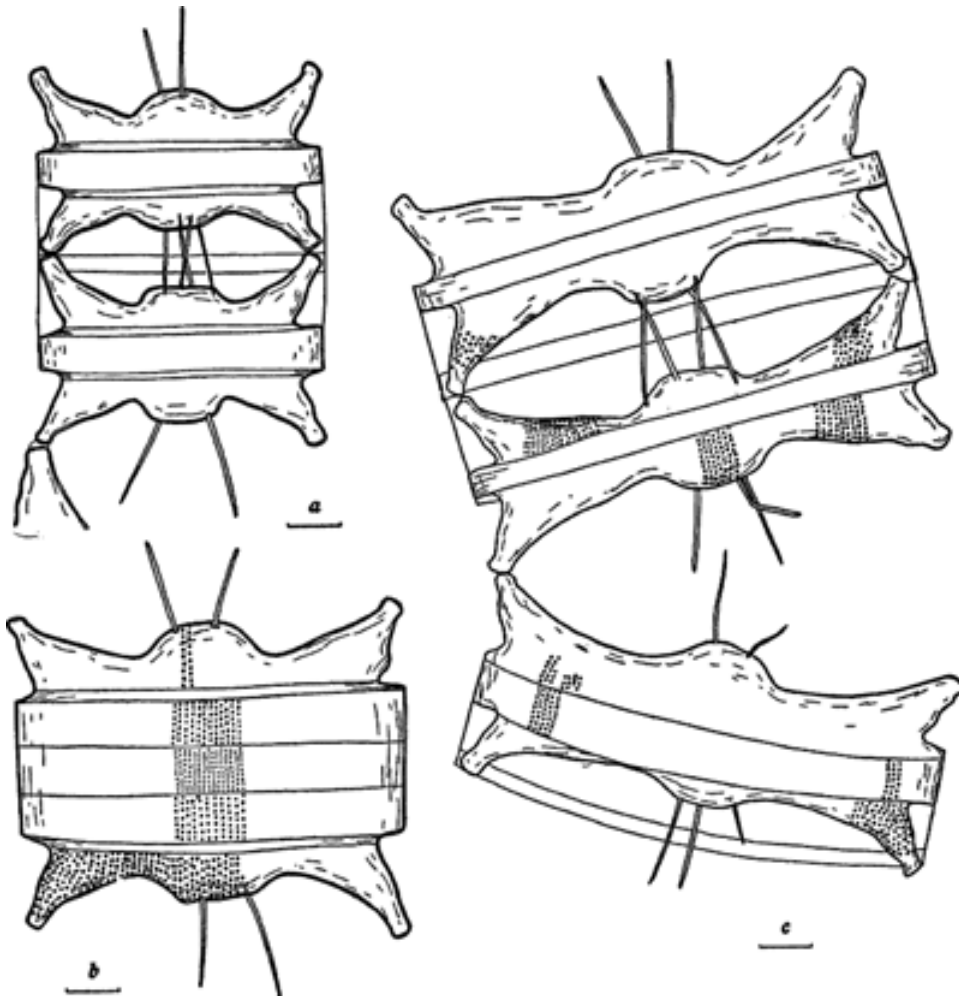

Fig. 112-A (2). *Biddulphia aurita* (Lyng.) Bréb. and God. Broad forms (from Alaskan waters); widths: *a*, 54 μ ; *b*, 79 μ ; *c*, 97 μ .

Cells united in straight or zigzag chains. Valves elliptical-lanceolate, with obtuse processes inflated at the base. Center part of valve convex, more or less flattened at the top from which usually more or less long spines project. Spines sometimes absent or several. Girdle zone sharply differentiated from the valve zone by a clear depression. Cell wall strongly siliceous, areolated-punctated. Areolae 8–10 in 10μ , on the valve in radial rows. On the girdle band in perivalvar rows, 7–10 rows in 10μ , with 8–14 puncta

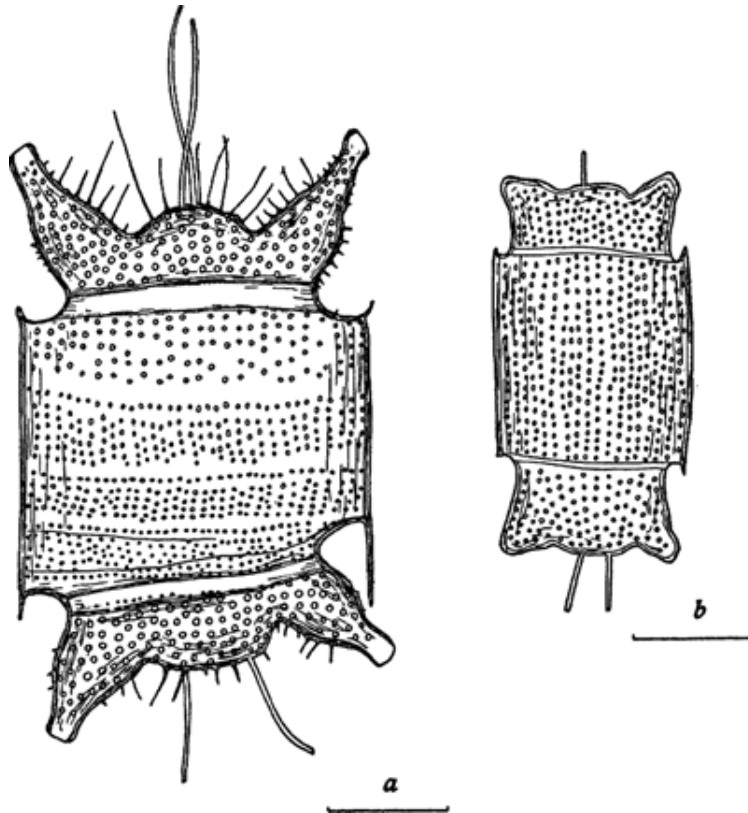

Fig. 112-A (3). *Biddulphia aurita* (Lyng.) Bréb. and God. *a*, individual found in lat. $17^{\circ}41' N.$, long. $102^{\circ}3' W.$; width, 29μ (note spines on valves). *b*, individual from southern California; width, 16μ .

or areolae in 10μ . A very variable species. Length of apical axis $12-97\mu$. With a number of small spines on valves in warmer-water specimen [fig. 112-A(3), *a*] from $17^{\circ}41'$ north latitude, $102^{\circ}3'$ west longitude.

Neritic and littoral species. Widely distributed, but most abundant in northern (arctic and boreal) seas. Very common at Scotch Cap, Alaska (Cupp, 1937), especially during April and May. Common off southern California but never in large numbers.

Variety **obtusa** (Kützing) Hustedt

Figure 112-B

1844. Kützing. Bacill., p. 137, pl. 18, fig. VIII, 1–3, 6–8 (*Odontella obtusa*).

1930. Hustedt. Kieselalgen, pt. 1, p. 848, fig. 502.

Differs from the type chiefly in the shortness of the processes and the absence of central spines. The difference in the processes is not always very apparent. Length along apical axis $24-70\mu$. Puncta 8–10 in 10μ on valve in radiating rows; 7–8 on girdle in 6 perivalvar rows in 10μ .

Littoral. Arctic to north temperate species. Fairly common off Scotch Cap, Alaska. Not recorded off southern California.

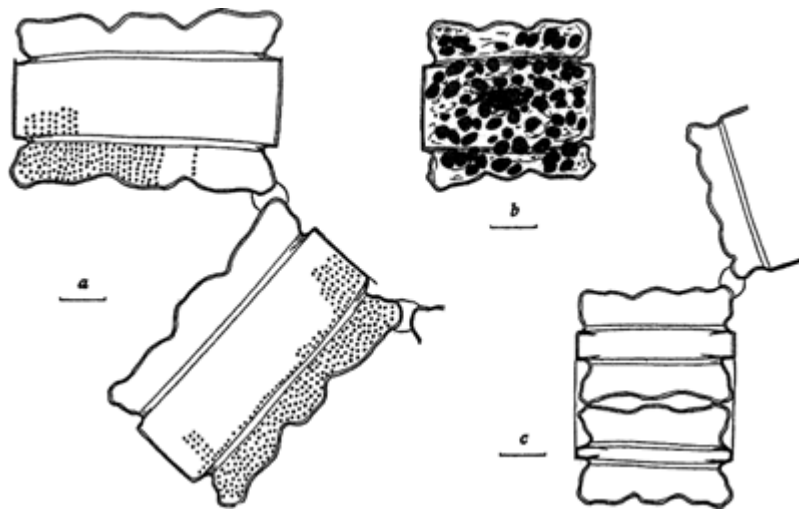

Fig. 112-B. *Biddulphia aurita* var. *obtusa* (Kütz.) Hust. *a*, two cells from a chain, sculpturing indicated; width, 61μ . *b*, typical cell, with chromatophores; width, 36μ . *c*, cell division; width, 36μ .

113. *Biddulphia rhombus* (Ehrenberg) W. Smith

Figure 113

1841. Ehrenberg. Phys. Abh. Akad. Wiss. Berl. 1839, p. 80, pl. 4, fig. 11 (*Zygoceros rhombus*).

1856. W. Smith. Syn. Brit. Diat., vol. 2, p. 49, pl. 45, fig. 320; pl. 61, fig. 320.

Valves rhombic-elliptical or triangular. Cells thick-walled, rather low, strongly sculptured. Processes small, short, and obtuse. Surface of valve convex, beset with small spines over entire surface. One or two larger spines near center of valve. Valve zone and girdle zone divided by deep groove. Girdle outstanding. Areolae on valve 9–10 in 10μ , irregular at center, then more or less regular radiating. Girdle band more delicately sculptured, 12–14 areolae in 10μ in regular, perivalvar rows. Length of apical axis 37μ , transapical axis 24μ in individual sketched.

Neritic. North temperate species. Rare off California.

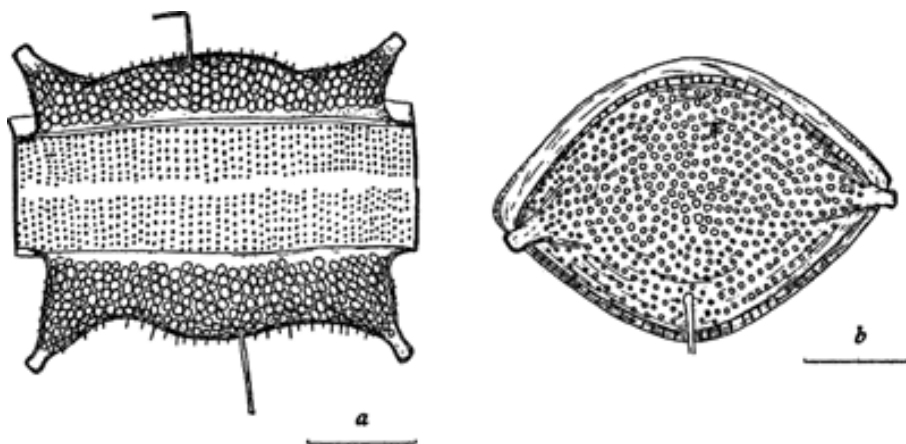

Fig. 113. *Biddulphia rhombus* (Ehr.) W. Sm. *a*, broad girdle view; width (length of apical axis), 37μ . *b*, valve view; length of transapical axis, 24μ .

114. *Biddulphia dubia* (Brightwell) Cleve

Figure 114

1859. Brightwell. Quart. Jour. Micr. Sci., vol. 7, p. 180, pl. 9, fig. 12 (*Triceratium dubium*).

1883. Cleve. Vega-Exped. Vetensk. Iakttag., vol. 3, p. 508.

Valves rhombic-lanceolate or triangular. Individuals found off southern California bipolar with sides extended to give valve nearly square cross section with concave sides. Processes obtuse. Center part of valve convex. Valve with numerous small spines and a larger one near base of each process. Small spines also on processes. Valve zone and

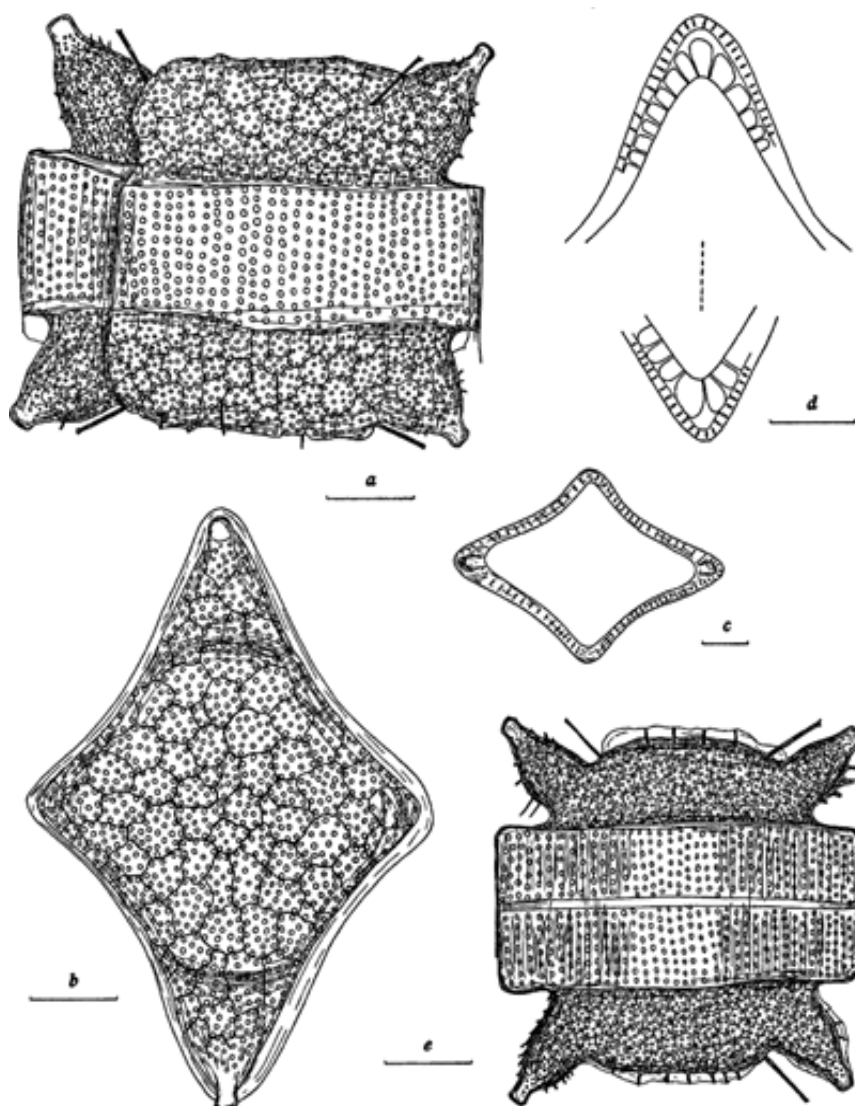

Fig. 114. *Biddulphia dubia* (Brightw.) Cl. *a*, girdle view. *b*, valve view of same cell; length along apical axis, 65μ ; length along transapical axis, 44μ ; length along sides, 40μ . *c*, valve view of same cell, lower focus. *d*, detail of valve view in (*c*). Upper end in (*d*) and (*b*) is left end in (*c*). *e*, girdle view of another cell, 42μ across.

girdle zone divided by a deep groove. Girdle outstanding. Surface of valve coarsely reticulated, 2–2½ meshes in 10 μ on center of valve, 2½–4 on mantle. Reticulations wavy, irregular, and of unequal size. Valves distinctly punctate, 8–9 puncta in 10 μ . Puncta on girdle in regular perivalvar rows, 7–8 puncta in 10 μ . Length of apical axis 42–65 μ ; of transapical axis 30–44 μ .

Neritic. Warm-water species, subtropical to tropical. Reported only occasionally off southern California.

Much confusion has arisen concerning the relationship of this species. It is unquestionably the same species as *Triceratium bicornis* Cleve (1878, p. 17, pl. 5, fig. 30). Figures 21–23 on plate 78 of Schmidt's Atlas are titled *Biddulphia reticulata* Roper var.? Mann (1907, p. 301) stated that they are certainly closer to *B. dubia*, and in fact figure 21 shows a specimen from San Francisco which closely resembles the ones sketched here. Figure 23, from a Yokohama specimen, is very similar to our figure 114, c. *Biddulphia reticulata* is a larger diatom than *B. dubia*, the reticulations are quite regular, usually hexagonal, with thin dividing walls showing "knots" at their points of juncture. The border is less massive and the valve outline is either elliptical or with convex sides approaching an elliptical outline. The puncta are smaller and more distinct than in *B. dubia*.

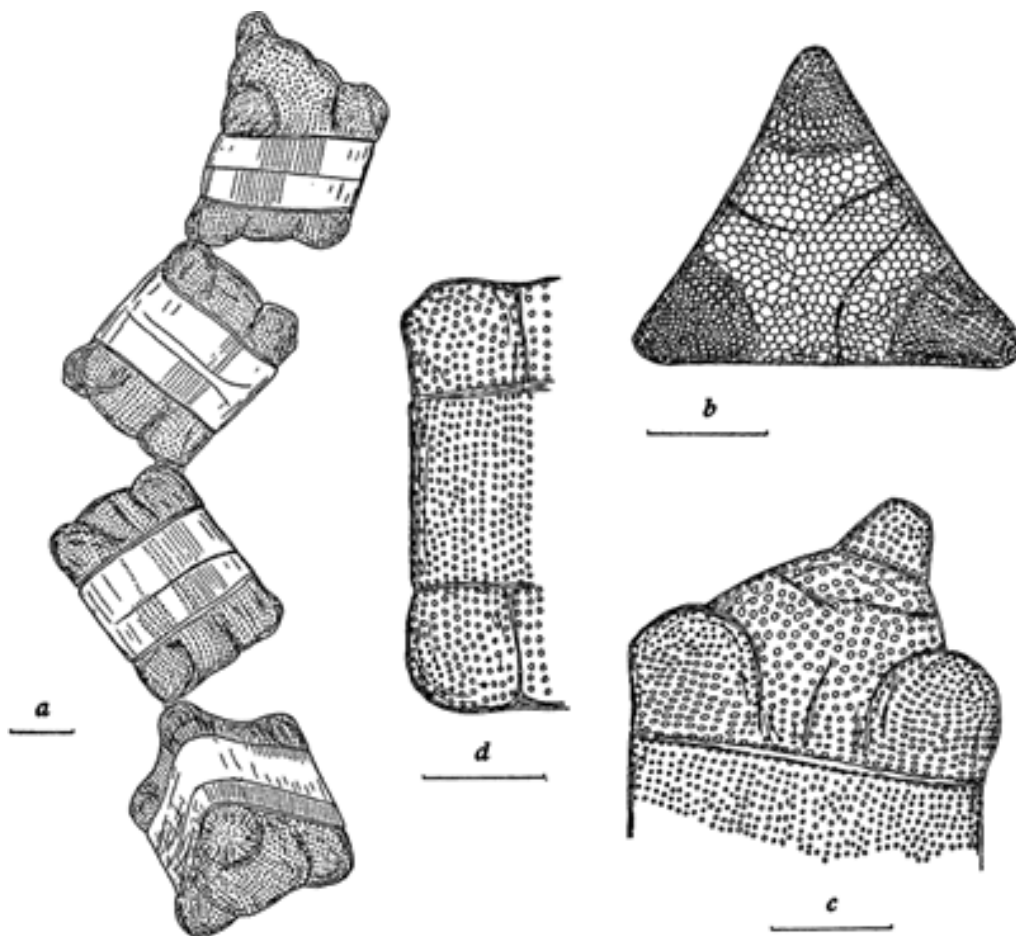

Fig. 115. *Biddulphia alternans* (Bail.) V. H. a, chain, girdle view. b, valve view; length along sides, 32 μ . c, semivalve view. d, girdle view of edge of cell.

115. *Biddulphia alternans* (Bailey) Van Heurck

Figure 115

1851. Bailey. Smithson. Contrib. Knowl., vol. 2, no. 3, p. 14, pl. 1, figs. 55–56 (*Triceratium alternans*).
1880–85. Van Heurck. Syn., p. 208, pl. 113, figs. 4–7.

Valves triangular, occasionally quadrangular, with straight or somewhat unevenly concave sides. Corners slightly elevated, rounded, separated from the central part by costae or ribs. Only a slight constriction or none between valve and girdle zones. Irregular ribs on both valve and girdle. Fine areolae (slime pores) on corners, 16–18 in 10μ . Areolae 8–10 in 10μ in center of valve, 10–12 on mantle. Girdle band with perivalvar rows of areolae, 16–18 in 10μ . Length along side of valve 27–34 μ ; along perivalvar axis 32–39 μ .

Neritic. Not often found in plankton samples. Fairly common along shore.

d) ISTHMIINAE Schütt

1896. Bacill. in Engl.-Prantl, Nat. Pflanzenf., p. 94.

Genus XXVIII. ISTHMIA Agardh

1832. Consp. crit. Diat., p. 55.

Cells cylindrical-box-shaped with elliptical valve surface and usually longer perivalvar axis. Intercalary bands absent. Girdle band usually strongly developed. Valves unlike, unipolar, on one pole of the apical axis with blunt or more pointed hump, with or without ribs. Cell wall strongly siliceous, with large areolae and chambers. Cells frequently building branching colonies, many cells lying at the side of other cells. Chromatophores rounded granules on the walls of the cells.

Species: 116. *I. nervosa* (fig. 116)

116. *Isthmia nervosa* Kützing

Figure 116

1844. Bacill., p. 137, pl. 19, fig. 5.

Cells very large, in outline variable, in broad girdle view rhombic or trapezoidal, valve plane smaller or broader elliptical. Apical axis 170–240 μ long. Cell wall with large

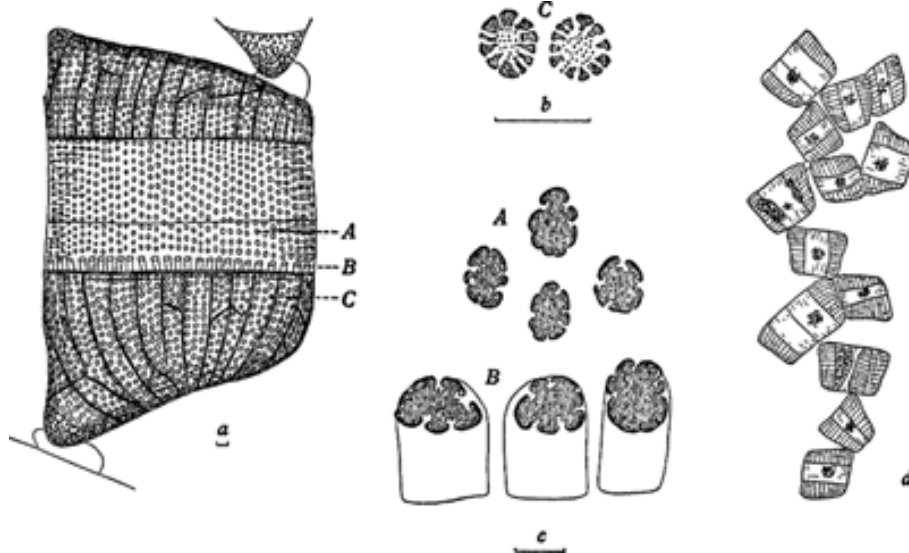

Fig. 116. *Isthmia nervosa* Kütz. a, girdle view of a cell; width, 240 μ . b, areolae from valve mantle (marked C on [a]). c, areolae from girdle band (regions indicated with corresponding letters A and B on [a]). d, colony.

areolae—chambers—with poroid outer membrane. Diameter of areolae $5\text{--}7.5\mu$, on the girdle band as a rule somewhat smaller ($5\text{--}6\mu$), on the valve mantle $6.5\text{--}7\mu$. On the mantle surface areolae arranged in more or less regular quincunx, on the valve surface irregular. Valves with several transapical, on the valve surface more or less anastomosing, ribs that extend to the edge of the valve mantle. Usually 10–12 ribs on each side of the valve.

Littoral. Occurring in plankton as tychopelagic species. Widespread, but never abundant. Usually found in colder waters. Reported from San Francisco to Alaska.

e) HEMIAULINAE Schütt

1896. Bacill. in Engl.-Prantl, Nat. Pflanzenf., p. 95.

Genus XXIX. **CERATAULINA** H. Péragallo

1892. Le Diatomiste, vol. 1, p. 103.

Cells cylindrical, usually in chains. Valves slightly arched, with two blunt projections or processes near their margin, attached to adjacent cell by means of a fine, small, curved, hairlike process which fits into the valve of the adjacent cell. Intercalary bands numerous, annular. Chromatophores numerous, small. Nucleus against the cell wall. Cell wall soft and weakly siliceous, collapsing when dried. Sculpturing very delicate.

Species: 117. *C. bergonii* (fig. 117)

117. **Cerataulina bergonii** H. Péragallo

Figure 117

1892. Le Diatomiste, vol. 1, p. 103, pl. 13, figs. 15, 16.

Cells twisted about the central axis of the chain; apertures between cells often very small. Processes short. Diameter of cells $11\text{--}36\mu$. Intercalary bands numerous, collarlike, very indistinct. Cell wall weakly siliceous and very delicately sculptured. Valves with radial rows of puncta, 21–23 puncta in 10μ . Chromatophores small, numerous.

Neritic. South temperate species. Common off California, in Gulf of California, and north to Alaska.

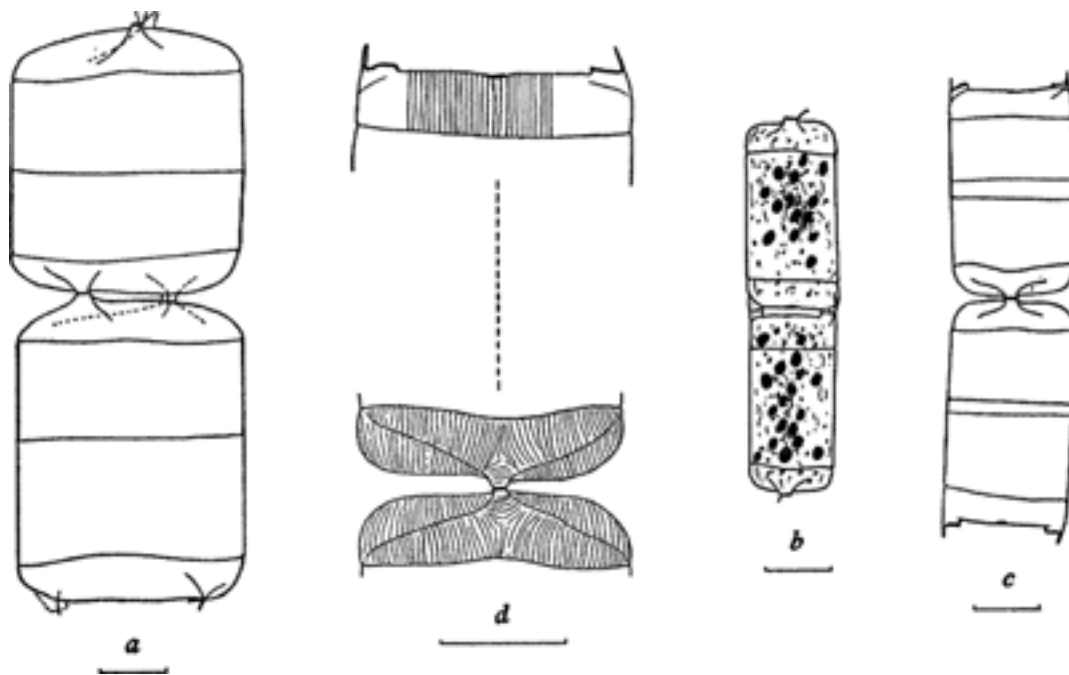

Fig. 117. *Cerataulina bergonii* H. Pér. a, cells 36μ wide. b, typical cells with chromatophores; width, 13μ . c, cells 20μ wide. d, valve mantles of cells illustrated in (c) showing arrangement of sculpturing.

Genus XXX. **HEMIAULUS** Ehrenberg

1845. Ber. Akad. Wiss. Berl. 1844, p. 199.

Cells single or united in chains. Valves elliptical in section, with two narrow, pointed, more or less long processes at the ends of the apical axis, parallel to pervalvar axis. One or more hyaline claws on the end of the processes. Intercalary bands indistinct or absent, without septa. Membrane strongly or weakly siliceous, finer or coarser areolated or punctated. Cells more or less bent. Chromatophores numerous.

Species: 118. *H. hauckii* (fig. 118)119. *H. sinensis* (fig. 119)120. *H. membranaceus* (fig. 120)118. **Hemiaulus hauckii** Grunow

Figure 118

1880–85. In V. H. Syn., pl. 103, fig. 10.

Cells long, straight or twisted, often forming chains more or less turned about the long axis. In broad girdle view oblong, with long thin processes which are strongly pointed. Apical axis 12–35 μ long. Valve surface flat or slightly concave, grooves absent. Valve mantle high, no groove at junction with girdle band. Apertures between cells large because of long processes. Cell wall weakly siliceous, often without visible sculpturing, puncta when visible 16–17 in 10 μ on valves.

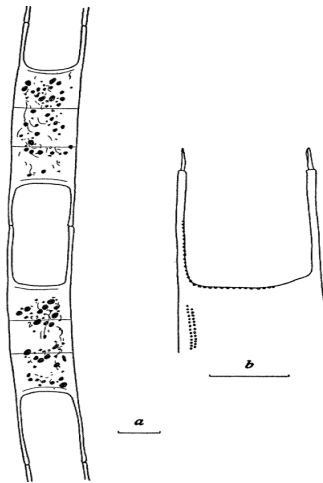

Fig. 118. *Hemiaulus hauckii* Grun. *a*, part of a chain, broad girdle view; width, 15 μ . *b*, detail of processes, claws, and sculpturing of valve mantle; width, 18 μ .

Oceanic or neritic. Temperate and tropical species. Not uncommon off southern California and in Gulf of California but never in large numbers. Recorded by Lebour (1930) as an oceanic, temperate and tropical species; by Gran (1912) as neritic, tropical.

119. **Hemiaulus sinensis** Greville

Figure 119

1865. Ann. Mag. Nat. Hist., vol. 16, no. 591, pl. 5, fig. 9.

Cells broadly elliptical in valve view. Chains straight or curved, more or less long. Pervalvar axis more or less elongated. Apical axis 15–36 μ long. Valves with slightly convex surface of elliptical outline. Valve mantle high, no groove at base. Processes on valves thin but strong, with a strong claw on the ends. Cell wall more strongly siliceous than in *H. hauckii*, areolated-punctated. Areolae in radial, on the mantle surface pervalvar, rows of characteristic excentric arrangement in that the center of the areolation

does not coincide with the center of the valve, but lies on one of the mantle surfaces. Areolae in the center of the valve 7–9 in 10μ , on the base of the mantle 11–13 in 10μ . Intercalary bands visible with special preparation. Very fine punctation present on bands in rows, 28–29 rows in 10μ .

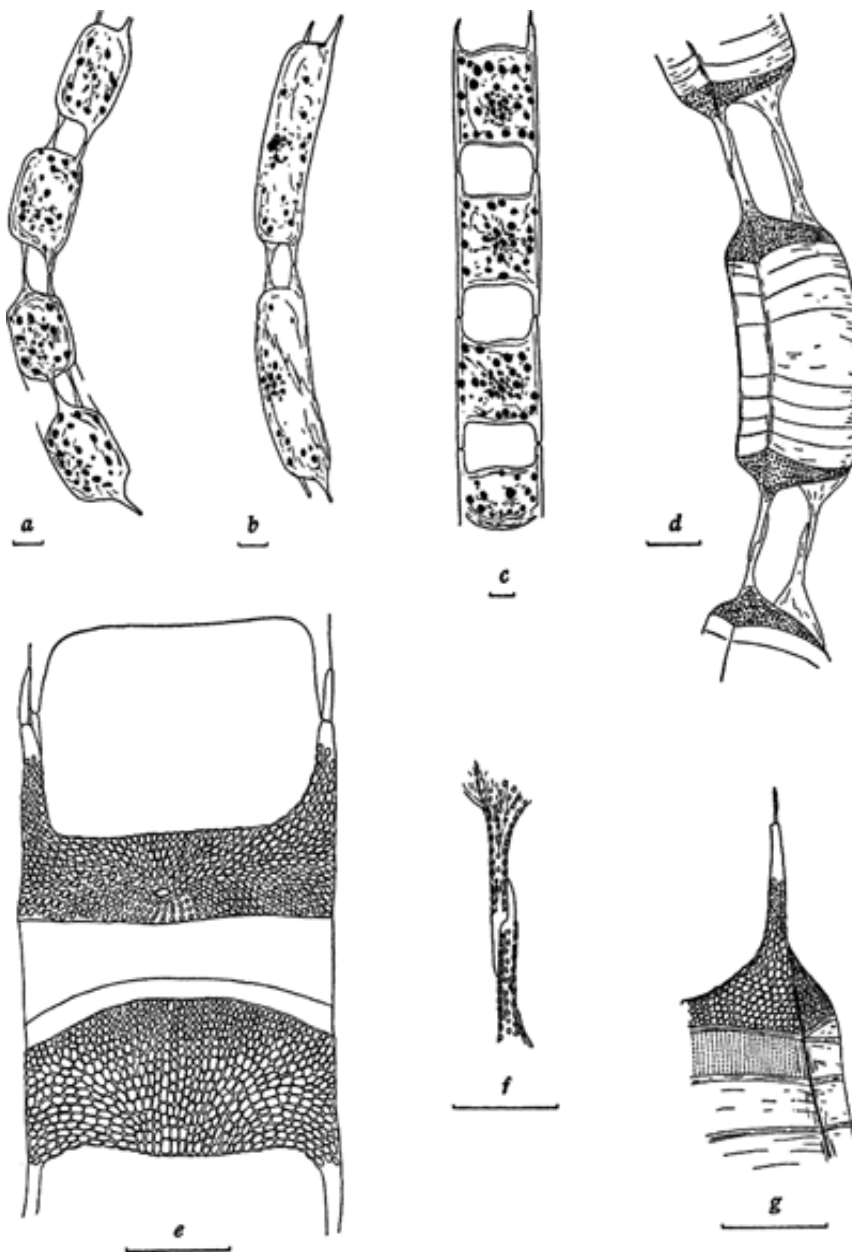

Fig. 119. *Hemiaulus sinensis* Grev. *a* and *b*, chains in narrow girdle view. *c*, chain in broad girdle view; width, 36μ . *d*, part of a chain, narrow girdle view. *e*, cell in broad girdle view showing sculpturing (note excentric arrangement of areolae); width, 30μ . *f*, detail of processes and claws of cell shown in (*d*). *g*, detail of cell shown in (*d*).

Neritic. South temperate or subtropical species. Fairly common off southern California and southward but never abundant.

120. **Hemiaulus membranaceus** Cleve

Figure 120

1873. Bih. Kongl. Svensk. Vet.-Akad. Handl., vol. 1, no. 11, p. 6, pl. 1, fig. 5.

Cells in girdle view from almost square to five or six times wider (length along apical axis) than long (length along perivalvar axis). Valves concave or nearly flat between processes. Processes short, with a more or less sharp point. United in chains by processes. Apertures narrow, linear to elliptical, or even broadly elliptical. Cell wall weakly siliceous. Punctuation on valves very fine, difficult to see. Length of apical axis 30–97 μ .

Rare. Tropical species. Reported in eastern Pacific only from near equator (lat. 3°15' S.). Probably oceanic.

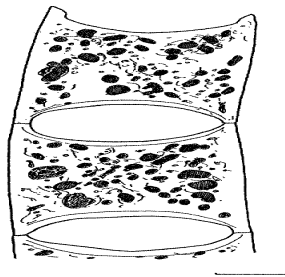

Fig. 120. *Hemiaulus membranaceus* Cl. Part of a chain; width, 32 μ .

7. EUODIEAE Schütt

1896. Bacill. in Engl.-Prantl, Nat. Pflanzenf., p. 99.

Genus XXXI. **HEMIDISCUS** Wallich

1860. Trans. Micr. Soc., N.S., vol. 8, p. 42.

Cells shaped like a sector of a sphere, in girdle view wedge-shaped, narrowing from the dorsal toward the ventral side. Valve semicircular to asymmetrically elliptical. Valves flat with short valve mantles. Intercalary bands and septa absent, perivalvar axis not particularly elongated. Cell wall weakly or strongly siliceous, with regular and thick areolation, radial rows frequently in bundles. Marginal spinulae often present, also sometimes a pseudonodule near middle of ventral valve margin. With or without a central hyaline area. Chromatophores numerous, small.

Species: 121. *H. cuneiformis* var. *ventricosa* (fig. 121)

121. **Hemidiscus cuneiformis** Wallich

1860. Trans. Micr. Soc., N.S., vol. 8, p. 42, pl. 2, figs. 3, 4.

Variety **ventricosa** (Castracane) Hustedt

Figure 121

1886. Castracane. Diat. Chall.-Exped., p. 149, pl. 12, fig. 5 (*Euodia ventricosa*).

1930. Hustedt. Kieselalgen, pt. 1, p. 906, fig. 542d.

Ventral margin regularly and gently convex, not drawn in (concave) near the ends. Dorsal margin strongly convex, in some individuals remarkably high-arched, without constrictions near the valve poles. Apical axis (along straight edge) 97 μ long; transapical axis 83 μ long. Sculpturing coarser or finer, near the center of the valve 9–12 areolae in 10 μ irregularly scattered; midway to margin 14–15 in 10 μ , in radial rows in more or less distinct bundles; near margin finer, 18–19 in 10 μ . Construction of bundles not so regular as in corresponding cases in *Coscinodiscus* species. In *Hemidiscus cuneiformis* the rows are shorter and inserted here and there. In a circle about the valve there is a row of regularly spaced spinulae or pores that project toward the inner part of the cell papillary-like.

The ventral papillae lie on the valve surface near the margin, the dorsal ones are deeper on the valve mantle and are therefore not visible in valve view in the type. In figure 121, *a* they can be seen but are closer to the edge. Two papillae, one on each apical

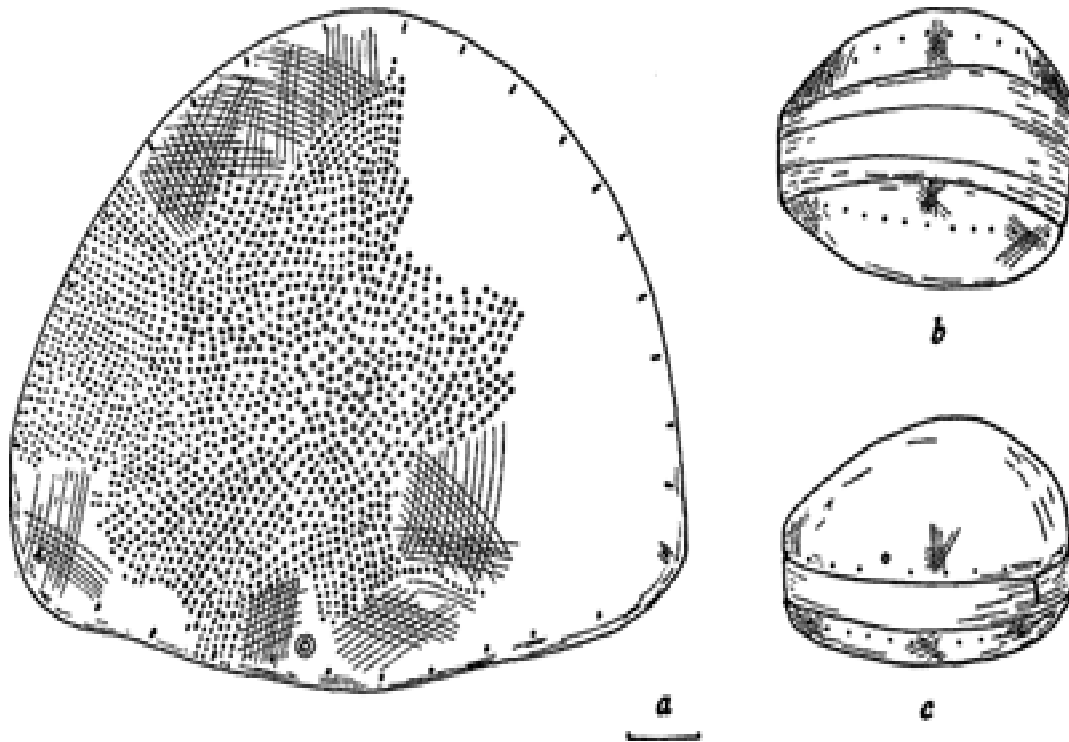

Fig. 121. *Hemidiscus cuneiformis* var. *ventricosa* (Castr.) Hust. *a*, valve view; width across widest region, 97μ . *b*, sketch of girdle view from wider side. *c*, sketch of girdle view from narrower side.

pole, are as a rule somewhat larger than the others. Near the middle of the ventral margin there is one larger eyelike spot.

Oceanic. Subtropical species. Rare. Reported only occasionally off southern California.

B. PENNATAE Schütt

1896. Bacill. in Engl.-Prantl, Nat. Pflanzenf., p. 101.

B-1. ARAPHIDEAE

IV. FRAGILARIOIDEAE Schütt

1896. Bacill. in Engl.-Prantl, Nat. Pflanzenf., p. 101.

8. TABELLARIEAE Schütt

1896. Bacill. in Engl.-Prantl, Nat. Pflanzenf., p. 101.

a) TABELLARIINAE Schütt

1896. Bacill. in Engl.-Prantl, Nat. Pflanzenf., p. 101.

Genus XXXII. STRIATELLA Agardh

1832. Consp. crit. Diat., p. 60.

Cells in girdle view nearly rectangular, tabular. United into closed bands or zigzag chains. Intercalary bands numerous, open on one end, on the other with shorter or longer shallow septa thickened slightly near the margin, the thickenings alternating in adjacent intercalary bands. Valves linear-lanceolate, with a narrow pseudoraphe and delicate transapical rows of punctated striae. Intercalary bands likewise striated in perivalvar direction. Cell wall weakly siliceous. Chromatophores numerous small granules, radiate.

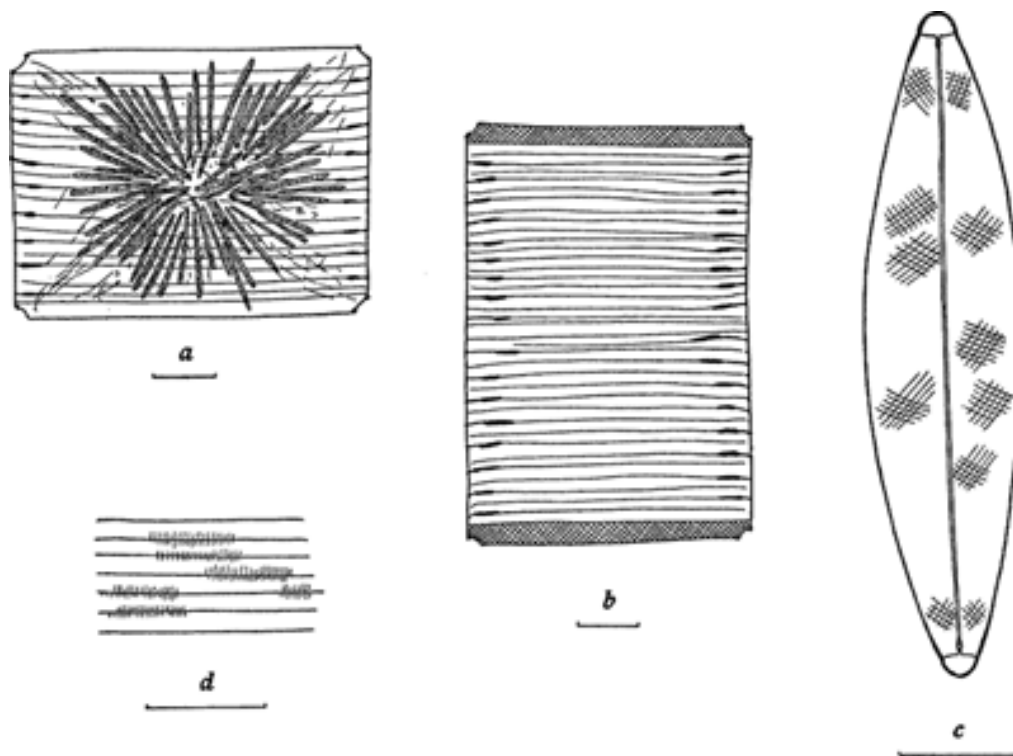

Fig. 122. *Striatella unipunctata* (Lyng.) Ag. *a*, cell with chromatophores, broad girdle view; width (length of apical axis), 62μ . *b*, cell in broad girdle view; width, 50μ . *c*, cell in valve view, sculpturing indicated; length of apical axis, 55μ ; length of transapical axis, 8μ . *d*, section of cell illustrated in (*b*) showing striations on intercalary bands.

All marine species, predominantly littoral, but often found in the plankton.

Species: 122. *S. unipunctata* (fig. 122)

123. *S. delicatula* (fig. 123)

122. *Striatella unipunctata* (Lyngbye) Agardh

Figure 122

1819. Lyngbye. Tent. hydrophyt. dan., pl. 62 (*Fragilaria unipunctata*).

1832. Agardh. Consp. crit. Diat., p. 61.

Cells tabular in girdle view with slightly rounded corners. Intercalary bands numerous, 6–10 in 10μ , with short septa, 3–5 in 10μ . Valves linear to elliptical-lanceolate with moderately blunt-rounded ends. Length of apical axis $50\text{--}78\mu$; of transapical axis $6\text{--}10\mu$. Valve surface delicately areolated-punctated. Puncta in a three self-crossing line system, 18–25 oblique lines in 10μ . Valve ends with small hyaline region. Pseudoraphe very narrow but sharply marked. Mantle surface of the intercalary bands with delicate perivalvar striae, 29–30 in 10μ . Chromatophores granular to oblong, arranged radially about the nucleus, often connected in the middle and then with a central pyrenoid or separate with a pyrenoid in the middle of each plate.

Very common in the littoral zone. Occurs in the plankton accidentally. Temperate species.

123. *Striatella delicatula* (Kützing) Grunow

Figure 123

1844. Kützing. Bacill., p. 125, pl. 18, fig. III, 1 (*Hyalosira delicatula*).

1880–85. Grunow. In V. H. Syn., pl. 54, figs. 5, 6.

Cells in girdle view tabular or nearly rectangular, perivalvar axis often considerably longer than the apical axis. Intercalary bands more or less numerous, 12–14 in 10μ ; short septa 6–7 in 10μ . Valve linear to linear-lanceolate with somewhat blunt-rounded ends. Apical axis $7\text{--}12\mu$ long; transapical axis $1.5\text{--}3.5\mu$. Transapical striae delicate, variable in number, 25–32 in 10μ .

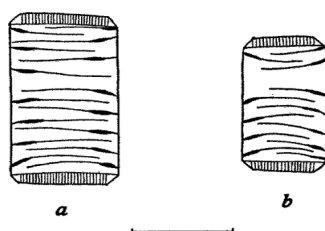

Fig. 123. *Striatella delicatula* (Kütz.) Grun. *a* and *b*, two cells in broad girdle view; widths: *a*, 11μ ; *b*, 8μ .

Common littoral species. Found frequently in the plankton. Widespread but often overlooked because of its delicate appearance.

Genus XXXIII. GRAMMATOPHORA Ehrenberg

1841. Phys. Abh. Akad. Wiss. Berl. 1839, pp. 122, 152.

Cells in girdle view rectangular with rounded corners, usually united into zigzag chains. Resting cells with two intercalary bands, one in each cell half. Intercalary bands with two polar, flat or more or less undulating septa (see fig. F, 1, *se*) that run far toward the cell center and leave only a central window in the intercalary bands (fig. F, 1, *ib*). Valve mantle (fig. F, 1, *vm*) with short pseudosepta near ends. Valve surface as a rule linear with parallel or more or less transapically constricted sides. Membrane with transapical rows of puncta, puncta in more or less regular longitudinal rows or in a self-crossing oblique line system. Valve ends usually with irregularly sculptured polar fields. Pseudoraphe narrow. Mucilage pores present on the poles. Chromatophores one to several, large, more or less lobed plates.

All species are littoral marine.

Species: 124. *G. angulosa* (fig. 124)125. *G. marina* (fig. 125-A)*G. marina* var. *adriatica* (fig. 125-B)126. *G. oceanica* (fig. 126)

124. *Grammatophora angulosa* Ehrenberg

Figure 124

1841. Phys. Abh. Akad. Wiss. Berl. 1839, p. 154.

Cells with irregularly wavy, bent septa, on the inner end hook-shaped, bent toward the center. Line of separation between valve mantle and intercalary band only on the poles with a group of short punctated striae. Valves linear-elliptical with slightly convex

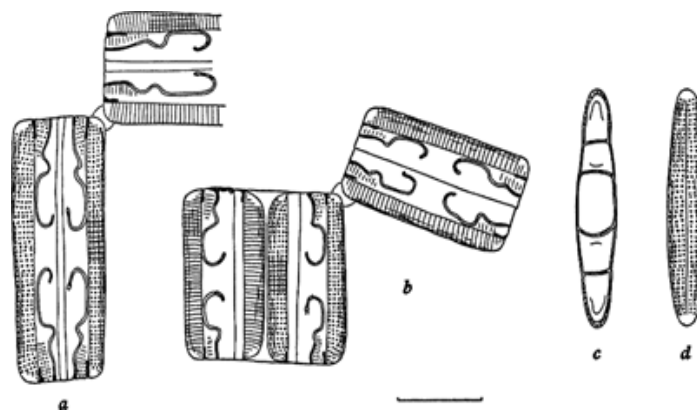

Fig. 124. *Grammatophora angulosa* Ehr. *a*, girdle view; length, 30 μ . *b*, girdle view of chain (note cell division); length, 20 μ . *c*, valve view showing underlying intercalary bands; length, 28 μ ; width, 5 μ . *d*, valve view of same cell as in (*c*) showing sculpturing.

sides and blunt-rounded ends. Length of apical axis 14–35 μ ; of transapical axis 4–6 μ . Transapical striae 18–20 in 10 μ , distinctly punctated, puncta in regular longitudinal rows parallel to the middle line. Pseudoraphe narrow. Valve ends with small hyaline polar field.

Littoral. Found occasionally in plankton collections. Temperate species.

125. *Grammatophora marina* (Lyngbye) Kützing

Figure 125-A

1819. Lyngbye. Tent. hydrophyt. dan., pl. 62 A (*Diatoma marinum*).

1844. Kützing. Bacill., p. 128, pl. 17, fig. 24; pl. 18, fig. I, 1–5.

Cells with septa having only a single and slight undulation close to the base or nearly flat. With short rows of striae only at the poles on the dividing line between valve mantles and intercalary bands. Pseudosepta of the valve mantles short. Valves relatively broad, linear, in the middle usually more or less transapically widened, on the ends broadly rounded. Length of apical axis 30–82 μ ; of transapical axis 5–10 μ . Transapical striae delicate but distinct, 20–22 in 10 μ , distinctly punctated-areolated, puncta in quincunx. Pseudoraphe very narrow. Hyaline polar field usually small.

Littoral, but often present in plankton collections taken near shore. Widespread.

Variety *adriatica* Grunow

Figure 125-B

1881. Beil. Bot. Centralbl., vol. 7, p. 7.

Valve broad linear with parallel sides and broadly rounded ends, occasionally slightly widened in the middle transapically. Transapical striae 25–28 in 10 μ .

Littoral. South temperate or subtropical species.

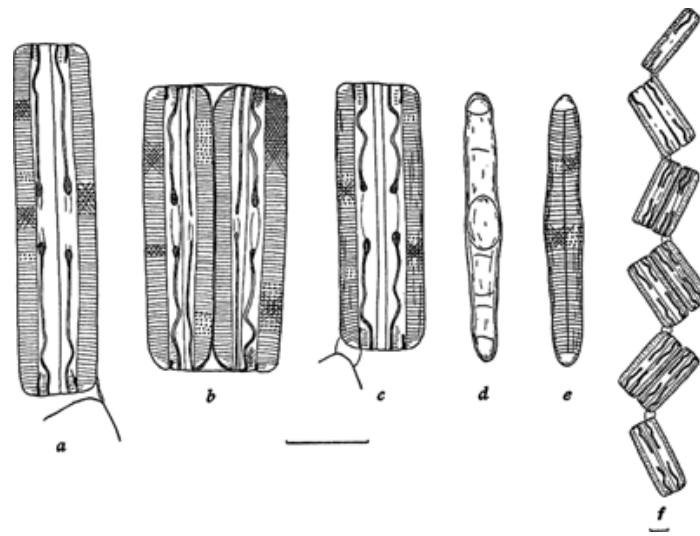

Fig. 125-A. *Grammatophora marina* (Lyng.) Kütz. *a*, cell in broad girdle view; length, 43μ . *b*, cell division; length, 35μ . *c*, cell 33μ long, broad girdle view. *d*, valve view of cell illustrated in (*c*) showing underlying intercalary bands; width, 4.5μ . *e*, valve view showing sculpturing. *f*, chain, cells 38μ long.

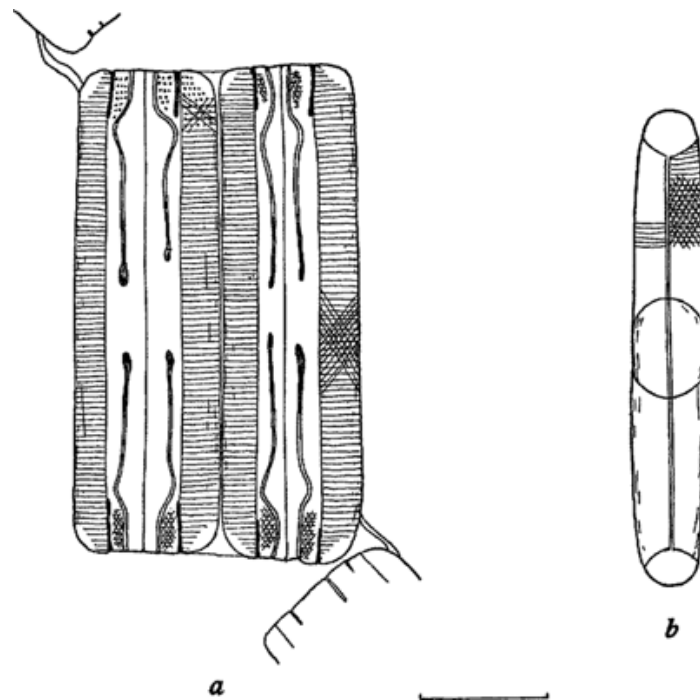

Fig. 125-B. *Grammatophora marina* var. *adriatica* Grun. *a*, recently divided cells in broad girdle view; length, 38μ . *b*, valve view; width, 6μ .

126. *Grammatophora oceanica* (Ehrenberg, 1854, in part) Grunow

Figure 126

1881. Grunow. Beil. Bot. Centralbl., vol. 7, p. 9.

Cell in girdle view similar to *G. marina* but slightly wider in the center than at the ends. Valve narrow linear to linear-lanceolate with blunt-rounded ends. Length of

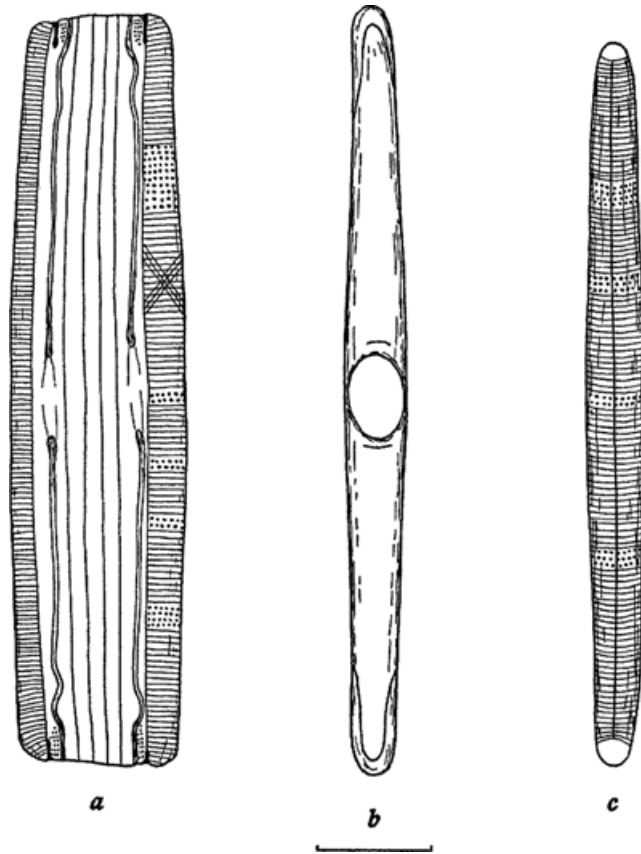

Fig. 126. *Grammatophora oceanica* (Ehr.) Grun. *a*, broad girdle view; length, 65μ . *b*, valve view showing underlying intercalary bands. *c*, valve view showing sculpturing on surface; width, 5μ .

apical axis $40-75\mu$; of transapical axis $4-6\mu$. Transapical striae delicate, 21-23 in 10μ , finely punctated, puncta in quincunx. Pseudoraphe very narrow. Polar field small. (See fig. F, 1.)

Littoral. Present occasionally in plankton collections taken near shore. Widespread.

b) LICMOPHORINAE Hustedt

1931. Kieselalgen, pt. 2, sec. 1, p. 52.

Genus XXXIV. LICMOPHORA Agardh

1827. Bot. Zeit. 1827, p. 628.

Cells with wedge-shaped girdle-band side and wedge- or club-shaped valve. Two intercalary bands in resting cells, with a more or less long penetrating septum on the head pole. Valves with transapical punctated striae, seldom with weak transapical ribs and extremely delicately punctated intercalary space. Pseudoraphe usually distinct, often

developed as a strong siliceous rib. Chromatophores numerous small granules or a few larger plates. Auxospore formation, so far as known, consists of one asexual auxospore in one mother cell.

Littoral marine species, held to the substrate by a shorter or longer, often branched gelatinous stalk.

Species: 127. *L. abbreviata* (fig. 127)

127. **Licmophora abbreviata** Agardh

Figure 127

1831. Consp. crit. Diat., p. 42.

Cells in girdle view usually strongly wedge-shaped with moderately rounded upper corners, deeply penetrating septa, and more or less strongly waved intercalary bands. Valves narrow club-shaped, with wide, usually somewhat wedge-shaped rounded head and more

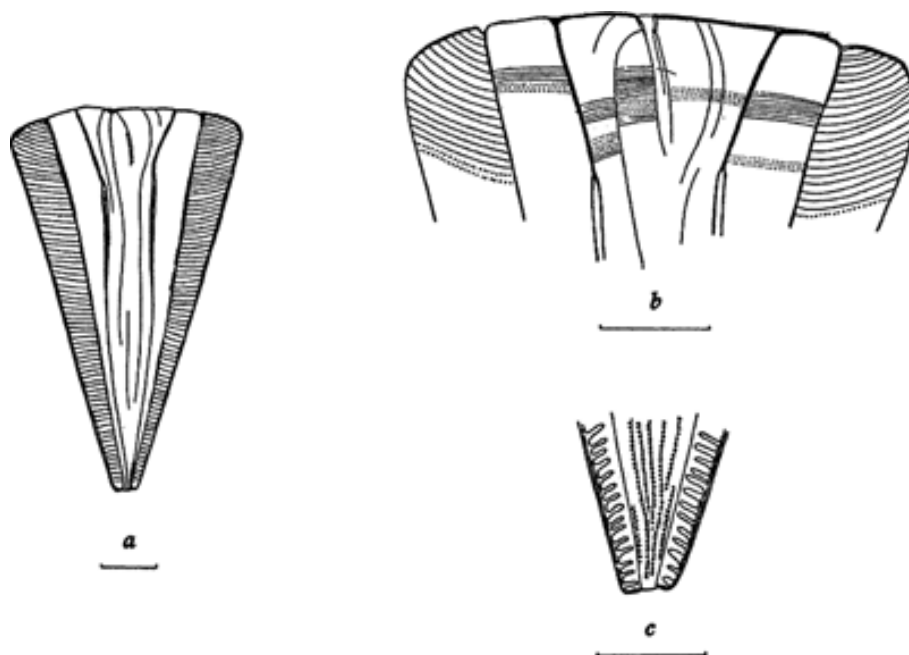

Fig. 127. *Licmophora abbreviata* Ag. *a*, cell in girdle view; length, 72μ . *b*, upper pole of cell shown in (*a*). *c*, lower pole of cell shown in (*a*).

acute rounded foot pole. In the lower part slightly concave. Apical axis $40-80\mu$ long; transapical axis $4-8\mu$. Transapical striae fairly strong, on the base $10-12$ in 10μ , in the upper part of the valve becoming weaker, near the upper (head) pole $13-16$ in 10μ . Pseudoraphe narrow but distinct.

Littoral, but often found in plankton collections. Widespread.

Genus XXXV. **CLIMACOSPHENIA** Ehrenberg

1843. Phys. Abh. Akad. Wiss. Berl. 1841, p. 401.

Cells of similar construction to those of the genus *Licmophora*. In girdle and valve view wedge-shaped, with two intercalary bands that have, instead of the end septa, numerous transapical septa the halves of which grow from the cell wall toward the inside and in the middle line come together in a more or less toothed seam. Internal septa are pierced by a row of large oval openings which in valve view give a stepladder appearance to the club-shaped valve (see fig. F, 2, *se*). Valve surface with usually delicate

transapical punctated striae that run directly together so that no distinct pseudoraphe is formed. On both sides of the middle line a hyaline longitudinal line (furrow or siliceous rib) is present. Mantle surface of the valve and the girdle bands pervalvarly punctated-striated. The structure of the girdle band is considerably coarser than that of the valve. Chromatophores numerous small granules.

Species: 128. *Climacosphenia moniligera* (fig. 128)

128. ***Climacosphenia moniligera*** Ehrenberg

Figure 128

1843. Phys. Abh. Akad. Wiss. Berl. 1841, p. 411, pl. 2, fig. VI, 1.

Cells in girdle view wedge-shaped with straight sides. Intercalary bands with usually numerous septa, usually smaller in the upper part of the cell, in the lower part gradually

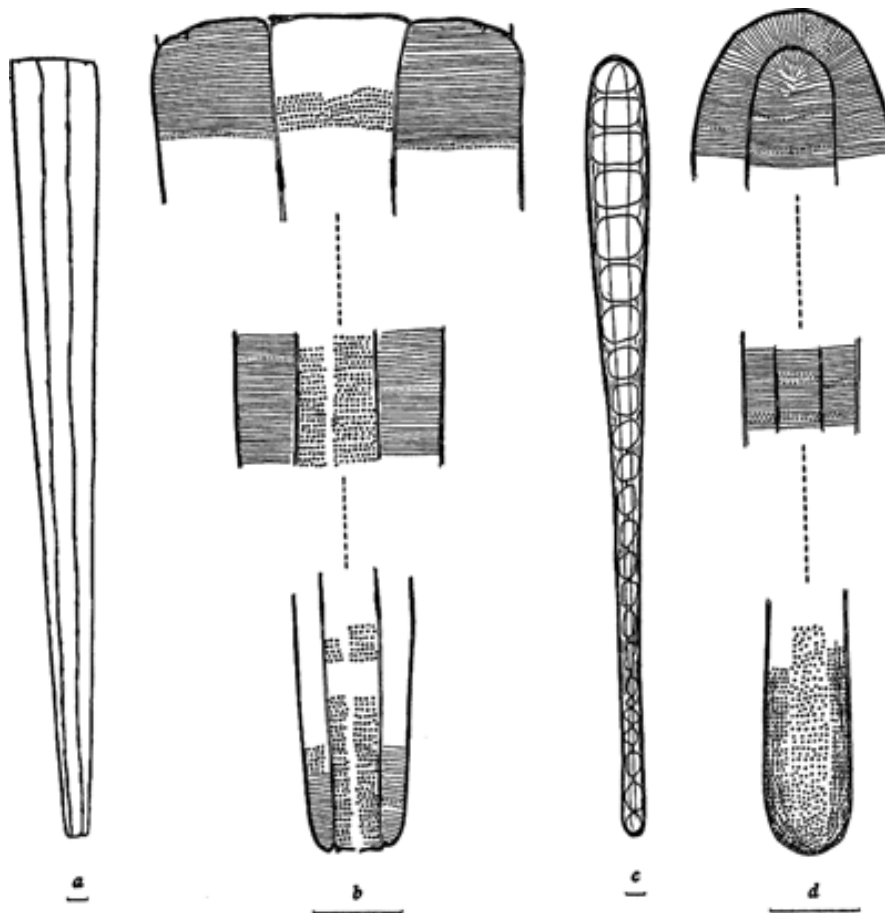

Fig. 128. *Climacosphenia moniligera* Ehr. *a*, girdle view; length, 373 μ . *b*, sections of cell in girdle view. *c*, valve view with underlying intercalary bands. *d*, sections of cell in valve view showing sculpturing on surface.

widening, often very irregular. Openings ("windows") in upper part roundish-four-cornered, toward the lower part gradually becoming elliptical, often irregular. Valves club-shaped, on the poles blunt, rounded, toward the lower (foot) pole gradually becoming smaller, the upper and lower parts not distinctly differentiated. Length of

apical axis 300–400 μ . At the widest part of the valve 25–35 μ across; at the narrowest part, above the lower pole, 9–10 μ wide. Transapical striae 17–21 in 10 μ in the marginal part above the lower pole; 12–17 in the middle part; toward the upper (head) pole gradually becoming closer, 21–24 in 10 μ . Striae very delicately punctated. In the middle part above the lower pole puncta are larger, almost irregularly placed, no longer in rows. Pseudoraphe absent. Hyaline longitudinal lines distinct.

Littoral. Abundant in warmer waters in enclosed regions, as in Mission Bay near San Diego.

9. FRAGILARIEAE Schütt

1896. Bacill. in Engl.-Prantl, Nat. Pflanzenf., p. 110.

a) DIATOMINAE Schütt

1896. Bacill. in Engl.-Prantl, Nat. Pflanzenf., p. 110.

Genus XXXVI. **PLAGIOGRAMMA** Greville

1859. Quart. Jour. Micr. Sci., vol. 7, p. 207.

Cells in girdle view rectangular-tabular, without intercalary bands and septa. Valves usually linear-lanceolate, sometimes with wavy margins, with transapical ribs that penetrate more or less deeply into the inner part of the cell as pseudosepta, often only very shallow. Usually two pairs of ribs present, of which one lies near the center, the other near the end of the valve; seldom several pairs of ribs present; very seldom only one rib in the center. Cell wall with more or less delicate transapical and longitudinal ribs by means of which the membrane is areolated-chambered. Sometimes the transapical ribs are wider than the more delicate longitudinal ribs so that the areolae become isolated transapical rows of puncta. Puncta and areolae usually in regular longitudinal rows. Polar field apparently hyaline, although in many individuals, perhaps in all, with a very delicate sculpturing. Chromatophores, so far as known, numerous small granules.

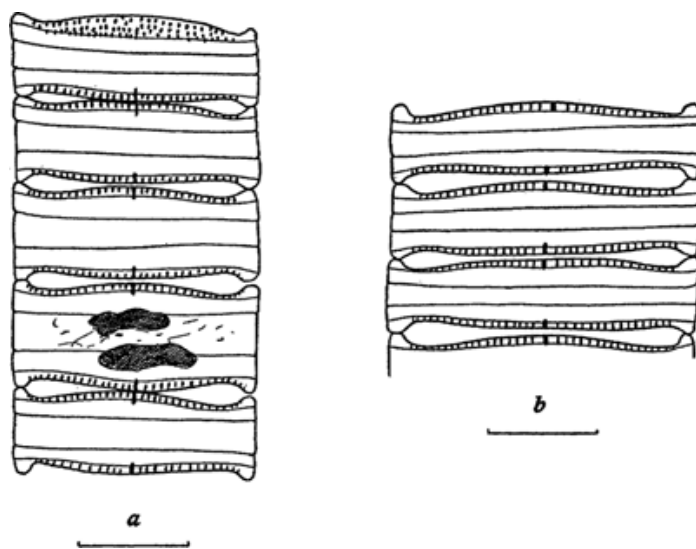

Fig. 129. *Plagiogramma vanheurckii* Grun. *a* and *b*, parts of two chains, girdle view; widths: *a*, 22 μ ; *b*, 28 μ .

Marine forms that live in close chains. Most species live on the coast in warmer waters.

Species: 129. *P. vanheurckii* (fig. 129)

129. *Plagiogramma vanheurckii* Grunow

Figure 129

1880–85. In V. H. Syn., pl. 36, fig. 4.

Cells in girdle view with rectangular outline but below the poles strongly constricted and hence with lanceolate middle part and knoblike corners. Valves lanceolate, gradually decreasing from the middle toward the small, constricted ends; on the poles slightly rounded. Length of apical axis 20–35 μ ; of transapical axis 4–5 μ . Valve center with one single, deeply penetrating pseudoseptum. Membrane delicately areolated, transapical and longitudinal rows 12–15 in 10 μ . A more or less dilated middle field on either side of the middle septum and the small polar fields are hyaline. Chromatophores two plates constricted in the middle and lying along the girdle.

Littoral. Found occasionally in plankton collections taken near shore off southern California. Widespread. Often overlooked because of its delicate appearance.

b) FRAGILARIINAE Schütt

1896. Bacill. in Engl.-Prantl, Nat. Pflanzenf., p. 112.

Genus XXXVII. *CAMPYLOSIRA* Grunow

1880–85. In V. H. Syn., description of pl. 45.

Cells forming bands, connected by means of delicate plates with numerous ribs (crown of spines). Cell body curved, one valve convex, the other concave. Valve surface areolated-punctated, transapical rows not marked. Pseudoraphe or central field absent.

Species: 130. *C. cymbelliformis* (fig. 130)130. *Campylosira cymbelliformis*

(A. Schmidt) Grunow

Figure 130

1874. A. Schmidt. II Jahresber. Komm. Untersuch. deutsch. Meere, Kiel, p. 93 (*Synedra cymbelliformis*).

1880–85. Grunow. In V. H. Syn., pl. 45, fig. 43.

Cells in outline curved-rectangular with knoblike corners, below the ends more or less constricted, with a strongly developed crown of spines. Valves lanceolate crescent-shaped with strongly convex dorsal side and weakly convex to straight or slightly concave ventral side, on the ends more or less drawn out and with a moderately rounded point. Length 25–45 μ ; width 4–5 μ . Membrane areolated-punctated, areolae in indistinct transapical and more or less regular longitudinal rows. Areolae 13–16 in 10 μ . Hyaline areas absent.

Found occasionally in plankton collections taken near the coast off southern California. Littoral. Temperate species.

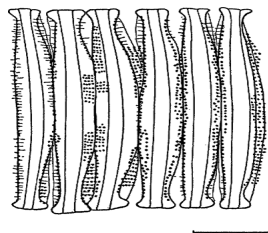

Fig. 130. *Campylosira cymbelliformis* (A. Schm.) Grun. Part of a chain, girdle view; width, 40 μ .

Genus XXXVIII. *FRAGILARIA* Lyngbye

1819. Tent. hydrophyt. dan., p. 182.

Cells united into more or less long bands by the whole valve sides, occasionally with regular apertures between the cells. Connection of the cells with one another often assisted by tiny spines on the valve margin. In girdle view cells are rectangular and

rodlike or with widened center part. Valve in outline linear, lanceolate to elliptical, often enlarged or constricted in the middle. Intercalary bands present in some marine species, septa absent. Cell wall with transapical, delicately punctated striae; bilaterally symmetrical. Pseudoraphe absent, or narrow to very wide. Raphe absent. Without special transapical ribs. With a larger or smaller clear field in the middle. Chromatophores single plates to numerous small granules. Resting spores known from a few marine species.

Mainly littoral species. Common off southern California.

Species: 131. *F. crotonensis* (fig. 131)

131. **Fragilaria crotonensis** Kitton

Figure 131

1869. *Sci. Gossip*, vol. 5, p. 110, fig. 81.

Cells in girdle view widened in the middle and sometimes also at the ends. Held together in bands by the center part or by the ends. Between the middle and the ends, with a lanceolate aperture; bands consequently loose, comblike. Valves very small, lanceolate, in the center somewhat widened, the ends slightly enlarged and rounded. Length 50–75 μ ; width 1.5–3 μ . Transapical striae delicate, 12–16 in 10 μ , in the middle interrupted so that a small rectangular central area is present. Pseudoraphe very narrow linear.

Found near shore in brackish water. Not common off southern California. Only occasionally in plankton collections. Neritic. North temperate to boreal species.

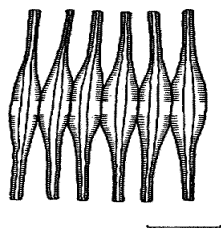

Fig. 131. *Fragilaria crotonensis* Kit. Six cells united in a band; length of cells, 62 μ .

Genus XXXIX. **SYNEDRA** Ehrenberg

1830. *Ber. Akad. Wiss. Berl.* 1830, p. 40.

Cells single or united into fanlike to clustered starlike colonies, seldom in short bands. In general with greatly elongated apical axis, rodlike, sometimes bent in the direction of the apical axis, very variable. Intercalary bands and septa absent, girdle band consequently narrow linear as a rule. Valve linear to very narrow lanceolate, sometimes with wavy edges, often widened in the middle or at the ends. Valve surface usually with transapical rows of delicate puncta and narrower pseudoraphe or wider lanceolate, hyaline central area sometimes with scattered puncta. In some species the cell wall is chambered on the inner side, the chambers entirely free toward the cell center or in some individuals closed by a finely poroid, delicate membrane. The chambered forms have also more or less numerous, lateral-longitudinal ribs that are sometimes very close to the valve margin and very difficult to see. One valve end usually has a mucilage pore. Chromatophores numerous small granules or two larger plates.

Species: 132. *S. undulata* (fig. 132)

132. **Synedra undulata** Bailey

Figure 132 (p. 182)

1854. *Smithson. Contrib. Knowl.*, vol. 7, p. 15. (*Toxarium undulatum* Bailey, l.c., figs. 24, 25.)

Valves very long and narrow, with undulating margins, in the middle and on the broadly rounded ends somewhat bulging. Length 450–650 μ ; width in the middle 8–13 μ , on the ends 5–6 μ , in the narrow parts 2–4 μ . Transapical striae short, distinctly punctated, 10–13 in 10 μ . Pseudoraphe indistinct, in narrow regions of the valve present as a hyaline line interrupted by the transapical rows, near the ends and in the ends and in the middle wide but dotted with irregular puncta. Central area absent.

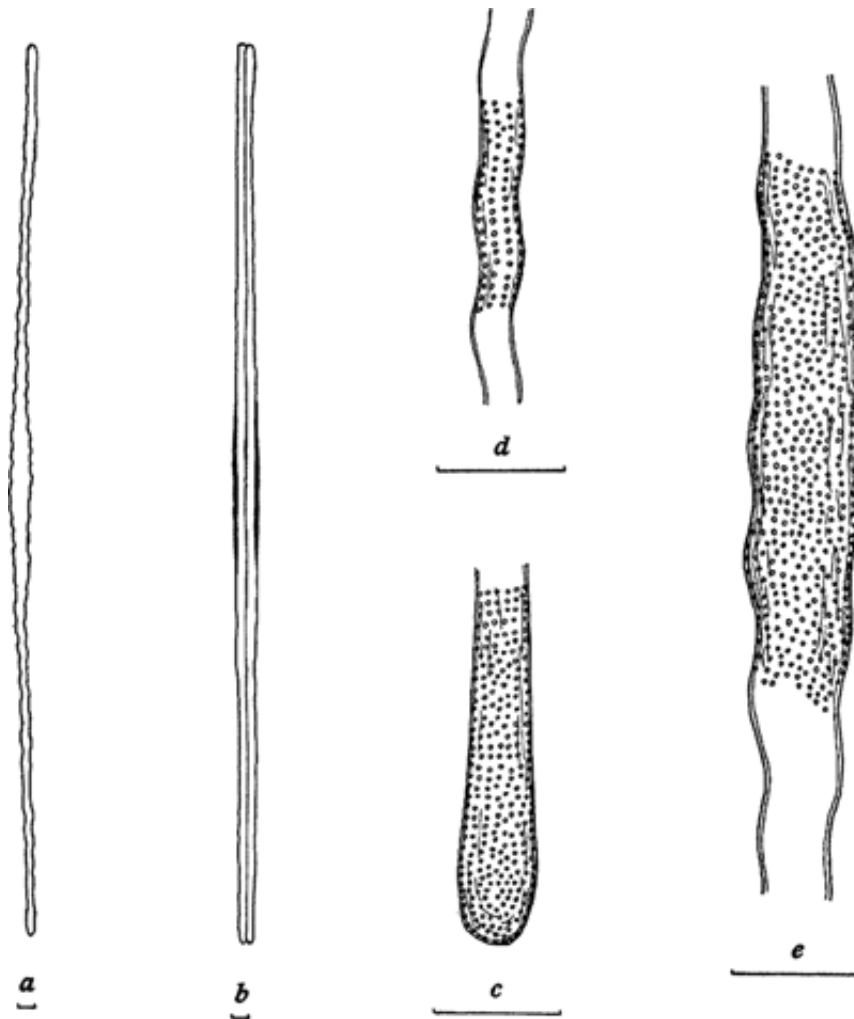

Fig. 132. *Synedra undulata* Bail. *a*, valve view of entire cell; length, 610μ ; widths: center, 13μ ; narrowest part, 3μ . *b*, same cell in girdle view. *c-e*, parts of cell in valve view showing sculpturing. *c*, end. *d*, narrowest part midway between end and center. *e*, widest center part.

Littoral species. Most common in enclosed regions such as Mission Bay near San Diego. South temperate to subtropical species.

Genus XL. **THALASSIONEMA** Grunow

1880–85. In V. H. Syn., description of pl. 43, figs. 7–10.

Cells forming zigzag bands or star-shaped colonies, adjacent cells united to each other by small gelatinous cushions on one cell end. In girdle view linear. Intercalary bands and septa absent. Valves linear to narrow lancet-shaped. Valves with numerous tiny spines on the margin placed at regular intervals. Cell wall otherwise structureless. Chromatophores more or less numerous small granules.

Only one species. Pelagic, marine.

Species: 133. *T. nitzschioides* (fig. 133)

133. **Thalassionema nitzschioides** Grunow

Figure 133

1880–85. In V. H. Syn., pl. 43, figs. 7–10.

Cells in girdle view narrow linear, often slightly curved. Valves narrow linear with parallel sides and blunt-rounded ends. Length $30-80\mu$; width $2-3.5\mu$. Marginal spines

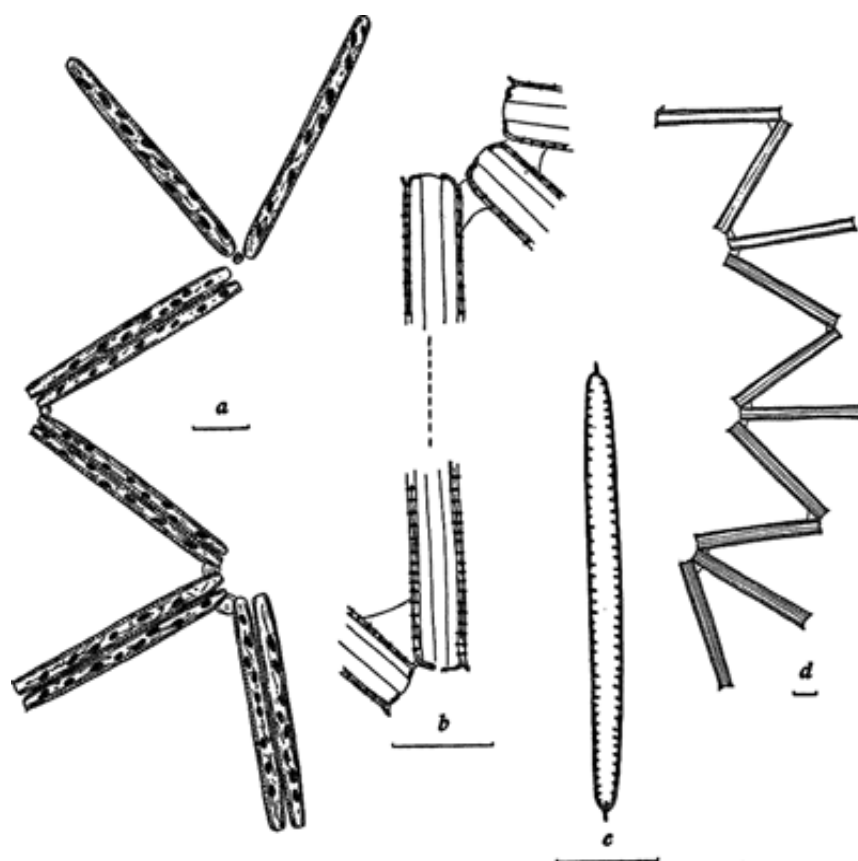

Fig. 133. *Thalassionema nitzschioides* Grun. *a*, chain with four recently divided cells in girdle view and two cells in valve view; length of cells, 42μ . *b*, sections of cells in girdle view, from chain shown in (*d*). *c*, valve view; length, 42μ ; width, 3.5μ . *d*, chain, all cells in girdle view; length of cells, 53μ .

small, 10–12 in 10μ . Valves otherwise without sculpturing. Cells united into star-shaped colonies or zigzag bands, frequently both types within a colony.

Neritic. North temperate species. Very common and often abundant off southern California and Lower California, in the Gulf of California, and north to Scotch Cap, Alaska.

Genus XLI. **THALASSIOTHRIX** Cleve and Grunow

1880. Kongl. Svensk. Vet.-Akad. Handl., vol. 17, no. 2, p. 108.

Cells living singly or forming star-shaped colonies, zigzag bands, or bunches, united to one another by a gelatinous cushion on the end of the cell. In girdle view narrow linear. Intercalary bands and septa absent. In valve view linear or slightly lancet-shaped, ends unlike. Valve borders similar to those of preceding genus, often beset with small spines. Valve surface with short marginal striae or structureless. Chromatophores more or less numerous small granules.

Pelagic marine forms. This genus contains the longest diatoms known at the present time. Often present in large masses in the plankton.

- Species: 134. *T. longissima* (fig. 134)
 135. *T. frauenfeldii* (fig. 135)
 136. *T. mediterranea* var. *pacifica* (fig. 136)
 137. *T. delicatula* (fig. 137)

134. *Thalassiothrix longissima* Cleve and Grunow

Figure 134

1880. Kongl. Svensk. Vet.-Akad. Handl., vol. 17, no. 2, p. 108.

Cells four-sided, very long and more or less curved, threadlike, usually living singly. Valves very narrow linear, ends slightly narrowed, more so on one end than on the other. Length 1–4 mm., width 3–6 μ . Corners of the valves beset with delicate spines,

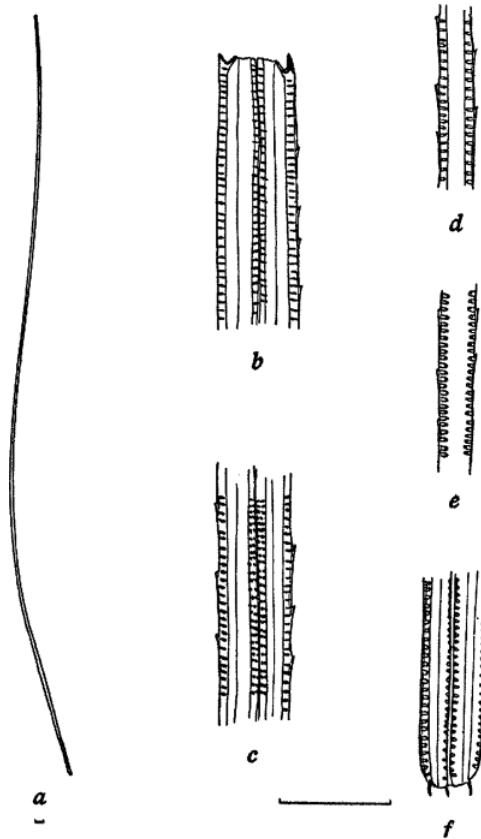

Fig. 134. *Thalassiothrix longissima* Cl. and Grun. *a*, entire cell; length, 1450 μ ; width at narrowest part, 3 μ . *b–f*, sections of cell. *b*, end of cell, girdle view. *c*, section midway between end and center, girdle view. *d*, section near center, valve view. *e*, section midway between center and end, valve view. *f*, end, girdle view.

about 3 in 10 μ in the middle part of the cell, fewer toward the ends or entirely absent. Sometimes the entire cell is without marginal spines. Membrane with short marginal ribs, 14–16 in 10 μ . Mucilage pore near the ends.

Oceanic. Arctic-boreal to north temperate species. Not uncommon off California but never in large numbers. Present in Gulf of California and north to Scotch Cap, Alaska.

135. *Thalassiothrix frauenfeldii* Grunow

Figure 135

1880. In Cleve and Grunow. Kongl. Svensk. Vet.-Akad. Handl., vol. 17, no.2, p. 109.

Cells united into star-shaped colonies or zigzag bands. In girdle view linear. Valves very narrow linear, ends distinct but only slightly unlike, one end blunt-rounded, near

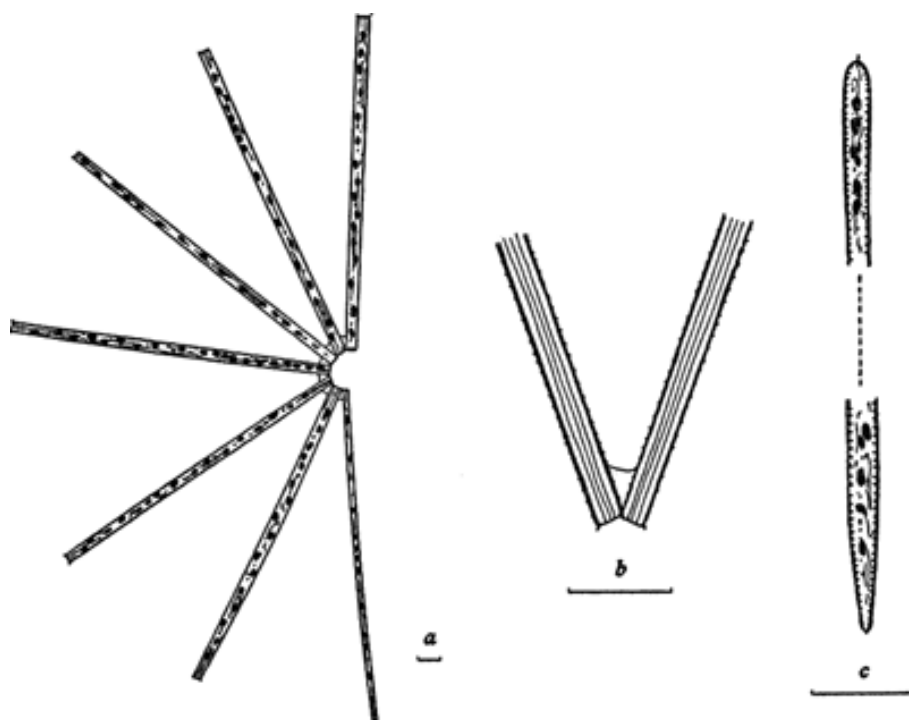

Fig. 135. *Thalassiothrix frauenfeldii* Grun. *a*, colony of seven cells; length of cells, 132μ . *b*, ends of cells joined together, girdle view. *c*, two ends of a cell in valve view.

the other end usually widened then decreased to form a wedge-shaped point. Valves $90\text{--}210\mu$ long, $2\text{--}4\mu$ wide. Marginal spines small but regular, 6–9 in 10μ . Valves otherwise structureless.

Oceanic. South temperate species. Widespread. Common, sometimes present in large numbers up to nearly 200,000 cells per liter off southern California in August, 1926. Common in Gulf of California and north to Scotch Cap, Alaska.

136. *Thalassiothrix mediterranea* Pavillard

1916. Rech. Diat. pélag. Golfe du Lion, p. 39, pl. 2, fig. 3.

Variety *pacifica* n. var.

Figure 136 (p. 186)

Cells delicate, very slender. United into star- or fan-shaped colonies by the valve surfaces of the wedge-shaped point. Valves very narrow linear, $525\text{--}1076\mu$ long (most commonly $625\text{--}850\mu$). Basal pole slightly wedge- or quill-shaped, blunt-pointed, $3\text{--}5\mu$ at widest point. About one-third the length of the cell from the basal pole, valve slightly enlarged, then narrower again, $1.5\text{--}2.5\mu$, to near head end which is rounded and $2.5\text{--}4\mu$ across at the widest point. In girdle view basal end more sharply wedge-shaped, $5\text{--}7\mu$ at widest point, then $3\text{--}4\mu$ wide for a short distance to about one-third the length of the cell where the slight thickening ($5.5\text{--}6\mu$) occurs, then again narrower ($1.8\text{--}3\mu$), until near head end which is wider ($3\text{--}5\mu$) and cut off abruptly. Cell sometimes partly twisted at narrow region near head end. Marginal spines lacking, but spinelike projections at corners of head end. Valve surface and valve mantle delicately striated. Striae punctate

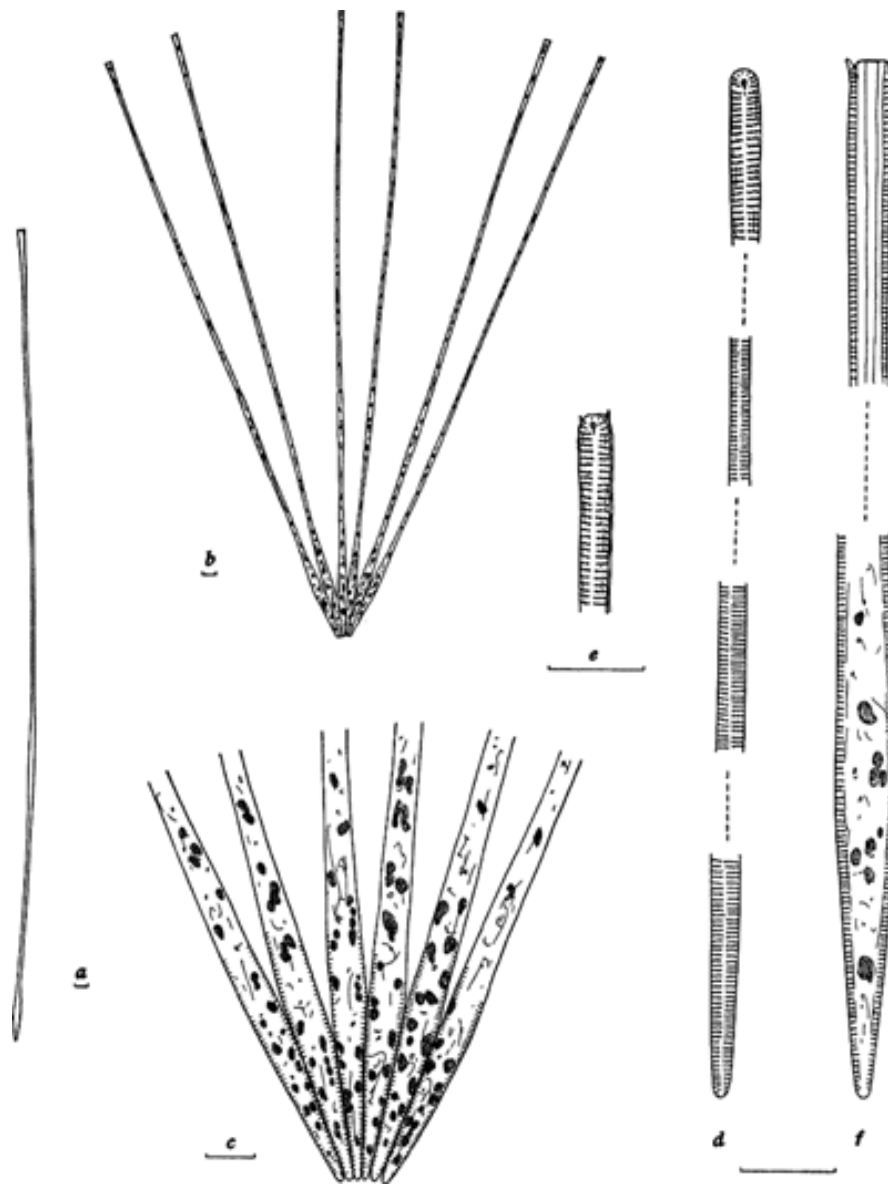

Fig. 136. *Thalassiothrix mediterranea* var. *pacifica* Cupp. *a*, entire cell; length, 745μ . *b*, colony of six cells; length of cells, 580μ . *c*, basal ends of cells shown in (*b*). *d*, sections of a cell in valve view. *e*, head end of cell shown in (*d*), focus slightly higher to show spines at corners (note mucilage pore). *f*, head and basal poles of a cell in girdle view.

(see fig. E, 1, *p*). Transapical striae 16–19 in 10μ . Pseudoraphe very narrow linear (fig. E, 1, *ps*). Chromatophores small, numerous, roundish to oval. Mucilage pore at head end.

Differs from the type mainly by the coarser striation, 16–19 in 10μ in the variety, 21–24 in 10μ in the type.

Temperate to south temperate species. Present off southern California, sometimes in moderately large numbers, and in the Gulf of California.

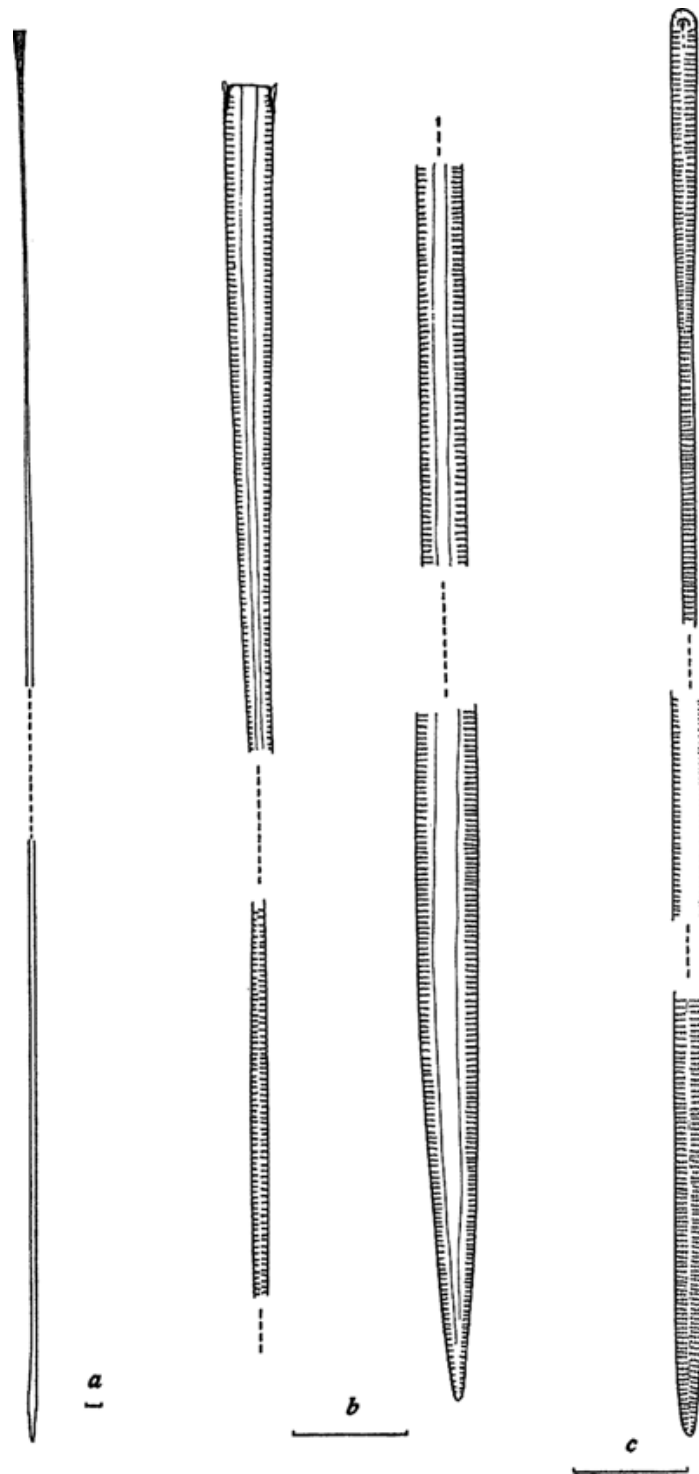

Fig. 137. *Thalassiothrix delicatula* Cupp. *a*, entire cell (except section of the center); length, 1590μ (cell ends in girdle view; narrow portion, valve view). *b*, sections of cell shown in (*a*). *c*, sections of same cell turned so that ends are in valve view (center section, girdle view).

137. *Thalassiothrix delicatula* n. sp.

Figure 137

Cells very long, 1120–1920 μ . Usually solitary or united for a time after division. One end (basal pole) of valve blunt-pointed, 1.5–2.5 μ at widest point, nearly same width until about one-third the length of the cell from the head end, then becomes slightly narrower, 1–2 μ , gradually becoming wider again, up to 4 μ at the widest point of the rounded head end. In girdle view more sharply pointed at basal end (about 3.5–6 μ wide at widest point), then nearly same width for about two-thirds the length of the cell, gradually becoming narrower, 3–4 μ wide, and again widening near the head end to 4–5 μ and is then cut off abruptly. Delicate, scarcely visible spines at corners of head end. The cell is normally twisted about 180° so that if the basal pole is seen in girdle view the head pole will also be in girdle view, but a section of the cell occupying about one-fourth the length in the vicinity of the head pole will be in valve view. In some individuals twisting is not entirely through 180°. Valve and valve mantle delicately striated. Striae punctate. Transapical striae 19–24 in 10 μ (most commonly 21–23 in 10 μ). Pseudoraphe narrow linear. Mucilage pore present near the head end of the valve. Chromatophores numerous, small, oval.

A south temperate to subtropical species. Found abundantly at times in the Gulf of California. A catch of 143,724 diatom cells per liter taken in mid-Gulf (lat. 27°38' N., long. 111°42' W.) on March 12, 1936 (Allen, 1937), contained this one species almost exclusively (listed as *T. heteromorpha*). The greater number of the specimens recorded as *T. mediterranea* in Cupp and Allen (1938) belong to this new species.

Thalassiothrix delicatula is closely related to *T. mediterranea*, but is longer, more twisted, and without the marked inflation one-third the length of the cell from the basal pole. It is also nearly related to *T. heteromorpha* (Karsten, 1907), but the twisting of the cell at the narrow region is greater, the number of striae in 10 μ is greater, and the cell is characteristically longer. *Thalassiothrix delicatula* is not bent into an S-shaped curve characteristic of *T. antarctica* (Karsten, 1906). The striae are more numerous than in *T. acuta* (Karsten, 1905), and the cell is more twisted. In *T. acuta* both valve ends are pointed.

Genus XLII. **ASTERIONELLA** Hassall

1855. Micr. exam. of water, p. 10.

Cells united by one end (the larger end) into star-shaped colonies or spirally curved, sometimes straight, comb-shaped bands. Intercalary bands and septa absent. In girdle view linear, usually widened at the ends, sometimes perivalvarly constricted. Valves linear with enlarged region near one or both ends. Membrane with delicate transapical striae and narrow median pseudoraphe. Chromatophores a single small plate or more or less numerous small granules.

Pelagic forms.

Species: 138. *A. japonica* (fig. 138)139. *A. kariana* (fig. 139)138. **Asterionella japonica** Cleve

Figure 138

1878. In Cleve and Möller, Diat., no. 307.

Cells united into starlike spiral colonies. In girdle view very narrow linear with parallel sides, with greatly enlarged three-cornered region at base. Cells united at corners of enlarged region. Valves very narrow, then with a widened knoblike region at the

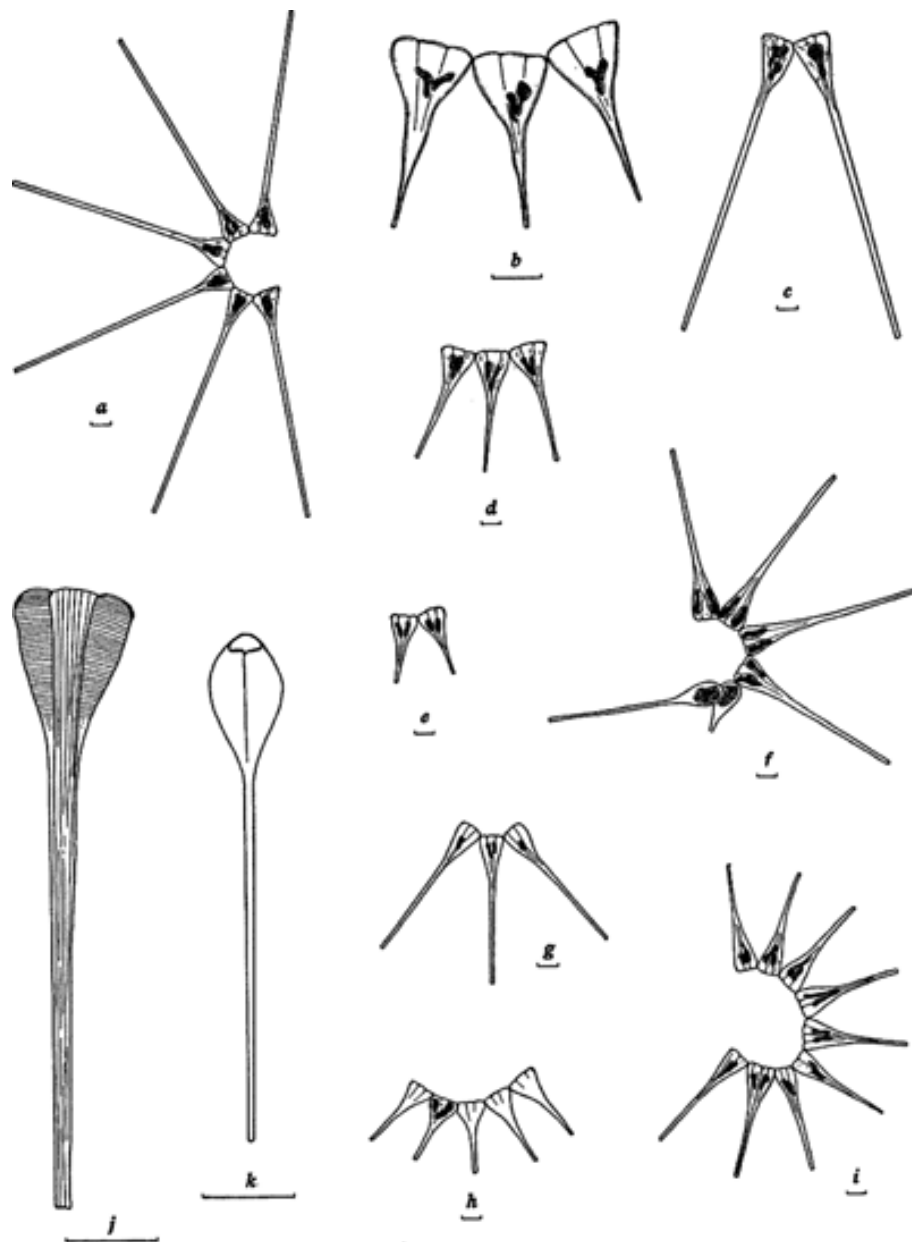

Fig. 138. *Asterionella japonica* Cl. *a-i*, colonies; lengths of entire cells: *a*, 110 μ ; *b*, 42 μ ; *c*, 150 μ ; *d*, 58 μ ; *e*, 30 μ ; *f*, 87 μ ; *g*, 70 μ ; *h*, 40 μ ; *i*, 55 μ . *j*, cell in girdle view; length, 67 μ (note striations). *k*, cell in valve view; length, 55 μ ; width at widest part of head, 8 μ .

base. Length of valve 30–150 μ ; length of enlarged region 10–23 μ ; width of enlarged part 8–12 μ . Transapical striae very delicate, 28–34 in 10 μ . Chromatophores one or two small plates, in basal enlarged part only.

Neritic. South temperate species. Widespread. Often in large numbers. Up to 1,360,000 cells per liter recorded off La Jolla in August, 1927.

139. *Asterionella kariana* Grunow

Figure 139

1880. In Cleve and Grunow. Kongl. Svensk. Vet.-Akad. Handl., vol. 17, no. 2, p. 110, pl. 6, fig. 121.

Cells united into spiral colonies with a large circular radius. In girdle view wedgeshaped, broad at the base, suddenly constricted, then again widening, decreasing from

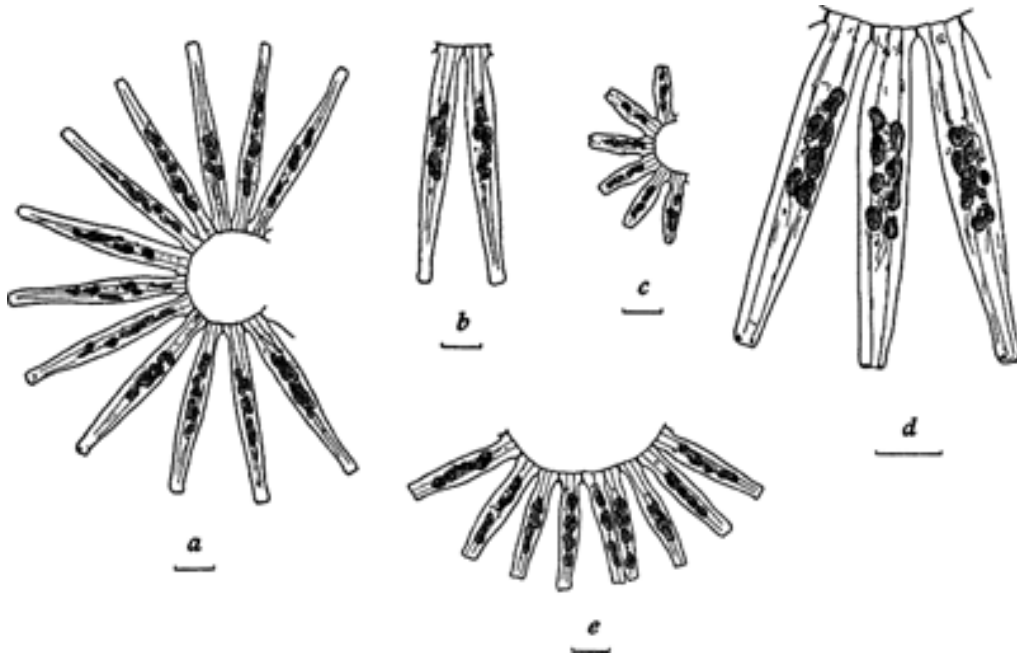

Fig. 139. *Asterionella kariana* Grun. a–e, parts of five colonies; lengths of cells: a, 50 μ ; b, 60 μ ; c, 18 μ ; d, 54 μ ; e, 29 μ .

the middle to the end. Length 16–68 μ . Chromatophores several small plates in each cell, scattered throughout the cell.

Neritic. Boreal-arctic species. Not recorded off southern California. Abundant only in northern waters.

Genus XLIII. **PSEUDOEUNOTIA** Grunow

1880–85. In V. H. Syn., pl. 35 (in part).

Cells united into bands by the valve surfaces. Colonies have appearance of sections of a barrel. Cells in ventral girdle view linear, dorsal view with slightly convex margins. Valves dorsiventral, with strongly arched back margin. Valve surface with thin transapical ribs, the membrane lying between the ribs delicately areolated-punctated. Pseudoraphe and central area absent.

Only one species.

Species: 140. *P. doliolus* (fig. 140)

140. **Pseudoeunotia doliolus** (Wallich) Grunow

Figure 140

1860. Wallich. Trans. Micr. Soc., N.S., vol. 8, p. 48, pl. 2, fig. 19 (*Synedra doliolus*).

1880–85. Grunow. In V. H. Syn., pl. 35, fig. 22.

Colony formation and girdle view as described for the genus. Valves half-lancet-shaped with blunt-rounded ends. One side of valve straight or slightly concave, seldom slightly

convex; other side (back) more strongly convex, gradually decreasing toward the ends and near the ends often slightly constricted. Length 40–60 μ ; width 6–8 μ . Transapical ribs 10–14 in 10 μ . Double row of areolae in quineunx, 20–21 rows in 10 μ . Pseudoraphe and central area absent.

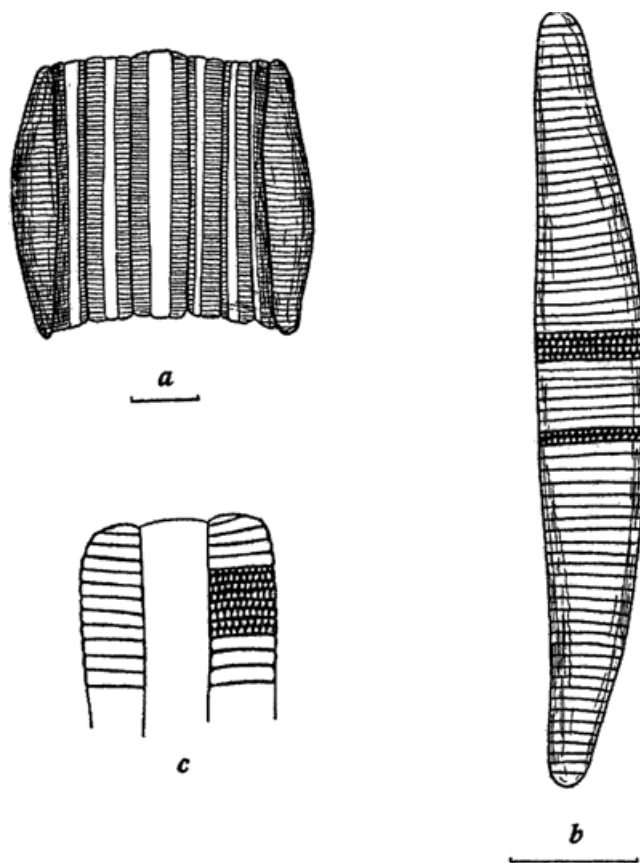

Fig. 140. *Pseudoeunotia doliolus* (Wall.) Grun. *a*, colony; length of cells, 43 μ . *b*, valve view; length, 60 μ ; width, 7 μ . *c*, sketch of part of a cell in girdle view.

Neritic (and littoral) species. Most common in warmer seas. Moderately abundant in Gulf of California (Cupp and Allen, 1938).

B-2. MONORAPHIDEAE

V. ACHNANTHOIDEAE Schütt

1896. Bacill. in Engl-Prantl, Nat. Pflanzenf., p. 120.

10. ACHNANTHEAE Schütt

1896. Bacill. in Engl.-Prantl, Nat. Pflanzenf., p. 120.

Genus XLIV. ACHNANTHES Bory

1822. Dict. class. hist. nat., vol. 1, pp. 79 and 593, pl. 51, fig. 2.

Cells single or united into ribbonlike bands, with or without a gelatinous stalk to hold the chains to the substrate. Seldom pelagic. Valves usually linear-lanceolate, seldom elliptical; in girdle view in general rectangular, but more or less strongly broken along the transapical axis. One valve with a true raphe, the other with a more or less wide pseudoraphe. Membrane with more or less distinctly punctated transapical rows, sometimes

double rows of puncta, seldom with the space between the rows of puncta thickened into strong ribs, or with the entire cell wall areolated. Chromatophores one lying along the valve without a raphe, two or four plates lying along the girdle, or in one species (*A. longipes*) numerous small platelets.

Chiefly littoral species.

Species: 141. *A. longipes* (fig. 141)

141. ***Achnanthes longipes*** Agardh

Figure 141

1832. Consp. crit. Diat., p. 58.

Valves linear with more or less wedge-shaped ends and usually somewhat constricted sides to linear-elliptical with broad rounded ends, 60–100 μ long, 10–30 μ wide. Valve without a raphe with an axial, very narrow pseudoraphe (siliceous rib), without a central area. Valve with a raphe with a threadlike, slightly curved raphe, axial area narrow, central area a narrow cross band reaching to the margin; central knot stauroid; stauros very narrow. Structure of both valves alike: strong transapical ribs, usually at right

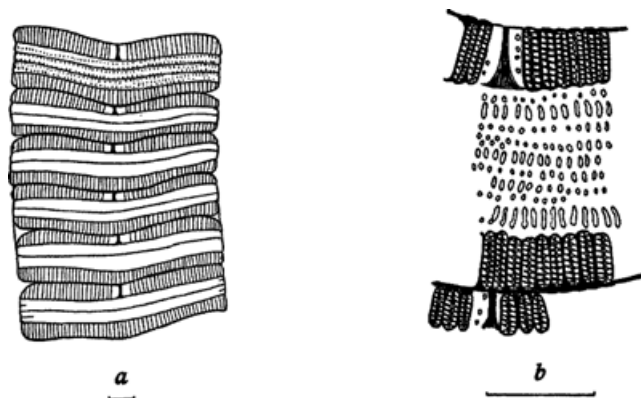

Fig. 141. *Achnanthes longipes* Ag. a, part of a band, girdle view; width of band, 77 μ . b, section through center of a cell, girdle view.

angles to the middle line, near the poles slightly radial, 6–8 in 10 μ . Between the ribs two (seldom four) rows of delicate areolae, 10–12 in 10 μ . Cells in girdle view strongly curved, valve mantle high and rather strongly convex. Girdle bands with delicately punctated striae parallel to the perivalvar axis, 10–13 in 10 μ . Chromatophores numerous small platelets.

Littoral, but found fairly often in plankton collections. North temperate species.

B-3. BIRAPHIDEAE

VI. NAVICULOIDEAE Schütt

1896. Bacill. in Engl.-Prantl, Nat. Pflanzenf., p. 122.

11. NAVICULEAE Schütt

1896. Bacill. in Engl.-Prantl, Nat. Pflanzenf., p. 122.

Genus XLV. NAVICULA Bory

1822. Dict. class. hist. nat., vol. 2, p. 562.

Cells usually free, motile. In plankton species usually united into ribbonlike chains. Valves linear to elliptical, with rounded, capitate or rostrate ends. Axial and central areas usually distinct. Striae or costae parallel or radiate, finely or coarsely punctate,

lineate or apparently smooth. Both valves with raphe and central nodule but without keel. (See fig. B.) Chromatophores two, in bands, one on each zone, sometimes extending over the valves. In some species the chromatophores are on the valves. Some with four bands, others eight. One species known in which chromatophores are granular.

Species: 142. *N. membranacea* (fig. 142)

143. *N. distans* (fig. 143)

142. *Navicula membranacea* Cleve

Figure 142

1897. Treat. phytopl. Atl. trib., p. 24, pl. 2, figs. 25–28.

Cells delicate, thin-walled. United into short, straight chains, 30–50 μ wide. In girdle view rectangular. Valves flat or slightly concave in the center, with a thickening in the middle at right angles to the raphe. In valve view cells are narrow elliptical, acute. Girdle zone striated. No structure visible. Central nodule dilated into a narrow stauros that reaches to the margin. Notches at point of union of valve mantle and girdle. Chromatophores two, drawn out like a ribbon. Several pyrenoids present.

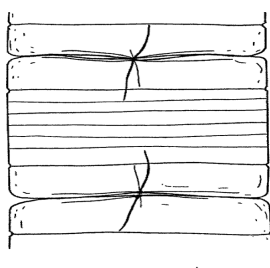

Fig. 142. *Navicula membranacea* CL. Part of a chain showing one complete cell; width, 34 μ .

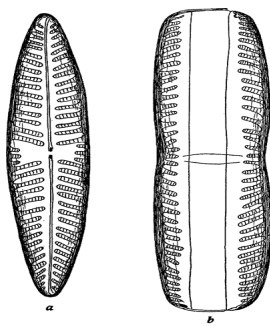

Fig. 143. *Navicula distans* (W. Sm.) Ralfs. *a*, valve; view; length, 70 μ ; width, 13 μ . *b*, girdle view of same cell.

Neritic. Truly planktonic. Temperate species. Found occasionally of southern California and in Gulf of California.

143. *Navicula distans* (W. Smith) Ralfs

Figure 143

1853. W. Smith. Syn. Brit. Diat., vol. 1, p. 56, pl. 18, fig. 169 (*Pinnularia distans*).

1861. Ralfs. In Pritchard, Infus., p. 907.

Cells free. In girdle view rectangular, slightly constricted in the middle; in valve view lanceolate. Length of valves 70–120 μ ; width 14–18 μ . Coarsely striate (costate), about 6

striae in 10μ . Central clear area distinct. Striae radiate with finer striations across them. Two chromatophores, one at each side of the girdle.

Littoral, but occurs occasionally in the plankton.

Genus XLVI. **GYROSIGMA** Hassall

1845. Hist. Brit. freshw. alg., vol. 1, p. 435, pl. 102, fig. 11.

1894. Emended by Cleve. Kongl. Svensk. Vet.-Akad. Handl., vol. 26, no. 2, p. 112.

Valves linear or lanceolate. Usually sigmoid. Axial area very narrow. Central area small. Striae punctate, in transverse and longitudinal rows. Chromatophores two, in long and narrow bands, one on each valve, the margins serrated in marine forms. Pyrenoids present in all species.

Species: 144. *G. spencerii* (fig. 144)

144. **Gyrosigma spencerii** (Quekett) Cleve

Figure 144

1848. Quekett. Treat. microscope, p. 440 (*Navicula spencerii*).

1853. W. Smith. Syn. Brit. Diat., vol. 1, p. 68, pl. 22, fig. 218 (*Pleurosigma spencerii*).

1894. Cleve. Kongl. Svensk. Vet. -Akad. Handl., vol. 26, no. 2, p. 117.

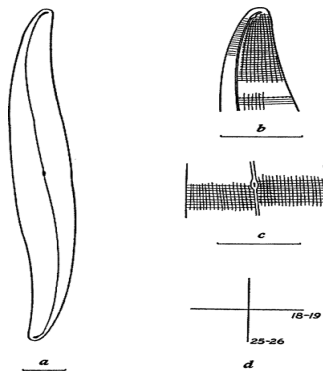

Fig. 144. *Gyrosigma spencerii* (Quek.) Cl. *a*, entire cell; length, 150μ . width, 17μ . *b*, end of cell showing striations. *c*, center of cell showing striations. *d*, diagram indicating direction and number of transverse and longitudinal striae.

Valves sigmoid, lanceolate, with obtuse ends. Raphe central. Central nodule elliptical.

Transverse striae 17–19 in 10μ ; longitudinal striae 24–26 in 10μ . Length of valves 150 – 237μ . Brackish-and fresh-water species. Found occasionally in plankton collections taken near shore. Bottom or littoral species.

Genus XLVII. **PLEUROSIGMA** W. Smith

1852. Ann. Mag. Nat. Hist., ser. 2, vol. 9, p. 1.

1894. Emended by Cleve. Kongl. Svensk. Vet.-Akad. Handl., vol. 26, no. 2, p. 32.

Valves linear to lanceolate, usually sigmoid. Raphe usually sigmoid, central or excentric. Striae finely punctate in oblique and transverse lines. Central nodule usually small and rounded. Cells narrow in girdle view, with narrow connective zone, sometimes twisted or arcuate, or constricted in the middle. Chromatophores usually two bands, one on each valve. Each band is lobed or indented and sometimes differs in opposite valves. Numerous pyrenoids present in most forms.

Littoral or bottom species, often occurring in the plankton.

Species: 145. *P. nicobaricum* (fig. 145)

146. *P. hamuliferum* (fig. 146)

147. *P. elongatum* (fig. 147)

148. *P. normanii* (fig. 148)

145. *Pleurosigma nicobaricum* Grunow

Figure 145

1867. Alg. Novara-Exped., p. 101, pl. 1A, fig. 20.

Valves rhombic, nearly symmetrical (very slightly oblique). Ends moderately broad, rounded. Raphe straight, central, ends curved in opposite directions. Transverse striae

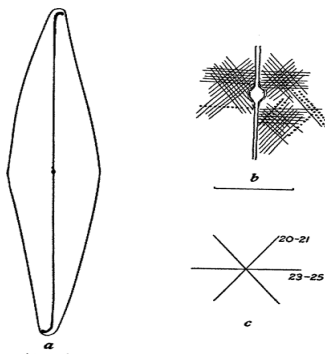

Fig. 145. *Pleurosigma nicobaricum* Grun. *a*, entire cell; length, 130μ ; width, 25μ . *b*, section of center of cell showing striations. *c*, diagram indicating direction and number of oblique and transverse striae.

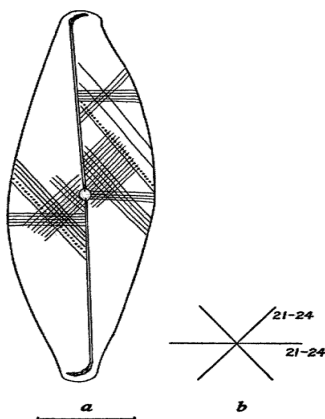

Fig. 146. *Pleurosigma hamuliferum* Brun and Temp. *a*, entire cell; length, 53μ ; width, 13.5μ (striations indicated). *b*, diagram indicating direction and number of oblique and transverse striae.

23–25 in 10μ ; oblique striae 20–22 in 10μ . Striae punctate. Length of valves 120 – 150μ ; width 25μ .

Reported off southern California occasionally.

146. *Pleurosigma hamuliferum* Brun and Tempère

Figure 146

1889. Mém. Soc. Phys. Hist. Nat. Genève, vol. 30, no. 9, p. 48, pl. 9, fig. 5.

Valves rhombic-rounded, slightly oblique. Ends broad, rounded. Raphe straight, oblique, ending in broad curves in opposite directions. Striae punctate. Transverse and oblique striae at an angle of about 65° , equidistant, 21–24 in 10μ . Length of valves 50 – 70μ ; width 13 – 15μ .

Rare. Reported only occasionally off southern California.

147. *Pleurosigma elongatum* W. Smith

Figure 147

1852. Ann. Mag. Nat. Hist., ser. 2, vol.9,p.6, pl. 1, fig.4.

Valves lanceolate, slightly sigmoid, acute ends. Raphe slightly sigmoid, central. Oblique striae at an angle less than 90° ; but more than 60° ; 16–19 in 10μ . Transverse striae 18–21 in 10μ . Length of valves 175–250 μ .

Marine and brackish-water species. Found occasionally in plankton collections, especially near shore.

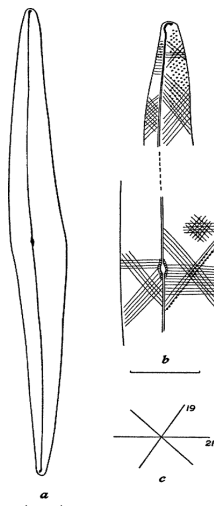

Fig. 147. *Pleurosigma elongatum* W. Sm. *a*, entire cell; length, 190 μ ; width, 16 μ . *b*, sections (end and center) of cell shown in (*a*) with striations indicated. *c*, diagram indicating direction and number of oblique and transverse striae.

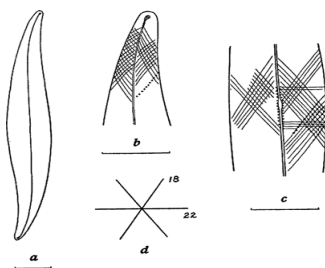

Fig. 148. *Pleurosigma normanii* Ralfs. *a*, entire cell; length, 94 μ ; width, 14 μ . *b*, end of cell shown in (*a*). *c*, center of same cell. *d*, diagram indicating direction and number of oblique and transverse striae.

148. *Pleurosigma normanii* Ralfs

Figure 148

1861. In Pritchard, Infus., p. 919.

Valves broadly lanceolate, slightly sigmoid, with subacute ends. Raphe nearly central, sigmoid. Oblique striae 17–19 in 10μ near the middle, slightly closer at the ends. Transverse striae 20–22 in 10μ . Length of valves 90–150 μ .

Present occasionally in plankton collections taken near shore.

12. AMPHIPROREAE Hustedt

1933. Kieselalgen, pt. 2, sec. 4, p. 434.

Genus XLVIII. **TROPIDONEIS** Cleve

1891. Le Diatomiste, vol. 1, p. 53.

Valves similar to those of *Navicula* but very convex. Lanceolate, acute, usually with a wing or longitudinal band on one or both sides. Median line straight, not sigmoid, on a central or excentric keel. Raphe at edge of keel. Axial area not evident. Central area small, sometimes transverse. Striae transverse and longitudinal, punctate. Girdle zone simple. Chromatophores either two or four plates, serrated or indented. Pyrenoids present. Chromatophores on the girdle band as in most naviculoid diatoms.

Species: 149. *T. lepidoptera* (fig. 149)150. *T. antarctica* var. *polyplasta* (fig. 150)149. **Tropidoneis lepidoptera** (Gregory) Cleve

Figure 149

1857. Gregory. Trans. Micr. Soc., N.S., vol. 5, p. 70, pl. 1, fig. 3 (*Amphiprora lepidoptera*).

1894. Cleve. Kongl. Svensk. Vet.-Akad. Handl., vol. 26, no. 2, p. 25.

Cells rectangular, linear-oblong, constricted in the middle. Valves lanceolate, acute or apiculate. Central area small or transversely lanceolate. Wing unilateral, projecting above the central nodule. Striae transverse. Length of valves 200–350 μ .

Not common off California but reported occasionally in the plankton. Littoral.

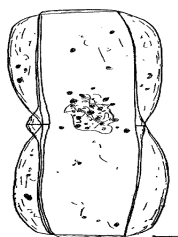

Fig. 149. *Tropidoneis lepidoptera* (Greg.) Cl. Cell in girdle view; length, 260 μ ; width at widest point, 65 μ .

150. **Tropidoneis antarctica** var. **polyplasta** Gran and Angst

Figure 150 (p. 198)

1931. Publ. PUGEST SOUND BIOL. STA., Univ. Wash., vol. 7, p. 501, fig. 90.

In girdle view cells elliptical or slightly constricted at the central nodule. In valve view lanceolate, 200–300 μ long. Keel median. Valves with two or three transverse rodlike thickenings at both sides of the central nodule. Cell wall thin, weakly siliceous. Both transverse and longitudinal punctated striae, 21–24 in 10 μ . Chromatophores numerous, elongated, at cell walls and radiating from the nucleus.

In the plankton off southern California occasionally. Considered by Gran and Angst to be at least nearly related to *T. antarctica* and described by them as a new variety for the present time. Littoral or neritic species.

Genus XLIX. **AMPHIPRORA** (Ehrenberg) Cleve

1843. Ehrenberg. Phys. Abh. Akad. Wiss. Berl. 1841, pp. 401, 410.

1894. Cleve. Kongl. Svensk. Vet.-Akad. Handl., vol. 26, no. 2, p. 13.

Cells single or in ribbonlike chains. Cells constricted in the middle. Valves lanceolate, convex, with raphe, central nodule, and a sigmoid keel. One-half of keel lies on each side of the chain axis. Terminal nodules present. Striae transverse, punctate. Girdle or connective zone complex, with numerous longitudinal rows of transverse striae. Chromatophores usually single, along the girdle.

Species: 151. *A. gigantea* var. *sulcata* (fig. 151)

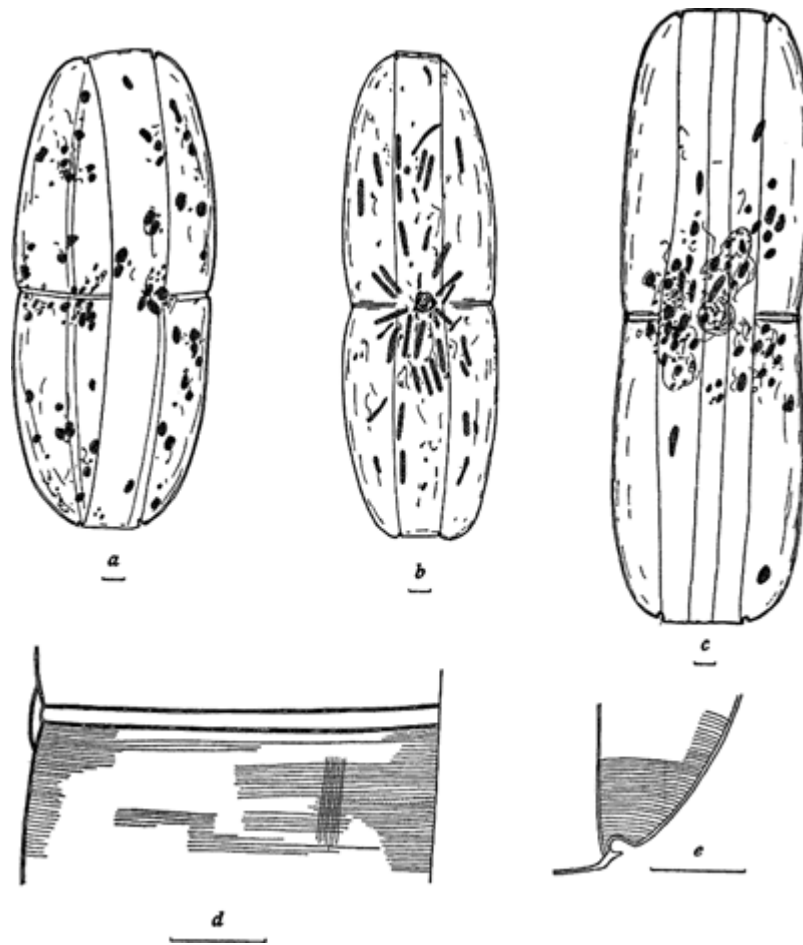

Fig. 150. *Tropidoneis antarctica* var. *polyplasta* Gran and Angst. *a-c*, entire cells. *a*, length, 215μ (cell slightly turned). *b*, length, 217μ ; width at widest point, 68μ (note chromatophores). *c*, length, 275μ ; width at widest point, 85μ . *d*, section of center of valve of cell illustrated in (*a*) showing striations. *e*, section near end of cell shown in (*c*).

151. *Amphiprora gigantea* var. *sulcata* (O'Meara) Cleve

Figure 151

1871. O'Meara. Quart. Jour. Micr. Sci., N.S., vol. 11, p. 22, pl. 3, fig. 3 (*Amphiprora sulcata*).

1894. Cleve. Kongl. Svensk. Vet.-Akad. Handl., vol. 26, no. 2, p. 18.

Cells strongly constricted. Keel with a hyaline margin, broader toward the ends. Junction line curved like a bow. Keel with puncta forming obliquely decussating rows, 14–16 in 10μ . Striae of the valve curved, divergent from the central nodule, 12–14 in 10μ , not decussating. Median line strongly sigmoid. Connecting zone with numerous longitudinal divisions. Striae on connective zone transverse, 21–24 in 10μ . Length of valves 95–120 μ .

Rare. Found only occasionally off southern California in plankton collections. Littoral.

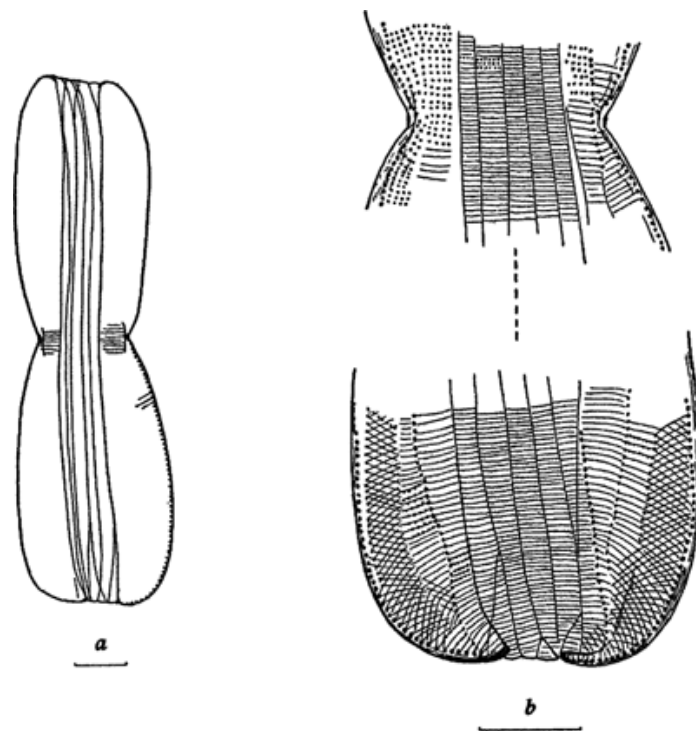

Fig. 151. *Amphiprora gigantea* var. *sulcata* (O'M.) Cl. *a*, entire cell; length, 105 μ . *b*, sections of center and end of same cell showing striations.

VII. NITZSCHIOIDEAE Schütt

1896. Bacill. in Engl.-Prantl, Nat. Pflanzenf., p. 142.

13. NITZSCHIEAE Schüt

1896. Bacill. in Engl.-Prantl, Nat. Pflanzenf., p. 142.

Genus **L. NITZSCHIA** Hassall

1845. Hist. Brit. freshw. alg., vol. 1, p. 435.

1880. Emended by Grunow. In Cleve and Grunow, Kongl. Svensk. Vet.-Akad. Handl., vol. 17, no. 2, p. 67.

Cells spindle-shaped, single or united into colonies. Valves keeled, the keel including a concealed raphe, usually diagonally opposite, either central or excentric (see fig. E, 4, k1, k2). Keel puncta short or prolonged (fig. E, 2, 3, kp). Striae transverse, punctate (fig. E, 2, 3, st, p). No central nodule. Chromatophores two bands placed transversely upon one zone. In certain forms the number of plates may vary from four to six. A pyrenoid sometimes found in center of a chromatophore.

Species: 152. *N. bilobata* var. *minor* (fig. 152)

153. *N. closterium* (fig. 153)

154. *N. longissima* (fig. 154)

155. *N. seriata* (fig. 155)

156. *N. pungens* var. *atlantica* (fig. 156)

157. *N. pacifica* (fig. 157)

158. *N. delicatissima* (fig. 158)

159. *N. paradoxa* (fig. 159)

152. *Nitzschia bilobata* var. *minor* Grunow

Figure 152

1880–85. In V. H. Syn., pl. 60, figs. 2, 3.

Valves linear-lanceolate, constricted in the middle, apiculate at the ends. Keel puncta 12–14 in 10μ (6–7 in the type), prolonged slightly over the valve, at unequal distances, the two median ones remote. Striae 26–30 in 10μ . (16–19 in the type). Cells broad, oblong, truncate, constricted in the middle. Length of valves 55–70 μ ; width at widest point 6–7 μ . (Length in type 80–150 μ .)

Littoral species. Only occasionally in plankton catches.

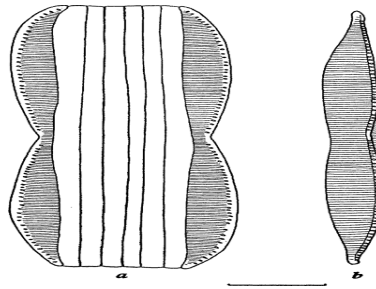

Fig. 152. *Nitzschia bilobata* var. *minor* Grun. *a*, cell in girdle view; length, 63 μ . *b*, same cell in valve view; width, 6 μ .

153. *Nitzschia closterium* (Ehrenberg) W. Smith

Figure 153

1841. Ehrenberg. Phys. Abh. Akad. Wiss.

Berl. 1839, no. 24, p. 64, pl. 4, fig. 7 (*Ceratoneis closterium*).

1853. W. Smith. Syn. Brit. Diat., vol. 1, p. 42, pl. 15, fig. 120.

Cells single, motile. Ends hairlike, flexible. Center lanceolate. Nucleus central. Chromatophores two, in center only, not in hairlike ends. Cells usually bent slightly. Length of valves 25–100 μ . Keel puncta about 7 in 10μ .

Ubiquitous. Very common in the littoral zone, frequently in the plankton.

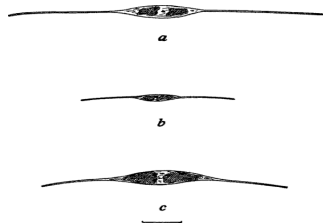

Fig. 153. *Nitzschia closterium* (Ehr.) W. Sm. *a*, cell 86 μ long. *b*, cell 41 μ long. *c*, cell 66 μ long. Note chromatophores.

154. *Nitzschia longissima* (Brébisson) Ralfs

Figure 154

1849. Brébisson. In Kützing, Sp. alg., p. 891 (*Ceratoneis longissima*).1861. Ralfs. In Pritchard, Infus., p. 783 (*Ceratoneis longissima* = *Nitzschia birostrata* W. Sm.).

1880. Cleve and Grunow. Kongl. Svensk. Vet.-Akad. Handl., vol. 17, no. 2, p. 100 (*Nitzschia longissima* = *N. birostrata*).

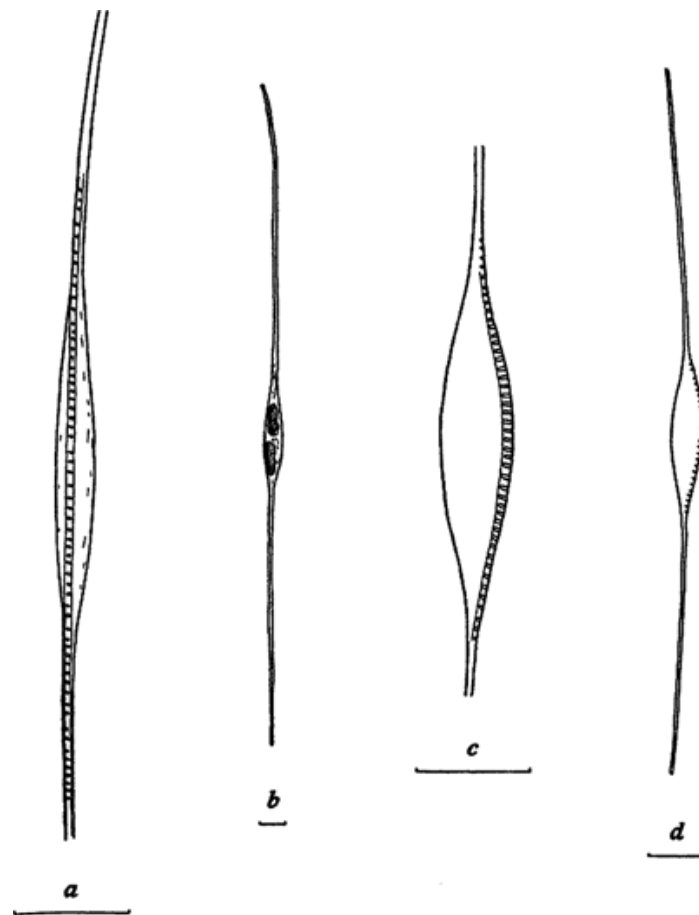

Fig. 154. *Nitzschia longissima* (Bréb.) Ralfs. *a*, part of a cell showing keel and keel puncta. *b*, entire cell with chromatophores; length, 209 μ . *c*, center of cell shown in (*d*). *d*, entire cell; length, 127 μ .

Valves linear-lanceolate. Ends extended into very long horns. Keel puncta 8–14 in 10 μ . Striae about 16 in 10 μ , often difficult to see. Length of valves 125–250 μ . Chromatophores as in *N. closterium*.

Littoral species, frequently found in the plankton. Never in large numbers.

155. *Nitzschia seriata* Cleve

Figure 155 (p.202)

1883. Vega-Exped. Vetensk. Iakttag., vol. 3, p. 478, pl. 38, fig. 75.

Cells spindle-shaped with more or less pointed to moderately rounded ends. United into stiff, hairlike chains by the overlapping points of the cells. Chains motile as a whole. Length of valves 80–140 μ (most commonly 95–115 μ); width 6.2–8 μ (usually 6.5–7 μ). Keel puncta indistinct, obsolete or nearly so, about the same number as the striae. Striae 14–19 in 10 μ , punctate. Chromatophores two per cell, one on each side of the central nucleus.

Northern to arctic, neritic species. Present in large numbers at Scotch Cap, Alaska. Recorded by Gran (1912) as an arctic, oceanic species.

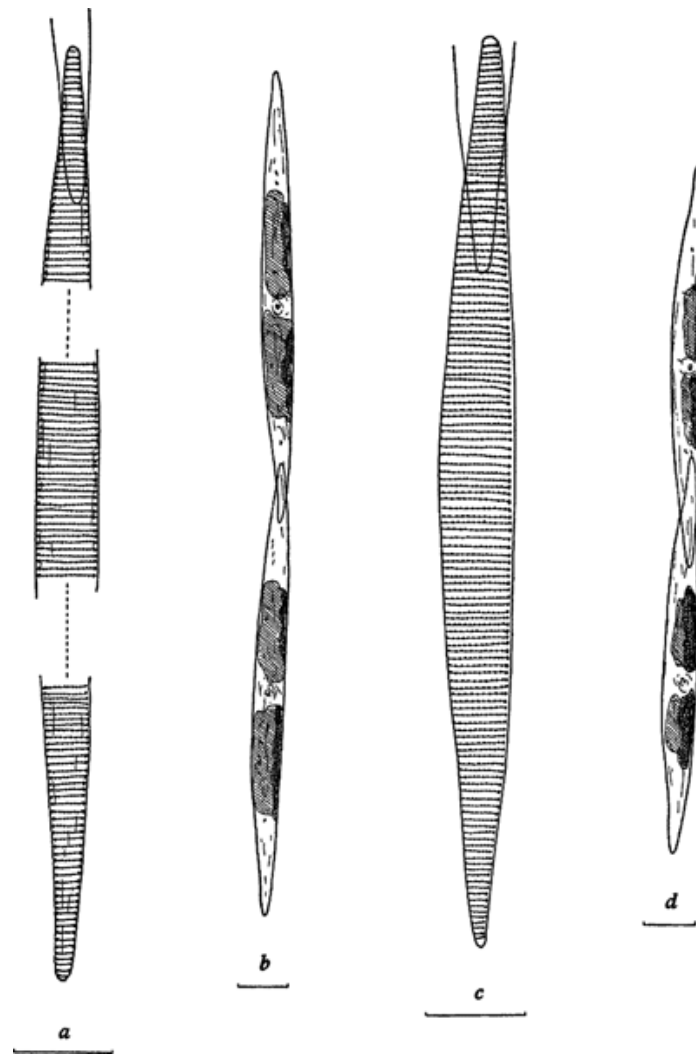

Fig. 155. *Nitzschia seriata* C1. *a*, cell 102μ long, 6μ wide, valve view; striae, 17 in 10μ . *b*, chain with chromatophores, valve view; length of cells, 102μ . *c*, cell 90μ long, 7μ wide, valve view; striae, 15 in 10μ . *d*, chain, valve view; cells 88μ long, 6.5μ wide. Note chromatophores.

156. *Nitzschia pungens* var. *atlantica* Cleve

Figure 156

1897. Treat. phytopl. Atl. trib., p. 24, pl. 2, fig. 24.

Valves linear-lanceolate, acute. Cells united into stiff chains by the overlapping tips of the cells. Chains motile. Length of valves $71-162\mu$; width $2.3-4.8\mu$. Keel puncta obsolete,

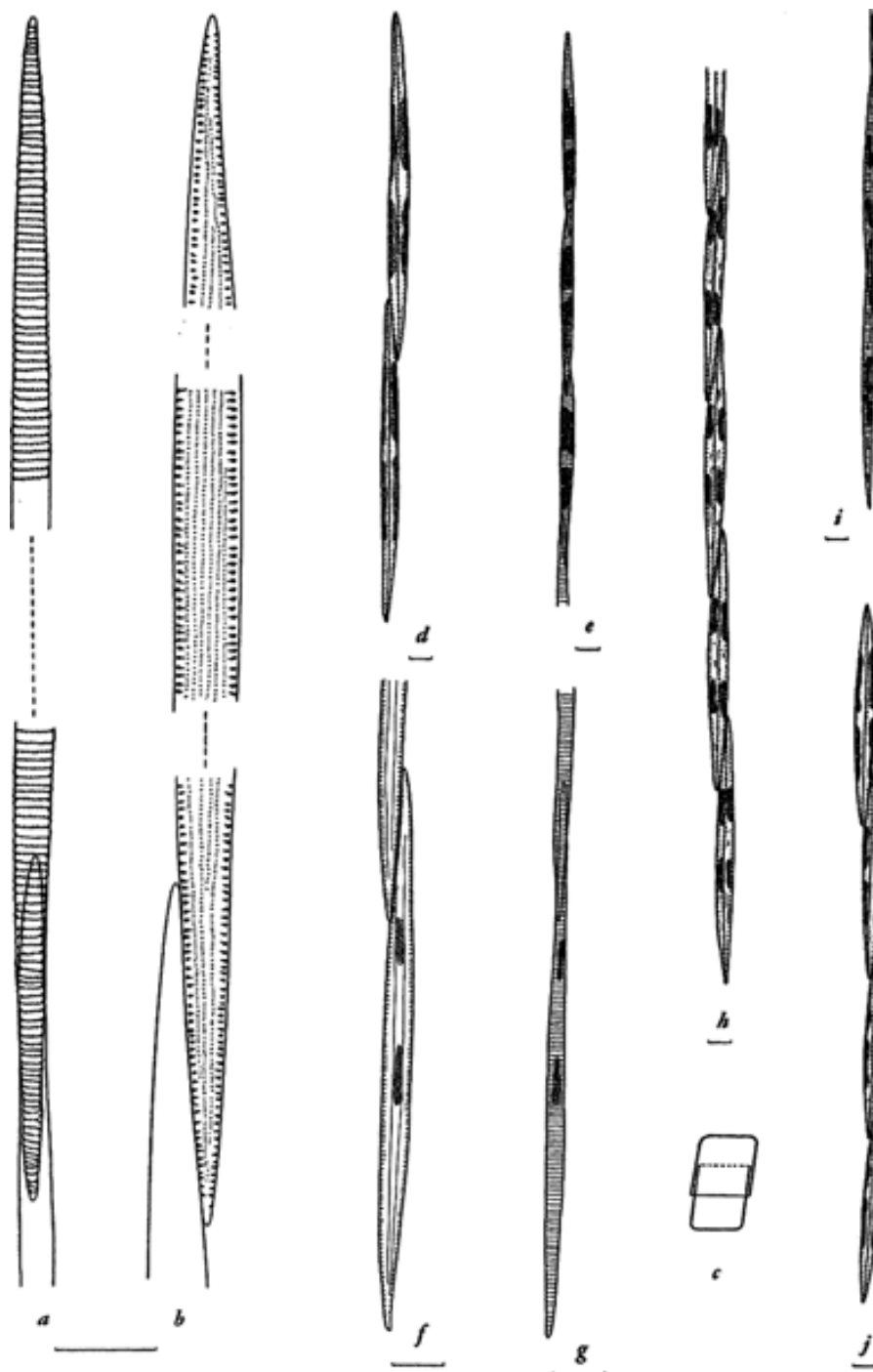

Fig. 156. *Nitzschia pungens* var. *atlantica* C1. *a*, valve view. *b*, girdle view of same cell as in (*a*) Length, 137 μ ; width of valve, 4 μ ; striae, 12–13 in 10 μ . *c*, cross section of a cell. *d*, chain, girdle view; cells dividing; length, 145 μ . *e*, chain, valve view; length, 90 μ . *f* and *g*, parts of same chain; length of cell, 115 μ ; width of valve, 3 μ ; striae, 12–13 in 10 μ , *f*, girdle view. *g*, valve view. *h*, chain of dividing cells, girdle view; length, 113 μ . *i*, chain in valve view; length, 112 μ ; width, 4.5 μ . *j*, another chain in girdle view; length, 90 μ .

of the same number as the striae. Striae 11–16 (usually 13–14) in 10μ , punctate. Chromatophores two plates in each cell, one at each side of the central nucleus, lying along the cell wall under normal conditions. Closely related to *N. seriata* but cells more pointed, valves narrower, and usually with greater overlapping of cell ends. Striae often visible in water mounts. Distinguished from the type chiefly by greater number of striae (10 in 10μ in the type).

Neritic. Temperate species. Common off southern California and Lower California, and in the Gulf of California. Distribution and abundance uncertain because of frequent confusion with *N. seriata* and *N. pacifica*.

157. ***Nitzschia pacifica*** n. sp.

Figure 157

Cells spindle-shaped with more or less pointed ends. United into stiff chains by the overlapping points of the cells as in *N. seriata*, *N. pungens* var. *atlantica*, and *N. delicatissima*. Chains motile as a whole. Length of valves 55–118 μ ; width 4.5–7.5 μ . Keel puncta distinct, 12–19 in 10μ . Striations punctate, 20–36 in 10μ (about twice as many striations as keel puncta on a valve). Chromatophores two per cell, one on each side of the nucleus. Asexual auxospore formation observed (fig. 157, g–k). (See also fig. E, 2, 3, 4.)

Neritic or possibly oceanic temperate species. Very abundant at times off southern California and Lower California, and in the Gulf of California. Also present at Scotch Cap, Alaska, along with *N. seriata*.

In general appearance in water mounts the species is frequently almost indistinguishable from *N. pungens* var. *atlantica*, *N. seriata*, and *N. delicatissima*. The presence of distinct keel puncta and finer striae, the distribution in warmer waters, and the less robust appearance were deciding factors in establishing it as a new species separate from *N. seriata*. *Nitzschia fraudulenta* (Cleve, 1897b, p. 300, fig. 11), a synonym of *N. seriata* according to Gran and Angst (1931), was originally described as much more delicate and with finer striations (23 in 10μ) than *N. seriata*. However, it has not been described as having distinct keel puncta. This fact appears to eliminate the possibility that it might be a synonym of *N. pacifica*. *Nitzschia pungens* and its variety *atlantica* are more closely related to *N. seriata* in structure than is *N. pacifica*. Meunier (1910, p. 334, pl. 34, figs. 38–40) showed keel puncta on specimens which he called *N. seriata*. His figures may represent individuals belonging to *N. pacifica*.

158. ***Nitzschia delicatissima*** Cleve

Figure 158 (p. 206)

1897. Treat. phytopl. Atl. trib., p. 24, pl. 2, fig. 22.

Valve narrow, linear, acute. Cells united into stiff, hairlike chains by the overlapping tips of the cells. Chains usually short, motile. Length of valves 32–85 μ ; width 1.3–2.8 μ . Keel slightly excentric; keel puncta 14–25 in 10μ . No striae visible. Chromatophores two per cell, one on either side of the central nucleus. Asexual auxospore formation observed (fig. 158, h–i). Similar in general appearance to *N. pacifica* but more delicate.

Neritic. Widespread. Karsten (1906) gave *N. delicatissima* as one of the six truly bipolar diatom species. Common off California and north. Probably often confused with *N. pacifica*.

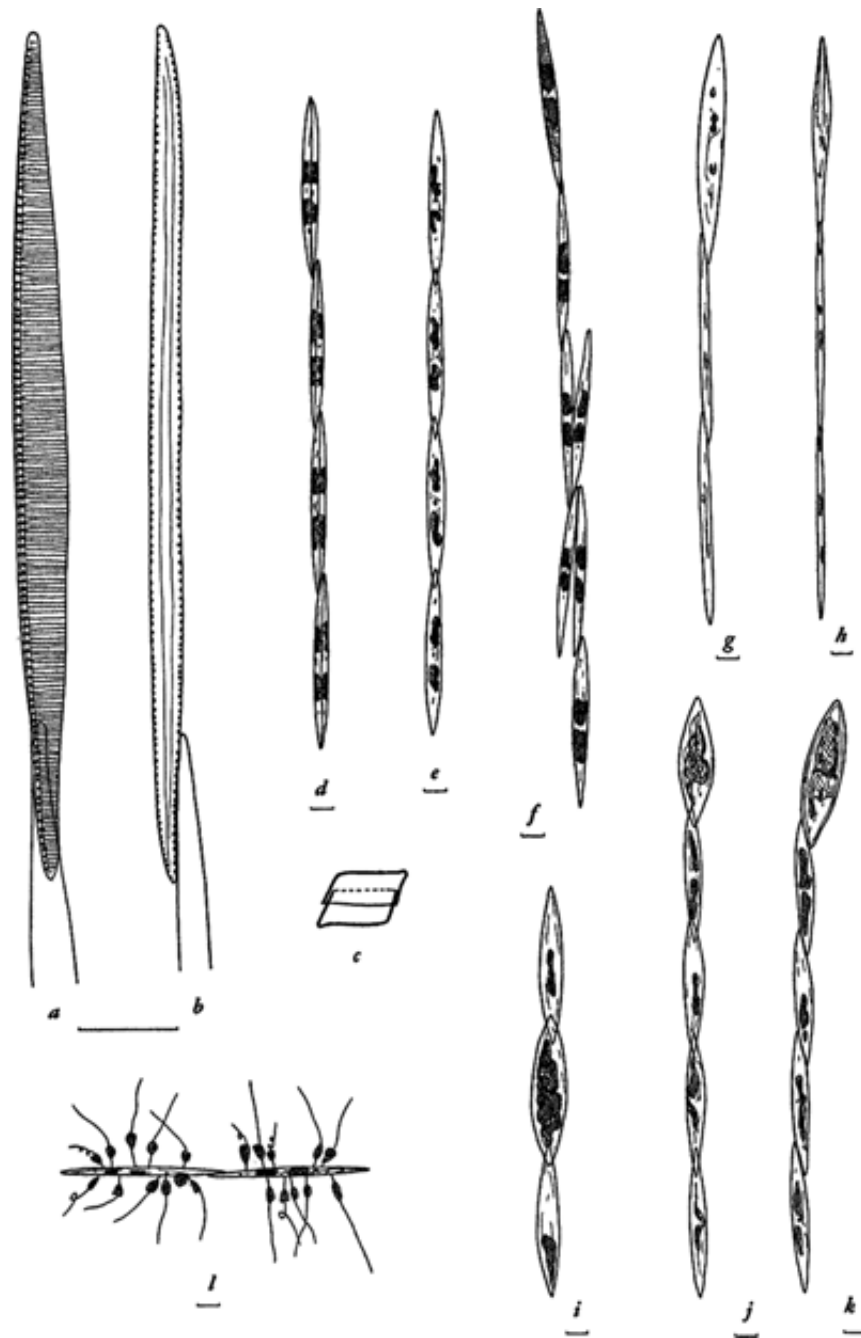

Fig. 157. *Nitzschia pacifica* Cupp. *a* and *b*, same cell. *a*, valve view. *b*, girdle view. Length, 86μ ; width of valve, 5.2μ ; striae, 26–27 in 10μ ; keel puncta, 13–14 in 10μ . *c*, cross section of a cell. *d*, chain with cells dividing, girdle view; length of cells, 75μ . *e*, valve view of chain in (*d*). *f*, chain with cells breaking apart after division. *g*–*k*, chains with auxospores. *g* and *h*, same chain. *g*, girdle view. *h*, valve view. Length of cells, 97μ . *i*, auxospore in center of chain; length of cells, 67μ ; width of auxospore, 15μ ; width of other cells, 7.5μ . *j* and *k*, two views of same chain. *j*, valve view. *k*, girdle view. Length of cells, 62μ ; width of auxospore, 17μ ; width of other cells, 8μ . *l*, two cells with epiphytic protozoa attached (*Bicoeca mediterranea* or related species). Sometimes as many as 28 protozoa are attached to one cell.

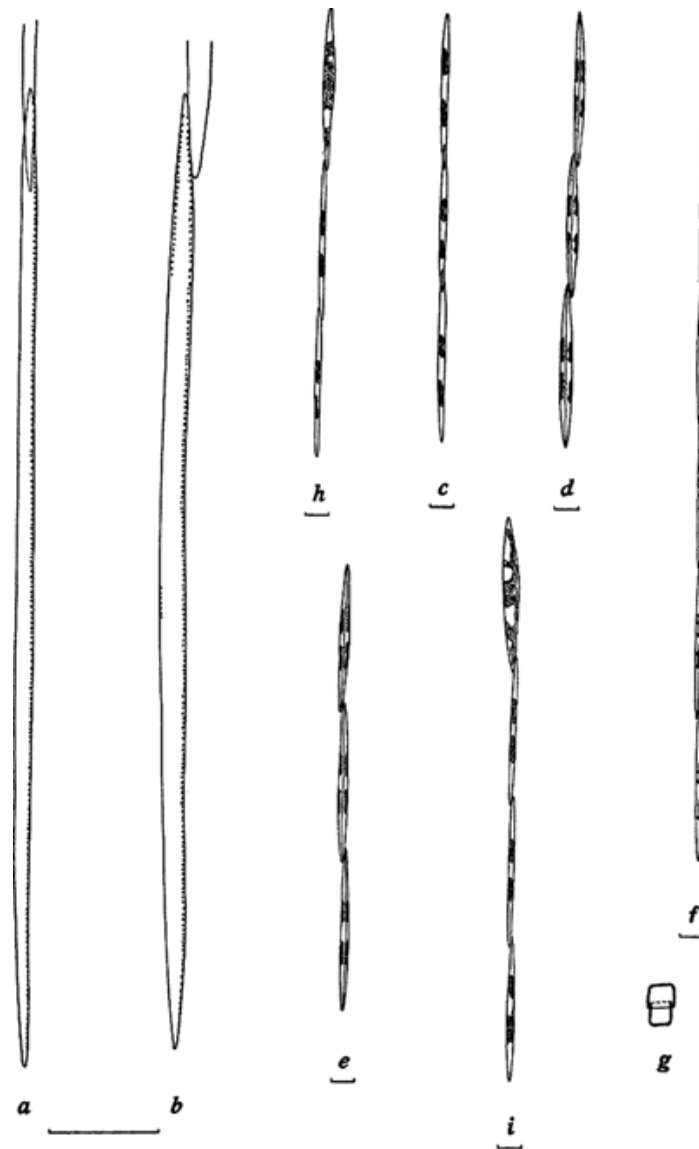

Fig. 158. *Nitzschia delicatissima* Cl. *a* and *b*, same cell. *a*, valve view. *b*, girdle view. Length, 88μ ; width of valve, 1.5μ ; puncta, 20–22 in 10μ . *c*–*f*, chains. *c*, valve view; length, 63μ . *d*, same chain as in (*c*), girdle view; cells dividing. *e*, girdle view, cells dividing; length, 63μ . *f*, girdle view; length of cells, 65μ . *g*, cross section of a cell. *h* and *i*, chains with auxospores.

159. *Nitzschia paradoxa* (Gmelin) Grunow

Figure 159

1788. Gmelin. In Linné, Syst. natur. (ed. 13), vol.6, p. 3903 (*Bacillaria paradoxa*).

1880–85. Grunow. In V. H. Syn., p. 176, pl. 61, fig. 6.

1880. Grunow. In Cleve and Grunow, Kongl. Svensk. Vet.-Akad. Handl., vol. 17, no. 2, p. 85.

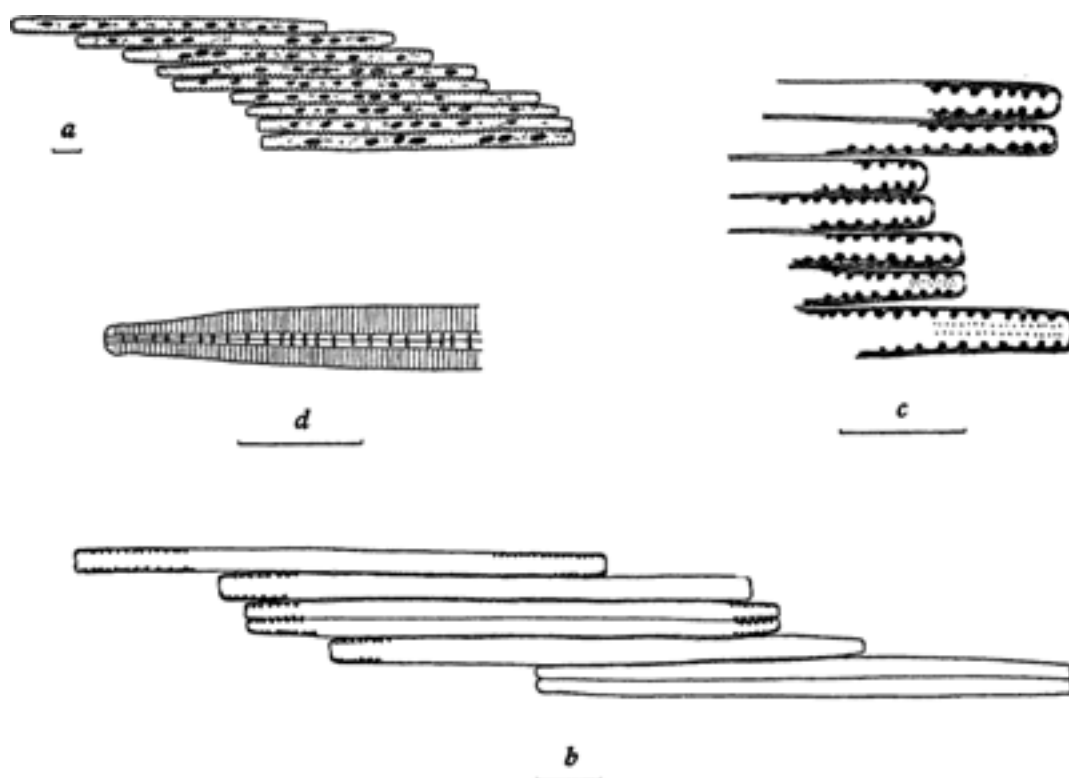

Fig. 159. *Nitzschia paradoxa* (Gmel.) Grun. *a*, colony, girdle view; length of cells, 107μ . *b*, another colony, girdle view; length of cells, 87μ . *c*, ends of cells in a colony, girdle view. *d*, valve view of part of a cell; width, 5μ ; keel puncta, 7–8 in 10μ ; striae, 20 in 10μ .

Cells united into movable colonies, the cells sliding along one another. In girdle view rectangular. In valve view linear-lanceolate with produced ends. Keel nearly central. Keel puncta 7–9 in 10μ . Striae 20–21 in 10μ . Length of valves 80 – 115μ ; width 5 – 6μ . Chromatophores small, numerous. Nucleus central.

Littoral marine and brackish-water species. Occasionally present in plankton collections.

VIII. SURIRELLOIDAE Schütt

1896. Bacill. in Engl.-Prantl, Nat. Pflanzenf., p. 145.

14. SURIRELLEAE Schütt

1896. Bacill. in Engl.-Prantl, Nat. Pflanzenf., p. 145.

Genus LI. SURIRELLA Turpin

1828. Mém. Mus. Hist. Nat., vol. 16, p. 361, pl. 15, figs. 1–7, 9–11, 14.

Cells single. In girdle view linear or wedge-shaped. Valves linear, elliptical or oval, sometimes constricted. Costae long or short, extending toward the center but not quite to it, with intermediate striae more or less evident. Central space linear or lanceolate, often obscure. Valves with a longitudinal central pseudoraphe and marginal, more or less elevated, undulated keel produced into winglike expansions containing the raphe on each side. Pseudoraphes of the two valves parallel. Raphe difficult to see. Distinct canal pores usually visible. Valve surface nearly flat, rarely spirally twisted.

Bottom and littoral forms found occasionally in the plankton.

Species: 160. *S. fastuosa* var. *recedens* (fig. 160)

160. *Surirella fastuosa* var. *recedens* (A. Schmidt) Cleve

Figure 160

1874. Schmidt. Atlas, ser. 1, pl. 19, figs. 2-4; pl. 24, fig. 28.

1878. Cleve. Bih. Kongl. Svensk. Vet.-Akad. Handl., vol.5, no.8, p. 11.

Cells wedge-shaped, rounded at the angles. Valves ovate. Costae or ribs about 2.5 in 10μ , robust, dilated at the margin. Central space lanceolate, narrower than in the type. The shortened lower end of the central space leaving the last two or three pairs of costae unattached

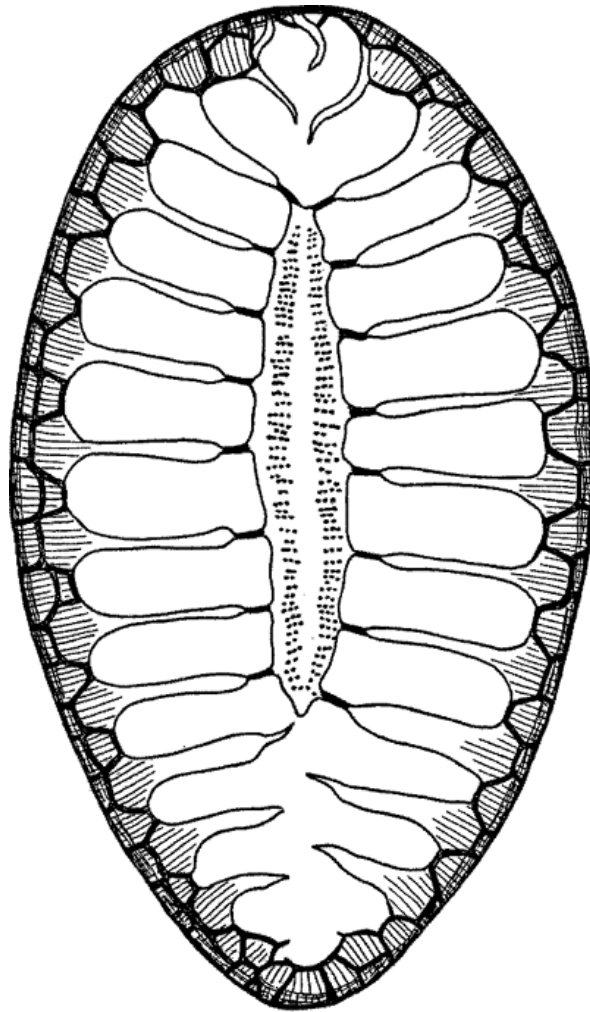

Fig. 160. *Surirella fastuosa* var. *recedens* (A. Schm.) Cl. Entire valve; length, 70μ ; width, 40μ .

is characteristic of the variety. Marginal striae distinct, 17-19 in 10μ . Striae in central field 17-20 in 10μ . Length of valves $54-80\mu$; width $30-45\mu$. Figure 28 on plate 24 of Schmidt's Atlas is a drawing of a specimen from California.

Not common. Found occasionally in the plankton collections off southern California and Lower California.

LITERATURE CITED

AGARDH, C. A.

1824. 'Systema algarum'. *Lundae, Literis Berlingianis*. xxxviii + 312 pp.
1830–32. 'Conspectus criticus Diatomacearum. Parts I–IV'. *Lundae*. 66pp.

ALLEN, W. E.

1921. 'Some work on marine phytoplankton in 1919'. *Trans. Amer. Micr. Soc.*, vol. 40, pp.177–181.
1922. 'Quantitative studies on inshore marine diatoms and dinoflagellates of southern California in 1920'. *Univ. Calif. Publ. Zoöl.*, vol. 22, pp.369–378, 1fig.
1923. 'Observations on surface distribution of marine diatoms of Lower California in 1921'. *Proc. Calif. Acad. Sci.*, vol. 12, pp.437–442.
1924. 'Observations on surface distribution of marine diatoms of Lower California in 1922'. *Ecology*, vol. 5, pp.389–392, 1fig.
1927a. 'Quantitative studies on inshore marine diatoms and dinoflagellates of southern California in 1921'. *Bull. Scripps Inst. Oceanog., Tech. Ser.*, vol. 1, pp.19–29, 1fig.
1927b. 'Quantitative studies on inshore marine diatoms and dinoflagellates of southern California in 1922'. *Ibid.*, pp.31–38, 2figs.
1927c. 'Surface catches of marine diatoms and dinoflagellates made by U.S.S. "Pioneer" in Alaskan waters in 1923'. *Ibid.*, pp.39–48, 2figs.
1928a. 'Catches of marine diatoms and dinoflagellates taken by boat in southern California waters in 1926'. *Ibid.*, pp.201–245, 6figs.
1928b. 'Quantitative studies of inshore marine diatoms and dinoflagellates collected in southern California in 1924'. *Ibid.*, pp.347–356, 1fig.
1928c. 'Review of five years of studies on phytoplankton at southern California piers, 1920–1924 inclusive'. *Ibid.*, pp.357–401, 5figs.
1929a. 'Surface catches of marine diatoms and dinoflagellates made by U.S.S. "Pioneer" in Alaskan waters in 1924'. *Ibid.*, vol. 2, pp.139–153, 2figs.
1929b. 'Ten years of statistical studies of marine phytoplankton at the Scripps Institution of Oceanography'. *Science*, vol. 70, pp.416–419.
1930. 'Quantitative studies of surface catches of marine diatoms and dinoflagellates taken in Alaskan waters by the International Fisheries Commission in the fall and winter of 1927–1928 and 1929'. *Bull. Scripps Inst. Oceanog., Tech. Ser.*, vol. 2, pp.389–399.
1932. 'Problems of flotation and deposition of marine plankton diatoms'. *Trans. Amer. Micr. Soc.*, vol. 51, pp.1–7.
1933. 'Surface phytoplankton obtained by the Templeton Crocker expedition of the California Academy of Sciences of 1932'. *Ibid.*, vol. 52, pp.101–102.
1934a. 'Marine plankton diatoms of Lower California in 1931'. *Bot. Gaz.*, vol. 95, pp.485–492, 1fig.
1934b. 'The primary food supply of the sea'. *Quart. Review Biol.*, vol. 9, pp.161–180, 3figs.
1936. 'Occurrence of marine plankton diatoms in a ten-year series of daily catches in southern California'. *Amer. Jour. Bot.*, vol. 23, pp.60–63.
1937. 'Plankton diatoms of the Gulf of California obtained by the G. Allan Hancock expedition of 1936'. *Univ. South. Calif. Press, Hancock Pacific Exped.*, vol. 3, pp.47–59, 1fig.
1938. 'The Templeton Crocker expedition to the Gulf of California in 1935—the phytoplankton'. *Trans. Amer. Micr. Soc.*, vol. 57, pp.328–335, 1fig.
1939. 'Surface distribution of marine plankton diatoms in the Panama region in 1933'. *Bull. Scripps Inst. Oceanog., Tech. Ser.*, vol. 4, pp.181–196, 4figs.

ALLEN, W. E., and LEWIS, RALPH

1927. 'Surface catches of marine diatoms and dinoflagellates from Pacific high seas in 1925 and 1926'. *Bull. Scripps Inst. Oceanog., Tech. Ser.*, vol. 1, pp.197–200.

APSTEIN, C.

1909. '*Chaetoceras gracile* Schütt und *Chaetoceras vistulae* n. sp. Wiss. Meeresunters., Abt. Kiel, N.F.', vol. 11, pp.133–137, 2figs.

ASKENASY, E.

1867. 'Beiträge zur Kenntniss des Chlorophylls und einiger dasselbe begleitender Farbstoffe'. *Bot. Zeit.*, vol. 25, pp.225–230, 233–238.

ATKINS, W. R. G.

- 1923a. 'The phosphate content of fresh and salt waters in' its relationship to the growth of the algal plankton'. *Mar. Biol. Assn. U.K., Jour.*, vol. 13, pp.119–150.

- 1923b. 'The silica content of some natural waters and of culture media'. *Ibid.*, pp.151–159.

- 1926a. 'Seasonal changes in the silica content of natural waters in relation to the phytoplankton'. *Ibid.*, vol. 14, pp.89–99.

- 1926b. 'A quantitative consideration of some factors concerned in plant growth in water'. *Conseil Perm. Internat. Explor. de la Mer, Jour.*, vol. 1, pp.99–126, 197–226.

- 1926c. 'The phosphate content of sea water in relation to the growth of the algal plankton'. *Mar. Biol. Assn. U.K., Jour.*, vol. 14, pp.447–467.

1928. 'Seasonal variations in the phosphate and silicate content of sea water during 1926 and 1927 in relation to the phytoplankton crop'. *Ibid.*, vol. 15, pp.191–205.

1930. 'Seasonal variations in the phosphate and silicate content of sea water in relation to the phytoplankton crop. Part V. November, 1927, to April, 1929, compared with earlier years from 1923'. *Ibid.*, vol. 16, pp.821–852, 12figs.

BACHRACH, E., and LEFÈVRE, M.

1929. 'Contribution à l'étude du rôle de la silice chez les êtres vivants. Observations sur la biologie des Diatomées'. *Jour. Phys. Pathol. Génér.*, vol. 27, pp.241–249.

BAILEY, J. W.

1842. 'A sketch of the Infusoria, of the family Bacillaria, with some account of the most interesting species which have been found in a Recent or fossil state in the United States'. *Amer. Jour. Sci.*, vol. 42, pp.88–105, pl. 2; vol. 43, pp.321–332, pl. 5.

1845. 'Notice of some new localities of Infusoria, fossil and Recent'. *Ibid.*, vol. 48, pp.321–343, pl. 4.

1851. 'Microscopical examination of soundings made by the U.S. Coast Survey off the Atlantic coast of the United States'. *Smithson. Contrib. Knowl.*, vol. 2, pp.1–15, pl. 1.

1854. 'Notes on new species and localities of microscopical organisms'. *Ibid.*, vol. 7, pp.1–16, pl. 1.

1856. 'Notice of microscopic forms found in the soundings of the sea of Kamtschatka'. *Amer. Jour. Sci.*, Ser. II, vol. 22, pp.1–6, pl. 1.

BAILEY, L. W.

1862. 'Notes on new species of microscopical organisms, chiefly from the Para River, South America'. *Boston Jour. Nat. Hist.*, vol. 7, pp.329–352, pls. 7–8.

BERGON, P.

1903. 'Etudes sur la flore diatomique du Bassin d'Arcachon et des parages de l'Atlantique voisins de cette station'. *Bull. Soc. Sci. Arcachon, Sta. Biol.*, vol. 6.

BIGELOW, H. B.

1926. 'Plankton of the offshore waters of the Gulf of Maine'. *Bull. U.S. Bur. Fish.*, vol. 40, pt.2, pp.1–509.

BIGELOW, H. B., and LESLIE, M.

1930. 'Reconnaissance of the waters and plankton of Monterey Bay, July, 1928'. *Bull. Mus. Comp. Zoöl., Harvard Col.*, vol. 70, pp.429–581.

BORY DE SAINT VINCENT, J. B. M.

1822. 'Dictionnaire classique d'histoire naturelle. 1822–1831. Paris, Baudoïn Frères'. Diatomaceae scattered throughout the 17 vols. in alphabetical arrangement. Pl. 51, figs. 1–2; pl. 54, figs. 1, 3.

BOYER, C. S.

- 1926–27. 'Synopsis of North American Diatomaceae'. *Proc. Acad. Nat. Sci. Philadelphia*. Part I. Coscinodiscatae, Rhizosolenatae, Biddulphiatae, Fragilariatae, vol. 78, 1926 suppl., pp.1–228. Part II. Naviculatae, Surirellatae, vol. 79, 1927 suppl., pp.229–583.

BRANDT, K.

1902. 'Ueber den Stoffwechsel im Meere. Part 2'. *Wiss. Meeresunters., Abt. Kiel, N.F.*, vol. 6, pp.25–79.

BRÉBISSON, ALPHONSE DE

1857. 'Description de quelques nouvelles Diatomées observées dans le guano du Pérou, formant le genre *Spatangidium*'. 'Bull. Soc. Linn. Normandie', vol. 2, pp.292–298, pl. 3. (Reprinted in *Ann. Sci. Nat., IV, Bot.*, vol. 9, pp.91–96, pl. 4. 1858.)

BRÉBISSON, ALPHONSE DE, and GODEY

1838. 'Considerations sur les Diatomées et essai d'une classification des genres et des espèces appartenant à cette famille'. *Falaise*. 20pp.

BRIGHTWELL, THOMAS

1856. 'On the filamentous, long-horned Diatomaceae, with a description of two new species'. *Quart. Jour. Micr. Sci.*, vol. 4, pp.105–109, pl. 7.
 1858a. 'Remarks on the genus *Bhizosolenia* of Ehrenberg'. *Ibid.*, vol. 6, pp.93–95, pl. 5.
 1858b. 'Further observations on the genera *Triceratium* and *Chaetoceros*'. *Ibid.*, pp.153–155, pl. 8.
 1859. 'On some of the rarer or undescribed species of Diatomaceae'. *Ibid.*, vol. 7, pp.179–181, pl. 9.

BRUN, JACQUES, and TEMPÈRE, J.

1889. 'Diatomées fossiles du Japon. Espèces marines & nouvelles des calcaires argileux de Sendai & de Yedo. Mém'. *Soc. Phys. Hist. Nat. Genève*, vol. 30, pp.1–75, pls. 1–9.

CASTRACANE, F.

1875. 'Contribuzione alla florula delle Diatomee del Mediterraneo'. *Atti del'Acad. Pont. Nuov. Linc.*, vol. 28. Rome.
 1886. *Report on the Diatomaceae collected by H.M.S. "Challenger" during the years 1873–1876. Report on the scientific results of the voyage of H.M.S. "Challenger" during the years 1873–76, under the command of Captain George S. Nares, R.N., F.R.S., and the late Captain Frank Tourle Thompson, R.N. Botany*, vol. 2, pp.1–178, pls. 1–30. London.

CHOLNOKY, B. v.

1929. 'Symbiose zwischen Diatomeen'. *Arch. Protistenk.*, vol. 66, pp.523–530, 4figs.

CLEVE, P. T.

- 1873a. 'Examination of diatoms found on the surface of the Sea of Java'. *Bih. Kongl. Svensk. Vet.-Akad. Handl.*, vol. 1, no.11, pp.1–13, pls. 1–3.
 1873b. 'On diatoms from the Arctic Sea'. *Ibid.*, no.13, pp.1–28, pls. 1–4.
 1878. 'Diatoms from the West Indian Archipelago'. *Ibid.*, vol. 5, no. 8, pp.1–22, pls. 1–5.

1881. 'On some new and little known diatoms'. *Kongl. Svensk. Vet.-Akad. Handl.*, vol. 18, no.5, pp.1–28, pls. 1–6.
1883. 'Diatoms collected during the expedition of the "Vega." Vega-Exped'. *Vetensk. Arbet. Iakttag.*, vol. 3, pp.457–517, pls. 35–38.
1889. 'Pelagiske Diatomeer från Kattegat. Det Videnskabelige Udbytte af Kanonbaaden "Hauch's" Togter i de danske Have. Part I'. Copenhagen.
1891. 'Remarques sur le genre *Amphiprora*'. *Le Diatomiste*, vol. 1, pp.51–54.
1894. 'Planktonundersökningar. Cilioflagellater og Diatomaceer'. *Bih. Kongl. Svensk. Vet.-Akad. Handl.*, vol. 20, pt.3, no.2. Stockholm.
- 1894–95. 'Synopsis of the Naviculoid diatoms. Part I'. *Kongl. Svensk. Vet.-Akad. Handl.*, vol. 26, no.2, pp.1–194, pls. 1–5. 1894. Part II. *Ibid.*, vol. 27, no.3, pp.1–219, pls. 1–4. 1895. Stockholm.
- 1896a. 'Diatoms from Baffins Bay and Davis Strait, collected by M. E. Nilsson'. *Bih. Kongl. Svensk. Vet.-Akad. Handl.*, vol. 22, pt.3, no.4, pp.1–22, pls. 1–2. Stockholm.
- 1896b. 'Planktonundersökningar. Vegetabilisk Plankton'. *Ibid.*, no.5. Stockholm.
- 1897a. 'A treatise on the phytoplankton of the Atlantic and its tributaries and on the periodical changes of the plankton of Skagerak', pp.1–28, pls. 1–4. Upsala.
- 1897b. 'Report on the phytoplankton collected on the expedition of H.M.S. "Research," 1896'. *Fifteenth Ann. Rep. Fish. Board for Scotland*, pt.3, pp.297–304, pl. 8.
- 1900a. 'The plankton of the North Sea, the English Channel, and the Skagerak in 1898'. *Kongl. Svensk. Vet.-Akad. Handl.*, vol. 32, no.8, pp.1–53.
- 1900b. 'Notes on some Atlantic plankton-organisms'. *Ibid.*, vol. 34, no. 1, pp.1–22, pls. 1–8.
- CLEVE, P. T., and GARUNOW, ALBERT
1880. 'Beiträge zur Kenntniss der Arctischen Diatomeen'. *Kongl. Svensk. Vet.-Akad. Handl.*, vol. 17, no.2, pp.1–121, pls. 1–7.
- CLEVE, P. T., and MÖLLER, J. D.
- 1877–82. *Diatoms. Parts I–VI*. Upsala.
- CONGER, P. S.
1925. 'A technique for type mounts of plankton diatoms and other microplankton'. *Jour. Roy. Micr. Soc.*, London, vol. for 1925, pp.43–47, 1fig.
- COOPER, L. H. N.
1933. 'Chemical constituents of biological importance in the English Channel, November, 1930, to January, 1932'. *Mar. Biol. Assn. U.K., Jour.*, vol. 18, pp.677–728.
- CUPP, E. E.
1930. 'Quantitative studies of miscellaneous series of surface catches of marine diatoms and dinoflagellates taken between Seattle and the Canal Zone from 1924 to 1928'. *Trans. Amer. Micr. Soc.*, vol. 49, pp.238–245.
1934. 'Analysis of marine plankton diatom collections taken from the Canal Zone to California during March, 1933'. *Ibid.*, vol. 53, pp.22–29, 1fig.
1937. 'Seasonal distribution and occurrence of marine diatoms and dinoflagellates at Scotch Cap, Alaska'. *Bull. Scripps Inst. Oceanog., Tech. Ser.*, vol. 4, pp.71–100, 7figs.
- CUPP, E. E., and ALLEN, W. E.
1938. 'Plankton diatoms of the Gulf of California obtained by Allan Hancock Pacific expedition of 1937'. *Univ. South. Calif. Press, Allan Hancock Pacific Exped.*, vol. 3, pp.61–99, pls. 4–15.

EHRENBERG, C. G.

1830. 'Organisation, Systematik und Geographisches Verhältniss der Infusions-thierchen'. *Phys. Abh. Akad. Wiss.* Berlin, 1830. 8 pls.
1838. 'Die Infusionsthierchen als vollkommene Organismen. Ein Blick in das tiefere organische Leben der Natur'. *Leipzig, Leopold Voss.* xviii + 548 pp., 65 pls.
1840. 'Ueber die Bildung der Kreidefelsen und des Kreidemergels durch unsichtbare Organismen'. *Phys. Abh. Akad. Wiss.* Berlin, 1838, pp. 59–147, pls. 1–4.
1841. 'Ueber noch jetzt Zahlreich lebende Thierarten der Kreidebildung und den Organismus der Polythalmien'. *Ibid.*, 1839, pp. 1–174, pls. 1–4.
1843. 'Verbreitung und Einfluss des mikroskopischen Lebens in Süd- und Nord-Amerika'. *Ibid.*, 1841, pp. 291–446, pls. 1–4.
- 1845a. 'Mittheilung über zwei neue Lager von Gebirgsmassen aus Infusorien als Meeresabsatz in Nord-Amerika und eine Vergleichung derselben mit den organischen Kreidegebilden in Europa und Afrika'. *Ber. Akad. Wiss.* Berlin, 1844, pp. 57–97.
- 1845b. 'Einige vorläufige Resultate der Untersuchungen der von der Südpolreise des Capitain Ross, so wie von den Herren Schayer und Darwin zugekommenen Materialien über das Verhalten des kleinsten Lebens in den Oceanen und den grössten bisher zugänglichen Tiefen des Weltmeers'. *Ibid.*, pp. 182–207.
- 1845c. 'Untersuchungen über die kleinsten Lebensformen in Quellenlande des Euphrats und Araxes, so wie über eine an neuen Formen sehr reiche marine Tripelbildung von den Bermudainseln'. *Ibid.*, pp. 253–275, pl. 1.
1846. 'Neue Untersuchungen über das kleinste Leben als geologisches Moment'. *Ibid.*, 1845, pp. 53–87.
- 1849a. 'Ueber die in dem Magen eines peruanischen Flussfisches als Speise gefundene mikroskopische Organismen'. *Ibid.*, 1848, pp. 1–5.
- 1849b. 'Passatstaub und Blutregen. Ein grosses organisches unsichtbares Wirken und Leben in der Atmosphäre'. *Phys. Abh. Akad. Wiss.* Berlin, 1847, pp. 269–460, pls. 1–6. (Résumé in Silliman's *Amer. Jour.*, vol. 9, 1850.)
1854. 'Mikrogeologie. Das Erden und Felsen schaffenden Wirken des unsichtbar kleinen selbständigen Lebens auf der Erde'. *Leipzig, Leopold Voss.* Vol. I, text, xxviii + 374 pp. Vol. II, atlas, 31 pp., 40 pls. with explanatory leaves.

FORTI, A.

1922. 'Ricerche su la flora pelagica (fitoplankton) di Quarto dei Mille (Mare Ligure)'. *R. Comit. talass. Ital. Lab. Mar.* di quarto dei Mille Presso Genova, Mem. 97, 248 pp., 13 pls.

FRITSCH, F. E.

1935. 'The structure and reproduction of the Algae. Vol. I, Class IV'. *Bacillariophyceae*, pp. 564–651. New York, The Macmillan Co.; Cambridge, England, The University Press.

GILLAM, A. E., EL RIDI, M. S., and WIMPENNY, R. S.

1939. 'The seasonal variation in biological composition of certain plankton samples from the North Sea in relation to their content of vitamin A, carotenoids, chlorophyll, and total fatty matter'. *Jour. Exper. Biol.*, vol. 16, pp. 71–88, 7 figs.

GOUGH, L. H.

1905. 'Report on the plankton of the English Channel in 1903'. *North Sea Fish. Invest. Comm. Rep. No. 2, South. Area, on Fish. and Hydrog. Invest.* in the North Sea and Adjacent Waters, 1902–03. Rep. No. 2, pp. 325–377, charts 1–16, figs. 1–7.

GRAN, H. H.

1897. 'Protophyta: Diatomaceae, Silicoflagellata og Cilioflagellata'. *Den Norske Nordhavs-Expedition 1876–1878*, vol. 24, pp. 1–36, pls. 1–4. Christiania. (Text in both Norwegian and English.)
1900. 'Bemerkungen über einige plankton Diatomeen. Nyt Mag. Naturvid.', vol. 38, pp. 103–126. Christiania.
1904. 'Die Diatomeen der arktischen Meere. I. Teil: Die Diatomeen des Planktons'. *Fauna Arctica. Deutsch. Exped. Nörd. Eismeer im Jahre 1898*, vol. 3, pp. 511–554, pl. 17, 6 figs. Jena.
1905. "'Diatomeen" in Brandt und Apstein, Nordisches Plankton, Botanischer Teil', vol. 19, pp. 1–146, 178 figs. Kiel und Leipzig, Lipsius und Tischer.
1912. 'Pelagic plant life'. Chapter vi (pp. 307–386) in "The Depths of the Ocean," by Sir John Murray and Dr. Johan Hjort. London, Macmillan & Co., Ltd. xx + 821 pp.
1915. 'The plankton production of the North European waters in the spring of 1911'. *Conseil Perm. Internat. Explor. de la Mer, Bull. Planktonique pour l'année 1912*. Copenhagen.
1929. 'Investigation of the production of plankton outside the Romsdals-fjord, 1926–1927'. *Conseil Perm. Internat. Explor. de la Mer, Rapp. et Proc.-Verb.*, vol. 56, 112 pp.
1930. 'The spring growth of the plankton at MØre in 1928–29 and at Lofoten in 1929 in relation to its limiting factors'. *Norsk. Videnskaps-Akad. Oslo, Skrifter*, no. 5. Oslo.
1931. 'On the conditions for the production of plankton in the sea'. *Conseil Perm. Internat. Explor. de la Mer, Rapp. et Proc.-Verb.*, vol. 75, pp. 37–46.
1933. 'Studies on the biology and chemistry of the Gulf of Maine. II. Distribution of phytoplankton in August, 1932'. *Biol. Bull.*, vol. 64, pp. 159–182.

GRAN, H. H., and ANGST, E. C.

1931. 'Plankton diatoms of Puget Sound'. *Publ. Puget Sound Biol. Sta., Univ. Wash.*, vol. 7, pp. 417–519, 95 figs.

GRAN, H. H., and YENDO, K.

1914. 'Japanese Diatoms. I. On *Chaetoceras*. II. On *Stephanopyxis*'. *Vidensk. Skrifter. I. Mat.-Naturv. Kl.* 1913, no. 8, pp. 1–29, 16 figs. Christiania.

GRAY, S. F.

1821. 'A natural arrangement of British plants according to their relations to each other'. London, Printed for Baldwin, Cradock and Joy. 2 vols. Diatomaceae, vol. 1, pp. 293–295.

GREGORY, W.

- 1856–57. 'On the post-tertiary diatomaceous sand of Glenshira. Part II. Containing an account of a number of additional undescribed species'. *Trans. Micr. Soc.* London, N.S., vol. 4, pp. 35–48, pl. 5, 1856; vol. 5, pp. 67–88, pl. 1, 1857.
1857. 'On new forms of marine Diatomaceae, found in the Firth of Clyde and in Loch Fyne, illustrated by numerous figures drawn by R. K. Greville, LL.D., F.R.S.E'. *Trans. Roy. Soc. Edinburgh*, vol. 21, pp. 473–542, pls. 9–14.

GREVILLE, R. K.

1859. 'Descriptions of Diatomaceae observed in Californian guano'. *Trans. Bot. Soc. Edinburgh*, vol. 6, pl. 5; and *Quart. Jour. Micr. Sci.*, vol. 7, pp. 155–166, pls. 7–8.
- 1865a. 'Descriptions of new and rare diatoms. Ser. XIV–XVII'. *Trans. Micr. Soc.* London, N.S., vol. 13, pp. 1–10, 24–34, 43–75, 97–105, pls. 1–6 and 8–9.
- 1865b. 'Descriptions of new genera and species of diatoms from Hongkong'. *Ann. Mag. Nat. Hist.*, Ser. III, vol. 16, pp. 1–7, pl. 5.

1866. 'Descriptions of new and rare diatoms. Ser. XVIII–XX'. *Trans. Micr. Soc.* London, N.S., vol. 14, pp. 1–9, 77–86, 121–130, pls. 1, 2, 8, 9, 11, and 12.

GROSS, F.

1937. 'The life history of some marine plankton diatoms'. *Phil. Trans. Roy. Soc.*, London, B, vol. 228, pp. 1–47.
- 1940a. 'The development of isolated resting spores into auxospores in *Ditylum brightwelli* (West)'. *Mar. Biol. Assn. U.K., Jour.*, vol. 24, pp. 375–380, 2 figs.
- 1940b. 'The osmotic relations of the plankton diatom *Ditylum brightwelli* (West)'. *Ibid.*, pp. 381–415, 22 figs.

GRUNOW, ALBERT

1863. 'Ueber einige neue und ungenügend bekannte Arten und Gattungen von Diatomaceen'. *Verh. Zool.-Bot. Ges. Wien*, vol. 13, pp. 137–162, pls. 4–5.
1867. 'Reise seiner Majestät Fregatte "Novara" um die Erde'. *Botanischer Theil*, vol. 1, Algen. 104 pp., 11 pls.
1878. 'Algen und Diatomaceen aus dem Kaspischen Meere. In Dr. O. Schneider's Naturwissen'. *Beitr. zur Kenntniss der Kaukasusländer, auf Grund seiner Sammelbeute*. Dresden. 160 pp., 5 pls.
1881. 'Ueber die Arten der Gattung *Grammatophora* mit Bezug auf die Tafeln LIII und LIII B, in Van Heurck's Synopsis der belgischen Diatomeen'. *Beil. Bot. Centralbl.*, vol. 7, pp. 1–15.
1884. 'Die Diatomeen von Franz Josefs-Land'. *Denkschr. Kais. Akad. Wissensch. Math.-Naturw. Kl.*, vol. 48, pp. 53–112, pls. 1–5. Wien.

HAECKEL, E.

1890. 'Planktonstudien'. *Jena*. (English translation in Rep. U.S. Fish. Comm., 1893. For 1889–1891.)

HARVEY, H. W.

1926. 'Nitrate in the sea'. *I. Mar. Biol. Assn. U.K., Jour.*, vol. 14, pp. 71–88.
1928. 'Nitrate in the sea. II'. *Ibid.*, vol. 15, pp. 183–190.
1933. 'On the rate of diatom growth'. *Ibid.*, vol. 19, pp. 253–276, 3 figs.
- 1934a. 'Measurement of phytoplankton populations'. *Ibid.*, pp. 761–773.
- 1934b. 'Annual variation of planktonic vegetation, 1933'. *Ibid.*, pp. 775–792, 5 figs.
1937. 'The supply of iron to diatoms'. *Ibid.*, vol. 22, pp. 205–219.
1939. 'Substances controlling the growth of a diatom'. *Ibid.*, vol. 23, pp. 499–520.
1940. 'Nitrogen and phosphorus required for the growth of phytoplankton'. *Ibid.*, vol. 24, pp. 115–123, 2 figs.

HARVEY, H. W., COOPER, L. H. N., LEBOUR, M. V., and RUSSELL, F. S.

1935. 'Plankton production and its control'. *Mar. Biol. Assn. U.K., Jour.*, vol. 20, pp. 407–441, 16 figs.

HASSALL, A. H.

1845. 'A history of the British freshwater algae, including descriptions of the Desmidiaceae and Diatomaceae with upwards of one hundred plates illustrating the various species. London'. *Diatomaceae: vol. 1*, pp. 395–439; vol. 2, pp. 21–24, pls. 93–102.
1855. 'The Diatomaceae in the water supplied to the inhabitants of London'. *Microscopic examination of the water*. London.

HENSEN, V.

1887. 'Ueber die Bestimmung des Plankton. 5. Bericht der Kommission zur wissenschaftlichen Untersuchung der deutschen Meere bei Kiel für die Jahre 1882–86'. Kiel.

HERDMAN, W. A.

1923. 'Founders of oceanography'. London, Edward Arnold & Co. 340 pp.

HOLMAN, R. M., and ROBBINS, W. W.

1939. *A textbook of general botany*. 4th ed. New York, John Wiley & Sons, Inc. xvii + 664 pp.

HUSTEDT, F.

1930–37. 'Die Kieselalgen Deutschlands, Oesterreichs und der Schweiz mit Berücksichtigung der übrigen Länder Europas sowie der angrenzenden Meeresgebiete. Vol. 7 in Dr. L. Rabenhorst's Kryptogamen-Flora von Deutschland, Oesterreich und der Schweiz'. *Leipzig. Part I*, secs. 1–5, 1930, xii + 920 pp., 542 figs. *Part II*, 1931—(not yet completed): sec. 1, 1931, pp. 1–176, figs. 543–682; sec. 2, 1932, pp. 177–320, figs. 683–780; sec. 3, 1933, pp. 321–432, figs. 781–880; sec. 4, 1933, pp. 433–576, figs. 881–1008; sec. 5, 1937, pp. 577–736, figs. 1009–1105.

IKARI, JIRO

1927. 'On *Bacteriastrum* of Japan'. *Bot. Mag.* Tokyo, vol. 41, no. 486, pp. 421–432, 9 figs.

JOHNSTONE, JAMES

1908. *Conditions of life in the sea*. Cambridge, Cambridge University Press. xiv + 332 pp., frontispiece (chart), 31 figs.

JØRGENSEN, E.

1905. 'Hydrographical and biological investigations in Norwegian fiords by O. Nordgaard'. The protist plankton of northern Norwegian fiords (winter and spring, 1899, 1900), pls. 6–18; and diatoms in bottom samples from Lofoten and Vesteraalen by E. Jørgensen. *Bergens Museums Skrifter* 7, 1905. 225 pp. Bergen.

KARSTEN, GEORGE

1901. 'Ueber farblose Diatomeen'. *Flora*, vol. 89.

1905. 'Das Phytoplankton des Antarktischen Meeres nach dem Material der deutschen Tiefsee-Expedition, 1898–1899'. *Wissenschaftliche Ergebnisse der deutschen Tiefsee-Expedition auf dem Dampfer "Valdivia," 1898–1899*, vol. 2, pt. 2, pp. 1–136, pls. 1–19.

1906. 'Das Phytoplankton des Atlantischen Oceans nach dem Material der deutschen Tiefsee-Expedition, 1898–1899'. *Ibid.*, pp. 137–220, pls. 20–34 (1–15).

1907. 'Das Indische Phytoplankton nach dem Material der deutschen Tiefsee-Expedition, 1898–1899'. *Ibid.*, pp. 221–548, pls. 35–54 (1–20), 5 figs.

1928. 'Abteilung Bacillariophyta (Diatomeae)'. In *Engler und Prantl, Die Natürlichen Pflanzenfamilien*, vol. 2. 2ded. Pp. 105–303, 329 figs.

KITTON, F.

1869. *Notes on New York diatoms with descriptions of a new species, Fragilaria crotonensis Kitt. Sci. Gossip*, vol. 5, p. 109, 3 figs.

KOHL, F. G.

1902. 'Untersuchungen über das Carotin und seine physiologische Bedeutung in den Pflanzen'. *Leipzig*. 165 pp.

1906. 'Die Farbstoffe der Diatomeen-Chromatophoren'. *Ber. Deutsch. Bot. Ges.*, vol. 24, pp. 124–134.

KÜTZING, F. T.

1844. 'Die kieselchaligen Bacillarien oder Diatomeen'. Nordhausen, W. Köhne. 152 pp., 29 pls. 2ded., Nordhausen, 1865.

1849. 'Species algarum'. Lipsiae, F. A. Brockhaus. vi + 922 pp.

LAUDER, H. S.

1864. 'Remarks on the marine Diatomaceae found at Hong Kong, with descriptions of new species'. *Trans. Micr. Soc.* London, N.S., vol. 12, pp. 75–79, pl. 8.

LAUTERBORN, ROBERT

1896. 'Untersuchungen über Bau, Kernteilung, und Bewegung der Diatomeen'. *Leipzig, Wilhelm Engelmann*. 165 pp., 150 figs.

LE BLANC, RENÉE

1935. 'Sur quelques *Chaetoceros* de l'Etang de Thau. Acad. Sci., C.R.', vol. 201, pp. 1139–1140, 6 figs. Paris.

LEBOUR, M. V.

1921. 'The food of young clupeoids'. *Mar. Biol. Assn. U.K., Jour.*, vol. 12, pp. 458–467.
 1922. 'The food of plankton organisms'. *Ibid.*, pp. 644–677.
 1923. 'The food of plankton organisms. II'. *Ibid.*, vol. 13, pp. 70–92.
 1930. 'The planktonic diatoms of northern seas'. London, printed for the Ray Society. ix + 244 pp., 181 figs., 4 pls.

LEUDUGER-FORTMOREL, G.

1892. 'Diatomées de la Malaisie'. *Ann. Jard. Bot. Buitenzorg*, vol. 11, pp. 1–60, pls. 1–7.

LIEBISCH, W.

1928. '*Amphitetras antediluviana* Ehrbg., sowie einige Beiträge zum Bau und zur Entwicklung der Diatomeenzelle. Zeitschr. Bot.', vol. 20, pp. 225–271.
 1929. 'Experimentelle und kritische Untersuchungen über die Pektinmembran der Diatomeen, usw'. *Ibid.*, vol. 22, pp. 1–65.

LINNÉ, C. V.

1788. *Systema naturae*. Ed.13. Vol. 6.

LOHMANN, H.

1911. 'Ueber das Nannoplankton und die Zentrifugierung kleinster Wasserproben zur Gewinnung desselben im lebenden Zustande'. *Internat. Revue Gesamten Hydrobiologie*, vol. 4, pp. 1–38.

LUCAS, C. C., and HUTCHINSON, A. H.

1927. 'A bio-hydrographical investigation of the sea adjacent to the Fraser River mouth'. *Trans. Roy. Soc. Canada*, vol. 21, pt. 2, sec. 5, 520 pp., 37 figs., 5 pls.

LYNGBYE, H. C.

1819. 'Tentamen hydrophytologiae danicae, continens omnia hydrophyta cryptogama Daniae, Holsatiae, Faeroae, Islandiae, Groenlandiae hucusque cognita, systematice disposita, descripta et iconibus illustrata, adjectis simul speciebus norvegicis'. *Hafniae, Typis Schultzianis*. xxxii + 248 pp., 70 col. pls.

MANGIN, L.

1908. 'Observations sur les Diatomées'. *Ann. Sci. Nat., Bot. IX*, vol. 8, pp. 177–219. Also in Acad. Sci., C.R., vol. 146, pp. 770–773. Paris.

1910. 'Sur quelques algues nouvelles ou peu eonnues du Phytoplankton de l'Atlantique'. *Bull. Soc. Bot. France*, vol. 57. Paris.

1917. 'Sur le *Chaetoceros criophilus* Castr., espèce caractéristique des mers antarctiques'. *Acad. Sci., C.R.*, vol. 164, pp. 704–709, 4 figs. Paris.

MANN, ALBERT

1905. 'Diatoms, the jewels of the plant world'. *Smithson. Miscell. Collection (vol. 48)*. Vol. 3, Quarterly Issue, pt. 1, pp. 50–58, pls. 22–25.

1907. 'Report on the diatoms of the "Albatross" voyages in the Pacific Ocean, 1888–1904'. *Contrib. U.S. Nat. Herb.*, vol. 10, pt. 5, pp. 220–419, pls. 44–54. *Smithson. Inst., U.S. Nat. Mus. Washington*.

1922. 'Suggestions for collecting and preparing diatoms'. *Proc. U.S. Nat. Mus.*, no. 2410, vol. 60, art. 15, pp. 1–8.

MARSHALL, S. M., and ORR, A. P.

1927. 'The relation of the plankton to some chemical and physical factors in the Clyde Sea area'. *Mar. Biol. Assn. U.K., Jour.*, vol. 14, pp. 837–868, 9 figs., 10 pls.

1930. 'A study of the spring diatom increase in Loch Striven'. *Ibid.*, vol. 16, pp. 853–878, 15 figs.

MERESCHKOWSKY, C.

1901. 'Etudes sur l'endochrome des Diatomées'. *Mém. Acad. Imp. St. Pétersb.*, sér. 8, vol. 11.

MEUNIER, A.

1910. 'Microplankton des Mers de Barents et de Kara. Duc d'Orléans, Campagne Arctique de 1907'. *Brussels*. 2 vols. Text, 355 pp.; Atlas, 36 pls. with explanatory leaves.

1913. 'Microplankton de la Mer Flamande. Ire Partie: Le genre *Chaetoceros* Ehrh'. *Mém. Mus. R. Hist. Nat. Belgique*, vol. 7, pp. 1–55, pls. 1–7. Brussels.

MEYER, A.

1904. 'Orientierende Untersuchungen über Verbreitung, Morphologie und Chemie des Volutins'. *Bot. Zeit.*, vol. 62.

MILLS, F. W.

1933–34. 'An index to the genera and species of the Diatomaceae and their synonyms. 1816–1932'. London, Wheldon & Wesley, Ltd. 3 vols. 1726 pp.

MOBERG, E. G.

1928. 'The interrelation between diatoms, their chemical environment, and upwelling water in the sea, off the coast of southern California'. *Proc. Nat. Acad. Sci.*, vol. 14, pp. 511–518.

MOLISCH, H.

1905. 'Ueber den braunen Farbstoff der Phaeophyceen und Diatomeen'. *Bot. Zeit.*, vol. 63, pp. 131–144.

MÜLLER, O. F.

1783. 'Strand-parlebandet och Armbandet, tvanne, Microscopiska Strand-växter'. *Kongl. Vet. Acad. Handl.*, vol. 4, pp. 80–85. Stockholm.

NÄGELI, CARL

1849. 'Die neueren Algen-systeme und Versuch zur Begründung eines eigenen Systems der Algen und Florideen'. Zürich.

NATHANSOHN, ALEXANDER

1906. 'Ueber die Bedeutung vertikaler Wasserwebungen für die Produktion des Planktons im Meere'. *Abh. Math.-Phys. Klasse Königl. Sächsischen Gess. Wiss.*, vol. 29, pp. 355–441.

NEBELUNG, HANS

1878. 'Spektroskopische Untersuchungen der Farbstoffe einiger Süßwasser-algen'. *Bot. Zeit.*, vol. 36, pp. 369–382, 385–399, 401–423.

NELSON, E. W.

1920. 'On the occurrence of diatoms on the skin of whales. (*Cocconeis ceticola*.)' *Proc. Roy. Soc. Bot.*, vol. 91, p. 210.

O'MEARA, E.

1871. 'On some new species of the genus *Amphiprora*'. *Quart. Jour. Micr. Sci., N.S.*, vol. 11, p. 21, pl. 1.

OSTENFELD, C. H.

1899. 'Plankton in 1898. Iagttagelser over Overfladevandets Temperatur, Saltholdighed og Plankton paa islandske og grölandske Skibrouter i 1898, udgivne af Martin Knudsen og C'. Ostenfeld. Copenhagen.
1901. 'Phytoplankton fra det Kaspide Hav'. *Vidensk. Meddel. naturh. Foren.*, pp. 129–139. Copenhagen.
1902. 'Marine plankton diatoms'. *Johs. Schmidt: Flora of Koh Chang. Part 7.* (Reprinted from *Botanisk Tidsskrift*, vol. 25, pp. 1–49.) Copenhagen.
1903. 'Phytoplankton from the sea around the Faeroes. Botany of the Faeroes', vol. 2. Copenhagen.

PALMER, L. S.

1922. *Carotinoids and related pigments. The chromolipoids.* American Chemical Society Monograph Series. New York, The Chemical Catalog Co., Inc. 316 pp.

PASCHER, A.

1914. 'Ueber Flagellaten und Algen'. *Ber. Deutsch. Bot. Ges.*, vol. 32, pp. 136–160, 430.
1921. 'Ueber die Uebereinstimmung zwischen den Diatomeen, Heterokonten und Chrysomonaden'. *Ibid.*, vol. 39, pp. 236–248.
1931. 'Systematische Uebersicht über die mit Flagellaten in Zusammenhang stehenden Algenreihen, usw'. *Beih. Bot. Centralbl.*, vol. 48, pp. 317–332.

PAVILLARD, J.

1911. 'Observations sur les Diatomées'. *Bull. Soc. Bot. France*, vol. 58, pp. 21–29, 2 figs. Paris.
1913. 'Observations sur les Diatomées, 2e série'. *Ibid.*, vol. 60, pp. 126–133, 2 figs.
- 1916a. 'Recherches sur les Diatomées pélagiques du Golfe du Lion. Travail de l'Institut de Botanique de l'Université de Montpellier et de la Station Zoologique de Cette'. *Série Mixte. Mém.* no. 5. 63 pp., 2 pls.
- 1916b. 'Flagellés nouveaux, épiphytes des Diatomées pélagiques'. *Acad. Sci., C.R.*, vol. 163, pp. 65–68.
1925. *Bacillariales. Report on the Danish Oceanographical Expeditions 1908–10 to the Mediterranean and Adjacent Seas. Vol. 2, Biology, J. 4.* 72 pp., 116 figs.

PÉRAGALLO, H.

1888. 'Diatomées de la baie de Villefranche (Alpes-Maritimes)'. *Bull. Soc. Hist. Nat. Toulouse*, vol. 22, pp. 13–100, pls. 1–6. (Reprinted under the title of "Diatomées du Midi de la France," pp. 1–100, pls. 1–6. Toulouse, 1888.)
1892. 'Monographie du *Rhizosolenia* et de quelques genres voisins'. *Le Diatomiste*, vol. 1, pp. 79–82, 99–117, pls. 13–15, 17–18. Paris.

PÉRAGALLO, H. and M.

- 1897–1908. 'Diatomées marines de France et des districts maritimes voisins'. M. J. Tempère, *Grez-sur-Loing*. 540 pp.; Atlas, 137 pls.

PHIFER, L. D.

1933. 'Seasonal distribution and occurrence of planktonic diatoms at Friday Harbor, Washington'. *Univ. Wash. Publ. Oceanog.*, vol. 1, pp. 39–81.

PRITCHARD, ANDREW

1861. 'A history of Infusoria, including the Desmidiaceae and Diatomaceae, British and foreign'. London, Whittaker & Co. Ed.1, 1842. Reprinted in 1845 and 1849 (1849 reprint was called ed. 2). Ed. 4, enlarged and revised, 1861. xii + 968 pp., 40 pls.

QUEKETT, JOHN

1848. *A practical treatise on the microscope.* London.

RALFS, JOHN

1864. 'Remarks on the marine Diatomaceae found at Hong Kong, with descriptions of new species. By Henry Scott Lauder, Assistant-Surgeon, Royal Navy; with notes by J. Ralfs', *Esq. Trans. Micr. Soc.* London, N.S., vol. 12, pp. 75–79, pl. 8.

ROPER, F. C. S.

1858. 'Notes on some new species and varieties of British marine Diatomaceae'. *Quart. Jour. Micr. Sci.*, vol. 6, pp. 17–25, pl. 3.

SCHMIDT, ADOLF

1874. 'Die in den Grundproben der Nordseefahrt vom 21. Juli bis 9 Sept. 1872, enthaltenen Diatomaceen'. *Jahresber. Komm. Untersuch. deutsch. Meere in Kiel, Jahre 1872–73*, vol. 2, pp. 81–96, pls. 1–3. Berlin.
- 1875–82. 'Atlas der Diatomaceenkunde, in Verbindung mit den Herren Grundler, Grunow, Janisch, Weissflog und Witt, herausgegeben von Adolf Schmidt, archidiaconus in Aschersleben'. *Aschersleben, Ernst Schlegel*. Heft 1–36, 144 pls.
- 1885–1937. 'Atlas der Diatomaceenkunde. First three series reissued in 1885'. *Zweite revidirte Auflage*. Last plate issued to date, pl. 416, in August, 1937, by F. Hustedt, Heft 104.

SCHNEIDER, OSCAR

1878. 'Naturwissenschaftliche Beiträge zur Kenntniss der Kaukasusländer, auf Grund seiner Sammelbeute'. Dresden, E. Blockmann und Sohn. 160 pp., 5 pls.

SCHREIBER, E.

1927. 'Die Reinkultur von marinem Phytoplankton und deren Bedeutung für die Erforschung der Produktionsfähigkeit des Meerwassers'. *Wiss. Meeresunters., Abt. Helgoland, N.F.*, vol. 16, pp. 1–34.

SCHRÖDER, BRUNO

1900. 'Das Phytoplankton des Golfes von Neapel'. *Mitt. Zool. Sta. Neapel*, vol. 14. Berlin.
1906. 'Beiträge zur Kenntnis der Phytoplanktons warmer Meere'. *Vierteljahrsschr. naturforsch. Ges. Zürich*, vol. 51, pp. 319–377, 46 figs.

SCHULTZE, M. S.

1858. 'Innere Bewegungserscheinungen bei Diatomeen der Nordsee aus den Gattungen *Coscinodiscus*, *Denticella*, *Rhizosolenia*'. *Müller's Archiv Anat., Phys. u. wissenschaft. Med.*, 1858, p. 330, pl. 13. Translation: Phenomena of internal movements in Diatomaceae of the North Sea, belonging to the genera *Coscinodiscus*, *Denticella*, and *Rhizosolenia*. *Quart. Jour. Micr. Sci.*, N.S., vol. 7, pp. 13–21, pl. 2. 1859.

SCHÜTT, F.

1893. 'Das Pflanzenleben der Hochsee'. Kiel und Leipzig.
1895. 'Arten von *Chaetoceras* und *Peragallia*. Ein Beitrag zur Hochseeflora'. *Ber. Deutsch. Bot. Ges.*, vol. 13, pp. 35–48, pls. 4–5.
1896. 'Bacillariales (Diatomeae)'. In *Engler und Prantl, Die Natürlichen Pflanzenfamilien*. 1sted. I. Teil. 1. Abteilung b., Bacillariales, pp. 31–150.

SHADBOLT, GEORGE

1854. 'A short description of some new forms of Diatomaceae from Port Natal'. *Trans. Micr. Soc.* London, N.S., vol. 2, pp. 13–18, pl. 1.

SHRUBSOLE, W. H.

1890. 'On a new diatom from the estuary of the Thames'. *Jour. Quek. Micr. Club*, ser. 2, vol. 4, pp. 259–262, pl. 13.

SMITH, WILLIAM

1852. *Notes on the Diatomaceae; with descriptions of British species included in the genus Pleurosigma*. *Ann. Mag. Nat. Hist., Ser. II*, vol. 9, pp. 1–12, pls. 1–2.

1853–56. 'A synopsis of the British Diatomaceae; with remarks on their structure, functions and distribution; and instructions for collecting and preserving specimens'. Plates by Tuffen West. London, Smith and Beck. Vol. I, xxxiv + 89 pp., 31 pls., 1853. Vol. II, xxx + 107 pp., pls. 32–42, A-E, 1856.

TAMMES, TINE

1900. 'Ueber die Verbreitung des Carotins im Pflanzenreiche'. *Flora*, vol. 87, pp. 205–247.

TAYLOR, F. B.

1929. 'Notes on diatoms. An introduction to the study of the Diatomaceae'. *Bournemouth*, England. 269 pp.

TURPIN, P. J. F.

1828. 'Observations sur le nouveau genre *Surirella*'. *Mém. Mus. Hist. Nat.*, vol. 16, pp. 361–368, pl. 15.

VAN HEUROK, HENRI

1880–85. 'Synopsis des Diatomées de Belgique'. *Anvers. Edité par l'auteur*. 2 vols., text and atlas. Atlas, 132 pls. with descriptive leaves and 3 supplementary pls., 1880–1881. Table alphabétique des noms génériques et spécifiques et des Synonymes contenus dans l'Atlas, 120 pp., 1884. Texte, 235 pp., 1885.

1896. 'A treatise on the Diatomaceae'. Translated by Wynne E. Baxter. London, Printed by W. E. Baxter, Ltd. Pp. xx + 559, 35 pls., 291 text figs.

WALLICH, G. C.

1860. 'On the siliceous organisms found in the digestive cavities of Salpae, and their relation to the flint nodules of the chalk formation'. *Trans. Micr. Soc.* London, N.S., vol. 8, pp. 36–55, pl. 2.

WEST, G. S.

1916. 'Bacillarieae (Diatoms)'. In "*Algae*," Vol. I. *Cambridge Botanical Handbooks*. Cambridge, University Press. Pp. 83–125.

WEST, G. S., and FRITSCH, F. E.

1927. *A treatise on the British freshwater Algae*. Cambridge, University Press.

WEST, TUFFEN

1860. 'Remarks on some Diatomaceae, new or imperfectly described, and a new desmid'. *Trans. Micr. Soc.* London, N.S., vol. 8, pp. 147–153, pl. 7.

WOLLE, F.

1894. 'Diatomaceae of North America, illustrated with twenty-three hundred figures from the author's drawings on one hundred and twelve plates'. *Bethlehem, Pa.*, The Comenius Press. Pp. i-xiii + 15–47, 112 pls. with explanatory leaves.

ZOBELL, C. E.

1935. 'The assimilation of ammonium nitrogen by *Nitzschia closterium* and other marine phytoplankton'. *Proc. Nat. Acad. Sci.*, vol. 21, pp. 517–522.

ZOPF, WILHELM

1900. 'Ueber das Polycystin, ein krystallisirendes Carotin aus *Polycystis flos aquae* Witttr'. *Ber. Deutsch. Bot. Ges.*, vol. 18, pp. 461–467.

EXPLANATION OF PLATES

[Short line below each figure represents the measurement of
10 microns. All photographs by the author.]

PLATE 1

Fig. 1. *Coscinodiscus excentricus* Ehr. Diameter, 67 μ .

Fig. 2. *Coscinodiscus curvatulus* Grun. Diameter, 53 μ .

Fig. 3. *Coscinodiscus marginatus* Ehr.

a. Entire valve. Low magnification. Diameter, 53 μ .

b. Same cell as in (*a*) more highly magnified to show structure.
Note poroid outer closing membrane.

c. Focus slightly lower than in (*b*). Note arrangement of areolae.

d. Focus lower than in (*c*) to show structure of margin.

Fig. 4. *Coscinodiscus radiatus* Ehr. Diameter, 47 μ .

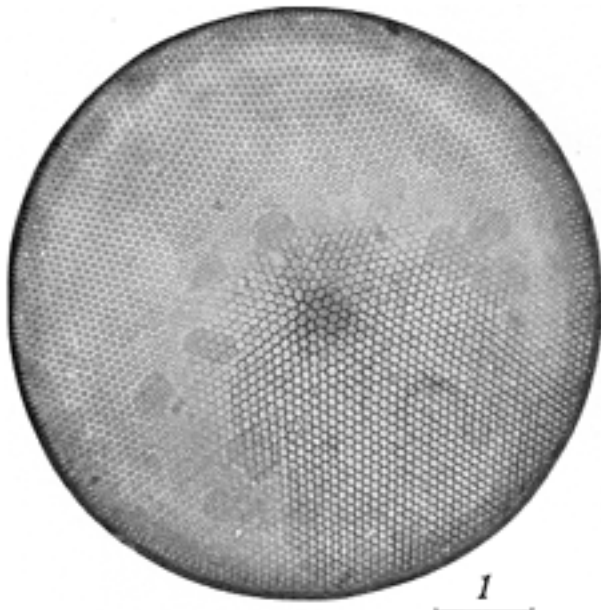

1

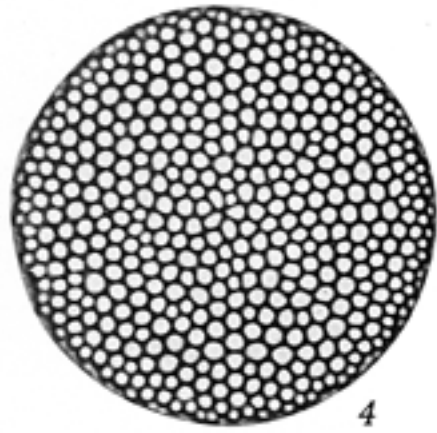

4

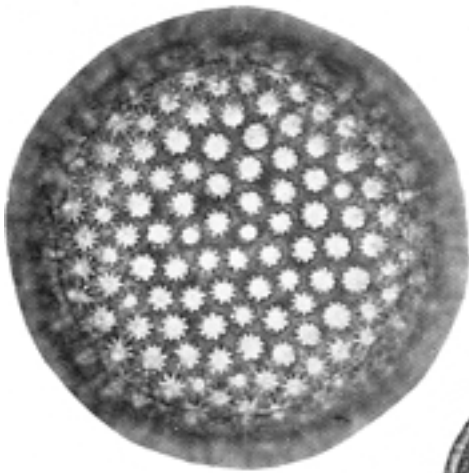

3 b

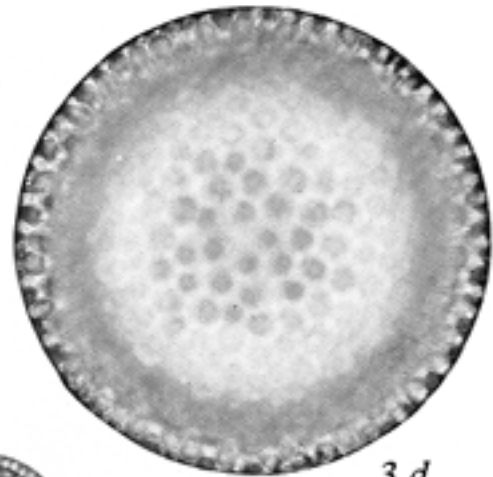

3 d

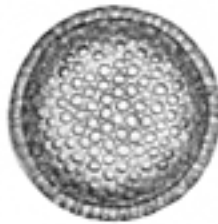

3 a

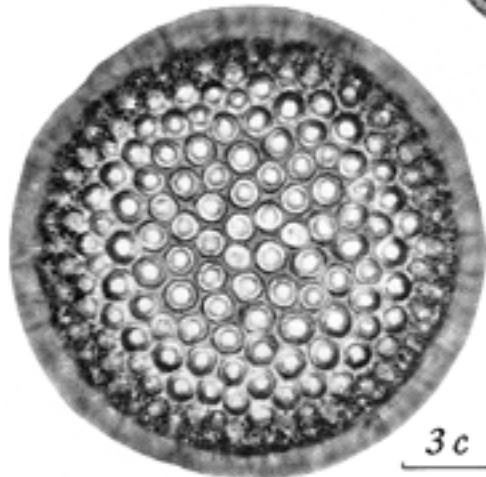

3 c

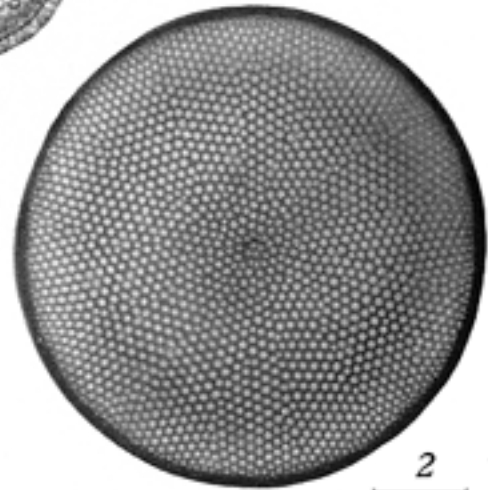

2

PLATE 2

Coscinodiscus centralis var. *pacifica* Gran and Angst

Fig. 1. Entire valve. Diameter, 260 μ .

Fig. 2. Section of valve more highly magnified to show arrangement of areolae.

Fig. 3. Center rosette. Note poroid outer membrane.

Fig. 4. Section of valve near margin. Note poroid outer membrane.

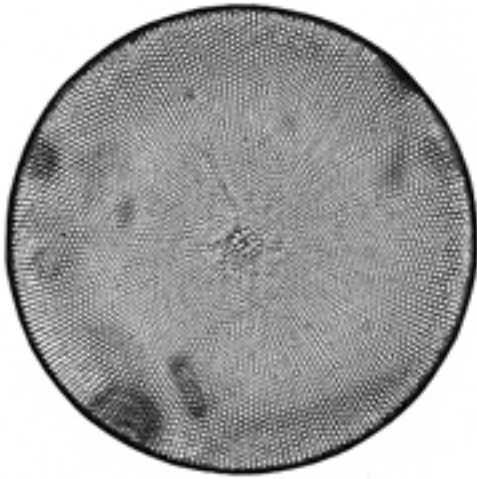

1

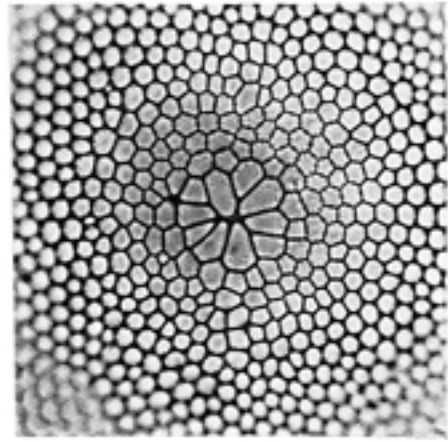

3

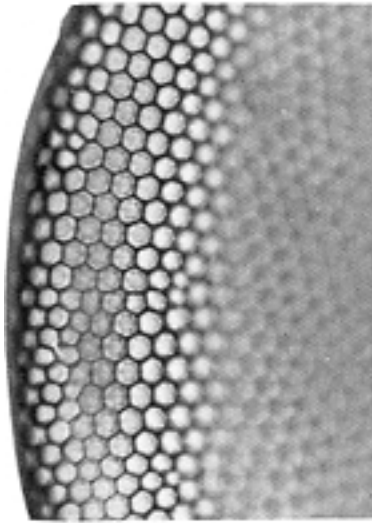

4

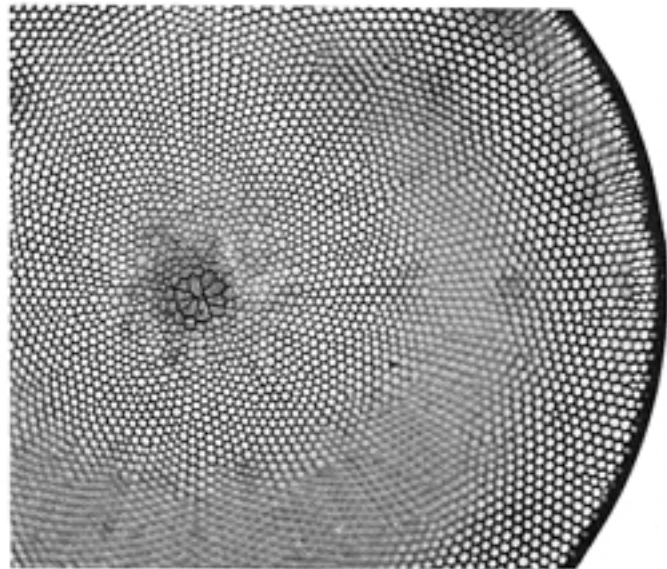

2

PLATE 3

Fig. 1. *Coscinodiscus perforatus* var. *cellulosa* Grun.

a. Entire valve. Diameter, 95μ .

b. Section of valve more highly magnified to show arrangement of areolae.

Note poroid outer membrane and interstitial meshes.

Fig. 2. *Coscinodiscus oculus iridis* Ehr.

a. Entire valve. Diameter, 138μ

b. Center of valve more highly magnified.

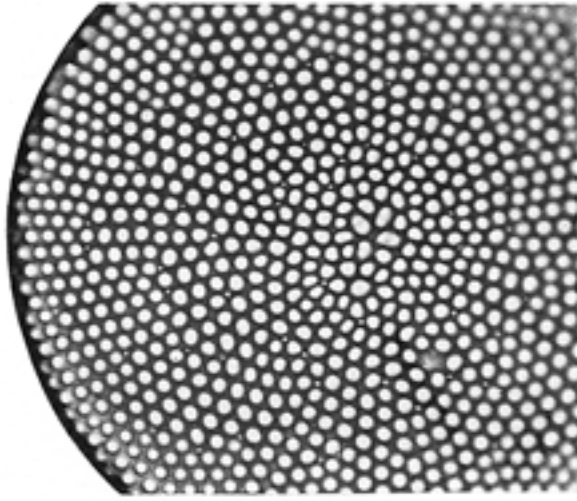

1 b

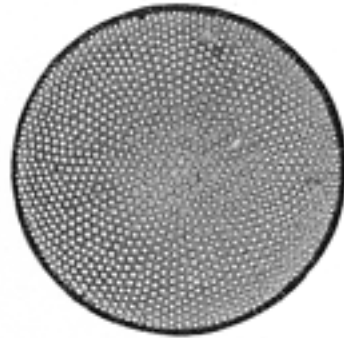

1 a

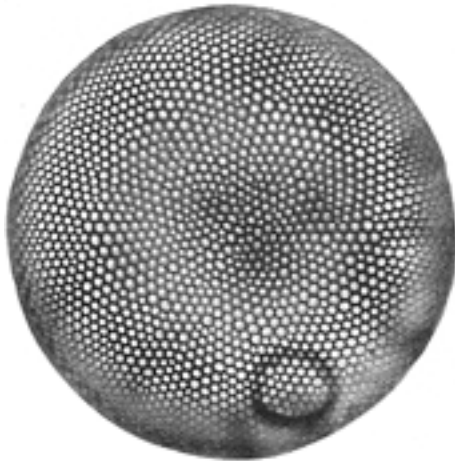

2 a

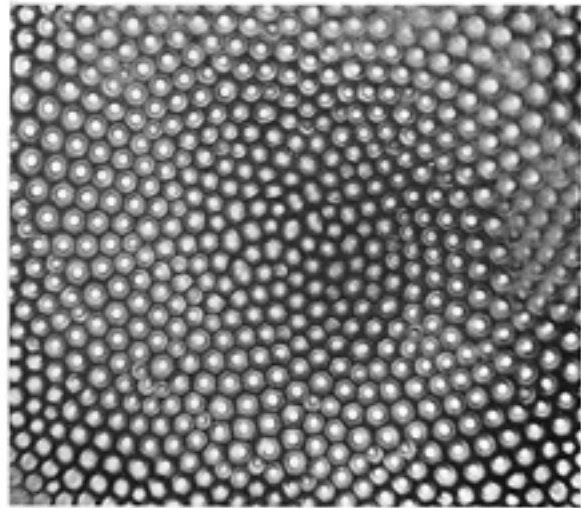

2 b

PLATE 4

Fig. 1. *Arachnoidiscus ehrenbergii* Bail

a. Entire valve. Diameter, 390μ .

b. Section of same cell more highly magnified. Inner side of valve.

Fig. 2. *Aulacodiscus kittoni* Arn.

a. Entire valve. Diameter, 70μ .

b. Same valve as in (a) more highly magnified.

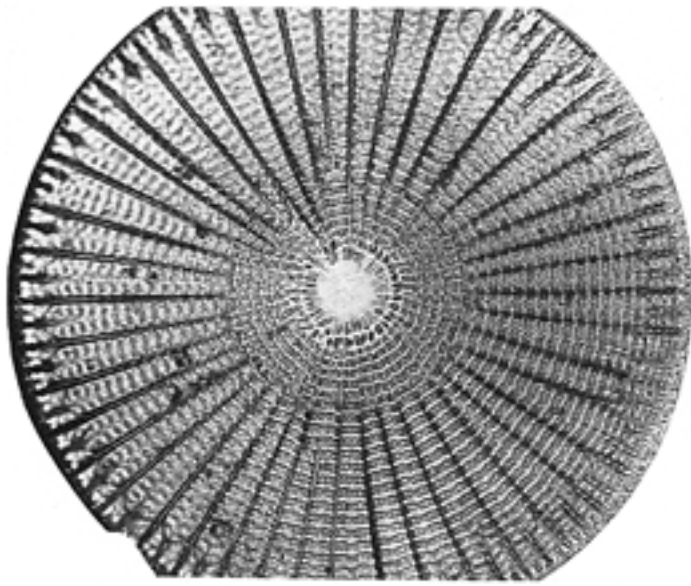

1b



1a

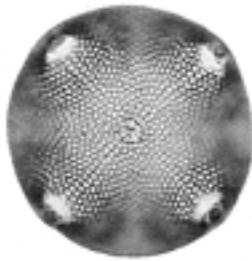

2a

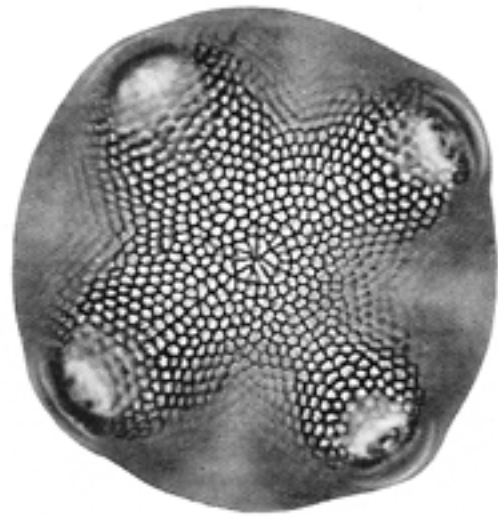

2b

PLATE 5

Fig. 1. *Actinoptychus undulatus* (Bail.) Ralfs

a and *b*. Same valve with opposite sets of sectors in focus. In (*a*) note processes at center of margin of sectors in focus. Diameter, 58 μ .

Fig. 2. *Actinoptychus splendens* (Shad.) Ralfs

a. Entire valve. Diameter, 85 μ . Focused to show hyaline bracket-shaped region near margin of alternate sectors.

b. Section of same valve. Same focus as in (*a*) but more highly magnified.

c. Same valve. Focused to show hyaline line running from spatulate process toward inner end of alternate sectors.

d. Same focus as in (*c*) but more highly magnified.



1a

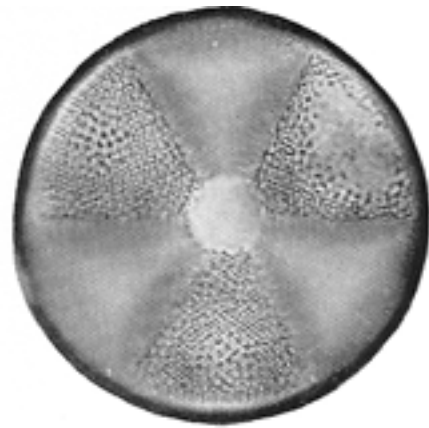

1b



2a

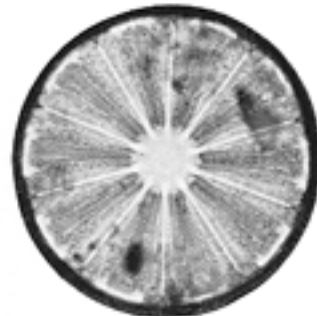

2c

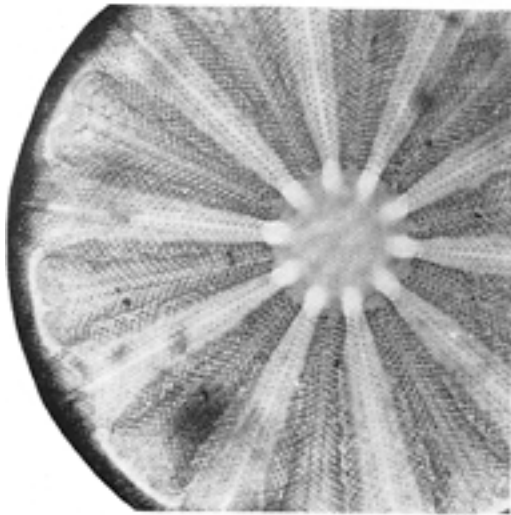

2b

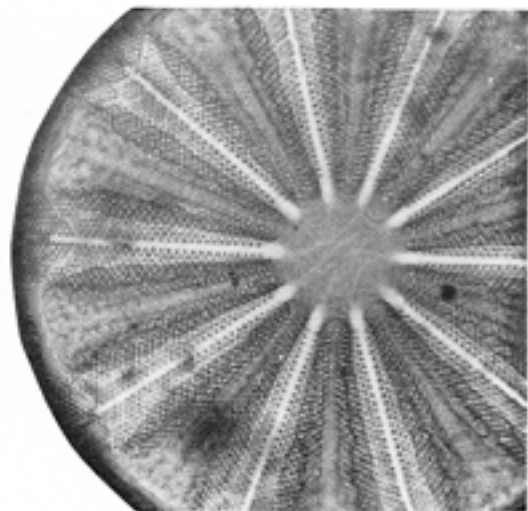

2d

INDEX TO GENERA AND SPECIES

- Achnanthes* Bory, 191
longipes Ag. (fig. 141), 192
- Actinoptychus* Ehr., 66
splendens (Shad.) Ralfs (fig. 30; pl. 5, fig. 2), 67
undulatus (Bail.) Ralfs (fig. 29; pl. 5, fig. 1), 67
- Amphiprora* (Ehr.) Cl., 197
gigantea var. *sulcata* (O'M.) Cl. (fig. 151), 198
- Arachnoidiscus* Ehr., 65
ehrenbergii Bail. (fig. 28; pl. 4, fig. 1), 66
- Asterionella* Has., 188
japonica Cl. (fig. 138), 188
kariana Grun. (fig. 139), 190
- Asterolampra* Ehr., 68
marylandica Ehr. (fig. 31), 68
- Asteromphalus* Ehr., 68
heptactis (Bréb.) Ralfs (fig. 32), 69
- Aulacodiscus* Ehr., 69
kittoni Arn. (fig. 33; pl. 4, fig. 2), 70
- Bacteriastrum* Shad., 95
comosum Pav. (fig. 58), 99
delicatulum Cl. (fig. 55), 96
elongatum Cl. (fig. 57), 99
hyalinum Laud. (fig. 56-A), 96
hyalinum var. *princeps* (Castr.) Ikari (fig. 56-B), 98
- Biddulphia* Grun, 151
alternans (Bail.) V.H. (fig. 115), 166
aurita (Lyng.) Bréb. and God. (figs. 112-A(1);, 112-A(2), 112-A(3)), 161
aurita var. *obtusata* (Kütz.) Hust. (fig. 112-B), 162
dubia (Brightw.) Cl. (fig. 114), 164
longicurris Grev. (figs. 111-A(1), 111-A(2), 111-A(3)), 154
longicurris var. *hyalina* (Schröd.) Cupp (figs. 111-B(1), 111-B(2), 111-B(3)), 157
mobiliensis Bail. (fig. 110), 153
pulachella Gray (fig. 109), 152
rhombus (Ehr.) W. Sm. (fig. 113), 163
- Campylosira* Gray., 180
cymbelliformis (A. Schm.) Grun. (fig. 130), 180
- Cerataulina* H. Pér., 167
bergonii H. Pér. (fig. 117), 167
- Chaetoceros* Ehr., 100
affinis Laud. (figs. 78-A(1), 78-A (2)), 125
affinis var. *circinalis* (Meun.) Hust. (fig. 78-B), 126
affinis var. *willei* (Gran) Hust. (fig. 78-C), 126
anastomosans Grun. (fig. 96), 140
atlanticus Cl. (fig. 59-A), 103
atlanticus from *audax* (Schütt) Gran (fig. 59-B, a), 103
atlanticus var. *neapolitana* (Schröd.) Hust. (fig. 59-B, d, e), 104
atlanticus var. *skeleton* (Schütt) Hust. (fig. 59-B, b, c), 104
brevis Schütt (fig. 82), 129
cinctus Gran (fig. 98), 142
coarctatus Laud. (fig. 62), 107
compressus Laud. (fig. 74), 119
concavicornis Mang. (fig. 66, a-c), 109
concavicornis form *volans* (Schütt) Hust. (fig. 66, d), 110
constrictus Gran (fig. 76), 122
convolutus Castr. (fig. 67), 110
costatus Pav. (fig. 79), 127
curvisetus Cl. (fig. 93), 137
dadayi Pav. (fig. 64), 109
danicus Cl. (fig. 65), 109
debilis Cl. (fig. 95), 138
decipiens Cl. (figs. 70-A, 70-B, a, b), 115
decipiens form *singularis* Gran (fig. 70-B, c, d), 117
dichaeta Ehr. (fig. 60), 106
didymus Ehr. (fig. 75-A), 121
didymus var. *anglica* (Grun.) Gran (fig. 75-B, b, c), 122
didymus var. *protuberans* (Laud.) Gran and Yendo (fig. 75-B, a), 121
difficilis Cl. (fig. 86), 132
diversus Cl. (fig. 87), 132
eibonii Grun. (fig. 61), 106
gracilis Schütt (fig. 101), 143
holsaticus Schütt (fig. 85), 131
lacinosus Schütt (fig. 80), 128
laevis Leud-Fort. (fig. 88), 133
lauderi Ralfs (fig. 73), 118
lorenzianus Grun. (fig. 71), 118
messanensis Castr. (figs. 89-A, 89-B), 133
pelagius Cl. (fig. 81), 129
pendulus Karst. (fig. 69), 114
perpusillus Cl. (fig. 92), 137
peruvianus Brightw. (fig. 68, a-c), 113

- Chaetoceros* Ehr.
peruvianus form *gracilis* (Schröd.) Hust. (fig. 68, d-f), 114
pseudocurvisetus Mang. (fig. 94), 138
radicans Schütt (fig. 97), 141
seiracanthus Gran (fig. 84), 131
similis Cl. (fig. 90), 135
socialis Laud. (fig. 100), 143
subsecundus (Grun.) Hust. (fig. 83), 130
teres Cl. (fig. 72), 118
tetrastichon Cl. (fig. 63), 108
tortissimus Gran (fig. 99), 142
vanheurcki Gran (fig. 77), 123
vistulae Apstein (fig. 102), 144
wighami Brightw. (fig. 91), 136
- Climacodium* Grun., 146
frauenfeldianum Grun. (fig. 105), 147
- Climacosphenia* Ehr., 177
moniligera Ehr. (fig. 128), 178
- Corethron* Castr., 70
hystrix Hen. (figs. 34-A, 34-B, 34-C), 70
- Coscinodiscus* Ehr., 49
centralis var. *pacifica* Gran and Angst (fig. 24; pl. 2), 60
concinus W. Sm. (fig. 22), 58
curvatus Grun. (fig. 17; pl. 1, fig. 2), 55
excentricus Ehr. (fig. 14; pl. 1, fig. 1), 52
granii Gough (fig. 21), 56
lineatus Ehr. (fig. 15), 53
marginatus Ehr. (fig. 19; pl. 1, fig. 3), 55
nitidus Greg. (fig. 18), 55
oculus iridis Ehr. (fig. 26; pl. 3, fig. 2), 62
perforatus var. *cellulosa* Grun. (fig. 25-A; pl. 3, fig. 1), 61
perforatus var. *pavillardi* (Forti) Hust. (fig. 25-B), 62
radiatus Ehr. (fig. 20; pl. 1, fig. 4), 56
stellaris Rop. (fig. 16), 53
wailesii Gran and Angst (fig. 23), 58
- Coscosira* Gran, 44
polychorda Gran (fig. 7), 44
- Dactyliosolen* Castr., 76
antarcticus Castr. (fig. 37), 76
mediterraneus H. Pér. (fig. 38), 77
- Ditylum* Bail., 148
brightwellii (west) Grun. (figs. 107-A, 107-B), 148
- Eucampia* Ehr., 145
cornuta (Cl.) Grun. (fig. 104), 146
zodiacus Ehr. (fig. 103), 145
- Fragilaria* Lyng., 180
crotonensis Kit. (fig. 131), 181
- Grammatophora* Ehr., 173
angulosa Ehr. (fig. 124), 174
marina (Lyng.) Kütz. (fig. 125-A), 174
marina var. *adriatica* Grun. (fig. 125-B), 174
oceanica (Ehr.) Grun. (fig. 126), 176
- Guinardia* H. Pér., 78
flaccida (Castr.) H. Pér. (fig. 40), 78
- Gyrosigma* Has., 194
spencerii (Quek.) Cl. (fig. 144), 194
- Hemiaulus* Ehr., 168
hauckii Grun. (fig. 118), 168
membranaceus Cl. (fig. 120), 170
sinensis Grev. (fig. 119), 168
- Hemidiscus* Wall., 170
cuneiformis var. *ventricosa* (Castr.) Hust. (fig. 121), 170
- Isthmia* Ag., 166
nervosa Kütz. (fig. 116), 166
- Lauderia* Cl., 74
borealis Gran (fig. 35), 74
- Leptocylindrus* Cl., 77
danicus Cl. (fig. 39), 78
- Licmophora* Ag., 176
abbreviata Ag. (fig. 127), 177
- Lithodesmium* Ehr., 150
undulatum Ehr. (fig. 108), 150
- Melosira* Ag., 39
moniliformis (Müll.) Ag. (fig. 1), 39
sulcata (Ehr.) Kütz. (fig. 2), 40
- Navicula* Bory, 192
distans (W.Sm.) Ralfs (fig. 143), 193
membranacea Cl. (fig. 142), 193
- Nitzschia* Has., 199
bilobata var. *minor* Grun. (fig. 152), 200
closterium (Ehr.) W. Sm. (fig. 153), 200
delicatissima Cl. (fig. 158), 204
longissima (Bréb.) Ralfs (fig. 154), 200
pacifica Cupp (fig. 157), 204
paradoxa (Gmel.) Grun. (fig. 159), 206
pungens var. *atlantica* Cl. (fig. 156), 202
seriata Cl. (fig. 155), 201
- Plagiogramma* Grev., 179
vanheurckii Grun. (fig. 129), 180
- Planktoniella* Schütt, 63
sol (Wall.) Schütt (fig. 27), 63

- Pleurosigma* W. Sm., 194
elongatum W. Sm. (fig. 147), 196
hamuliferum Brun and Temp. (fig. 146), 195
nicobaricum Grun. (fig. 145), 195
normanii Ralfs (fig. 148), 196
- Pseudoeunotia* Grun., 190
doliolus (Wall.) Grun. (fig. 140), 190
- Rhizosolenia* (Ehr.) Brightw., 79
acuminata (H. Pér.) Gran (fig. 53), 94
alata Brightw. (fig. 52-A), 90
alata from **curvirostris** Gran (fig. 52-D), 93
alata form **gracillima** (Cl.) Grun. (fig. 52-B), 92
alata form **indica** (H Pér.) Osten. (fig. 52-C), 93
alata form *inermis* (Castr.) Hust. (fig. 52-E), 94
bergonii H. Pér. (fig. 43), 81
calcar avis M. Schultze (fig. 51), 89
castracanei H. Pér. (fig. 54), 94
cylindrus Cl. (fig. 42), 80
delicatula Cl. (fig. 44), 83
fragilissima Berg. (fig. 41), 80
hebetata form *hiemalis* Gran (fig. 50-A), 88
hebetata form *semispina* (Hen.) Gran (fig. 50-B), 88
imbricata var. *shrubslei* (Cl.) Schröd. (fig. 47), 84
robusta Norm. (fig. 46), 83
setigera Brightw. (fig. 49), 88
stolterfothii H. Pér. (fig. 45), 83
styliformis Brightw. (fig. 48-A), 87
styliformis var. *longispina* Hust. (fig. 48-B), 87
- Schröderella* Pav., 75
delicatula (H.Pér.) Pav. (fig. 36), 76
- Skeletonema* Grev., 43
costatum (Grev.) Cl. (fig. 6), 43
- Stephanopyxis* Ehr., 40
nipponica Gran and Yendo (fig. 5), 43
palmeriana (Grev.) Grun. (fig. 4), 40
turris (Grev. and Arn.) Ralfs (fig. 3), 40
- Streptotheca* Shrub., 147
thamensis Shrub. (fig. 106), 147
- Striatella* Ag., 172
delicatula (Kütz.) Grun. (fig. 123), 173
unipunctata (Lyng.) Ag. (fig. 122), 173
- Surirella* Turp., 207
fastuosa var. *recedens* (A. Schm.) Cl. (fig. 160), 208
- Synedra* Ehr., 181
undulata Bail. (fig. 132), 181
- Thalassionema* Grun., 182
nitzschioides Grun. (fig. 133), 182
- Thalassiosira* Cl., 45
aestivalis Gran and Angst (fig. 9), 47
decipiens (Grun.) Jørg. (fig. 10), 48
gravida Cl. (fig. 11), 48
nordenskiöldii Cl. (fig. 8), 46
rotula Meun. (fig. 12), 49
subtilis (Osten.) Gran (fig. 13), 49
- Thalassiothrix* Cl. and Grun., 183
delicatula Cupp (fig. 137), 188
frauenfeldii Grun. (fig. 135), 184
longissima Cl. and Grun. (fig. 134), 184
mediterranea var. *pacifica* Cupp (fig. 136), 185
- Tropidoneis* Cl., 197
antarctica var. *polyplasta* Gran and Angst (fig. 150), 197
lepidoptera (Greg.) Cl. (fig. 149), 197