SUN, WIND, AND COMFORT

A Study of Open Spaces and Sidewalks in Four Downtown Areas

**Peter Bosselmann
Juan Flores
William Gray
Thomas Priestley
Robin Anderson**

Environmental Simulation Laboratory

**Edward Arens
Peter Dowty
Stanley So
Jong-Jin Kim**

Building Technology Laboratory

**Institute of Urban and Regional Development
College of Environmental Design
University of California, Berkeley**

Acknowledgements

We would like to thank the staff of the San Francisco Planning Department and its director Dean Macris for giving us the opportunity to conduct this study. In particular, we would like to acknowledge George Williams for his continued support for our work. We would also like to thank the San Francisco Planning Commission and its president, Toby Rosenblatt, for encouraging us to continue with the analysis of building impacts on pedestrian comfort.

We want to acknowledge the support and sponsorship of the American Institute of Architects, the San Francisco Planning and Urban Research Association (SPUR), the North of Market Planning Coalition, the Chinatown Neighborhood Improvement Association, and Jeffrey Heller of Heller and Leak architects.

We also want to recognize Terry O'Hare, a former member of the Simulation Laboratory staff, for the critical role he played in developing the project proposal.

Our thanks to Kevin Gilson for the design of this report and for the photographs, most of which he took especially for this study. We also thank Carl A. Wilmington, who provided us with the aerial photos.

Special thanks are due to Laurie Mason who volunteered hours of her own time to help build the foam model required for the wind tunnel studies. Eleanor Lee helped with organizing the many wind tunnel tests. Susan Merriman spent many hours helping with the layout of the maps and text. Dorit Frann compiled the hundreds of pages of computer printout into a manageable appendix. Many thanks go to Lynne Charlot and Tony Brock of the Institute of Urban and Regional Development for administering the project and to Nancy Albert, Liz Prince and Ann Rizzolo for their assistance with word processing.

Table of Contents

		Chinatown	34
		Area Description	34
		Development Assumptions	40
SUMMARY	4	Wind Effects	42
		Comfort Results	50
INTRODUCTION	8	Tenderloin	58
		Area Description	58
		Development Assumptions	64
SUN, WIND AND COMFORT IN THE URBAN ENVIRONMENT	10	Wind Effects	66
		Comfort Results	74
Sun in the Urban Environment	12	Van Ness	82
Winds in San Francisco	16	Area Description	82
Wind in the Urban Environment	19	Development Assumptions	86
		Wind Effects	88
		Comfort Results	92
METHODOLOGY	24	South of Market	96
Selection of Study Areas	25	Area Description	96
		Development Assumptions	102
Area Analysis and Generation of Future Development Scenarios	25	Wind Effects	106
		Comfort Results	118
Scenario Testing	27	FINDINGS AND CONCLUSIONS	126
Solar Testing	29	RECOMMENDATIONS	136
Comfort modeling	30	BIBLIOGRAPHY	144
ANALYSIS	32	APPENDIX	147



Summary

This report describes a study by the U.C. Berkeley Environmental Simulation and Building Technology Laboratories of development in downtown San Francisco and its consequences for street level sun, wind, and thermal comfort conditions. The study grew out of San Francisco

residents' increasing concerns about the quality of the downtown environment, and is related to the measures now being considered to implement the San Francisco Downtown Plan.

This study continues the work presented in the Simulation Laboratory's 1983 report, Sun and Light for Downtown San Francisco.

That research concerned itself with the shadowing produced by downtown buildings, and recommended procedures and standards for preserving sunlight on downtown sidewalks and open spaces. This research takes the next steps, considering the effects of buildings on both sun and wind conditions at street level and evaluating the combined effects of these conditions on pedestrian comfort. Rather than considering just the effects of individual buildings, it evaluated the cumulative effects of area-wide development.

Study Procedure

The study procedure was to select four areas at the edge of the existing downtown that are subject to strong pressures for increased development. These areas, Chinatown, the Tenderloin, a portion of the Van Ness Corridor, and the district around the TransBay Terminal (Figure 1) were evaluated to inventory existing conditions and potentials for change. For each area, at least two future scenarios were created: one illustrated continued development under current regulations, and the other illustrated development modified in ways it was assumed would reduce undesirable wind and shadow effects.

Scale models were made of each area under each of the development

conditions and used as the basis for determining wind and shading effects. Wind effects were identified by testing the models in the Building Technology Laboratory's wind tunnel. Shading effects were determined by placing the models under a parallel beam light source that was manipulated to reflect the sun's altitude and bearing angle at varying times of the day and year. To gauge the combined effects of the measured wind and shadow conditions on pedestrian comfort, the wind and shadow data was fed into a computer model that simulates the human thermo-regulatory system. The model considers ambient temperature, humidity, wind velocity, and solar radiation, as well as assumptions about activity level and the amount of clothing worn. The model's product is a figure expressing the percentage of time a particular place would be comfortable for outdoor users during daylight hours.

Report Structure

The report begins with a generalized discussion of sun and wind and their effects on comfort in the urban environment; next, the study method is described, and then, the analysis of the results is presented. The analysis section includes diagrams indicating the wind patterns and street level wind speeds determined by the wind tunnel

testing, as well as maps summarizing each area's comfort evaluations by season, permitting street level comfort conditions to be related to development magnitude, location, and form. The report ends with generalized findings and recommendations. The detailed analysis data is summarized in the appendix.

Key Findings

The very basic observation confirmed by this study is that in San Francisco's cool and windy climate, localized wind conditions and the availability of direct solar radiation play a critical role in determining people's thermal comfort in public open spaces. Although San Francisco has strong winds, they only occasionally produce conditions which are severe enough to create discomfort for pedestrians. For people who want to use park benches, the wind and ambient temperature conditions frequently combine to make it too cool to sit in the shade. However, most of the open spaces studied are well enough sheltered from the wind to make sitting in the sun comfortable under most temperature conditions. This finding suggests the need for standards to preserve sun access for all publicly accessible open spaces, whether they be under the jurisdiction of the Recreation and Parks Department or other public agencies.

A similar emphasis on sunlight preservation is also appropriate for the publicly accessible private open spaces constructed by developers in exchange for increased development rights. Standards that preserve sun access for the dominant times of use need to be developed for these spaces. The findings also suggest the need for standards preserving sun access to sidewalks, where pedestrians stroll as well as sidewalks and alleyways that are used as open space in high density inner city neighborhoods where little park and open space is available.

In addition, the findings suggest the need for standards for controlling adverse wind conditions caused by new construction. At several locations within the areas studied, it was found that buildings possible under existing or proposed development controls could create wind conditions adverse enough to produce comfort problems. These conditions were most common in areas of abrupt height changes facing the predominant wind direction. Frequently, additional development can mitigate such impacts, if it is designed to form a more gradual height transition. The western edge of the downtown core along Kearny Street, as well as the western edge of the hotel district towards the Tenderloin warrant special attention in this regard. Development not

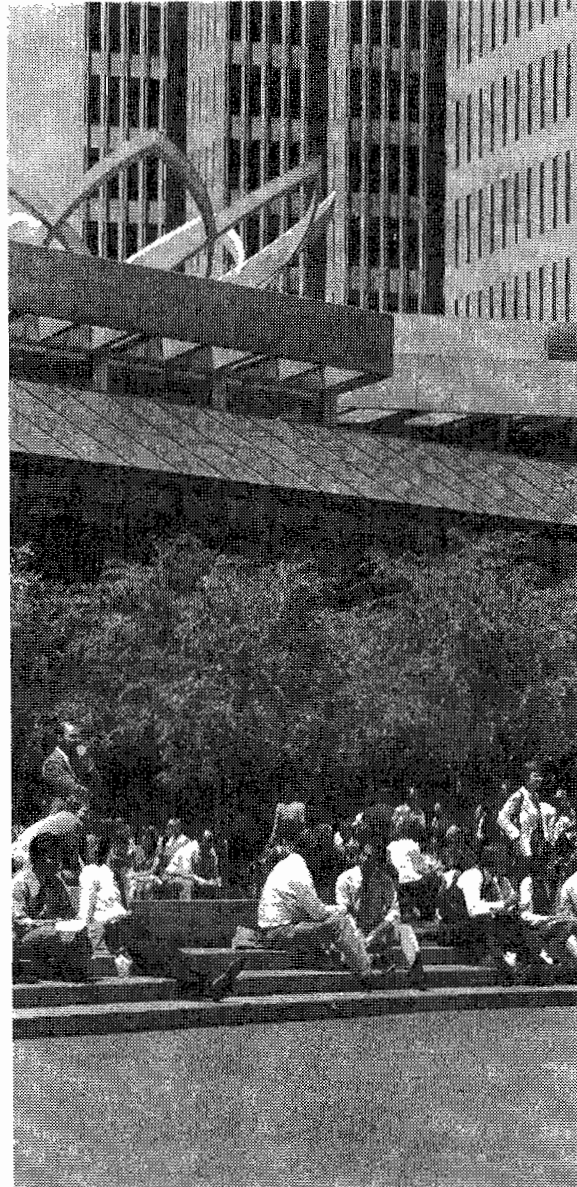

studied in our tests, but in locations with similar conditions would be development possible under the new proposed Rincon Hill Plan as well as under The Yerba Buena Center Plan, along Third Street and Mission Street. Another critical area is the section of Second Street, between Market and Howard, where proposed zoning would permit an abrupt change in height.

At a more detailed level, the study findings suggest that wind conditions caused by building corner flows, downwashes, and wakes are the strongest and most critical wind effects. Designers should therefore consult closely with wind experts during the building design phase and make good faith efforts to mitigate building impacts. More detailed guidelines are illustrated at the end of the report in the findings and conclusion section.

During the last 15 years or so, large amounts of public and private money have been invested in increasing the number and quality of open spaces in downtown San Francisco. This investment reflects the emerging understanding that attractive, usable open spaces providing places to rest, eat, relax and watch play a critical role in maintaining the central district's attractiveness as a place to live, work, shop, and visit. Now, San Francisco's planners and citizens alike are increasingly aware of and concerned about how these spaces are being affected by the shadows and winds produced by large new buildings. This concern has been created by situations like the one at the Bank of America Plaza where a costly open space has been rendered virtually unusable by almost constant shading and frequently gusty windy conditions.

In response, the city's planners and citizens are taking action to insure that downtown parks, plazas, and even sidewalks will be protected from undesirable sun and wind effects. Consideration of sun and wind played an important part in the formulation of San Francisco's new Downtown Plan, released in 1983. In research related to the preparation of the Downtown Plan, the Environmental Simulation Laboratory in 1982 and

1983 evaluated the effects of downtown development patterns on sunlight availability on sidewalks and in open spaces, and developed methods and standards for sunlight preservation. The findings, presented in Sun and Light for Downtown San Francisco published in April, 1983, helped to enrich the discussion of sunlight issues taking place among planners, developers, and the public. This discussion led to Proposition K, a sunlight referendum approved by the city's voters in June, 1984 balloting. The measure mandates preservation of sun access in all parks and other open spaces under the jurisdiction of the Recreation and Parks Department. In the central core area, the new ordinance will protect the Civic Center Plaza; the Father Alfred Boedekker and Sergeant Macaully Parks in the Tenderloin; the Chinese playground, and Portsmouth and St. Mary's Squares in Chinatown; and Union Square, Justin Herman Plaza, and the Embarcadero Parks in the retail and office districts. In addition, several amendments to the city planning code proposed in June, 1984 to implement the provisions of the Downtown Plan also deal with sun access. One would require protection of solar access to public open spaces not under Parks and Recreation's jurisdiction, and to privately owned but publicly accessible space. Another would protect sun access along Market Street and

on major streets in the retail district, in Chinatown and in the South of Market area.

Attention is now turning to control of adverse downtown wind conditions. The amendments proposed to implement the Downtown Plan mandate the reduction of ground level wind currents in C3 Districts. It requires buildings to be shaped or sited in such a way that ground level wind currents do not exceed an 11 mile per hour comfort standard in pedestrian areas more than 10% of the time between 7 a.m. and 6 p.m., and that winds do not exceed a 7 mile per hour standard in outdoor sitting areas more than 10% of the time. When ambient wind speeds already exceed the comfort level, buildings are to be designed to reduce the existing speeds. Under the ordinance, if the developer can prove that the standards cannot be met, the building will be allowed to add no more than 3 miles per hour to the permitted speed. No buildings would be permitted that would cause ground level wind speeds to reach or exceed the hazard level of 26 miles per hour for one hour of the year.

The sun and wind policies that are now under consideration in the Downtown Plan, or that have already been adopted, are an important first step in maintaining downtown San Francisco's outdoor comfort levels. The next step is to develop a more detailed understanding of the combinations of wind and sun conditions

that work for outdoor thermal comfort or discomfort downtown. Then, the cumulative effect of the downtown's potential development changes on those conditions needs to be assessed, and related back to the city's policies to insure that they will complement each other and be effective in the long run in maintaining the outdoor comfort conditions desired. This study's analyses were undertaken with these goals in mind. More specifically, this study was designed to determine whether:

1. downtown San Francisco's continued development under existing policies would affect outdoor comfort conditions in an undesirable way
2. measures designed to optimize sunlight availability would lead to significant improvements in outdoor comfort conditions
3. pedestrian level wind conditions in San Francisco can be significantly improved by modifications in building design.

This study breaks new ground, because to date, there has been no research evaluating the combined effects of sun and wind on outdoor comfort, and no work evaluating the cumulative, district-wide effects of new development on either sun or wind conditions at street level.

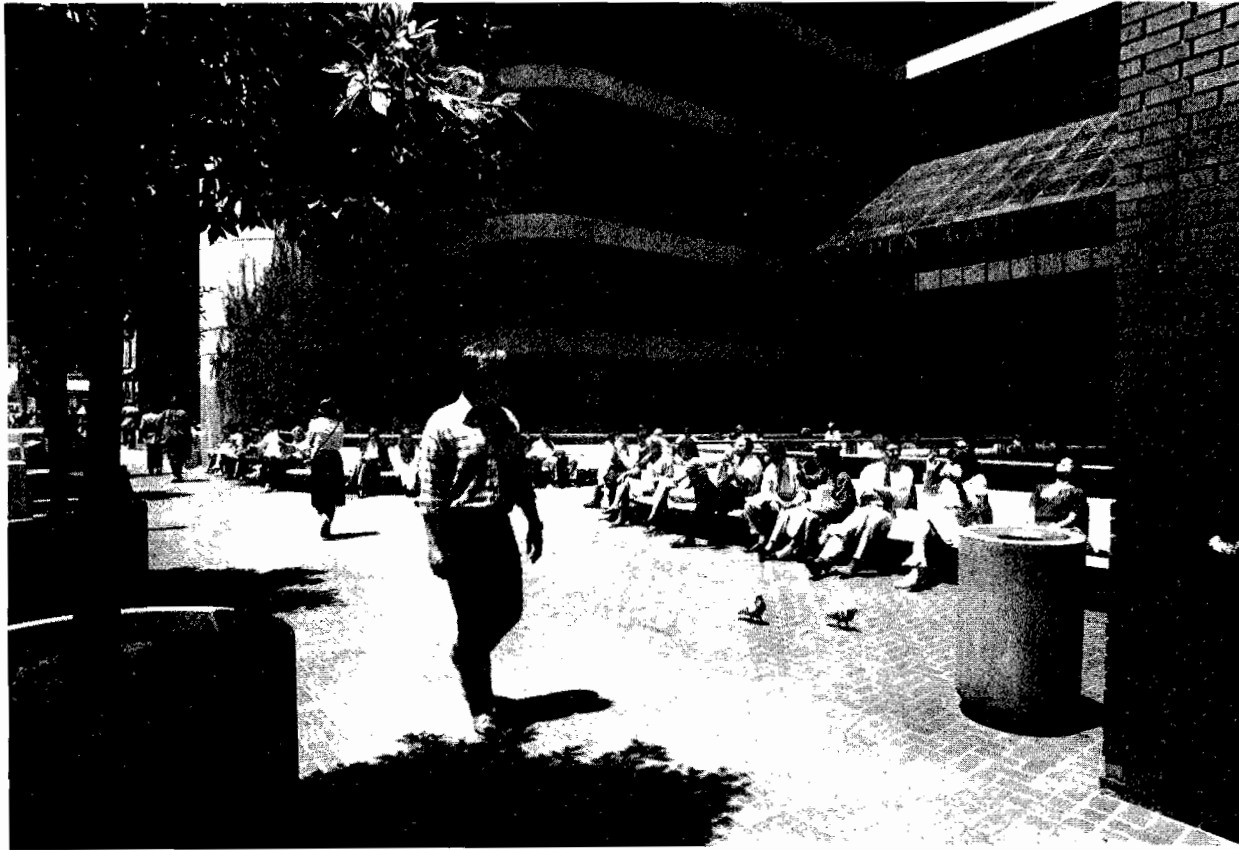

Sun, Wind, and Comfort in the Urban Environment

Sun and wind play a critical role in determining people's sense of comfort outdoors. Sun and wind both influence how warm or cold people feel, and winds, when too

strong, can be a source of annoyance, and even physical harm.

Wind increases cooling by stripping the insulating film of still air that normally builds up around the body and clothing. As a consequence, under windy conditions higher levels of temperature and radiation are required to maintain

Figure 2. Wind Effects

Wind Speed	Effects Observed or Deduced
0	Calm, no noticeable wind Wind felt on face
4.4	Clothing flaps
8.8	Newspaper reading becomes difficult
13.2	Hair disarranged, dust and paper raised, rain and sleet driven
17.6	Control of walking begins to be impaired Violent flapping of clothes, progress into wind slightly slowed
22.0	Umbrella used with difficulty
26.4	Blown sideways, inconvenience felt walking into wind, hair blown straight Difficult to walk steadily, appreciably slowed into wind
30.8	Noise on ears unpleasant Generally impedes progress Almost halted into wind, uncontrolled tottering downwind
35.2	Difficulty with balance in gusts Unbalanced, grabbing at supports
41.8	People blown over in gusts
48.4	Cannot stand

Standard equivalent mean wind speed, in miles per hour.

Source: Edward Arens, Designing for an Acceptable Wind Environment, 1961.

thermal comfort. In addition, low to moderate winds can create discomfort by causing clothing to flap, by raising dust and light debris, and by disarranging hair. Higher winds can make walking difficult, and very high winds can make it difficult for people to keep their balance (Figure 2).

Under windless conditions, when no solar radiation is present, the pedestrian dressed in normal business attire without an overcoat generally requires temperatures in the 70 to 80 degree range to feel comfortable. In Figure 3, the comfort chart prepared by the U.S. Bureau of standards, the lines in the upper half of the chart indicate the temperature levels required to maintain comfort as wind speed increases. The lines in the chart's lower half indicate the cooler temperature levels at which comfort can be maintained with varying levels of solar radiation.

Comfort in San Francisco's Climate

In San Francisco's cool, often breezy climate, sun and wind conditions can have a significant effect on outdoor comfort. As Figure 4 suggests, although air temperatures never get very low, they seldom get very high either. Even in September and October, typically the warmest months in the year, the monthly

average high temperatures remain just outside the 70° - 80° comfort zone range. Average wind speeds at street level range up to over 10 miles per hour, and gusts of over 25 miles per hour are not uncommon. As a consequence, most of the time, people outdoors require direct sunshine and protection from the wind to be comfortable. When direct sunlight is available, San Francisco's solar radiation levels are generally high enough to insure the pedestrian's thermal comfort, just so long as wind speeds are kept at low to moderate levels. This is readily apparent in downtown San Francisco, where on all but the warmest days, parks and plazas that are windswept or in shadow are virtually deserted, while those that offer sunlight and protection from the wind are heavily used.

Because of their shadow effects and impacts on wind flows, the siting and design of large buildings play an important role in the maintenance of street level comfort. It is critical that these effects be thoroughly understood and carefully considered when decisions are made about future development.

Sun in the Urban Environment

Previous work at U.C. Berkeley's Environmental Simulation Laboratory explored the consequences

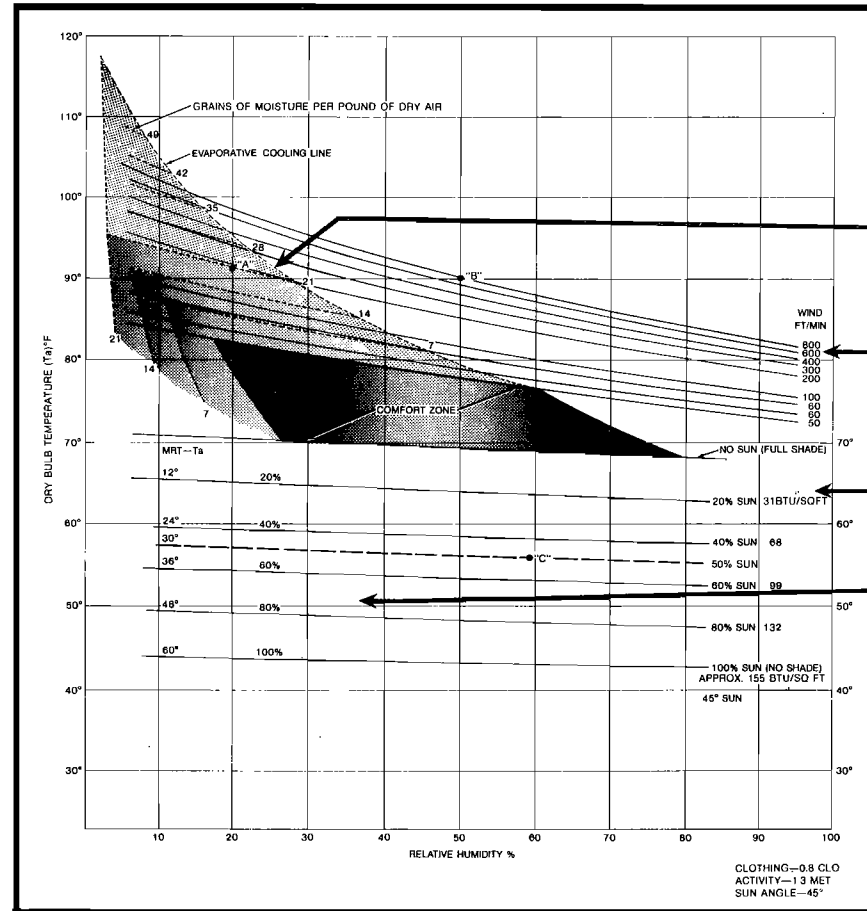

Figure 3. Comfort Chart

The shaded area represents the temperature range required for maintenance of human thermal comfort when no wind or solar radiation is present. The lines above the shaded area indicate the temperatures required to maintain comfort with winds at varying speeds. The lines below the shaded areas indicate the temperatures at which comfort can be maintained when varying levels of radiation are present.

Figure 4. San Francisco Climate

Month	Mean Maximum Temperature ^F	Mean Minimum Temperature ^F	Percent Possible Sunshine	Average Windspeed Miles/Hr.	Prevailing Wind Direction
January	60.0	45.7	56	6.7	north
February	58.9	47.9	62	7.5	west
March	50.1	48.5	69	8.5	west
April	61.2	49.3	73	9.5	west
May	62.5	50.9	72	10.4	west
June	64.5	52.8	73	10.9	west
July	63.8	53.2	66	11.2	west
August	64.8	54.0	65	10.5	west
September	68.8	55.5	72	9.1	west
October	68.2	54.6	70	7.6	west
November	63.2	51.5	62	6.3	west
December	56.8	47.2	53	6.7	north

Source: National Oceanographic and Atmospheric Administration, Technical memorandum NWS-WR-126, 1978.

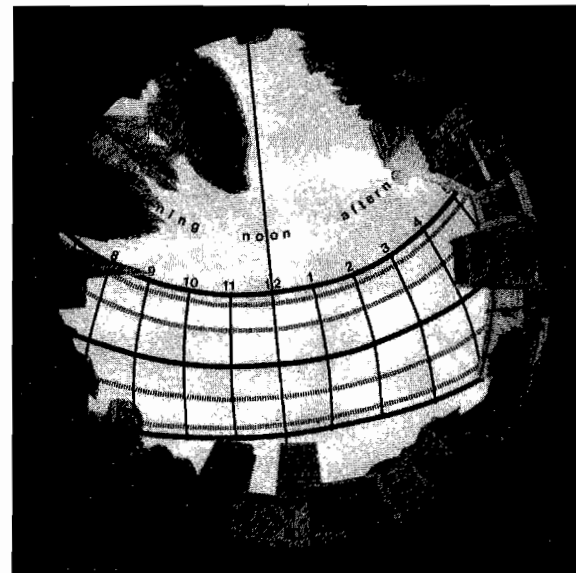

Figure 5. Sun Path Analysis for Clay Street at Portsmouth Square

of downtown development for sunlight availability on sidewalks and other public open spaces, and set out methods and standards for sunlight preservation. That work was presented in Sun and Light for Downtown San Francisco, published in April 1983. The report demonstrates the use of sky exposure studies to determine current patterns of sunlight availability in urban open spaces. The approach makes use of photographs of the sky taken from the ground level at each analysis point using a fish eye lens. By superimposing a diagram displaying the sun's path across the sky on the photograph, it is possible to quickly identify the times of the day and year when sunlight is available at each location. Figure 5 illustrates the use of the technique for evaluating sunlight availability at a point on Portsmouth Square. Such sky exposure studies can also be used to predict the effects of future buildings on sunlight availability at specific points. By superimposing the outlines of proposed buildings on the fish-eye view, it becomes easy to identify the seasons and times of day during which additional shadows will be cast. Figures 6, 7, and 8 demonstrate how sky exposure studies for several points can be linked to provide a picture of sunlight availability patterns in a major downtown space (in this case, Union Square).

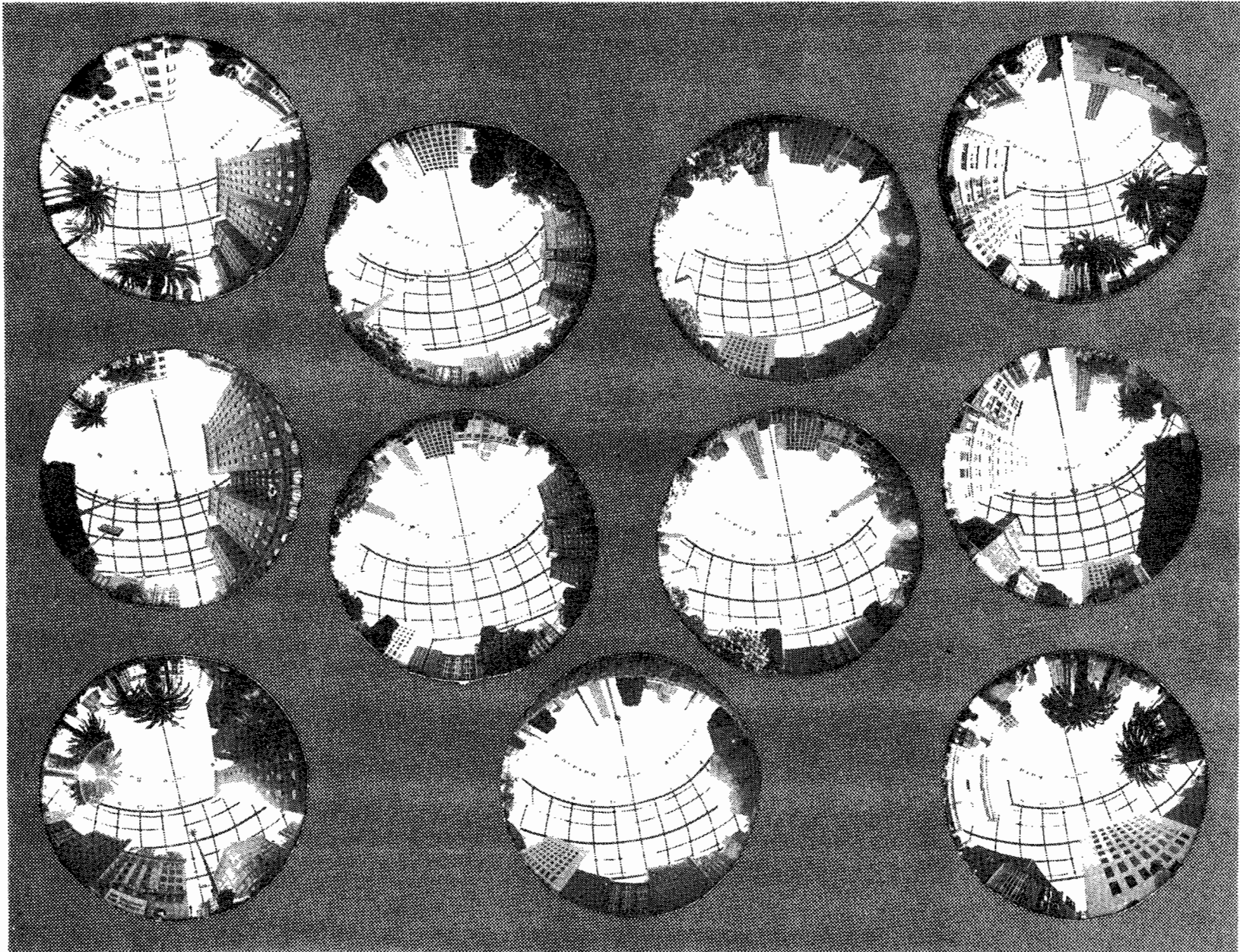

Figure 6. Use of sun path analyses to assess sunlight availability at the Union Square test points.

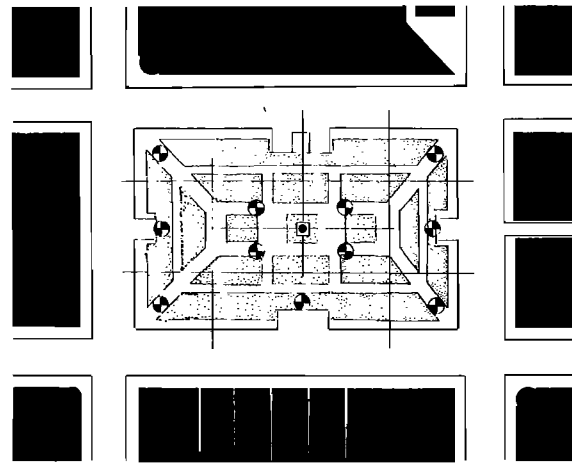

Figure 7. Points selected for solar access analysis on Union Square

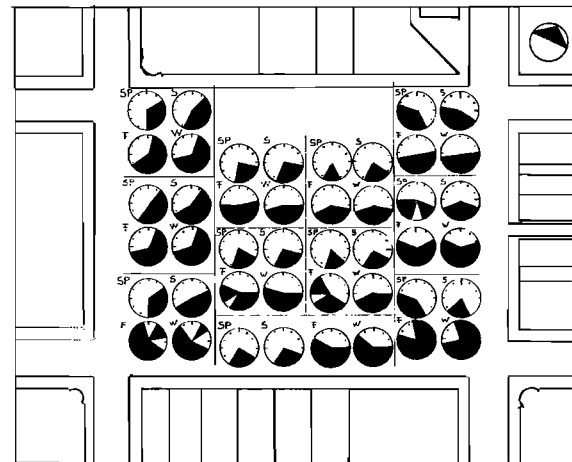

Figure 8. Seasonal analysis of the times during which sunlight is available at each point on Union Square

To translate the sun availability concerns into development policy guidelines, the Sun and Light Report proposed the use of sun profile planes and solar zones to establish height limits that would preserve sunlight in critical public spaces. The sun profile planes were suggested as a way of establishing street wall heights and building setback requirements for preserving sunlight on sidewalks. The planes were determined by calculating the "cut-off angles" necessary to permit sunlight to reach the sidewalks during critical times of the day (generally, the lunch hours) during a specified portion of the year. (Figure 9). The Sun and Light Report established cut-off angles and corresponding maximum street wall heights for all the major streets in the city's central district. In places these cut-off angles have been superseded by the policies established by Proposition K mandating sunlight protection not just during critical times of day, but from one hour after sunrise to one hour before sunset at all times of the year.

Solar fans were presented as a way of depicting the complex sets of cut-off angles that need to be considered for protecting sunlight in larger open spaces. The cut-off angles essentially establish a funnel-like set of planes ascending outward from the open space, defin-

ing the air space that has to be left clear to permit sunlight to reach the open space during specified hours and seasons. "Solar fan" diagrams convert these three-dimensional figures into simplified two-dimensional drawings which plot the height limits that the various cut-off angles define (Figure 10).

Winds in San Francisco

In San Francisco, wind direction and speed vary considerably, depending on both season and time of day. These variations are depicted in Figures 11 (season) and 12 (time of day). In the spring, the winds generally blow from the west and northwest, and speeds tend to be in the 12 to 24 mile per hour range. During the summer, the ocean breezes increase, so west and northwest winds of 12 miles per hour are more common. Fall winds are not as strong as those in the summer; they generally come from the west and northwest, but winds from the northeast and southwest are common as well. Overall, the winds are calmest during the winter. The strongest winds blow from the west and northwest. At this time of year, east and northeast winds also occur, but these tend to be of relatively low velocity.

On a typical spring day, wind speeds tend to be relatively low in

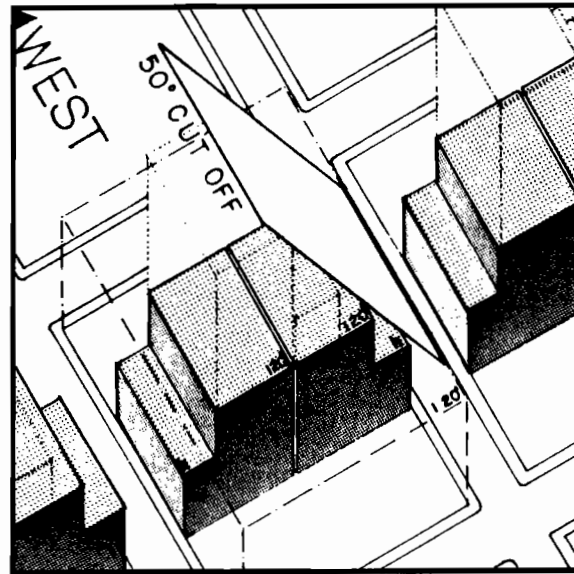

Figure 9. Example of a Cut-off Angle

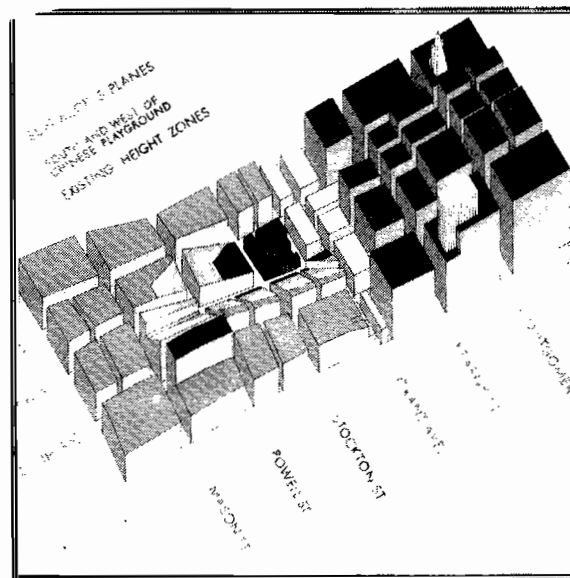

Figure 10. Solar Fan for the Chinese Playground

Source: Terminal Forecasting Manual San Francisco International Airport, 1968, modified by a factor related to Federal Building data.

Note: The wind data presented here is preliminary: data more relevant for downtown San Francisco will be available in the Fall of 1984.

Figure 11. Wind Velocities and Directions in San Francisco by Season

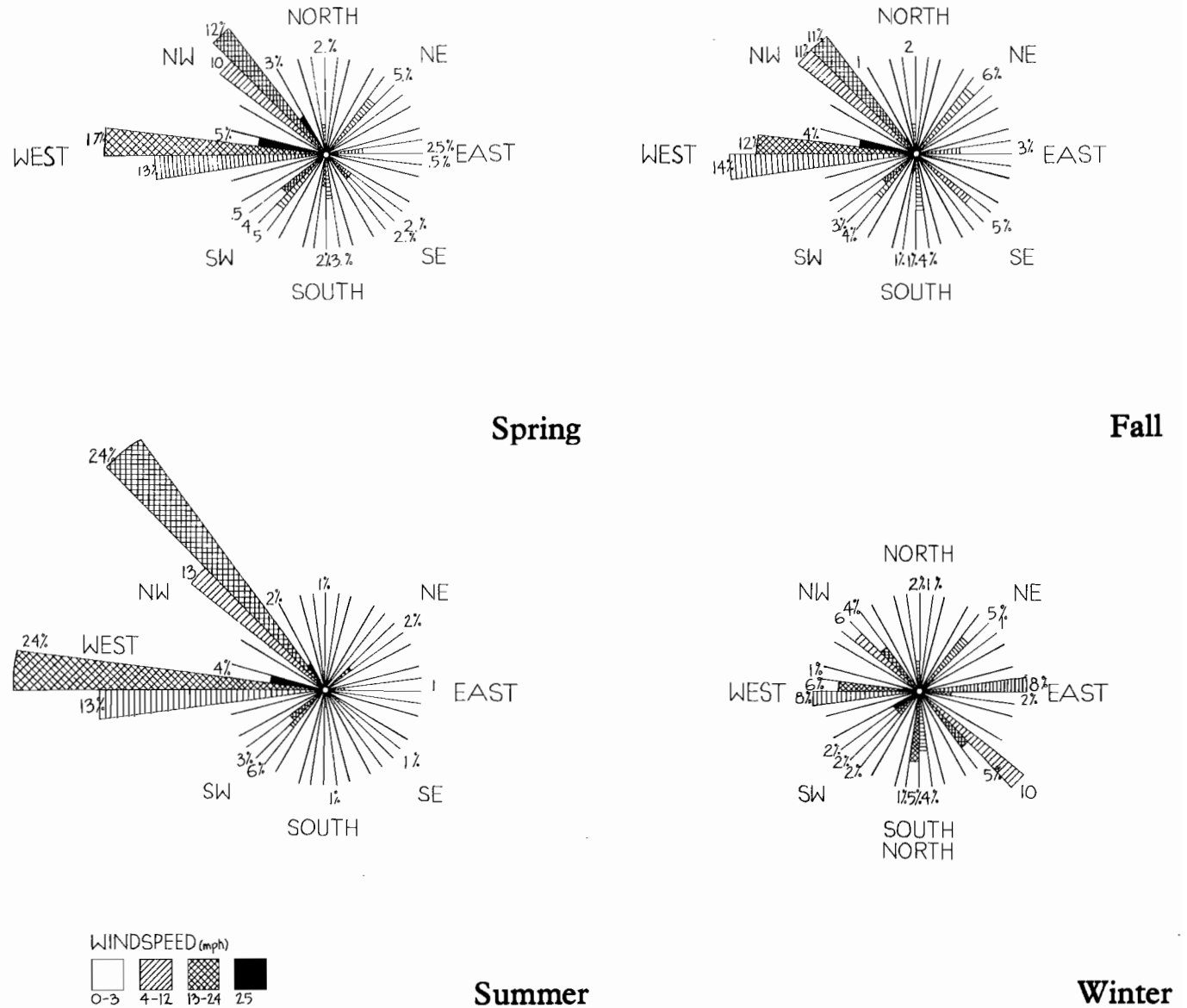
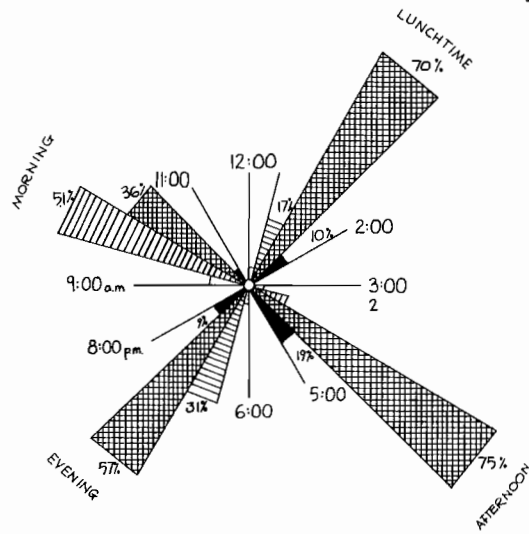
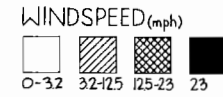
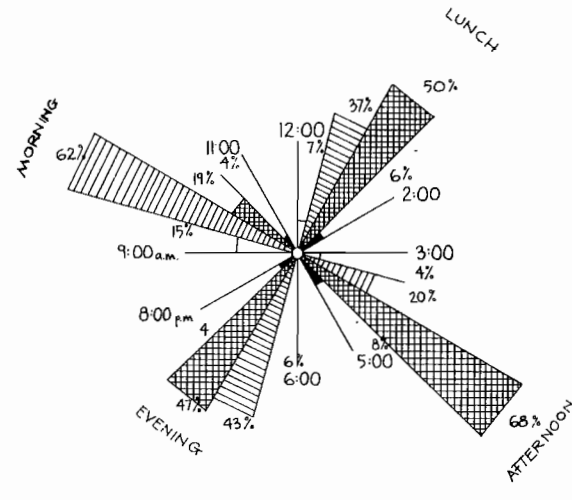

Figure 12. Wind Velocities in San Francisco by Time of Day



Spring



Fall

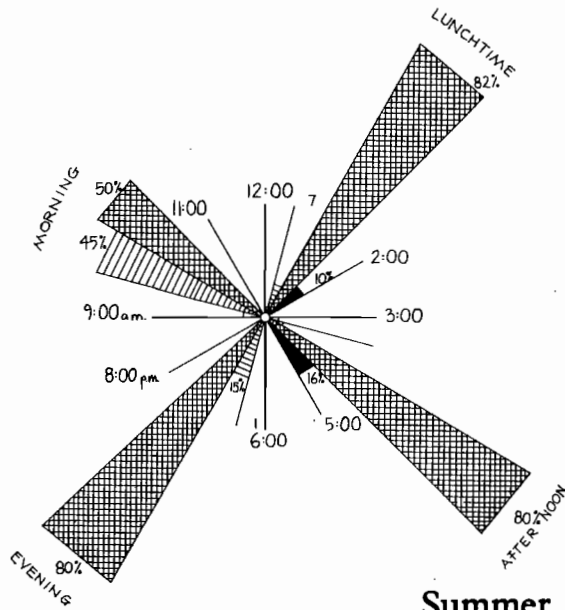

Summer

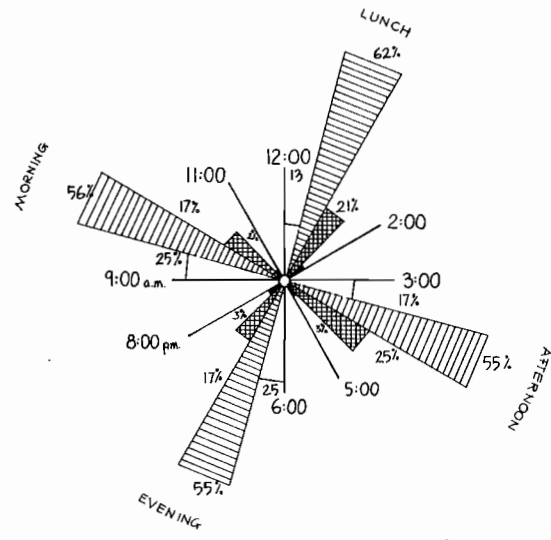

Winter

the morning, pick up by lunch time, remain at high levels during the course of the afternoon, and remain strong into the evening. Fall mornings, typically, are relatively calm, but the winds pick up around lunchtimes and the strongest winds occur in the afternoon. Fall evenings tend to be calm. Winter days are typically calm, but when high winds do occur, there is no particular diurnal pattern.

Wind in the Urban Environment

Wind is of special concern in city design because the urban environment alters natural air flows in ways that can create problems unless care is taken. In general, ground level wind speeds are lower in urban areas than they are in the open countryside because the city's

structures create a high friction surface that causes the lower level winds to slow down. However, large buildings that are poorly sited or designed can cause disturbed wind flow patterns in which ground level wind conditions are worse than those that would occur in the open countryside.

Figure 13 illustrates what typically happens when the wind hits a large single building. Much of the wind is deflected so that it flows around the sides and over the roof, and part of the wind flows downward on the building's windward side. The flow pattern is shaped by differential pressures around the building: typically, a zone of high pressure builds up on the windward side, and low pressure zones on the leeward side and at the upwind edges of the sides and roof. The low pressure zones create a suction which cause the reverse eddy flows that frequently occur around building sides and roofs.

When more than one building is involved, wind disturbances can become more complicated and severe. Much depends upon building orientation and the relationships of buildings to each other. Many of the effects have been documented by research carried out at the Scientific and Technical Building Center in Nantes, France.¹ Some of the most important effects identified are:

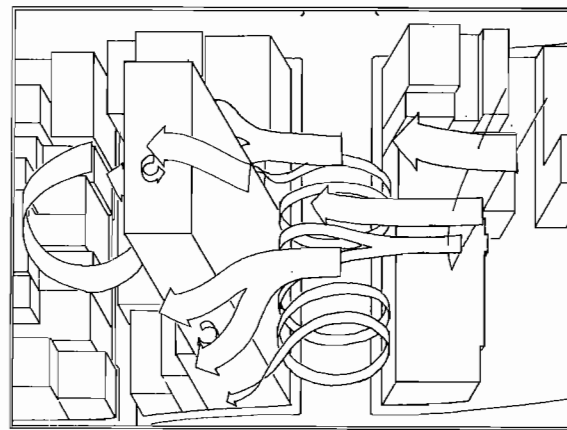

Figure 13. Typical Air Flow Patterns around a single building

¹ Gandemer, J. "Wind Environment Around Buildings: Aerodynamic Concepts." in Proceedings of the Fourth International Conference on Wind Effects on Buildings and Structures, London, 1975. Cambridge: University Press, 1977.

Downwash Vortex at the Foot of Buildings

Some of the most frequent and severe urban wind effects come about when a tall building protrudes above the surrounding cityscape. Because the wind's speed increases with height, the pressures that build up on the building's windward face are higher at the building's top than at its base. The difference in pressure creates a strong downward flow. The intensity is further amplified if a low building in front of the tall one creates a stronger suction at the building's base. Once it reaches the low pressure zone at ground level, the downdraft tends to turbulently spin around, further adding to the discomfort it creates.

Corner Effect

Another common effect is for severe winds to be created at building corners. The corner effect is created by the flow of wind from the high pressure zone on a building's windward side to the low pressure zone on the leeward side. The disturbed wind patterns created by the corner effect are generally restricted to an area whose radius is no longer than the building's width. The taller and wider the building, the more intense the effect. If two towers of 30 or more stories are placed less than two building widths apart, a severe corner effect will

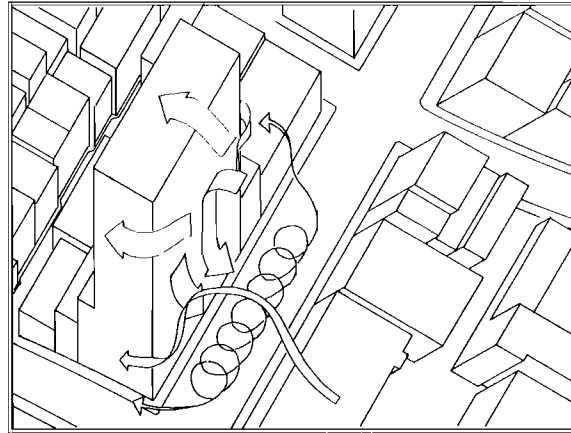

Downwash Vortex

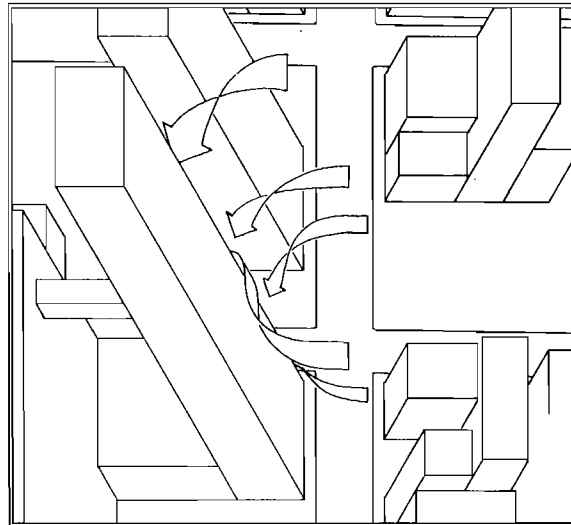

Corner Effect

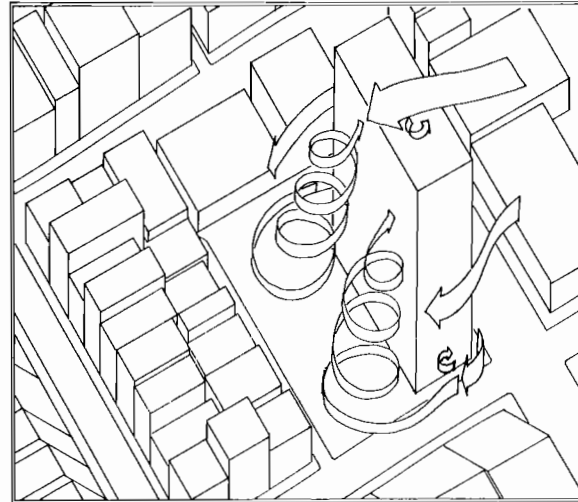

Wake Effect

influence the entire space between them.

Wake Effect

The wake effect is related to the corner flow phenomenon. Wind sucked into the vacuum on a building's leeward side continues to flow and spiral, creating a zone of turbulence. Downwind wakes generally follow the pattern indicated in the illustration, but tend to be erratic. The wakes created along the building's sides sometimes connect to the downward wakes, depending on the building's alongwind length.

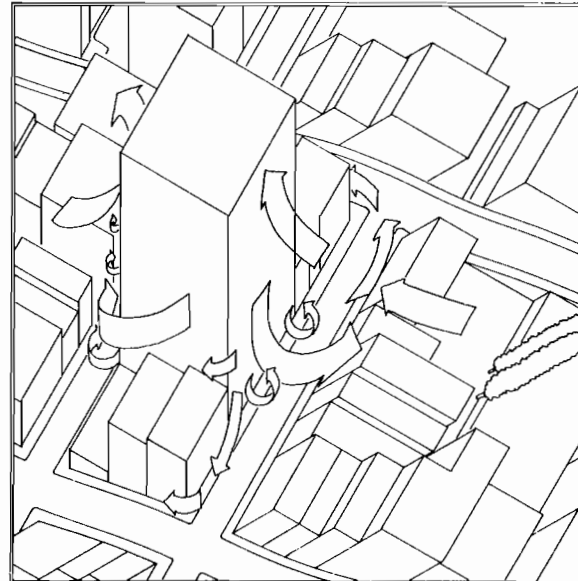

Tower Among Lower Buildings

Tower Among Lower Buildings Effect

Downflow, corner and wake effects are generally the most severe when a tall building is set down among existing buildings that are all considerably lower in height. The lower buildings decrease the ground level wind speeds, creating a greater differential between the high level and street level pressures, increasing the downward suction.

Gap Effect

When a building of five stories or more is set on columns or has a passageway through it, air forced through the openings creates a chan-

nel of intensified wind on the downwind side.

Pressure Connection Effect

Pressure connection effects develop as the wind flows over parallel rows of buildings, creating suction between them that draw in downdrafts and winds, generating transverse flows, especially along the ground. The intensity of the effect varies with building height, with taller buildings producing more intense effects. The effects further intensify if the crossflow's channel is narrow and regular-sided. When there is a pattern of continuously increasing heights, different pressure zones are created on the lee-side of each building, and the cross-currents tend to flow towards the zones of lowest pressure.

Channel Effect

A street or other open space lined with tightly grouped sets of buildings can tend to channel the wind if the space is long, and narrow in relation to the heights of the buildings which bound it.

Venturi Effect

A venturi effect can take place when two large buildings placed at an angle to each other create a funnel with a narrow opening that is no more than two or three times the

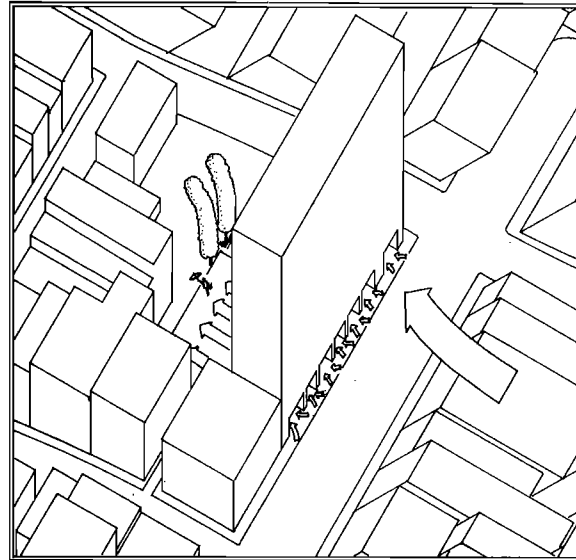

Gap Effect

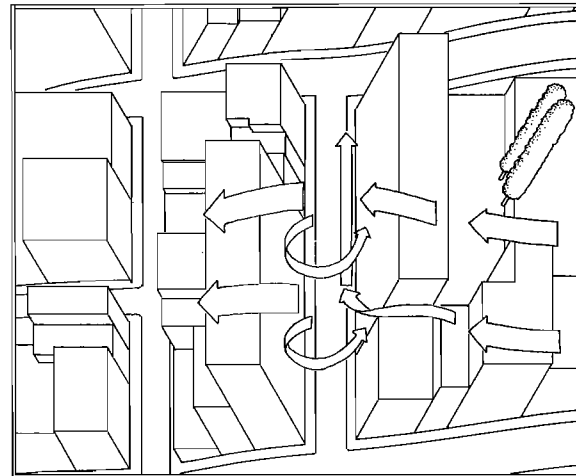

Pressure Connection

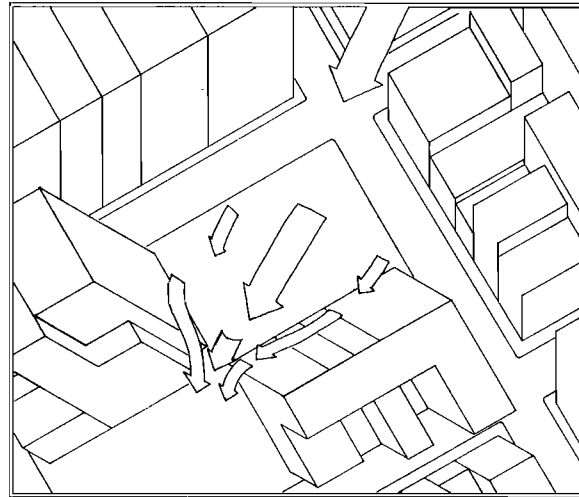

Venturi Effect

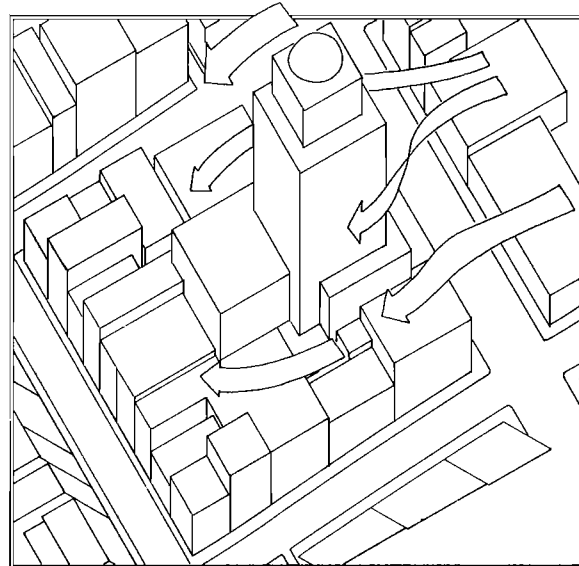

Pyramid Effect

building height. The winds channel through the opening, creating highly intensified wind speeds. This effect occurs only when the buildings are at least five stories high and have a combined length of 300 feet, and when the areas in front of and behind the venturi are relatively open.

Pyramid Effect

Pyramidal structures offer little resistance to the wind, and generally seem to disperse the wind energy in all directions. One application of the pyramid principle is the use of tiering configurations in the design of tall buildings as a way of reducing downflow, wake, and corner effects.

Shelter Effect

The shelter effect exists when buildings are arranged in such a way that they shelter each other from the wind. When a wind first hits a built up area, it tends to have the greatest effect in a strip approximately 600 feet wide. Beyond that, wind speed and turbulence remain at reduced levels until the wind encounters buildings twice the average height of the surrounding cityscape.

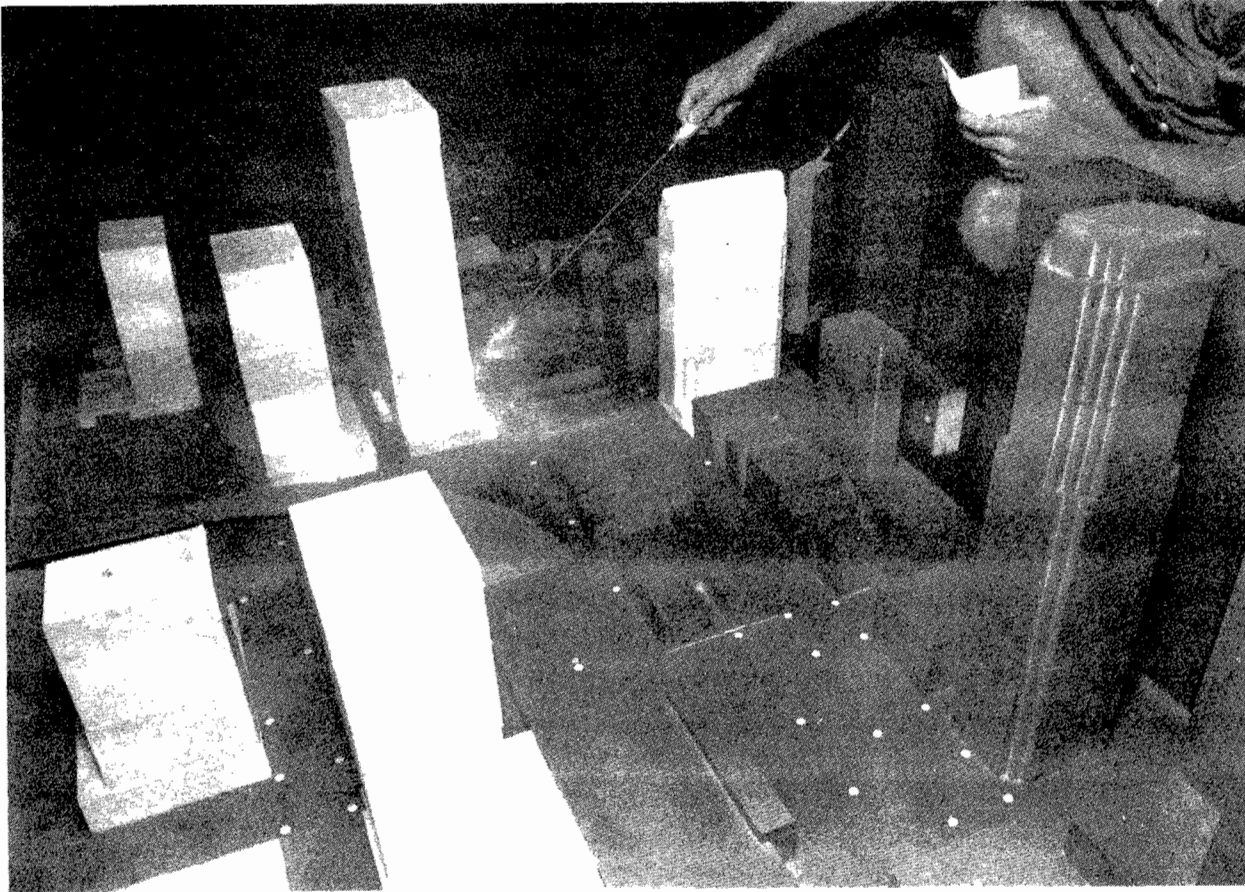

Methodology

Unlike most sun and wind studies, which tend to focus on the effects of a single building, this study was designed to evaluate the cumulative sun and wind effects produced by development changes in several square block urban segments.

In brief, the study process involved selecting specific areas for detailed study, evaluating the development conditions and trends existing there, and generating scenarios representing potential future growth. Scale models were made of each of the areas, and wind and shadow conditions were simulated

for each of the development patterns assumed. The wind and shadow measurements were fed into a computerized model which then predicted the implications of the sun and wind conditions for human thermal comfort in the San Francisco climate. The results were then evaluated and related to San Francisco's development and design policies.

Selection of Study Areas

The study focused on sun, wind, and comfort conditions in the areas at the edge of the central district whose current land use and building patterns are under the greatest pressure for change. In general, those areas are Chinatown/North Beach, the area south of Market Street, the Tenderloin, and the Van Ness corridor. All are places that face mounting pressure for replacement of existing 3 to 8 story buildings with buildings considerably larger in scale. Much of the impetus for undertaking the study came from resident groups concerned about the effects of development on livability.

Chinatown is vulnerable to change because of its location next to the Financial District, and because of internal pressures for more intensive development. Market conditions and evolving city planning policies are making the area south of Market Street the place

where much of the central district's future expansion will be taking place. The Tenderloin faces the threat of change brought about by the westward expansion of the Union Square Hotel District. Along San Francisco's former auto row on Van Ness Avenue, city planning policies encourage replacement of the existing structures with high density housing built above street level commercial uses.

In each of these areas, the project team evaluated existing land use, building, and activity patterns, existing and proposed development regulations, and public concerns to identify a smaller area for detailed study. Each of the smaller areas selected for study was defined to include major or proposed open spaces, a variety of street and building configurations, and conditions reflecting the changes and issues facing the larger areas of which they are a part.

Area Analyses and Generation of Future Development Scenarios

To get a picture of existing conditions and trends, the study team evaluated each area, analyzing existing plans, studies, and environmental impact reports, land use information, market data, and aerial photos, and carried out field surveys. In addition, the implications of public and private plans,

and provisions of existing and proposed zoning and other development controls were carefully assessed.

Based on this analysis, future development scenarios for each area were generated. The lots considered to be the most likely sites for future development were identified, and from these, representative lots were chosen to demonstrate the effect of potential change. An effort was made to select representative sites with varying lot sizes and configurations, sites that were close to major open spaces, and sites with varying relationships to the different street-types identified (wide and narrow, north-south and east-west). For each of the representative sites, hypothetical buildings were designed, assuming an average build-out to 75% of the floor area permitted under height, bulk, floor area, and density transfer regulations.

In all cases, at least two development scenarios were devised. The first, "current regulation", scenario assumed development conforming to existing development regulations. Because this work was done before Proposition K was passed, the current regulation scenarios do not reflect the height limits that Proposition K imposes. Around Portsmouth Square in Chinatown, and Boedekker Park in the Ten-

derloin, the two places in this project's study area where Proposition K would apply, the existing condition scenarios come closest to representing the development levels and wind and comfort effects that Proposition K's regulations would create.

In a second, "mitigated", scenario, building shapes, and in some cases building heights and bulks were modified in ways it was assumed would reduce undesirable wind and shadow effects. In developing the mitigated scenario, cut-off planes and solar fans were consulted to assure that streets and open spaces would be protected from shadows during critical hours. To mitigate wind effects, the building siting and design principles established through previous wind tunnel research and illustrated in this report's Sun, Wind, and Comfort section were applied. For the Trans Bay Terminal area, additional scenarios were generated to illustrate the sun and wind implications of the regulations proposed by the Downtown Plan.

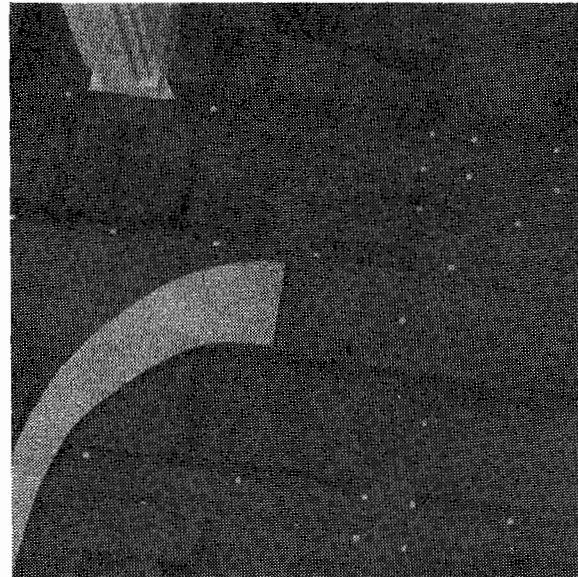
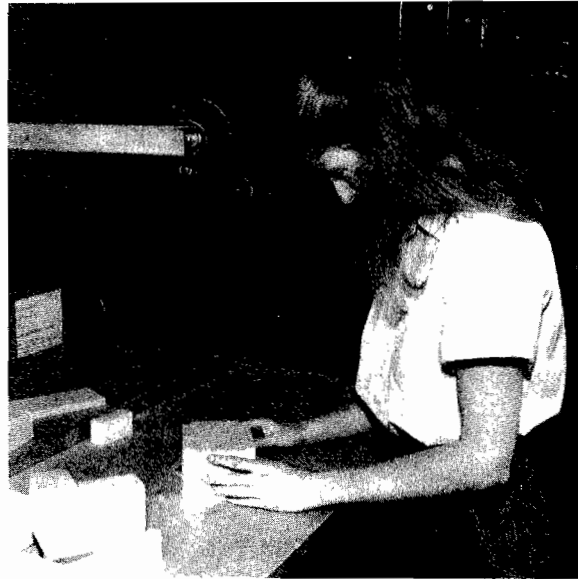

Scenario Testing

Model Construction

To measure the sun and wind effects that exist at present, and that would be created under each of the scenarios, models were built using foam blocks at a scale of 1" to 30'. For each area, a base model reflecting the existing development pattern was constructed using a system of interchangeable building modules. Each of the base models could be altered to reflect the building patterns assumed under the future scenarios. Within the models, points along the streets and in the open spaces were designated where measurements were to be taken of sun and wind conditions. These points were located in a way intended to capture the range of conditions and effects in each area. Particular care was taken to place points in major public open spaces (both existing and proposed) and on sidewalks along both representative and heavily used streets. Points were also placed in areas where it was hypothesized that major new buildings would create substantial sun and wind impacts at street level.

Wind Tunnel Testing

To measure wind effects, each version of each area's model (exist-

ing conditions, development under existing regulations, mitigated development) was placed in U.C. Berkeley's Boundary Layer Wind Tunnel. Using the wind tunnel, it is possible to calculate the ratios between the wind speed at each point on the ground, and the wind speed at the weather station from which data representing San Francisco's characteristic climatic conditions is obtained. An electronic probe was placed on each of the measurement points to determine the ratio between the pedestrian level wind speed at that particular point and the wind speed at the weather station. The intensity of turbulence or gustiness was also measured for each point, and the effect of that turbulence on pedestrians was factored into the wind speed ratios. The wind speed ratios were measured for the existing building configurations and for each of the potential future scenarios. Use of a smoke generator also made it possible to visually observe the ways in which the simulated winds were affected by building configurations.

In addition to calculating the wind speed ratios for each of the points for each scenario, a separate series of tests was carried out to identify the siting and design features most effective in reducing a building's pedestrian level wind effects. Using a model for a generalized urban area, individual

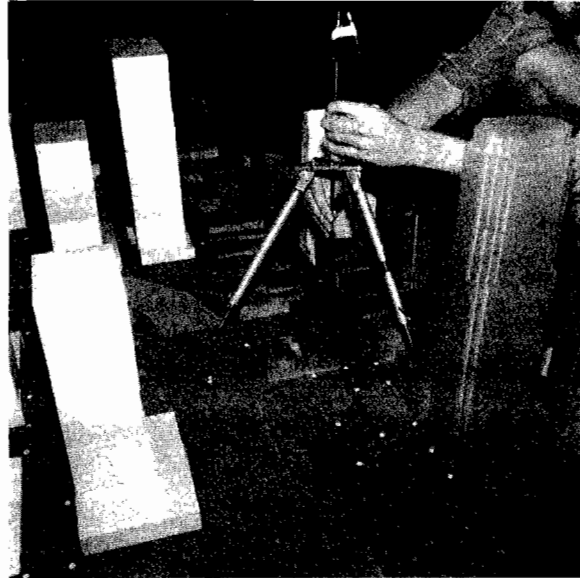

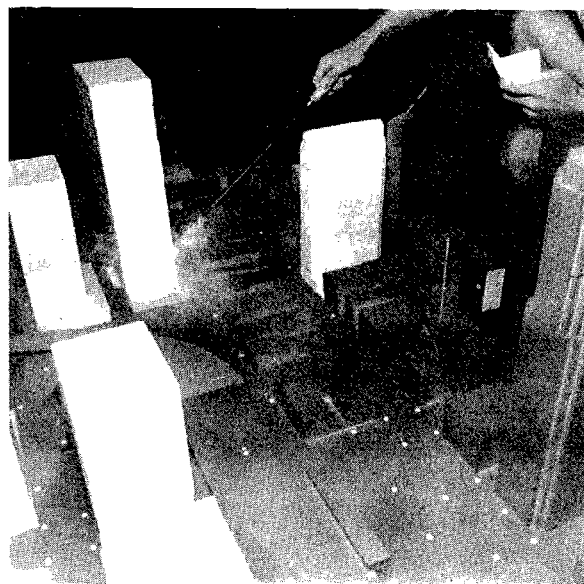

building masses were systematically altered to determine the effects on street level winds of building orientation, height, bulk and setback widths and heights. Smoke patterns were observed, and measurements were made of the pedestrian level wind ratios.

Solar Testing

To measure the shading effects of each of the building configurations, a parallel beam light source was used. The light source, whose position was manipulated to reflect the sun's altitude and bearing angle at each of the dates and times for which solar data was required, was directed at the model to determine if the measurement points would be in sun or shadow.

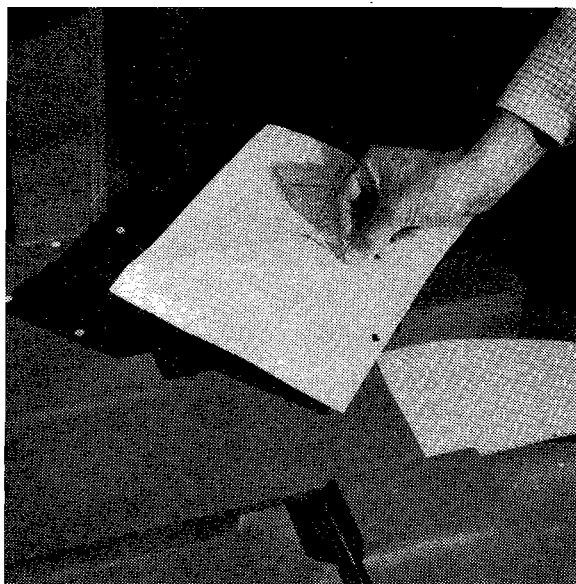

Because it would have been impractical to individually assess the street-level solar conditions for every hour of every day of the year, one day at the mid-point of each season was selected to represent solar conditions for the entire season. Likewise, mid-point times were selected to represent the solar conditions prevailing during the five major time periods into which the day was divided for the purpose of analysis. Readings for 8:00 a.m. represented the 8:00 to 9:00 a.m. period; 10:00 a.m., 9:00 to 11:00 a.m.; 12:30 p.m., 11:00

a.m. to 2:00 p.m.; 3:00 p.m., 2:00 to 4:00 p.m. and 5:00 p.m., 4:00 to 6:00 p.m.

Comfort Modelling

The wind ratios and sunlight availability data by itself was useful in analyzing the consequences of alternative development patterns in each of the areas. However, it only partially answered the question of when and how much building shadows and wind disturbance affect pedestrian comfort in San Francisco's climate. To complete the analysis and make it more useful to policy-making, a computer model was used to calculate more precisely how the wind and shading effects influence human thermal comfort.

The model used was a modified version of a mathematical model of the human thermo-regulatory system developed by Pharo Gagge at the J. B. Pierce Foundation Laboratory.² The model consists of two interrelated energy balance equations--one representing the energy balance in the human core (muscles, skeleton and internal organs) and the other representing the energy balance of the skin. Together, the equations consider the rates of energy production, loss, and storage in the body, and the energy transport between the two compartments of the body and the exterior environment. The model is



² Gagge A.P., Stolwijk, J.A.J. and Nishi, Y. 'An effective temperature scale based on a simple model of human physiological regulator response' ASHRAE Trans. 70, (I) 1970; Berglund, L.G. and Stolwijk, J.A.J., "The use of simulation models of human thermoregulation in assessing acceptability of complex dynamic thermal environments" in Stolwijk, J.A.J., ed. 'Energy conservation strategies in buildings,' New Haven: J.B. Pierce Foundation, 1978.

sensitive to variations in activity (metabolic level) and clothing, and in ambient temperature, radiation, relative air velocity, and humidity. It can thus predict the extent to which the body can maintain its temperature levels given alterations in activity and clothing and external climatic conditions. Comfort or discomfort is determined from body temperature based on ASHRAE thermal comfort standards.³

For the purposes of this study the model assumed an activity level of 1.2 MET (that of a person walking), and a clothing level of .07 clo in the summer and 1.2 clo in the winter. This model was used in conjunction with a weather data tape representing the "average weather year" for the San Francisco area (TMY year).⁴ The tape, based on readings taken over many years at the San Francisco Airport, contains actual weather observations hour by hour, day by day, for an entire year.

The model was run for representative points in each of the analysis areas. The points selected were those in the most crucial areas (such as heavily used open spaces) and those reflecting different combinations of sun and wind conditions. The model calculated comfort levels for each of the five periods

into which the day had been divided (7:00 - 9:00 a.m., 9:00 - 11:00 a.m., 11:00 a.m. - 2:00 p.m., 2:00 - 4:00 p.m. and 4:00 - 6:00 p.m.) for each season.

Use of the wind ratios (described in the previous section) for each of the points made it possible to translate the wind speeds contained in the weather tape to actual wind speeds that could be expected at the pedestrian level at each hour.

For each of the points for which the model was run, data was produced indicating how much of the time that spot would be comfortable for pedestrians under existing conditions, and under the future scenarios assumed. The output data was broken down by season and by time of day, permitting a relatively fine-grained analysis of when the location would or would not be comfortable. The comfort data for each point was evaluated in detail, related to the wind and shading effects produced by nearby buildings, and translated into implications for development and design policy. Implications were drawn for each of the specific areas studied, and based on an identification of common patterns, generalizations were made for broader development control and urban design policy.

³ ASHRAE Standard 55-81 Thermal Environmental Conditions Occupancy. January 81, Atlanta: American Society of Heating, Refrigerating, and Air Conditioning Engineers, Inc.

⁴ For technical detail on annualized weather data, see: National Climatic Center. "Typical Meteorological Observations. Asheville, N.C.: National Climatic Center, May 1981.

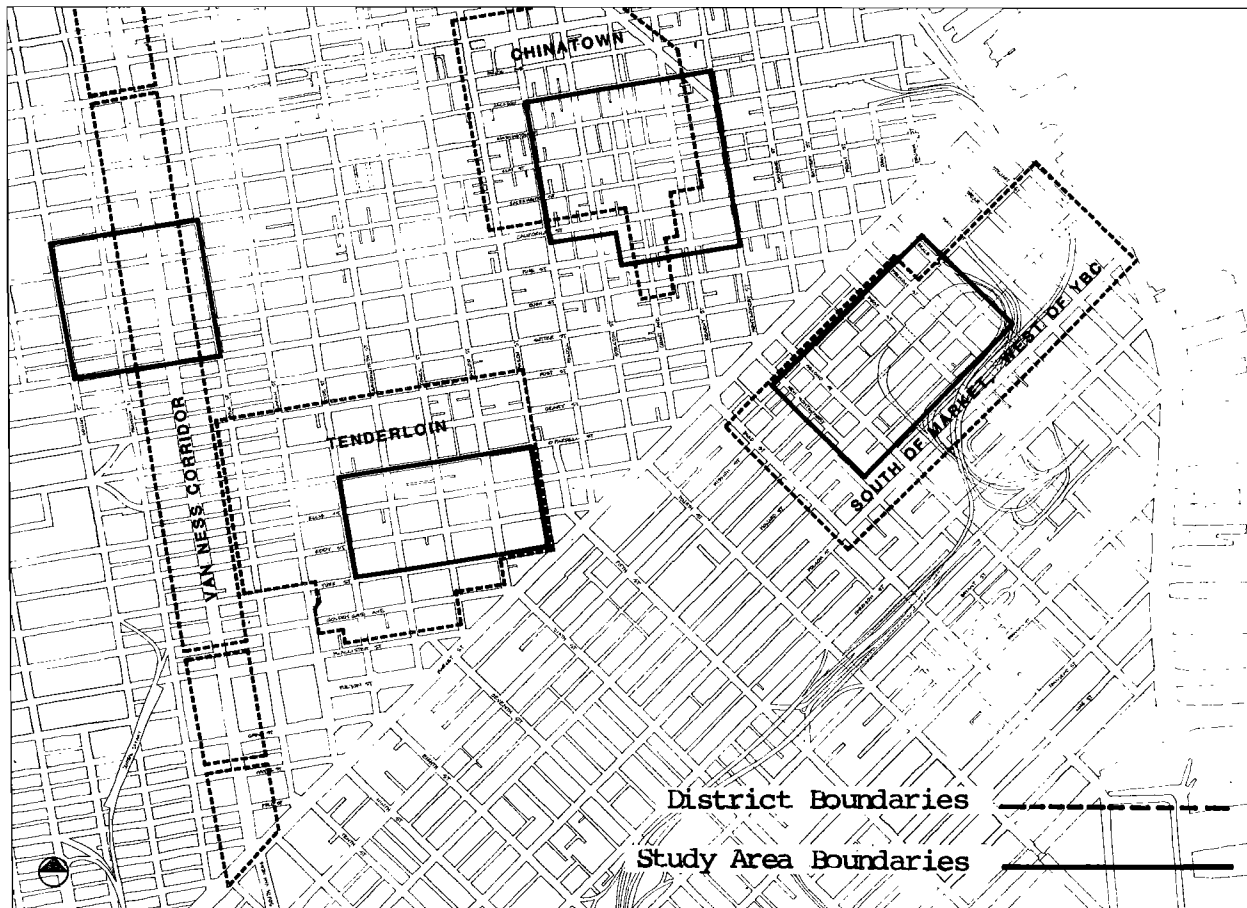

Analysis

This section summarizes the analyses carried out for each of the four areas evaluated. The area analysis summaries each begin with a brief description of current physical and social conditions; outdoor spaces, use patterns, and comfort

conditions; development trends; and planning issues. Next, the assumptions made about the future growth modeled for the area are spelled out. Then, a series of drawings is used to illustrate the effects of development patterns on wind at a central site or sites in the area under existing conditions, and under

the conditions that would exist assuming development under existing regulations and development modified to mitigate wind and shadow effects. These illustrations are followed by a series of maps of the same areas on which the complete comfort ratings are depicted, by season, for the same three development conditions. The detailed data on wind ratios, sun and shadow conditions, and comfort ratings for each point in each area is presented in tables in the appendices.

The maps in the following section show the wind directions and speeds as measured in the wind tunnel at the scale model's street level. The speeds are given in ratios of speed at street level over speed at the weather station. For example, if a windspeed of 12 mph is measured at the weather station, and the windspeed ratio for a given point is 0.6, then the windspeed at that point is expected to be 60% of 12 mph = 7.2 mph. The wind ratios shown on the maps represent the "equivalent steady wind," an hourly mean windspeed adjusted to incorporate the additional effects of gustiness on pedestrians.⁵

⁵ Hunt, J.C.R., Poulton, E.C., and Mumford, J.C., "The Effects of Wind on People: New Criteria Based on Wind Tunnel Experiments," Building and Environment, Vol. II, 1976, pp. 15-28.



Chinatown

This study area encompasses much of Chinatown, as well as a small corner of the Financial District's northern edge (Figure 14). Development is intense. In Chinatown, most of the blocks are covered with 3 and 4 story masonry buildings housing a mixture of uses. Most of Chinatown's street level

spaces house shops, restaurants, small offices, and even some small manufacturing and food processing operations. Upper floors are frequently devoted to housing. Because much of the housing consists of tiny apartments and single room occupancy accommodations, Chinatown has the highest density of any residential district in the city and houses over 10,000 people. The blocks along

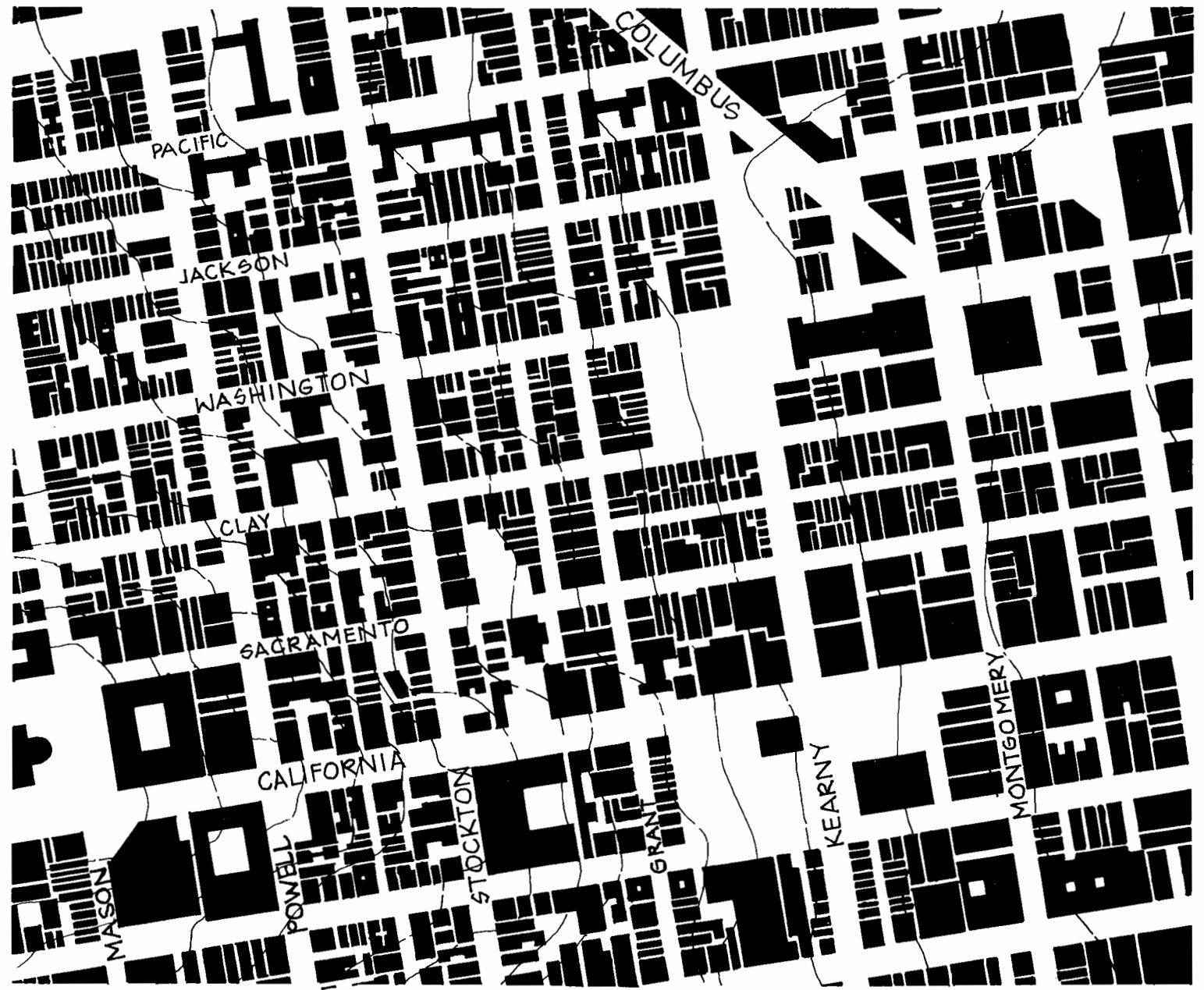
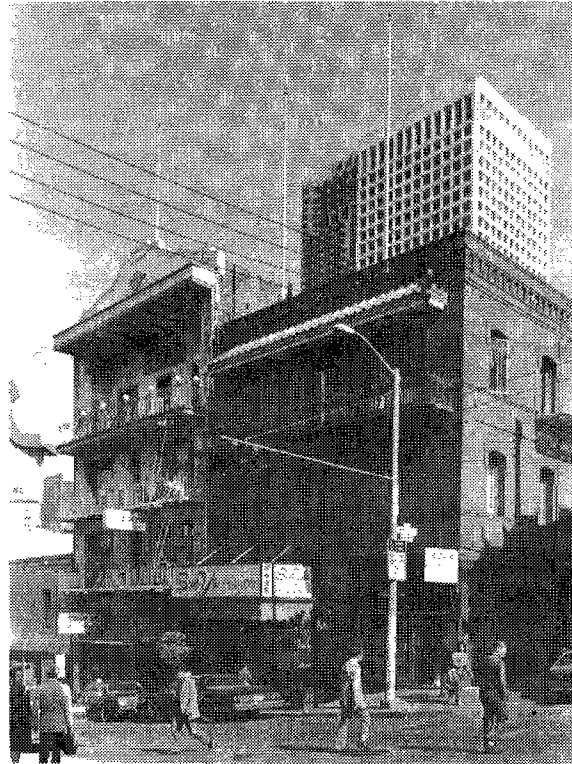

Figure 14. Chinatown

Pine and Montgomery Streets are part of the Financial District and are predominantly devoted to office and commercial uses. These blocks include several large office buildings, including the 52 story Bank of America tower.

Chinatown is one of San Francisco's most intensely utilized districts. With its specialized stores, services, and institutions, it serves as the center of community life for the 143,000 Chinese living in the central Bay Area. On weekends in particular, Chinatown's streets are thronged with people who have come in from other parts of the city and region. In addition, Chinatown is a major tourist destination, attracting, on the average, over 50,000 tourists per day.

Chinatown is under considerable pressure for change. Given the area's central location and proximity to the Financial District and the Nob Hill luxury hotel and residential area, land values have been rising, creating an economic incentive for replacing existing structures with larger and more profitable buildings. The low scale buildings along California, Kearney, and Montgomery Streets appear to be particularly vulnerable to pressures for replacement with large office towers. Pressures also exist for more intense development to meet the



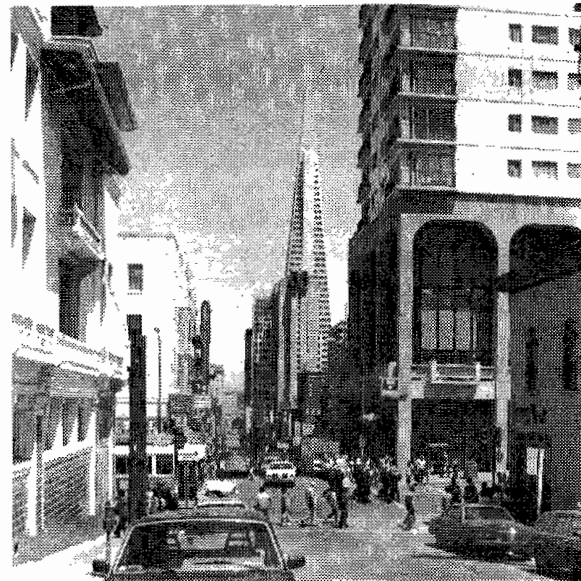

Chinese community's requirements for more commercial space, hotel facilities and housing. These pressures are further intensified by the inflow of overseas capital.

Although the pressure for change in Chinatown is very great, there are arguments for preventing wholesale replacement of the existing physical environment. One of the primary concerns is to protect the special role that Chinatown now plays for its current residents, many of whom are poor, elderly, or recently arrived immigrants. Although the housing is often old, cramped, and sometimes substandard, it meets the needs of those for whom affordable housing doesn't exist anywhere else. More importantly, for these groups, for whom opportunities are often limited by low mobility and limited acculturation, Chinatown has a concentration of social services geared to their specific needs, provides employment and shopping opportunities in a familiar social and cultural environment, and has good public transportation.

At present, heights are limited to 88 feet along Grant Avenue and 105 to 160 feet in areas to the west of Grant. However, along Kearney Street, heights of up to 320 feet are permitted, and along Montgomery, from 300 to 450. Recognizing the need to protect Chinatown's special qualities, the Downtown Plan recom-

mends reducing the C-3-G zone in the Chinatown area to protect the low rise buildings along Clay and Commercial Streets, and to limit heights in the rest of the corridor between Montgomery and Kearney Streets to 200 to 300 feet. Chinatown is now undergoing a re-zoning study in which further modifications of land use and height and bulk restrictions may be considered.

One of the central concerns that has emerged in the re-zoning process has been the need to preserve the existing low cost housing supply, and at the same time to enhance the area's livability for residents and other users. Preservation of outdoor living areas and comfort levels is a critical component of the livability issue. At present, Chinatown has one of the lowest ratios of public open space per capita of any district in the city. Given the residents' crowded housing, low incomes, and limited mobility, the need for nearby outdoor living space is particularly high. The public open spaces that now exist in the area (Portsmouth Square, the Chinese Playground, and St. Mary's Square) are now intensively used, and many of Chinatown's streets and alleyways are also heavily utilized for children's play and adult socializing. Given the low and relatively uniform building heights that now exist in most of the area, street level wind condi-

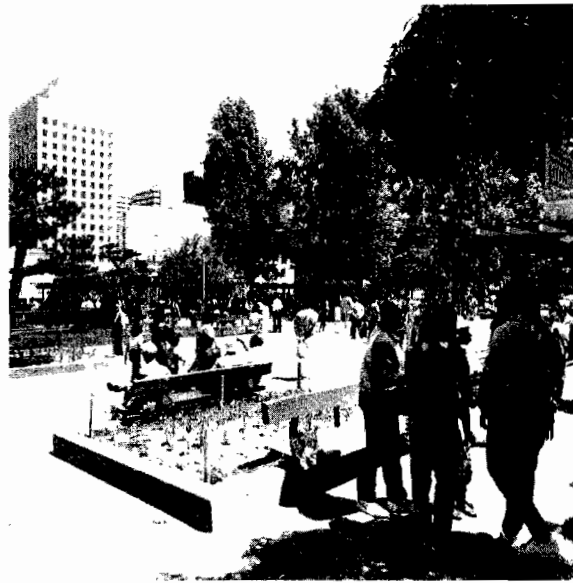



tions are generally good. Portsmouth Square is particularly well sheltered, and has generally calm wind conditions. The worst winds occur on Stockton Street at the base of the Mandarin Tower. Sunlight generally exists on most of the main streets, but sunlight availability is a problem in many of the narrow alleys. Protecting sun and wind conditions in the major open spaces is increasingly becoming problematic because all of them are located close to the areas under the greatest pressure for development with high buildings.



The alternative development scenarios modeled and tested for this area assumed that new buildings would be constructed on the sites indicated on Figure 15. These sites were chosen because they are potential candidates for change, and because they represent a range of relationships to streets, alleys, and parks. The development under the existing regulations scenario applied the height and bulk controls of the current zoning code, which generally restricts buildings to 80' if no housing is provided, and 160' if housing is included. The buildings modeled represented, on the average, 75% of the buildout that current regulations would permit on the sites used. The building outlines created reflect not only height and bulk restrictions, but also, when housing was assumed, the building configurations and setbacks that housing structures require. The mitigated development scenario for Chinatown was developed using solar cutoff angles recommended in the Sun and Light for Downtown San Francisco report to protect sun availability in streets and open spaces, and building step-backs and other design features intended to reduce street level winds. The use of these solar cut-off angles and wind sensitive building design principles resulted in a total build-

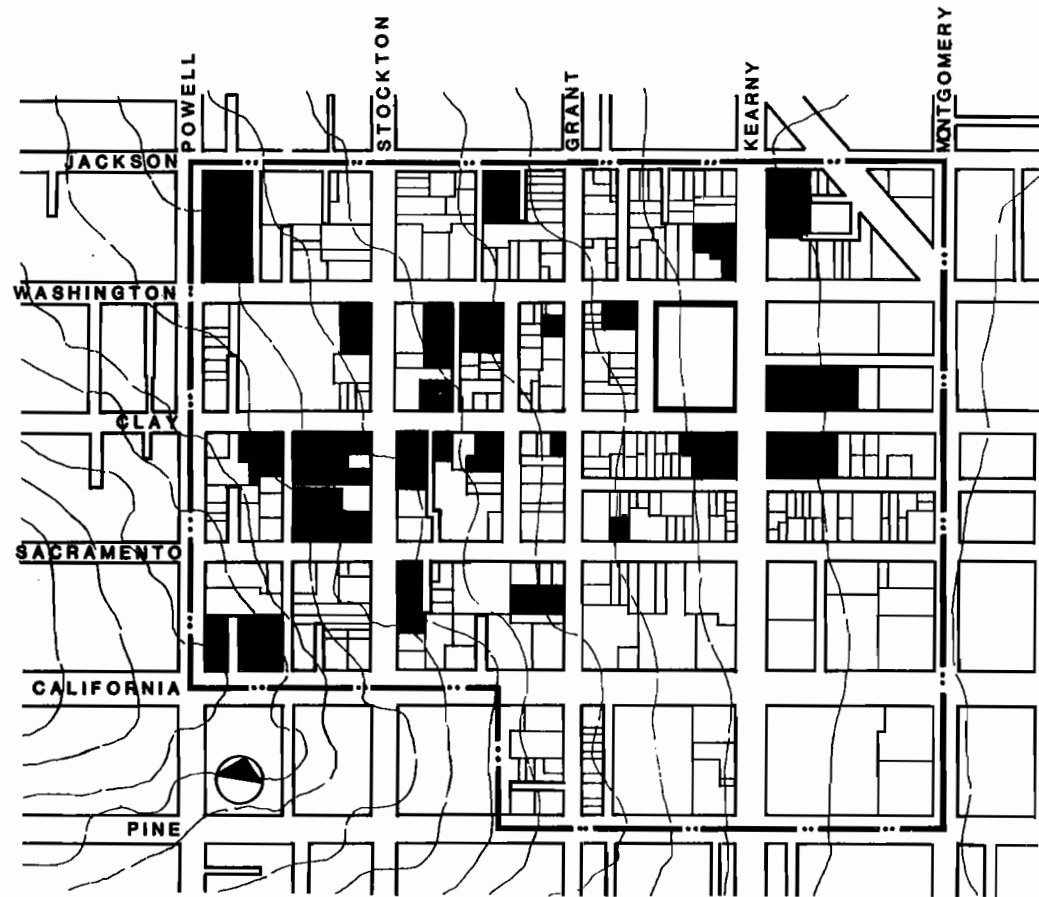

Figure 15. Representative Development Sites in Chinatown

dout that was about 1/3 less than the buildout assumed in the existing development scenario.



Aerial Photo of the Chinatown Area



Existing Conditions

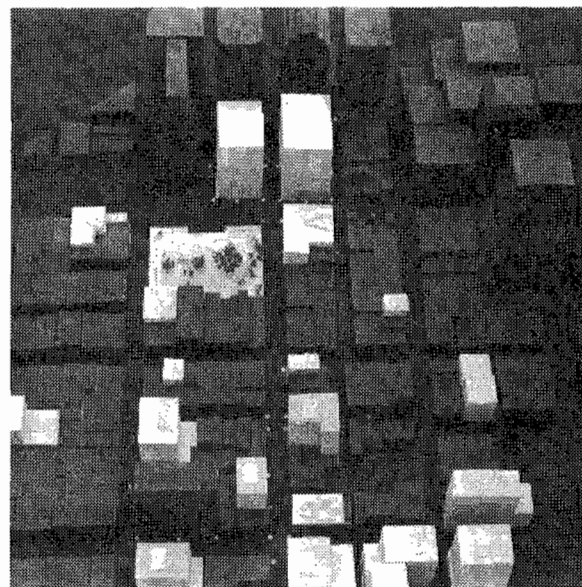

Development Under Current Controls

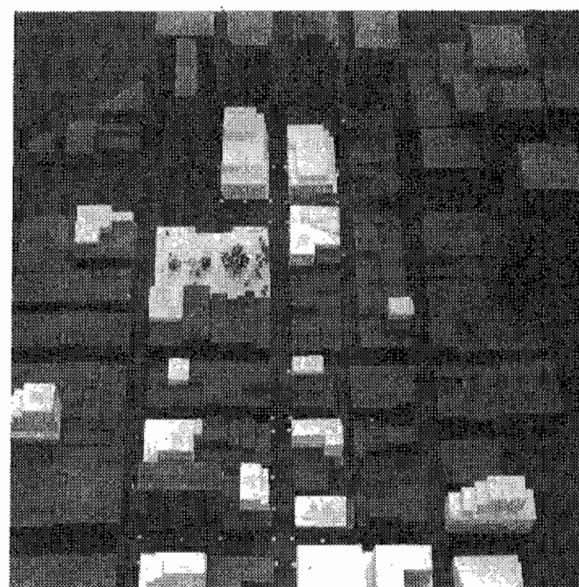

Mitigated Development

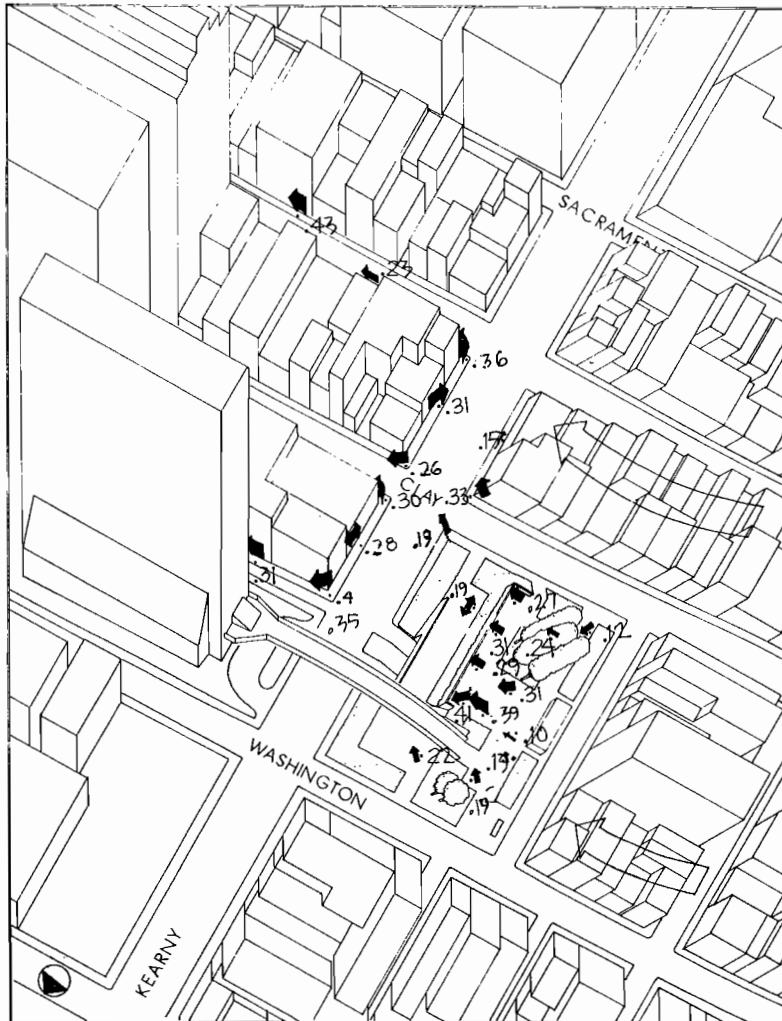

Existing Conditions

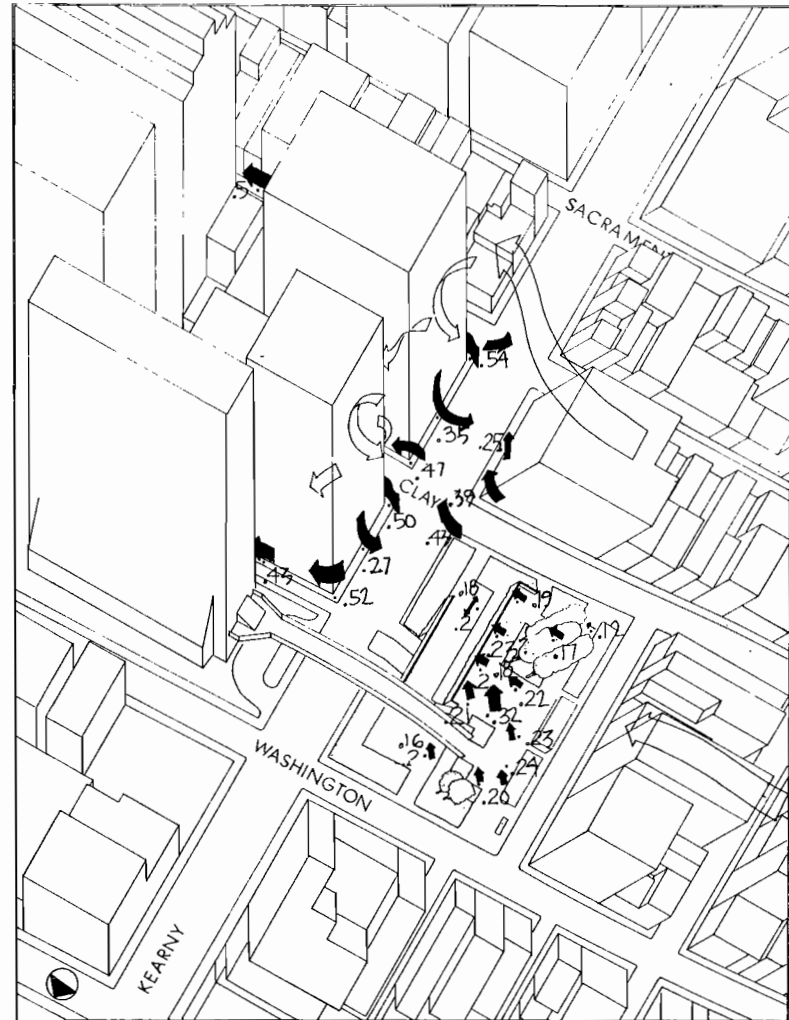

Development Under Current Controls

Wind from the West

The drawings and text on the next pages summarize the results of the wind tunnel tests. The numbers located at each test point are ratios that represent the relation-

ship of the street level wind speeds to the wind speeds measured at the weather station. The ratios have been adjusted so that they also reflect the effects of gustiness.

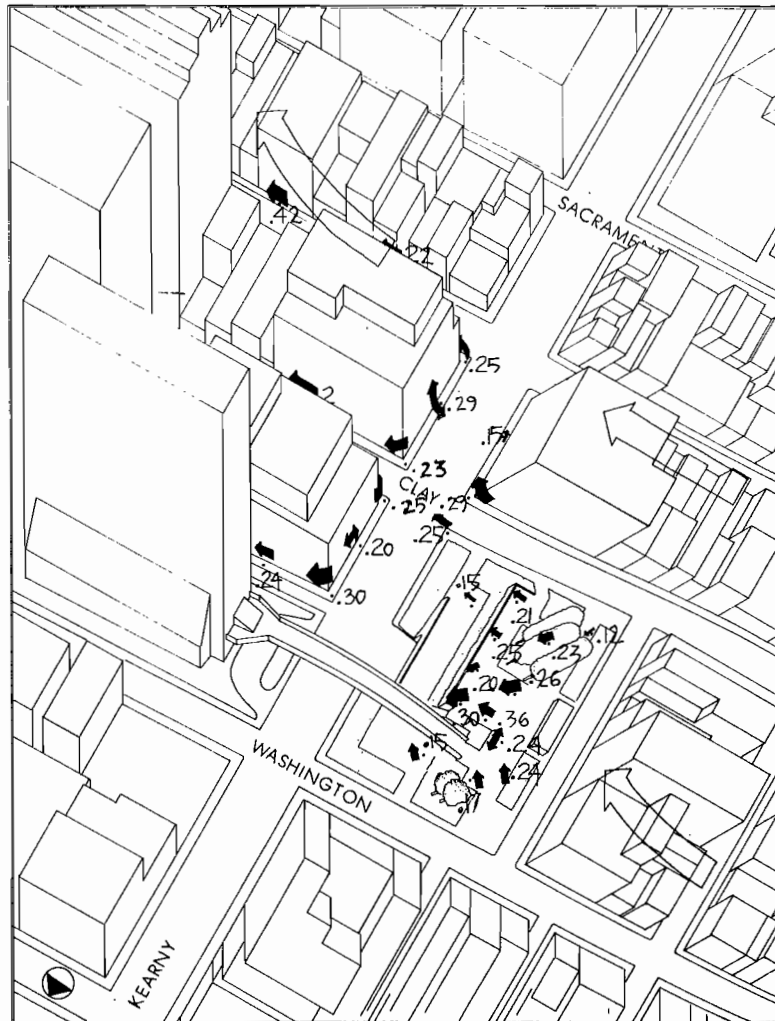

Mitigated Development

Portsmouth Square

Under existing conditions, the Portsmouth Square area is well sheltered from the western winds, so as a consequence, wind ratios at most points on the square and on Kearny Street are in the low to moderate range. When development under existing regulations is assumed, the wall of high buildings created along Kearny produces downwashes and corner effects which increase the wind ratios at its base. None of these ratios is so high as to constitute a severe problem. The wind ratios in the square itself remain relatively unchanged. Under the mitigated scenario, the wind ratios along Kearny are significantly reduced, and those in Portsmouth Square are slightly moderated, making them lower than they were in either the development under existing regulations scenario or under existing conditions.

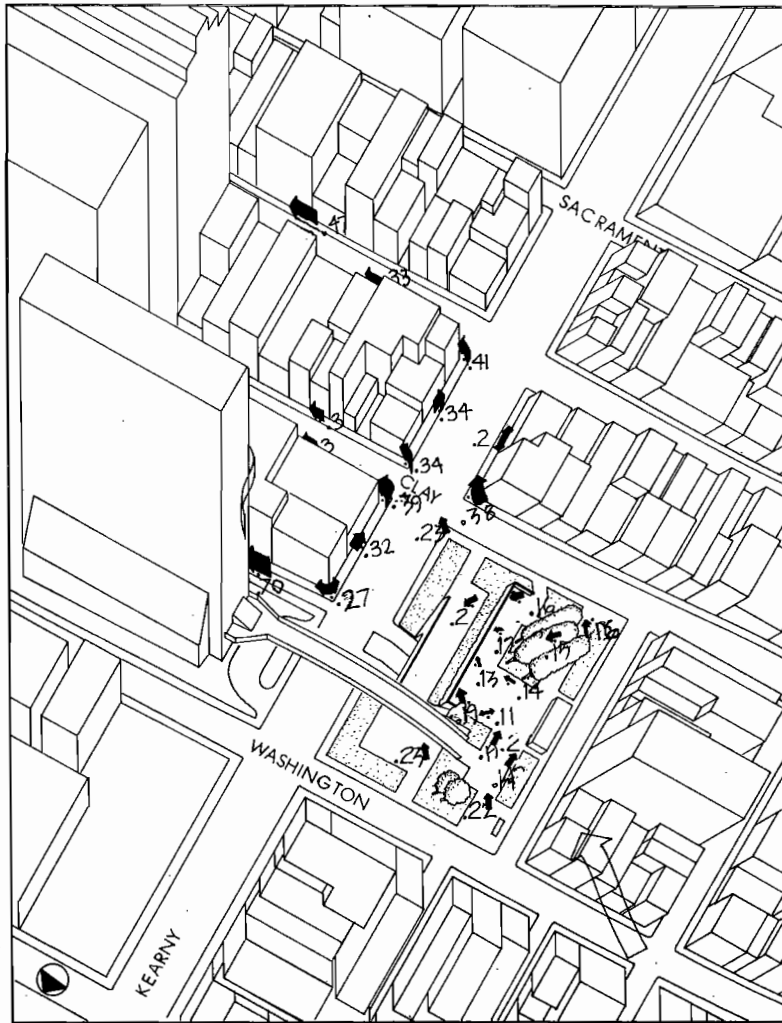

Existing Conditions

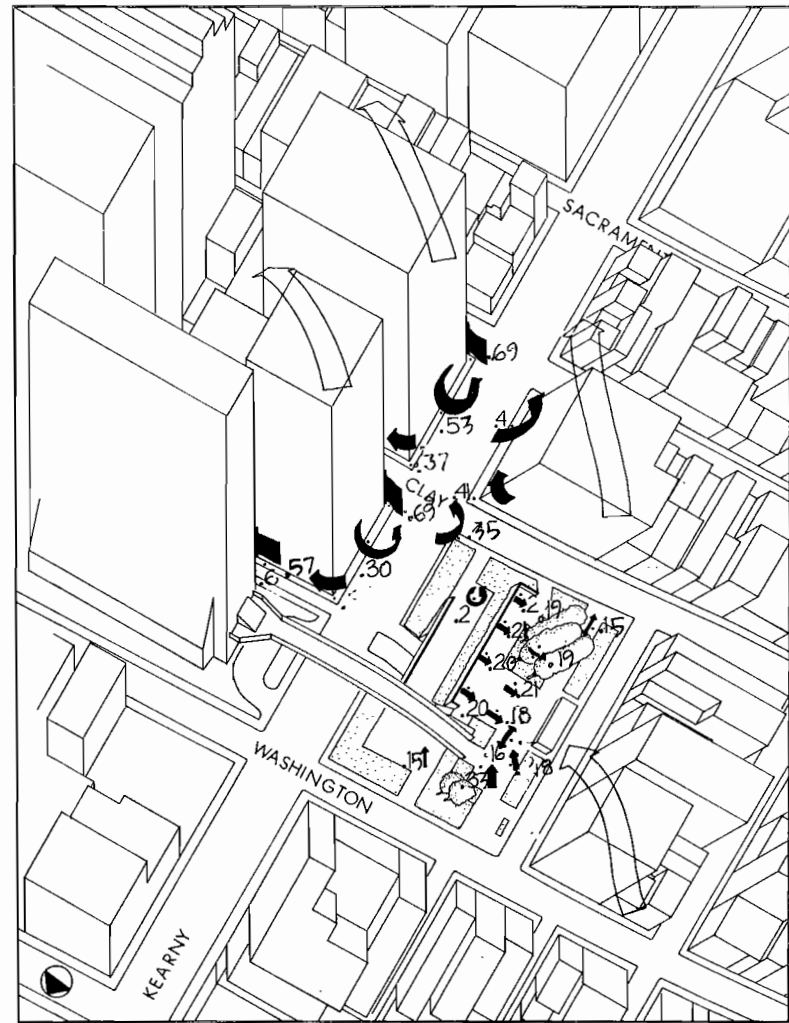

Development Under Current Controls

Wind from the Northwest

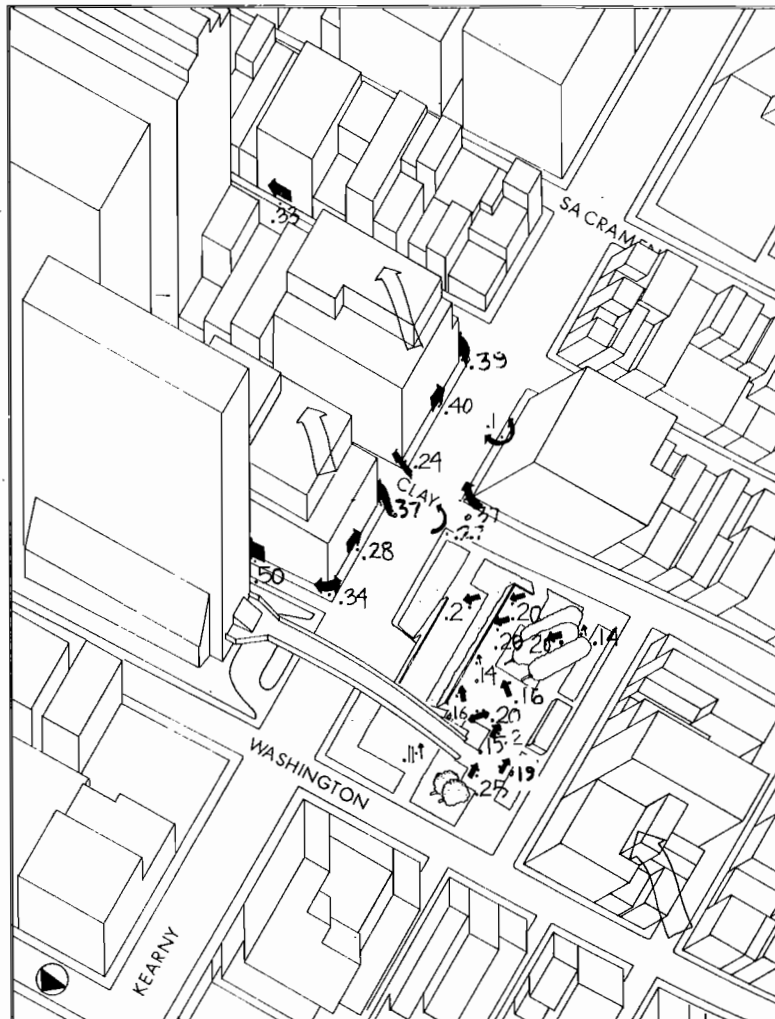

Mitigated Development

When winds are from the northwest, the wind ratios at most of the points in this area are low to moderate under existing conditions. The only point at which an extremely high reading is obtained is at the base of the Chinatown Holiday Inn. With development under existing regulations, the ratios are increased to extremely high levels at several points along Kearney, where tall new buildings create downwash and vortex effects. Wind conditions on Portsmouth Square remain relatively unchanged. Under the mitigated scenario, the modification to the buildings along Kearney result in ratios at their bases that are lowered considerably. Portsmouth Square continues to have exceptionally low ratios.



Existing Conditions

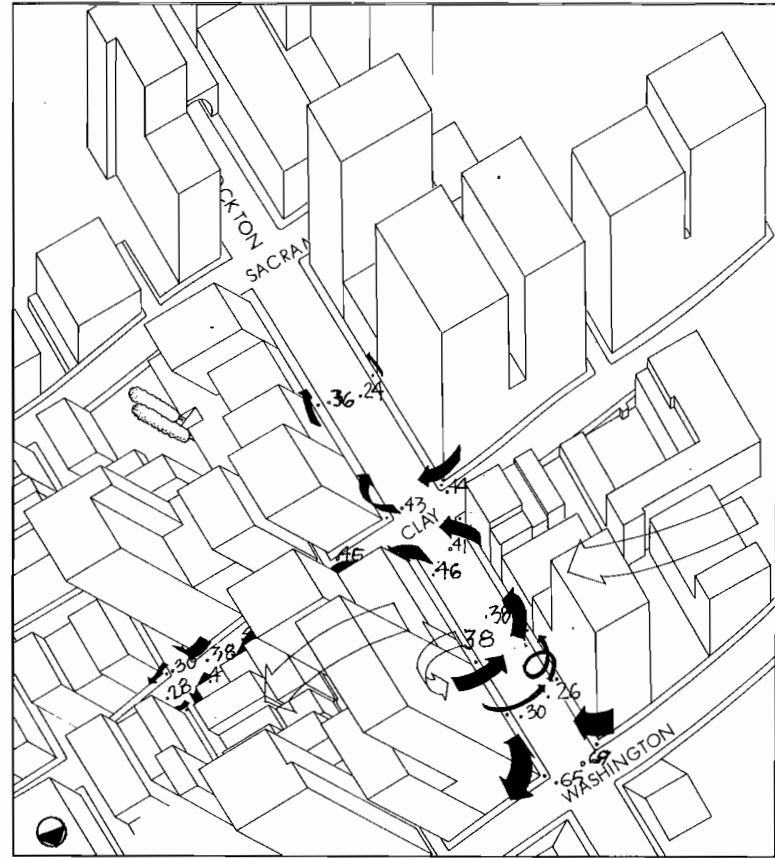

Development Under Current Controls

Wind from the West

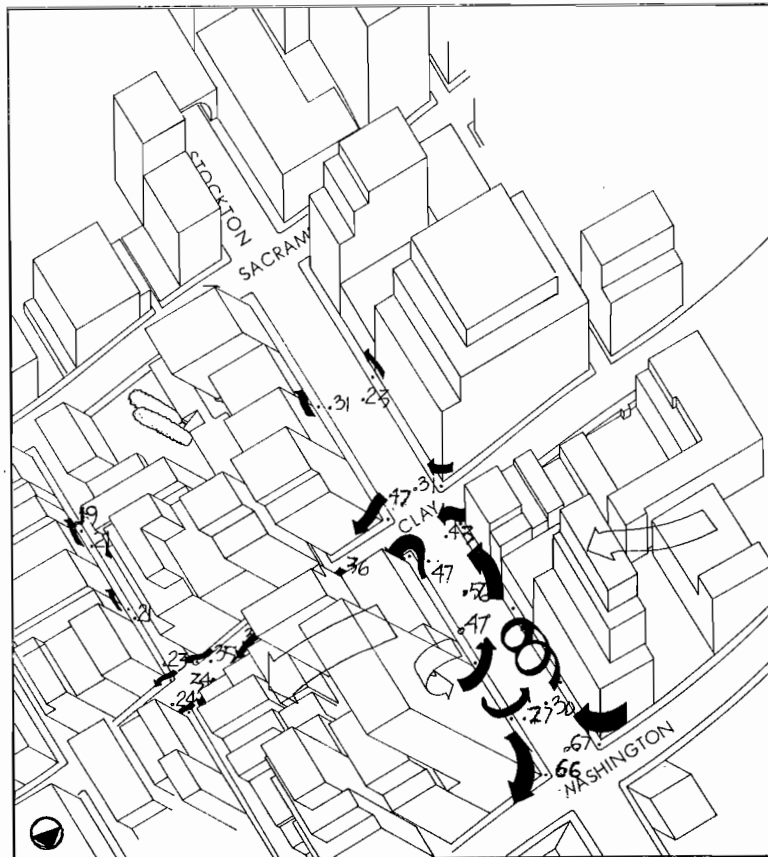

Mitigated Development

Stockton Street

Under existing conditions, winds from the west hit the Mandarin Tower building head-on, creating downwash, vortex, pressure connection and corner effects that produce extremely high wind ratios at several points along Stockton Street. In the rest of the area, most of the points have low to moderate level ratios, reflecting the uniform building heights, which create a degree of street level sheltering. With development under existing regulations, Stockton Street is sheltered by buildings to the west, moderating the wind ratios, although several extremely high ratios remain at the corner of Stockton and Washington. Along Clay, the ratios increase only slightly. In the mitigated scenario, wind conditions along Stockton Street are slightly worsened: the corner readings remain extremely high, and several of the mid-block ratios slightly increase. On Clay Street, the ratios are reduced to approximately the same levels as under existing conditions.

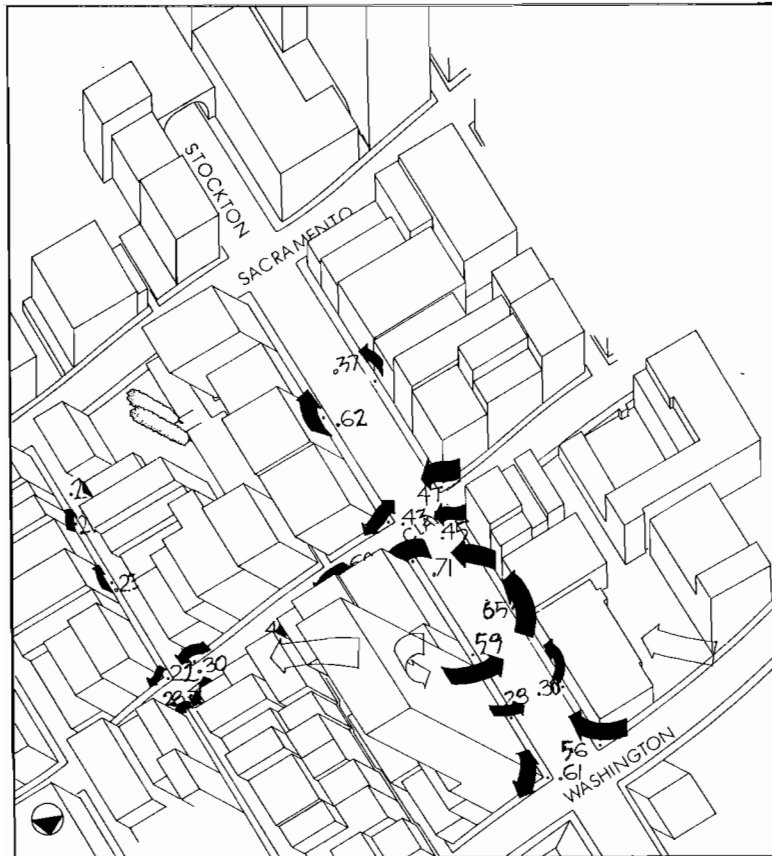

Existing Conditions

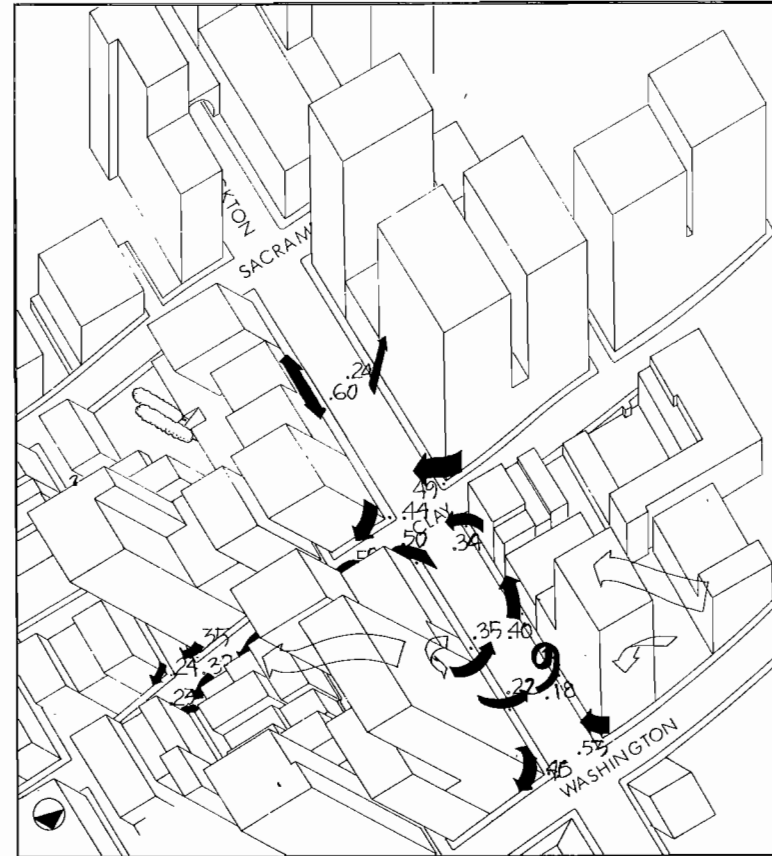

Development Under Current Controls

Wind from the Northwest

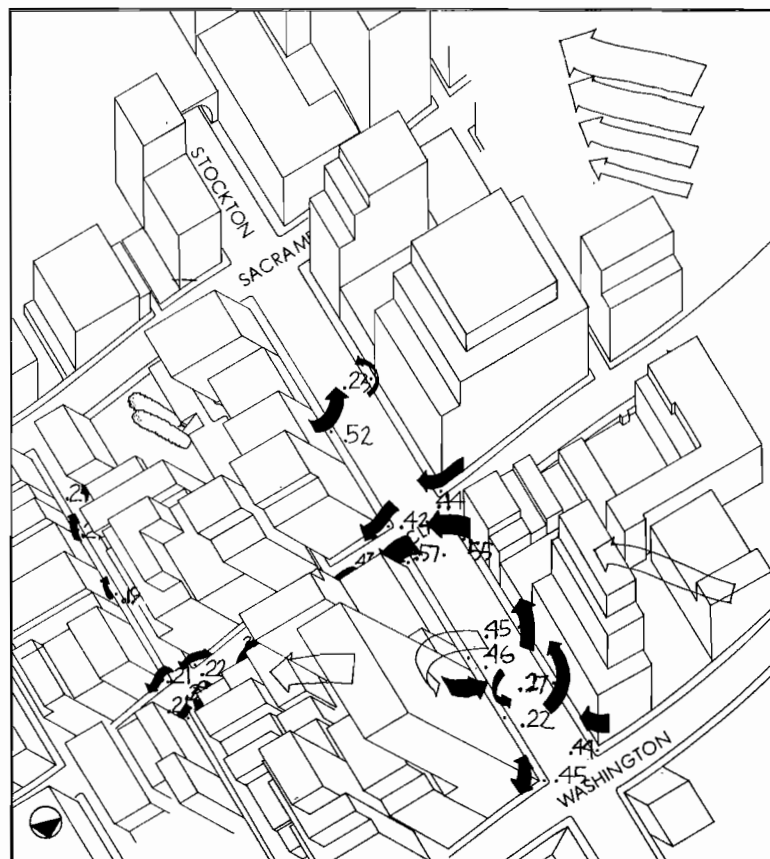

Mitigated Development

In a northwest wind, Stockton Street is even more of a problem area under existing conditions than it is with a west wind. The down-drafts from the Mandarin Tower swirl along the street causing readings of .6 and .7 at several points, and corner effects produce readings of .6 at the Stockton/Washington intersection. In most of the rest of the area, low to moderate ratio levels prevail. The new towers assumed in the development-under-existing-regulation scenario shelter Stockton Street, reducing the wind ratios to acceptable levels at most points. In addition, the ratios at most of the points in the rest of the area would stay the same or be reduced in this scenario. The mitigated scenario would not make a significant difference in the ratios at the points around the base of the Mandarin tower, and it would produce ratios slightly higher than those under the existing controls scenario at the Clay Street end of the block. In the rest of the area, the stepped back building designs would produce ratios slightly lower than those created in the existing regulations case .

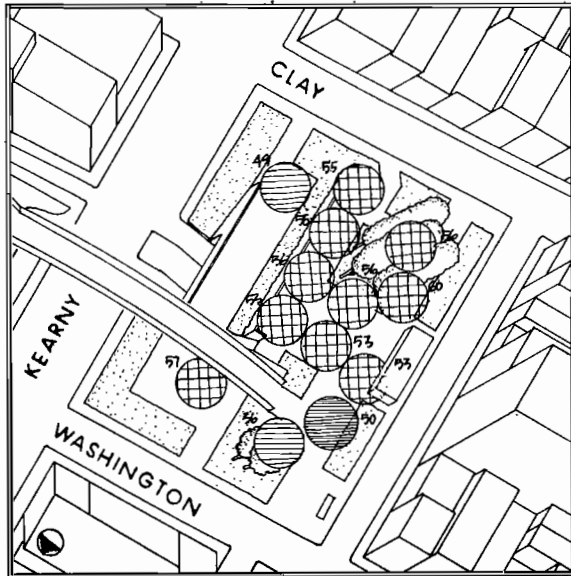

Existing Conditions

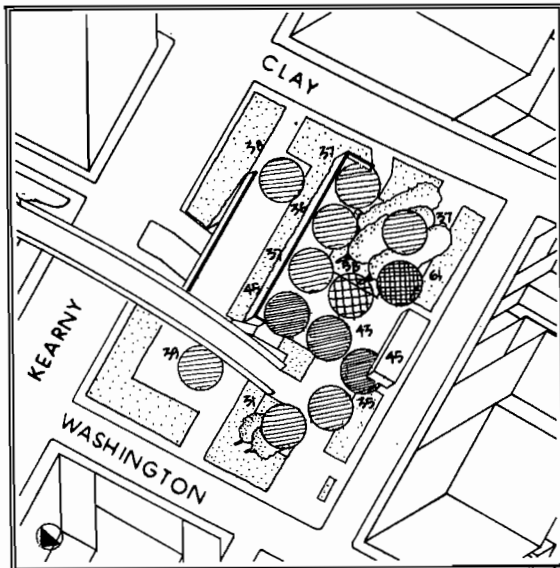

Development Under Current Controls

Portsmouth Square

Portsmouth Square's exceptionally low winds and high levels of sun availability combine to create unusually good winter thermal comfort levels under existing conditions. The square's comfort levels are reduced by 20% to 35% at most points in the development under existing conditions scenario, due both to increases in shading and local winds. The wind and shadow reductions brought about by the mitigated design are sufficient to restore comfort levels at most points back to their existing levels.

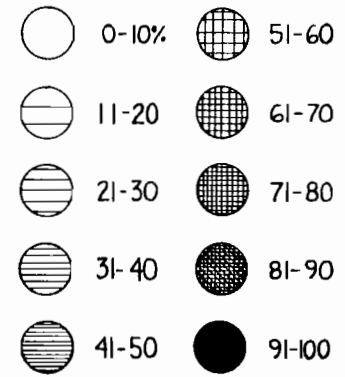

Mitigated Development

The drawings and text on the next pages summarize the results of the comfort modeling process. The numbers and circles located at each of the points indicate the percentage of time during the daylight hours of a particular season that sun and wind conditions would permit the maintenance of human thermal comfort.

Winter

Except for a few points subject to late afternoon shading and localized drafts, existing springtime thermal comfort conditions are exceptionally good. These comfort levels are not as severely affected by development under existing regulations as those in the winter. The most significant decreases take place at the north end of the park where there is some increase in morning and late afternoon shading. The design modifications of the mitigated scenario succeed in largely eliminating the comfort impacts at the park's northern end and maintaining the park's overall spring comfort at the levels that exist at present.



Existing Conditions

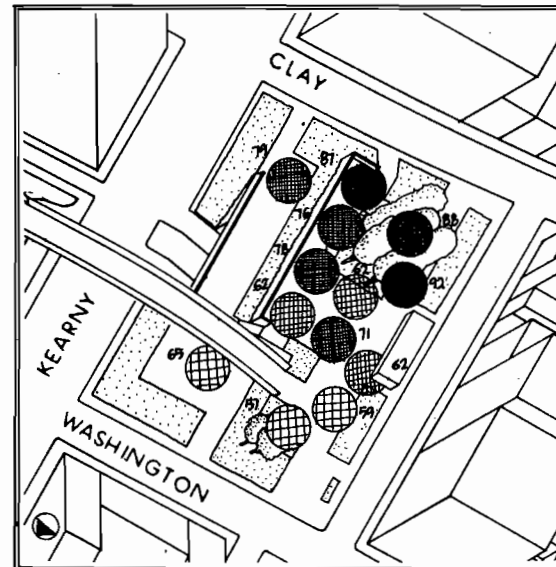

Development Under Current Controls

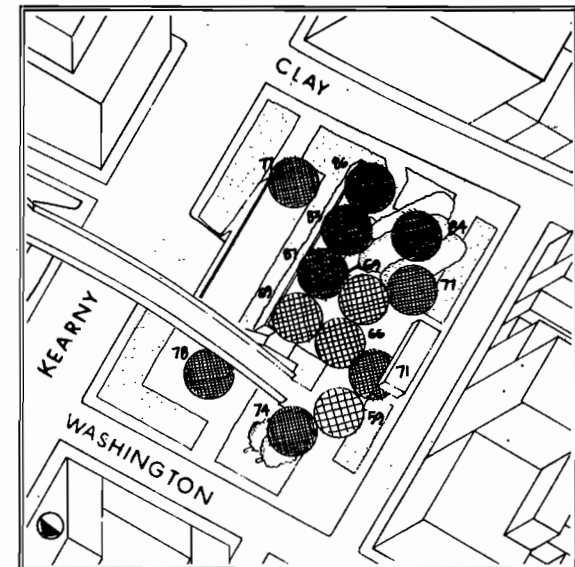

Mitigated Development

Spring



Existing Conditions

Under existing conditions, most points in Portsmouth Square are comfortable for virtually the entire day during the summer. The exceptions are several points in the middle of the square subject to partial shading and localized drafts. With development under existing regulations, increased winds and shading reduce the comfort hours by about 30% at the square's northern end. In the mitigated scenario, the comfort percentages at these points are partially restored to their original levels and comfort conditions elsewhere in the park are generally preserved.

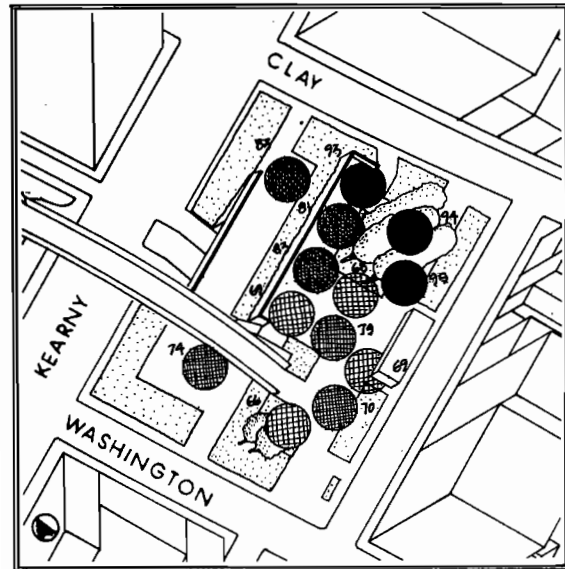
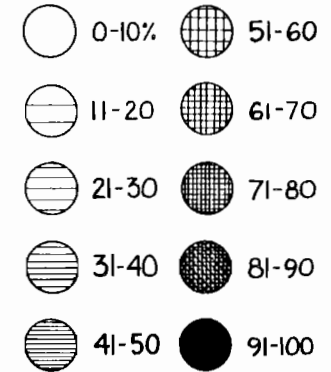

Development Under Current Controls



Mitigated Development

Summer

Portsmouth Square's existing fall comfort levels are relatively good, although shadows cast by nearby buildings create low comfort hour percentages at the park's southeast and northwest corners. With development under existing regulations, localized winds increase somewhat, and the area of the square subject to shading greatly increases, reducing the comfort hour percentages by nearly half at many points. The design modifications of the mitigated scenario mostly succeed in maintaining comfort conditions at their existing levels, although the park's southwest corner remains a problem area because of the mid-day shadows cast by the blocky building assumed for the site across Clay Street.



Existing Conditions

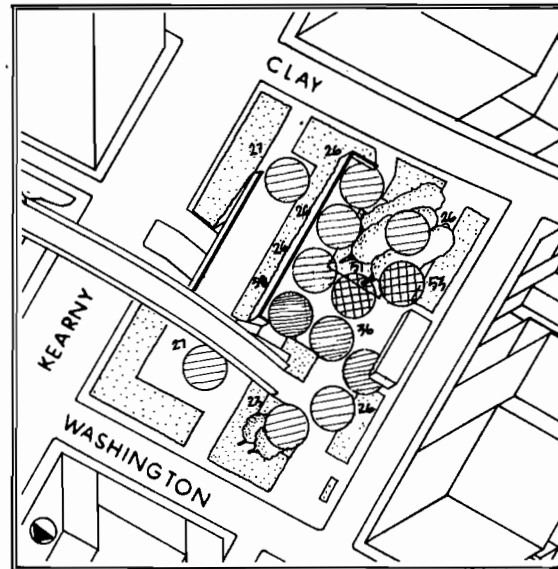

Fall

Development Under Current Controls

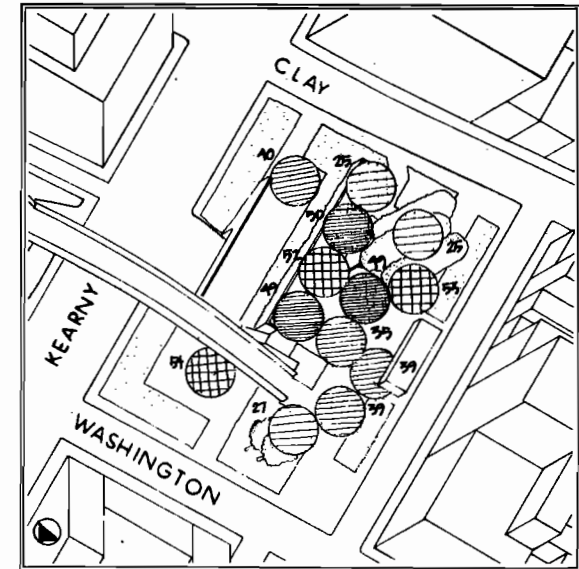

Mitigated Development

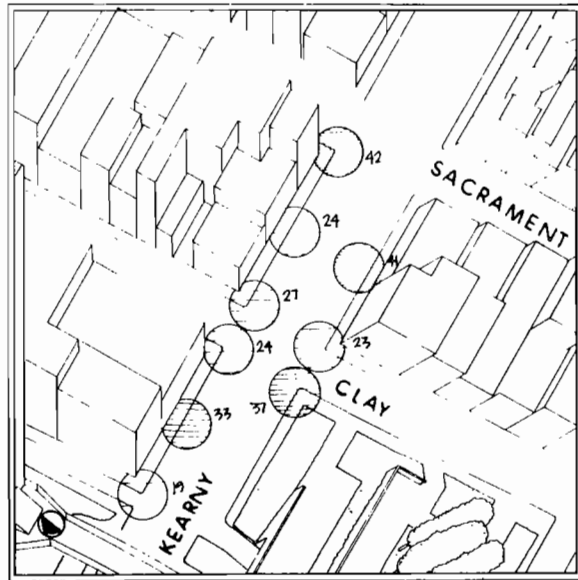

Existing Conditions

Kearney Street

Under existing conditions, the wintertime thermal comfort percentages along Kearney Street are somewhat below average to average, reflecting the fact that most of the points get sunlight for only short periods during the middle of the day. When development under existing development controls is modeled, the comfort levels at Clay and Kearney drop significantly due both to increased shading and to increases in street level winds created by the large towers assumed in that area. The mitigated development scenario significantly reduces the effect of the new buildings, restoring the comfort readings at most points to what they were under existing conditions. The only significant problem area is the west side of Kearney at Clay where little shadow reduction is achieved.

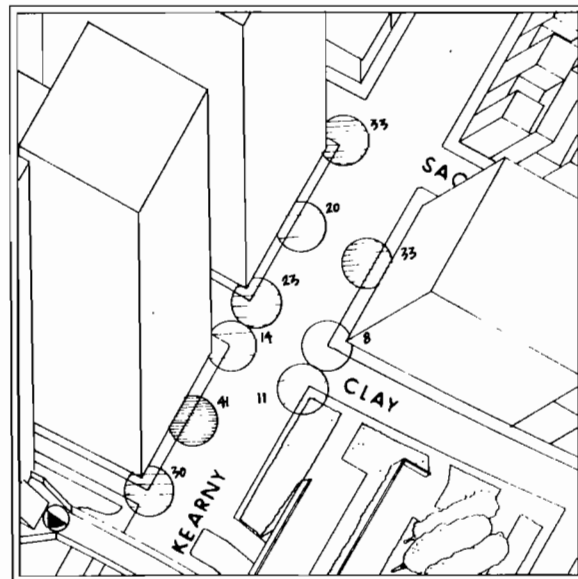
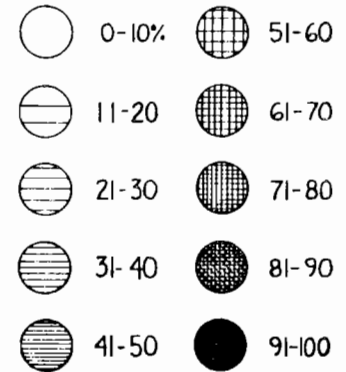

Development Under Current Controls

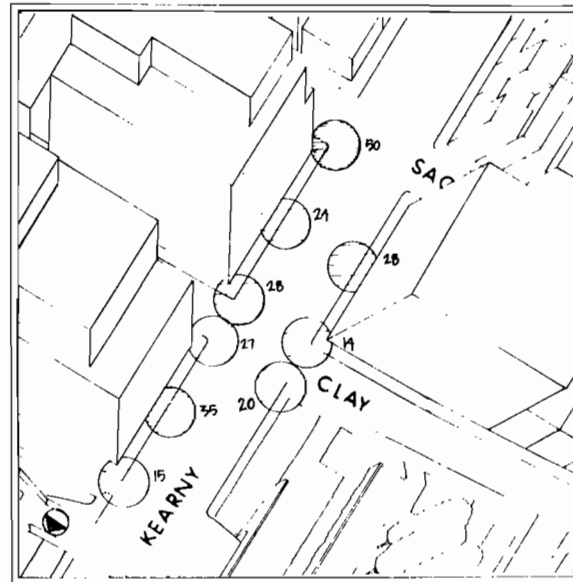

Mitigated Development

Winter

Spring thermal comfort conditions along Kearney Street range from fair to very good under existing conditions. The two low comfort percentages are primarily a product of limited sun access. The comfort percentages at most of the points are reduced by half or more with development under existing regulations, which greatly increases shading, and creates strong windflows at corners. The stepped back and slightly lowered buildings of the mitigated development scenario succeed in greatly moderating the impacts of the development, increasing comfort levels at most points to the levels prevailing under existing conditions.

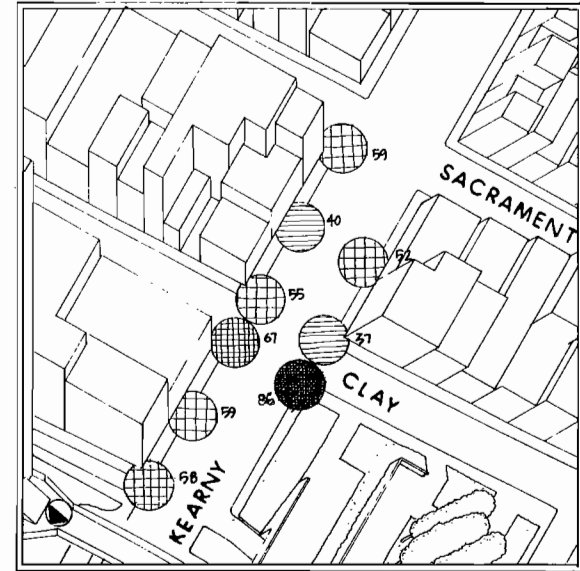

Existing Conditions

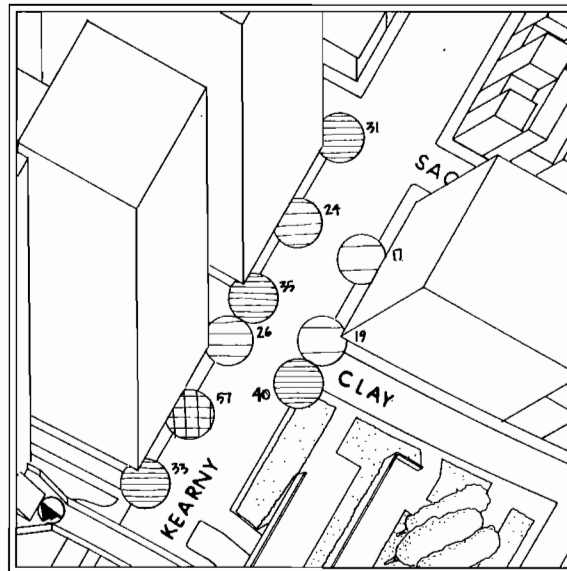

Development Under Current Controls

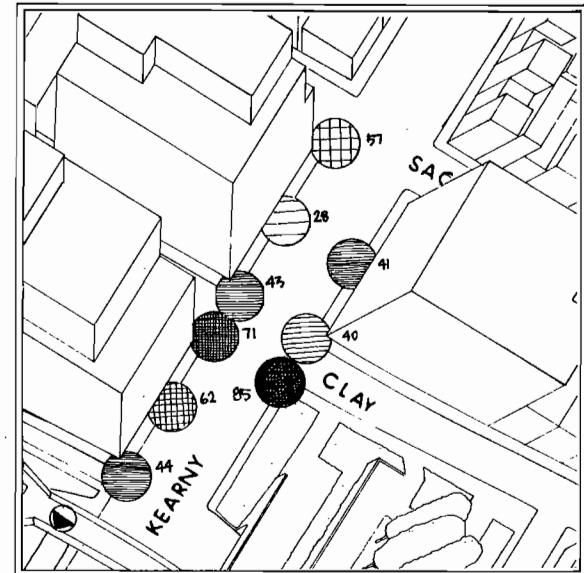

Mitigated Development

Spring

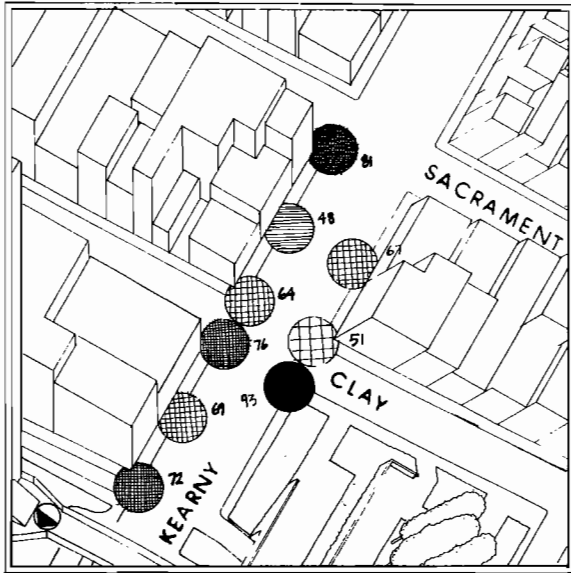

Existing Conditions

Kearney Street—Summers

Kearney Street's existing summer thermal comfort conditions are generally fairly good, reflecting good sun exposures and moderate wind conditions. The development under existing conditions scenario greatly increases shading and corner winds, reducing the comfort readings by 25% to 40%. The mitigated design significantly reduces the development's wind effects and partially reduces the shading effects, restoring the comfort percentages at most points to levels closer to what they are under existing conditions.

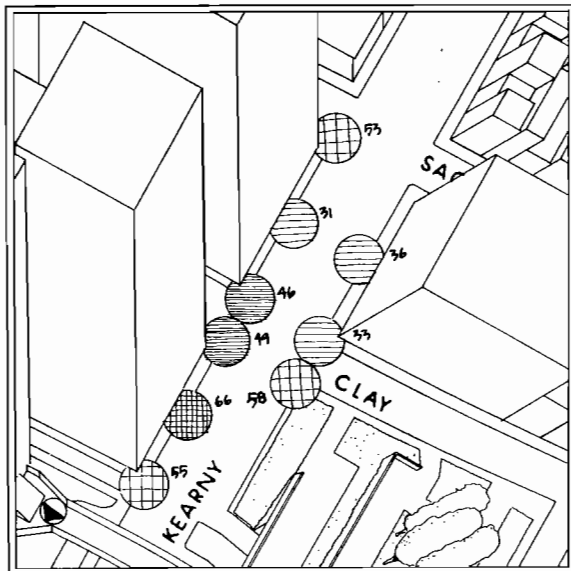
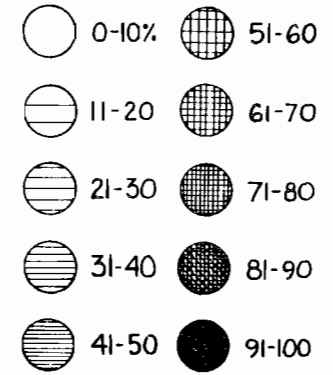

Development Under Current Controls

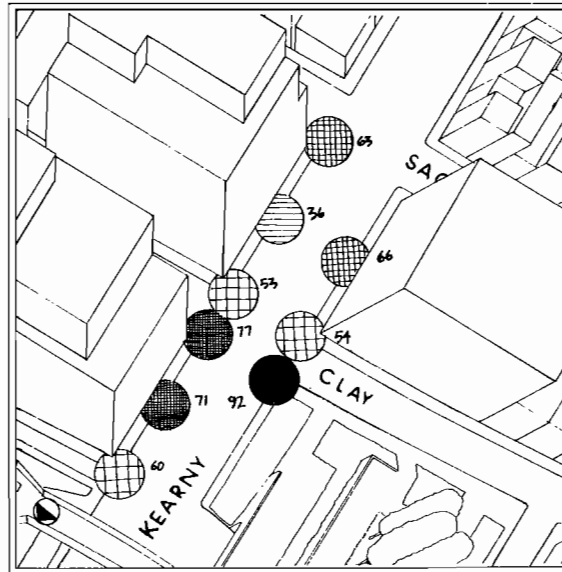

Mitigated Development

Summer

Thermal comfort conditions along Kearney Street in the fall are only fair under existing conditions. With development under existing controls, the comfort percentages at most points don't get much worse, although a severe drop in comfort hours does take place on the east side of Kearney at Clay. Under the mitigated scenario, improved sun access and slightly moderated winds cause the comfort percentages on the east side of Kearney to return to their original levels. On the west side of Kearney, shadows cast by the blocky building assumed for the site between the alley and Clay cause the comfort percentages to remain quite low.

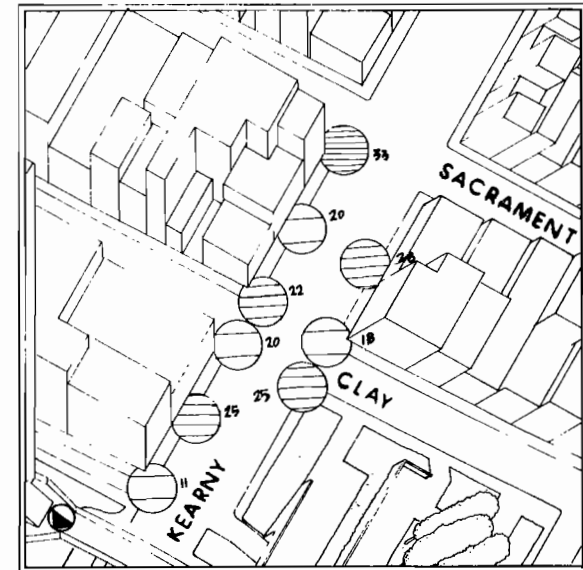

Existing Conditions

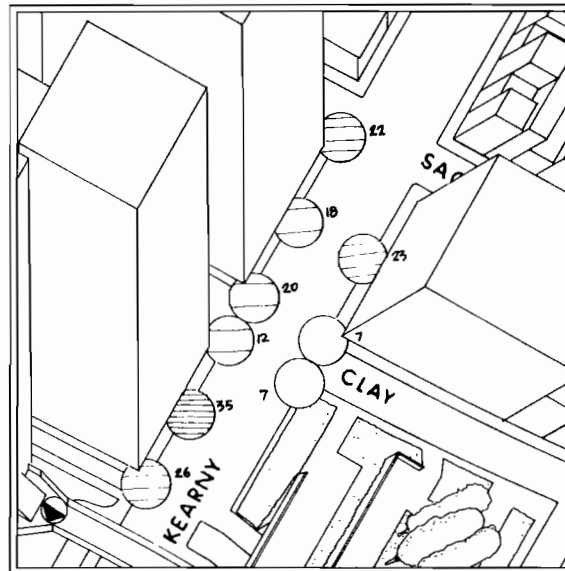

Development Under Current Controls

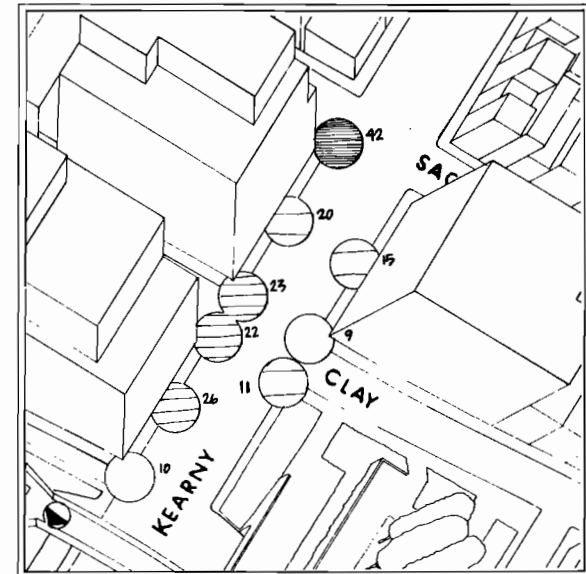

Mitigated Development

Fall



Tenderloin

This study area (Figure 16) takes in a large portion of the Tenderloin, the high density commercial and residential district lying to the west of Union Square. The area's easternmost blocks function as a part of the Union Square hotel district and includes the new Air-porter bus terminal and the 40 story

Hilton Hotel Tower at Taylor and Ellis. In the rest of the area, most of the structures are 4 to 6 story masonry hotel and apartment buildings dating from the post earthquake reconstruction period. Many of the old hotels, originally designed for tourist occupancy, have evolved into residential hotels serving the needs of the low income elderly, immigrants, and transients. The area is now one of San

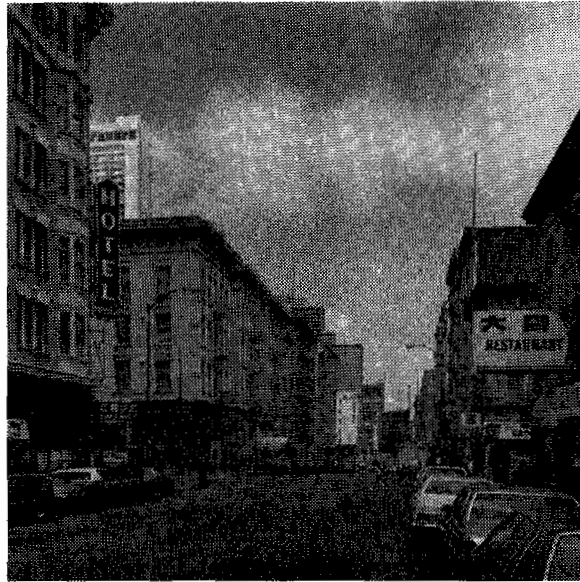

Figure 16. Tender...

Francisco's most dense residential neighborhoods. In most of the area, the many first floor commercial uses are geared to meeting the daily needs of the local population. In addition, there is a concentration of tourist-serving facilities close to the Airporter terminal, and a major adult entertainment district in the blocks closest to Market Street.

This area is under considerable pressure for change. It lies directly in the path of the expanding Union Square Hotel District. A 1000 room Ramada Inn is under construction just to the east of the area at Ellis and Mason, Holiday Inn is planning an 800 room facility east of Mason in the block between Ellis and Eddy and the Hilton has received final approval for a 19 story addition that would increase its room total from 1600 to over 2000. In addition, some of the transient hotels have been upgraded, and converted back into facilities for the more lucrative tourist market, and there is pressure for additional conversions. On the area's northern and western fringes, there has also been a minor trend towards gentrification as middle income people move in to take advantage of the area's central location, good public transportation, and lower rents.





All of these changes are being resisted by the neighborhood's advocacy organizations which stress the need to protect the area's supply of low cost housing. They argue that although much of the area's housing may be substandard in some way, it is a valuable resource because it provides affordable housing for people who have no place else to go, and because the area's central location and proximity to social services is important for people with little money or mobility.



To some degree, the neighborhood organization's concerns are being heeded. Conversions of transient hotels to tourist hotel use have been limited, and approvals for construction of new tourist hotels have been tied to agreements to provide monies for neighborhood improvements and social services. City and private agency programs for the area stress building rehabilitation aimed at providing improved housing for the area's existing residents. To reduce the economic pressures for replacement of the existing buildings with larger structures, the Downtown Plan proposes reducing the 290 foot height limits that now exist in most of the area down to 80 feet.

Residents of this area have a particularly high need for public open space to provide for recrea-

tion, socializing and relief from their often substandard and crowded indoor living conditions. Because most of the area's buildings completely cover their lots, little private open space exists. At present, there is little public open space as well, so sidewalks are important for children's play and adult socializing. Because of the uniform and moderately low building heights that now prevail in most of the area, sidewalk comfort conditions are generally acceptable, with a high level of sunlight availability, and few unusually bad wind conditions. The major exception is in the area around the Hilton Hotel tower. The downdrafts produced by the tower sometimes create sidewalk level winds that are so strong that they impede pedestrians.

Preservation of the area's favorable outdoor comfort conditions, and avoidance of problems like those occurring around the Hilton, provide another argument for the lowered height limits the Downtown Plan recommends. To help remedy the area's critical need for more open space, a park is now being constructed adjacent to the Airport terminal on the block bounded by Eddy, Ellis, Jones and Taylor Streets. Any new development proposal for the area immediately surrounding this site will have to be carefully evaluated to protect the



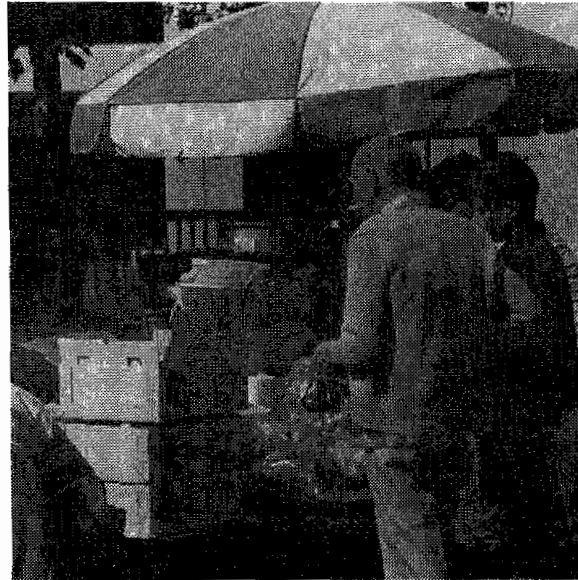

park's solar access and to prevent creation of undesirable wind conditions.

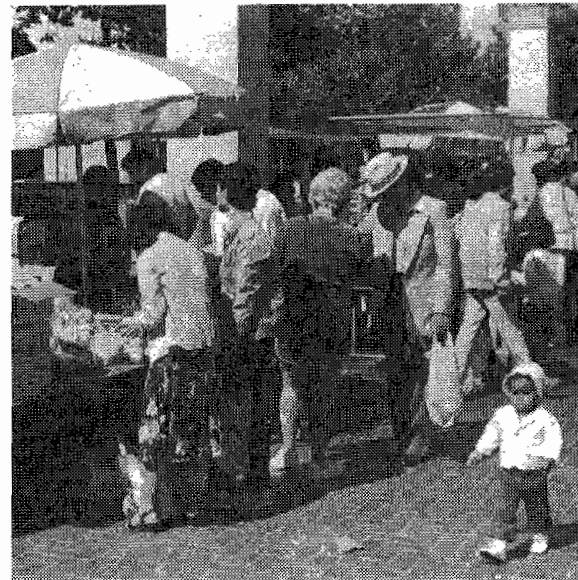

Tenderloin

The alternative development scenarios modeled and tested for this area assumed that new buildings could be constructed on the sites indicated on Figure 17. These sites would, theoretically, be subject to change in the future, and more importantly, they reflect varying relationships to different street types and the Boedekker Park site. The development under existing regulations scenario reflects a direct application of the current zoning code. The mitigated scenario was based on an application of the recommendations contained in the North of Market Re-Zoning Study as well as solar cut-off angles recommended in the Sun and Light for Downtown San Francisco report and wind-reducing building design principles. The mitigated scenario represents approximately 15% less space than what was assumed in the existing regulations development scenario.

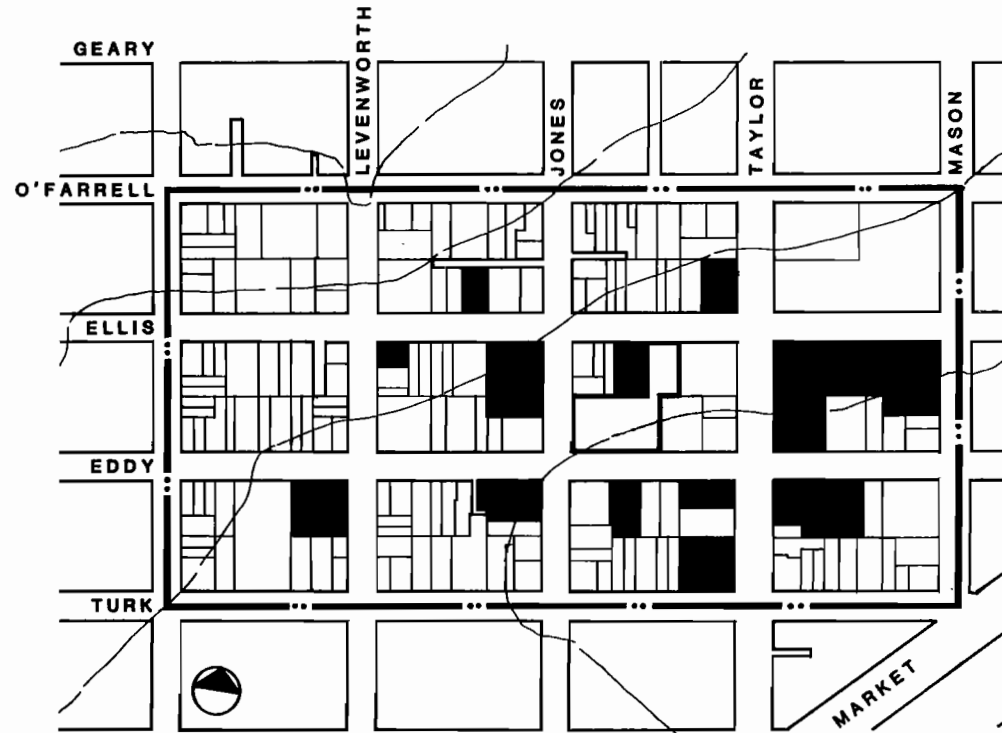
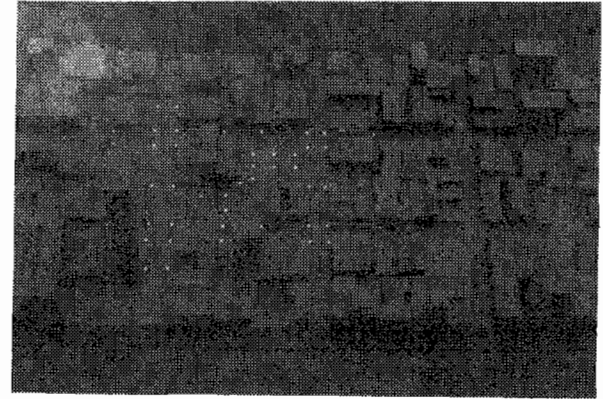

Figure 17. Representative Development Sites in the Tenderloin



Aerial Photo of the Tenderloin Area



Existing Conditions

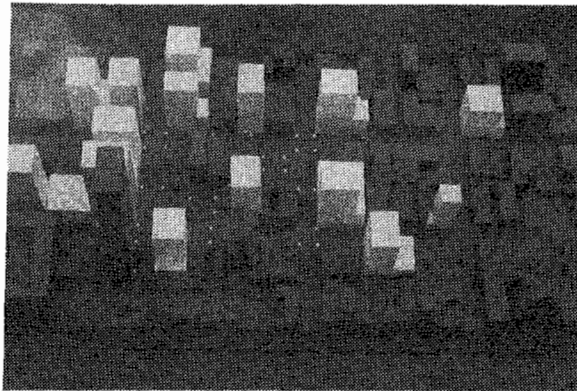

Full Development under Proposed
Downtown Plan

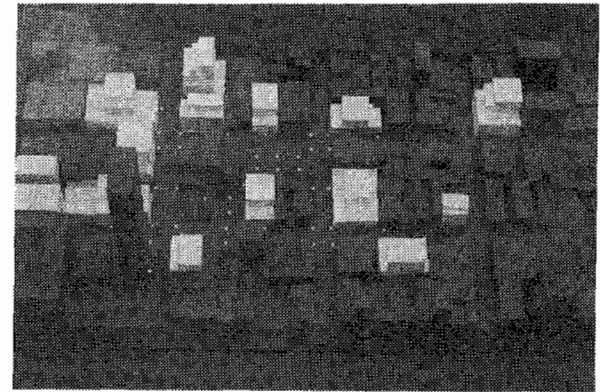

Mitigated Development

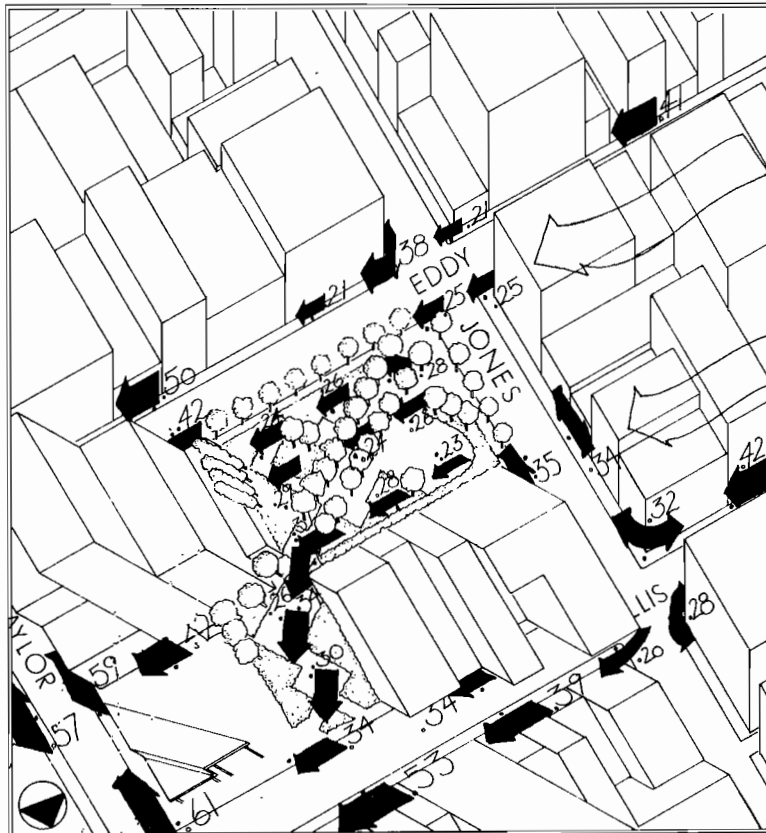

Existing Conditions

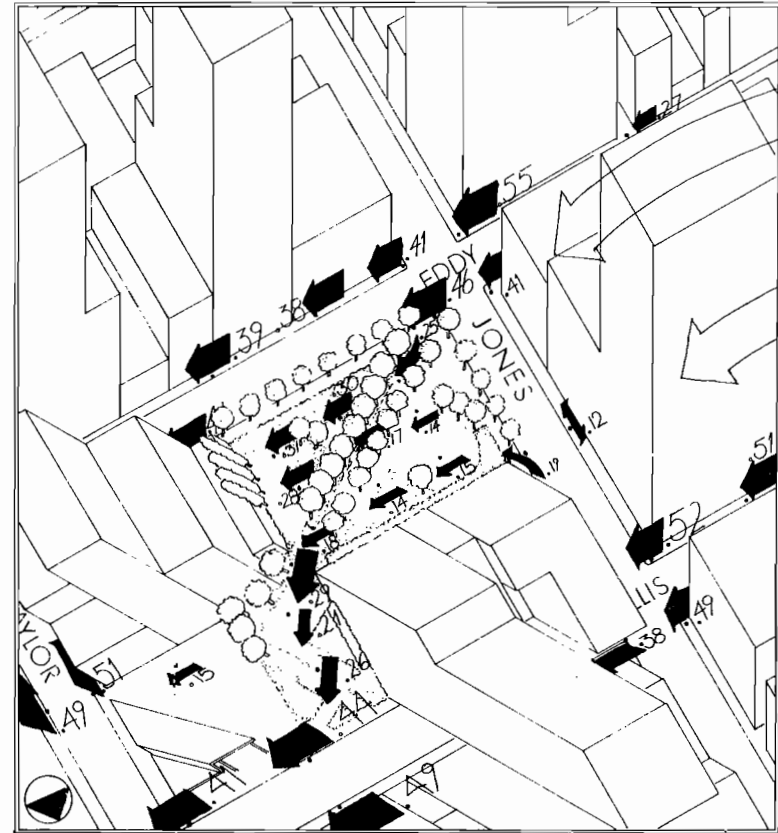

Development Under Current Controls

Wind from the West

The drawings and text on the next pages summarize the results of the wind tunnel tests. The numbers located at each test point are ratios that represent the relationship of the street level wind speeds to the wind speeds measured at the weather station. The ratios have been adjusted so that they also reflect the effects of gustiness.

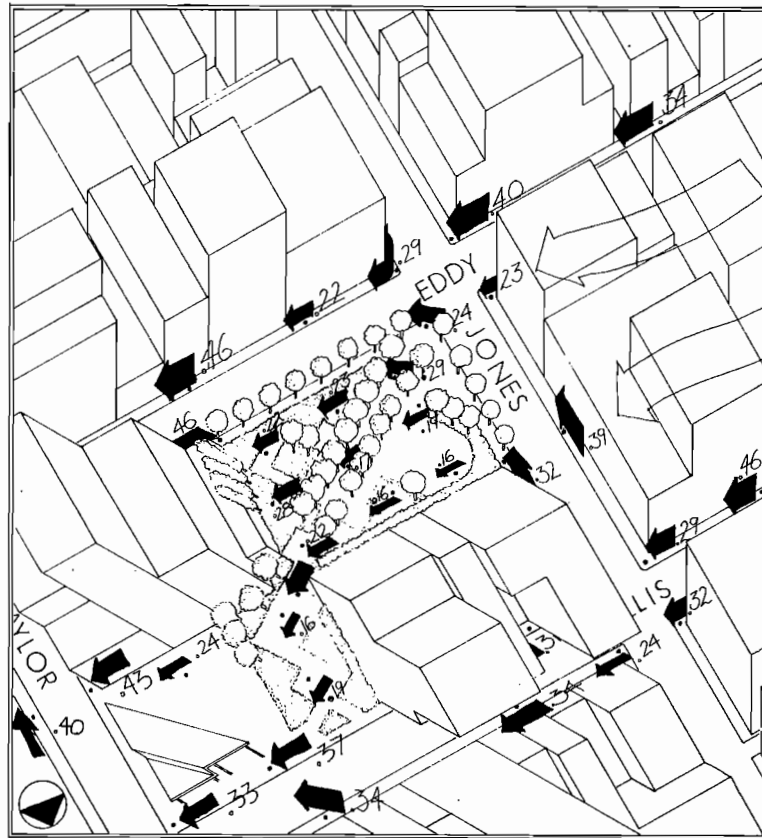

Mitigated Development

Boedekker Park

Under existing conditions, both sections of the Boedekker Park site are well sheltered from western winds, resulting in relatively low wind ratio readings for all data points. Channel and corner effects produce somewhat higher ratios on the adjacent east-west streets. The most extreme readings, which are around the Airporter Terminal, are related to the taller buildings to the east.

When development under existing (pre Proposition K) regulations is modeled, the new buildings assumed further shelter the park site, significantly lowering the wind ratios at most points. (Although the ratios increase slightly at the points closest to Eddy). Wind ratios on most of the surrounding streets are also lowered, although corner effects increase the readings at the intersections along Jones Street. When the mitigated development scenario is modeled, the ratios drop at most points on the park and surrounding streets, reflecting a continuation of the shelter effects, and a reduction in corner and channel effects.



Existing Conditions

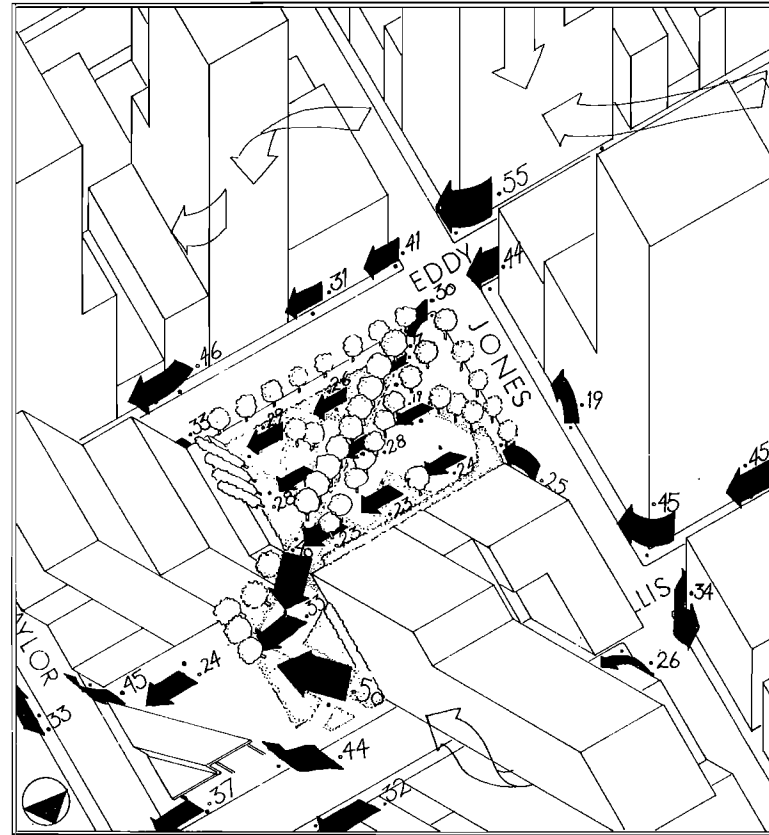

Development Under Current Controls

Wind from the Northwest

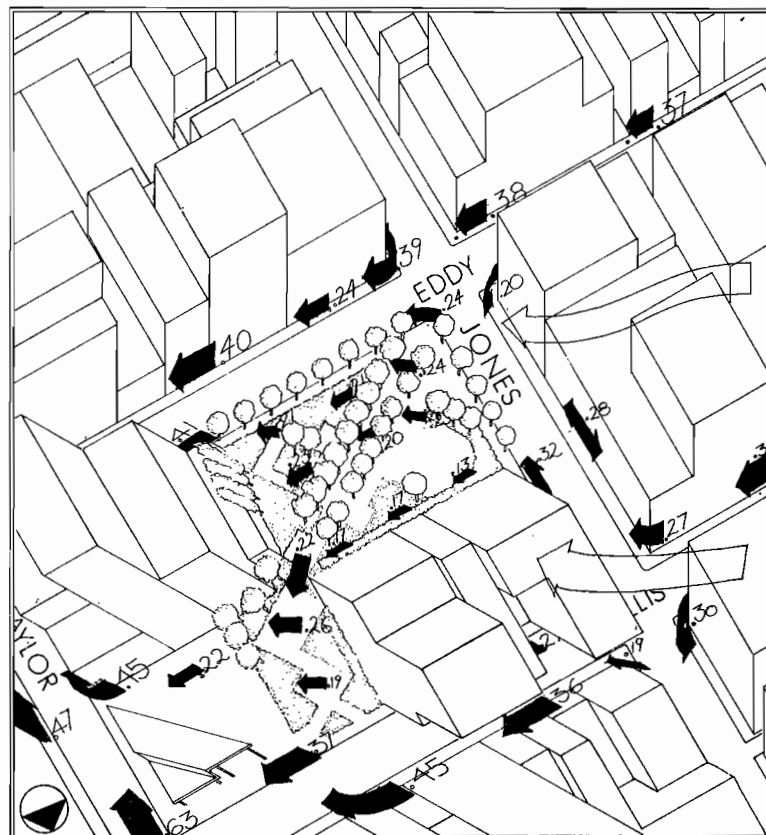

Mitigated Development

Northwest winds produce slightly higher winds in the Boedekker Park site than do westerly winds when existing conditions are modeled. The .47 ratio at the site's southeast corner suggests wind conditions at that point are outside of the comfort range for park users. With the exception of the area around the Airporter Terminal, wind ratios in the surrounding streets are in the low to moderate range. The Airporter Terminal area appears to be affected by downwashes and vortexes generated by buildings to the east. The development under existing conditions scenario has mixed effects on the park site; ratios at most points, including the one on the southeast corner are lowered. However, a reading of .50 is created in the park's northeastern segment. The development modeled tends to shelter the surrounding streets, lowering ratios at many points, most notably those around the Airporter Terminal. High ratios are generated at some of the corners, but all street readings fall well within the acceptable range. The mitigated scenario produces low ratios at points in the park, including those that had been problem areas under the other two conditions. The ratios at most points along the streets are also lowered in comparison to the other conditions. The major exception is the corner of Taylor and Ellis by the Airporter Terminal.

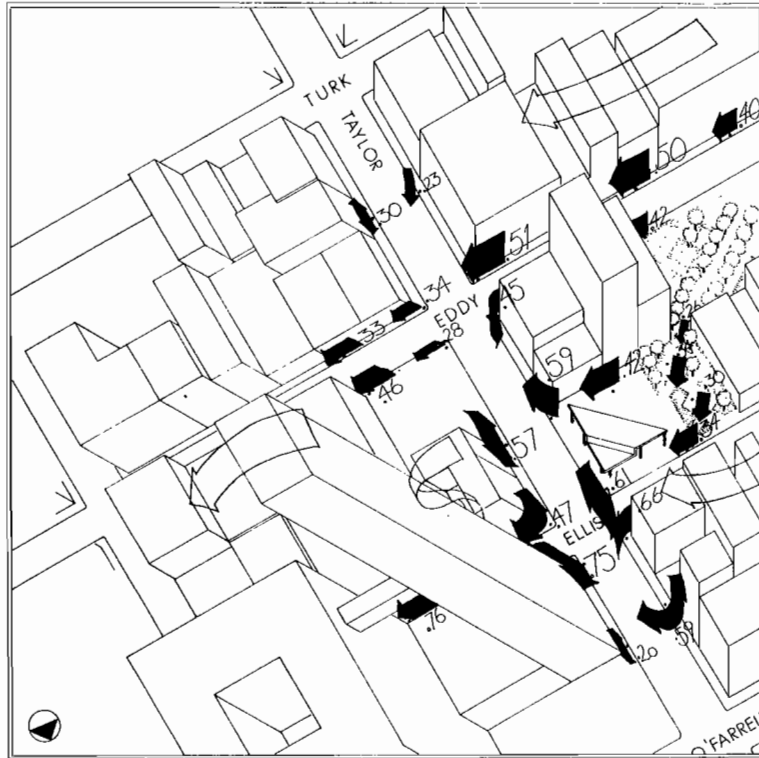

Existing Conditions

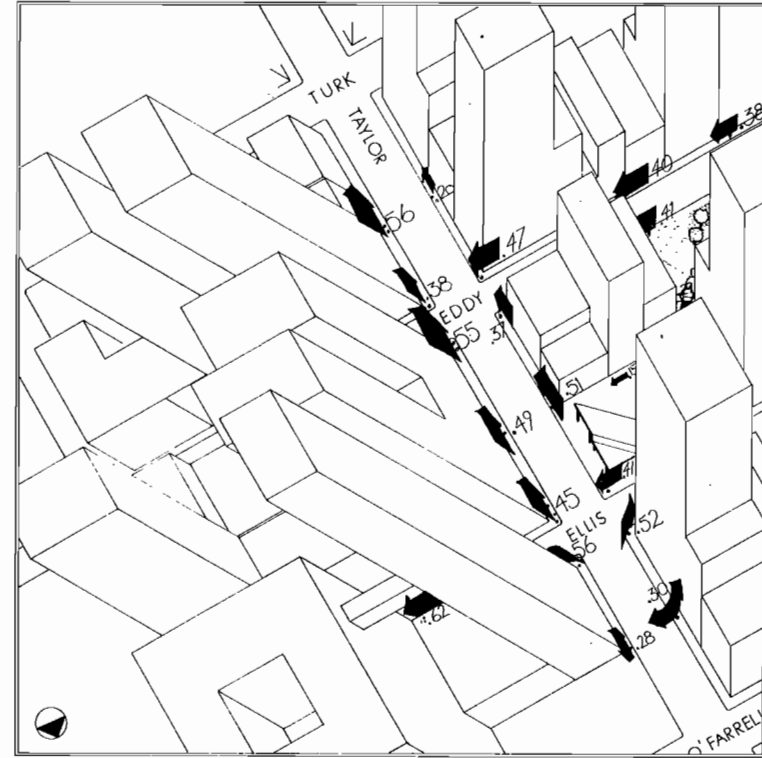

Development Under Current Controls

Wind from the West



Mitigated Development

Taylor Street: Wind from the West

Under existing conditions, west winds create relatively windy conditions at street level in most of this area. The Hilton Hotel tower produces a severe downwash and corner effect at its base, and the eddy produces another extremely high wind ratio around the corner on Ellis Street. Channel and corner effects produce moderately high ratios along Eddy and Ellis Streets. When development under existing regulations is modeled, a sheltering effect is created that reduces the ratios at the base of the Hilton tower to levels that are still high, but within the acceptable range. The additional buildings have a mixed effect on the rest of Taylor Street; some ratios increase, and some decrease, but all remain within the moderately high but acceptable range. Under this scenario, the wind flows along Ellis Street are slightly reduced. Under the mitigated development scheme, the sheltering effect of the Hilton tower is reduced, producing somewhat higher ratios at the tower's base than in the previous scenario. On the rest of Taylor Street, the ratios are reduced, but are still somewhat higher than under existing conditions. Along Eddy Street, the effect continues to be mixed, with some of the ratios fluctuating upwards, and others downward.



Existing Conditions

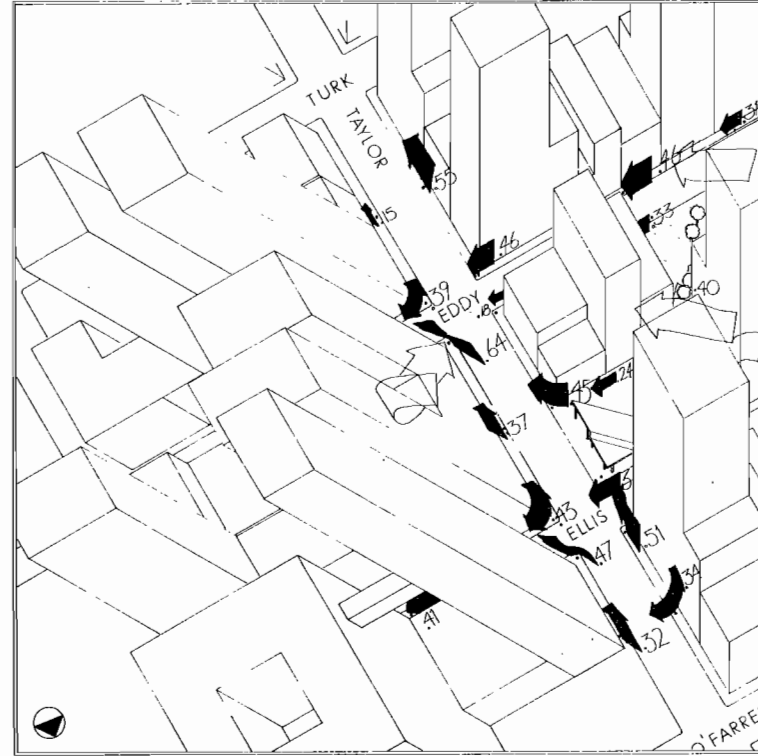

Development Under Current Controls

Wind from the Northwest

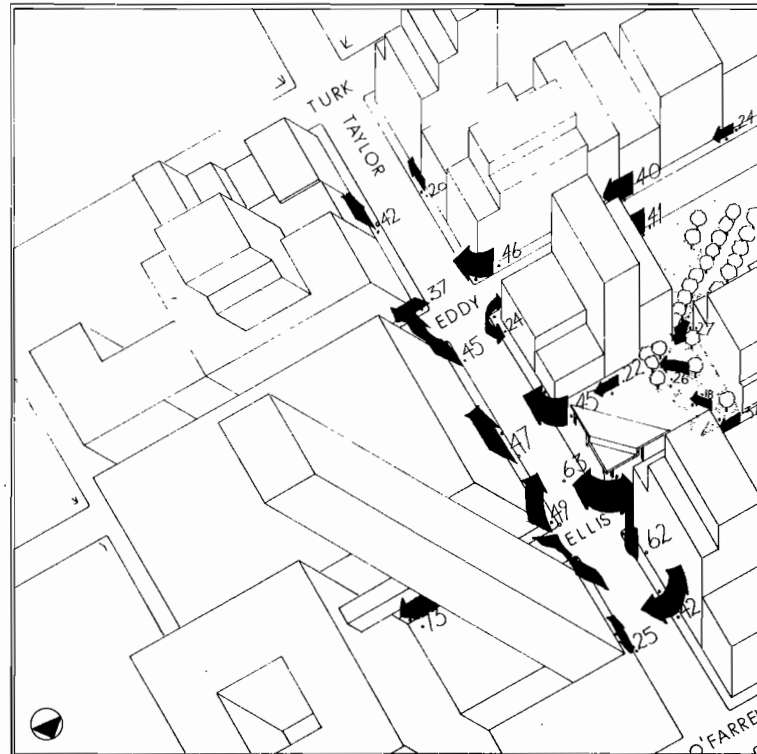

Mitigated Development

When the wind is from the northwest, extremely high wind ratios are created at the base of the Hilton Tower under existing conditions. The downwash and corner effects produce a ratio of .81 at Taylor and Ellis, and the eddy produces an .84 ratio (the highest found in this study) around the corner on Ellis. Ratios in the .60 range occur at several other points along Taylor between O'Farrell and Eddy. Ratios on the streets in the rest of the area tend to be in the moderately high range. The new buildings assumed in the development under-existing-regulations scenario significantly reduce the ratios around the Hilton Tower, bringing them well into the acceptable range, and with a few exceptions, moderates the ratios in the rest of the area. The mitigated scenario reduces the sheltering effect around the Hilton Tower, producing wind ratios nearly as high as those under existing conditions. In the rest of the area, the ratios generally tend to be a bit lower than those occurring under the other conditions.



Existing Conditions

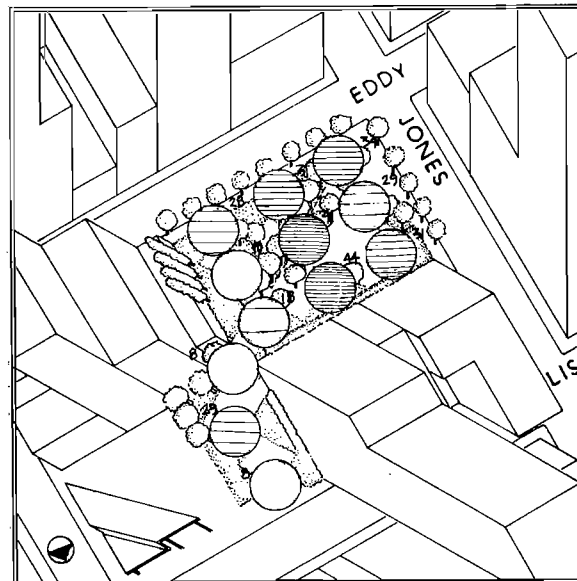

Development Under Current Controls

Boedekker Park

The existing winter thermal comfort levels on the Boedekker Park site range from fair to good, but in general, they are not as consistently high as those on Portsmouth Square, which is better sheltered from the winds, and is less subject to shading. The high new buildings it is assumed would be constructed around the park with development under existing regulations would greatly increase the shadows on the site and would increase ground level wind flows at some points. The result would be to produce significant drops in comfort levels in all areas of the park. At several points, the park would be comfortable only 8 to 10 percent of the time. The lowered heights and stepped back designs of the buildings in the mitigated development scenario succeed in reducing the shading and wind impacts on the site, preserving comfort conditions at approximately existing levels.

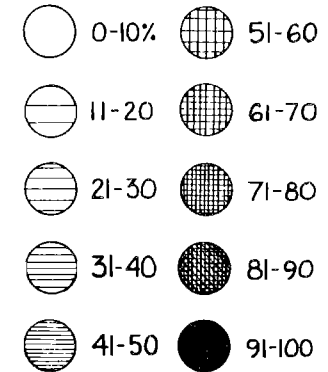

Mitigated Development

The drawings and text on the next pages summarize the results of the comfort modeling process. The numbers and circles located at each of the points indicate the percentage of time during the daylight hours of a particular season that sun and wind conditions would permit the maintenance of human thermal comfort.

Winter

In the spring, existing comfort levels on the Boedekker Park site are generally very good, but they are still somewhat lower than those in Portsmouth Square. Nearly continuous shading on a portion of the Park's northern leg creates a localized comfort problem there. The reduction in comfort levels created by the development under existing regulations scenario are not as severe as those occurring under winter conditions. Although the comfort percentages become lowered somewhat, they remain within a generally acceptable range. The mitigated scenario produces comfort levels that are, on the whole, better than those produced in the unmitigated development case, and nearly as good as those that exist at present.



Existing Conditions

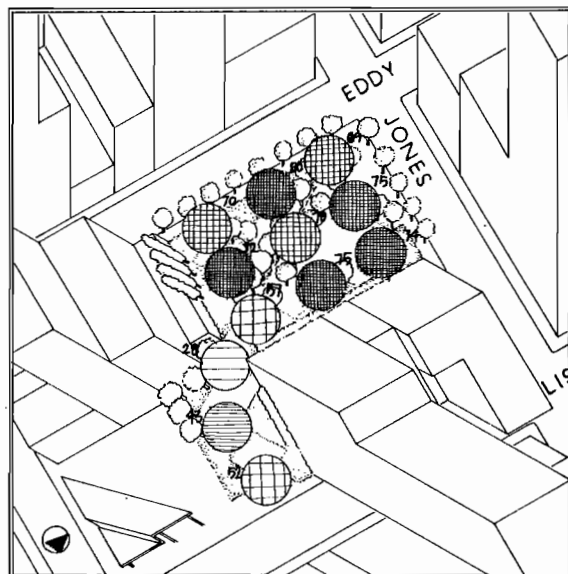

Spring

Development Under Current Controls



Mitigated Development



Existing Conditions

In the summer, the existing thermal comfort conditions on the Boedekker Park site are generally very good, and most of the park is almost as comfortable as Portsmouth Square. The exception is the heavily shaded point located where the two legs of the park join, which is comfortable less than 50% of the time. When development under existing regulations is modeled, the comfort levels at most points decrease only slightly because with the high summer sun, increased shading is not as much of a problem as it is in other seasons. The mitigated development scheme restores comfort levels at most of the points to their original levels, and even increases the comfort percentages at some points by reducing ground level winds.

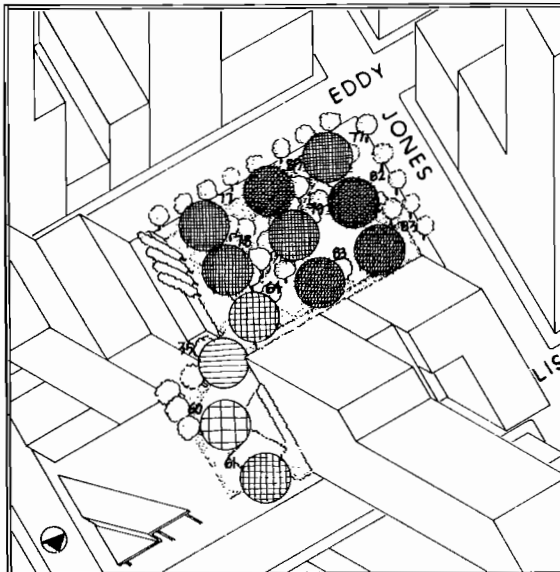
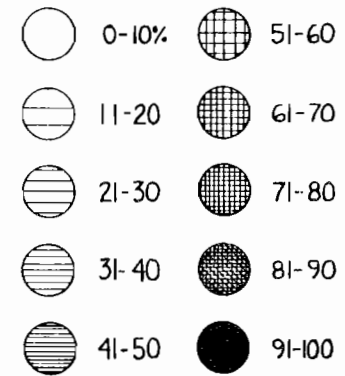

Development Under Current Controls



Mitigated Development

Summer

Under existing conditions, fall thermal comfort levels on the Boedekker Park site are relatively good, but the site's greater shading and higher winds make the park somewhat less comfortable than Portsmouth Square. The increased winds and shadows produced in the development under existing regulations scenario significantly decrease the amount of time the park is comfortable, and create exceedingly poor comfort conditions in the site's northern leg. The mitigated scenario reduces much of the development impact on comfort levels in the main portion of the site, and although the comfort percentages in the park's northern leg improve somewhat, they remain at relatively low levels.



Existing Conditions

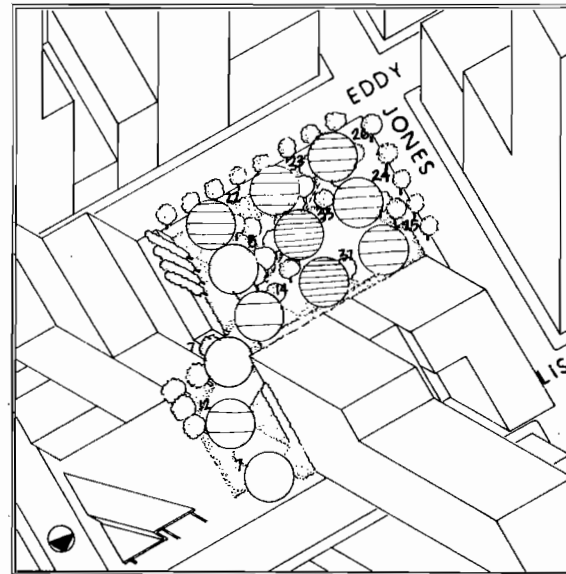

Fall

Development Under Current Controls

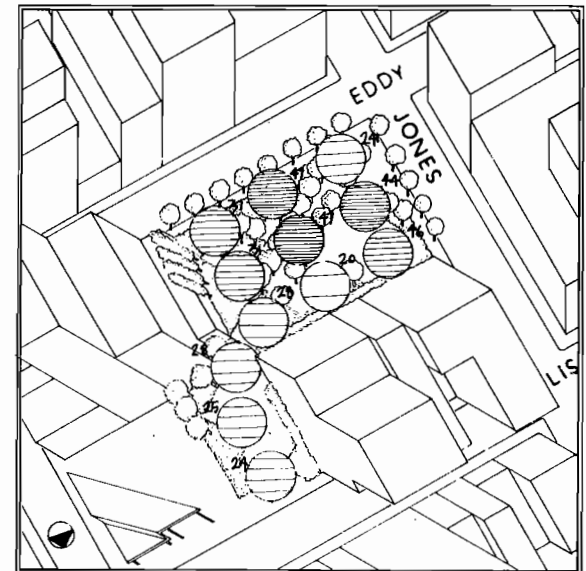

Mitigated Development

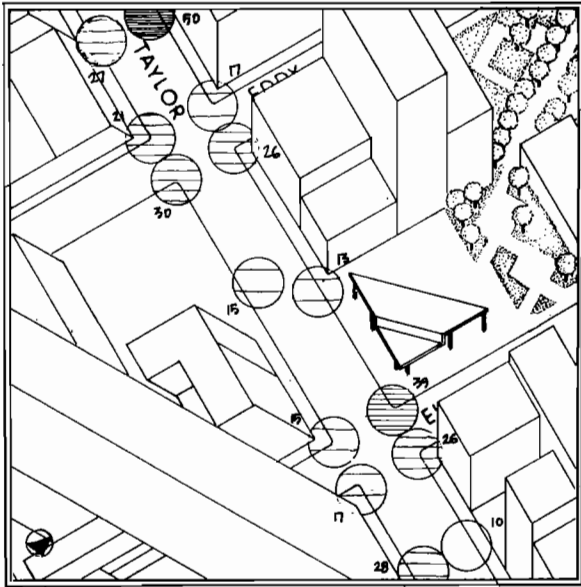

Existing Conditions

Taylor Street

On Taylor Street, shading and high street level winds combine to create generally low comfort levels at most points under existing winter conditions. The lowest readings are at corners and other places where localized wind conditions are particularly severe. With development under existing regulations, the comfort percentages decline to even lower levels at most points, reflecting increases in shading for the most part, but also reflecting increased winds in a few cases. On the whole, these comfort impacts are not reduced by the mitigated development scheme.

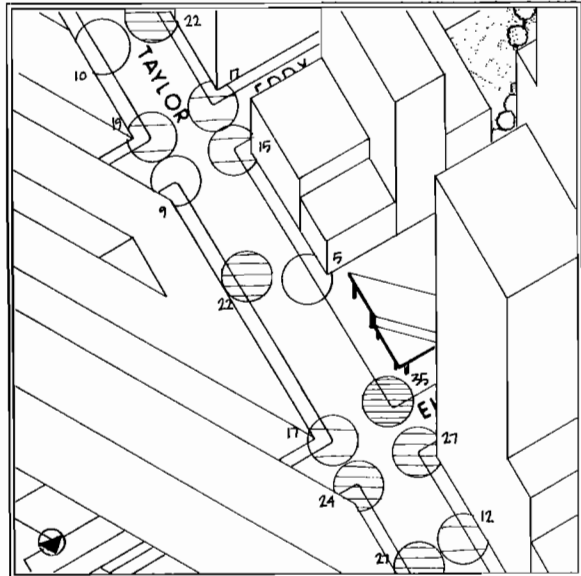
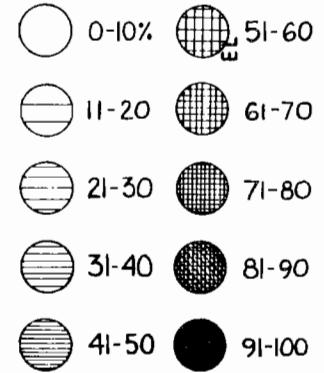

Development Under Current Controls

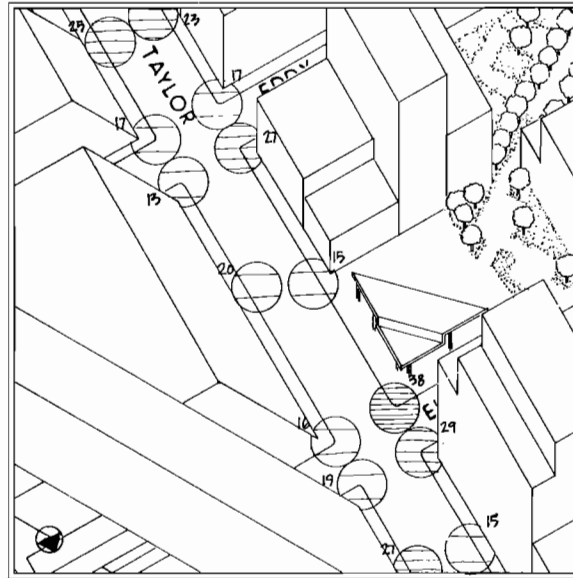

Mitigated Development

Winter

Under existing spring conditions, high local wind flows create very low comfort levels at Taylor and Ellis. With development under existing regulations, that area's already poor comfort conditions remain about the same, but further south, increases in shading cause comfort levels to drop considerably. Because the mitigated development scenario does not significantly decrease the high winds at Taylor and Ellis, most comfort percentages there do not improve appreciably. Further south on Taylor, some of the comfort readings improve, but continued shading and high winds keep many of the points at very low comfort levels.

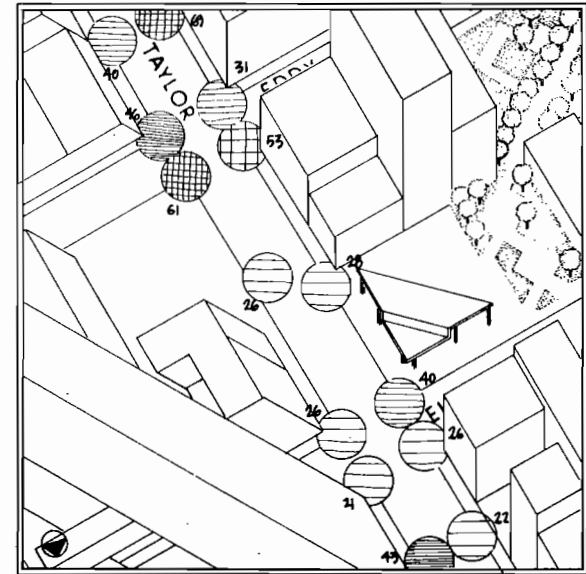

Existing Conditions

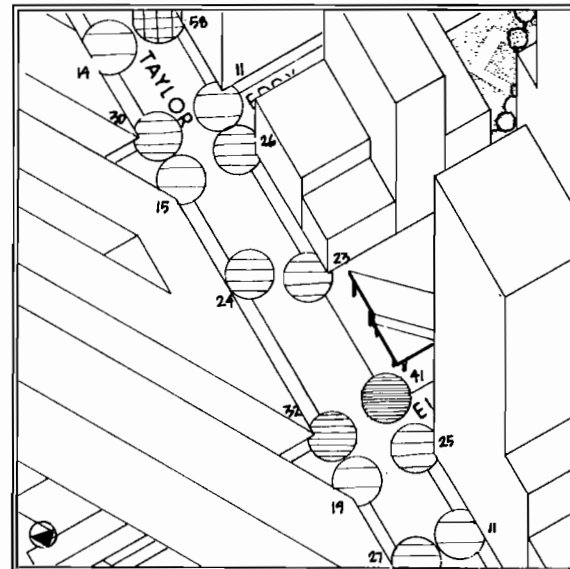

Development Under Current Controls

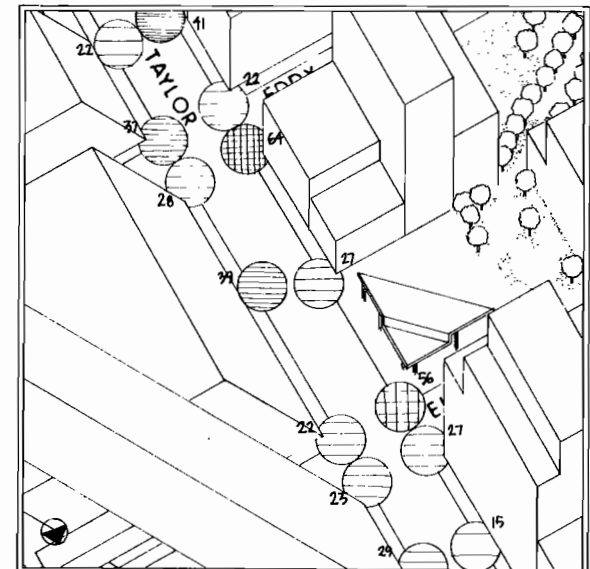

Mitigated Development

Spring

Under fall conditions, existing comfort levels at most points along Taylor Street are exceptionally low, the product of shading and extreme wind conditions. With development under existing regulations, most of the comfort percentages decline even further. The mitigated development design has very little effect on improving the comfort conditions because of continued shading and the difficulty involved in reducing the disturbed wind patterns around the Hilton Tower.

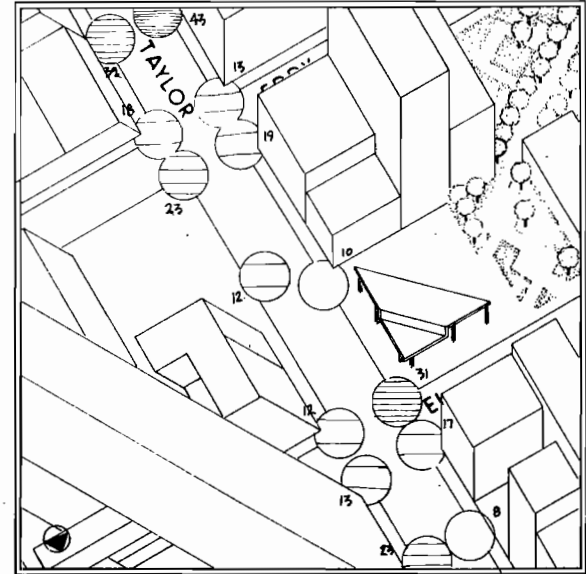

Existing Conditions

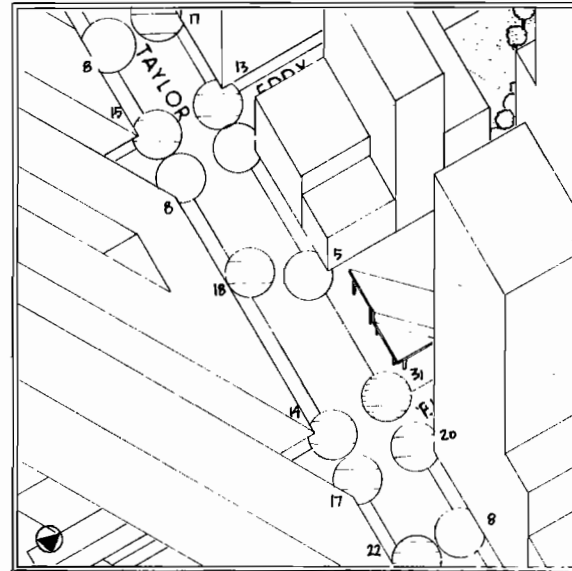

Fall

Development Under Current Controls

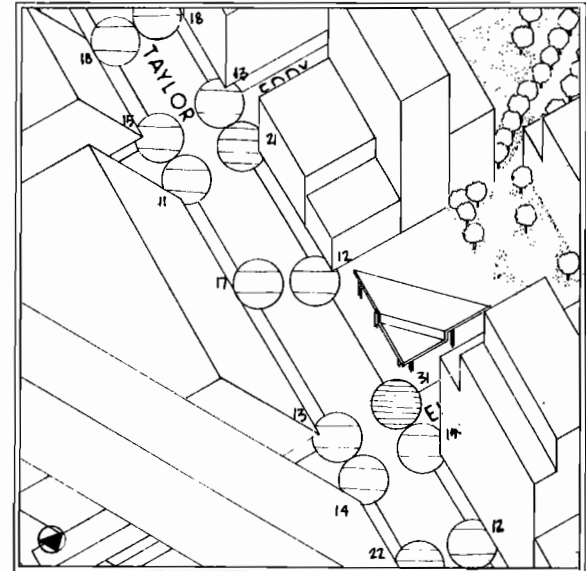

Mitigated Development



Van Ness

The corridor along Van Ness Avenue is increasingly being viewed as a good site for the development of new high density housing. The shift of automobile showrooms and service facilities from Van Ness Avenue to a new auto row south of Market is freeing up space along Van Ness on which housing could be

developed. Locationally, the area is well suited to high density housing because it is just a mile from the Financial District, has a high level of public transportation service, and is on the edge of the well established Pacific Heights residential area.

The portion of the corridor along Franklin and Gough Streets is

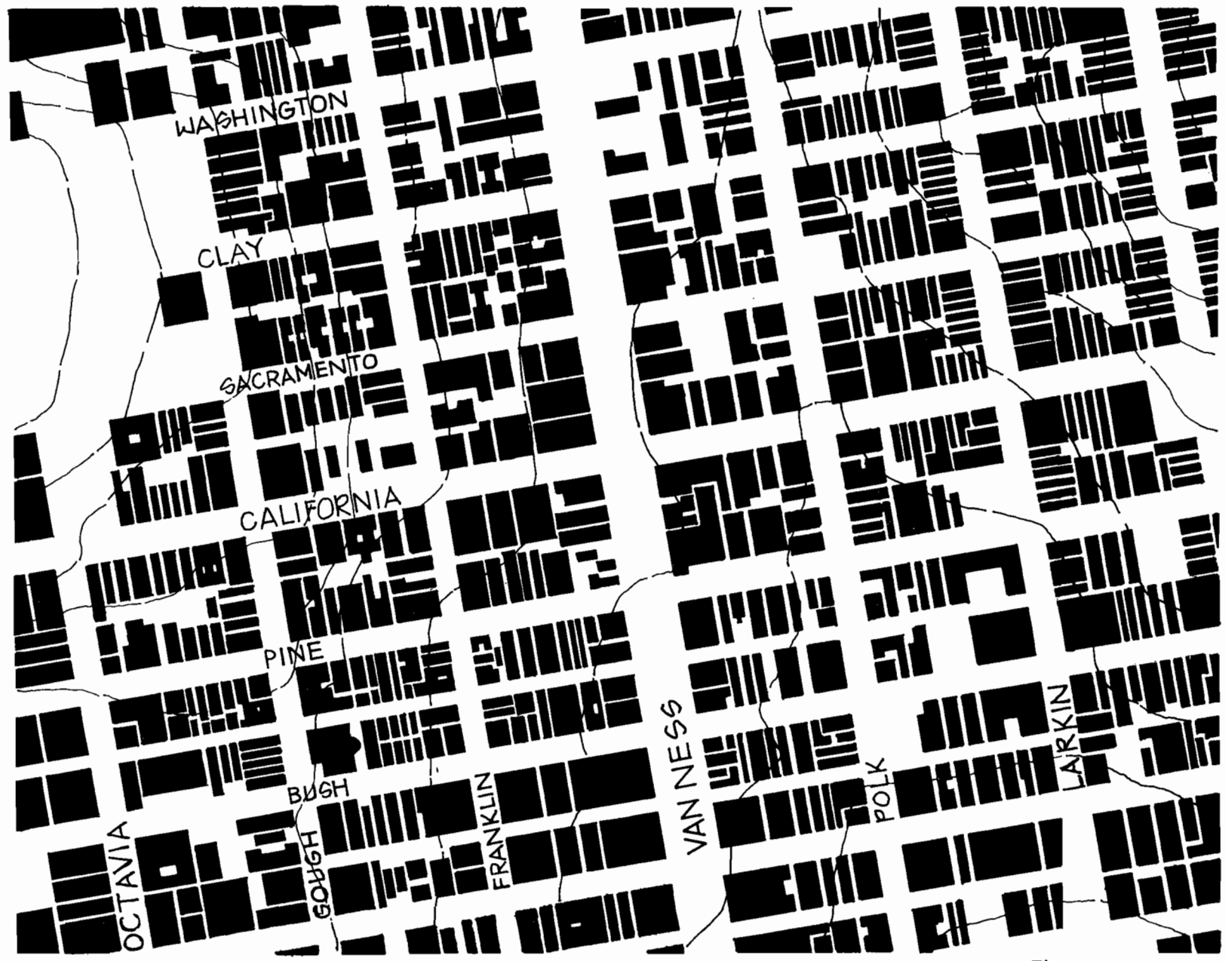

Figure 18. Van Ness

already a solidly developed residential area. Most of the structures there are four to six story apartment buildings; some date from the early decades of the century, while others are of more recent vintage. In places, most notably along Austin Street and the northern ends of Gough and Franklin, a few clusters of 2-3 story 19th century frame dwellings remain.

The central stretch of Van Ness Avenue is characterized by a mix of old 4 story auto showroom/garage structures, large branch banks, home furnishing stores, and large, older apartment buildings. Some of the auto showroom/garage structures are still occupied by auto dealers, but others are now vacant or have been converted to other uses. The largest building is the 21 story Holiday Inn at Van Ness and Pine.

To the east of Van Ness, the corridor along Polk Street is an intensely utilized commercial strip that serves both neighborhood and city-wide and regional needs. Most of the structures are only one to two stories high and house small pedestrian oriented shops, restaurants, bars, and snack food outlets.

Current city policy is to encourage intensification of residential development on Van Ness Avenue. The 1983 Van Ness Avenue





plan would change the avenue's commercial zoning to a new classification that would emphasize residential use. Pedestrian-oriented commercial uses would be encouraged on the ground floor, but the total amount of commercial space would be limited. The plan would retain the avenue's 130 foot height limit, but would eliminate floor area ratio restrictions, allowing the height and bulk regulations to be the ultimate determinants of density. This change, along with elimination of regulations tying number of units to lot area would both permit greatly increased residential densities. Along Polk, and Franklin and Gough, existing regulations would not be changed.

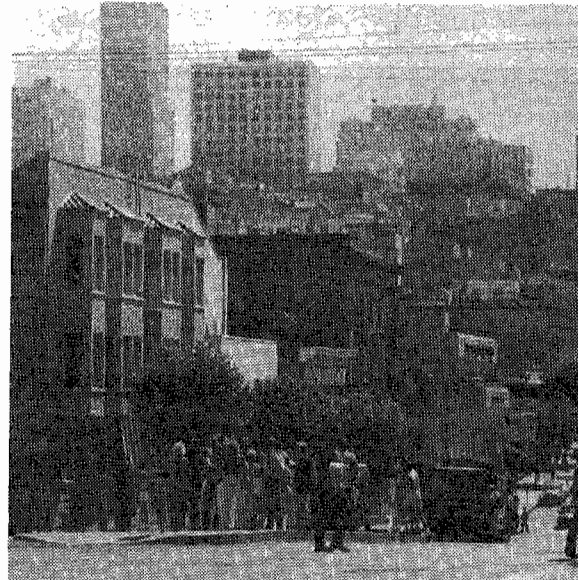

In this area, the primary objective is to preserve existing sidewalk comfort conditions for pedestrians and those waiting for buses.

Because of its great width, Van Ness Avenue is light and sunny much of the time. However, the area is exposed and fairly windy, and there are some significant wind problems around the Holiday Inn Tower. At present, outdoor comfort levels in this area are somewhat lower than in other parts of the central district. As the area develops in the future, the 130 foot high buildings permitted along the Avenue could add con-

siderably to sidewalk shading and create disturbed winds, producing even worse comfort conditions for the many pedestrians and the large numbers of people waiting for or transferring buses. Particular care will be required to preserve comfort conditions at the intersection of Van Ness and California where construction of a pedestrian plaza over a depressed street has been proposed. Because of the uniformly low building heights, sun, wind, and comfort conditions on Polk street are quite favorable. Because of the street's heavy pedestrian use, preservation of these conditions is critical. Under current regulations, buildings could be replaced with structures up to 65 feet high.

The development scenarios modeled and tested for this area assumed new building would be constructed on the sites indicated on Figure 19. Most of these sites are located along Van Ness Avenue where city policies are encouraging new mixed-use development, and they illustrate a variety of site relationships to Van Ness and the surrounding streets. The building outlines assumed in the development under existing regulations case represent a direct application of current zoning controls. The mitigated scenario, which contains essentially the same amount of building space as under existing

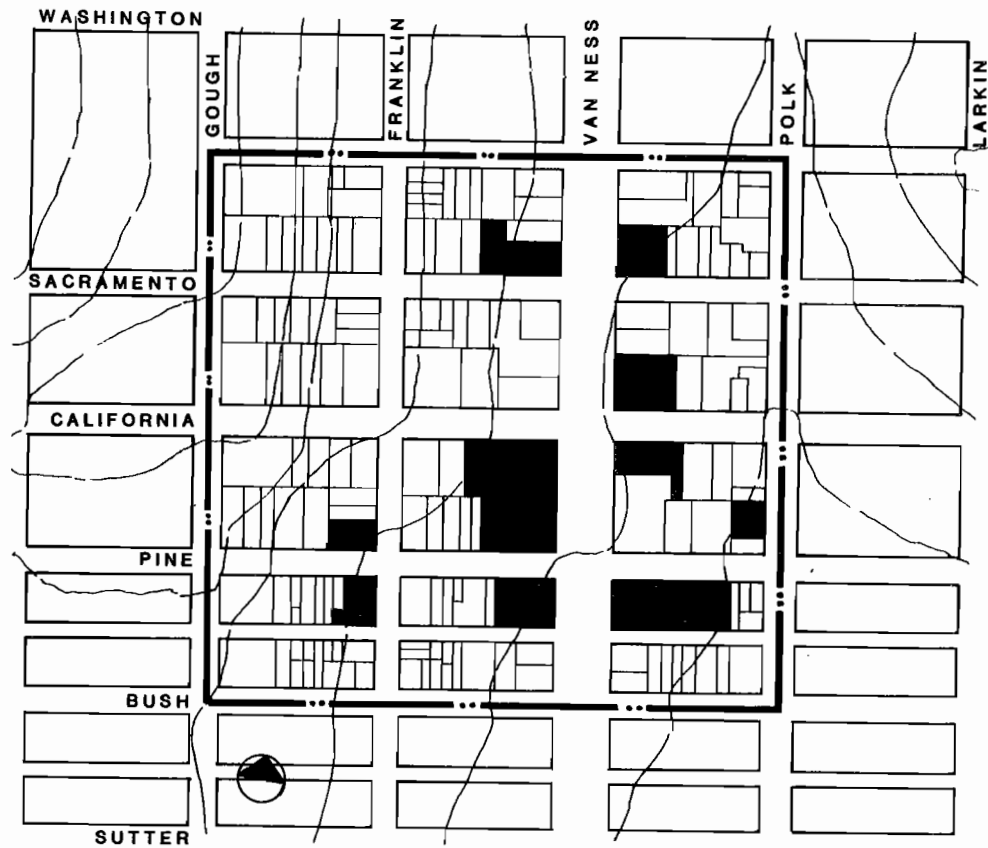
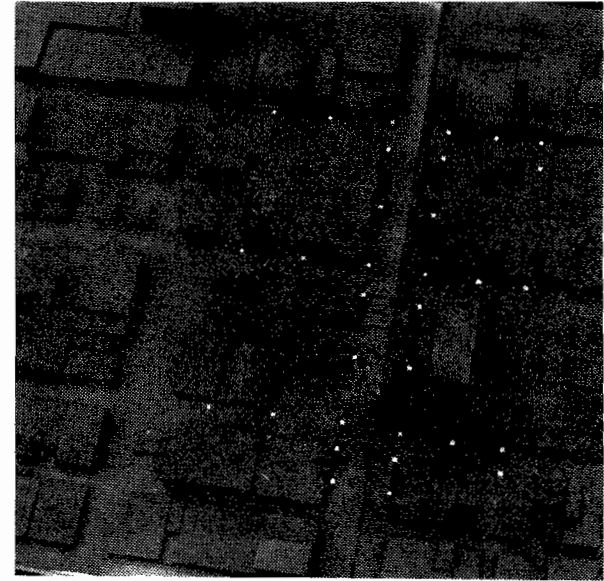

Figure 19. Representative Sites for Development at Van Ness and California Streets



Aerial Photo of the Van Ness Avenue Area



Existing Conditions

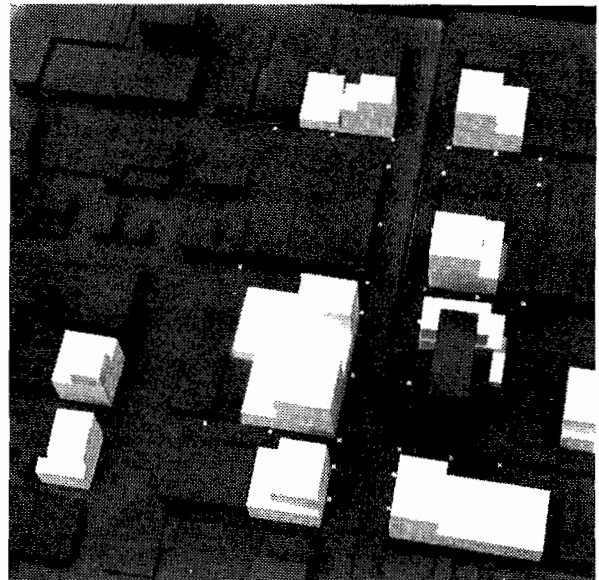

Development Under Current Controls

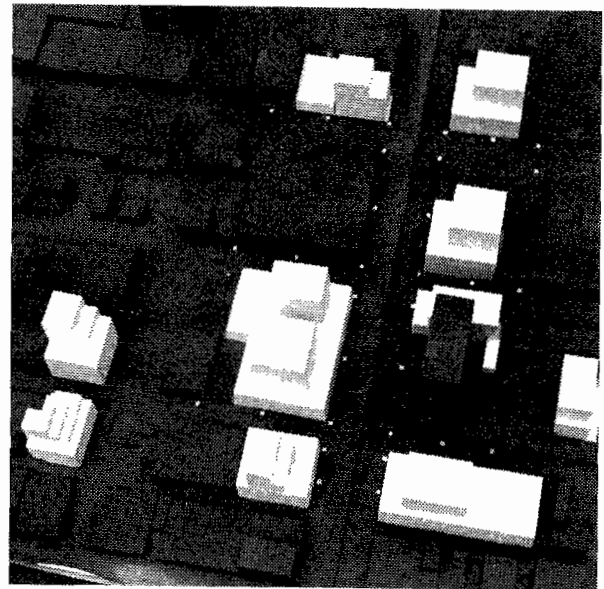

Mitigated Development

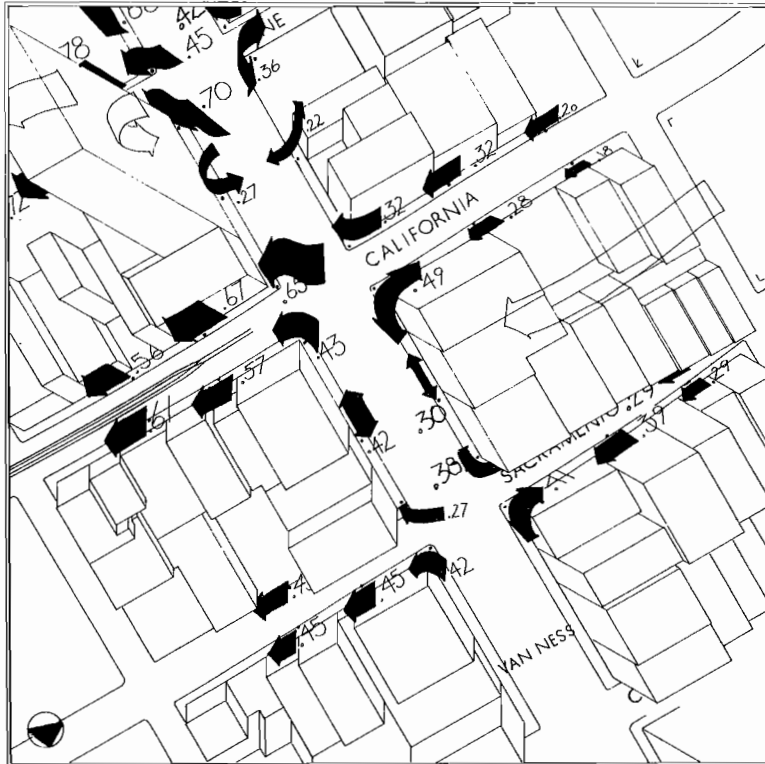

Existing Conditions



Development Under Current Controls

Wind from the West

The drawings and text on the next pages summarize the results of the wind tunnel tests. The numbers located at each test point are ratios that represent the relationship of the street level wind speeds to the wind speeds measured at the weather station. The ratios have been adjusted so that they also reflect the effects of gustiness.



Mitigated Development

regulations, reflects the design principles contained in the Van Ness Re-Zoning Study, which spells out design measures intended to reduce wind effects and preserve sunlight.

Van Ness

The west wind tests for the Van Ness Avenue existing conditions model indicate that downwash, corner and eddy effects create extremely high wind ratios around the base of the Holiday Inn tower. In the rest of the area, the ratios are in the low to mid-range level, with the higher ratios occurring at corners. The buildings assumed in the development under existing regulations scenario shelter the Holiday Inn, causing a reduction in winds at most points around its base. However, the buildings generally bring about an increase in the ratios in the rest of the area, and create some particularly high readings on Van Ness between Sacramento and California. In general, the mitigated scenario produces somewhat lower wind ratios in the entire area. The notable exception is at Pine and California, where extremely high ratios produced by the Holiday Inn's downwash, vortex, corner and eddy effects persist.

Northwest winds produce approximately the same pattern of wind ratios in this area under existing conditions as the west winds. The only major difference is a shift in

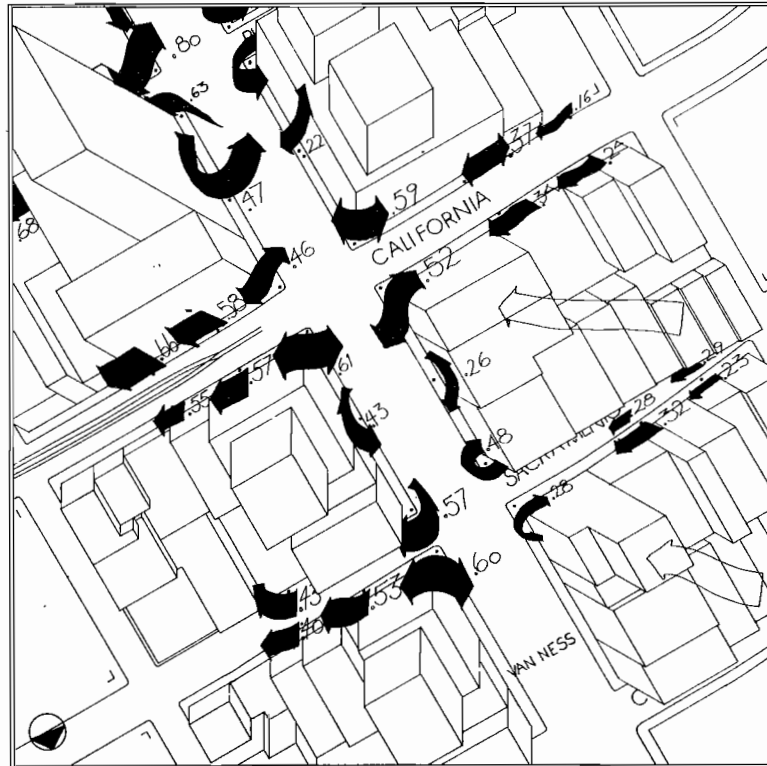

Mitigated Development

wind patterns around the Holiday Inn tower that creates several extremely high ratios at Van Ness and Pine. When growth under existing regulations is modeled, quite high wind ratios are produced on Van Ness between Bay and California, reflecting vortices and eddies created by the large new buildings added.

The new buildings shelter the Holiday Inn, greatly reducing the wind ratios at its base. Under the mitigated scenario the wind ratios between Clay and California are slightly reduced compared to the other development alternative. However, some of the ratios at the base of the Holiday Inn return to extremely high levels, reflecting a reduction in the amount of sheltering provided by the new structures.

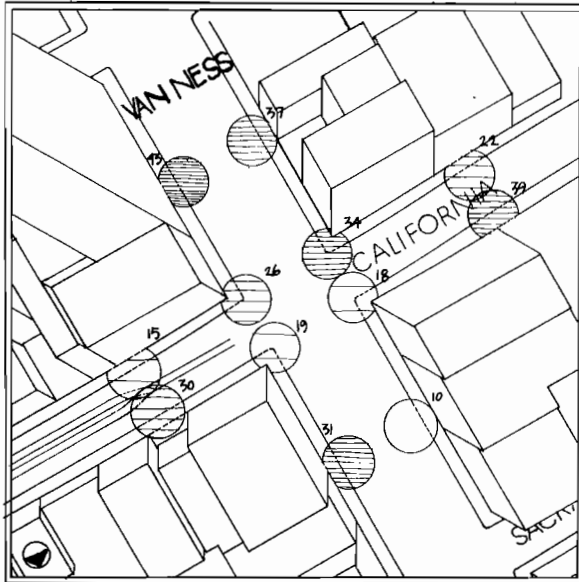

Existing Conditions

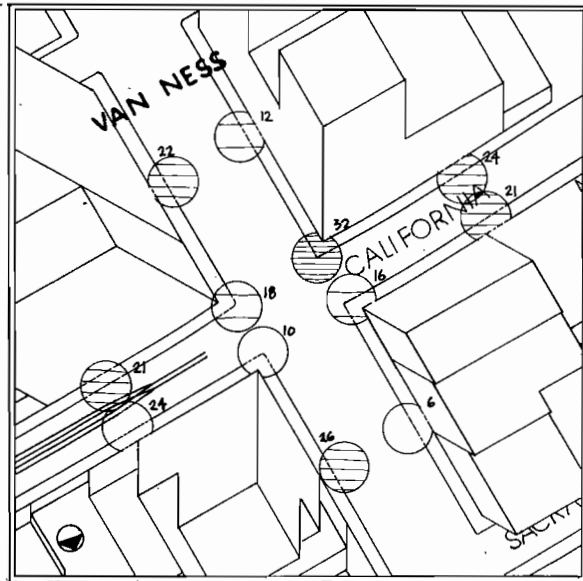

Development Under Current Controls

Van Ness and California

The exceptionally high winds that exist at some points in this area create wide variations in existing winter comfort conditions. Points in windy spots and or in shadowed areas have very low comfort percentages. Places sheltered from the wind and with good sun access have average or above average comfort levels. When development under existing controls is modeled, the percentages at the points that already have low readings decline only slightly. At the points with relatively high comfort levels under existing conditions, sharp declines frequently take place, reflecting increased shadowing. By decreasing some of the development's wind and shadow effects, the mitigated scenario partially moderates its comfort impacts.

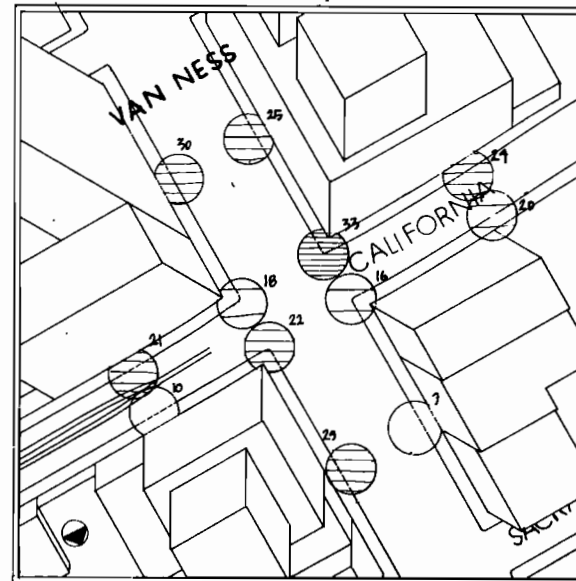
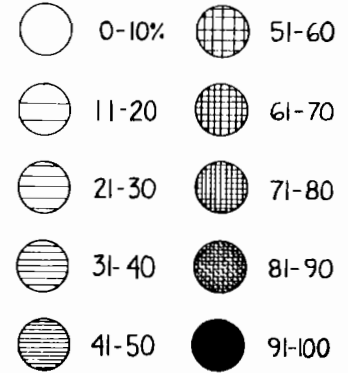

Mitigated Development

The drawings and text on the next pages summarize the results of the comfort modeling process. The numbers and circles located at each of the points indicate the percentage of time during the daylight hours of a particular season that sun and wind conditions would permit the maintenance of human thermal comfort.

Winter

Under existing spring conditions, comfort levels at most points are fair to good. The worst comfort conditions are at points along California Street east of Van Ness that are subject to wind eddies produced by the Holiday Inn Tower. With development under existing regulations, increased shadowing and some increases in local winds bring about a general decline in comfort levels, with some sharp reductions at several points. The mitigated development scheme is partially successful, for the decreases in wind and shade effects improve the comfort levels somewhat at most points.

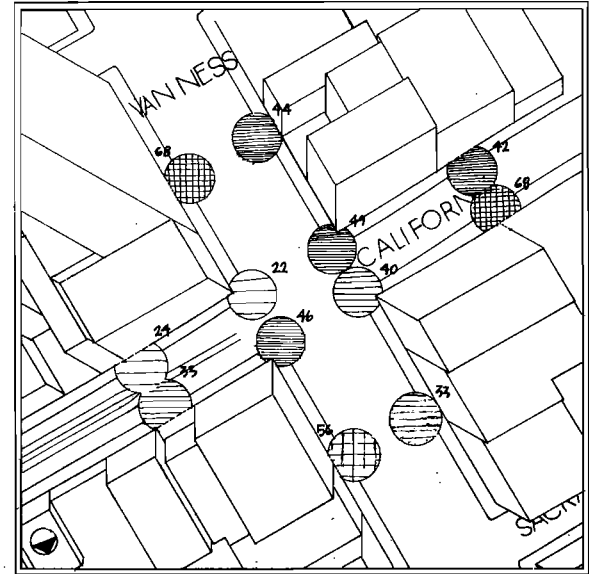

Existing Conditions

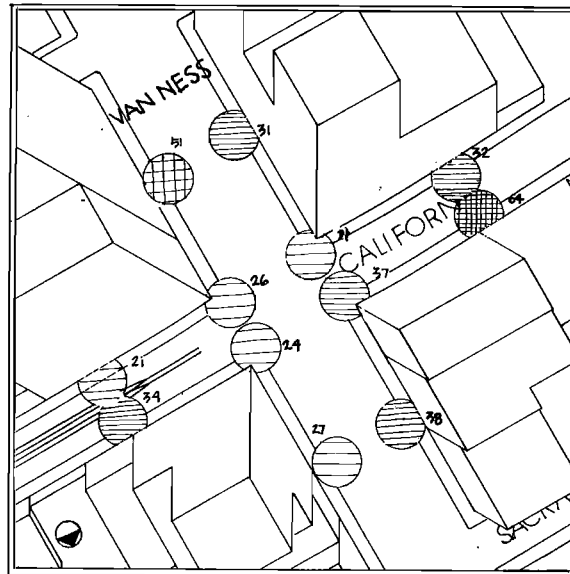

Spring

Development Under Current Controls

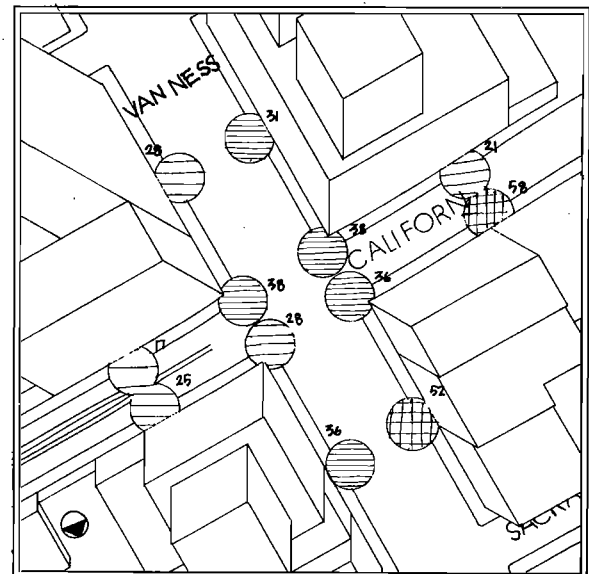

Mitigated Development

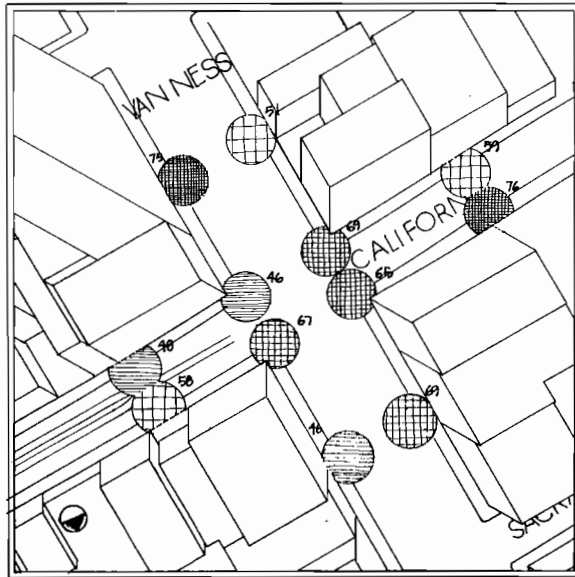

Existing Conditions

Summer comfort levels under existing conditions in this area are, in general, somewhat lower than average for the season, due primarily to high street level winds. On the whole, the development modeled assuming existing controls brings about only a minor decrease in comfort levels. The mitigated scenario creates some increases and decreases in comfort levels at individual points, but on the average, the comfort levels are little changed.

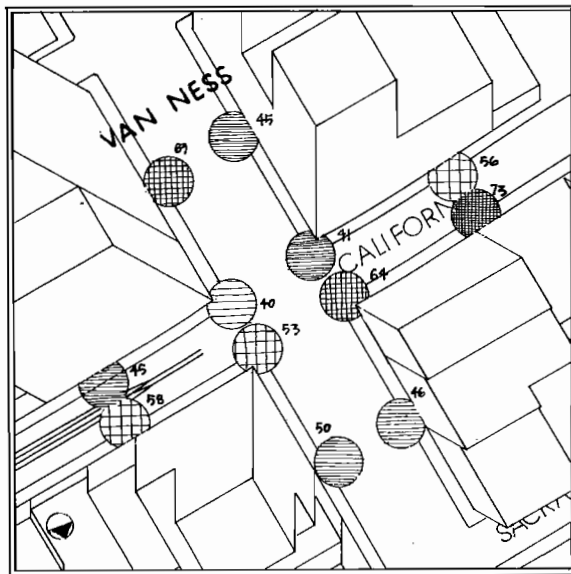
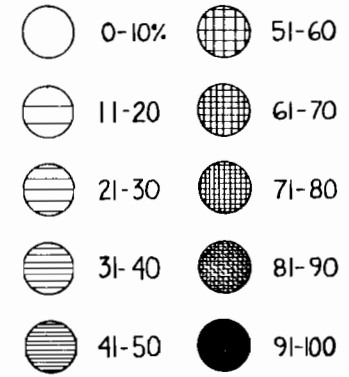

Development Under Current Controls

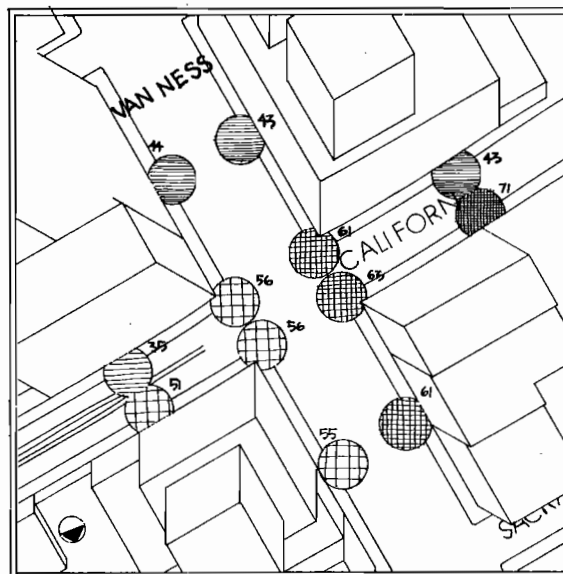

Mitigated Development

Summer

At most points in this area, existing fall comfort levels are much lower than average. The points with the lowest comfort percentages have strong wind flows, and are usually located on the south and west sides of the street, where shading is a problem. With development under existing controls, comfort percentages at virtually all points drop to exceptionally low levels, reflecting increased shading, and the sensitivity of comfort to increased wind speeds at this time of year. The mitigated scenario reduces winds at some points while increasing them at others, and only partially reduces the shadows created at this time of year, so while some comfort levels improve slightly compared to the unmitigated development scenario, they are generally still very low.

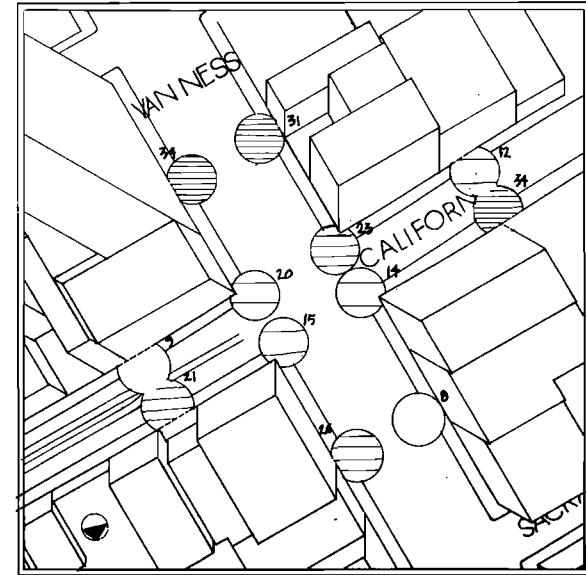

Existing Conditions

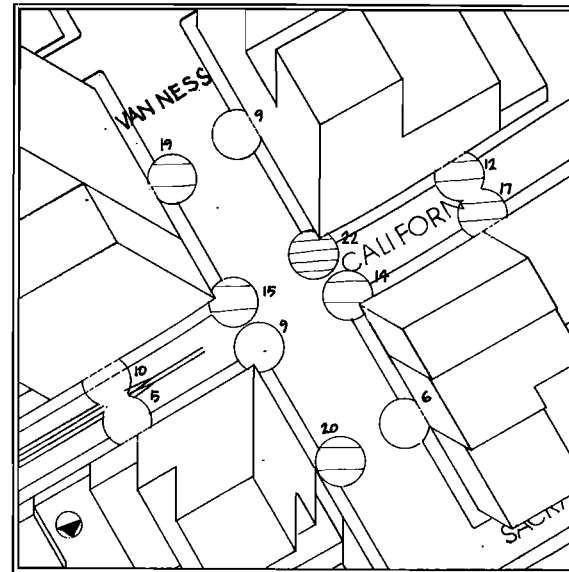

Development Under Current Controls

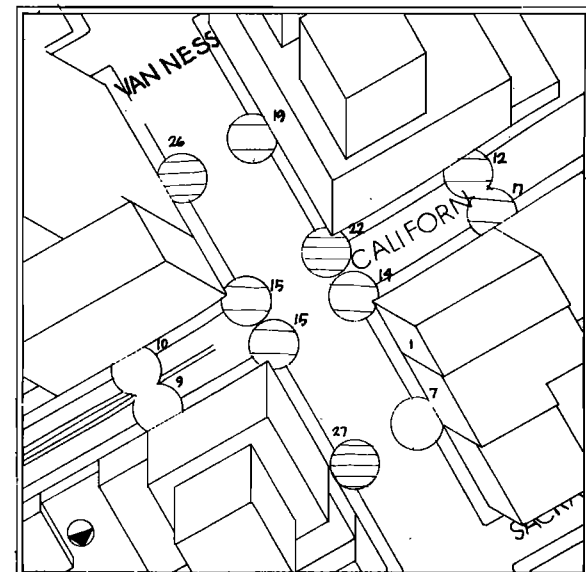

Mitigated Development

Fall

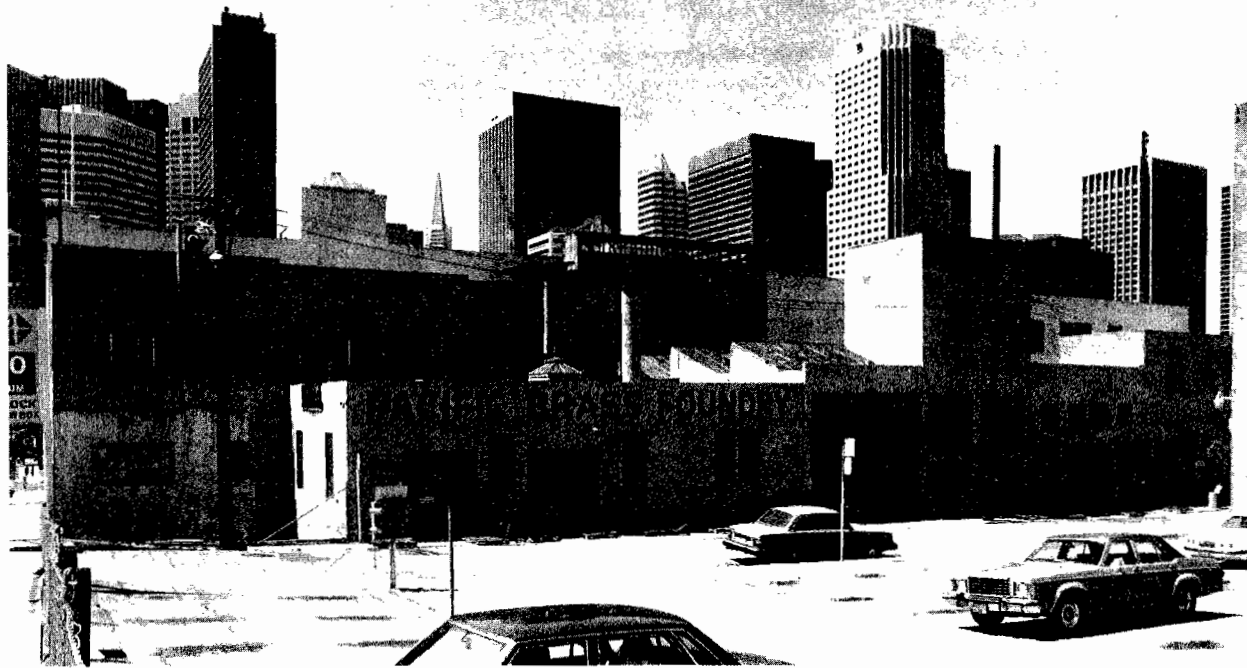

South of Market

During the next 15 to 20 years, the area around the Trans Bay Terminal is likely to be the center of some of San Francisco's most intensive office growth. Decreasing availability of readily developable sites in the existing Financial District (roughly the area between Market, Washington, Drumm, and Kear-

ney Streets), restrictions on the Financial District's northward and westward expansion, and increasing controls designed to protect the Financial District's historic buildings, sunlight, and other amenities will all tend to shift new office development into the area south of Market Street. This trend is already evident in the conversion of many of the terminal area's 4 to 8

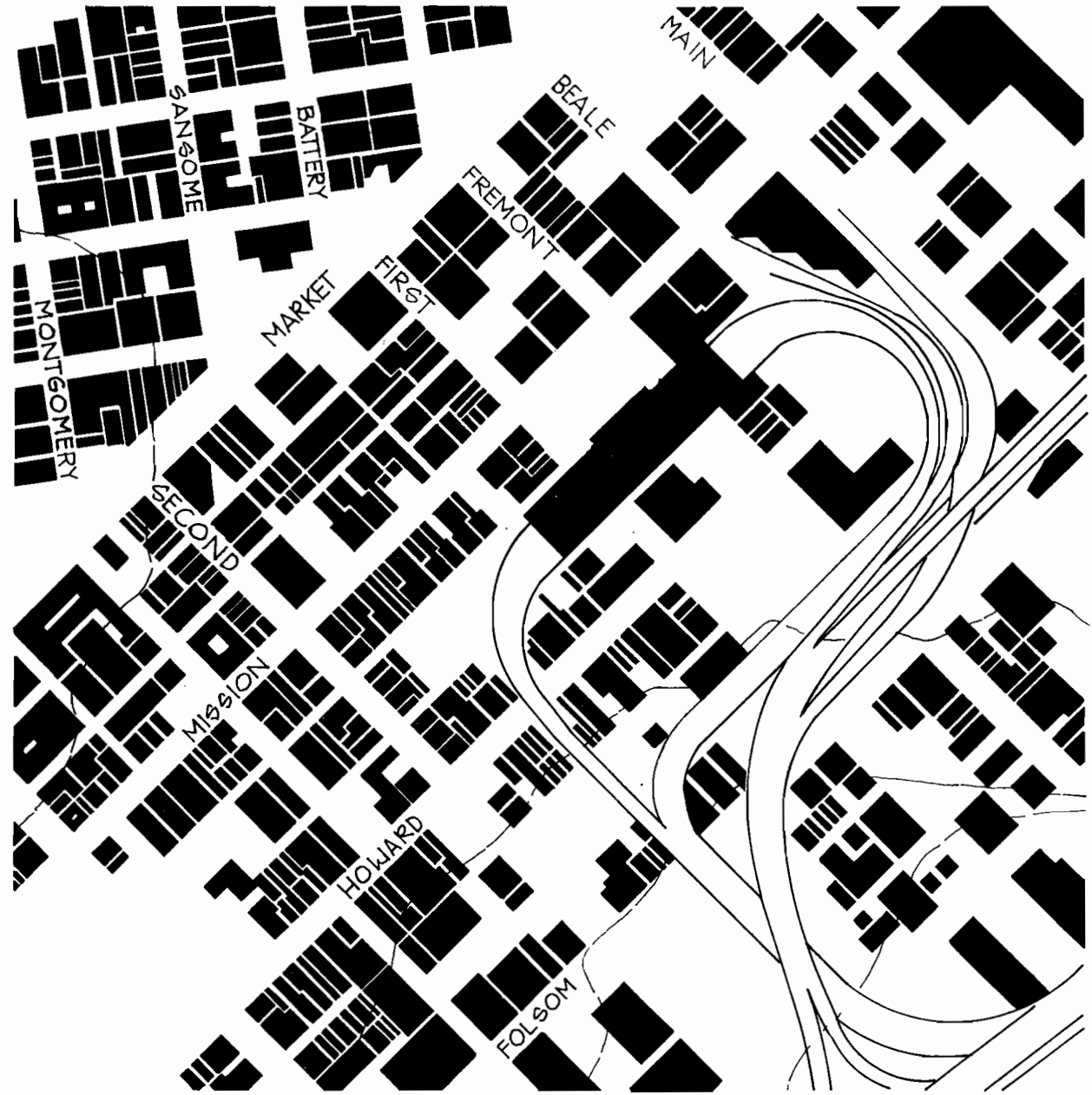

Figure 20. South of Market

story warehouse and industrial buildings into office space, and in the construction of new office towers along Mission Street. The largest of the recently completed structures is the 48 story Five Fremont Plaza building directly across from the terminal.

The Downtown Plan contains a number of provisions that would reinforce this southward shift. Although it proposes reducing basic height limits in all of the C-3 zone, it would at the same time realign the height pattern to cluster the highest buildings in the area immediately surrounding the terminal. The plan also proposes special incentives to encourage office development south of the terminal by creating a special development district between Natoma and Folsom Streets into which development rights from the Financial District could be transferred.

The area's Spanish grid street layout (with streets oriented southwest-northeast and northwest-southwest) blocks the prevailing west winds and permits good sun access most of the day. In addition, with the exception of the new office tower cluster around Mission and Fremont, building heights are uniform and relatively low, reducing the amount of wind disturbance, and minimizing shading effects, creating



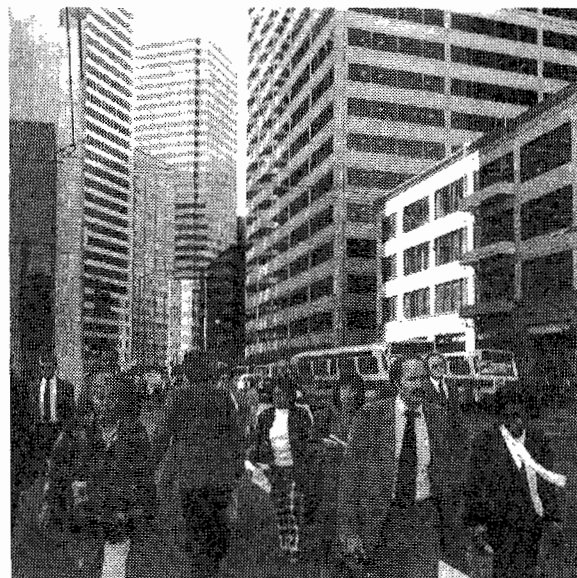

relatively good microclimatic conditions at street level. During most of the day, each street has at least one side that is flooded with sunlight. As development intensifies, careful design will be required to preserve the existing levels of sun, light, and outdoor comfort.

In this area, consideration of pedestrian comfort is particularly important. The terminal already generates exceptionally high levels of foot traffic on the surrounding streets. These levels will increase as activity in this area and the downtown as a whole intensifies. Protection of sidewalk sun access, and prevention of disturbed wind patterns will be most critical along Main Street, and on the portions of Fremont, First, Ecker, and Second connecting Mission and Market, the streets with the heaviest pedestrian flows.



At present, there is little public open space in this area. The only major space, the open area in front of the Trans Bay Terminal, is designed primarily for transit use. There are only a few other spaces designed for sitting, lunching, and other informal outdoor activities. The plaza on the west side of Beale Street between the Bechtel Building and 333 Market is in deep shade most of the day, and it is only lightly used. The landscaped edge along the

west and south sides of the PG&E buildings gets mid-day sun and is heavily used as a spot for bag lunching. The area's most successful open space is the small plaza in front of Golden Gate University on Mission Street. The plaza's benches are in sun much of the day, are sheltered from the wind, and are heavily used.

Under both existing zoning and the regulations recommended by the Downtown Plan, the density of office workers in this area will be greatly increasing, intensifying the need for additional open space for informal outdoor activity. To meet this need, the city proposed creation of a major new park or plaza behind the Trans Bay Terminal in the block south of Howard Street between Fremont and First Streets. The original research plan was to evaluate the effects of sun and wind impacts on comfort conditions on this site. However, during the course of this study, there was a shift in the city's thinking, and in June, 1984, the proposed Downtown Plan was changed to permit two 400 foot towers to be developed on the site. For this reason, comfort conditions on this block were not analyzed, and instead, attention was turned to the bus plaza in front of the Trans Bay Terminal, the area's sole large open space.

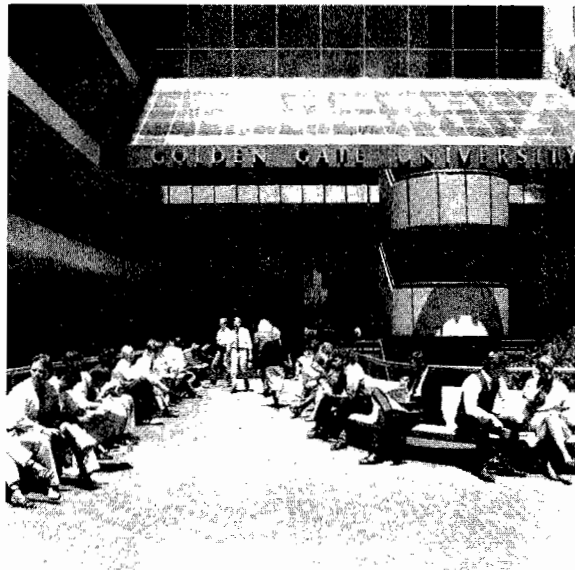
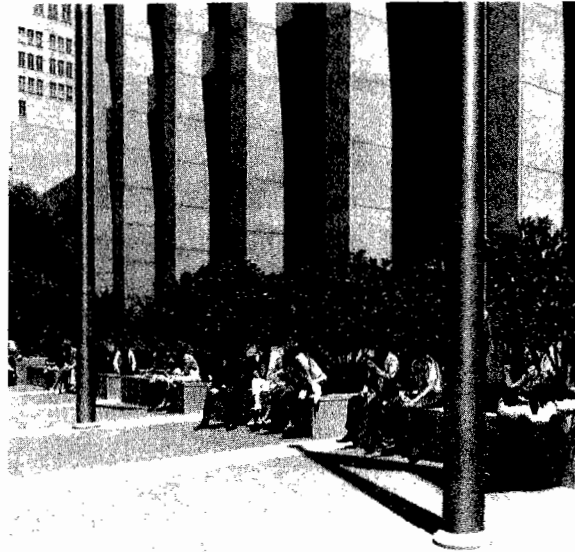



Given the general scarcity of usable public open spaces in this area, it will be important to protect the existing mini-plazas, and any additional areas that might be constructed in conjunction with new office tower development. Under the Downtown Plan, such spaces would be required to receive direct sunlight between 11 a.m. and 2 p.m. between the spring and fall equinoxes. In the corridor along Mission Street, this will take particular care in view of the tall building heights permitted under both existing zoning and the proposed downtown plan.

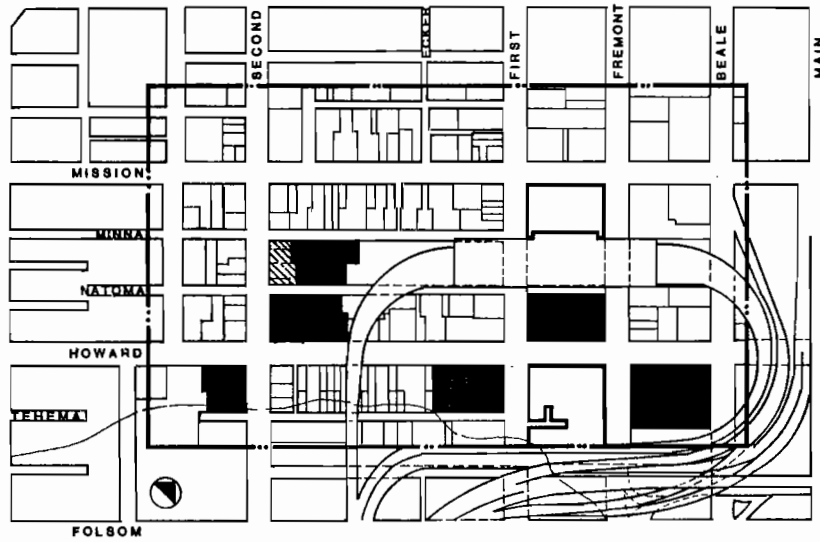

Figure 21. Representative sites for development in the South of Market Area under partial controls and partial development under proposed Downtown Plan

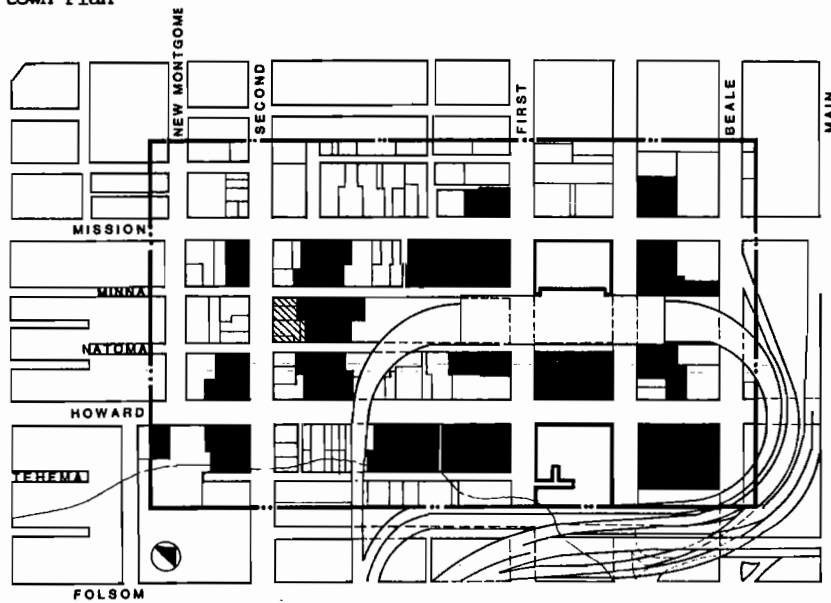

Figure 22. Representative sites for full development under Downtown Plan

For this area, four development scenarios were modeled and tested. The existing regulation and Downtown Plan--partial buildout scenarios assumed development on the sites indicated on Figure 21. In the Downtown Plan full buildout and mitigated scenarios, it was assumed that these sites, as well as additional ones would be developed (Figure 22). All scenarios, including the existing conditions case, assumed the existence of the Lincoln Plaza building on Mission Street which has been approved but not yet constructed. The buildings modeled in the existing regulation development scenario are based on direct application of the provisions of the pre Proposition K zoning code. The Downtown Plan-partial buildout case assumes application of the plan's provisions to the same sites modeled under the existing regulations, resulting in a reduction of total building volume. This was done to compare existing regulations with the Downtown Plan using the same physical sites. In order to show a more realistic Downtown Plan scenario, however, it was necessary to develop a larger number of sites, as the Plan encourages more growth in this area than the existing regulations permit. In the mitigated case, the full build-out Downtown Plan's building forms have been altered by the application of the

solar cut-off angles recommended in the Sun and Light for Downtown San Francisco report and wind-mitigation design measures, causing the total amount of building space to be reduced by 10% to 15%.



Aerial Photo of the South of Market Area

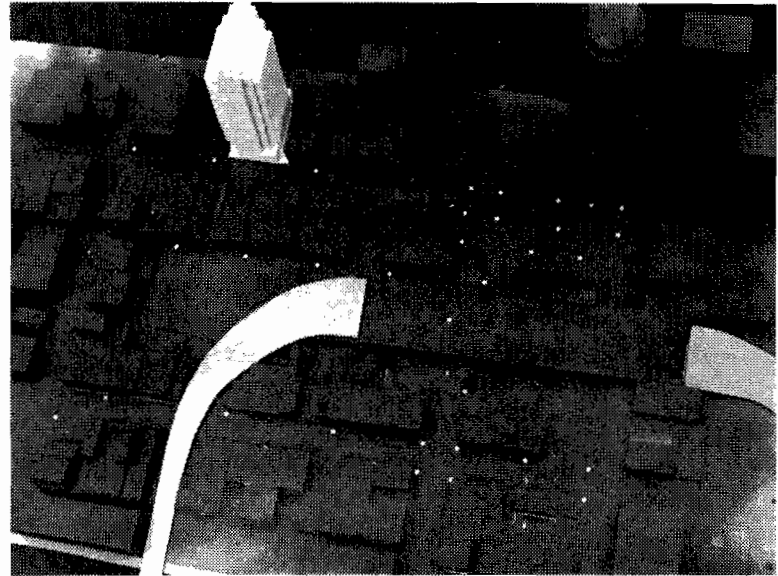

Existing Conditions

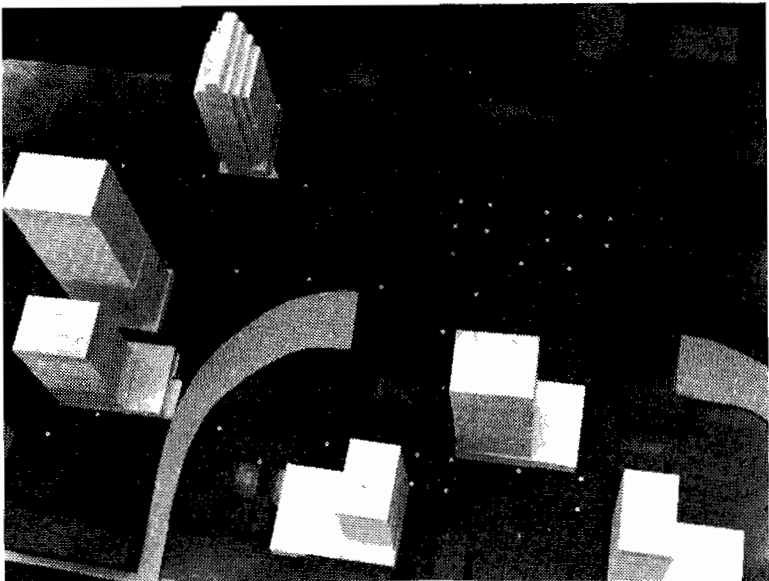

Development Under Current Controls

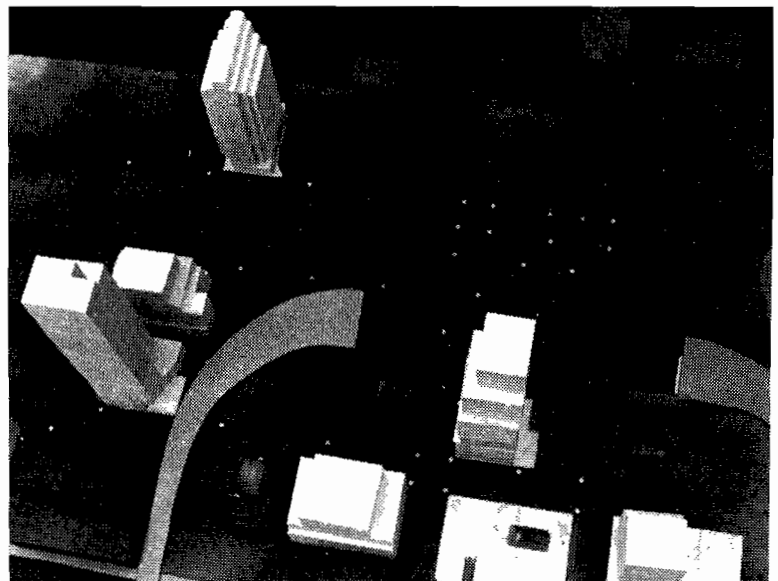

Partial Development under Proposed Downtown Plan

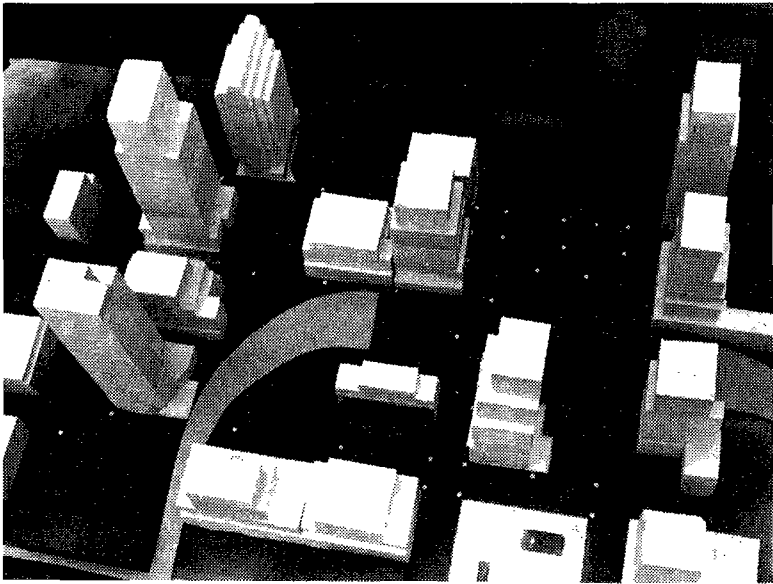

Full Development under Proposed Downtown Plan

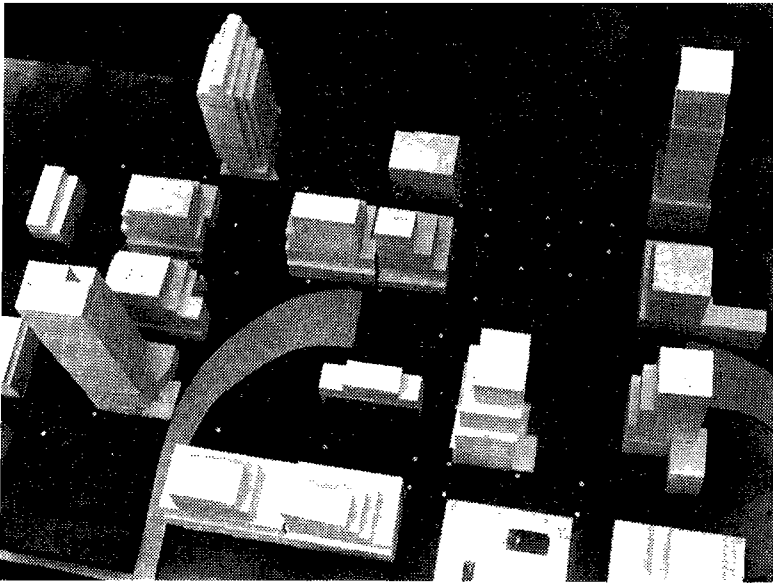

Mitigated Development



Existing Conditions

TransBay Terminal Area

Under existing conditions, street level wind conditions in this area are, for the most part, reasonably calm when the wind comes from the west. The major exception is the passageway on the west side of the Five Fremont Center building where downwash and pressure connection effects create a moderately high wind ratio. With development under existing controls, the wind ratios on and around the plaza in front of the terminal remain more or less the same, although there is a reduction in the passageway west of Five Fremont Center. Behind the Terminal, downwash, eddy, and corner

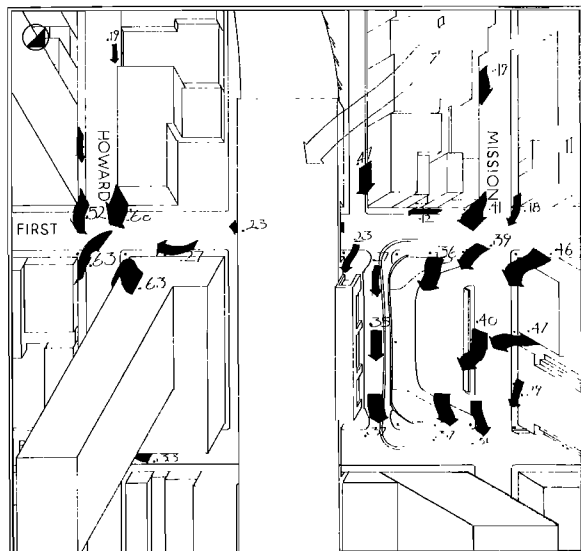

Development Under Current Controls

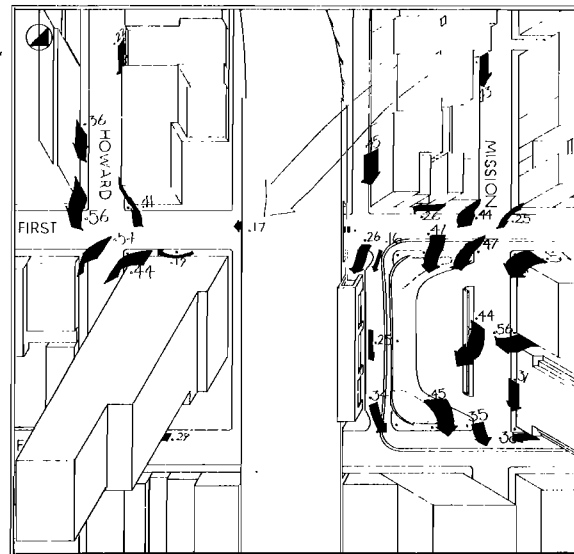

Partial Development under Proposed Downtown Plan

The drawings and text on the next pages summarize the results of the wind tunnel tests. The numbers located at each test point are ratios that represent the relationship of the street level wind speeds to the wind speeds measured at the weather station. The ratios have been adjusted so that they also reflect the effects of gustiness.

Wind from the West

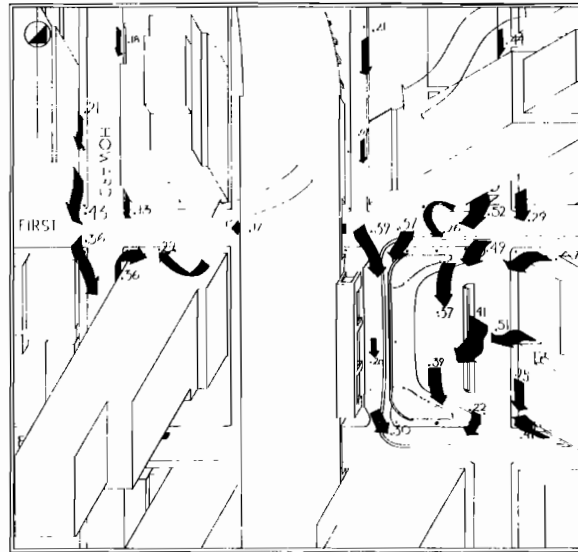

Full Development under Proposed
Downtown Plan

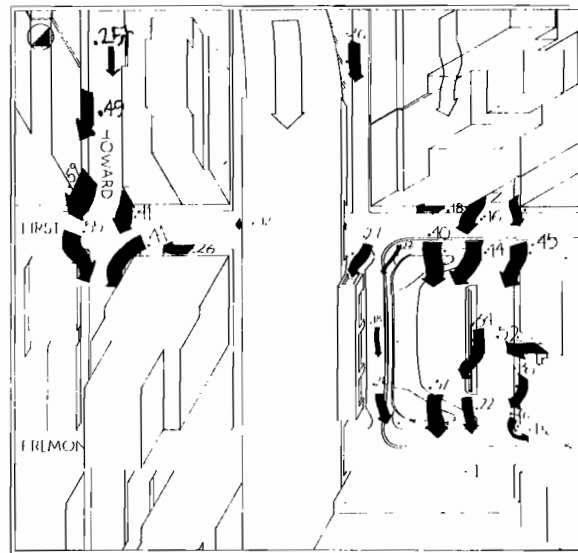

Mitigated Development

effects associated with a new tower structure create high ratios at the corner of First and Howard Streets. A generally similar pattern of ratios is created when development of the same sites is modeled assuming application of Downtown Plan regulations. The only major difference is that the ratios at the base of the tall building at the corner of First and Howard are reduced somewhat, perhaps reflecting the step-back design assumed.

When full development under the Downtown Plan is assumed, most wind ratios in the area in front of the Trans Bay Terminal remain at reasonably moderate levels, and a few are even reduced from what they were in the preceding scenarios. The slightly increased ratios predicted at First and Mission appear to reflect wake and corner effects produced by the tower assumed at that corner. The increased level of development in the area as a whole appears to create a shelter effect for the area behind the terminal, producing ratios that are lower than those occurring under the other scenarios and even under existing conditions. Under the mitigated scenario, the ratios in front of the terminal remain about the same, although the higher ratios produced by the building at First and Mission are moderated somewhat. At First and Howard, the ratios increase, but are still at generally acceptable levels.

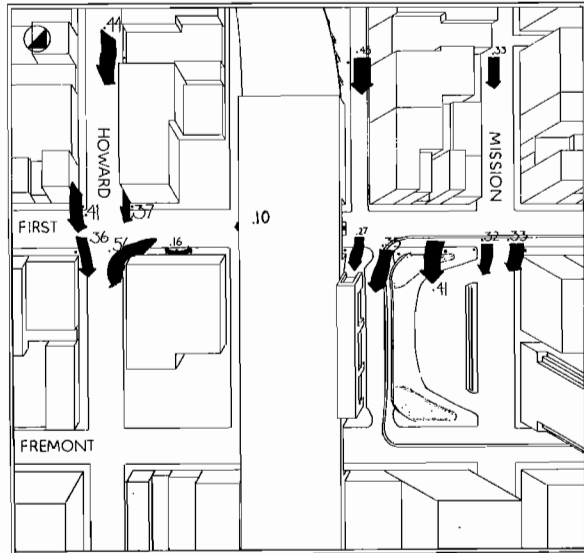

Existing Conditions

Under existing conditions, when winds blow from the southwest, most street level wind conditions in this area are fairly good. When development under existing controls is modeled, ratios in the area in front of the Trans Bay Terminal remain the same, but slightly increased ratios occur along Mission Street, and at the base of the tower assumed at First and Howard. The ratios are little changed when development of the same sites is modeled assuming application of the Downtown Plan's provisions.

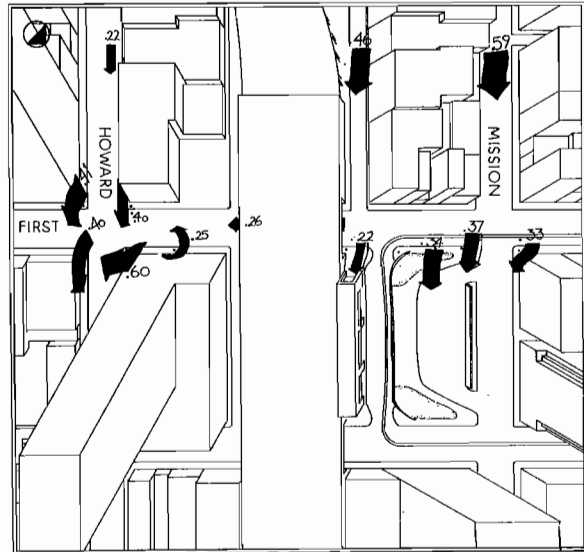

Development Under Current Controls

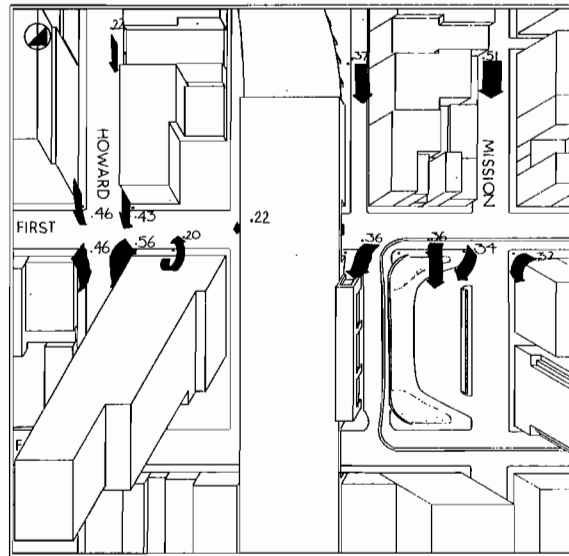

Partial Development under Proposed Downtown Plan

Wind from the Southwest

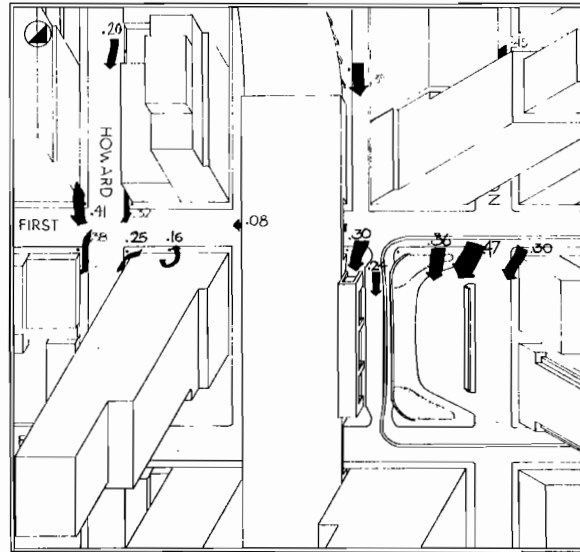

Full Development under Proposed Downtown Plan

When full development under the Downtown Plan is modeled, this area's wind ratios remain at moderate levels. Some intensification occurs at First and Mission, probably as a result of an eddy created by the tower assumed at that corner. At First and Howard, a shelter effect appears to be responsible for reducing the ratios. Under the scenario in which sun and wind mitigating measures are applied to the Downtown Plan-full buildout condition, the wind ratios decrease slightly around the tower at First and Mission. The ratios increase significantly around the new buildings assumed at First and Howard.

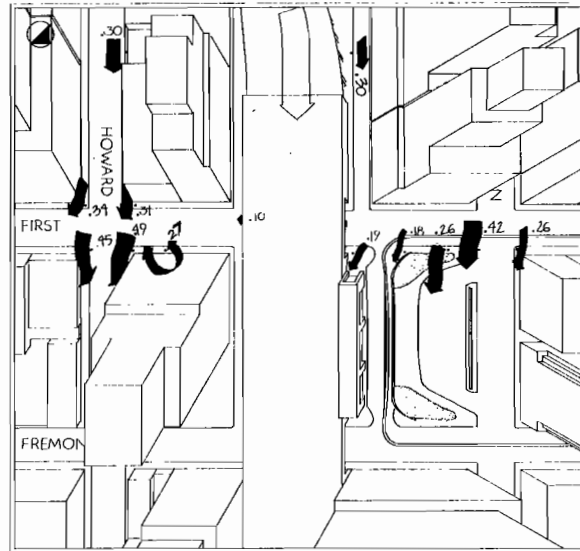

Mitigated Development

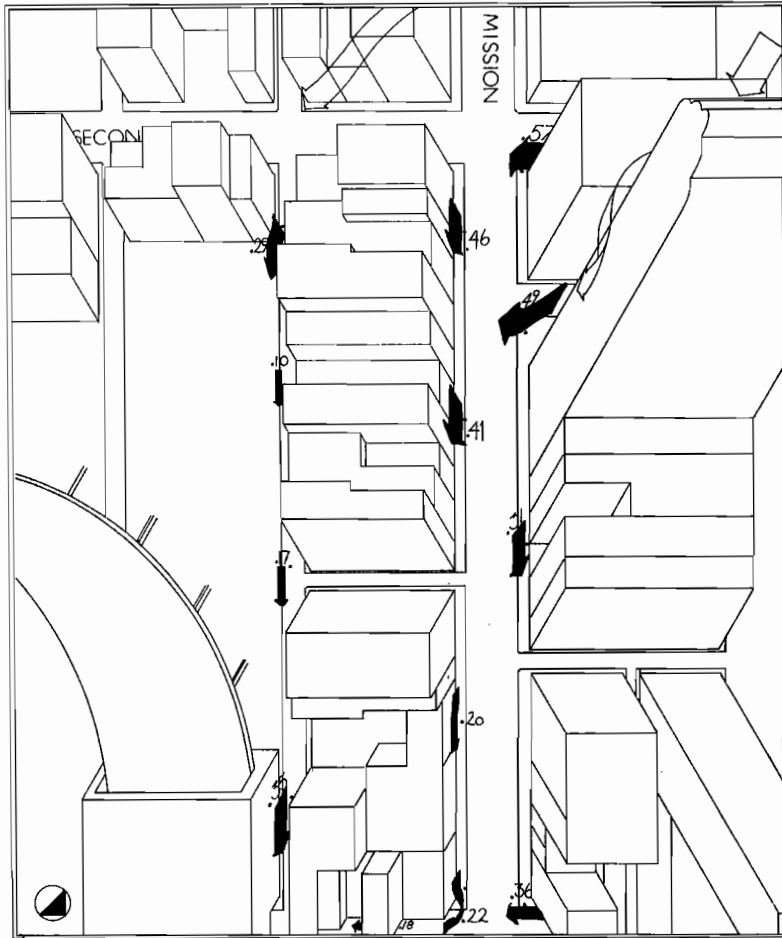

Existing Conditions

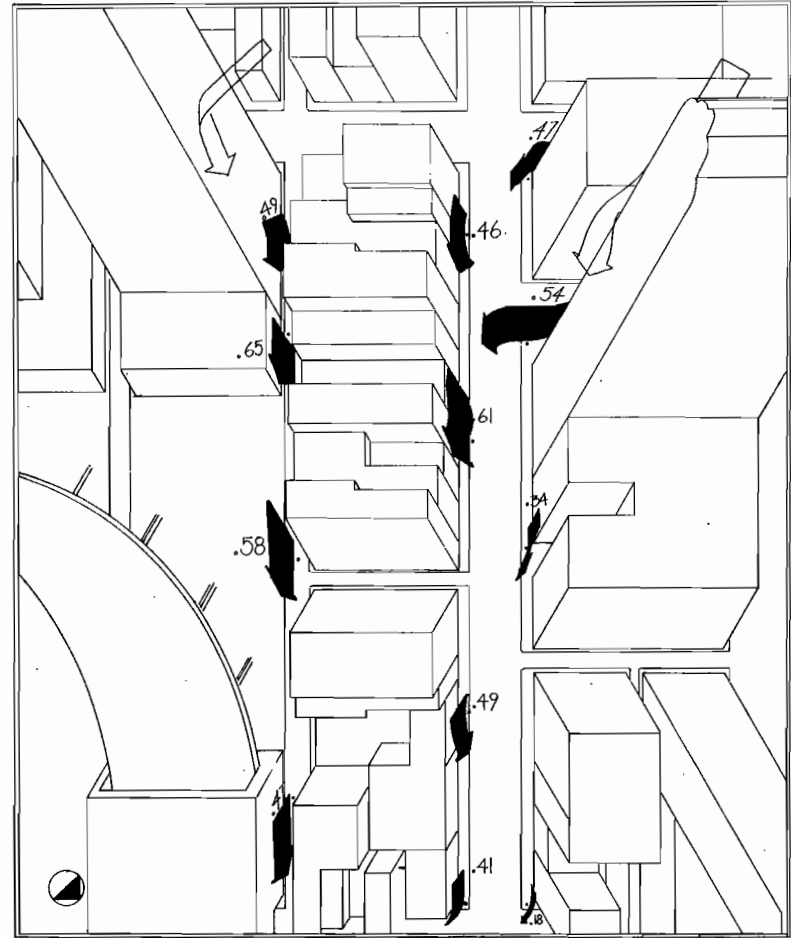

Development Under Current Controls

Wind from the West

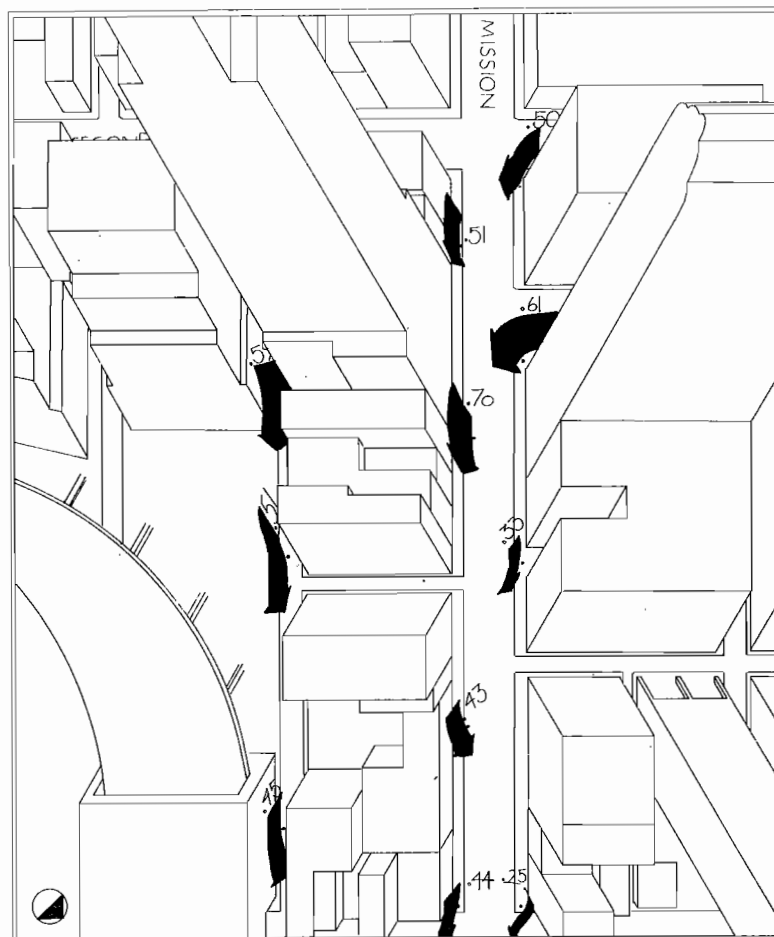

Partial Development under Proposed Downtown Plan

Mission Between First and Second

The "existing conditions" modeled for this area include the 33 story Lincoln Plaza Building on Mission Street which has been approved but not yet constructed. The highest wind ratios occur at the base of this building and the adjacent building at the corner of Mission and Second. These moderately high ratios appear to be a product of the downwash vortex and corner effects. The wakes produced by these buildings also create moderately high wind ratios on the opposite side of Mission Street; further down the block the ratios taper off. Minna Street, south of Mission Street and parallel to it, is well sheltered and has relatively low ratios.

With development under existing controls, the wind ratios at most of the measurement points along Mission Street intensify somewhat, and the ratios along Minna increase dramatically. At one of the Minna Street points, the ratio increases from .10 to .65, creating potentially serious wind problems. When development of the same sites is modeled assuming that the Downtown Plan's regulations apply, further increases in wind ratios occur at most points along Mission, including a reading of .70 at mid-block. These increases appear to be the product of down-

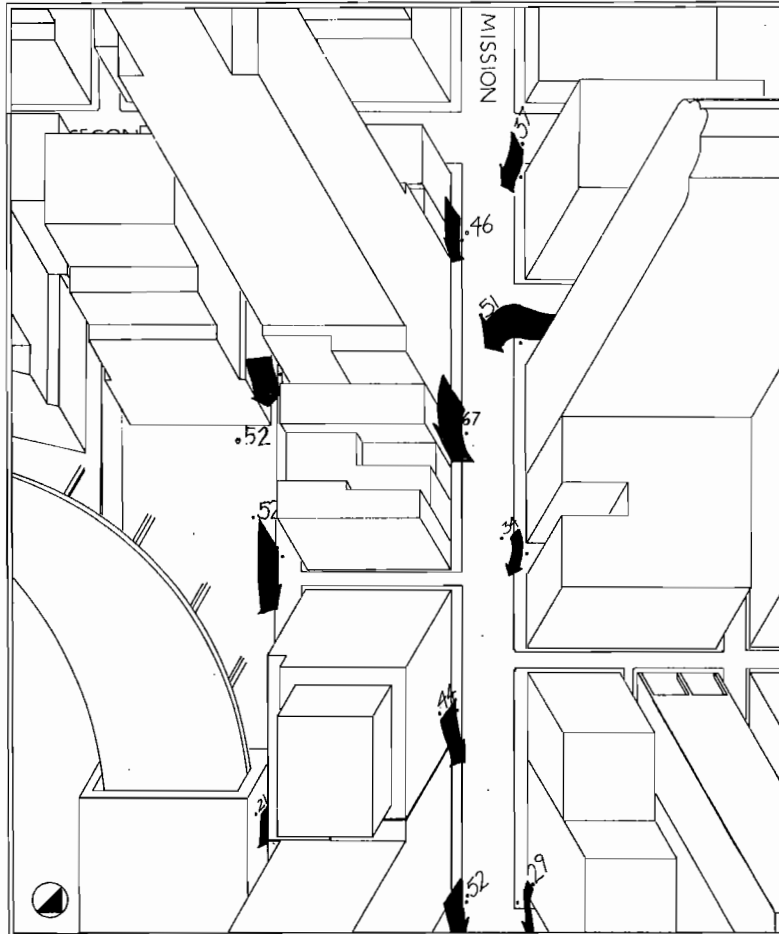

Full Development under Proposed
Downtown Plan

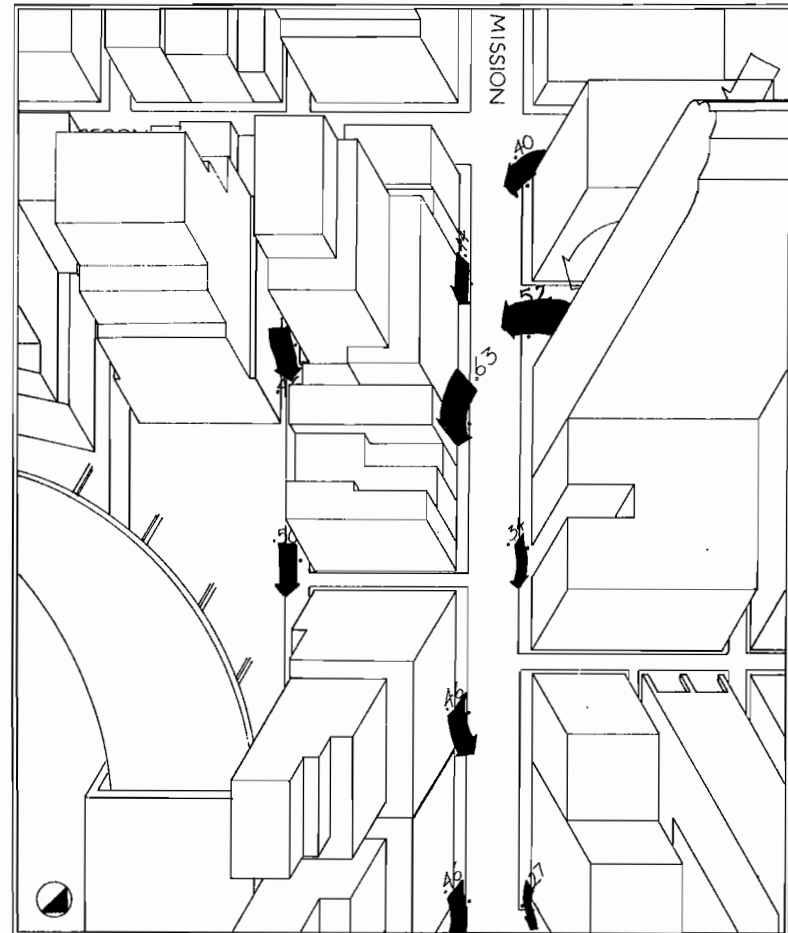

Mitigated Development

Wind from the West

drafts and eddies associated with the tall buildings assumed along Mission Street. These same buildings shelter Minna Street somewhat, producing wind ratios that are slightly lower than those created with development under existing regulations. With full buildout under the Downtown Plan, the wind ratios remain more or less the same as they were under the Downtown Plan-partial buildout scenario. In this area, the sun and wind mitigation measures applied to the Downtown Plan buildout levels appear to have only limited effect on the wind ratios, but do succeed in bringing about a slight reduction in the very high ratio at mid block on Mission.

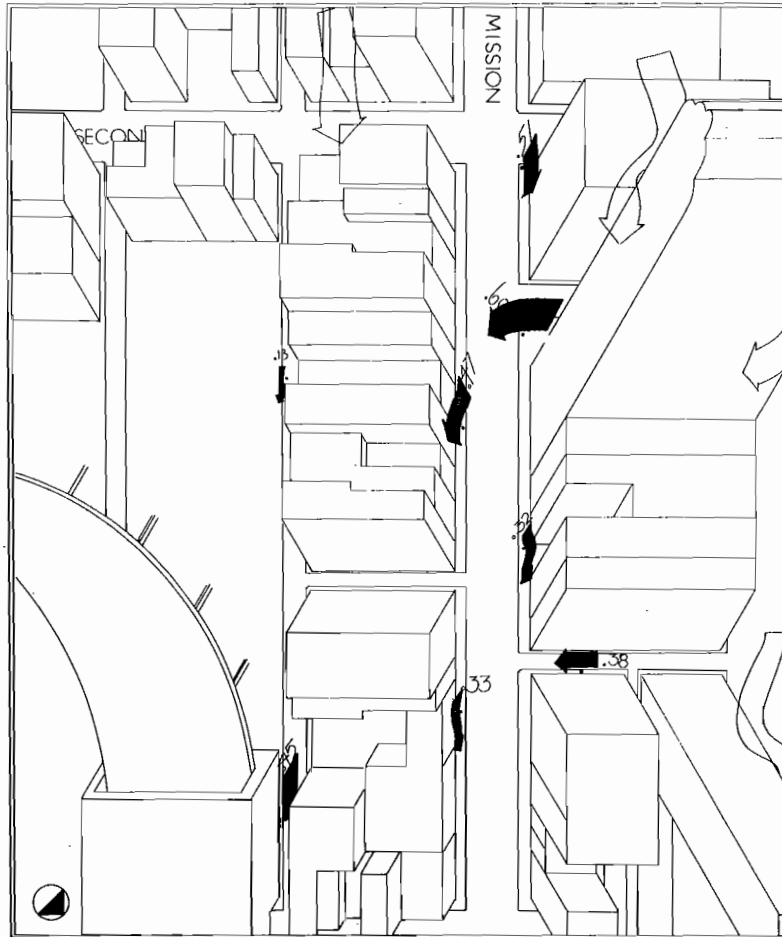

Existing Conditions

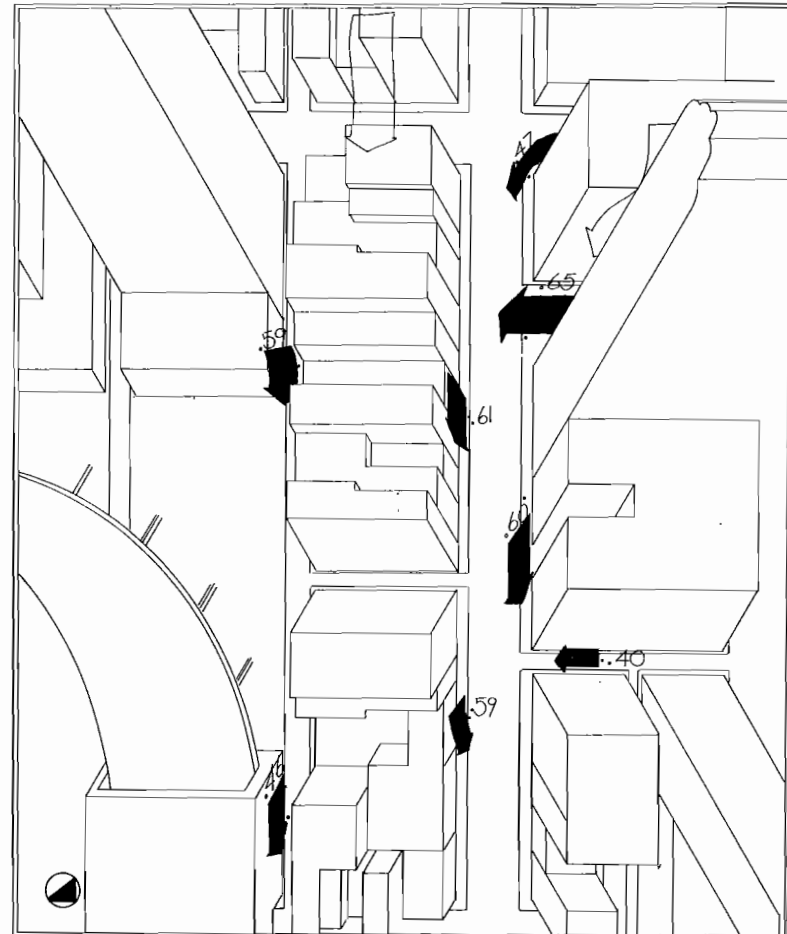

Development Under Current Controls

Wind from the Southwest

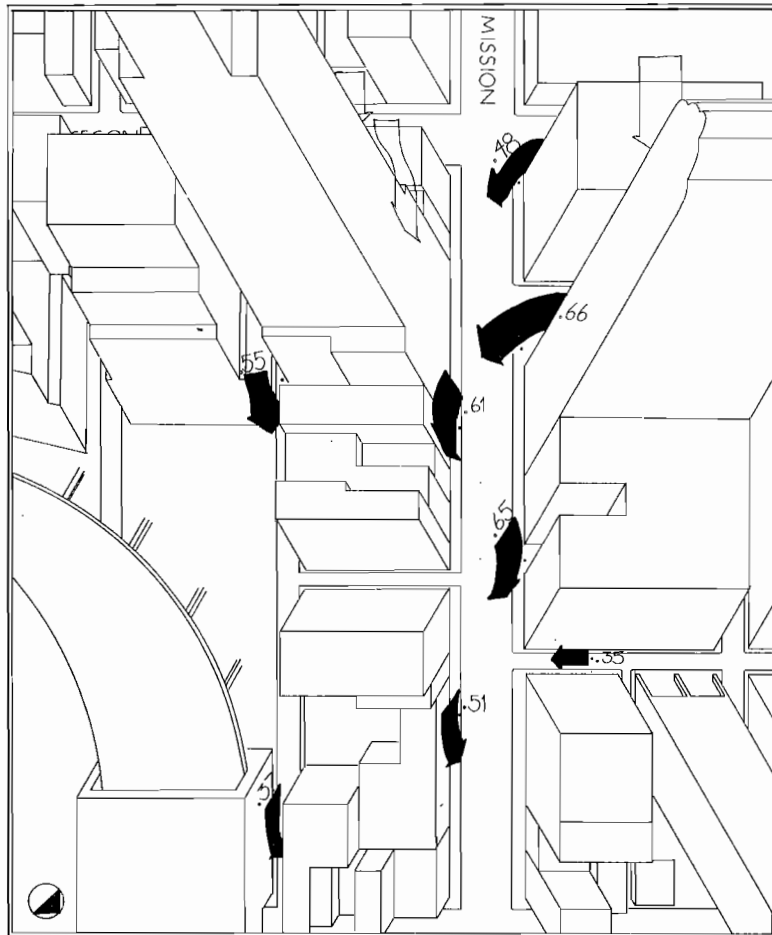

Partial Development under Proposed Downtown Plan

The winds from the southwest flow with the grain of the South of Market grid system, striking the buildings' windward sides head-on and channeling down the major streets. Under existing conditions, the highest wind speed ratios are produced by the downwash, corner, and wake effects created by the large buildings near the corner of Mission at Second Streets. The wind ratio is low at the southwest end of Minna, but increases near the Trans Bay Terminal.

With development under existing controls, the wind ratios along most of Mission increase significantly, and begin to approach unacceptable levels. At the west end of Minna Street, the downwash and channel effects produced under this scenario cause the wind ratio to jump from .13 to .59. When development is modeled for the same sites assuming the Downtown Plan's controls, the wind ratios along both Mission and Minna Streets remain as high as they were under the previous scenario, creating potential wind problems at mid-block on Mission. With full buildout under the Downtown Plan, the wind ratios at the points along Mission Street present a mixed picture. The ratios remain high near the Second Street end of the block, and an unacceptably high ratio of .70 is created at mid-block, but the ratios are slightly reduced at the

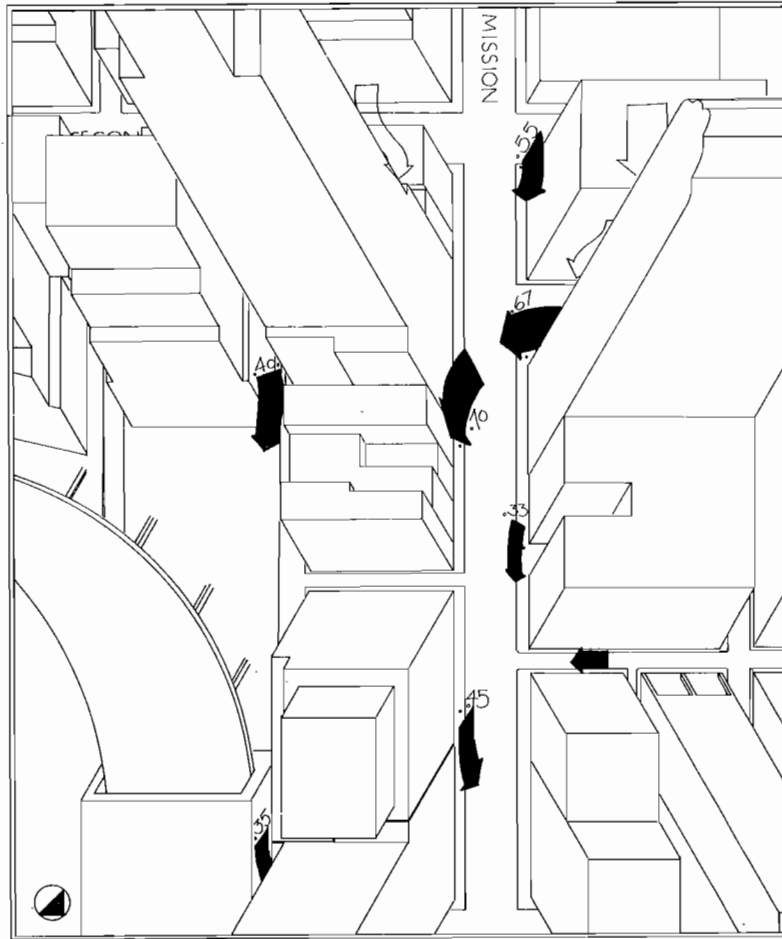

Full Development under Proposed
Downtown Plan

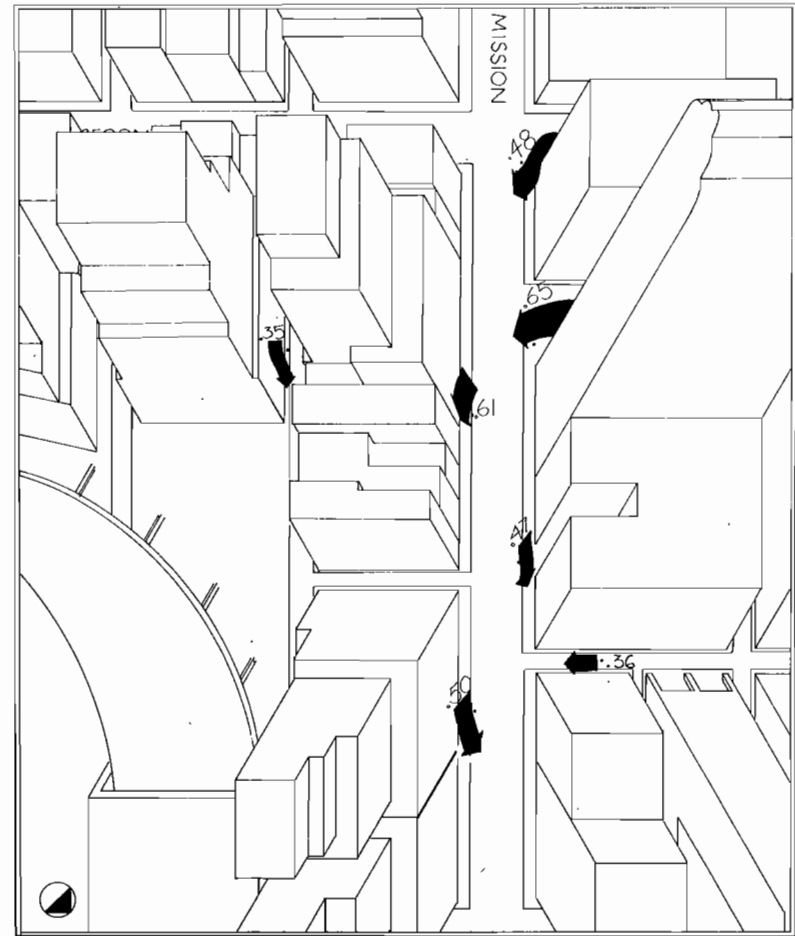

Mitigated Development

Wind from the Southwest

points further east. The ratios along Minna Street are somewhat lower than those produced in the preceding development scenarios. Under the mitigated development scheme, slight reductions are brought about in the ratios at most of the points, and the very high reading at the base of the tower at mid-block on Mission is brought down to a more acceptable level.

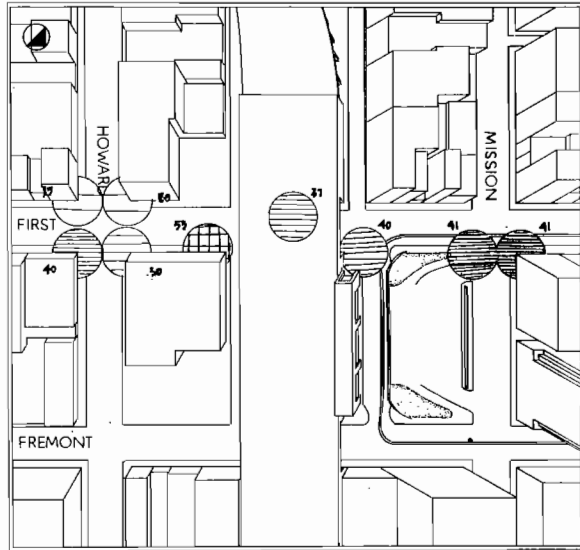

Existing Conditions

Trans Bay Terminal Area

Under existing conditions, winter thermal comfort levels on First Street near the Trans Bay Terminal are poor to fair. The points that are comfortable for the greatest amount of time are subject to only moderate wind flows, and are located on the east side of First, where they get direct solar radiation for a good part of the day. Although the point in the terminal underpass is in shade all day, it is comfortable a fair amount of the time because wind currents in the underpass are extremely light. When the scenario assuming development under existing regulations is modeled, comfort levels at most of the points remain about the same. One of the few changes occurs on the east side of First at Howard, where increased shading and corner winds created by the large

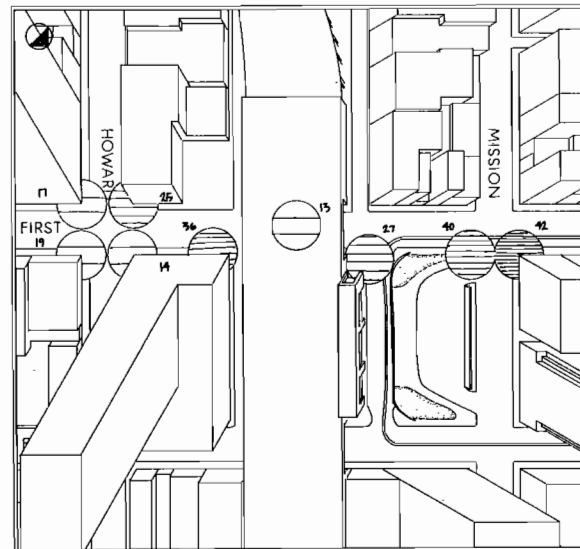
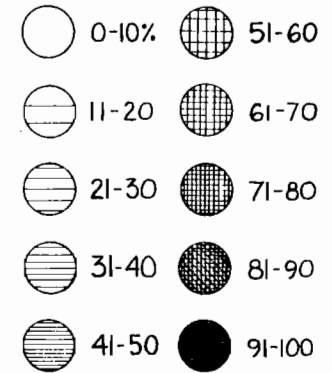

Development Under Current Controls

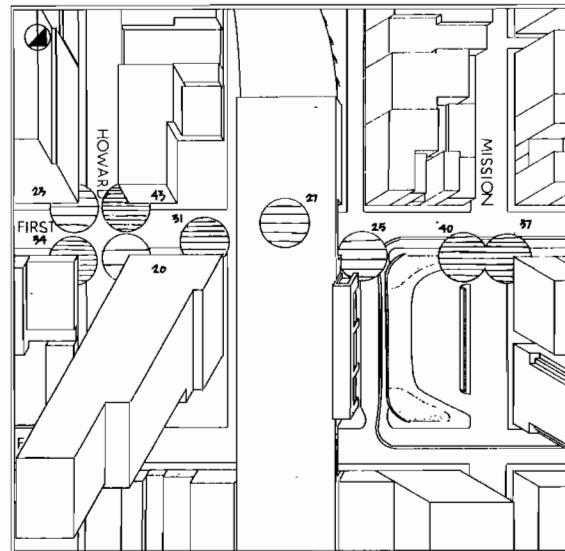

Partial Development under Proposed Downtown Plan

The drawings and text on the next pages summarize the results of the comfort modeling process. The numbers and circles located at each of the points indicate the percentage of time during the daylight hours of a particular season that sun and wind conditions would permit the maintenance of human thermal comfort.

Winter

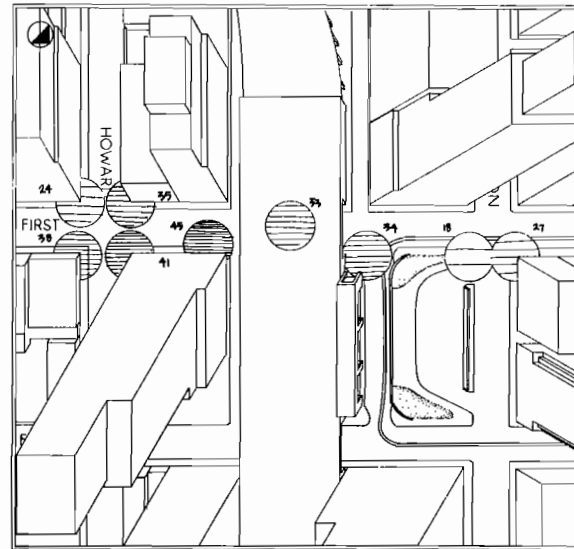

Full Development under Proposed
Downtown Plan

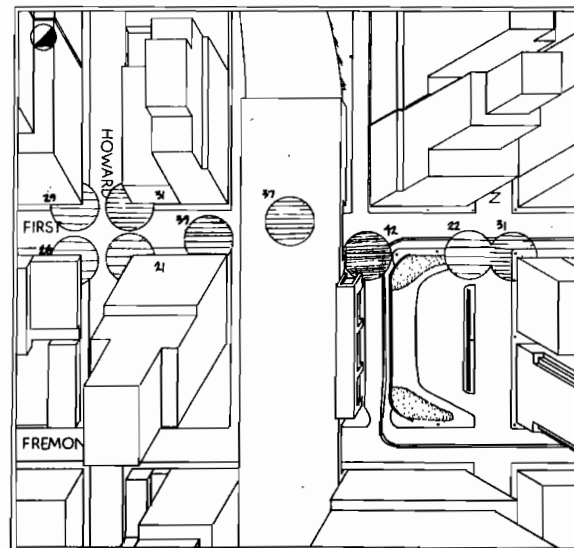

Mitigated Development

buildings assumed nearby cause the comfort percentage to drop by half. The sharp drop in comfort time in the terminal underpass is produced by the doubled wind flows occurring there under this scenario. When development of the same sites under the Downtown Plan regulations is modeled, comfort conditions at most points improve in comparison with the existing regulations case, reflecting the effect of building set-backs in improving solar access and moderating some of the worst street level wind flows.

Under the Downtown Plan full buildout scenario, comfort conditions south of the terminal remain the same or improve slightly because of the increased wind sheltering that takes place. North of the terminal, the large tower assumed for the site west of First shadows the points at First and Mission causing a substantial decrease in the percentage of time they are comfortable. The mitigated scenario has mixed effects. North of the terminal, the setting back of the tower at First and Mission increases solar access, mitigating the comfort impacts across the street. South of the terminal, the stepped back building designs reduce the wind sheltering effects of the Downtown Plan full development scenario, causing slight reductions in the comfort percentage at most of the points, but nevertheless producing comfort levels that are generally higher than those that would be created by development under existing regulations.

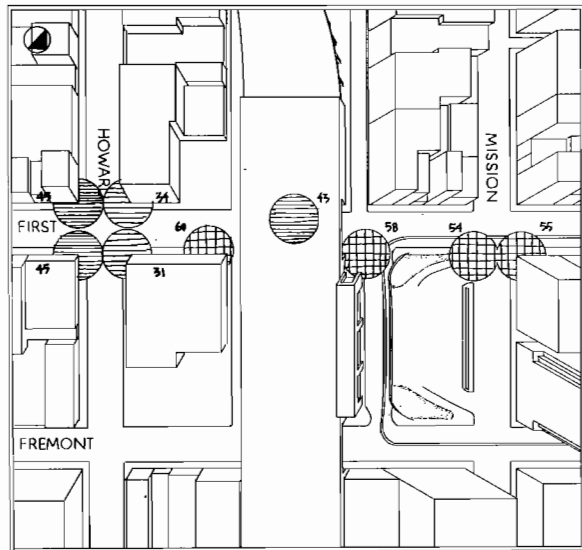

Existing Conditions

At most points in this area the Spring thermal comfort percentages are only fair under existing conditions. The lowest readings are created by afternoon shadows and relatively high winds at First and Howard. With development under existing regulations, the comfort percentages north of the terminal remain the same, but major decreases occur at First and Howard, reflecting the shadows and wind turbulence created by the tall buildings assumed for that corner. Doubled wind flows in the terminal underpass produce the sharp drop in the comfort percentage there. Modeling development of the same sites assuming application of the Downtown Plan's regulations produces comfort percentages south of the terminal that are much improved over those of the existing regulations case, and that are nearly as high as those that exist at present. When full develop-

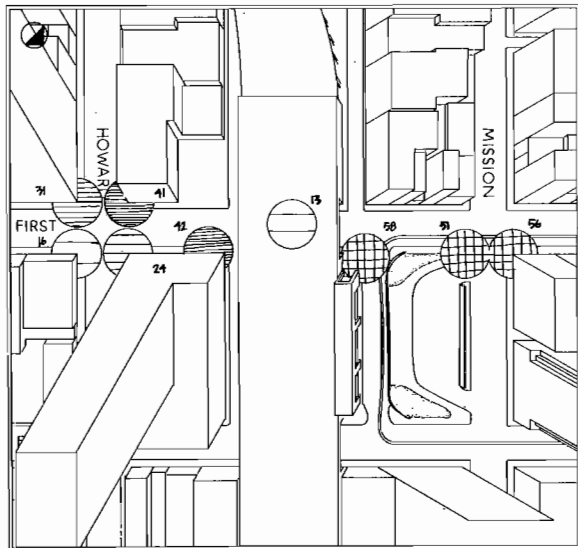
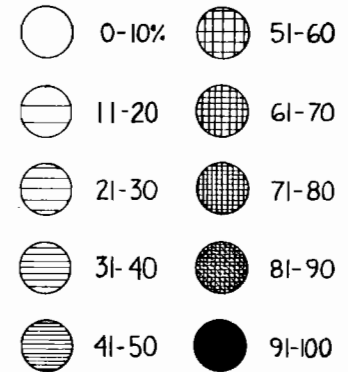

Development Under Current Controls

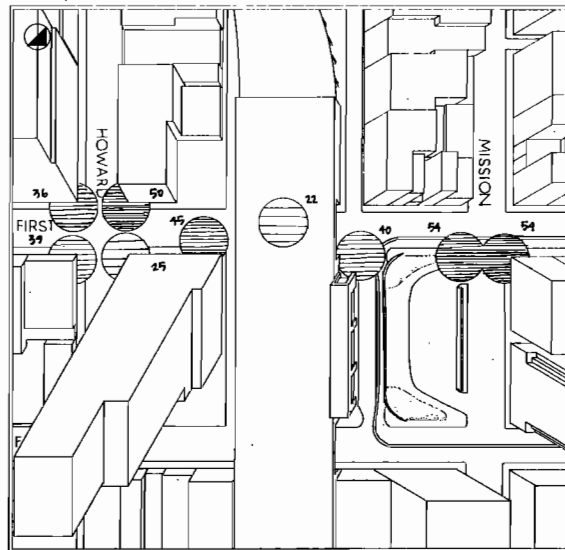

Partial Development under Proposed Downtown Plan

Spring

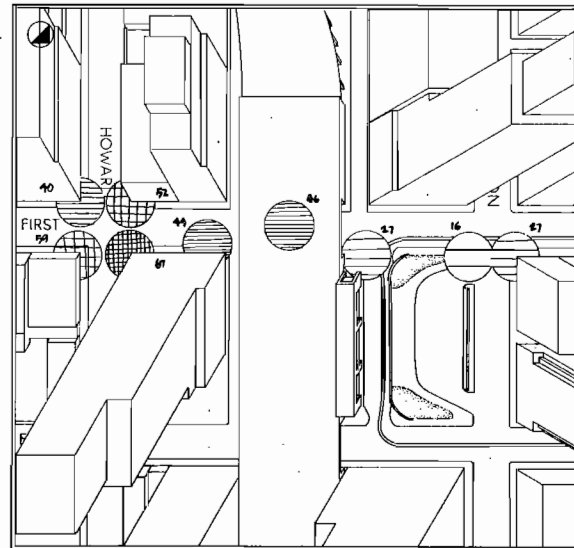

Full Development under Proposed
Downtown Plan

ment under the Downtown Plan is tested, most of the comfort readings south of the terminal improve in comparison with the other cases, reflecting the fact that sun access is partially protected, and street level wind effects are reduced. The comfort percentage under the terminal overpass improves, too, as a result of greatly decreased wind flows. North of the terminal though, the comfort percentages are reduced by half or more by the shading created by the two large buildings assumed at First and Mission. The mitigated version of the Downtown Plan full development scenario succeeds in reducing most of the comfort impacts, producing comfort levels that are not significantly lower than those that exist at present.

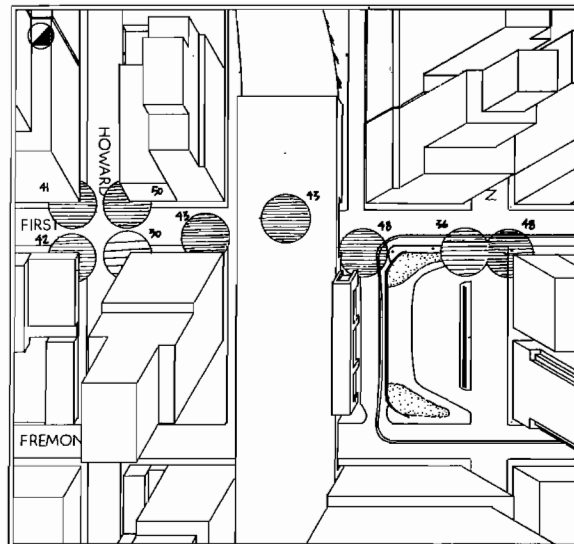

Mitigated Development

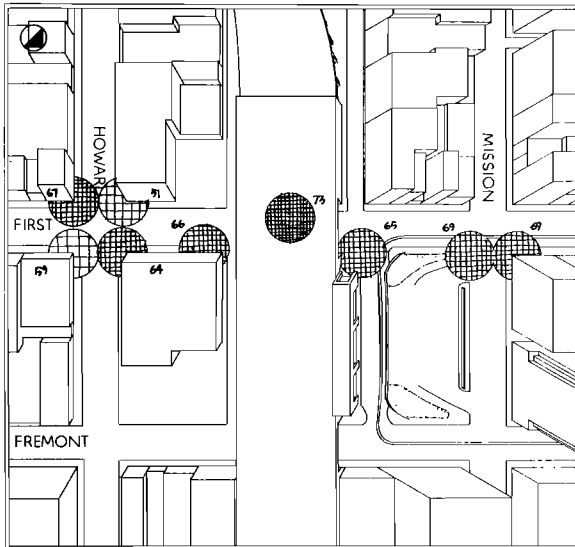

Existing Conditions

Existing summer comfort conditions are relatively good at all points in this area. Under the existing development controls scenario, comfort levels drop off somewhat at First and Howard due to the shadow and wind effects of the large buildings assumed there. The comfort percentage in the terminal underpass drops to 1/3 of what it is under existing conditions because of the doubling of wind speed that occurs there. The Downtown Plan-partial development scenario, which provides for more sunlight preservation than the existing regulations case, produces somewhat better comfort readings. The Downtown Plan full development scenario leaves the comfort levels south of the terminal at relatively high levels. However, the shadows created by the tall buildings assumed at First and Mission bring about substantial reductions in the

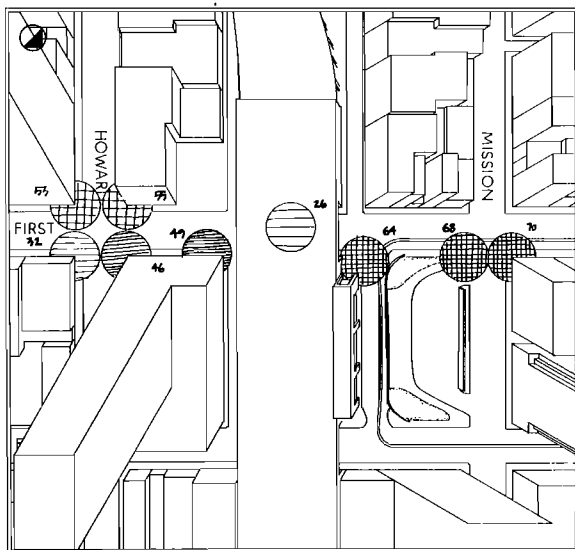
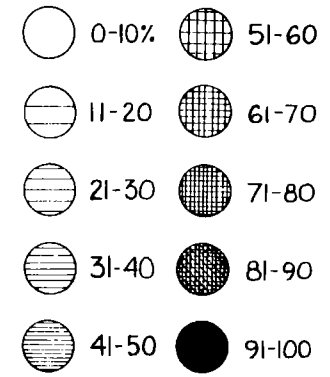

Development Under Current Controls

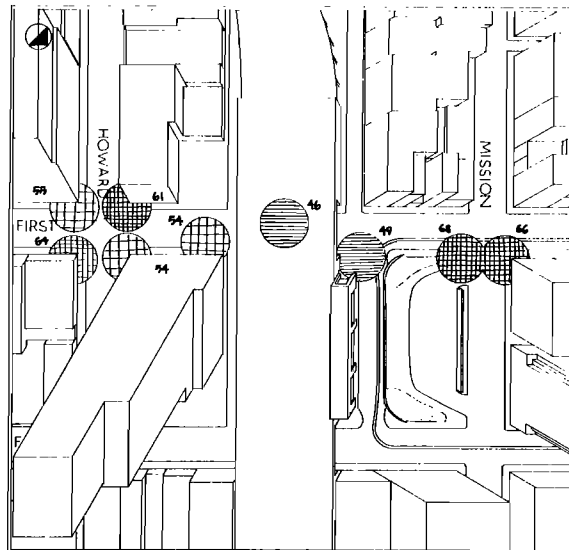

Partial Development under Proposed Downtown Plan

Summer

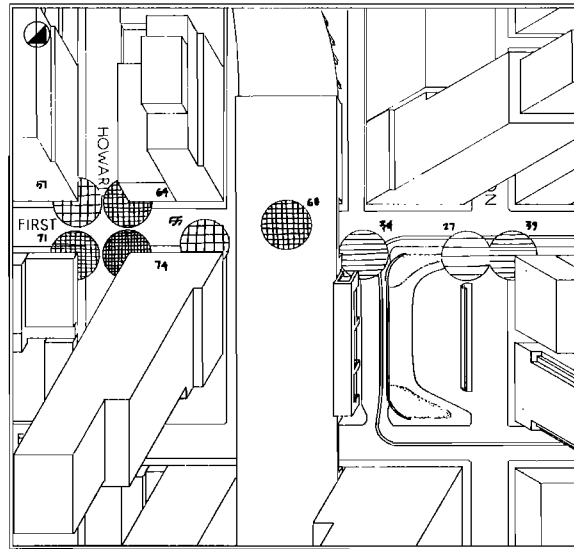

Full Development under Proposed
Downtown Plan

comfort hours at the points across the street. Under the mitigated scenario, the comfort impacts of the building at First and Mission are significantly reduced, and good comfort conditions are also maintained at all the other points.

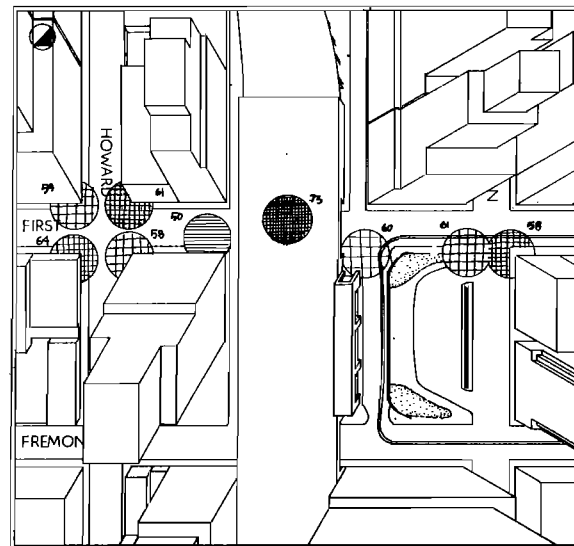

Mitigated Development

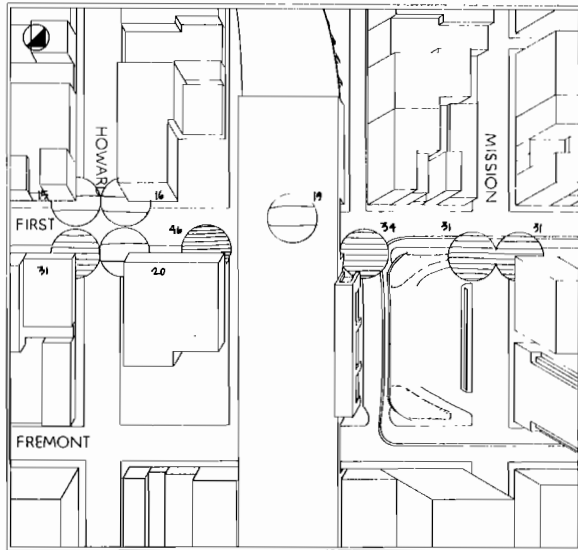

Existing Conditions

The existing thermal comfort conditions in this area are mixed. In the sunny areas north and just south of the terminal, the percentages are relatively high. Shadow and wind effects create much lower readings at First and Howard and under the terminal overpass. When development under existing controls is modeled, increased winds and shadows make comfort conditions somewhat worse at several points south of the terminal and at the points under and just north of the terminal overpass. When development of the same sites under the Downtown Plan's provisions is modeled, increased winds make the impacts slightly worse north of the terminal, and improved sun access and wind sheltering make them slightly better at First and Howard. The Downtown Plan full development scenario has the greatest impact north of the terminal where the

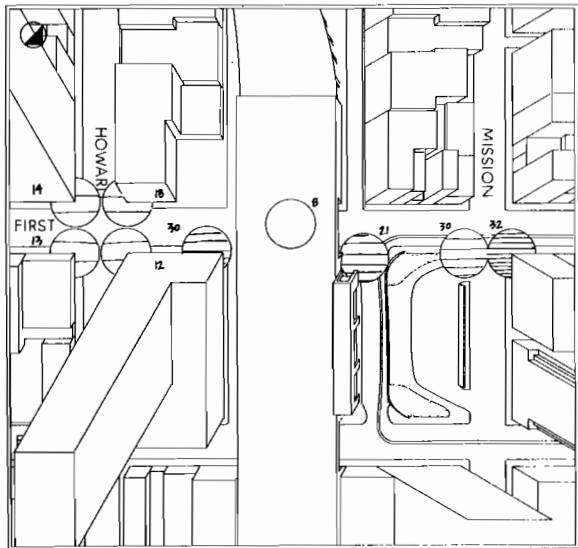
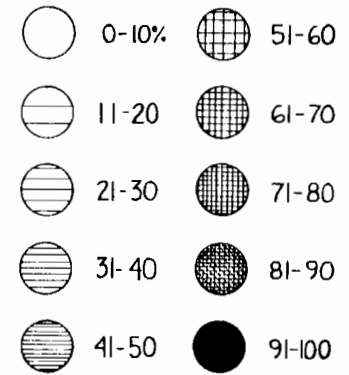

Development Under Current Controls

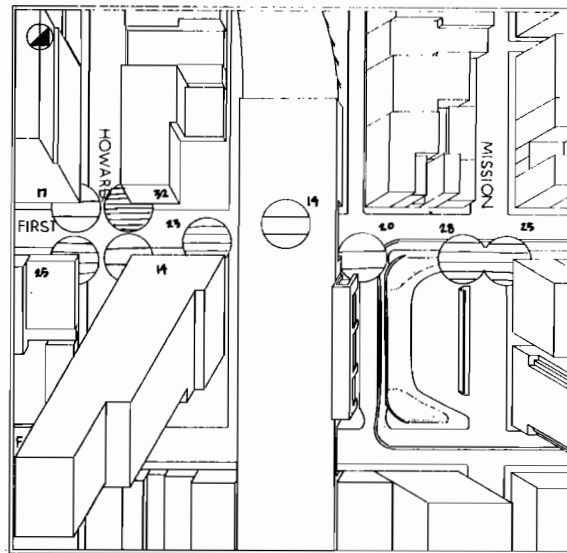

Partial Development under Proposed Downtown Plan

Fall

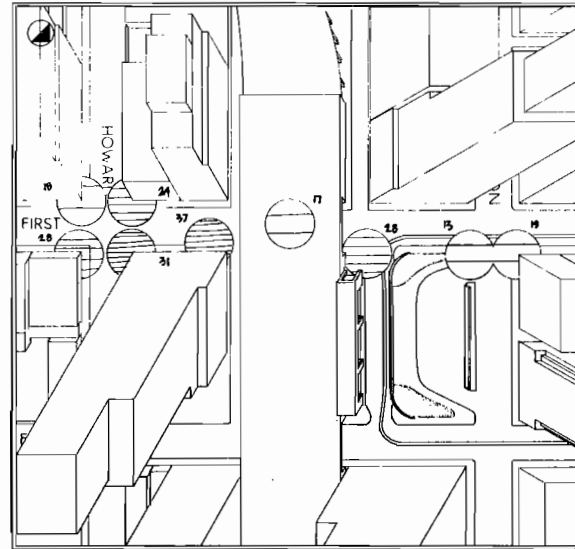

Full Development under Proposed
Downtown Plan

shadows cast by the tall building at First and Mission produce major reductions in the comfort hours. The mitigated case slightly reduces the comfort time decrease at First and Mission and creates conditions south of the terminal that are approximately the same as those that exist at present.

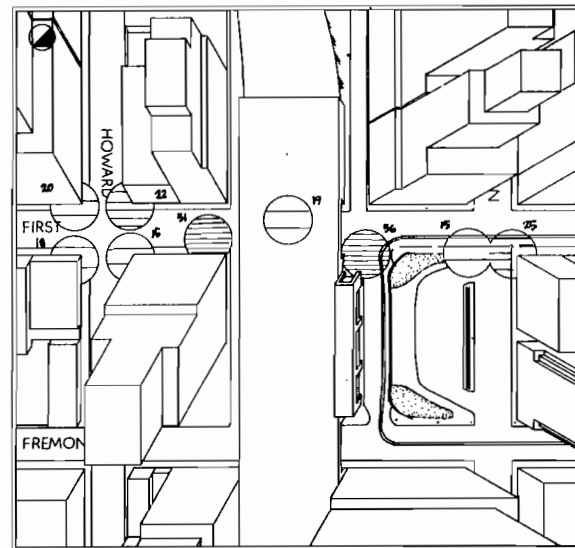

Mitigated Development

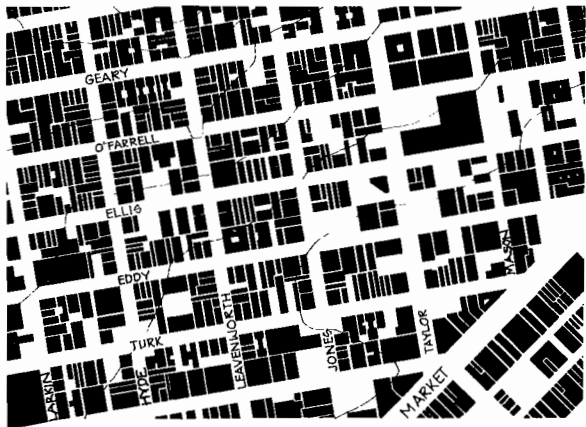

Findings and Conclusions

Although this study's analyses were carried out for four limited areas in San Francisco's downtown

fringe, producing area-specific findings, some generalizations that are more global can be made.



A wide range of wind conditions was found in the streets and open spaces evaluated in this study. The highest wind ratios were found at points in streets, particularly at corner locations. In general, winds in parks and other open spaces were considerably more calm. Winds also varied considerably from one area to another. Chinatown had the lowest wind velocities of all the areas studied. The sheltering provided by the hills to the west and northwest, and the homogeneous building height create a wind environment that is calm throughout the area. The only exception to this generalization is the area at Stockton and Washington Streets where the Mandarin Tower's abrupt height change creates disturbed wind patterns. The area around the Trans Bay Terminal also has relatively good wind conditions. The high buildings along Market Street shelter it from the strong west and northwest winds. The Tenderloin is windier than Chinatown or the Terminal area. The district is more exposed to the west winds, and the fact that building heights are not homogeneous is a source of wind disturbances. The strip along Van Ness is the windiest of all the areas studied. Because of its ridge-top location on the windward side of the downtown, it is the most fully exposed to the force of the prevailing west and northwest winds.

Winds on Streets

Within the areas studied, few locations were found where wind alone is likely to produce uncomfortable conditions for pedestrians or open space users. A surface wind of 12 miles per hour is considered uncomfortable for people walking on sidewalks. Equivalent wind speed ratios of .65 will be unpleasant but not uncomfortable, if the ambient windspeed measured at a weather station exceeds 12 miles/hour. The ambient windspeed at the weather station has to measure 18 miles per hour or more for a location with an equivalent windspeed ratio of 0.65 to become uncomfortable. Windspeeds of 18 miles per hour and above occur relatively frequently, particularly on spring and summer afternoons.

Points with windspeed ratios above 0.65 were found under existing conditions in the Tenderloin at Ellis and Taylor Streets at the foot of the Hilton Tower; at Stockton and Washington Streets in Chinatown, at Van Ness and Pine and California Streets, but not in the Trans Bay Terminal Area. At all of these points, the wind problems were caused by the abrupt change in height that occurs when a tall building is set down in an area of lower buildings of uniform height.

Many additional points come into the range of 0.65 and above

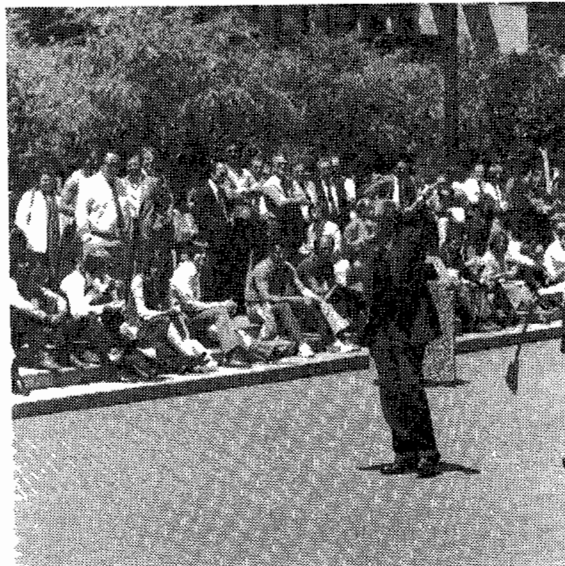

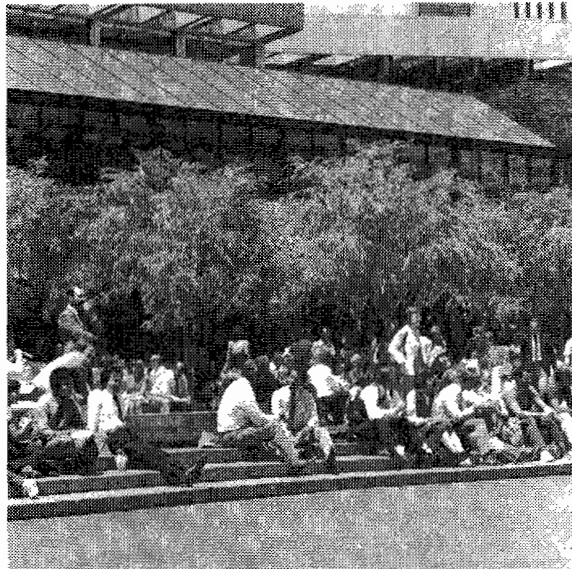

with development under current controls. It is possible to site new high buildings so that they shelter existing problem buildings, reducing their wind effects. The likelihood, however, is great that the original problem is carried to the windward side of the new building. Several buildings that gradually step up to the maximum height are necessary to mitigate for the bad wind conditions created by existing abrupt changes in building height.

In open spaces windspeeds of 7 miles per hour are considered uncomfortable for people sitting on benches. Here an equivalent windspeed ratio of .60 would be considered unacceptable at a windspeed of 12 miles per hour. No windspeed ratios of .60 were found in the three open spaces studied. The highest ratios found in an open space are in the .34 to .40 range in Boedekker Park and on Portsmouth Square. Here an ambient wind of 18 to 20 miles an hour is needed to make for an uncomfortable sitting environment. Again, winds in this range do occur in San Francisco, and they are most likely on spring and summer afternoons.

Mitigating Wind Effects--Setback Tests

Because most severe windflows were found at the corners of high buildings, we conducted additional studies to learn more about how corner flows might be mitigated through building design.

Building Setback Testing

To test techniques for mitigating development's wind effects, we initiated a series of tests which compared the wind velocities using different combinations of building setbacks. We also studied the effects with a 60' building across the street and a 120' building across the street. The depths and heights of the setbacks are shown in the adjacent drawings.

Based on these tests, we concluded that setbacks do not improve the wind conditions at the center of a building, but do tend to mitigate the tendency for higher windspeeds to occur at the corner of a building. The photographs illustrate what happens using a smokestick. In the first photograph (with no setbacks) air is forced down the facade of a building and outwards towards the corners. As soon as it reaches the corner, the air sweeps around the building in much the same fashion as it does on an aircraft

Condition with 60' High Building Across the Street

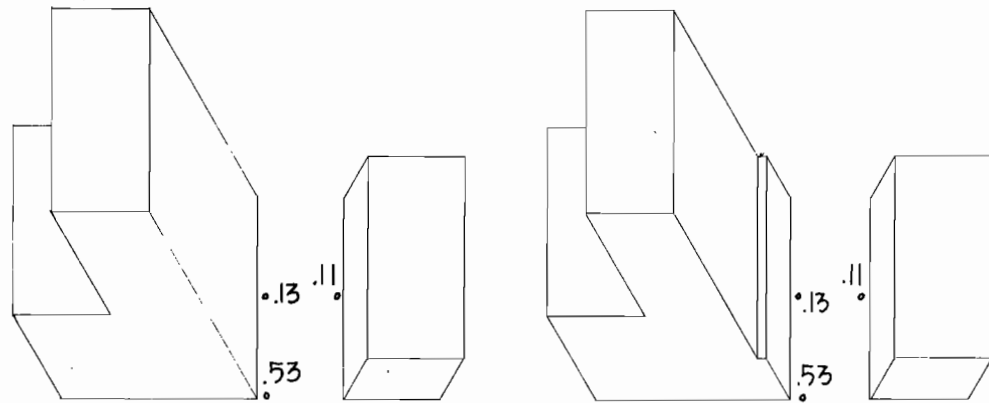

No Setbacks

1 - 12' Setback @ 60'

Condition with 120' High Building Across the Street

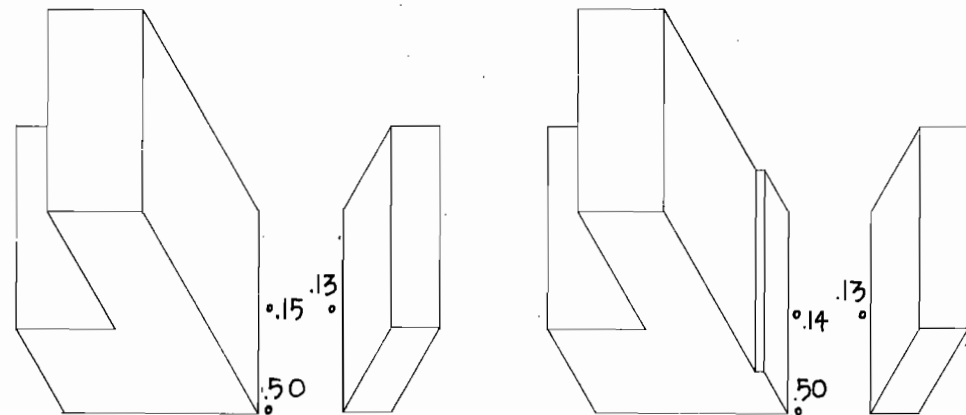

No Setbacks

1 - 12' Setback @ 60'

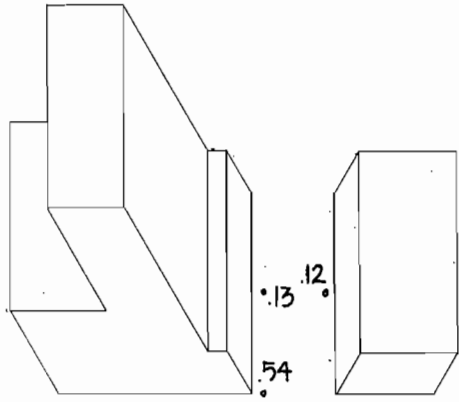

1 - 24' Setback @ 60'

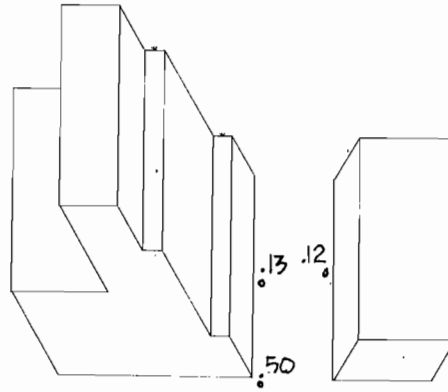

2 - 24' Setbacks @ 60' & 180'

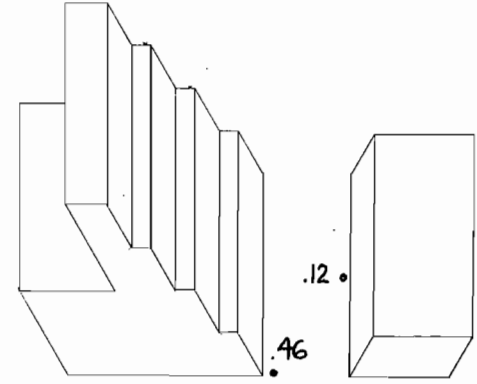

3 - 24' Setbacks @ 60', 120', & 180'

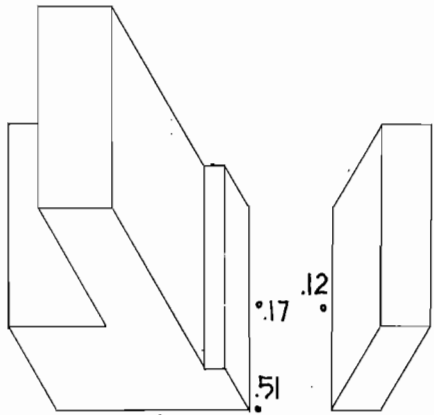

1 - 24' Setback @ 60'

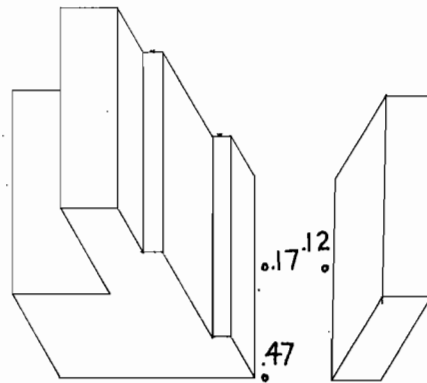

2 - 24' Setbacks @ 60' & 180'

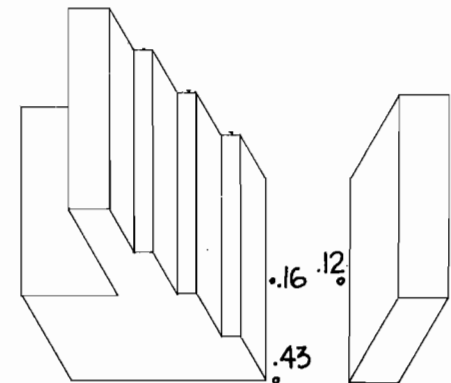

3 - 24' Setbacks @ 60', 120', & 180'

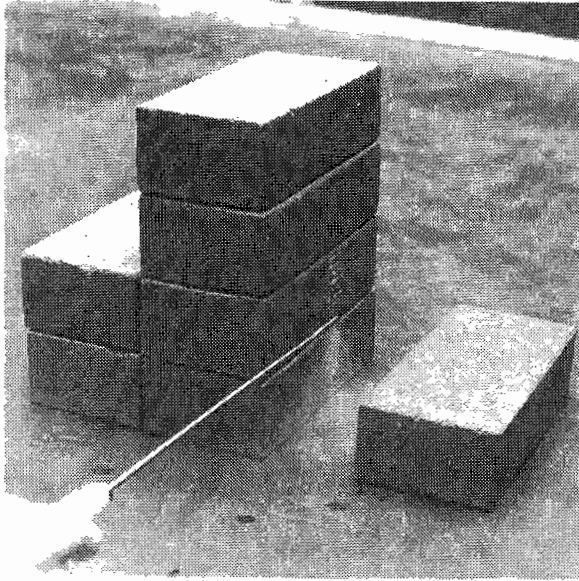

Smoke Test - No setbacks and 60' building across the street

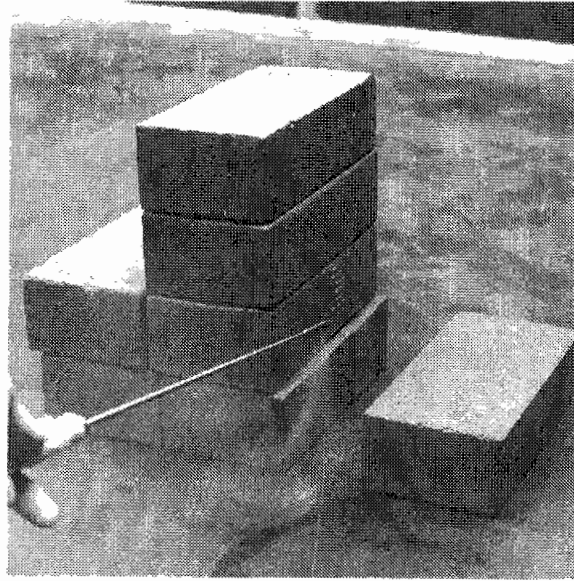

Smoke Test - Setbacks and 60' building across the street

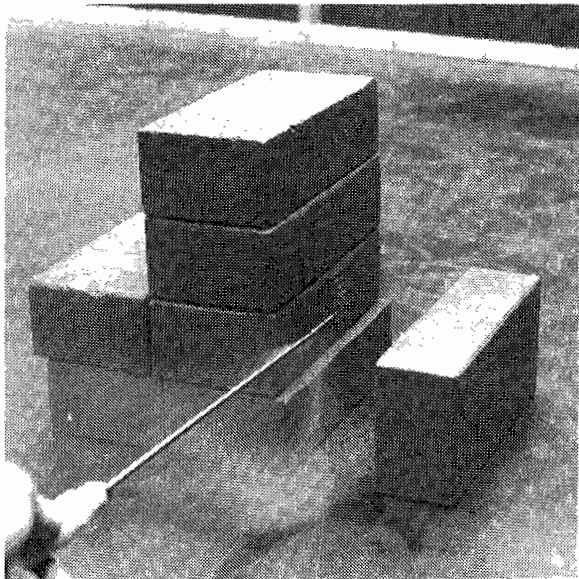

Smoke Test - Setbacks and 120' building across the street

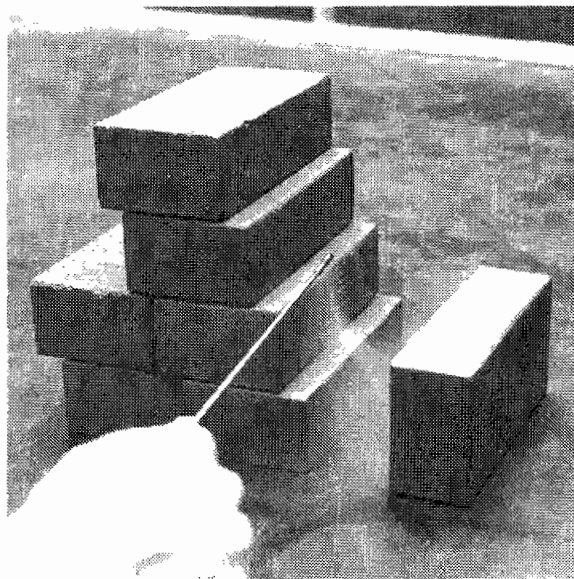

Smoke Test - Setbacks and 120' building across the street

wing. With a 12' setback as shown in the second photograph, the air is slowed somewhat in the downward direction which results in a slightly lower windspeed at the corner. To significantly reduce the corner windspeeds, however, it was necessary to have three twenty-four foot setbacks at the base, mid-tower, and upper tower levels (third photograph). This combination of setbacks resulted in a reduction of 15% in the measured wind velocity at the corner test point.

These findings correspond with similar readings in the four areas tested. In some cases, however, larger reductions in wind ratios are found between build-out under the existing regulations and build-out under the mitigated conditions due to the fact that there is often a difference in height between the two scenarios. This test involves only effects of building setbacks for structures of the same height. Additional research is required to assess the optimal wind setbacks for buildings of various heights and orientations on their blocks.

Comfort Findings

One of the study's most basic and predictable findings was that under San Francisco's climatic conditions, when sun is present, people generally feel sufficiently warm to be comfortable. Analysis of the data for the points evaluated in this study indicates that areas receiving direct solar radiation are comfortable more than 50% of the time, while places in shadow are rarely comfortable.

Another very basic finding is that when the street level wind velocity ratio exceeds .50, the place is likely to be uncomfortable much of the time, even if it receives direct solar radiation. A related finding is that when a place is in the shade, reducing high wind speeds is usually not enough to make the place comfortable.

Even though San Francisco's daytime air temperatures vary within a relatively narrow range from season to season, outdoor thermal comfort levels vary considerably from one time of year to another. This study's comfort analysis indicates that, on the average, points in downtown streets and open spaces are comfortable for pedestrians about 75% of the daytime hours during the summer, but only about 35% of the time during the day in the winter.

The lower winter comfort levels are a product of lower ambient temperatures, and perhaps more importantly, of a decreased solar contribution to comfort. In the winter, not only does the sun provide less warming radiation, it is also less available--because of the sun's lower position in the sky, city streets and parks are much more likely to be in shade than in the other seasons.

The study's analyses also found that comfort conditions vary considerably from area to area. For a number of reasons, Chinatown has the best comfort conditions of all the areas studied. Nob and Russian Hills shelter the neighborhood from the full force of the prevailing winds. The area's generally low and uniform building heights provide for good sun access and preclude the disturbed street level wind patterns produced by tall buildings and juxtapositions of buildings of varying heights. The Trans Bay Terminal area also has relatively good comfort conditions at present. The Financial District's cluster of tall buildings breaks the winds from the northwest, and the south of Market Street grid orientation reduces the impacts of the prevailing west and northwest winds. The street grid orientation also maximizes street level sun penetration. Although the

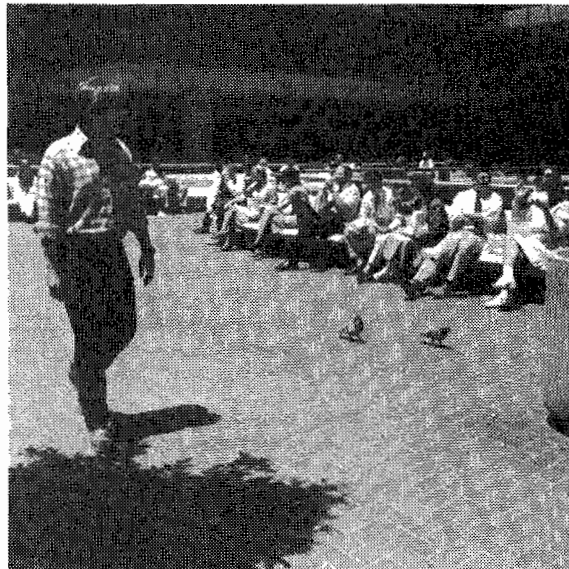

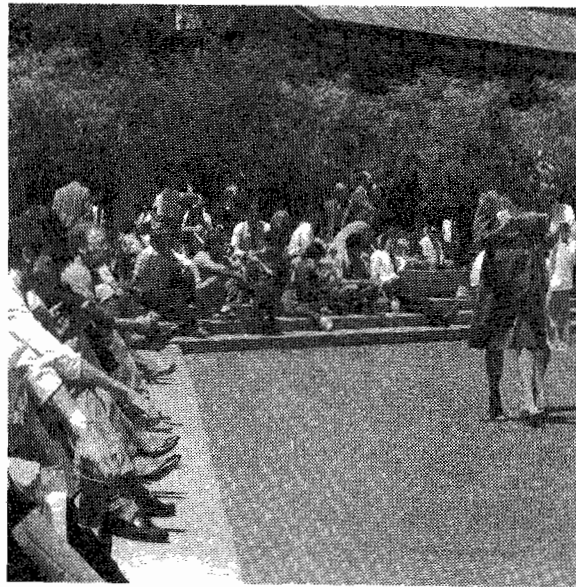

buildings are higher than those in Chinatown, street level sun access is still relatively good, and except for the strip along Mission, heights are uniform, producing relatively calm street level wind conditions in much of the area. The Tenderloin has slightly less comfortable conditions. Because the area lies on the windward side of the central district, there is no sheltering from the prevailing winds and the abrupt change in heights where the area abuts the Union Square Hotel district creates some severely disturbed wind patterns. Although most buildings in the area are 4 to 6 stories in height, some are considerably taller, creating localized shading and wind problems. The Van Ness Area has the poorest thermal comfort conditions of all the areas evaluated. To a large extent, the poor comfort conditions are related to the area's exposed ridge-top location which enables the prevailing winds to strike the area's taller buildings with full force, producing highly disturbed wind patterns at street level.

Recommendations

Sun Access for Streets

The study confirms that direct sunlight is crucial for comfort in San Francisco, especially in areas like Chinatown and the Tenderloin, where residents depend on streets and alleys for open space, it is important to preserve as much sunlight as possible. Analyses of various downtown streets indicate that many of the east-west streets receive sunlight for 6 months of the year for many hours during the day and that north-south streets are sunny year round at lunchtime.

Therefore, observe cutoff angles of 50 degrees on east-west streets, struck from the curb of the northern sidewalk projected across to limit heights on the southern side of the street. On north-south streets, buildings following cutoff angles of 50 degrees will first allow the western side of the street to remain

sunny during midmorning, and then as the sun moves to lunchtime the entire street will be in the sun. After lunch, buildings on the western side of the street following the 50 degree angle will allow the sun to reach the eastern sidewalk until the early afternoon.

If cutoff angle and height limits are the only constraints on development envelopes, bulky and pyramid shape buildings are likely to result.

Therefore, set the Floor Area Ratio limits in such a way that future buildings can not follow an envelope defined by cutoff angles and height limit alone but are further constrained by FAR. For Chinatown an FAR of 4:1; and 6:1 for the Tenderloin will generally produce building forms that follow the sun access criteria but also be compatible with existing building volumes and street scale.

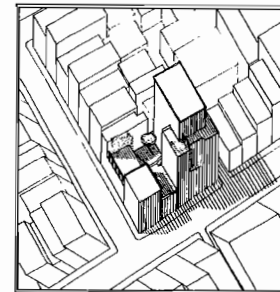
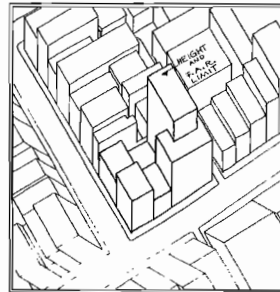
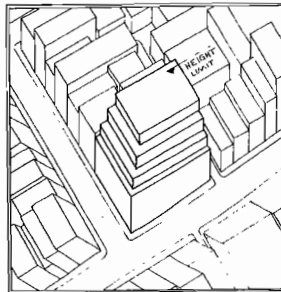
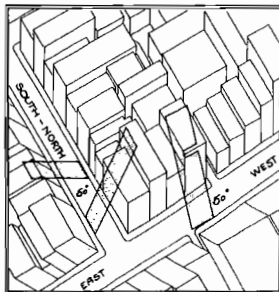

Parks and Plazas

In the vicinity of several downtown parks, plazas and squares building envelopes block sun access, making the open spaces uncomfortable.

Therefore, configure building envelopes in the vicinity of publicly accessible open spaces in such a way that a maximum amount of sunlight reaches into such spaces during the critical use hours.

The voters in San Francisco have mandated through a referendum that sun access for parks under the jurisdiction of the Recreation and Parks Department be preserved for all hours of the day from one hour after sunrise to one hour before sunset for all months of the year. Based on our study we find that preservation of sunlight for other public and private open spaces is of similar importance.

Previous studies indicate it possible to preserve sunlight at lunch-time for a minimum of 6 months of the year.

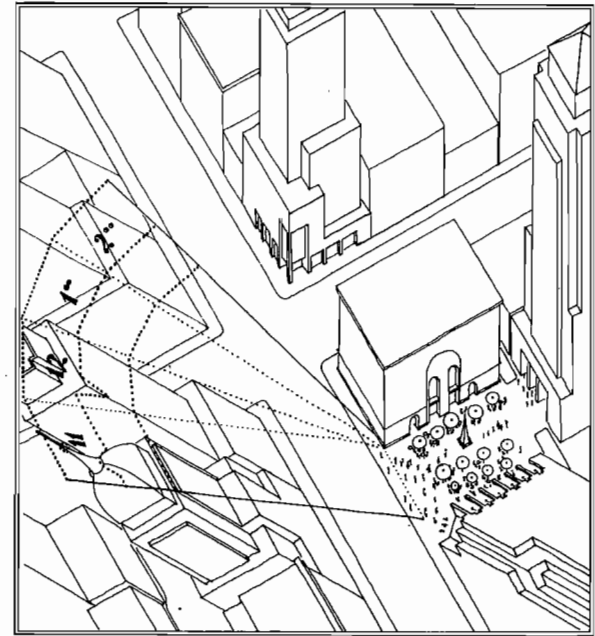

Therefore, require that new building in the vicinity of all open spaces not under Recreation and Parks jurisdiction be shaped and placed in such a way that sun access is preserved between 11:00 am and 2 pm Standard Time (12 to 3 pm daylight savings time) from the spring to the fall equinox.

Require that future downtown open space not under jurisdiction of the Recreation and Parks Department also be protected by this measure. Solar Fans (height measurements for sun access) should be constructed for all existing and proposed open spaces.



Wind

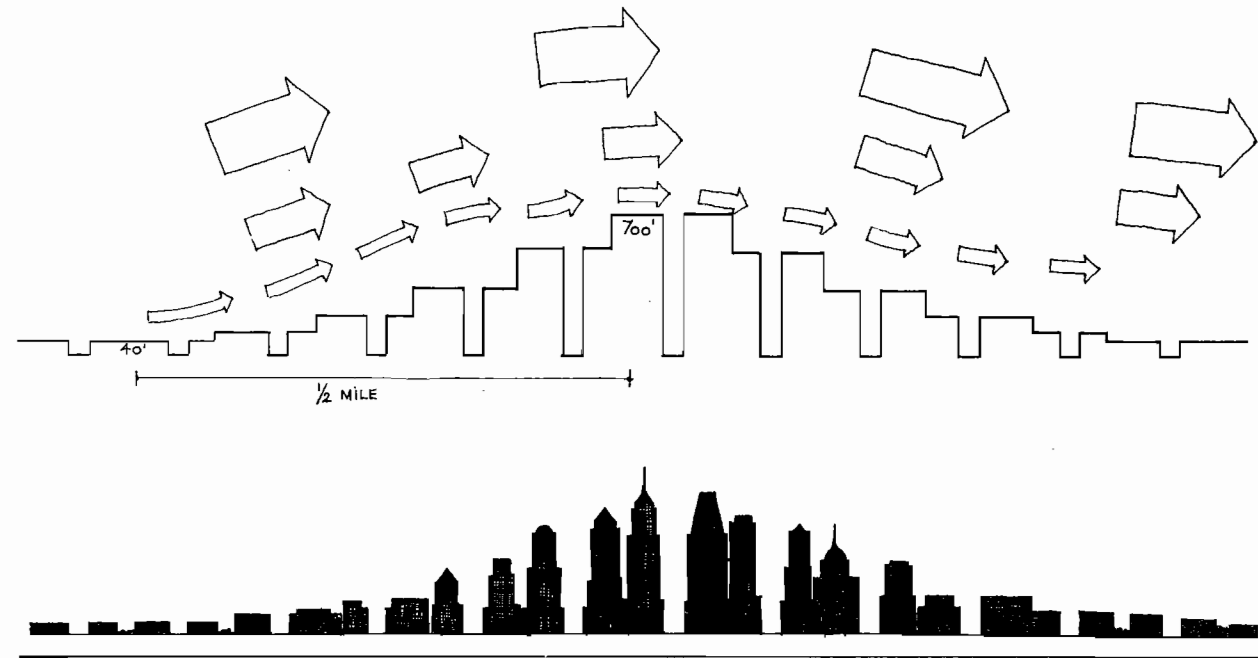

We have found that an abrupt change in the heights of buildings causes a significant impact on wind velocities on adjacent streets and parks. This is particularly important along the western edge of the Downtown, because the winds most frequently come from the west and northwest. Once a large building is constructed in an area where low buildings predominate, it is extremely difficult to mitigate the negative effects generated.

Therefore, height zone transitions should be made gradually, avoiding changes that exceed 100% of the height of the previous zone.

It has been customary to draw the lines representing height zone changes along streets. As a result, abrupt height changes from one side of the street to the other have been created in various parts of downtown San Francisco.

Therefore, height changes should not occur along streets but should be drawn in the center of blocks. In locations, where bad wind conditions exist, future buildings should be designed to mitigate for adverse wind conditions by blocking prevailing winds and thereby providing shelter for open space or pedestrian corridors.

Whenever possible, a broad facade of a building should be oriented on an east-west axis so that the narrow portion of the building faces the prevailing westerly winds. This allows the wind to flow more easily around the building instead of catching the breeze and bringing it down to the pedestrian level.

If the Hilton Tower had been constructed with an orientation similar to the Chinatown Holiday Inn, for example, there would be less of a wind problem around the tower's base. This recommendation is particularly important to follow when a building is by necessity higher than surrounding buildings. Locations that are exposed to strong winds in San Francisco warrant special attention.

Therefore, the designs of potential high buildings in these locations should be tested in a wind tunnel to determine adverse wind effects early in the planning process.

One example of an exposed location is Rincon Hill. Due to its elevation this location is not sheltered from west- and north-west winds by downtown development. The hill is also exposed to the southeast wind, which during the winter months brings bad weather. High winds here at street level could be very uncomfortable for pedestrians.



1984

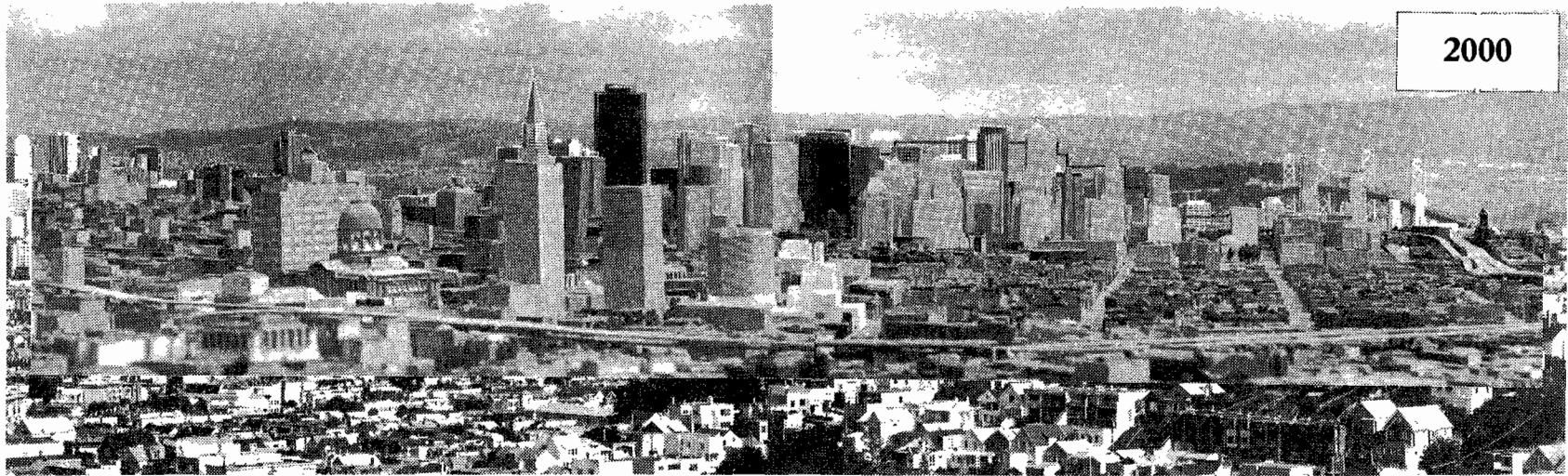

2000

Downtown Plan as of 6/84

MARKET--VAN NESS

FEDERAL BUILDING

THIS AREA NEEDS ONE OR MORE 10 TO 12 STORY BUILDINGS TO GRADUALLY STEP UP TO FOX PLAZA AND AAA BUILDING.

YBC

ABRUPT HEIGHT CHANGES OF YBC DEVELOPMENT ALONG 3rd STREET.

TRANSBAY - TERMINAL AREA

SHOULD BE A GRADUAL EXTENTION OF DOWNTOWN HILL.

RINCON HILL

ALL TOWERS SHOULD HAVE SETBACKS ABOVE THE STREETWALL HEIGHT.

BUILDINGS FACING WEST AND SOUTHWEST WINDS

1984



2000

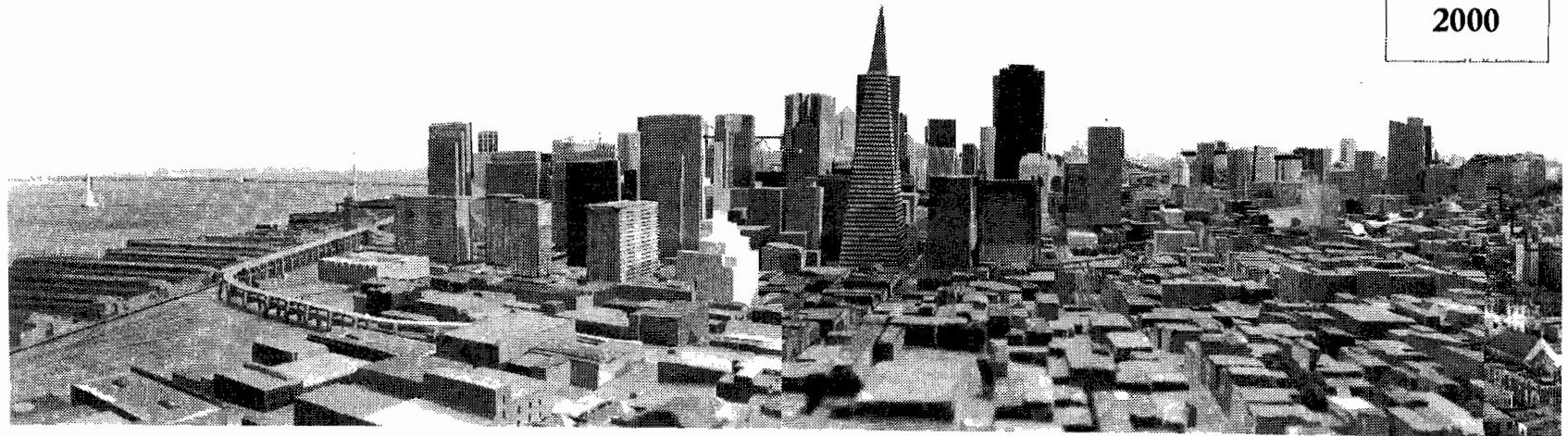

Downtown Plan as of 6/84

ALCOA BUILDING

BANK OF AMERICA

HILTON TOWER

IMMIGRATION BUILDING

BUILDINGS FACING NORTHWEST AND WESTWINDS

1984

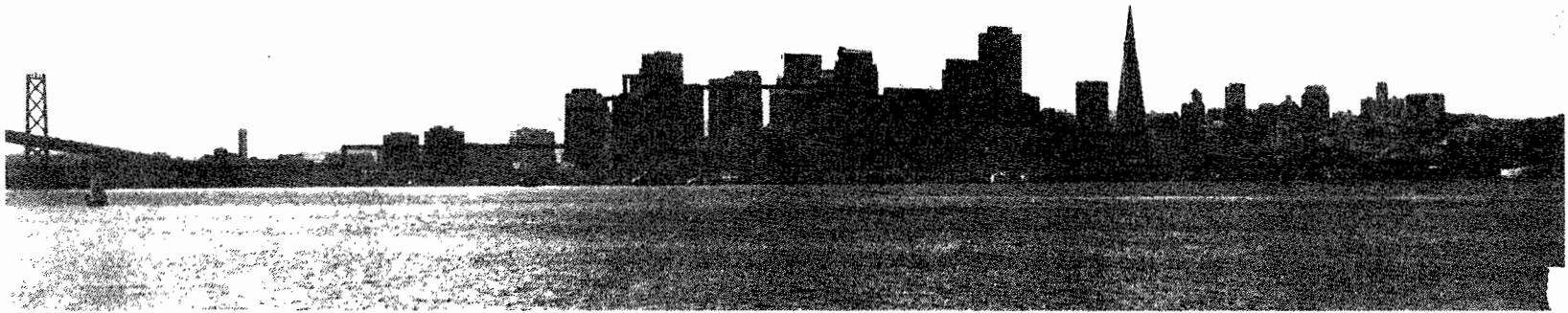

2000

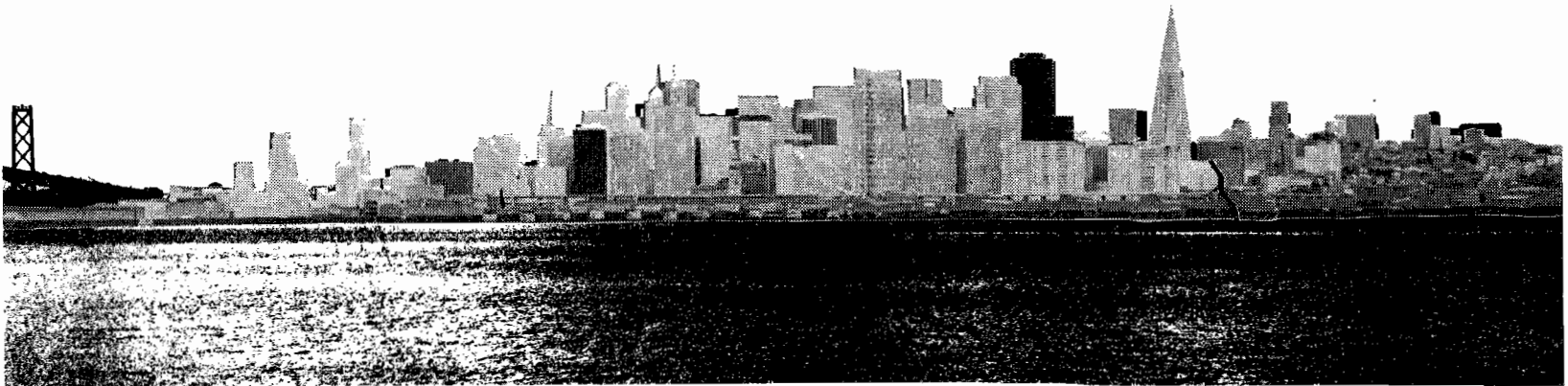

VIEW FACING LEEWARD SIDE OF CITY

Downtown Plan as of 6/84

Bibliography

Sun, Wind, and Comfort

Arens, Edward, "Designing for an Acceptable Wind Environment," Transportation Engineering Journal, ASCE, Vol. 107, No. TE2, March 1981, pp. 127-141.

Arens, Edward and Andrew G. Blyholder, Analysis of Thermal Comfort by Natural Ventilation for Project P-089 at Camp Smith.

ASHRAE Standard 55-81 Thermal Environmental Conditions Occupancy. January 81, Atlanta: American Society of Heating, Refrigerating, and Air Conditioning Engineers, Inc.

Berglund, L.G. and Stolwijk, J.A.J., "The use of simulation models of human thermoregulation in assessing acceptability of complex dynamic thermal environments." Stolwijk, J.A.J., ed. Energy conservation strategies in buildings

Gagge A.P., Stolwijk, J.A.J. and Nishi, Y. 'An effective temperature scale based on a simple model of human physiological regulator response' ASHRAE Trans. 70, (I) 1970.

Gandemer, J. "Wind Environment Around Buildings: Aerodynamic Concepts." Proceedings of the Fourth International Conference on Wind Effects on Buildings and Structures, London, 1975. Cambridge: University Press, 1977.

Gandemer, J. and A. Guyot. Integration du Phenomene Vent dans la Conception du Milieu Bati; Guide Methodologique et Conseils Pratiques. Paris: Premier Ministre Groupe Control des Villes Nouvelles Secretariat General.

Hunt, J.C.R. "The Effect of Single Buildings and Structures." Philosophical Transactions, Royal Society, London. Vol. 269, May, 1971, pp. 457-467.

Hunt, J.C.R., Poulton, E.C., and Mumford, J.C., "The Effects of Wind on People: New Criteria Based on Wind Tunnel Experiments," Building and Environment, Vol. II, 1976 pp. 15-28.

National Climatic Center. "Typical Meteorological Observations. Asheville, N.C.: National Climatic Center, May 1981.

University of California Environmental Simulation Laboratory, Bosse-
selmann, Peter, Juan Flores,
and Terence O'Hare, Sun and
Light for Downtown San Fran-
cisco, Institute of Urban and
Regional Development, Monograph
No. 34, College of Environmen-
tal Design, Berkeley, April
1983.

San Francisco Plans, Studies and
Ordinances

Environmental Sciences Associates,
Inc., Growth Management Alter-
natives for Downtown San Fran-
cisco: Downtown EIR
Consultant's Report, 1: Text,
May 1983.

_____, Growth Management Alter-
natives for Downtown San Fran-
cisco: Downtown EIR
Consultant's Report, 2: Appen-
dices, May 1983.

_____, San Francisco Downtown
EIR Scope of Work ESA 1095, May
1981.

The Foundation for San Francisco's
Architectural Heritage, A
Preservation Strategy for Down-
town San Francisco, November
1982.

North of Market Planning Coalition,
A Comprehensive Plan for the
Neighborhood, November 1979.

San Francisco City Planning Commis-
sion, Final EIR: Tower No. 2 -
San Francisco Hilton Hotel, EE
79.257, October 6, 1980.

San Francisco Department of City
Planning, The Downtown Plan:
Proposal for Citizen Review,
August 1983.

San Francisco City Planning Commis-
sion, Draft EIR: Montgomery-
Washington Building, 81.104E,
November 13, 1981.

San Francisco Department of City
Planning, Environmental Setting
of Chinatown: History, People,
Land Use Regulations, Develop-
ment Issues, Issue Paper #1,
February 1984.

San Francisco Department of City
Planning, 505 Montgomery Street
Draft EIR, 82.463E, November
25, 1983.

San Francisco Department of City
Planning, Guiding Downtown
Development, May 1981.

San Francisco Department of City
Planning, Guiding Downtown
Development, July 1982.

San Francisco Department of City Planning, North of Market Rezoning Study, March 1983.

San Francisco Department of City Planning, Preliminary EIR: 49 Stevenson Street, 83.75E, June 24, 1983.

San Francisco Department of City Planning, Preliminary EIR: One Anthony Court, 81.297E, December 10, 1982.

San Francisco Department of City Planning, Van Ness Avenue Plan: Conservation and Development, Proposal for Citizen Review, May 1983.

Skidmore, Owens and Merrill and San Francisco Study Center for the San Francisco Department of City Planning, Mid-Market Street Conservation and Development Study, April 15, 1982.

Wilbur Smith and Associates, San Francisco Center City Pedestrian Circulation and Goods Movement Study, San Francisco Transportation Policy Group, September 1980.