

UNIVERSITY OF CALIFORNIA

Los Angeles

Towards a higher dimensional construction of
stable/unstable Lagrangian laminations

A dissertation thesis presented for the degree of
Doctor of Philosophy
in Mathematics

by

Sangjin Lee

2019

© Copyright by
Sangjin Lee
2019

ABSTRACT OF THE DISSERTATION

A higher dimensional construction of
stable/unstable Lagrangian laminations

by

Sangjin Lee

Doctor of Philosophy in Mathematics

University of California, Los Angeles, 2019

Professor Ko Honda, Chair

We generalize some properties of surface automorphisms of pseudo-Anosov type. First, we generalize the Penner construction of a pseudo-Anosov homeomorphism and show that a symplectic automorphism which is constructed by our generalized Penner construction has an invariant Lagrangian branched submanifold and an invariant Lagrangian lamination, which are higher-dimensional generalizations of a train track and a geodesic lamination in the surface case. Moreover, if a pair consisting of a symplectic automorphism ψ and a Lagrangian branched surface \mathcal{B}_ψ satisfies some assumptions, we prove that there is an invariant Lagrangian lamination \mathcal{L} which is a higher-dimensional generalization of a geodesic lamination.

The dissertation of Sangjin Lee is approved.

Ciprian Manolescu

Christian Fronsdal

Ko Honda, Committee Chair

University of California, Los Angeles

2019

CONTENTS

List of Figures	v
1. Introduction	1
2. Preliminaries	4
2.1. Plumbing spaces	4
2.2. Generalized Dehn twist	5
3. Lagrangian branched submanifolds	8
3.1. Lagrangian branched submanifolds.	9
3.2. Construction of fibered neighborhoods.	10
3.3. Associated branched manifolds and the notion of “carried by”.	15
3.4. The generalized Penner construction	20
3.5. Proof of Theorem 1.2	22
4. Construction of Lagrangian laminations	26
4.1. Singular and regular disks	26
4.2. Braids	29
4.3. Lagrangian lamination on a singular disk	46
4.4. Lagrangian lamination on a regular disk	50
4.5. A generalization	60
5. Application on the Lagrangian Floer homology	61
5.1. Setting	61
5.2. Proof of Theorem 1.5	63
5.3. Example 5.5	64
References	68

LIST OF FIGURES

1	Example of plumbing spaces.	6
2	Construction of fibered neighborhood.	12
3	Fibered neighborhood.	15
4	Abstract branched manifold.	16
5	Example of Lagrangian branched submanifold.	21
6	$\tau_k(N_p)$ and $\tau_k(D_p^-)$.	25
7	$\sigma_2^{-1}(\mathcal{B}_\psi) \cap \phi_{\beta_2}(W_y)$.	34
8	$\Phi_1(\sigma_2^{-1}(\mathcal{B}_\psi)) \cap \phi_{\beta_2}(W_y)$.	36
9	Example of a collection \mathcal{C} on $[r_0, 1] \times S^1$.	54
10	Creation of a collection \mathcal{C} .	56

ACKNOWLEDGMENTS

I would first like to thank my advisor, Ko Honda, for his guidance through each stage of the process. His patience and help in writing this dissertation thesis were invaluable. I would like to acknowledge Kwanjeong Educational Foundation for for helping and providing the funding for the work. I am grateful to my parents who have provided me through moral and emotional support in my life. I would like to thank Yeohoon Choi for her support and encouragement which were a huge part of completing this thesis.

Vita

Education and professional employment

2006–2012 B.S. Mathematics, Seoul National University

2013–2019 Teaching assistant, Mathematics Department, UCLA

Award

2013–2018 Oversea's scholarship (Kwanjeong Educational Foundation)

1. INTRODUCTION

By the Nielsen-Thurston classification of surface diffeomorphisms, an automorphism $\psi : S \xrightarrow{\sim} S$ of a compact oriented surface S is of one of three types: periodic, reducible or pseudo-Anosov [1], [10]. A generic element of the mapping class group of S is of pseudo-Anosov type.

Let us assume that ψ is of pseudo-Anosov type. For any closed curve $C \subset S$, it is known that there is a sequence $\{L_m\}_{m \in \mathbb{N}}$ of closed geodesics such that L_m is isotopic to $\psi^m(C)$ for all $m \in \mathbb{N}$, and $\{L_m\}_{m \in \mathbb{N}}$, as a sequence of closed subsets, converges to a closed subset \mathcal{L} . Moreover, \mathcal{L} is a geodesic lamination. The definitions of a lamination, a geodesic lamination and a Lagrangian lamination are the following:

Definition 1.1.

- (1) A *k-dimensional lamination* on an n -dimensional manifold M is a decomposition of a closed subset of M into k -dimensional submanifolds called *leaves* so that M is covered by charts of the form $I^k \times I^{n-k}$ where a leaf passing through a chart is a slice of the form $I^k \times \{pt\}$.
- (2) A 1-dimensional lamination \mathcal{L} on a Riemannian 2-manifold (S, g) is a *geodesic lamination* if every leaf of \mathcal{L} is geodesic.
- (3) A n -dimensional lamination \mathcal{L} on a symplectic manifold (M^{2n}, ω) is a *Lagrangian lamination* if every leaf of \mathcal{L} is a Lagrangian submanifold.

For more details, we refer the reader to [3, Chapter 15].

In [2], Dimitrov, Haiden, Katzarkov, and Kontsevich defined the notion of a *pseudo-Anosov functor* of a category. A pseudo-Anosov map ψ on a compact oriented surface S induces a functor, also called ψ , on the derived Fukaya category $D^\pi Fuk(S, \omega)$, where ω is an area form of S . In [2], the authors showed that ψ is a pseudo-Anosov functor.

In [2, Section 4], the authors listed a number of open questions. One of them is to find a symplectic automorphism ψ on a symplectic manifold M of dimension greater than 2 which has invariant transversal stable/unstable Lagrangian measured foliations. A slightly weaker version of the question is to define a symplectic automorphism ψ with invariant stable/unstable Lagrangian laminations.

The goal of the present paper is to prove Theorems 1.2–1.5, which answer the latter question.

Theorem 1.2. *Let M be a symplectic manifold and let $\psi : M \xrightarrow{\sim} M$ be a symplectic automorphism of generalized Penner type. Then, there exists a Lagrangian branched submanifold \mathcal{B}_ψ such that if L is a Lagrangian submanifold which is carried (resp. weakly carried) by \mathcal{B}_ψ , then $\psi^m(L)$ is carried (resp. weakly carried) by \mathcal{B}_ψ for all $m \in \mathbb{N}$.*

In Sections 2 and 3, we will explain the terminology that appears in the statement of Theorem 1.2, i.e., a symplectic automorphism of generalized Penner type, a Lagrangian branched submanifold, and the notion of “carried by”.

We would like to remark that Theorem 1.2 is for ψ of generalized Penner type. However, there would be a generalized version of Theorem 1.2, which we do not prove in the current paper.

Theorem 1.3. *Let M be a symplectic manifold and let $\psi : M \xrightarrow{\sim} M$ be a symplectic automorphism of generalized Penner type. Then, there is a Lagrangian lamination \mathcal{L} such that if L is a Lagrangian submanifold of M which is carried by \mathcal{B}_ψ , then there is a Lagrangian submanifold L_m for all $m \in \mathbb{N}$, which is Hamiltonian isotopic to $\psi^m(L)$ and converges to \mathcal{L} as closed sets as $m \rightarrow \infty$.*

We will also prove the following generalization of Theorem 1.3

Theorem 1.4. *Let $\psi : M \xrightarrow{\sim} M$ be a symplectic automorphism and let \mathcal{B}_ψ be a Lagrangian branched submanifold such that $\psi(\mathcal{B}_\psi)$ is carried by \mathcal{B}_ψ . Moreover, if the associated branched*

manifold \mathcal{B}_ψ admits a decomposition into singular and regular disks, then there is a Lagrangian lamination \mathcal{L} such that if L is a Lagrangian submanifold of M which is carried by \mathcal{B}_ψ , then there is a Lagrangian submanifold L_m for all $m \in \mathbb{N}$, which is Hamiltonian isotopic to $\psi^m(L)$ and converges to \mathcal{L} as closed sets as $m \rightarrow \infty$.

The associated branched manifold and singular/regular disks will be defined in Sections 3 and 4.

Theorem 1.5. *Let M be a plumbing space of Penner type and let $\eta : M \xrightarrow{\sim} M$ be the involution associated to M . Let assume that a transversal pair $L_1, L_2 \subset M$ of Lagrangian submanifolds satisfies the following:*

- (1) $\eta(L_i) = L_i$ for $i = 0, 1$.
- (2) Let $\tilde{L}_i = L_i \cap M_i$. Then, \tilde{L}_i is a Lagrangian submanifold of \tilde{M} such that \tilde{L}_0 and \tilde{L}_1 are not isotopic to each other.
- (3) $L_0 \cap L_1 = \tilde{L}_0 \cap \tilde{L}_1$.

Then,

$$\dim HF^0(L_1, L_2) + \dim HF^1(L_1, L_2) = i(\tilde{L}_1, \tilde{L}_2),$$

where $HF^k(L_1, L_2)$ denotes $\mathbb{Z}/2$ -graded Lagrangian Floer homology over the Novikov ring of characteristic 2 and $i(\tilde{L}_1, \tilde{L}_2)$ denotes the geometric intersection number of \tilde{L}_1 and \tilde{L}_2 in the fixed surface \tilde{M} .

In Section 5, we will explain the terminology that appears in the statement of Theorem 1.5, i.e., a plumbing space M of Penner type, the involution η associated to M , and the fixed surface \tilde{M} of M .

This paper consists of 5 sections. In Section 2, we review plumbing spaces and generalized Dehn twists. We will prove Theorem 1.2 in Section 3 and Theorems 1.3 and 1.4 in Section 4. In Section 5, we will prove Theorem 1.5.

2. PRELIMINARIES

In this section, we will review plumbings of cotangent bundles and generalized Dehn twists, partly to establish notation.

2.1. Plumbing spaces. Let α and β be oriented spheres S^n . We describe how to plumb $T^*\alpha$ and $T^*\beta$ at $p \in \alpha$ and $q \in \beta$. Let $U \subset \alpha$ and $V \subset \beta$ be small disk neighborhoods of p and q . Then, we identify T^*U and T^*V so that the base U (resp. V) of T^*U (resp. T^*V) is identified with a fiber of T^*V (resp. T^*U).

To do this rigorously, we fix coordinate charts $\psi_1 : U \rightarrow \mathbb{R}^n$ and $\psi_2 : V \rightarrow \mathbb{R}^n$. Then, we obtain a compositions of symplectomorphisms

$$T^*U \xrightarrow{(\psi_1^*)^{-1}} T^*\mathbb{R}^n \simeq \mathbb{R}^{2n} \xrightarrow{f} \mathbb{R}^{2n} \simeq T^*\mathbb{R}^n \xrightarrow{\psi_2^*} T^*V,$$

where $f(x_1, \dots, x_n, y_1, \dots, y_n) = (y_1, \dots, y_n, -x_1, \dots, -x_n)$.

A plumbing space $P(\alpha, \beta)$ of $T^*\alpha$ and $T^*\beta$ is defined by $T^*\alpha \sqcup T^*\beta / \sim$, where $x \sim (\psi_2^* \circ f \circ \psi_1^{*-1})(x)$ for all $x \in T^*U$. Since $\psi_2^* \circ f \circ \psi_1^{*-1}$ is a symplectomorphism, $P(\alpha, \beta)$ has a natural symplectic structure induced by the standard symplectic structures of cotangent bundles.

Since the plumbing procedure is a local procedure, we can plumb a finite collection of cotangent bundles of the same dimension at finitely many points. For convenience, we plumb cotangent bundles of oriented manifolds.

Note that we can replace f by

$$g(x_1, \dots, x_n, y_1, \dots, y_n) = (-y_1, y_2, \dots, y_n, x_1, -x_2, \dots, -x_n).$$

If we plumb $T^*\alpha$ and $T^*\beta$ at one point using g , this plumbing space is symplectomorphic to the previous plumbing space $P(\alpha, \beta)$, which is plumbed using f . However, if we plumb at more than one point, then by replacing f with g at a plumbing point, the plumbing space will change.

Definition 2.1. Let $\alpha_1, \dots, \alpha_m$ be oriented manifolds of dimension n .

- (1) A *plumbing data* is a collection of pairs of non-negative integers $(a_{i,j}, b_{i,j})$ for all $1 \leq i \leq j \leq m$ and collections of distinct points

$$\{p_k^{i,j} \in \alpha_i \mid 1 \leq i \leq j \leq m, 1 \leq k \leq a_{i,j} + b_{i,j}\} \text{ and}$$

$$\{q_k^{i,j} \in \alpha_j \mid 1 \leq i \leq j \leq m, 1 \leq k \leq a_{i,j} + b_{i,j}\}.$$

- (2) A *plumbing space* $P(\alpha_1, \dots, \alpha_m)$, with the given plumbing data, is given by

$$P(\alpha_1, \dots, \alpha_m) = T^*\alpha_1 \sqcup \dots \sqcup T^*\alpha_m / \sim,$$

where the equivalence relation \sim is defined as follows: First, choose small disk neighborhoods $U_k^{i,j} \subset \alpha_i$ of $p_k^{i,j}$ and $V_k^{i,j} \subset \alpha_j$ of $q_k^{i,j}$ and orientation-preserving coordinate charts $\psi_k^{i,j} : U_k^{i,j} \xrightarrow{\sim} \mathbb{R}^n$ and $\phi_k^{i,j} : V_k^{i,j} \xrightarrow{\sim} \mathbb{R}^n$. Then for all $x \in T^*U_k^{i,j}$,

$$x \sim (\phi_k^{i,j*} \circ f \circ (\psi_k^{i,j*})^{-1})(x) \text{ if } 1 \leq k \leq a_{i,j},$$

$$x \sim (\phi_k^{i,j*} \circ g \circ (\psi_k^{i,j*})^{-1})(x) \text{ if } a_{i,j} + 1 \leq k \leq a_{i,j} + b_{i,j}.$$

- (3) A *plumbing point* is an identified point $p_k^{i,j} \sim q_k^{i,j} \in P(\alpha_1, \dots, \alpha_m)$.

Figure 1 is examples of plumbing spaces.

If α_i is of dimension $n \geq 2$, then specific choices of plumbing points do not change the symplectic topology of $P(\alpha_1, \dots, \alpha_m)$.

2.2. Generalized Dehn twist. Let

$$T^*S^n = \{(u; v) \in \mathbb{R}^{n+1} \times \mathbb{R}^{n+1} \mid \|u\| = 1, \langle u, v \rangle = 0\},$$

$$S^n = \{(u; 0) \in T^*S^n\},$$

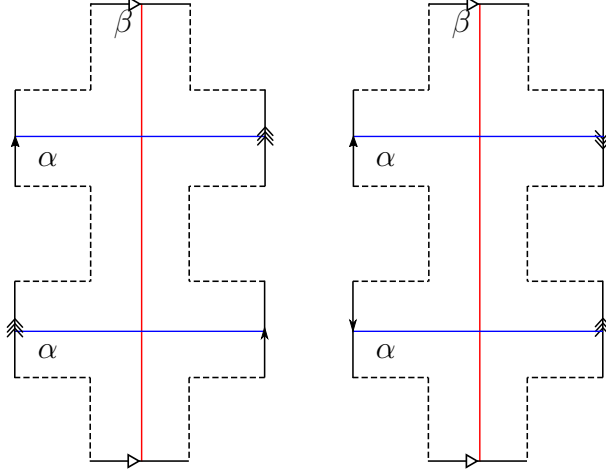

FIGURE 1. Example of plumbing spaces.

$P(\alpha \simeq S^1, \beta \simeq S^1)$ with plumbing data $(2, 0)$ (left) and $(1, 1)$ (right).

where $(u; v) \in \mathbb{R}^{n+1} \times \mathbb{R}^{n+1}$ and $\langle u, v \rangle$ is the standard inner product of u and v in \mathbb{R}^{n+1} . Moreover, let 0_k be the origin in \mathbb{R}^k .

We fix a Hamiltonian function $\mu(u; v) = \|v\|$ on $T^*S^n \setminus S^n$. Then, μ induces a circle action on $T^*S^n \setminus S^n$ given by

$$\sigma(e^{it})(u; v) = \left(\cos(t)u + \sin(t) \frac{v}{\|v\|}; \cos(t)v - \sin(t)\|v\|u \right).$$

Let $r : [0, \infty) \rightarrow \mathbb{R}$ be a smooth decreasing function such that $r(0) = \pi$ and $r(t) = 0$ for all $t \geq \epsilon$ for a small positive number ϵ . If ω_0 is the standard symplectic form of T^*S^n , we define a symplectic automorphism $\tau : (T^*S^n, \omega_0) \xrightarrow{\sim} (T^*S^n, \omega_0)$ as follows

$$(2.1) \quad \tau(u; v) = \begin{cases} \sigma(e^{ir(\mu(u;v))})(u; v) & \text{if } v \neq 0_{n+1}, \\ (-u; 0_{n+1}) & \text{if } v = 0_{n+1}. \end{cases}$$

Let (M^{2n}, ω) be a symplectic manifold and let $L \simeq S^n$ be a Lagrangian sphere in M . By the Lagrangian neighborhood theorem [12], there is a neighborhood $N(L) \supset L$ and a symplectomorphism $\phi : T^*S^n \xrightarrow{\sim} N(L)$. We define a generalized Dehn twist

τ_L along L as follows:

$$(2.2) \quad \tau_L(x) = \begin{cases} (\phi \circ \tau \circ \phi^{-1})(x) & \text{if } x \in N(L), \\ x & \text{if } x \notin N(L). \end{cases}$$

Note that the support of τ_L is contained in $N(L)$. From now on, a generalized Dehn twist will just be called a Dehn twist.

Remark 2.2. In this paper, we will use two specific Dehn twists $\tau, \tilde{\tau} : T^*S^n \xrightarrow{\sim} T^*S^n$ which are defined by Equation (2.1) and two functions $r, \tilde{r} : [0, \infty) \rightarrow \mathbb{R}$. The function r (resp. \tilde{r}) defining τ (resp. $\tilde{\tau}$) satisfies the above conditions in addition to $r(t) = \pi$ for all $t \leq \frac{\epsilon}{2}$ (resp. $\tilde{r}'(0) < 0$). Two Dehn twists τ and $\tilde{\tau}$ are equivalent in the sense that $\tau \circ \tilde{\tau}^{-1}$ is a Hamiltonian isotopy.

Dehn twists have been studied extensively by Seidel. For example, Seidel [9] proved the following theorem.

Theorem 2.3. *Let α be a Lagrangian sphere and β be a Lagrangian submanifold of a symplectic manifold M . If α and β intersect transversally at only one point, $\alpha \# \beta$ is Lagrangian isotopic to $\tau_\alpha(\beta)$ where $\alpha \# \beta$ is a Lagrangian surgery of α and β .*

We prove Theorem 2.3 in the special case that β is also a sphere and $M = P(\alpha, \beta)$, as an illustration of the “spinning” procedure. To define “spinning”, we use the following notation. Let $y \in S^{n-1} \subset \mathbb{R}^n$. Then,

$$\psi_y : T^*S^1 \simeq S^1 \times \mathbb{R} \rightarrow T^*S^n,$$

$$(\theta, t) \mapsto (\cos \theta(0_n, 1) + \sin \theta(y, 0); t \cos \theta(y, 0) - t \sin \theta(0_n, 1))$$

is a symplectic embedding. Let W_y be the embedded symplectic surface $\psi_y(T^*S^1)$.

Definition 2.4. Given a curve C in T^*S^1 , its *spun image* $S(C)$ is $\cup_{y \in S^{n-1}} \psi_y(C)$.

Proof of Theorem 2.3. We use $T^*\alpha$ and $T^*\beta$ to indicate neighborhoods of α and β inside $M = P(\alpha, \beta)$. Let p be the intersection point of α and β . Then, $T_p^*\alpha = \beta \cap T^*\alpha$. The closure of $T_p^*\alpha$ is denoted by D_p^- ; we use D to indicate that this is a disk and the subscript p means that p is the center of D_p^- . The meaning of the negative sign in D_p^- will be explained in the next section. Since τ_α is supported on $T^*\alpha$,

$$\tau_\alpha(\beta) = \tau_\alpha(\beta \cap T^*\alpha) \cup \tau_\alpha(\beta \setminus T^*\alpha) = \tau_\alpha(D_p^-) \cup (\beta \setminus T^*\alpha).$$

There exists $\phi : T^*S^n \xrightarrow{\sim} T^*\alpha$ such that $\tau_\alpha = \phi \circ \tau \circ \phi^{-1}$. Without loss of generality, $\phi(0_n, 1; 0_{n+1}) = p$ and

$$D_p^- = \phi(\{(0_n, 1; ty, 0) \mid t \in \mathbb{R}, y \in S^{n-1} \subset \mathbb{R}^n\}).$$

Then,

$$\begin{aligned} (\phi \circ \tau_\alpha \circ \phi^{-1})(D_p^-) &= (\phi \circ \tau)(\{(0_n, 1; ty, 0) \mid t \in \mathbb{R}, y \in S^{n-1} \subset \mathbb{R}^n\}) \\ &= \cup_{y \in S^{n-1}} \phi(\{\tau(0_n, 1; ty, 0) \mid t \in \mathbb{R}\}). \end{aligned}$$

Thus, $\tau_\alpha(D_p^+)$ is given by spinning with respect to p and ϕ . Similarly, we can construct a Lagrangian isotopy connecting $\tau_\alpha(\beta)$ and $\alpha \# \beta$ by spinning. This completes the proof. \square

3. LAGRANGIAN BRANCHED SUBMANIFOLDS

In Section 3.1, we will define Lagrangian branched submanifolds. In Section 3.2, we will introduce a construction of a fibered neighborhood of a Lagrangian branched submanifolds. In Section 3.3, we will defined the notion of “carried by” by using a fibered neighborhood. In Section 3.4, we will introduce the generalized Penner construction. Finally, we will give a proof of Theorem 1.2 in Section 3.5.

3.1. Lagrangian branched submanifolds. Thurston [11] used train tracks, which are 1-dimensional branched submanifolds of surfaces, and defined the notion of “carried by a train track”. In this subsection, we generalize train tracks.

The generalization of a train track is an n -dimensional branched submanifold of a $2n$ -dimensional manifold. We define the n -dimensional branched submanifolds with local models, as Floyd and Oertel defined a branched surface in a 3-dimensional manifold in [4], [6]. For our definition, we need a smooth function $s : \mathbb{R} \rightarrow \mathbb{R}$ such that $s(t) = 0$ if $t \leq 0$ and $s(t) > 0$ if $t > 0$.

Definition 3.1. Let M^{2n} be a smooth manifold.

- (1) A subset $\mathcal{B} \subset M$ is an n -dimensional branched submanifold if for every $p \in \mathcal{B}$, there exists a chart $\phi_p : U_p \xrightarrow{\sim} \mathbb{R}^{2n}$ about p such that $\phi_p(p) = 0$ and $\phi_p(\mathcal{B} \cap U_p)$ is a union of submanifolds L_0, L_1, \dots, L_k for some $k \in \{0, \dots, n\}$, where

$$L_i := \{(x_1, \dots, x_n, s(x_1), s(x_2), \dots, s(x_i), 0, \dots, 0) \in \mathbb{R}^{2n} \mid x_j \in \mathbb{R}\}.$$

- (2) A *sector* of \mathcal{B} is a connected component of the set of all points in \mathcal{B} that are locally modeled by L_0 , i.e., $k = 0$.
- (3) A *branch locus* $Locus(\mathcal{B})$ of \mathcal{B} is the complement of all the sectors.
- (4) Let (M^{2n}, ω) be a symplectic manifold. A subset $\mathcal{B} \subset M$ is a *Lagrangian branched submanifold* if for every $p \in \mathcal{B}$, there exists a Darboux chart $\phi_p : (U_p, \omega|_{U_p}) \xrightarrow{\sim} (\mathbb{R}^{2n}, \omega_0)$ about p , satisfying the conditions of an n -dimensional branched submanifold.

Remark 3.2.

- (1) At every point p of a branched submanifold \mathcal{B} , the tangent plane $T_p\mathcal{B}$ is well-defined. Moreover, if \mathcal{B} is Lagrangian, then $T_p\mathcal{B}$ is a Lagrangian subspace of T_pM .

- (2) A point on the branch locus is (a smooth version of) an arboreal singularity in the sense of Nadler [5].

Example 3.3.

- (1) Every train track of a surface equipped with an area form is a Lagrangian branched submanifold.
- (2) Let (M, ω) be a symplectic manifold and let L_1 and L_2 be two Lagrangian submanifold of M such that

$$L_1 \pitchfork L_2, L_1 \cap L_2 = \{p\}.$$

The Lagrangian surgery of L_1 and L_2 at p will be denoted by $L_1 \#_p L_2$. Then, $L_1 \#_p L_2 \cup L_1$ and $L_1 \#_p L_2 \cup L_2$ are examples of Lagrangian branched submanifold.

In Section 3.3, we will define the notion of “*carried by*” which appears in Theorems 1.2 - 1.4. In order to define the notion of carried by, we will construct a fibered neighborhood first in Section 3.2.

3.2. Construction of fibered neighborhoods. Let \mathcal{B} be a Lagrangian branched submanifold. A fibered neighborhood $N(\mathcal{B})$ of \mathcal{B} is, roughly speaking, a codimension zero compact submanifold with boundary and corners of M , which is foliated by Lagrangian closed disks which are called *fibers*.

Definition 3.4. A *fibered neighborhood* of \mathcal{B} is a union $\cup_{p \in \mathcal{B}} F_p$, where $\{F_p \mid p \in \mathcal{B}\}$ is a family of Lagrangian disks satisfying

- (1) for any $p \in \mathcal{B}$, $F_p \pitchfork \mathcal{B}$,
- (2) for any $p, q \in \mathcal{B}$, either $F_p = F_q$ or $F_p \cap F_q = \emptyset$,
- (3) there exists a closed neighborhood $U \subset \mathcal{B}$ of $Locus(\mathcal{B})$, such that $\{F_p \mid p \in U\}$ is a smooth family over each local sheet $L_i \cap U$,

- (4) for each sector S of \mathcal{B} , $\{F_p \mid p \in S \setminus U\}$ is a smooth family,
(5) if $p \in S \cap \partial U$ where S is a sector of \mathcal{B} , then, for any sequence $\{q_n \in S \setminus U\}_{n \in \mathbb{N}}$,

$$\lim_{n \rightarrow \infty} F_{q_n} \text{ is a Lagrangian disk such that } \lim_{n \rightarrow \infty} F_{q_n} \subset \overset{\circ}{F}_p = F_p \setminus \partial F_p.$$

We will now give a specific construction of a fibered neighborhood $N(\mathcal{B})$.

Remark 3.5. By the Lagrangian neighborhood theorem [12], for any Lagrangian submanifold L of M , there exists a small neighborhood $\mathcal{N}(L)$ of the zero section of T^*L such that a symplectic embedding $i_L : \mathcal{N}(L) \hookrightarrow M$ is defined on $\mathcal{N}(L)$. Without loss of generality, we assume that $\mathcal{N}(L)$ is a closed neighborhood. Then, $\mathcal{N}(L)$ is foliated by closed Lagrangian disks $\mathcal{N}(L) \cap T_p^*L$.

Fibration over $L(\ell)$. First, we will construct fibers near the branch locus. For each connected component ℓ of $Locus(\mathcal{B})$, we choose a small closed Lagrangian neighborhood $L(\ell)$ of ℓ . Then, by Remark 3.5, there exists a symplectic embedding

$$i_{L(\ell)} : \mathcal{N}(L(\ell)) \hookrightarrow M.$$

Let $U(L(\ell)) = i_{L(\ell)}(\mathcal{N}(L(\ell)))$.

By choosing a sufficiently small $L(\ell)$, without loss of generality, the following hold:

$$i_{L(\ell)}(\mathcal{N}(L(\ell)) \cap T_x^*L(\ell)) \cap \mathcal{B} \neq \emptyset \text{ for all } x \in L(\ell),$$

$$i_{L(\ell)}(\mathcal{N}(L(\ell)) \cap T_x^*L(\ell)) \pitchfork \mathcal{B} \text{ for all } x \in L(\ell),$$

$$U(\ell) \cap U(\ell') = \emptyset \text{ if } \ell \neq \ell'.$$

If $p \in \mathcal{B}$ is close to the branch locus, in other words, there is a connected component ℓ of $Locus(\mathcal{B})$ such that $p \in \mathcal{B} \cap U(\ell)$, then there exists $x \in L(\ell)$ such that $p \in i_{L(\ell)}(\mathcal{N}(L(\ell)) \cap T_x^*L(\ell))$. Let $F_p := i_{L(\ell)}(\mathcal{N}(L(\ell)) \cap T_x^*L(\ell))$. Then, F_p is a closed Lagrangian disk containing p .

If $p \in \ell$, then,

$$(3.3) \quad F_p \pitchfork \mathcal{B} \text{ and } \partial F_p \cap \mathcal{B} = \emptyset.$$

Moreover, by choosing a sufficiently small $L(\ell)$, for every $p \in \mathcal{B} \cap U(\ell)$, Equation (3.3) holds.

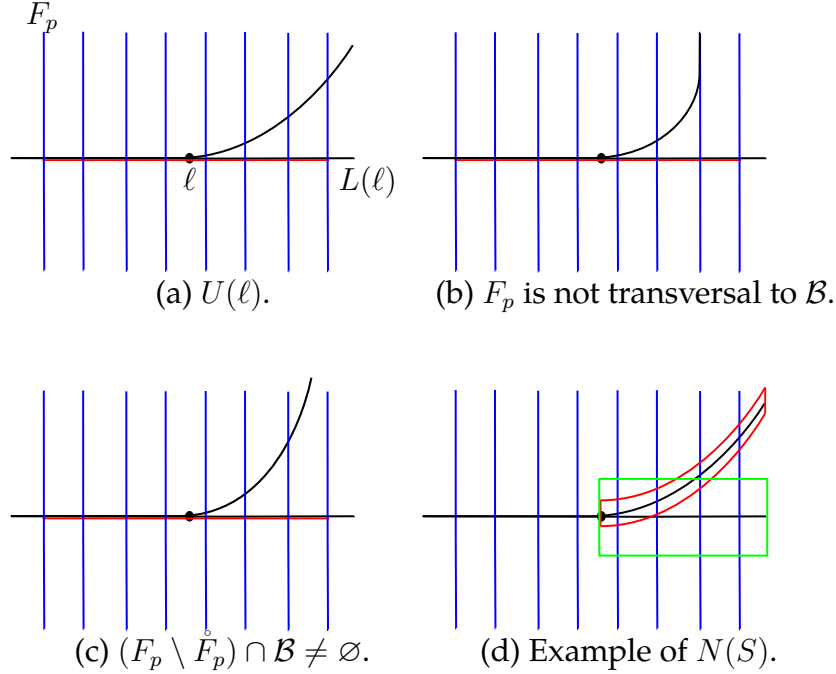

FIGURE 2. Construction of fibered neighborhood.

Black curves are part of a Lagrangian branched submanifold and the black marked points denote a connected component ℓ of $Locus(\mathcal{B})$. in (a), $L(\ell)$ is in red, and the fibers F_p , for $p \in \mathcal{B} \cap U(\ell)$, are in blue; (b) and (c) are not allowed by Equation (3.3); and in (d), the red and green boxes are examples of $N(S)$.

After possibly renaming $U(\ell)$, from now we assume that

$$U(\ell) = \cup_{p \in L(\ell)} F_p.$$

If $p \in \mathcal{B} \cap U(\ell)$, then there is a unique $q \in L(\ell)$ such that $p \in F_q$. We define $F_p := F_q$. Thus, for $p \in \mathcal{B}$ which is close to $Locus(\mathcal{B})$, i.e., $p \in U(\ell)$ for some connected component ℓ of $Locus(\mathcal{B})$, we can define a fiber F_p at p .

Fibration over $S \setminus \cup_\ell U(\ell)$. If $p \in \mathcal{B} \setminus \cup_\ell U(\ell)$, then there is a sector S of \mathcal{B} containing p . Since S is Lagrangian, there is an embedding $i_S : \mathcal{N}(S) \hookrightarrow M$. We can assume that $\mathcal{N}(S)$ is small enough, so that

$$F_q \cap i_S(\mathcal{N}(S)) \subset \mathring{F}_q = F_q \setminus \partial F_q \text{ for any } q \in \mathcal{B} \cap U(\ell),$$

$$(i_S(\mathcal{N}(S)) \setminus \cup U(\ell)) \cap (i_{S'}(\mathcal{N}(S')) \setminus \cup U(\ell)) = \emptyset.$$

Figure 2 (d) represents examples of $\mathcal{N}(S)$. We define B_p for all $p \in S$ by setting

$$B_p := i_S(\mathcal{N}(S) \cap T_p^* S).$$

For any sector S , let $S^\circ := S - \cup_\ell \text{Int } U(\ell)$. Then, S° is a Lagrangian submanifold with boundary. The boundary of S° is a union of $S(\ell) := S \cap \partial(U(\ell))$. We fix a tubular neighborhood of $S(\ell)$, which is contained in S° , and identify the tubular neighborhood with $S(\ell) \times [0, 1]$. For convenience, we will pretend that $S(\ell) \times [0, 1] \subset S$ and $S(\ell) \times \{0\} = S(\ell)$.

If $p \in S^\circ$ does not lie in any $S(\ell) \times (0, 1)$, then we set $F_p := B_p$.

Interpolation on $S(\ell) \times [0, 1]$. If there is a connected component ℓ of $\text{Locus}(\mathcal{B})$ such that $p = (p_0, t_0) \in S(\ell) \times (0, 1)$, we will construct $F_{p=(p_0, t_0)}$ from $F_{(p_0, 0)}$ and $F_{(p_0, 1)}$. To do this, we need the following facts:

First, by the definition of $F_{(p_0, 0)}$, $F_{(p_0, 0)} \cap i_S(\mathcal{N}(S))$ is a Lagrangian disk which contains $(p_0, 0)$, and is transversal to \mathcal{B} at $(p_0, 0)$. Also, $B_{(p_0, 0)}$ is also a Lagrangian disk which contains $(p_0, 0)$, and is transversal to \mathcal{B} .

By the Lagrangian neighborhood theorem [12], we can see $F_{(p_0, 0)} \cap i_S(\mathcal{N}(S))$ as a graph of a closed section in $T^*B_{(p_0, 0)}$, i.e.,

$$F_{(p_0, 0)} \cap i_S(\mathcal{N}(S)) = i_{B_{(p_0, 0)}}(\text{the graph of a closed section in } T^*B_{(p_0, 0)}).$$

Every closed section of $T^*B_{(p_0,0)}$ is an exact section because $B_{(p_0,0)}$ is a disk. Thus, there is a function $f_{(p_0,0)} : B_{(p_0,0)} \rightarrow \mathbb{R}$ such that

$$F_{(p_0,0)} \cap i_S(\mathcal{N}(S)) = i_{B_{(p_0,0)}}(\text{the graph of } df_{(p_0,0)}).$$

Second, we will fix a Riemannian metric g compatible with ω for convenience. By restricting g to S , S is equipped with a Riemannian metric $g|_S$. Thus, for any $t_0 \in [0, 1]$, there is a parallel transport induced by $g|_S$, between $T_{(p_0,t_0)}S$ and $T_{(p_0,0)}S$ along $\gamma_{p_0}(t) = (p_0, t) \in S$. Also, g induces a bijection between $T_{(p_0,0)}S$ (resp. $T_{(p_0,t_0)}S$) and $T_{(p_0,0)}^*S$ (resp. $T_{(p_0,t_0)}^*S$). Thus, there is a bijective map between $B_{(p_0,t_0)}$ and $B_{(p_0,0)}$.

From those two facts, we define a function $f_{(p_0,t)} : B_{(p_0,t)} \rightarrow \mathbb{R}$ as follows:

$$f_{(p_0,t)} : B_{(p_0,t)} \xrightarrow{\sim} B_{(p_0,0)} \xrightarrow{(1-t)f_{(p_0,0)}} \mathbb{R}.$$

The first arrow comes from the parallel transport induced by g .

There is a map,

$$h : \cup_{(p_0,t) \in S(\ell) \times [0,1]} B_{(p_0,t)} \rightarrow M,$$

$$x \in B_{(p_0,t)} \mapsto i_{B_{(p_0,t)}}(df_{B_{(p_0,t)}}(x)).$$

It is easy to check that $h(p_0, t) = (p_0, t)$. Moreover, h is the associated (time 1) flow of the Hamiltonian vector field of

$$f_{(p_0,t)} : \cup_{(p_0,t) \in S(\ell) \times [0,1]} B_{(p_0,t)} \rightarrow \mathbb{R}.$$

Finally, we construct $F_{(p_0,t_0)}$ by setting

$$F_{(p_0,t_0)} := h(B_{(p_0,t_0)}).$$

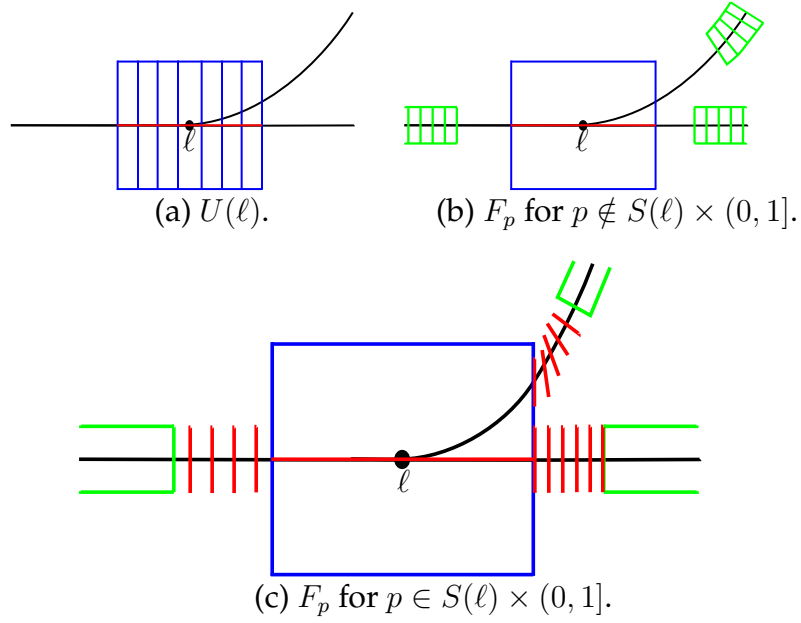

FIGURE 3. Fibered neighborhood.

Black curves are part of a Lagrangian branched submanifold and marked points denote ℓ ; in (a), $U(\ell)$ is shaded blue, the vertical line segments are fibers; (b) fiber F_p for $p \notin S(\ell) \times (0, 1]$ is in green; and in (c), fiber F_p for $p \in S(\ell) \times (0, 1]$ is in red.

A fibered neighborhood $N(\mathcal{B})$ is given by the union of fibers, i.e., $N(\mathcal{B}) = \cup_{p \in \mathcal{B}} F_p$. Note that the construction of $N(\mathcal{B})$ is not unique because the construction depends on some choices, including the choices of $L(\ell)$ and a Riemannian metric g .

3.3. Associated branched manifolds and the notion of “carried by”. We constructed a fibered neighborhood $N(\mathcal{B})$. From now on, we will define a projection map defined on $N(\mathcal{B})$, in order to define the notion of “carried by”.

First, we define *the associated branched manifold \mathcal{B}^* of \mathcal{B}* .

Definition 3.6. Let \mathcal{B} be a Lagrangian branched submanifold of M and let $N(\mathcal{B})$ be a fibered neighborhood of \mathcal{B} . Then, the *associated branched submanifold \mathcal{B}^** is defined by setting

$$\mathcal{B}^* := N(\mathcal{B}) / \sim, \quad x \sim y \text{ if } \exists F_p \text{ such that } x, y \in F_p.$$

Let $\pi : N(\mathcal{B}) \rightarrow \mathcal{B}^*$ denote the quotient map.

Before defining the notion of “carried by”, we note that \mathcal{B}^* is not contained in M . Moreover, since \mathcal{B}^* is a branched manifold, we can define the branch locus and sectors of \mathcal{B}^* as follows:

Definition 3.7.

(1) A sector of \mathcal{B}^* is a connected component of

$$\{p \in \mathcal{B}^* \mid p \text{ has a neighborhood which is homeomorphic to } \mathbb{R}^n\}.$$

(2) A branch locus of \mathcal{B}^* is the complement of all the sectors.

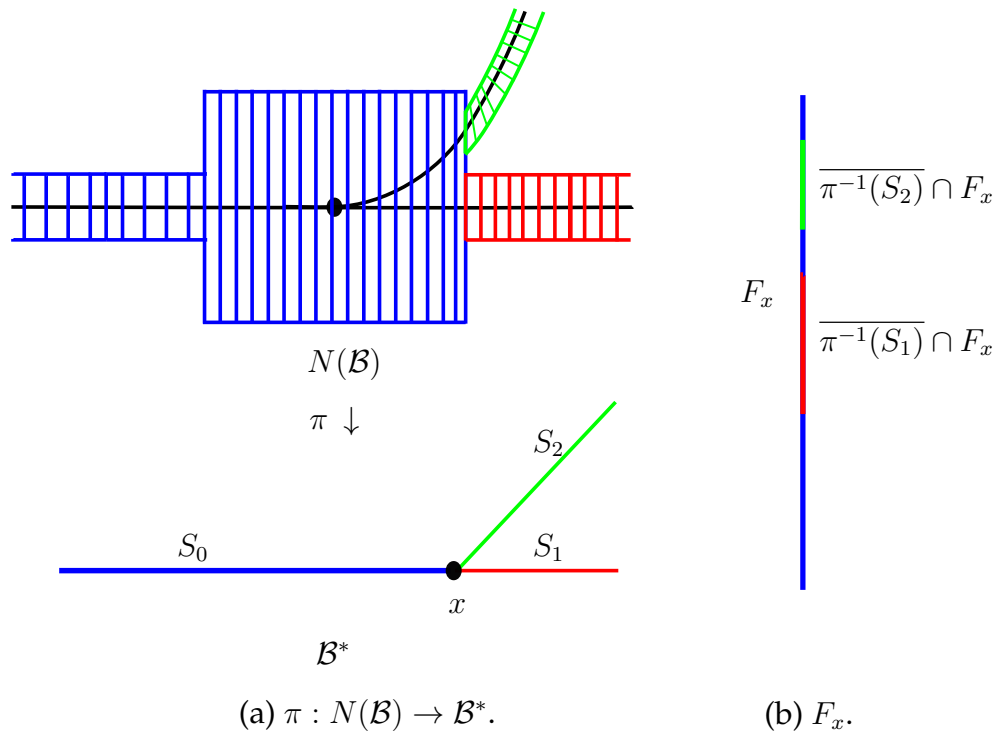

FIGURE 4. Abstract branched manifold.

(a) represents $\pi : N(\mathcal{B}) \rightarrow \mathcal{B}^*$. In $N(\mathcal{B})$, the blue, red, and green represent $\pi^{-1}(S_0)$, $\pi^{-1}(S_1)$, and $\pi^{-1}(S_2)$, where S_i is the corresponding sector of \mathcal{B}^* ; (b) represents F_x where x is in the branch locus of \mathcal{B}^* in (a).

Remark 3.8.

- (1) The construction of $N(\mathcal{B})$ depends on the choices of a Riemannian metric, a closed neighborhood of $Locus(\mathcal{B})$, and so on. Thus, fibered neighborhoods $N(\mathcal{B})$ of \mathcal{B} are not unique. However, \mathcal{B}^* is unique as a branched manifold since \mathcal{B} and \mathcal{B}^* are equivalent as branched manifolds.

In the rest of this paper, when it comes to a Lagrangian branched submanifold \mathcal{B} , we will consider a triple $(\mathcal{B}, N(\mathcal{B}), \mathcal{B}^*)$ with an arbitrary choice of $N(\mathcal{B})$. Moreover, for any triple $(\mathcal{B}, N(\mathcal{B}), \mathcal{B}^*)$, the projection map is denoted by π for convenience.

- (2) A fibered neighborhood $N(\mathcal{B})$ is a union of fibers, i.e., $N(\mathcal{B}) = \cup_{p \in \mathcal{B}} F_p$. In the equation, \mathcal{B} is an index set. However, there is a possibility of having two distinct points $p, q \in \mathcal{B}$ such that $F_p = F_q$. From now on, we will use \mathcal{B}^* as an index set. In other words, we replace F_p by $\pi^{-1}(\pi(p))$. By abuse of notation, F_x denotes $\pi^{-1}(x)$ for all $x \in \mathcal{B}^*$.
- (3) Let x be a branch point of \mathcal{B}^* . Then, there are sectors S_0, S_1, \dots, S_l of \mathcal{B}^* for some l such that

$$x \in \bar{S}_i \text{ for every } i = 0, 1, \dots, l$$

$$F_x \cap \overline{\pi^{-1}(S_0)} = F_x \text{ and } F_x \cap \overline{\pi^{-1}(S_i)} \subset \overset{\circ}{F}_x = F_x \setminus \partial F_x \text{ for every } i = 1, 2, \dots, l.$$

Figure 4 represents this.

From now on, we define the notion of “carried by”. If a Lagrangian submanifold L (resp. a Lagrangian branched submanifold \mathcal{L}) is contained in $N(\mathcal{B})$, there is a restriction of π to L (resp. \mathcal{L}). For convenience, we will simply use π instead of $\pi|_L : L \rightarrow \mathcal{B}^*$.

Definition 3.9. Let L be a Lagrangian submanifold (resp. \mathcal{L} be a Lagrangian branched submanifold) of $N(\mathcal{B})$.

- (1) $x \in L$ (resp. \mathcal{L}) is a *regular point* of π if $L \pitchfork F_{\pi(x)}$ (resp. $\mathcal{L} \pitchfork F_{\pi(x)}$) at x .

- (2) $x \in L$ (resp. \mathcal{L}) is a *singular point* of π if x is not regular point of $\pi : L' \rightarrow \mathcal{B}^*$. Moreover, values of π at singular points are called *singular values* of π . $y \in \mathcal{B}^*$ is a *singular value* of π if there is a singular point x of π such that $\pi(x) = y$.
- (3) L is *minimally singular with respect to \mathcal{B}* if $\pi : L \rightarrow \mathcal{B}^*$ has no singular value on the branch locus of \mathcal{B}^* and $|F_x \cap L| = |F_y \cap L|$, for any non-singular value x and y which lie in the same sector of \mathcal{B}^* , where $|\cdot|$ means the cardinality of a set.

Definition 3.10.

- (1) A Lagrangian submanifold L (resp. a Lagrangian branched submanifold \mathcal{L}) is *strongly carried by* a Lagrangian branched submanifold \mathcal{B} if L (resp. \mathcal{L}) is Hamiltonian isotopic to a Lagrangian submanifold L' (resp. a Lagrangian branched submanifold \mathcal{L}') such that L' (resp. \mathcal{L}') $\subset N(\mathcal{B})$ and $\pi : L' \rightarrow \mathcal{B}^*$ has no singular value.
- (2) A Lagrangian submanifold L (resp. a Lagrangian branched submanifold \mathcal{L}) is *weakly carried by* a Lagrangian branched submanifold \mathcal{B} if L (resp. \mathcal{L}) is Hamiltonian isotopic to a Lagrangian submanifold L' (resp. a Lagrangian branched submanifold \mathcal{L}') such that L' (resp. \mathcal{L}') $\subset N(\mathcal{B})$, L' is minimally singular, and $\pi : L' \rightarrow \mathcal{B}^*$ has countably many singular values.
- (3) Two Lagrangian submanifolds L and L' that are weakly carried by \mathcal{B} are *weakly fiber isotopic* if there exists an isotopy for L and L' through Lagrangians that are weakly carried by \mathcal{B} .

In the rest of this paper, if L is weakly carried by \mathcal{B} , then we will assume that $L \subset N(\mathcal{B})$ and L is minimally singular with respect to \mathcal{B} .

Note that the notion of “carried by” used by Thurston in [10] is our notion of “strongly carried by”. Thurston showed that for a pseudo-Anosov surface automorphism $\psi : S \xrightarrow{\sim} S$, there is a 1-dimensional branched submanifold τ which is called a train track such that $\psi(\tau)$ is strongly carried by τ .

Our higher-dimensional generalization is slightly weaker, i.e., for some symplectic automorphism $\psi : (M, \omega) \xrightarrow{\sim} (M, \omega)$, we construct a Lagrangian branched submanifold \mathcal{B}_ψ such that $\psi(\mathcal{B}_\psi)$ is weakly carried by \mathcal{B}_ψ . In other words, we allow non-transversality at countably many point $p \in \mathcal{B}_\psi$. However, we allow only one type of non-transversality. In the rest of the present subsection, we will describe the unique type of non-transversality.

Definition 3.11. Let L be weakly carried by \mathcal{B} . A *singular component* V of $\pi : L \rightarrow \mathcal{B}$ is a connected component of the set of all singular points of π .

Example 3.12. Let M_* be a symplectic manifold $T^*\mathbb{R}^n \simeq \mathbb{R}^{2n}$ equipped with the canonical symplectic form. The zero section $\mathcal{B}_* := \mathbb{R}^n \times 0 \subset \mathbb{R}^{2n}$ is a Lagrangian branched submanifold. We assume that the fibered neighborhood $N(\mathcal{B}_*)$ is M_* , by setting $F_p := T_p^*\mathbb{R}^n$ for all $p \in \mathbb{R}^n = \mathcal{B}_*$. Then, a Lagrangian submanifold

$$L_* := \{(tx, x) \in \mathbb{R}^n \times \mathbb{R}^n \mid t \in \mathbb{R}, x \in S^{n-1} \subset \mathbb{R}^n\}$$

is weakly carried by \mathcal{B}_* and π_* has only one singular component

$$V_* := \{(0, x) \mid x \in S^{n-1}\}.$$

Definition 3.13. A singular component V of $\pi : L \rightarrow \mathcal{B}$ is of *real blow-up type* if there exists an open neighborhood U of V and a symplectomorphism $\phi : U \xrightarrow{\sim} M_*$ such that $\phi(U \cap \mathcal{B}) = \mathcal{B}_*$, $\phi(V) = V_*$, and $\phi^{-1} \circ \pi_* \circ \phi = \pi$, where M_*, \mathcal{B}_*, V_* , and π_* are defined in Example 3.12.

Definition 3.14. A Lagrangian submanifold L (resp. a Lagrangian branched submanifold \mathcal{L}) is *carried by* a Lagrangian branched submanifold \mathcal{B} if L (resp. \mathcal{L}) is weakly carried by \mathcal{B} and every singular component of π (resp. π) is a singular component of real blow-up type.

3.4. The generalized Penner construction. In this subsection, we give a higher-dimensional generalization of Penner construction [7] of pseudo-Anosov surface automorphisms. The generalization replaces Dehn twists by generalized Dehn twists along Lagrangian spheres.

Generalized Penner construction : Let M be a symplectic manifold. A symplectic automorphism $\psi : M \xrightarrow{\sim} M$ is of *generalized Penner type* if there are two collections $A = \{\alpha_1, \dots, \alpha_m\}$ and $B = \{\beta_1, \dots, \beta_l\}$ of Lagrangian spheres such that

$$\begin{aligned} \alpha_i \cap \alpha_j &= \emptyset, \beta_i \cap \beta_j = \emptyset, \text{ for all } i \neq j, \\ \alpha_i \pitchfork \beta_j &\text{ for all } i, j, \end{aligned}$$

so that ψ is a product of positive powers of Dehn twists τ_i along α_i and negative powers of Dehn twists σ_j along β_j , subject to the condition that every sphere appear in the product.

A Lagrangian sphere α_i (resp. β_j) is called a *positive* (resp. *negative*) sphere since only positive powers of τ_i (resp. negative powers of σ_j) appear in ψ .

Remark 3.15.

- (1) In Theorems 1.2 and 1.3, we can assume that the symplectic manifold M is a plumbing space. Every τ_i (resp. σ_j) is supported on a neighborhood of α_i (resp. β_j), which is denoted by $T^*\alpha_i$ (resp. $T^*\beta_j$). Thus, ψ is supported on the union of $T^*\alpha_i$ and $T^*\beta_j$. By the transversality condition $\alpha_i \pitchfork \beta_j$, we can identify the union with a plumbing space $P = P(\alpha_1, \dots, \alpha_m, \beta_1, \dots, \beta_l)$. Thus, it

is suffices to prove Theorems 1.2 and 1.3 on the plumbing space P , which we take to be connected.

- (2) In [7], the Penner construction required that A and B fill the surface S , i.e., the complement of $A \cup B$ is a union of disks and annuli, one of whose boundary components is a component of ∂S . In the current paper, we do not require the analogue of the filling condition since we only construct an invariant Lagrangian branched submanifold and an invariant Lagrangian lamination, not an invariant singular foliation on all of M .

In the rest of this subsection, we define a set of Lagrangian branched submanifolds in a plumbing space $P(\alpha_1, \dots, \alpha_m, \beta_1, \dots, \beta_l)$. We start from the simplest plumbing space, having one positive and one negative sphere intersecting at only one point.

Example 3.16. Let α and β be n -dimensional spheres and let M be a plumbing $P(\alpha, \beta)$ which is plumbed at only one point p . Let $\alpha \#_p \beta$ be the Lagrangian surgery of α and β at p such that $\alpha \#_p \beta \simeq \tau_\alpha(\beta) \simeq \sigma_\beta^{-1}(\alpha)$. See Figure 5, which represents the case $n = 1$. The cross-shape is the plumbing space $P(\alpha, \beta)$, where α is the horizontal line and β is the vertical line.

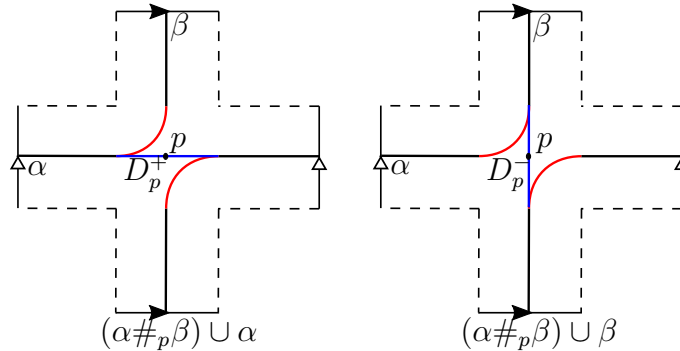

FIGURE 5. Example of Lagrangian branched submanifold.

The blue curves represent D_p^+ in the left hand picture and D_p^- in the right hand picture, the red curves represent N_p in both.

The *neck* N_p at p connecting α and β is the closure of $(\alpha \#_p \beta) - (\alpha \cup \beta)$. In Figure 5, N_p is drawn in red. The *positive disk* D_p^+ at p is the closure of $\alpha - (\alpha \#_p \beta)$ and the *negative disk* D_p^- at p is the closure of $\beta - (\alpha \#_p \beta)$. The disks D_p^\pm are drawn in blue in Figure 5. Then, by attaching D_p^+ or D_p^- to $\alpha \#_p \beta$, we obtain Lagrangian branched submanifolds $(\alpha \#_p \beta) \cup \alpha$ and $(\alpha \#_p \beta) \cup \beta$.

On a general plumbing space $M = P(\alpha_1, \dots, \alpha_m, \beta_1, \dots, \beta_l)$ with positive spheres α_i and negative spheres β_j , we similarly construct Lagrangian branched submanifolds. More precisely, given a plumbing point p , N_p, D_p^+, D_p^- are the closures of $(\alpha_i \#_p \beta_j) - (\alpha_i \cup \beta_j), \alpha_i - (\alpha_i \#_p \beta_j), \beta_j - (\alpha_i \#_p \beta_j)$ respectively. Let D_p be either D_p^+ or D_p^- . Then, we construct a Lagrangian branched submanifold \mathcal{B} by setting

$$(3.4) \quad \mathcal{B} := \cup_i (\alpha_i - \cup_{p \in \alpha_i} D_p^+) \bigcup \cup_j (\beta_j - \cup_{p \in \beta_j} D_p^-) \bigcup \cup_p N_p \bigcup \cup_p D_p.$$

There are 2^N possible choices of \mathcal{B} , where N is the number of plumbing points. Let \mathbb{B} be the set of all 2^N Lagrangian branched submanifolds constructed above.

3.5. Proof of Theorem 1.2. In this subsection, let $M = P(\alpha_1, \dots, \alpha_m, \beta_1, \dots, \beta_l)$, let τ_i (resp. σ_j) be a Dehn twist along α_i (resp. β_j), and let ψ be of generalized Penner type.

In the rest of the paper, we assume that every Dehn twist τ_i and σ_j satisfies the following:

- (1) τ_i (resp. σ_j) is supported on a small neighborhood $T^* \alpha_i$ (resp. $T^* \beta_j$) of α_i (resp. β_j).
- (2) τ_i (resp. σ_j) agrees with the antipodal map on α_i (resp. β_j).

We define the following:

$$(3.5) \quad \begin{aligned} \bar{D}_p^+ &:= \tau_i(D_p^+), \quad \bar{D}_p^- := \sigma_j^{-1}(D_p^-) \quad \text{if } p \in \alpha_i \cap \beta_j, \\ \alpha'_i &:= \alpha_i - \cup_{p \in \alpha_i} (D_p^+ \cup \bar{D}_p^+), \quad \beta'_j := \beta_j - \cup_{p \in \beta_j} (D_p^- \cup \bar{D}_p^-). \end{aligned}$$

In words, \bar{D}_p^+ (resp. \bar{D}_p^-) is a neighborhood of an antipodal point of p in α_i (resp. β_j). We are assuming that D_p^\pm and \bar{D}_p^\pm are sufficiently small so that they are disjoint to each other.

Recall that \mathbb{B} is the set of Lagrangian branched submanifolds defined in Section 3.2.

Lemma 3.17. *For all k , there exists a function $F_{\tau_k} : \mathbb{B} \rightarrow \mathbb{B}$ such that $\tau_k(\mathcal{B})$ is carried by $F_{\tau_k}(\mathcal{B})$ for all $\mathcal{B} \in \mathbb{B}$. Similarly, there is a function $F_{\sigma_j^{-1}} : \mathbb{B} \rightarrow \mathbb{B}$ for all j such that $\sigma_j^{-1}(\mathcal{B})$ is carried by $F_{\sigma_j^{-1}}(\mathcal{B})$.*

Proof. In this proof, τ_k is given by Equation (2.2) and $\tilde{\tau} : T^*S^n \xrightarrow{\sim} T^*S^n$ defined in Section 2.2, i.e., $\tau_k = \phi \circ \tilde{\tau} \circ \phi^{-1}$ in a neighborhood of α_k , where ϕ is an identification of T^*S^n and a neighborhood of α_k .

Given $\mathcal{B} \in \mathbb{B}$, \mathcal{B} admits the following decomposition:

$$(3.6) \quad \mathcal{B} = \cup_i \alpha'_i \cup \cup_j \beta'_j \cup \cup_p N_p \cup \cup_p \bar{D}_p^+ \cup \cup_p \bar{D}_p^- \cup \cup_p D_p,$$

where D_p is either D_p^+ or D_p^- . This follows from Equations (3.4) and (3.5).

We prove the first statement for τ_k ; the proof for σ_j^{-1} is analogous. Our strategy is to apply τ_k to $\alpha'_i, \beta'_j, N_p, \bar{D}_p^\pm$, and D_p^\pm . We claim the following:

- (i) $\tau_k(\alpha'_i) = \alpha'_i, \tau_k(\beta'_j) = \beta'_j$ and they are strongly carried by α'_i, β'_j .
- (ii) If $p \notin \alpha_k$, then $\tau_k(N_p) = N_p, \tau_k(D_p^\pm) = D_p^\pm, \tau_k(\bar{D}_p^\pm) = \bar{D}_p^\pm$ and they are strongly carried by $N_p, D_p^\pm, \bar{D}_p^\pm$.
- (iii) If $p \in \alpha_k$, then $\tau_k(D_p^+) = \bar{D}_p^+, \tau_k(\bar{D}_p^+) = D_p^+, \tau_k(\bar{D}_p^-) = \bar{D}_p^-$ and they are strongly carried by $\bar{D}_p^+, D_p^+, \bar{D}_p^-$.
- (iv) If $p \in \alpha_k$, then $\tau_k(D_p^-)$ and $\tau_k(N_p)$ are obtained by spinning with respect to p . Moreover, $\tau_k(D_p^-)$ is strongly carried by $N_p \cup (\alpha_k - D_p^+)$ and $\tau_k(N_p)$ is carried by $N_p \cup (\alpha_k - D_p^+)$.

By Equation (3.6) and (i)–(iv), $\tau_k(\mathcal{B})$ is carried by \mathcal{B}' such that

$$(3.7) \quad \mathcal{B}' = \cup_i \alpha'_i \cup \cup_j \beta'_j \cup \cup_p N_p \cup \cup_p \bar{D}_p^+ \cup \cup_p \bar{D}_p^- \cup \cup_p \tilde{D}_p,$$

where \tilde{D}_p is D_p if $p \notin \alpha_k$ and D_p^+ if $p \in \alpha_k$. Then, $F_{\tau_k} : \mathbb{B} \rightarrow \mathbb{B}$ is defined by $F_{\tau_k}(\mathcal{B}) = \mathcal{B}'$.

(i) Since τ_k agrees with the antipodal map on α_k , $\tau_k(\alpha'_k) = \alpha'_k$ and $\tau_k(\alpha'_k)$ is strongly carried by α'_k . Moreover, since τ_k is supported on $T^*\alpha_k$, α'_i does not intersect the support of τ_k for all $i \neq k$. Thus, $\tau_k(\alpha'_i)$ agrees with α'_i and $\tau_k(\alpha'_i)$ is strongly carried by itself. The same proof applies to $\tau_k(\beta'_j)$.

(ii) and (iii) are proved in the same way.

(iv) We compute $\tau_k(D_p^-)$ and $\tau_k(N_p)$ by spinning with respect to p and ϕ . We assume $\phi((1, 0_n; 0_{n+1})) = p$ without loss of generality. Using the notation from Section 2, D_p^- and N_p are contained in $\cup_{y \in S^{n-1}} \phi(W_y)$. Thus,

$$(3.8) \quad \begin{aligned} \tau_k(D_p^-) &= \cup_{y \in S^{n-1}} (\phi \circ \tilde{\tau} \circ \phi^{-1})(D_p^- \cap \phi(W_y)) \\ &= \cup_{y \in S^{n-1}} (\phi(\tilde{\tau}|_{W_y}(\phi^{-1}(D_p^-) \cap W_y))) \\ &= \cup_{y \in S^{n-1}} \tau_k(D_p^-) \cap \phi(W_y), \end{aligned}$$

$$(3.9) \quad \begin{aligned} \tau_k(N_p) &= \cup_{y \in S^{n-1}} (\phi \circ \tilde{\tau} \circ \phi^{-1})(N_p \cap \phi(W_y)) \\ &= \cup_{y \in S^{n-1}} \phi(\tilde{\tau}|_{W_y}(\phi^{-1}(N_p) \cap W_y)) \\ &= \cup_{y \in S^{n-1}} \tau_k(N_p) \cap \phi(W_y). \end{aligned}$$

The restriction $\tilde{\tau}|_{W_y}$ is a Dehn twist on $W_y \simeq T^*S^1$ along the zero section. Thus, we obtain Figure 6, which represents intersections $\phi(W_y) \cap D_p^-$, $\phi(W_y) \cap N_p$, $\phi(W_y) \cap \tau_k(D_p^-)$, and $\phi(W_y) \cap \tau_k(N_p)$. Equation (3.9) and Figure 6 imply that $\tau_k(N_p)$ is carried by $N_p \cup (\alpha_k - D_p^+)$ and $\tau_k(D_p^-)$ is strongly carried by $N_p \cup (\alpha_k - D_p^+)$.

Then, (i)–(iv) and Equation (3.6) prove that $\tau_k(\mathcal{B})$ is carried by $F_{\tau_k}(\mathcal{B})$. \square

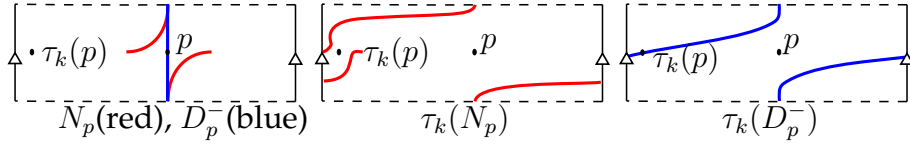

FIGURE 6. $\tau_k(N_p)$ and $\tau_k(D_p^-)$.

In the left picture, the blue curve represents D_p^- and the red curve represents N_p ; in the middle picture, the red curve represents $\tau_k(N_p)$; and in the right picture, the blue curve represents $\tau_k(D_p^-)$.

Lemma 3.18. *If L is a Lagrangian submanifold which is carried by (resp. weakly carried by) $\mathcal{B} \in \mathbb{B}$, then $\tau_k(L)$ is carried (resp. weakly carried) by $F_{\tau_k}(\mathcal{B})$. The case of σ_j^{-1} is analogous.*

Proof. We can assume that L is contained in an arbitrary small neighborhood of \mathcal{B} . Then, we apply a Dehn twist τ_k as we did in the proof of Lemma 3.17. The details are similar to the proof of Lemma 3.17. \square

Proof of Theorem 1.2. Let $\psi : M \xrightarrow{\sim} M$ be a symplectic automorphism of generalized Penner type. Then, we can write $\psi = \delta_1 \circ \dots \circ \delta_l$ where δ_k is a Dehn twist τ_i or σ_j^{-1} . We then define $F_\psi = F_{\delta_1} \circ \dots \circ F_{\delta_l} : \mathbb{B} \rightarrow \mathbb{B}$. By Lemma 3.17, we have specific functions F_{τ_i} and $F_{\sigma_j^{-1}}$ acting on \mathbb{B} .

We claim that F_ψ is a constant map, i.e., $\text{Im}(F_\psi)$ is a point \mathcal{B}_ψ , which we define as follows: in Equation (3.4), we set $D_p = D_p^+$ for $p \in \alpha_i \cap \beta_j$ if the last τ_i in ψ appears later than the last σ_j^{-1} , and $D_p = D_p^-$ otherwise. Note that every Dehn twist τ_i and σ_j^{-1} appears in ψ , thus \mathcal{B}_ψ is well-defined. By Equation (3.7), $F_\psi(\mathcal{B}) = \mathcal{B}_\psi$ for all $\mathcal{B} \in \mathbb{B}$. \square

Remark 3.19.

- (1) Note that a singular value of $\pi : \psi^m(L) \rightarrow \mathcal{B}^*$, which is defined in Section 3.1, can be moved by isotoping $\psi^m(L)$.
- (2) We observe that every singular value of $\pi : \psi^m(\mathcal{B}_\psi) \rightarrow \mathcal{B}^*$ lies near $\pi(p)$, $\pi(\tau_i(p))$, or $\pi(\sigma_j^{-1}(p))$ by isotoping, where p is a plumbing point. More precisely, let $S_{p, \mathcal{B}_\psi}^+$ (resp. $S_{p, \mathcal{B}_\psi}^-$) be the sector of \mathcal{B}_ψ^* containing $\pi(p)$ if $D_p = D_p^+$ (resp. D_p^-),

where D_p, D_p^+ and D_p^- are defined in Section 3.4. Similarly, let $\bar{S}_{p, \mathcal{B}_\psi}^\pm$ be $\pi(\bar{D}_p^\pm)$, where \bar{D}_p^\pm is defined in Equation (3.5). Then, by isotoping $\psi^n(\mathcal{B}_\psi)$, every singular value of $\pi : \psi^n(\mathcal{B}_\psi) \rightarrow \mathcal{B}^*$ lies in the interiors of $S_{p, \mathcal{B}_\psi}^\pm$ or $\bar{S}_{p, \mathcal{B}_\psi}^\pm$ for some plumbing point p .

For convenience, let the *centers* of $S_p^\pm, \bar{S}_p^+, \bar{S}_p^-$ be $p, \tau(p), \sigma^{-1}(p)$ respectively. Then, the singular values in S_p^\pm, \bar{S}_p^\pm lie near the centers of them. Moreover, $S_{p, \mathcal{B}_\psi}^\pm$ and $\bar{S}_{p, \mathcal{B}_\psi}^\pm$ will be simply called S_p^\pm and \bar{S}_p^\pm .

4. CONSTRUCTION OF LAGRANGIAN LAMINATIONS

In this section, we will prove Theorems 1.3 and 1.4..

4.1. Singular and regular disks. In order to prove Theorems 1.3 and 1.4, we would like to construct a stable Lagrangian lamination \mathcal{L} of a symplectic automorphism ψ from a Lagrangian branched submanifold \mathcal{B}_ψ . One of the difficulties is that singular components occur naturally. In order to control the singularities, we introduce singular and regular disks.

In general, we assume that \mathcal{B}_ψ^* , the associated branched manifold, can be decomposed into the union of a finite number of disks $S_i \simeq \mathbb{D}^n$, which are called *singular disks*, and $R_j \simeq \mathbb{D}^n$, which are called *regular disks*, i.e.,

$$(4.10) \quad \mathcal{B}_\psi^* = \bigcup_i S_i \cup \bigcup_j R_j,$$

such that

- (1) each singular disk S_i is either a closed disk contained in the interior of a sector of \mathcal{B}_ψ^* or a closure of a sector,
- (2) $S_i \cap S_j = \emptyset$ for any $i \neq j$,
- (3) every singular value of $\pi : \psi^m(\mathcal{B}_\psi) \rightarrow \mathcal{B}_\psi$ after weakly fibered isotopy lies in $\cup_i \mathring{S}_i$ for all $m \in \mathbb{N}$, where \mathring{S}_i is the interior of S_i ,
- (4) each regular disk R_j is obtained by cutting up a closure of a sector minus $\cup_i \mathring{S}_i$,

(5) S_i and R_j (resp. R_i and R_j for $i \neq j$) meet only along their boundaries.

Remark 4.1. From now on, for any compact Lagrangian submanifold L which is carried by \mathcal{B}_ψ , we will assume that every singular value of $\pi : L \rightarrow \mathcal{B}_\psi$ lies in the interior of a singular disk by Remark 3.19.

If \mathcal{B}^* admits Equation (4.10), then one obtains a decomposition of $N(\mathcal{B})$ as follows:

$$N(\mathcal{B}) = \bigcup_i \pi^{-1}(S_i) \cup \bigcup_j \pi^{-1}(R_j).$$

In Section 4.2, we will define braids $b(L, S_i)$ for a Lagrangian L , which is carried by \mathcal{B}_ψ , and a singular disk S_i . By Theorem 1.2, there exist sequences of braids $b(\psi^m(L), S_i)_{m \in \mathbb{N}}$, and we will construct limits of those braid sequences as $m \rightarrow \infty$. We then extend the limit lamination to a Lagrangian lamination of $\pi^{-1}(S_i)$ in Section 4.3, and a Lagrangian lamination of $\pi^{-1}(R_j)$ in Section 4.4.

Remark 4.2.

- (1) In Section 4.3 (resp. Section 4.4), we will construct a Lagrangian lamination on $\overline{\pi^{-1}(\overset{\circ}{S}_i)} \subset \pi^{-1}(S_i)$ (resp. $\overline{\pi^{-1}(\overset{\circ}{R}_j)} \subset \pi^{-1}(R_j)$), the closure of $\pi^{-1}(\overset{\circ}{S}_i)$. This is because $\pi^{-1}(S_i)$ (resp. $\pi^{-1}(R_j)$) is not a (closed) submanifold of M if S_i (resp. R_j) intersects the branch locus of \mathcal{B}^* .

Figure 4 is an example. If S_1 in Figure 4 is a singular disk, then $\pi^{-1}(S_1)$ is the union of the red box in Figure 4 (a) and F_x .

- (2) We note that $(\overline{\pi^{-1}(\overset{\circ}{S}_i)}, \omega)$ (resp. $(\overline{\pi^{-1}(\overset{\circ}{R}_j)}, \omega)$) and $(DT^*\mathcal{D}, \omega_0)$ are symplectomorphic to each other, where \mathcal{D} is a closed disk, $DT^*\mathcal{D}$ is a disk cotangent bundle of \mathcal{D} , and ω_0 is the standard symplectic form of the cotangent bundle.

In order to construct a symplectomorphism, we will consider the following:
Let \mathcal{D} be a largest Lagrangian disk such that

$$\mathcal{D} \subset \pi^{-1}(S_i) \cap \mathcal{B} \text{ (resp. } \pi^{-1}(R_j) \cap \mathcal{B}) \text{ and } \pi(\mathcal{D}) = S_i \text{ (resp. } R_j).$$

By Remark 3.5, there exists a symplectic embedding $i_{\mathcal{D}} : \mathcal{N}(\mathcal{D}) \hookrightarrow M$. It is easy to construct a vector field on $i_{\mathcal{D}}(\mathcal{N}(\mathcal{D}))$, whose (time 1) flow moves $i_{\mathcal{D}}(\mathcal{N}(\mathcal{D}) \cap T_p^*\mathcal{D})$ to $F_{\pi(p)}$ for any $p \in \text{Int}(\mathcal{D})$. Moreover, the vector field is a symplectic vector field, i.e., the flow is a symplectomorphism, and

$$\cup_{p \in \text{Int}(\mathcal{D})} i_{\mathcal{D}}(\mathcal{N}(\mathcal{D}) \cap T_p^*\mathcal{D}) \simeq \cup_{p \in \text{Int}(\mathcal{D})} F_{\pi(p)} = \pi^{-1}(\dot{S}_i) \text{ (resp. } \pi^{-1}(\dot{R}_j)).$$

By taking the closures, $i_{\mathcal{D}}(\mathcal{N}(\mathcal{D})) \simeq \overline{\pi^{-1}(\dot{S}_i)}$ (resp. $\overline{\pi^{-1}(\dot{R}_j)}$). Moreover, $\mathcal{N}(\mathcal{D})$ is symplectomorphic to $DT^*\mathcal{D}$. Thus, $DT^*\mathcal{D}$ and $\overline{\pi^{-1}(\dot{S}_i)}$ (resp. $\overline{\pi^{-1}(\dot{R}_j)}$) are symplectomorphic.

From now on, we assume that a symplectic automorphism ψ is of generalized Penner type until the end of Section 4.3.

Decomposition of \mathcal{B}_ψ^ for ψ of generalized Penner type.* We will now explain how to decompose \mathcal{B}^* , the associated branched manifold of $\mathcal{B} \in \mathbb{B}$, into the union of specific singular and regular disks. Note that \mathbb{B} is defined in Section 3.4.

By Remark 3.19, after weakly fiber isotoping, every singular value of $\pi : \psi^m(\mathcal{B}) \rightarrow \mathcal{B}^*$ lies in the interior of S_p or \bar{S}_p^\pm , where $S_p = S_p^+$ if $D_p = D_p^+$ and $S_p = S_p^-$ if $D_p = D_p^-$. Let S_p and \bar{S}_p^\pm be the specific singular disks of \mathcal{B}^* .

We will divide the complement of singular disks from \mathcal{B}^* , i.e.,

$$(4.11) \quad \mathcal{B}^* \setminus (\cup_p S_p \sqcup \cup_p \bar{S}_p^+ \sqcup \cup_p \bar{S}_p^-),$$

into regular disks. In order to do this, we use a symplectic submanifold $W^{2n-2} \subset M^{2n}$, which is defined as follows: For each α_i (resp. β_j), there is an equator C_{α_i} (resp. C_{β_j}) $\simeq S^{n-1}$ such that

- (1) for any plumbing point $p \in \alpha_i$ (resp. β_j), p lies on C_{α_i} (resp. C_{β_j}),
- (2) if $p \in \alpha_i \cap \beta_j$, then $T^*C_{\alpha_i} \equiv T^*C_{\beta_j}$ near p .

Note that the equators on a Lagrangian sphere α_i (resp. β_j) are defined using an identification $\phi_{\alpha_i} : \alpha_i \xrightarrow{\sim} S^n$ (resp. $\phi_{\beta_j} : \beta_j \xrightarrow{\sim} S^n$). Thus, by choosing proper identification ϕ_{α_i} and ϕ_{β_j} , we can assume the existence of C_{α_i} and C_{β_j} . Then,

$$W := \cup_i T^*C_{\alpha_i} \cup \cup_j T^*C_{\beta_j}$$

is a $(2n - 2)$ -dimensional symplectic submanifold of M .

We cut (4.11) along $\pi(W)$. These are the regular disks R_k . Each R_k is a manifold with corners, where the corners are at $R_k \cap \pi(W) \cap S_l$.

4.2. Braids. Consider the decomposition of \mathcal{B}_ψ^* into specific singular and regular disks as in the previous subsection. In this subsection, for a given compact Lagrangian submanifold L which is carried by \mathcal{B}_ψ , we define a sequence of braids $b(\psi^m(L), S_i)$ corresponding to $\psi^m(L)$ over the boundary of each singular disk S_i of \mathcal{B}_ψ^* . Lemma 4.4 gives an inductive description of the sequences $b(\psi^m(L), S_i)$. We will end this subsection by constructing limits of $b(\psi^m(L), S_i)$ as $m \rightarrow \infty$.

For a singular disk S , $\pi^{-1}(\partial S) = \cup_{p \in \partial S} F_p$ is a \mathbb{D}^n -bundle over $\partial S \simeq S^{n-1}$. Note that we use \mathbb{D}^n to indicate a closed disk, and we will use $\mathring{\mathbb{D}}^n$ to indicate an open disk. Let $\varphi : \pi^{-1}(\partial S) \xrightarrow{\sim} S^{n-1} \times \mathbb{D}^n$ be a bundle map. If L is a Lagrangian submanifold which is carried by \mathcal{B}_ψ , then, for all $p \in \partial S$, $\varphi(L \cap F_p)$ is a finite collection of isolated points in \mathbb{D}^n ; recall that $\pi : L \rightarrow \mathcal{B}^*$ has no singular value on ∂S . Thus, $\varphi(L \cap \pi^{-1}(\partial S))$ can be identified with a map from $\partial S \simeq S^{n-1}$ to the configuration space $\text{Conf}_l(\mathbb{D}^n)$ of l points on \mathbb{D}^n where $l = l(L, S)$, i.e., a braid.

We explained that $L \cap \pi^{-1}(\partial S)$ could be identified with a braid. Since L is a Lagrangian submanifold of M , the braid corresponding to $L \cap \pi^{-1}(\partial S)$ satisfies a symplectic property. The symplectic property is the following: For the bundle map $\varphi : \pi^{-1}(\partial S) \xrightarrow{\sim} S^{n-1} \times \mathbb{D}^n$, $(\varphi^{-1})^*(\omega)$ is a 2-form on $S^{n-1} \times \mathbb{D}^n$ such that $(\varphi^{-1})^*(\omega)$ is zero on $\varphi(L \cap \pi^{-1}(\partial S))$.

From now on, we will define the braids on the boundary of a singular disk S . Let $f : S^{n-1} \rightarrow \text{Conf}_l(\mathbb{D}^n)$ for some l . In other words, there are maps

$$f_1, \dots, f_l : S^{n-1} \rightarrow \mathbb{D}^n,$$

such that $f(p) = \{f_1(p), \dots, f_l(p)\}$ as $f_i(p) \neq f_j(p)$ for all $i \neq j$. We define

$$B(f) := \{(p, f_i(p)) \in S^{n-1} \times \mathbb{D}^n \mid i \in \{1, \dots, l\}\},$$

$$\tilde{B}r_{\partial S} := \{\varphi^{-1}(B(f)) \mid f : S^{n-1} \rightarrow \text{Conf}_l(\mathbb{D}^n) \text{ for some } l \text{ such that,}$$

$$(\varphi^{-1})^*(\omega) \text{ is a zero on } B(f)\}.$$

Note that $\tilde{B}r_{\partial S}$ is a set of closed subsets of $\pi^{-1}(\partial S)$ and independent of φ .

We define an equivalence relation on $\tilde{B}r_{\partial S}$ as follows: $b_0 \sim b_1$ for $b_i \in \tilde{B}r_{\partial S}$ if there exists a smooth 1-parameter family $b_t \in \tilde{B}r_{\partial S}$ connecting b_0 and b_1 . Let $Br_{\partial S} := \tilde{B}r_{\partial S} / \sim$.

Definition 4.3. Let $\mathcal{B} \in \mathbb{B}$ and let S be a singular disk of \mathcal{B} . If L is a Lagrangian submanifold which is carried by \mathcal{B} , then the *braid* $b(L, S)$ of L on S is the braid isotopy class of $Br_{\partial S}$ which is given by

$$b(L, S) = [L \cap \pi^{-1}(\partial S)] \in Br_{\partial S}.$$

Recall that \mathbb{B} is a set of Lagrangian branched submanifold defined in Section 3.4 and for any $\mathcal{B} \in \mathbb{B}$, we decompose \mathcal{B} into the union of specific singular disks and regular disks, introduced in Section 4.1.

Lemma 4.4. Let L be a Lagrangian submanifold of M which is carried by \mathcal{B} . For a given singular disk S of $F_{\tau_i}(\mathcal{B})$ (resp. $F_{\sigma_j^{-1}}(\mathcal{B})$), there exist maps f_k from $\tilde{B}r_{S_{i_k}}$ to $\tilde{B}r_S$, where S_{i_k} is a singular disk of \mathcal{B} , and there exist closed sets $\mathring{b}_{i_k} \in \tilde{B}r_{S_{i_k}}$, such that $b(\tau_i(L), S)$ (resp. $b(\sigma_j^{-1}(L), S)$) is $[\bigsqcup_k f_k(\mathring{b}_{i_k})] \in Br_{\partial S}$.

Recall the functions F_{τ_i} and $F_{\sigma_j^{-1}}$ in Lemma 4.4 are defined in Lemma 3.17.

Proof of Lemma 4.4. In Steps 1–3, we prove Lemma 4.4 for a particular example; this is just for notational simplicity. In Step 4, we briefly describe how to prove the general case.

The example we consider is the Lagrangian branched submanifold \mathcal{B}_ψ in $M = P(\alpha, \beta_1, \beta_2)$, where α and β_j are spheres such that $\alpha \cap \beta_1 = \{p\}$ and $\alpha \cap \beta_2 = \{q\}$, τ_0 and σ_j are Dehn twists along α and β_j , and $\psi = \tau_0 \circ \sigma_1^{-1} \circ \sigma_2^{-1}$. Then, \mathcal{B}_ψ is given by Theorem 1.2.

Step 1 (Notation). First, we will choose $\varphi : \pi^{-1}(\partial S) \xrightarrow{\sim} S^{n-1} \times \mathbb{D}^n$ for $S = S_p^\pm, S_q^\pm, \bar{S}_p^\pm$, and \bar{S}_q^\pm . We will use φ in the next steps.

In order to construct $\varphi : \pi^{-1}(\partial S_p^+) \xrightarrow{\sim} S^{n-1} \times \mathbb{D}^n$, we observe that

$$\pi^{-1}(S_p^+) \cap \mathcal{B} \subset D_p^+,$$

by Remark 4.2. Moreover, we can assume that $\pi^{-1}(S_p^+) \subset i_{D_p^+}(\mathcal{N}(D_p^+))$. Note that $i_{D_p^+}$ and $\mathcal{N}(D_p^+)$ are defined in Remark 3.5. Thus, by choosing coordinate charts for D_p^+ , one obtains $\varphi : \pi^{-1}(S_p^+) \xrightarrow{\sim} \mathbb{D}^n \times \mathbb{D}^n$. By abuse of notation, the restriction $\varphi|_{\pi^{-1}(\partial S_p^+)}$: $\pi^{-1}(\partial S_p^+) \xrightarrow{\sim} S^{n-1} \times \mathbb{D}^n$ is simply called φ again. Similarly, it is enough to choose coordinate charts for $D_p^-, D_q^\pm, \bar{D}_p^\pm, \bar{D}_q^\pm$, in order to fix $\varphi : \pi^{-1}(\partial S) \xrightarrow{\sim} S^{n-1} \times \mathbb{D}^n$ for $S = S_p^-, S_q^\pm, \bar{S}_p^\pm, \bar{S}_q^\pm$.

In order to choose specific coordinate charts for $D_p^\pm, D_q^\pm, \bar{D}_p^\pm$, and \bar{D}_q^\pm , we use the $(2n - 2)$ -dimensional submanifold $W \subset M$ defined in Section 4.1. For convenience, we consider the lowest nontrivial dimension, i.e., $n = 2$. For higher n , we can fix coordinate charts similarly.

Let (x_1, x_2) be a coordinate chart on $D_p^+ \subset \alpha$ such that the x_1 -axis agrees with $W \cap D_p^+$. There are two choices for the positive x_1 -direction corresponding to the two orientations of $W \cap D_p^+$, or equivalently orientations of C_α . We can choose either

of them. Then, let (y_1, y_2) be an oriented chart on D_p^- such that the y_1 -axis agrees with $W \cap \beta_1$ and $\omega(\partial_{x_1}, \partial_{y_1}) > 0$. The positive y_1 -direction determines an orientation of C_{β_1} . On \bar{D}_p^+ , there exists an oriented chart (x_1, x_2) such that the positive x_1 -direction agrees with the orientation of C_α . For the other singular disks, we obtain oriented coordinate charts from the orientations of $C_\alpha, C_{\beta_i}, \alpha$ and β_i in the same way.

Let $b_1 = b(L, S_p^+), b_2 = b(L, \bar{S}_p^+), b_3 = b(L, \bar{S}_p^-), b_4 = b(L, S_q^+), b_5 = b(L, \bar{S}_q^+)$, and $b_6 = b(L, \bar{S}_q^-)$, and let \mathring{b}_i be a representative of b_i .

The boundaries of S_p^+ is a component of the branch locus of \mathcal{B}_ψ^* . By Remark 3.8 (3), one can decompose \mathring{b}_1 . More precisely, in this case, Remark 3.8 says that for any $x \in \partial S_p^+$, there are three sectors S_0, S_1, S_2 such that

$$x \in S_i \text{ for all } i = 0, 1, 2,$$

$$F_x \cap \overline{\pi^{-1}(\mathring{S}_0)} = F_x \text{ and } F_x \cap \overline{\pi^{-1}(\mathring{S}_i)} \subset \mathring{F}_x \text{ for } i = 1, 2.$$

Moreover, it is easy to check that S_p^+ is either S_1 or S_2 . Without loss of generality, let us label $S_1 = S_p^+$.

If L is carried by \mathcal{B} , we assume that $L \subset N(\mathcal{B})$. Then, one obtains

$$L \cap F_x \subset (F_x \cap \overline{\pi^{-1}(\mathring{S}_1)}) \cup (F_x \cap \overline{\pi^{-1}(\mathring{S}_2)})$$

We decompose \mathring{b}_1 into $\mathring{b}_1 = \tilde{b}_1 \sqcup \bar{b}_1$, where $\tilde{b}_1 = \mathring{b}_1 \cap \overline{\pi^{-1}(\mathring{S}_1)}$ and $\bar{b}_1 = \mathring{b}_1 \cap \overline{\pi^{-1}(\mathring{S}_2)}$. The decomposition $\mathring{b}_4 = \bar{b}_4 \sqcup \tilde{b}_4$ is similar.

We will explain the effects of σ_2^{-1} on \mathcal{B}_ψ in Step 2 and τ_0 on \mathcal{B}_ψ in Step 3. The effect of σ_1^{-1} is similar to that of σ_2^{-1} .

Step 2 (Effect of σ_2^{-1} on \mathcal{B}_ψ). In the rest of this paper, we make specific choices of τ_0 and σ_j which are given by Equation (2.2), and $\tau : T^*S^2 \xrightarrow{\sim} T^*S^2$, which is defined in Remark 2.2. In other words, $\tau_0 = \phi_\alpha \circ \tau \circ \phi_\alpha^{-1}$ and $\sigma_j = \phi_{\beta_j} \circ \tau \circ \phi_{\beta_j}^{-1}$, where ϕ_α

(resp. ϕ_{β_j}) is a symplectomorphism from T^*S^2 to a neighborhood of α (resp. β_j). The neighborhood of α (resp. β_j) will be denoted by $T^*\alpha$ (resp. $T^*\beta_j$).

Remark 4.5. Recall that τ is a Dehn twist on T^*S^n which agrees with the antipodal map

$$T^*S^n \xrightarrow{\sim} T^*S^n, (u; v) \mapsto (-u; -v),$$

on a neighborhood of the zero section S^n .

By Lemma 3.18, $\sigma_2^{-1}(L)$ is carried by $\mathcal{B}' = F_{\sigma_2^{-1}}(\mathcal{B}_\psi)$. We label

$$\begin{aligned} b'_1 &= b(\sigma_2^{-1}(L), S_p^+), b'_2 = b(\sigma_2^{-1}(L), \bar{S}_p^+), b'_3 = b(\sigma_2^{-1}(L), \bar{S}_p^-), \\ b'_4 &= b(\sigma_2^{-1}(L), S_q^-), b'_5 = b(\sigma_2^{-1}(L), \bar{S}_q^+), b'_6 = b(\sigma_2^{-1}(L), \bar{S}_q^-). \end{aligned}$$

Note that the singular disk for b_4 is S_q^+ and the singular disk for b'_4 is S_q^- , i.e., two singular disks have the same center but different sign. However, for $i \neq 4$, the singular disks for b_i and b'_i have the same center and the same sign.

For convenience, the singular disk of \mathcal{B}_ψ (resp. $F_{\sigma_2^{-1}}(\mathcal{B}_\psi)$) will be called S_i (resp. S'_i), so that b_i (resp. b'_i) is a braid on $\pi^{-1}(\partial S_i)$ (resp. $\pi^{-1}(\partial S'_i)$). Also, let $\varphi_i : \overline{\pi^{-1}(\dot{S}_i)} \xrightarrow{\sim} \mathbb{D}^2 \times \mathring{\mathbb{D}}^2$ (resp. $\varphi'_i : \overline{\pi^{-1}(\dot{S}'_i)} \xrightarrow{\sim} \mathbb{D}^2 \times \mathring{\mathbb{D}}^2$) be the identification which is fixed in Step 1.

Since σ_2^{-1} is supported on $T^*\beta_2$, a small neighborhood of β_2 , b_i and b'_i are the same braid in $Br_{\partial S_i}$ for $i = 1, 2, 3$, and 5 . We will explain how b'_6 is constructed.

We can obtain $\sigma_2^{-1}(\mathcal{B}_\psi)$ by spinning with respect to q in $T^*\beta_2$, i.e., $\sigma_2^{-1}(\mathcal{B}_\psi)$ is the union of curves in 2-dimensional submanifold $\phi_{\beta_2}(W_y)$ over $y \in S^1$. Recall that the spinning and W_y are defined in Section 2.2.

Figure 7 represents $\mathcal{B}_\psi \cap \phi_{\beta_2}(W_y)$ and $\sigma_2^{-1}(\mathcal{B}_\psi) \cap \phi_{\beta_2}(W_y)$ on $\phi_{\beta_2}(W_y)$. We obtain Figure 7 because we choose specific σ_2 .

By spinning blue, red, and green points in Figure 7, we obtain $\sigma_2^{-1}(\mathcal{B}_\psi) \cap \pi^{-1}(\partial S'_6)$. Let B, R , and G be the circles obtained by spinning blue, red, and green points respectively.

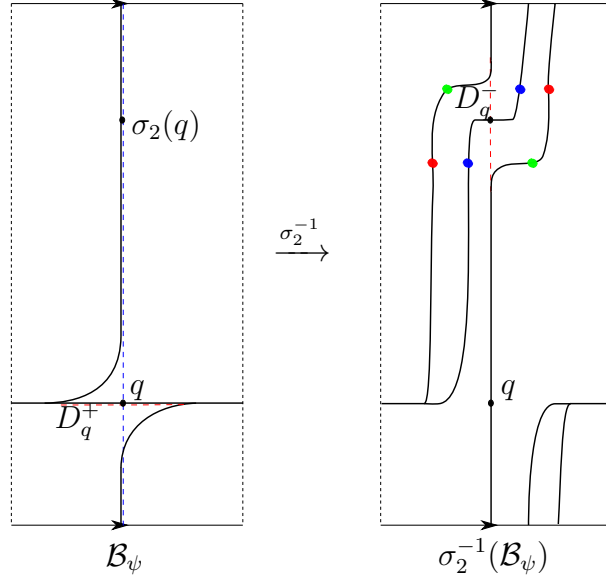

FIGURE 7. $\sigma_2^{-1}(\mathcal{B}_\psi) \cap \phi_{\beta_2}(W_y)$.

The left picture represents $\mathcal{B}_\psi \cap \phi_{\beta_2}(W_y)$ and the right picture represents $\sigma_2^{-1}(\mathcal{B}_\psi) \cap \phi_{\beta_2}(W_y)$.

Since $N(\mathcal{B}_\psi) \supset \mathcal{B}_\psi$, $\sigma_2^{-1}(N(\mathcal{B}_\psi)) \cap \pi^{-1}(\partial S'_6)$ is a neighborhood of $\sigma_2^{-1}(\mathcal{B}_\psi) \cap \pi^{-1}(\partial S'_6)$. By assuming that $N(\mathcal{B}_\psi)$ is a sufficiently small neighborhood of \mathcal{B}_ψ , $\sigma_2^{-1}(N(\mathcal{B}_\psi)) \cap \pi^{-1}(\partial S'_6)$ consists of three connected components, which are neighborhoods of B , R , and G . Each connected component will be called $N(B)$, $N(R)$, and $N(G)$.

By definition, $b'_6 = [\sigma_2^{-1}(L) \cap \pi^{-1}(\partial S'_6)]$. Without loss of generality, we assume that $L \subset N(\mathcal{B}_\psi)$. Then,

$$\sigma_2^{-1}(L) \cap \pi^{-1}(\partial S'_6) \subset \sigma_2^{-1}(N(\mathcal{B}_\psi)) \cap \pi^{-1}(\partial S'_6) = N(B) \sqcup N(R) \sqcup N(G).$$

Thus, strands of $\sigma_2^{-1}(L) \cap \pi^{-1}(\partial S'_6)$, or equivalently b'_6 , are divided into three groups, which are contained in $N(B)$, $N(R)$, and $N(G)$ respectively. We argue the group which is contained in $N(B)$ first.

The group of strands in $N(B)$ is given by $\sigma_2^{-1}(L) \cap N(B)$. Thus, we will consider $\sigma_2(\sigma_2^{-1}(L) \cap N(B)) = L \cap \sigma_2(N(B))$. One of the main difficulties is that the action of σ_2^{-1} on $\sigma_2(N(B))$ is not simple. To make it simpler, we will construct a Hamiltonian

isotopy Φ_t , so that there is a disk $D_B \subset S_q^+$ such that

$$(\Phi_1 \circ \sigma_2^{-1})(\pi^{-1}(\partial D_B)) \subset \pi^{-1}(\partial S'_6).$$

Then, $(\Phi_1 \circ \sigma_2^{-1})(\pi^{-1}(\partial D_B) \cap L)$ corresponds to the group of strands in $N(B)$.

We construct Φ_t as follow: Let $H_t : \mathbb{R}^4 \rightarrow \mathbb{R}^4$ be a Hamiltonian isotopy given by

$$H_t = \begin{pmatrix} \cos t & 0 & -\sin t & 0 \\ 0 & \cos t & 0 & -\sin t \\ \sin t & 0 & \cos t & 0 \\ 0 & \sin t & 0 & \cos t \end{pmatrix},$$

and let $\delta : [0, \infty) \rightarrow \mathbb{R}$ be a smooth decreasing function such that $\delta(x) = \frac{\pi}{2}$ for all $x < 1$ and $\delta(x) = 0$ for all $x > 2$. We choose a neighborhood $U \subset \beta_2$ of $\sigma_2^{-1}(q)$ and a Darboux chart $\phi_q : T^*U \xrightarrow{\sim} \mathbb{R}^4$ such that $\phi_q(\sigma_2^{-1}(q))$ is the origin. We remark that $T^*\beta_2$ denotes a neighborhood of β_2 in M , which is symplectomorphic to the cotangent bundle of β_2 . Thus, for a subset U of β_2 , one can assume that T^*U is a subset of M .

For convenience, let $\phi_q(x) = (x_1; x_2)$ where $x_i \in \mathbb{R}^2$. Then, there is a Hamiltonian isotopy

$$(4.12) \quad \Phi_t(x) = \begin{cases} (\phi_q^{-1} \circ H_{t\delta(c_1\|x_1\|+c_2\|x_2\|)} \circ \phi_q)(x) & \text{if } x \in T^*U, \\ x & \text{if } x \notin T^*U, \end{cases}$$

where c_i is a positive constant and $\|\cdot\|$ is the standard norm on \mathbb{R}^2 .

To visualize, we use D_q^+ and \bar{D}_q^- instead of S_4 and S'_6 in Figure 8. Figure 8 represents $\phi_{\beta_2}(W_y) \cap D_q^+$, $\phi_{\beta_2}(W_y) \cap \sigma_2^{-1}(D_q^+)$ and $\phi_{\beta_2}(W_y) \cap \Phi_1(\sigma_2^-(D_q^+))$ in the left, middle, and right pictures respectively. By choosing proper c_i , we obtain a small disk $D_B \subset S_q^+$ such that $(\Phi_1 \circ \sigma_2^{-1})(\pi^{-1}(\partial D_B)) \subset \pi^{-1}(\partial S'_6)$. More precisely, we obtain a disk $\tilde{D} \subset D_q^+$ which is in blue in the left of Figure 8. Blue curves in the middle and

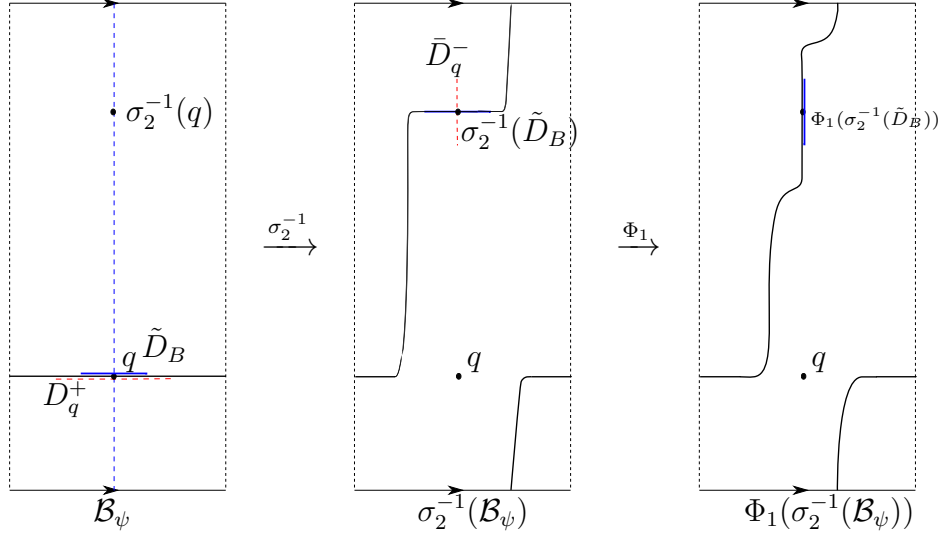

FIGURE 8. $\Phi_1(\sigma_2^{-1}(\mathcal{B}_\psi)) \cap \phi_{\beta_2}(W_y)$.

The blue curves represent $\tilde{D}_B \cap \phi_{\beta_2}(W_y)$ in the left picture, $\sigma_2^{-1}(\tilde{D}_B) \cap \phi_{\beta_2}(W_y)$ in the middle picture, and $\Phi_1(\sigma_2^{-1}(\tilde{D}_B)) \cap \phi_{\beta_2}(W_y)$ in the right picture.

right of Figure 8 represent $(\pi \circ \sigma_2^{-1})(\tilde{D}_B)$ and $(\Phi_1 \circ \sigma_2^{-1})(\pi(\tilde{D}_B))$. Then, D_B is given by $D_B := \pi(\tilde{D}_B)$.

On a small neighborhood of D_B , σ_2^{-1} agrees with the antipodal map of $\phi_{\beta_2}(T^*\beta_2) \simeq T^*S^2$, as we mentioned in Remark 4.5. Then, we obtain a map

$$f_1 : S^1 \times \mathbb{D}^2 \xrightarrow{\tilde{\varphi}_4^{-1}} \pi^{-1}(\partial D_B) \xrightarrow{\Phi_1 \circ \sigma_2^{-1}} \pi^{-1}(\partial S'_6) \xrightarrow{\varphi'_6} S^1 \times \mathbb{D}^2,$$

$$(\theta, x, y) \mapsto (\theta + \pi, -r_1x, -r_1y).$$

The first identification $\tilde{\varphi}_4$ is the restriction of $\varphi_4 : \pi^{-1}(S_4) \xrightarrow{\sim} \mathbb{D}^2 \times \mathbb{D}^2$.

Remark 4.6.

- (1) Note that $\varphi'_6(\text{Im}(f_1)) = (\Phi_1 \circ \sigma_2^{-1})(\pi^{-1}(\partial D_B)) \cap \pi^{-1}(\partial S'_6)$. Similarly, for the groups of strands in $N(R)$ and $N(G)$, one can obtain two functions f_2 and f_3 on $S^1 \times \mathbb{D}^2$ in the same way. Then, the images $\text{Im}(f_2)$ and $\text{Im}(f_3)$ correspond

to

$$(\Phi_1 \circ \sigma_2^{-1})(\pi^{-1}(\pi(N_q))) \cap \pi^{-1}(\partial S'_6) \subset \pi^{-1}(\partial S'_6) \stackrel{\varphi'_6}{\cong} S^1 \times \mathbb{D}^2.$$

Thus, f_1 explains the contribution of \tilde{b}_4 , and f_2 and f_3 explain the contribution of \bar{b}_4 on the construction of b'_6 .

- (2) The constant r_1 is determined by specific choices of an identification $\phi_{\beta_2} : T^*S^2 \xrightarrow{\sim} T^*\beta_2$, the fixed Dehn twist τ in Remark 2.2, and so on. However, r_1 has to be smaller than 1. This is because $\text{Im}(f_1)$, $\text{Im}(f_2)$, and $\text{Im}(f_3)$ are mutually disjoint, since they corresponds to $N(B)$, $N(R)$, and $N(G)$ respectively.

The strands of b'_6 which are contained in $N(B)$ correspond to

$$\varphi_6'^{-1}(f_1(\tilde{\varphi}_4(L \cap \pi^{-1}(\partial D_B)))).$$

We will prove that $L \cap \pi^{-1}(\partial D_B)$ represents the same braid with \tilde{b}_4 . We can assume that there is no singular value of π on $S_4 \setminus D_B$. Then, $\varphi_4(\tilde{b}_4)$ and $\tilde{\varphi}_4(L \cap \pi^{-1}(\partial D_B))$ represent the same braid in $S^1 \times \mathbb{D}^2$ because of non-singularity on $S_4 \setminus D_B$. Thus, in $S^1 \times \mathbb{D}^2$, $f_1(\varphi_4(\tilde{b}_4))$ and $f_1(\tilde{\varphi}_4(L \cap \pi^{-1}(\partial D_B)))$ represent the same braid. It proves that $\varphi_6'^{-1}(f_1(\varphi_4(\tilde{b}_4)))$ and the group of strands in $N(B)$ represent the same braid in $Br_{\partial S'_6}$.

Remark 4.7. For convenience, we simply use $f_1(\tilde{b}_4)$, instead of $\varphi_6'^{-1}(f_1(\varphi_4(\tilde{b}_4)))$. In the rest of this paper, we will abuse notation in the same way.

For the groups of strands in $N(R)$ and $N(G)$, we obtain the following maps f_2 and f_3 in the same way,

$$\begin{aligned}
f_2 : S^1 \times \mathbb{D}^2 &\rightarrow S^1 \times \mathbb{D}^2, \\
(\theta, x, y) &\mapsto (\theta + \pi, r_0 \cos \theta + r_2 x, r_0 \sin \theta + r_2 y), \\
f_3 : S^1 \times \mathbb{D}^2 &\rightarrow S^1 \times \mathbb{D}^2, \\
(\theta, x, y) &\mapsto (\theta + \pi, -r_0 \cos \theta + r_2(x \cos 2\theta - y \sin 2\theta), \\
&\quad -r_0 \sin \theta + r_2(x \sin 2\theta + y \cos 2\theta)),
\end{aligned}$$

where r_0 and r_2 are positive constants which are smaller than 1.

Remark 4.8.

- (1) To obtain f_1 , we used a Hamiltonian isotopy Φ_t . Similarly, to obtain f_2 and f_3 , we need a Hamiltonian isotopy. We construct a Hamiltonian isotopy by extending a Lagrangian isotopy connecting $\sigma_2^{-1}(N_q) \cap \overline{\pi^{-1}(S'_6)}$ and

$$\begin{aligned}
&\varphi_6'^{-1}(\{(s \cos(\theta + \pi), s \sin(\theta + \pi), r_0 \cos \theta, r_0 \sin \theta) \mid s \in [-1, 1], \theta \in S^1\}), \\
&\text{in } \overline{\pi^{-1}(S'_6)} \overset{\varphi_6'}{\simeq} \mathbb{D}^2 \times \mathbb{D}^2.
\end{aligned}$$

- (2) Note that r_0 and r_2 are positive constants which are determined by specific choices. However, r_0 and r_2 have to satisfy $r_1 + r_2 < r_0$ since $\text{Im}(f_1)$, $\text{Im}(f_2)$ and $\text{Im}(f_3)$ are mutually disjoint.

In the same way that we proved that $f_1(\tilde{b}_4)$ and the group of strands in $N(B)$ represent the same braid in $Br_{\partial S'_6}$, we can prove that $f_2(\bar{b}_4)$ (resp. $f_3(\bar{b}_4)$) and the group of strand in $N(R)$ (resp. $N(G)$) represent the same braid in $Br_{\partial S'_6}$. Then, b'_6 is represented by $f_1(\tilde{b}_4) \sqcup f_2(\bar{b}_4) \sqcup f_3(\bar{b}_4)$. Note that we are abusing notation for convenience as we mentioned in Remark 4.7.

The situation for b'_4 is analogous. We obtain three maps g_1, g_2 and g_3 in the same way. At the end, b'_4 is represented by $g_1(\bar{b}_4) \sqcup g_2(\bar{b}_4) \sqcup g_3(b_6)$. This proves Lemma 4.4 for the case of σ_2^{-1} .

Note that maps f_i and g_j are given by specific maps acting on $S^1 \times \mathbb{D}^2$, but we would like to consider them as maps on $\tilde{B}r_{\partial S_k}$ for some k . Then, we summarize the effect of σ_2^{-1} as a matrix

$$\Sigma_{2, \mathcal{B}_\psi} = \begin{pmatrix} id & 0 & 0 & 0 & 0 & 0 \\ 0 & id & 0 & 0 & 0 & 0 \\ 0 & 0 & id & 0 & 0 & 0 \\ 0 & 0 & 0 & g_1 + g_2 & 0 & g_3 \\ 0 & 0 & 0 & 0 & id & 0 \\ 0 & 0 & 0 & f_1 + f_2 + f_3 & 0 & 0 \end{pmatrix}.$$

Thus, if \mathring{b}_i is a representative of a braid b_i for L , then \mathring{b}'_i is a representative of b'_i where

$$\begin{pmatrix} \mathring{b}'_1 \\ \mathring{b}'_2 \\ \mathring{b}'_3 \\ \mathring{b}'_4 \\ \mathring{b}'_5 \\ \mathring{b}'_6 \end{pmatrix} = \Sigma_{2, \mathcal{B}_\psi} \begin{pmatrix} \mathring{b}_1 \\ \mathring{b}_2 \\ \mathring{b}_3 \\ \mathring{b}_4 \\ \mathring{b}_5 \\ \mathring{b}_6 \end{pmatrix} = \begin{pmatrix} \mathring{b}_1 \\ \mathring{b}_2 \\ \mathring{b}_3 \\ g_1(\bar{b}_4) \sqcup g_2(\bar{b}_4) \sqcup g_3(\mathring{b}_6) \\ \mathring{b}_5 \\ f_1(\tilde{b}_4) \sqcup f_2(\bar{b}_4) \sqcup f_3(\bar{b}_4) \end{pmatrix}.$$

Remark 4.9. We remark that in surface theory, we can do linear algebra on weights, but in a higher-dimensional case, we cannot do linear algebra with the matrix $\Sigma_{2, \mathcal{B}_\psi}$, because there is no module structure on $\tilde{B}r_{\partial S_i}$.

Step 3 (Effects of τ_0 on \mathcal{B}_ψ). We use the same notation, i.e., b_1, \dots, b_6 denote the braids on singular disks $S - i$ of \mathcal{B}_ψ^* , and

$$b'_1 = b(\tau_0(L), S_p^+), \dots, b'_6 = b(\tau_0(L), \bar{S}_q^-),$$

so that the singular disk corresponding to b'_i has the same center as the singular disk corresponding to b_i . We also use \mathring{b}_i and \mathring{b}'_i , S_i and S'_i , φ_i and φ'_i to indicate representatives of braids, singular disks in \mathcal{B}_ψ and $F_{\tau_0}(\mathcal{B}_\psi)$, identifications induced by fixed coordinate charts.

The situation for τ_0 is similar to that for σ_2^{-1} . For example, by observing how τ_0 acts on $\overline{\pi^{-1}(\mathring{S}_1)}$, we obtain

$$h_1 : S^1 \times \mathbb{D}^2 \rightarrow S^1 \times \mathbb{D}^2,$$

explaining the contribution of \tilde{b}_1 on the construction of b'_3 . Then, h_1 is given by a translation on S^1 and a scaling on \mathbb{D}^2 , as f_1 is. Similarly, we obtain h_2 and h_3 , which explain the contributions of \bar{b}_1 on the construction of b'_3 . The map h_2 (resp. h_3) is of the same types with f_2 (resp. f_3), i.e.,

$$\begin{aligned} h_2(\theta, x, y) &= (\theta \text{ or } \theta + \pi, \pm r_1 \cos \theta + r_2 x, \pm r_1 \sin \theta + r_2 y), \\ h_3(\theta, x, y) &= (\theta \text{ or } \theta + \pi, \pm r_1 \cos \theta + r_2(x \cos 2\theta - y \sin 2\theta), \\ &\quad \pm r_1 \sin \theta + r_2(x \sin 2\theta + y \cos 2\theta)), \end{aligned}$$

where r_1 and r_2 are constants.

If a map is of the same type to f_1 , in other words, if the map is given by a translation on S^1 and a scaling on \mathbb{D}^2 , let the map be of *scaling type*. This is because the formula defining the map is given by a scaling on fibers. The maps of scaling type explain how braids $b(L, S_p^\pm)$ or $b(L, \bar{S}_p^\pm)$ contribute on the construction of braids $b(\delta(L), S_{\delta(p)}^\pm)$ or $b(\delta(L), \bar{S}_{\delta(p)}^\pm)$ through $\delta(\pi^{-1}(S_p^\pm))$, where δ is a Dehn twist.

If a map is of the same type to f_2 (resp. f_3), let the map be of *the first (resp. second) singular type*. This is because they are related to a creation of new singular component. The maps of the first and second singular types explain how the braid $b(L, \delta(S_p))$ contributes on the construction of braid $b(\delta(L), \bar{S}_{\delta(p)}^\pm)$.

To summarize, if b_i contributes the construction of b'_j and if the center of a singular disk corresponding to b_i is either the same point or the antipodal point of the center of the singular disk corresponding to b'_j , maps of these three types explain the contribution of b_i on the construction of b'_j . Note that the center of a singular disk is defined in Remark 3.19.

The maps of these three types explain the effects of σ_2^{-1} on \mathcal{B} . However, to explain the effects of τ_0 on \mathcal{B}_ψ , we need maps of one more type.

This is because α has two plumbing points, unlike β_i has only one plumbing point. Thus, when we apply τ_0 , b_i can contribute on b'_j even if the centers of singular disks corresponding to b_i and b'_j are neither the same nor antipodals of each other. For example, $L \cap \pi^{-1}(\pi(N_p))$ is stretched by τ_0 . The stretched part $\tau_0(L \cap \pi^{-1}(\pi(N_p)))$ has intersection with $\pi^{-1}(S_4)$ and $\pi^{-1}(S_5)$. Thus, b'_4 has some strands corresponding to $\tau_0(L \cap \pi^{-1}(\pi(N_p))) \cap \pi^{-1}(\partial S_4)$. These strands are the contribution of \bar{b}_1 on the construction of b'_4 . Similarly, \bar{b}_1 contributes on the construction of b'_5 , and \bar{b}_4 contributes on the constructions of b'_1 and b'_2 .

To describe the contribution of \bar{b}_1 on b'_4 , without loss of generality, we assume that there is no singular value for

$$\tau_0(L \cap \pi^{-1}(\pi(N_p))) \cap \overline{\pi^{-1}(\mathring{S}_4)} \xrightarrow{\pi} S_4,$$

by Remark 3.19. Thus, $\tau_0(L \cap \pi^{-1}(\pi(N_p))) \cap \overline{\pi^{-1}(\mathring{S}_4)}$ is a union of disjoint Lagrangian disks on $\overline{\pi^{-1}(\mathring{S}_4)}$ and \bar{b}_1 contributes on b'_4 by adding strands near $\tau_0(N_p) \cap \pi^{-1}(\partial S_4)$ which are not braided to each other. The number of the added strands is the same

as the number of strands of \bar{b}_1 . In the same way, \bar{b}_1 contributes on the construction of b'_5 .

To describe the contribution of \bar{b}_1 on b'_4 as a map acting on $S^1 \times \mathbb{D}^2$, we define $\bar{b}_1^\circ \subset \pi^{-1}(\partial S_1)$ such that

$$\varphi_1(\bar{b}_1^\circ) := \{(\theta, x_0, y_0) \mid \phi_1^{-1}(0, x_0, y_0) \in \bar{b}_1\} \subset S^1 \times \mathbb{D}^2 \xrightarrow{\varphi_1} \pi^{-1}(\partial S_1),$$

which represents a trivial braid having the same number of strands with \bar{b}_1 . This is because we only need the number of the strands in \bar{b}_1 , not the way \bar{b}_1 is braided.

We construct a Hamiltonian isotopy Φ_t by extending a Lagrangian isotopy connecting $\tau_0(N_p) \cap \pi^{-1}(\partial S_4)$ and

$$\varphi_4'^{-1}(\{(s \cos \theta, s \sin \theta, c_1, c_2) \mid s \in [-1, 1], \theta \in S^1, c_i \text{ is constants}\}) \subset \pi^{-1}(S_4),$$

as we did in Remark 4.8. Then, one obtains

$$\begin{aligned} h_t : S^1 \times \mathbb{D}^2 &\xrightarrow{\varphi_1} \pi^{-1}(\partial S_1) \xrightarrow{\Phi_1 \circ \tau_0} \pi^{-1}(\partial S_4) \xrightarrow{\varphi_4'} S^1 \times \mathbb{D}^2, \\ &(\theta, x, y) \mapsto (\theta, r_0 x + c_1, r_0 y + c_2), \end{aligned}$$

where r_0 is a positive constant number less than 1. Then, $h_t(\bar{b}_1^\circ)$ represents the same braid to the strands in b'_4 , which correspond to $\tau_0(L \cap \pi^{-1}(\pi(N_p)))$. We recall that we are abusing notation as mentioned in Remark 4.7.

Similarly, if b_i contributes the construction of b'_j and if the center of a singular disk corresponding to b_i is neither the same point nor the antipodal point of the center of the singular disk corresponding to b'_j , then the contribution of b_i on b'_j can be described by a map like h_t . If a map is of the same type with h_t , let the map be of *trivial type*, because a map of trivial type adds strands which are not braided with each other.

Then, we can describe the effect of τ_0 on \mathcal{B}_ψ as a matrix

$$T_{0, \mathcal{B}_\psi} = \begin{pmatrix} 0 & i & 0 & h_t & 0 & 0 \\ h_1 + h_2 + h_3 & 0 & 0 & i_t & 0 & 0 \\ 0 & 0 & id & 0 & 0 & 0 \\ h_t & 0 & 0 & 0 & i & 0 \\ i_t & 0 & 0 & h_1 + h_2 + h_3 & 0 & 0 \\ 0 & 0 & 0 & 0 & 0 & id \end{pmatrix}.$$

Among the entries, h_1, i , and id are of scaling type, h_2 and h_3 are of the first and second singular types, and h_t and i_t are of trivial type.

Step 4 (General case). A ψ of generalized Penner type is a product of Dehn twists. In the general case, when we apply ψ , each Dehn twist is followed by a Hamiltonian isotopy as σ_2^{-1} is followed by Φ_t in step 2. Let $\psi_H = (\Phi_{1,1} \circ \delta_1) \circ \cdots \circ (\Phi_{l,1} \circ \delta_l)$, where $\psi = \delta_1 \circ \cdots \circ \delta_l$, δ_i is a Dehn twist, and $\Phi_{i,t}$ is a Hamiltonian isotopy which follows δ_i .

After applying the Hamiltonian isotopy, the effect of a Dehn twist τ_i (resp. σ_j^{-1}) on $\mathcal{B} \in \mathbb{B}$ is described by a matrix $T_{i, \mathcal{B}}$ (resp. $\Sigma_{j, \mathcal{B}}$), whose entries are sums of maps of four types. As we mentioned in Step 3, the maps of scaling type explain how braids $b(L, S_p^\pm)$ or $b(L, \bar{S}_p^\pm)$ contribute on the construction of braids $b(\delta(L), S_{\delta(p)}^\pm)$ or $b(\delta(L), \bar{S}_{\delta(p)}^\pm)$, where δ is a Dehn twist. Similarly, the maps of the first and second singular types explain how braids $b(L, \delta(S_p))$ contribute on the construction of braid to $b(\delta(L), \bar{S}_{\delta(p)}^\pm)$. Finally, the maps of trivial type explain the other cases.

This completes the proof of Lemma 4.4. □

Taking the limit of a braid sequence. We have obtained braid sequences $\{b(\psi^m(L), S_i)\}_{m \in \mathbb{N}}$, where L is carried by \mathcal{B}_ψ , and S_i is a singular disk of \mathcal{B}_ψ^* . In the rest of this subsection, we construct a limit of $\{b(\psi^m(L), S_i)\}_{m \in \mathbb{N}}$ as $m \rightarrow \infty$.

We argue with the above example, i.e.,

$$M = P(\alpha, \beta_1, \beta_2), \psi = \tau_0 \circ \sigma_1^{-1} \circ \sigma_2^{-1}.$$

For convenience, let

$$\mathcal{B} := \mathcal{B}_\psi, \mathcal{B}' := F_{\sigma_2^{-1}}(\mathcal{B}), \mathcal{B}'' := F_{\sigma_1^{-1}}(\mathcal{B}'),$$

and let singular disks $S_p^+, \bar{S}_p^+, \bar{S}_p^-, S_q^+, \bar{S}_q^+$, and \bar{S}_q^- of \mathcal{B} be S_1, \dots, S_6 . Using notation from the proof of Lemma 4.4, we have matrices $T_{0, \mathcal{B}''}$, $\Sigma_{1, \mathcal{B}'}$, and $\Sigma_{2, \mathcal{B}}$. Then, we obtain $\Psi = T_{0, \mathcal{B}''} \cdot \Sigma_{1, \mathcal{B}'} \cdot \Sigma_{2, \mathcal{B}}$ by defining a multiplication of maps as a composition of them. Note that a product of two arbitrary matrices is not defined. For example, an input of $\Sigma_{2, \mathcal{B}}$ and an output of $T_{0, \mathcal{B}''}$ are tuples of braids on singular disks of \mathcal{B}^* . Thus, $\Sigma_{2, \mathcal{B}} \cdot T_{0, \mathcal{B}''}$ is defined. However, $T_{\mathcal{B}''} \cdot \Sigma_{2, \mathcal{B}}$ is not defined since an input of $T_{0, \mathcal{B}''}$ is a tuple of braids on singular disks of \mathcal{B}^* , but an output of $\Sigma_{2, \mathcal{B}}$ is a tuple of braids on singular disks of \mathcal{B}'^* .

Let \mathring{b}_i be a representative of $b_i = b(L, S_i)$. If

$$\begin{pmatrix} \mathring{b}_{1,m} \\ \mathring{b}_{2,m} \\ \mathring{b}_{3,m} \\ \mathring{b}_{4,m} \\ \mathring{b}_{5,m} \\ \mathring{b}_{6,m} \end{pmatrix} := \Psi^m \begin{pmatrix} \mathring{b}_1 \\ \mathring{b}_2 \\ \mathring{b}_3 \\ \mathring{b}_4 \\ \mathring{b}_5 \\ \mathring{b}_6 \end{pmatrix},$$

then $\mathring{b}_{i,m}$ is a representative of $b_{i,m}$. Thus, in order to keep track of braid sequences $\{b_{i,m}\}_{m \in \mathbb{N}}$, it is enough to keep track of Ψ^m .

Every entry of Ψ^m is a sum of compositions of $3m$ -maps. The image of a composition of $3m$ -maps is a solid torus. By Remarks 4.6 and 4.8, the radius of each solid torus appearing in Ψ^m decreases exponentially and converges to zero as $m \rightarrow \infty$.

From another view points, we consider ψ_H . Note that ψ_H is defined in step 4 of the proof of Lemma 4.4. The proof of Lemma 4.4 implies that

$$\mathring{b}_{i,m} \subset \psi_H^m(N(\mathcal{B}_\psi)) \cap \pi^{-1}(\partial S_i) \text{ for all } m \in \mathbb{N} \text{ and for all } i = 1, \dots, 6.$$

Let

$$B_{i,m} := \psi_H^m(N(\mathcal{B}_\psi)) \cap \pi^{-1}(\partial S_i).$$

Then, $B_{i,m}$ is the disjoint union of solid tori. More precisely, each solid torus in $B_{i,m}$ is the image of a composition of $3m$ -maps, appearing in Ψ^m . Conversely, for each composition of $3m$ -maps appearing in Ψ^m , the image is a solid torus contained in $B_{i,m}$. The radii of solid tori in $B_{i,m}$ are decreasing exponentially and are converging to zero as $m \rightarrow \infty$.

Since $\mathring{b}_{i,m} \subset B_{i,m}$ and $B_{i+1,m} \subset B_{i,m}$ for all $m \in \mathbb{N}$, there is a limit

$$B_{i,\infty} := \lim_{m \rightarrow \infty} B_{i,m} = \bigcap_{m \in \mathbb{N}} B_{i,m}.$$

Thus, $B_{i,\infty}$ is the union of infinite strands as a subset of $\pi^{-1}(\partial S_i)$ and

$$\lim_{m \rightarrow \infty} \mathring{b}_{i,m} = B_{i,\infty},$$

as a sequence of closed sets in $\pi^{-1}(\partial S_i)$.

Remark 4.10.

- (1) We have constructed a sequence of specific representatives $\{\mathring{b}_{i,m}\}_{m \in \mathbb{N}}$ such that

$$\lim_{m \rightarrow \infty} \mathring{b}_{i,m} = B_{i,\infty}.$$

For the purposes of extending the lamination to the singular and regular disks in Sections 4.3 and 4.4, we assume that the limit $B_{i,\infty}$ is a specific closed subset in $\pi^{-1}(\partial S_i)$.

- (2) Each strand of $B_{i,\infty}$ corresponds to an infinite sequence $\{f_m\}_{m \in \mathbb{N}}$ such that $f_1 \circ \cdots \circ f_{3m}$ appears in Φ^m for all $m \in \mathbb{N}$.

4.3. Lagrangian lamination on a singular disk. Let ψ be of generalized Penner type and let L be a Lagrangian submanifold which is carried by \mathcal{B}_ψ . In Section 4.2, on each singular disk S_i , we gave an inductive description of a sequence $\{b(\psi^m(L), S_i)\}_{m \in \mathbb{N}}$. There is a limit $B_{i,\infty}$ of the sequence. Moreover, the limit $B_{i,\infty}$ depends only on ψ and $B_{i,\infty}$ is independent to L . In this present subsection, we will construct a Lagrangian lamination $\mathcal{L}_i \subset \pi^{-1}(S_i)$ from $B_{i,\infty}$.

Remark 4.11. If ∂S_i is contained in the branch locus of \mathcal{B}_ψ^* , $B_{i,\infty}$ can be divided into two groups, as a braid b was divided into \bar{b} and \tilde{b} in the Step 1 of the proof of Lemma 4.4. We will construct \mathcal{L}_i from $B_{i,\infty} \cap \overline{\pi^{-1}(\mathring{S}_i)}$, which is one of two groups of $B_{i,\infty}$.

If ∂S_i is not contained in the branch locus of \mathcal{B}_ψ^* , then $B_{i,\infty} \subset \overline{\pi^{-1}(\mathring{S}_i)}$. In this case, we will construct a Lagrangian lamination from $B_{i,\infty} = B_{i,\infty} \cap \overline{\pi^{-1}(\mathring{S}_i)}$. Thus, we will simply say that the Lagrangian lamination is constructed from $B_{i,\infty} \cap \overline{\pi^{-1}(\mathring{S}_i)}$.

Lemma 4.12. *Let ψ be of generalized Penner type. For each singular disk S_i of \mathcal{B}_ψ , there is a Lagrangian lamination $\mathcal{L}_i \subset \overline{\pi^{-1}(\mathring{S}_i)}$, such that*

- (1) $\mathcal{L}_i \cap \pi^{-1}(\partial S_i)$ is the same braid with $B_{i,\infty} \cap \overline{\pi^{-1}(\mathring{S}_i)}$, where $B_{i,\infty}$ is the limit of a braid sequence, which depends only on ψ .
- (2) If L is a Lagrangian submanifold of M which is carried by \mathcal{B}_ψ , then for every $m \in \mathbb{N}$, there is a Lagrangian submanifold L_m which is Hamiltonian isotopic to $\psi^m(L)$ and $L_m \cap \overline{\pi^{-1}(\mathring{S}_i)}$ converges to \mathcal{L}_i as a sequence of closed subsets.

Proof. Let ψ be of generalized Penner type, i.e., $\psi = \delta_1 \circ \cdots \circ \delta_l$, where δ_k is a Dehn twist τ_i or σ_j^{-1} . We will use similar notation with the previous subsection, for example, S_i denotes a singular disk of \mathcal{B}_ψ , Ψ denotes a matrix corresponding to ψ , $\varphi_i : \pi^{-1}(\partial S_i) \xrightarrow{\sim} S^{n-1} \times \mathbb{D}^n$ denotes the identification induced from the fixed coordinate chart on S_i , and so on.

In this proof, first, we will construct $\mathcal{L}_i \subset \overline{\pi^{-1}(\overset{\circ}{S}_i)}$ satisfying the first condition, i.e., $\mathcal{L}_i \cap \pi^{-1}(\partial S_i) = B_{i,\infty} \cap \overline{\pi(\overset{\circ}{S}_i)}$. Then, we will show that the constructed \mathcal{L}_i satisfies the second condition.

Construction of \mathcal{L}_i . As we mentioned in Remark 4.10, a strand of $B_{i,\infty} \cap \overline{\pi(\overset{\circ}{S}_i)}$ is identified with an infinite sequence $\{f_m\}_{m \in \mathbb{N}}$ such that $f_1 \circ \cdots \circ f_{lk}$ appears in Ψ^k for all $k \in \mathbb{N}$. Note that we are assuming that $\psi = \delta_1 \circ \cdots \circ \delta_l$ for some positive number l . For each strand $\{f_m\}_{m \in \mathbb{N}}$ of $B_{i,\infty} \cap \overline{\pi^{-1}(\overset{\circ}{S}_i)}$, we will construct a Lagrangian submanifold of $\overline{\pi^{-1}(\overset{\circ}{S}_i)}$ whose boundary agrees with the strand $\{f_m\}_{m \in \mathbb{N}}$.

First, for a given strand $\{f_m\}_{m \in \mathbb{N}}$, let us assume that f_1 is of trivial type. Then, the strand is identified with a straight curve

$$\{(\theta, x_1, \dots, x_n) \mid \theta \in S^{n-1}\} \subset S^{n-1} \times \mathbb{D}^n \xrightarrow{\varphi_i} \pi^{-1}(\partial S_i),$$

where x_i is a constant. A subsequence $\{f_m\}_{m \geq 2}$ determines constants x_i . Let

$$D := \{(p, x_1, \dots, x_n) \mid p \in S_i\} \subset \mathbb{D}^n \times \mathbb{D}^n \xrightarrow{\varphi_i} \overline{\pi^{-1}(\overset{\circ}{S}_i)}.$$

Then, $\varphi_i(D)$ is a Lagrangian disk in $\overline{\pi^{-1}(\overset{\circ}{S}_i)}$, whose boundary agrees with the strands $\{f_m\}_{m \in \mathbb{N}}$.

Second, let us assume that f_1 is not of trivial type, but there exists $m \in \mathbb{N}$ such that f_m is of trivial type. Let $k > 1$ be the smallest number such that f_k is of trivial type appearing in $\{f_m\}_{m \in \mathbb{N}}$. Then, $\tilde{\psi} = \delta_{k_0} \circ \cdots \circ \delta_l \circ \delta_1 \circ \cdots \circ \delta_{k_0-1}$, where $k_0 \cong k \pmod{l}$, is of generalized Penner type such that $\mathcal{B}_{\tilde{\psi}}$ has a singular disk \tilde{S}_j , so that $\tilde{B}_{j,\infty}$, the limit of the braid sequence corresponding to $\tilde{\psi}$ and \tilde{S}_j , has a strand identified with $\{f_m\}_{m \geq k}$. Thus, there is a Lagrangian disk in $\pi^{-1}(\tilde{S}_j)$ whose boundary agrees with $\{f_m\}_{m \geq k}$. Let D denote the Lagrangian disk in $\pi^{-1}(\tilde{S}_j)$. Then, there is a connected component of

$$\left((\Phi_{1,1} \circ \delta_1) \circ \cdots \circ (\Phi_{k_0,1} \circ \delta_k) \right) (D) \cap \overline{\pi^{-1}(\overset{\circ}{S}_i)},$$

whose boundary is $\{f_m\}_{m \in \mathbb{N}}$, where $\Phi_{i,t}$ is a Hamiltonian isotopy mentioned mentioned in Section 4.1.

To summarize, if there is at least one map of trivial type in $\{f_m\}_{m \in \mathbb{N}}$, then we have a Lagrangian submanifold in $\overline{\pi^{-1}(\mathring{S}_i)}$, whose boundary agrees with $\{f_m\}_{m \in \mathbb{N}}$. Let $\mathcal{L}_{i,\infty}$ be the union of those Lagrangian submanifolds.

Finally, let us assume that for all $m \in \mathbb{N}$, f_m is not of trivial type. Then, for all $k \in \mathbb{N}$, we will construct a sequence $\{f_m^k\}_{m \in \mathbb{N}}$ for each $k \in \mathbb{N}$, satisfying

- (1) $\{f_m^k\}_{m \in \mathbb{N}}$ is a strand of $B_{i,\infty}$,
- (2) if $m \leq kl$, then $f_m^k = f_m$,
- (3) there exists a constant $N_k \in \mathbb{N}$ such that $f_{kl+N_k}^k$ is of trivial type.

If there is a sphere having 2 or more plumbing points, there exists a sequence $\{f_m^k\}_{m \in \mathbb{N}}$ for all $k \in \mathbb{N}$. This is because of the following:

We note that the finite sequence $\{f_t\}_{1 \leq t \leq kl}$ explains a contribution of the braid on a singular disk S_{i_0} on the construction of the braid on a singular disk S_{j_0} when one applies ψ^k . In other words, from the view point of Remark 4.6, there is a connected component of $\psi^k(\overline{\pi^{-1}(\mathring{S}_i)}) \cap \pi^{-1}(S_{j_0})$ or $\psi^k(\pi^{-1}(\pi(N_p))) \cap \pi^{-1}(S_{j_0})$, where p is the center of S_{i_0} and N_p is the neck at p , such that the boundary of the connected component is the image of $f_1 \circ \cdots \circ f_{kl}$.

If there exists a sphere having 2 or more plumbing points, the Dehn twist along the sphere appears in ψ , because of our assumption that every Dehn twist appears in ψ . Let δ_i be the Dehn twist. For any plumbing points p and q of the sphere, $\delta_i(\pi^{-1}(\pi(N_p)))$ intersects $\pi^{-1}(S_q^+)$, if the sphere is positive, or $\pi^{-1}(S_q^-)$, otherwise. Thus, there is a map of trivial type in Δ_i , the matrix corresponding to δ_i .

For a sufficiently large N , $(\psi^N \circ \delta_1 \circ \cdots \circ \delta_i)(\pi^{-1}(\pi(N_p)))$ intersects $\pi^{-1}(S_{j_0})$. We can prove this by observing that $(\psi^N \circ \delta_1 \circ \cdots \circ \delta_{i-1})(\pi^{-1}(S_q^\pm)) \cap \pi^{-1}(S_{j_0}) \neq \emptyset$ for some sufficiently large N . Thus, there is a finite sequence of functions $\{g_j\}_{1 \leq j \leq Nl+i}$ such that g_j is an entry of $\Delta_{j'}$, the matrix corresponding to $\delta_{j'}$, where $j' \cong j \pmod{l}$, and

the image of $g_1 \circ \cdots \circ g_{Nl+i}$ is identified to the boundary of a connected component of $(\psi^N \circ \delta_1 \circ \cdots \circ \delta_i)(\pi^{-1}(\pi(N_p))) \cap \pi^{-1}(S_{j_0})$. Moreover, we can extend the finite sequence $\{g_j\}_{1 \leq j \leq Nl+i}$ to an infinite sequence $\{g_j\}_{j \in \mathbb{N}}$ such that $\{g_j\}_{j \in \mathbb{N}}$ appears in $B_{i,\infty}$. Then, by setting $f_{kl+j}^k = g_j$, we prove the existence of $\{f_m^k\}_{m \in \mathbb{N}}$.

We obtain a strand $\{f_m^k\}_{k \in \mathbb{N}}$ for each $k \in \mathbb{N}$. These strands converge to $\{f_m\}_{m \in \mathbb{N}}$ as $k \rightarrow \infty$. Moreover, by definition of $\mathcal{L}_{i,\infty}$, the boundary of $\mathcal{L}_{i,\infty}$ contains strands $\{f_m^k\}_{m \in \mathbb{N}}$ for all $k \in \mathbb{N}$. Thus, the strand $\{f_m\}_{m \in \mathbb{N}}$ is contained in the boundary of \mathcal{L}_i , where $\mathcal{L}_i = \overline{\mathcal{L}_{i,\infty}}$, the closure of $\mathcal{L}_{i,\infty}$, i.e., the closure of $\mathcal{L}_{i,\infty}$.

If there is no sphere with 2 or more plumbing points, then there is only one positive and one negative sphere intersecting at only one point because we are working on a connected plumbing space. For the case, we can construct a Lagrangian lamination \mathcal{L} on M by spinning. Then, $\mathcal{L}_i := \mathcal{L} \cap \pi^{-1}(S_i)$ is a Lagrangian lamination which we want to construct.

Remark 4.13. We note that, if there is no sphere with 2 or more plumbing points, then we can construct \mathcal{L} without using singular and regular disks.

Convergence to \mathcal{L}_i . Let $L_m := \psi_H^m(L)$. We defined ψ_H in Step 4 of the proof of Lemma 4.4. We will prove that $L_m \cap \overline{\pi^{-1}(\mathring{S}_i)}$ converges to \mathcal{L}_i .

First, we will show that

$$(4.13) \quad \lim_{m \rightarrow \infty} L_m \cap \overline{\pi^{-1}(\mathring{S}_i)} = \lim_{m \rightarrow \infty} (\psi_H^m(N(\mathcal{B}_\psi)) \cap \overline{\pi^{-1}(\mathring{S}_i)}).$$

Since $\psi_H(N(\mathcal{B}_\psi)) \subset N(\mathcal{B}_\psi)$,

$$\psi_H^{m+1}(N(\mathcal{B}_\psi)) \cap \overline{\pi^{-1}(\mathring{S}_i)} \subset \psi_H^m(N(\mathcal{B}_\psi)) \cap \overline{\pi^{-1}(\mathring{S}_i)}.$$

Thus, there exists the limit

$$\lim_{m \rightarrow \infty} (\psi_H^m(N(\mathcal{B}_\psi)) \cap \overline{\pi^{-1}(\mathring{S}_i)}) = \cap_m (\psi_H^m(N(\mathcal{B}_\psi)) \cap \overline{\pi^{-1}(\mathring{S}_i)}).$$

If we equip a Riemannian metric g on M , then $d_H(\psi_H^m(\mathcal{B}_\psi), \psi_H^m(N(\mathcal{B}_\psi)))$, where d_H is the Hausdorff metric induced from g , converges to zero as $m \rightarrow \infty$ because of the same reason that $B_{i,m} := \psi_H^m(N(\mathcal{B}_\psi)) \cap \pi^{-1}(\partial S_i)$ converges to an infinite braid $B_{i,\infty}$ in the last part of Section 4.2.

Since for a large N_0 , L_{N_0} intersects $\pi^{-1}(S_j)$ for any singular disk S_j , $L_{m+N_0} \cap \overline{\pi^{-1}(\mathring{S}_i)}$ intersects every connected component of $\psi_H^m(N(\mathcal{B}_\psi)) \cap \overline{\pi^{-1}(\mathring{S}_i)}$. Thus,

$$0 \leq \lim_{m \rightarrow \infty} d_H(L_{m+N_0} \cap \overline{\pi^{-1}(\mathring{S}_i)}, \psi_H^m(N(\mathcal{B}_\psi))) \leq \lim_{m \rightarrow \infty} 2d_H(\psi_H^m(\mathcal{B}_\psi), \psi_H^m(\mathcal{B}_\psi)) = 0.$$

This proves Equation (4.13). Let \mathbb{L}_i be the limit in Equation (4.13).

Second, we show that \mathbb{L}_i is \mathcal{L}_i . By the construction of \mathcal{L}_i , we know that

$$\mathcal{L}_i \subset \psi_H^m(N(\mathcal{B}_\psi)) \cap \overline{\pi^{-1}(\mathring{S}_i)} \text{ for every } m \in \mathbb{N}.$$

It implies that $\mathcal{L}_i \subset \mathbb{L}_i$. Moreover,

$$\mathcal{L}_i \cap \pi^{-1}(\partial S_i) = \mathbb{L}_i = B_{i,\infty} \cap \overline{\pi^{-1}(\mathring{S}_i)}.$$

Because every connected component of \mathbb{L}_i has a boundary on ∂S_i , this shows $\mathcal{L}_i = \mathbb{L}_i$. □

4.4. Lagrangian lamination on a regular disk. In the previous subsection, we constructed Lagrangian laminations on singular disks, when boundary data for singular disks are given. In the present subsection, first, we will define boundary data for a regular disk. Then, second, we will construct Lagrangian laminations on regular disks from the given data. Finally, we will prove Theorem 1.3 as a corollary of Lemmas 4.12 and 4.15.

Before defining the boundary data, we remark that, by Remark 4.2, $\overline{\pi^{-1}(\mathring{R}_i)}$ is symplectomorphic to $DT^*\mathcal{D}$, where \mathcal{D} is a disk.

We define a data $c_{j,m}$ on the boundary of a regular disk R_j for $\psi^m(L)$, by setting

$$c_{j,m} := L_m \cap \pi^{-1}(\partial R_j).$$

We defined L_m in the proof of Lemma 4.12. Note that $c_{j,m}$ is a closed subset, not a class of a closed subset.

To obtain a limit of $c_{j,m}$, we consider

$$C_{j,m} := \psi_H^m(N(\mathcal{B}_\psi)) \cap \pi^{-1}(\partial R_j),$$

as we did in Section 4.2. Since $\psi_H^1(N(\mathcal{B}_\psi)) \subset N(\mathcal{B}_\psi)$, $C_{j,m+1} \subset C_{j,m}$. Moreover, $C_{j,m}$ is the union of solid tori (resp. $S^{n-1} \times \mathbb{D}^n$) in $\pi^{-1}(\partial R_j)$ for the case $n = 2$ (resp. of general n). If a symplectic manifold M is equipped with a Riemannian metric g , we can measure the radii of solid tori in $C_{j,m}$. The radii decrease exponentially and converge to zero as $m \rightarrow \infty$, because of the same reason that radii of solid tori comprising $B_{i,m}$ decrease exponentially and converge to zero as $m \rightarrow \infty$ in Section 4.2. Then, the limit of $c_{j,m}$ is given by

$$C_{j,\infty} = \lim_{m \rightarrow \infty} C_{j,m} = \bigcap_m C_{j,m}.$$

The next step is to smooth R_j . A regular disk R_j has corners. We will replace R_j with a smooth disk R'_j . This is because, at the end, a Lagrangian lamination will be given as graphs of closed sections. By smoothing R_j , it will be easier to handle closed sections.

To smooth R_j , we subtract a tubular neighborhood $N(\partial R_j) \subset R_j$ from R_j . Let $R'_j := R_j \setminus N(\partial R_j)$. Then, R'_j is a smooth disk. We replace R_j with R'_j . To finish smoothing, we need to determine boundary data for R'_j from $c_{j,m}$.

Each connected component of $c_{j,m}$ can be identified with a section of a bundle $\pi^{-1}(\partial R_j)$ over ∂R_j . We can extend this section to a closed section of a bundle $\pi^{-1}(N(\partial R_j))$ over

$N(\partial R_j)$ by computations. Then, the graph of the extended section is a Lagrangian submanifold of $\pi^{-1}(N(\partial R_j))$. The boundary of the Lagrangian submanifold on $\partial R'_j$ makes up the boundary data for R'_j .

From now, we assume that a regular disk R_j is a smoothed disk. Lemma 4.14 claims that for a given data $c_{j,m}$ on a smoothed regular disk R_j , we can construct a Lagrangian submanifold $N_{j,m} \subset \overline{\pi^{-1}(\overset{\circ}{R}_i)}$ such that $\partial N_{j,m} = c_{j,m} \cap \pi^{-1}(\overset{\circ}{R}_i)$.

Lemma 4.14. *Let Q be a closed subset of $\partial T^*\mathbb{D}^n$ such that there exists a Lagrangian submanifold $L \subset T^*\mathbb{D}^n$ so that $L \cap \partial T^*\mathbb{D}^n = Q$ and L is a union of Lagrangian disks transverse to fibers. Then, we can construct a Lagrangian submanifold L uniquely up to Hamiltonian isotopy through Lagrangians transverse to the fibers.*

To prove Lemma 4.14, we will use the following: in Lemma 4.14, if an identification $\varphi : \partial T^*\mathbb{D}^n \xrightarrow{\sim} S^{n-1} \times \overset{\circ}{\mathbb{D}}^n$ is induced from a coordinate chart on \mathbb{D}^n , $\varphi(Q)$ represent the trivial braid because L is a union of Lagrangian disks.

Proof of Lemma 4.14. The proof of Lemma 4.14 consists of two parts, the construction of L and the uniqueness of L .

Construction. We start the proof with the simplest case, i.e., when Q is connected. In other words, Q represents the braid with only one strand.

By fixing coordinate charts on \mathbb{D}^n , we can write down Q as a section of a disk bundle $\partial T^*\mathbb{D}^n$ over $\partial \mathbb{D}^n$, i.e.,

$$Q := \{f_1(x_1, \dots, x_n)dx_1 + \dots + f_n(x_1, \dots, x_n)dx_n \mid x_1^2 + \dots + x_n^2 = 1\}.$$

Then, the simplest case is proved by determining a function $\phi : \mathbb{D}^n \rightarrow \mathbb{R}$ such that $d\phi = f_1dx_1 + \dots + f_n dx_n$ on $\partial \mathbb{D}^n$. The graph of $d\phi$ is a Lagrangian submanifold which we would like to find. Note that there are infinitely many ϕ satisfying the conditions,

but the Hamiltonian isotopy class of the graph of $d\phi$ is unique through Lagrangians transverse to the fibers.

If Q has 2 or more connected components l_i , then we can write l_i as a section over $\partial\mathbb{D}^n$. For each i , we need to determine functions $\phi_i : \mathbb{D}^n \rightarrow \mathbb{R}$ such that $d\phi_i$ agrees with l_i on $\partial\mathbb{D}^n$. Moreover, to avoid self-intersection, we need $d\phi_i \neq d\phi_j$ for all $i \neq j$ everywhere. Then, the union of graphs of $d\phi_i$ on $T^*\mathbb{D}^n$ is a Lagrangian submanifold L which we want to construct.

We discuss with the simplest non-trivial case, i.e., Q has two connected components l_0 and l_1 , and the dimension $2n = 4$. Without loss of generality, we assume that l_0 is the zero section. Then, we can assume that $\phi_0 \equiv 0$. We only need to determine ϕ_1 such that $d\phi_1$ does not vanish everywhere.

We assume that there exists ϕ_1 satisfying the conditions. Then, we will collect combinatorial data from ϕ_1 , and we will construct a function $\tilde{\phi}_1$ satisfying conditions, from the combinatorial data. Through this, we will see what combinatorial data we need. We will end the construction part by obtaining the combinatorial data from the given Q .

For convenience, we will use the polar coordinates instead of the (x, y) -coordinate on \mathbb{D}^2 . Let r_0 be a small positive number. We restrict the function ϕ_1 on $[r_0, 1] \times S^1$. On $\{1\} \times S^1 = \partial\mathbb{D}^2$ agrees with l_1 . On $\{r_0\} \times S^1$, $d\phi_1$ is approximately a constant section $adx + bdy = a(\cos\theta dr - r_0 \sin\theta d\theta) + b(\sin\theta dr + r_0 \cos\theta d\theta)$, where $d\phi_1(0, 0) = adx + bdy$ and (x, y) are the standard coordinate charts of \mathbb{D}^2 . We remark that on $\{r_0\} \times S^1$, the pair of graphs of $d\phi_i|_{\{r_0\} \times S^1}$ represents the trivial braid under the identification induced from the (x, y) -coordinates. Then, the pair $(d\phi_0 \equiv 0, d\phi_1)$ implies an isotopy between two representatives of the trivial braid on $[r_0, 1] \times S^1$.

For every $r_* \in [r_0, 1]$, we can find all local maxima and minima of a function

$$\theta \mapsto \phi_1(r_*, \theta).$$

We mark (r_*, θ_*) as a red (resp. blue) point if the above function has a local maxima (resp. minima) at θ_* . If $r_* = 1$, there are same number of red/blue marked points on $\{1\} \times S^1$, and there are only one red/blue marked point on $\{r_0\} \times S^1$. On $[r_0, 1] \times S^1$, we have a collection \mathcal{C} of curves shaded red and blue. If a curve in \mathcal{C} is not a circle, then the curve has two end points on the boundary of $[r_0, 1] \times S^1$. There are exactly two curves connecting both boundary components of $[r_0, 1] \times S^1$, and those two curves have end points of the same color.

If we write $d\phi_1 = fd\theta + gdr$, then f is zero on curves in \mathcal{C} . Since $d\phi_1$ does not vanish, g cannot be zero on the curves. Thus, we can assign the sign of g for each curve. Figure 9 is an example of a collection \mathcal{C} .

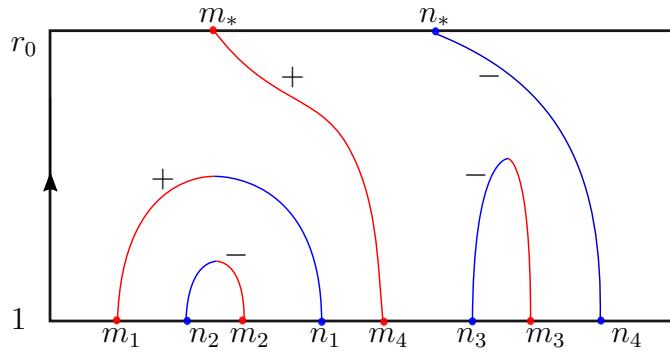

FIGURE 9. Example of a collection \mathcal{C} on $[r_0, 1] \times S^1$.

Conversely, if we have a collection \mathcal{C} of curves such that each curve is shaded red and blue and is equipped with a sign, then we can draw a graph of $\tilde{\phi}_1$ roughly. This is because, the collection \mathcal{C} determines the sign of horizontal directional derivative of $\tilde{\phi}_1$, i.e., $d\tilde{\phi}_1(\partial_\theta)$ on every point of $[r_0, 1] \times S^1$, and vertical directional derivative of $\tilde{\phi}_1$, i.e., $d\tilde{\phi}_1(\partial_r)$ on the curves. From these, one obtains a (rough) graph of $\tilde{\phi}_1$. Thus, in order to determine a function ϕ_1 , it is enough to determine a collection \mathcal{C} of curves in $[r_0, 1] \times S^1$ from the given Q .

For the given Q , we assume that a connected component l_0 of Q is the zero section without loss of generality. For the other connected component l_1 , one has $f_1, g_1 :$

$S^1 \rightarrow \mathbb{R}$ such that l_1 is the graph of $f_1 d\theta + g_1 dr$ on $\{1\} \times S^1 = \partial\mathbb{D}^2$. We know that Q represents the trivial braid with respect to the standard (x, y) -coordinate of \mathbb{D}^2 . Thus, there is an isotopy $\Gamma : [r_0, 1] \times S^1 \rightarrow \mathbb{D}^2$ such that

$$\Gamma(1, \theta) = (f(\theta), g(\theta)), \quad \Gamma(r_0, \theta) = (Ar_0 \cos \theta, A \sin \theta)$$

$$\Gamma(t, \theta) \neq (0, 0) \text{ for all } (t, \theta) \in [r_0, 1] \times S^1,$$

where A is a constant.

For every $r \in [r_0, 1]$, let $\gamma_r(\theta) = \Gamma(r, \theta)$. Then, γ_r is a closed curve in \mathbb{D}^2 , for all r . Moreover, Γ is a path connecting γ_1 and γ_{r_0} in the loop space of \mathbb{D}^2 without touching the origin.

We mark (r, θ) on $[r_0, 1] \times S^1$ as a red (resp. blue) point if $\gamma_r(\theta)$ intersects dr -axis from right to left (resp. from left to right). These marked points comprise curves in $[r_0, 1] \times S^1$, and we have a collection \mathcal{C} of curves, shaded red and blue, in $[r_0, 1] \times S^1$. We know that γ_1 has an even number of intersection points. When r decreases, there is a series of creations/removes of intersection points, which are given by finger moves along dr -axis. Each finger move does not touch the origin. Thus, for a curve in \mathcal{C} , every intersection point composing the curve lies on either the positive dr -axis or the negative dr -axis. Then, we can assign a sign for each curve in \mathcal{C} .

Figure 10 is an example of Γ , corresponding to the case described by Figure 9. The upper left of Figure 10 is γ_1 and the upper right is γ_{r_0} . Through the first arrow, we observe a finger move removing two intersection points. Those two intersection points correspond to m_2 , a local maxima shaded red, and n_2 , a local minima shaded blue. Thus, we obtain a curve connecting m_2 and n_2 in Figure 9. Moreover, the intersection points lie in the negative part of the dr -axis. Thus, we assign a negative sign to the curve. Similarly, we observe there are finger moves removing intersection points. We obtain curves connecting m_i and n_i for $i = 1, 2$, and 3 in Figure 9. After

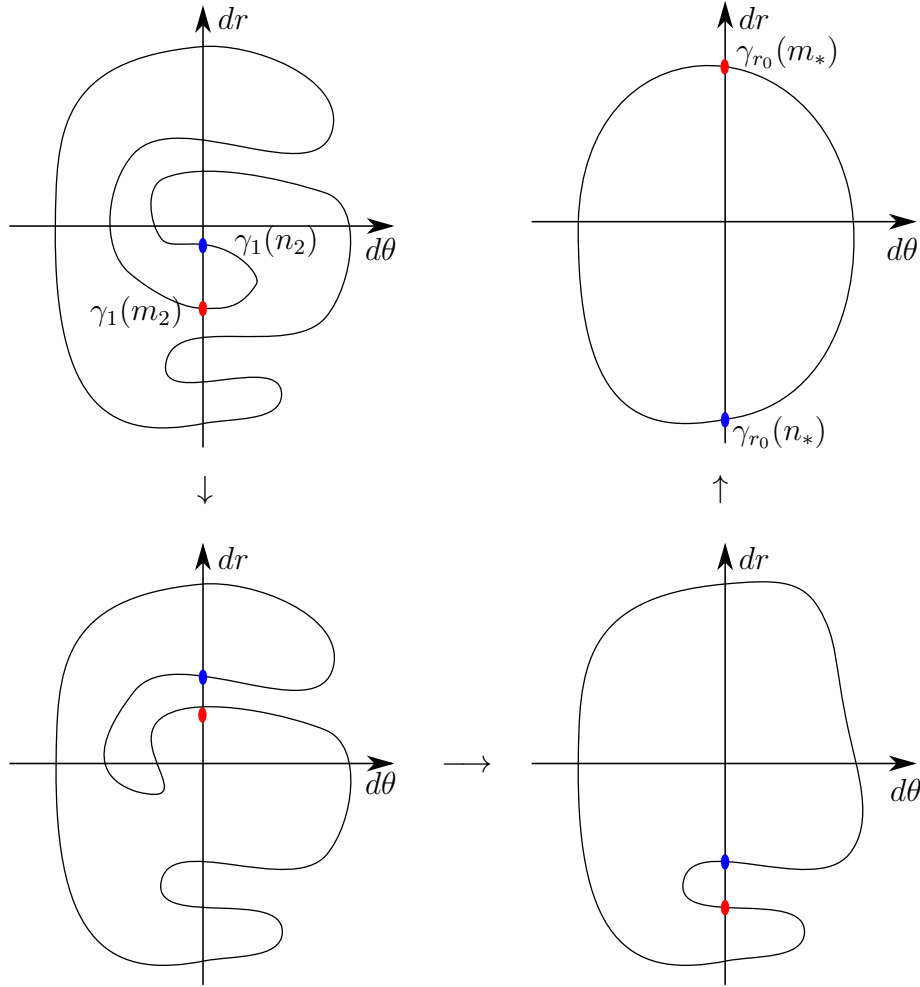

FIGURE 10. Creation of a collection \mathcal{C} .

the finger moves, there are only two intersection points corresponding to m_* and n_* , and we obtain curves connecting m_4 (resp. n_4) and m_* (resp. n_*).

We have constructed a collection \mathcal{C} of curves on $[r_0, 1] \times S^1$ from an isotopy Γ . Thus, we can obtain a function $\phi_1 : [r_0, 1] \times S^1 \rightarrow \mathbb{R}$. In order to complete the proof, we need to extend ϕ_1 into a small disk with radius r_0 . We have

$$\phi_1(x, y) = Ar \sin \theta = Ay$$

on the small disk.

The situation for the general case is analogous. If Q has more connected components l_i for $i = 0, \dots, k$, then we have to determine $\phi_i : \mathbb{D}^2 \rightarrow \mathbb{R}$ such that $d\phi_i = l_i$ on $\partial\mathbb{D}^2$, and $d\phi_i \neq d\phi_j$ for all $i \neq j$. We fix an isotopy Γ , and obtain a collection \mathcal{C} of curves on $[r_0, 1] \times S^1$ from Γ . Each curve in \mathcal{C} encodes restrictions on $d\phi_i - d\phi_j$ for some i and j . More precisely, $(\phi_i - \phi_j)$ has a local maxima (resp. minima) in the horizontal direction, only at a point of a curve shaded red (resp. blue), and $(d\phi_i - d\phi_j)(\partial_r)$ has the sign assigned on the curve. For the case of general dimension $2n$, we obtain combinatorial data from Q , i.e., a collection of curves on $[r_0, 1] \times S^{n-1}$ assigned a sign, and construct functions on \mathbb{D}^n from the combinatorial data.

Uniqueness. Recall that the construction consists of three steps. First, we choose an isotopy Γ connecting Q and the trivial representative of the trivial braid. Then, we obtained a collection \mathcal{C} of curves from Γ , such that each curve encodes restrictions on $d\phi_i - d\phi_j$. The last step is to construct a set of functions $\{\phi_i : \mathbb{D}^n \rightarrow \mathbb{R}\}$.

The construction depends on choices in the first and last steps. More precisely, for the first step, the choice of isotopy Γ is not unique. If we choose an isotopy Γ , then there is a unique collection \mathcal{C} . However, a set $\{\phi_i\}$ of functions, which is constructed from the collection \mathcal{C} , is not unique. We will show that the Hamiltonian isotopy class of L , through Lagrangians transverse to the fibers, is independent to those choices.

First, we discuss the choice in the third step. Let us assume that we have a collection \mathcal{C} of curves in $[r_0, 1] \times S^{n-1}$ and two sets of functions $\{\phi_i\}_i$ and $\{\zeta_i\}_i$ satisfying the restrictions encoded by \mathcal{C} . Then, by setting $\eta_{i,t} := (1-t)\phi_i + t\zeta_i$, we obtain a family of sets of functions such that every member of the family satisfies the restrictions encoded by \mathcal{C} .

Let L_t be the Lagrangian submanifold corresponding to $\{\eta_{i,t}\}$ for a fixed t . Then, L_t is a Lagrangian isotopy connecting L_0 , corresponding to $\{\phi_i\}$, and L_1 , corresponding to $\{\zeta_i\}$. Since L_t is a disjoint union of Lagrangian disks in $T^*\mathbb{D}^n$, L_0 and L_1 are

Hamiltonian isotopic. Thus, the Hamiltonian class of L through Lagrangians transverse to the fibers is independent of the choice of functions for the third step of the construction.

Before discussing the choice of the first step, note that a continuous change on a collection \mathcal{C} does not make a change on the Hamiltonian isotopy class. More precisely, let $\mathcal{C}_0 = \{\gamma_1, \dots, \gamma_N\}$ be a collection of curves and let $\{\phi_i\}$ be a set of functions corresponding to \mathcal{C}_0 . If $\{\gamma_{k,t}\}$ is a continuous family of curves with respect to t such that $\gamma_{k,0} = \gamma_k$ for all k , then we can obtain a continuous family $\{\phi_{1,t}, \dots, \phi_{N,t}\}$ such that $\phi_{i,0} = \phi_i$ and $\{\phi_{1,t}, \dots, \phi_{N,t}\}$ corresponds to $\mathcal{C}_t := \{\gamma_{1,t}, \dots, \gamma_{N,t}\}$. Then, it is easy to check that the Hamiltonian isotopy class of the union of graphs of $d\phi_{i,t}$ in $T^*\mathbb{D}^n$, through Lagrangians transverse to the fibers, is independent to t .

Finally, we will discuss the choice of Γ . Let Γ_0 and Γ_1 be two isotopies obtained from the given Q in the first step. Then, we can understand Γ_0 and Γ_1 as paths on the loop space of the configuration space of $\mathring{\mathbb{D}}^n$. Since the loop space is simply connected, there is a continuous family $\{\Gamma_t\}_{t \in [0,1]}$ connecting γ_0 and γ_1 .

Let \mathcal{C}_t be the collection of curves obtained from Γ_t and let $\{\phi_i\}$ be a set of functions constructed from \mathcal{C}_0 . There is $\{\phi_{i,t}\}$ corresponding to \mathcal{C}_t such that $\phi_{i,0} = \phi_i$. Then, if L_t is the union of graphs of $d\phi_{i,t}$, then the Hamiltonian class of L_t is independent to t . This shows the uniqueness of L , up to Hamiltonian isotopy, through Lagrangians transverse to the fibers. \square

For a smoothed regular disk R_j , there is a sequence of data $c_{j,m}$ for each $m \in \mathbb{N}$. Then, we can construct a sequence of Lagrangian submanifolds $N_{j,m} \subset \overline{\pi^{-1}(\mathring{R}_j)}$ such that $N_{j,m} \cap \overline{\partial\pi^{-1}(\mathring{R}_j)} = c_{j,m}$. The following lemma, Lemma 4.15, claims that we can construct $N_{j,m}$ wisely, so that $N_{j,m}$ converges to a Lagrangian lamination \mathcal{N}_j as m goes to ∞ .

Lemma 4.15. *It is possible to construct $N_{j,m} \subset \overline{\pi^{-1}(\mathring{R}_j)}$ so that the sequence $N_{j,m}$ converges to a Lagrangian lamination $\mathcal{N}_j \subset \overline{\pi^{-1}(\mathring{R}_j)}$ as $m \rightarrow \infty$.*

Proof. Let the boundary condition $c_{j,m}$ be the set $\{l_{1,m}, \dots, l_{N_{m,m}}\}$, where $l_{i,m}$ is a connected component of $c_{j,m}$, or equivalently, $l_{i,m}$ is a strand of the braid represented by $c_{j,m}$. We defined $C_{j,m}$ as a disjoint union of solid tori in $\pi^{-1}(\partial R_j)$ at the beginning of the present subsection. Then, we can divide $c_{j,m}$ into a partition, so that $l_{i,m}$ and $l_{j,m}$ are in the same subset if and only if $l_{i,m}$ and $l_{j,m}$ are in the same solid torus (resp. $S^{n-1} \times \mathbb{D}^n$ for a higher dimensional case) in $C_{j,m}$. After that, we randomly choose a connected component $l_{s,m}$ from each subset of the partition.

By Lemma 4.14, there is $\phi_{s,m} : R_j \rightarrow \mathbb{R}$ such that $d\phi_{s,m} = l_{s,m}$ on ∂R_j . Then, the graph of $d\phi_{s,m}$ is a Lagrangian disk in $\overline{\pi^{-1}(\mathring{R}_i)}$. We can choose a neighborhood $N(\phi_{s,m})$ of the graph of $d\phi_{s,m}$ in $\overline{\pi^{-1}(\mathring{R}_i)}$, such that $N(\phi_{s,m}) \simeq T^*\mathbb{D}^n$ and $N(\phi_{s,m}) \cap \pi^{-1}(\partial R_j)$ is the torus in $C_{j,m}$ containing $l_{s,m}$. Moreover, we can assume that

$$d_H(N(\phi_{s,m}), \text{the graph of } d\phi_{s,m}) < 2r^m,$$

where d_H is the Hausdorff metric induced by a fixed Riemannian metric.

We apply Lemma 4.14 to $\{l_{t,m+1} \in c_{j,m+1} \mid l_{t,m+1} \subset N(\phi_{s,m})\}$ in $N(\phi_{s,m}) \simeq T^*\mathbb{D}^n$. Then, we can construct $\phi_{t,m+1} : R_j \rightarrow \mathbb{R}$ such that $d\phi_{t,m+1} = l_{t,m+1}$ on ∂R_j and the graph of $d\phi_{t,m+1}$ is contained in $N(\phi_{s,m+1})$. We repeat this procedure inductively on $m \in \mathbb{N}$.

Let l be a strand of $C_{j,\infty}$. Then, there is a sequence $l_{i_m,m} \in c_{j,m}$ such that $l_{i_m,m}$ converges to l . If we construct $\phi_{i_m,m}$ by repeating the above procedure, we know that

$$d_H(d\phi_{i_m,m}, d\phi_{i_n,n}) < 4r^{\max(m,n)}.$$

Thus, $d\phi_{i_m,m}$ converges. Moreover, by assuming that $\phi_{i_m,m}(p) = 0$ for every i and m , where p is a center of R_j , $\phi_{i_m,m}$ converges to a function ϕ . The graph of $d\phi$ is a

Lagrangian disk in $\overline{\pi^{-1}(\mathring{R}_j)}$ such that whose boundary is l , the stand of $C_{j,\infty}$. The union of graphs of $d\phi$ is the Lagrangian lamination \mathcal{N}_j which $N_{j,m}$ converges to. \square

Proof of Theorem 1.3. By Lemma 4.12, there is a Lagrangian lamination \mathcal{L}_i in $\overline{\pi^{-1}(\mathring{S}_i)}$ and by Lemma 4.15, there is a Lagrangian lamination \mathcal{N}_j in $\overline{\pi^{-1}(\mathring{R}_j)}$. Moreover, every Lagrangian lamination agrees with each other along boundaries, thus we can glue them. Then we obtain a Lagrangian lamination \mathcal{L} in M . \square

4.5. A generalization. In the previous sections, we assumed that ψ is of generalized Penner type. In the present subsection, we discuss a symplectic automorphism $\psi : (M, \omega) \rightarrow (M, \omega)$, not necessarily to be of generalized Penner type, with some assumptions.

First, we assume that there is a Lagrangian branched submanifold \mathcal{B}_ψ such that $\psi(\mathcal{B}_\psi)$ is (weakly) carried by \mathcal{B}_ψ . The proof of Lemma 3.17 carries over with no change. Thus, if a Lagrangian submanifold L is (weakly) carried by \mathcal{B}_ψ , then $\psi(L)$ is carried by \mathcal{B}_ψ .

As mentioned in Section 4.1, we assume that \mathcal{B}_ψ^* admits a decomposition into a union of finite number of singular disks $S_i \simeq \mathbb{D}^n$ and regular disks $R_j \simeq \mathbb{D}^n$.

Proof of Theorem 1.4. First, we define data on the boundary of each singular and regular disk, in the same way we did for the case of ψ of generalized Penner type. Then, on a regular disk R_j , the proofs of Lemma 4.14 and Lemma 4.15 carry over with no change. Thus, we can construct a Lagrangian lamination on $\pi^{-1}(R_j)$.

On a singular disk S_i , we define the boundary data in the same way. In other words, the boundary data is defined by the isotopy class of $\psi^m(L) \cap \pi^{-1}(\partial S_i)$. We also can obtain a matrix Ψ , which explains how the sequences of braids are constructed inductively. However, the rest of the proof of Lemma 4.12 does not carry over. This is because in the proof of Lemma 4.12, functions of trivial type have a key role. To use the same proof, we need to show that there are enough functions of trivial type.

However, the assumptions cannot imply the existence of enough functions of trivial type.

For a singular disk S_i , let $\{f_m\}_{m \in \mathbb{N}}$ be a strand of the limit braid on S_i . We note that each strand can be identified to an infinite sequence of functions. We forget specific functions f_m , but remember their types. Then, we obtain a sequence of types. The sequence of types determines the “shape” of strand, for example, how many times the strand is rotated.

We can construct a symplectomorphism ϕ which is of generalized Penner type such that \mathcal{B}_ϕ has a singular disk S so that the limit braid assigned on S has a strand of the same shape. In Section 4.3, we constructed a Lagrangian submanifold $L_0 \subset \overline{\pi^{-1}(\dot{S})}$ such that ∂L_0 is the strand. Since $\overline{\pi^{-1}(\dot{S})} \simeq \overline{\pi^{-1}(\dot{S}_i)}$, we assume that L_0 is a Lagrangian submanifold in $\overline{\pi^{-1}(\dot{S}_i)}$ and ∂L_0 has the same shape to the strand which we choose. By scaling and translating L_0 inside $\overline{\pi^{-1}(\dot{S}_i)}$, we obtain a Lagrangian submanifold whose boundary agrees with the strand.

The rest of the proof is the same as the proof of Theorem 1.3. □

5. APPLICATION ON THE LAGRANGIAN FLOER HOMOLOGY

In this section, we will give an application of the previous sections on Lagrangian Floer homology. More precisely, we will prove Theorem 1.5.

5.1. Setting. In the present subsection, we will explain terminology in Theorem 1.5.

In Section 5, we assume that our symplectic manifold M is a plumbing space $M = P(\alpha_1, \dots, \alpha_m, \beta_1, \dots, \beta_l)$ of Penner type defined as follows:

Definition 5.1. A plumbing space $M = P(\alpha_1, \dots, \alpha_m, \beta_1, \dots, \beta_l)$ is of *Penner type* if α_i and β_j satisfy

- (1) $\alpha_1, \dots, \alpha_m$ and β_1, \dots, β_l are n -dimensional spheres,
- (2) $\alpha_i \cap \alpha_j = \emptyset$, and $\beta_i \cap \beta_j = \emptyset$, for all $i \neq j$.

Note that $P(\alpha_1, \dots, \alpha_m, \beta_1, \dots, \beta_l)$ is defined in Section 2.1.

From now on, we will define an involution $\eta : M \xrightarrow{\sim} M$. In Section 5.2, we will use η to prove Theorem 1.5.

*Involution on T^*S^n* : First, we will define an involution η_0 on T^*S^n . Let

$$S^n = \{x \in \mathbb{R}^{n+1} \mid |x| = 1\},$$

$$T^*S^n = \{(x, y) \in S^n \times \mathbb{R}^{n+1} \mid x \in S^n, \langle x, y \rangle = 0\}.$$

Then, we define $\eta_0 : T^*S^n \xrightarrow{\sim} T^*S^n$ as follow:

$$\eta_0(x_1, \dots, x_{n+1}, y_1, \dots, y_{n+1}) = (x_1, x_2, -x_3, \dots, -x_{n+1}, y_1, y_2, -y_3, \dots, -y_{n+1}).$$

Let

$$S = \{(\cos \theta, \sin \theta, 0, \dots, 0) \in S^n \mid \theta \in [0, 2\pi]\},$$

$$T^*S = \{(\cos \theta, \sin \theta, 0, \dots, 0, -r \sin \theta, r \cos \theta, 0, \dots, 0) \mid \theta \in [0, 2\pi], r \in \mathbb{R}\} \subset T^*S^n.$$

Then, it is easy to check that $\eta_0^{fixed} = T^*S$.

Involution associated to M : First, we will construct an involution η_{α_i} and η_{β_j} on $T^*\alpha_i$ and $T^*\beta_j$ for every i and j . For each α_i , we will choose an embedded circle $S_{\alpha_i} \subset \alpha_i$ such that S_{α_i} contains every plumbing point of α_i . Then, there is a symplectic isomorphism $\phi_{\alpha_i} : T^*S^n \xrightarrow{\sim} T^*\alpha_i$ such that $\phi_{\alpha_i}(S) = S_{\alpha_i}$.

One obtains an involution $\eta_{\alpha_i} : T^*\alpha_i \xrightarrow{\sim} T^*\alpha_i$ by setting

$$\eta_{\alpha_i} := \phi_{\alpha_i} \circ \eta_0 \circ (\phi_{\alpha_i})^{-1}.$$

Note that $T^*\alpha_i$ is a subset of M . Similarly, one obtains an involution $\eta_{\beta_j} : T^*\beta_j \xrightarrow{\sim} T^*\beta_j$ in the same way.

Moreover, without loss of generality, one can assume that $\eta_{\alpha_i}(x) = \eta_{\beta_j}(x)$ for every $x \in T^*\alpha_i \cap T^*\beta_j$. Thus, one can define an involution $\eta : M \xrightarrow{\sim} M$ as follow:

$$\eta(x) := \begin{cases} \eta_{\alpha_i}(x) & \text{if } x \in T^*\alpha_i, \\ \eta_{\beta_j}(x) & \text{if } x \in T^*\beta_j. \end{cases}$$

Then, we will call η *the involution associated to M* .

Remark 5.2. Let \tilde{M} be the set of fixed points of η , i.e., $\tilde{M} = \{x \in M \mid \eta(x) = x\}$. We call \tilde{M} *the fixed surface of M* .

It is easy to check that \tilde{M} is a 2-dimensional symplectic submanifold of M . Moreover, \tilde{M} is symplectomorphic to a plumbing space $P(S_{\alpha_1}, \dots, S_{\alpha_m}, S_{\beta_1}, \dots, S_{\beta_l})$ of Penner type. Note that S_{α_i} and S_{β_j} are embedded circles in α_i and β_j .

5.2. Proof of Theorem 1.5. Let M be a plumbing space of Penner type. Let η be the associated involution of M . Let L_0 and L_1 be a transversal pair of Lagrangian submanifolds such that

- (1) $\eta(L_i) = L_i$.
- (2) Let $\tilde{L}_i = L_i \cap \tilde{M}$. Then, \tilde{L}_i is a Lagrangian submanifold of \tilde{M} .
- (3) $L_0 \cap L_1 = \tilde{L}_0 \cap \tilde{L}_1$.
- (4) L_0 and L_1 are not isotopic to each other.

We will compute $\mathbb{Z}/2$ -graded Lagrangian Floer homology $HF^*(L_0, L_1)$ over the Novikov field Λ of characteristic 2. To do this, we will compare chain complexes $CF^*(L_0, L_1)$ and $CF^*(\tilde{L}_0, \tilde{L}_1)$. More precisely, we will show that those two chain complexes have the same generators and the same differential maps.

First, it is easy to show that $CF^*(L_0, L_1)$ and $CF^*(\tilde{L}_0, \tilde{L}_1)$ have the same generators since L_0 and L_1 satisfy that $L_0 \cap L_1 = \tilde{L}_0 \cap \tilde{L}_1$. Thus, $CF^*(L_0, L_1) = CF^*(\tilde{L}_0, \tilde{L}_1)$ as vector spaces.

Second, let ∂ (resp. $\tilde{\partial}$) denote the differential map on $CF^*(L_0, L_1)$ (resp. $CF^*(\tilde{L}_0, \tilde{L}_1)$).

Then,

$$\partial p = \sum_{\substack{q \in L_0 \cap L_1 \\ [u]: \text{ind}([u])=1}} (\#\mathcal{M}(p, q; [u], J)) T^{\omega([u])} q,$$

where J is an almost complex structure on M , u is a homomorphic strip connecting p and q , and $\mathcal{M}(p, q; [u], J)$ is the moduli space. We skip the foundational details of the definition of ∂ .

Let assume that for a holomorphic strip u , the image of u is not contained in \tilde{M} . Then, it is easy to check that $\eta \circ u$ is also another holomorphic strip connecting p and q . Since the Novikov field Λ is of characteristic 2, u and $\eta \circ u$ will be canceled together. Thus, in order to define the differential map $\partial : CF^*(L_0, L_1) \rightarrow CF^*(L_0, L_1)$, it is enough to count holomorphic strips u such that the image of u is contained in \tilde{M} .

On the other hands, in order to define $\tilde{\partial} : CF^*(\tilde{L}_0, \tilde{L}_1) \rightarrow CF^*(\tilde{L}_0, \tilde{L}_1)$, one needs to count the holomorphic strips on \tilde{M} . Thus, $\partial(p) = \tilde{\partial}(p)$ for all $p \in L_0 \cap L_1 = \tilde{L}_0 \cap \tilde{L}_1$.

Under the assumptions, $HF^*(L_0, L_1) = HF^*(\tilde{L}_0, \tilde{L}_1)$. Note that the former is defined on M^{2n} , but the latter is defined on a surface \tilde{M} . Then, Lemma 2.18 of [2] completes the proof. \square

5.3. Example 5.5. In the present subsection, we will prove Lemmas 5.3 and 5.4 in order to slightly weaken the difficulty of applying Theorem 1.5. More precisely, we will weaken the conditions in Theorem 1.5, which L_0 and L_1 should satisfy.

Before giving the statement of Lemmas 5.3 and 5.4, we will establish notation first. In Section 5, $M = P(\alpha_1, \dots, \alpha_m, \beta_1, \dots, \beta_l)$ is a plumbing space of Penner type. Then, as we did in Section 3.4, we can constructed a set \mathbb{B} of Lagrangian branched submanifolds of M . To construct \mathbb{B} , we need to choose one of two possibilities: one is that $\{\alpha_i\}$ are positive spheres and $\{\beta_j\}$ are negative spheres, and the other is that $\{\alpha_i\}$ are negative spheres and $\{\beta_j\}$ are positive spheres. More precisely, let assume that

α_i is positive and β_j is negative. Every Lagrangian branched submanifold $\mathcal{B} \in \mathbb{B}$ is a union of (parts of) α_i and β_j and Lagrangian connected sums α_i and β_j . By assuming that α_i is positive and β_j is negative, one considers the Lagrangian connected sum $\alpha_i \# \beta_j$, not $\beta_j \# \alpha_i$. Similarly, by assuming that α_i is negative and β_j is positive, one can construct another set \mathbb{B}^{op} of Lagrangian branched submanifolds.

Lemma 5.3. *Let $\mathcal{B}_i \in \mathbb{B} \cup \mathbb{B}^{op}$ for $i = 0, 1$. Then, there is a Hamiltonian isotopy $\Phi_t : M \rightarrow M$ such that*

- (1) $\Phi_t \circ \eta = \eta \circ \Phi_t$,
- (2) $\mathcal{B}_0 \pitchfork \Phi_1(\mathcal{B}_1)$,
- (3) *for every $q \in \mathcal{B}_0 \cap \Phi_1(\mathcal{B}_1)$, q is not a plumbing point or the antipodal point of a plumbing point.*

Proof. Since \mathcal{B}_i is a union of (parts of) compact cores and their Lagrangian connected sums, we will construct Hamiltonian isotopies perturbing each compact cores α_i and β_j . Then, one obtains a perturbation of \mathcal{B}_1 as a union of (parts of) perturbations of α_i, β_j and their Lagrangian connected sums.

First, we note that there is an identification $\phi_{\alpha_i} : T^*S^n \xrightarrow{\sim} T^*\alpha_i$ which is defined in Section 5.1. We also note that

$$T^*\alpha_i \stackrel{\phi_{\alpha_i}}{\simeq} T^*S^n = \{(x, y) \in \mathbb{R}^{n+1} \times \mathbb{R}^{n+1} \mid |x| = 1, \langle x, y \rangle = 0\}.$$

We will use the identification.

We choose a smooth function $f_i : \alpha_i \rightarrow \mathbb{R}$ with isolated critical points such that

- (1) every plumbing point $p \in \alpha_i$, $f_i(p) = f_i(-p) = 0$, where $-p$ is the antipodal point of p on α_i ,
- (2) every critical point q of f_i lies on S_{α_i} and $q \neq p, -p$ for any plumbing point $p \in \alpha_i$,
- (3) $|df_i(x)| < \epsilon$ for all $x \in \alpha_i$ and for a sufficiently small fixed positive number ϵ ,

(4) $f_i \circ \eta_{\alpha_i} = f_i$, where η_{α_i} is the involution on $T^*\alpha_i$ defined in Section 5.1.

Then, we can extend f_i to $\tilde{f}_i : T^*\alpha_i \rightarrow \mathbb{R}$. We choose a smooth decreasing function

$$\delta : [0, \infty) \rightarrow \mathbb{R},$$

such that

$$\delta([0, \epsilon]) = 1, \delta([2\epsilon, \infty)) = 0.$$

We set

$$\tilde{f}_i : T^*\alpha_i \rightarrow \mathbb{R}, \tilde{f}_i(x, y) = \delta(|y|)f_i(x).$$

Similarly, we can get $\tilde{g}_j : T^*\beta_j \rightarrow \mathbb{R}$ in the same way.

These functions \tilde{f}_i and \tilde{g}_j define Hamiltonian isotopies on $T^*\alpha_i$ and $T^*\beta_j$. Moreover, these Hamiltonian isotopies could be extended on the plumbing space M since the Hamiltonian isotopies have compact supports on $T^*\alpha_i$ and $T^*\beta_j$.

Let $\Phi_{\alpha_i, t} : M \xrightarrow{\sim} M$ be the (extended) Hamiltonian isotopy associated to \tilde{f}_i . Then, it is easy to check that

$$\Phi_{\alpha_i, t} \circ \eta = \eta \circ \Phi_{\alpha_i, t},$$

$$\Phi_{\alpha_i, t}(\alpha_k) = \alpha_k, \text{ if } k \neq i,$$

$$\Phi_{\alpha_i, t}(\beta_j) = \beta_j \text{ for all } j,$$

$$\Phi_{\alpha_i, 1}(\alpha_i) = \Gamma(df_i),$$

where $\Gamma(df_i)$ is the graph of df_i in $T^*\alpha_i \subset M$. Similarly, one can obtain a Hamiltonian isotopy $\Phi_{\beta_j, t} : M \xrightarrow{\sim} M$ for each β_j in the same way.

Let

$$\Phi_t = \prod_{\beta_j} \Phi_{\beta_j, t} \circ \prod_{\alpha_i} \Phi_{\alpha_i, t}.$$

Then, it is easy to check that Φ_t satisfies the first condition of Lemma 5.3. Moreover, one can assume that $\Phi_1(\mathcal{B}_1)$ is constructed from $\Phi_1(\alpha_i)$ and $\Phi_1(\beta_j)$. Thus, it is easy to prove that \mathcal{B}_0 and $\Phi_1(\mathcal{B}_1)$ satisfy the second and the last conditions of Lemma 5.3. \square

From now on, we will explain how Lemma 5.3 weakens a difficulty of applying Theorem 1.5. The difficulty we will consider is the last condition of Theorem 1.5, i.e.,

$$L_0 \cap L_1 = \tilde{L}_0 \cap \tilde{L}_1$$

Let assume that L_0 (resp. L_1) is a Lagrangian submanifold which is carried by \mathcal{B}_0 (resp. \mathcal{B}_1) $\in \mathbb{B} \cup \mathbb{B}^{op}$. Note that we can assume that L_i is contained in a small neighborhood of \mathcal{B}_i . Also, note that $\Phi_1(L_1)$ is carried by $\Phi_1(\mathcal{B}_2)$, where Φ_1 is the Hamiltonian isotopy given in Lemma 5.3. Then, we will count the numbers of intersections $L_0 \cap \Phi_1(L_1)$ and $\tilde{L}_0 \cap \Phi_1(\tilde{L}_1)$. If these numbers are the same, then $L_0 \cap \Phi_1(L_1) = \tilde{L}_0 \cap \Phi_1(\tilde{L}_1)$.

First, we remark that \tilde{L}_0 (resp. $\Phi_1(\tilde{L}_1)$) is a curve which is carried by a train track $\mathcal{B}_0 \cap \tilde{M}$ (resp. $\Phi_1(\mathcal{B}_1) \cap \tilde{M}$). Then, \tilde{L}_0 (resp. $\Phi_1(\tilde{L}_1)$) has weights on the train track $\mathcal{B}_0 \cap \tilde{M}$ (resp. $\Phi_1(\mathcal{B}_1) \cap \tilde{M}$). Moreover, the number of $\tilde{L}_0 \cap \Phi_1(\tilde{L}_1)$ is the following:

$$\sum_{x \in \mathcal{B}_0 \cap \Phi_1(\mathcal{B}_1)} (\text{the weight of } \tilde{L}_0 \text{ at } x) \cdot (\text{the weight of } \Phi_1(\tilde{L}_1) \text{ at } x).$$

To count the number of $L_0 \cap \Phi_1(L_1)$, we can assume that $L_0 \cap \Phi_1(L_1)$ is contained in a small neighborhood of $\mathcal{B}_0 \cap \Phi_1(\mathcal{B}_1)$. Since L_0 is carried by, not strongly carried by, \mathcal{B}_0 , L_0 can have singular points. However, the singular points are lying near plumbing points or the antipodal of plumbing points. Since the intersection points of \mathcal{B}_0 and $\Phi_1(\mathcal{B}_1)$ are not plumbing points of their antipodals, every $p \in L_0 \cap \Phi_1(L_1)$ is a regular point of L_0 (resp. $\Phi_1(L_1)$). It means that the number $|L_0 \cap L_1|$ is also give by

$$\sum_{x \in \mathcal{B}_0 \cap \Phi_1(\mathcal{B}_1)} (\text{the weight of } \tilde{L}_0 \text{ at } x) \cdot (\text{the weight of } \Phi_1(\tilde{L}_1) \text{ at } x).$$

Lemma 5.4. *Let L_i is carried by $\mathcal{B}_i \in \mathbb{B} \cup \mathbb{B}^{op}$. Then, there is a Hamiltonian isotopy Φ_t such that*

$$L_0 \cap \Phi_1(L_1) = \tilde{L}_0 \cap \Phi_1(\tilde{L}_1).$$

Then, we consider $HF^*(L_0, \Phi_1(L_1)) \simeq HF^*(L_0, L_1)$.

Example 5.5. Let ψ_i ($i = 0, 1$) be a symplectomorphism of Penner type, i.e., ψ_i is a product of positive (resp. negative) powers of τ_i and negative (resp. positive) powers of σ_j , where τ_i and σ_j are Dehn twists along α_i and β_j respectively. Let assume that L_i is a Lagrangian submanifold of M , which is generated from one of compact cores by applying ψ_i , i.e.,

$$L_i = \psi_i(\alpha_k) \text{ or } \psi_i(\beta_j).$$

Then, $\eta(L_i) = L_i$ since

$$\eta(\alpha_i) = \alpha_i \text{ for all } i, \eta(\beta_j) = \beta_j \text{ for all } j,$$

$$\eta \circ \tau_i = \tau_i \circ \eta \text{ for all } i, \eta \circ \sigma_j = \sigma_j \circ \eta \text{ for all } j.$$

Similarly, $\tilde{L}_i = \psi_i(\tilde{\alpha}_k)$ or $\psi_i(\tilde{\beta}_j)$. Thus, \tilde{L}_i is a Lagrangian submanifold of \tilde{M} . Finally, L_i is carried by \mathcal{B}_{ψ_i} .

Thus, if L_0 and L_1 are not isotopic to each other, then one can apply Theorem 1.5 to $HF^*(L_0, L_1)$.

REFERENCES

- [1] A. J. Casson and S. A. Bleiler. *Automorphisms of surfaces after Nielsen and Thurston*, volume 9 of *London Mathematical Society Student Texts*. Cambridge University Press, Cambridge, 1988.
- [2] G. Dimitrov, F. Haiden, L. Katzarkov, and M. Kontsevich. Dynamical systems and categories. In *The influence of Solomon Lefschetz in geometry and topology*, volume 621 of *Contemp. Math.*, pages 133–170. Amer. Math. Soc., Providence, RI, 2014.
- [3] B. Farb and D. Margalit. *A primer on mapping class groups*, volume 49 of *Princeton Mathematical Series*. Princeton University Press, Princeton, NJ, 2012.

- [4] W. Floyd and U. Oertel. Incompressible surfaces via branched surfaces. *Topology*, 23(1):117–125, 1984.
- [5] D. Nadler. Arboreal singularities. *Geom. Topol.*, 21(2):1231–1274, 2017.
- [6] U. Oertel. Incompressible branched surfaces. *Invent. Math.*, 76(3):385–410, 1984.
- [7] R. C. Penner. A construction of pseudo-Anosov homeomorphisms. *Trans. Amer. Math. Soc.*, 310(1):179–197, 1988.
- [8] A. F. Ritter. Deformations of symplectic cohomology and exact Lagrangians in ALE spaces. *Geom. Funct. Anal.*, 20(3):779–816, 2010.
- [9] P. Seidel. Lagrangian two-spheres can be symplectically knotted. *J. Differential Geom.*, 52(1):145–171, 1999.
- [10] W. P. Thurston. On the geometry and dynamics of diffeomorphisms of surfaces. *Bull. Amer. Math. Soc. (N.S.)*, 19(2):417–431, 1988.
- [11] W. P. Thurston. *Three-dimensional geometry and topology. Vol. 1*, volume 35 of *Princeton Mathematical Series*. Princeton University Press, Princeton, NJ, 1997. Edited by Silvio Levy.
- [12] A. Weinstein. Symplectic manifolds and their Lagrangian submanifolds. *Advances in Math.*, 6:329–346 (1971), 1971.
- [13] W. Wu. Exact Lagrangians in A_n -surface singularities. *Math. Ann.*, 359(1-2):153–168, 2014.