

UC Berkeley

UC Berkeley Previously Published Works

Title

Measurement of post-lens tear thickness.

Permalink

<https://escholarship.org/uc/item/9919325x>

Journal

Investigative Ophthalmology & Visual Science, 40(12)

ISSN

0146-0404

Authors

Lin, MC
Graham, AD
Polse, KA
[et al.](#)

Publication Date

1999-11-01

Peer reviewed

Measurement of Post-Lens Tear Thickness

Meng C. Lin, Andrew D. Graham, Kenneth A. Polse, Robert B. Mandell, and Nancy A. McNamara

PURPOSE. A method to measure the tear film beneath a soft contact lens, referred to as post-lens tear thickness (PLTT), would have many applications to contact lens research. In this study a noninvasive technique for measuring the PLTT is presented.

METHODS. The feasibility of measuring the tear layer by optical pachometry was first assessed using a model eye. The baseline corneal thickness (B) of both eyes of 21 subjects was measured, etafilcon-A ionic disposable soft contact lenses (58% water) were inserted, and the total thickness (T) of the cornea, contact lens, and PLTT were measured. After the pachometry readings the lenses were removed and their center thickness (C) determined. The PLTT was calculated using the equation: $PLTT = T - (B + C)$. Two sets of measurements of T were performed at 15 and 25 minutes after lens insertion. The entire procedure was repeated at a second visit.

RESULTS. The pachometry measurements of the small aqueous reservoir between the model eye and the lens closely matched those obtained by direct microscopic measurement. For human PLTT, the mean values (and 95% confidence intervals) for right eyes on visits 1 and 2 were 11 (8, 13) and 12 (10, 15) μm , respectively, and for left eyes were 12 (10, 15) and 11 μm (8, 14) μm , respectively.

CONCLUSIONS. It is possible to measure the post-lens tear thickness using optical pachometry. The variability between repeated measurements suggests that with careful sample size planning, the technique is sufficiently precise to be useful in group assessments of PLTT. (*Invest Ophthalmol Vis Sci.* 1999;40:2833–2839)

Most clinicians and scientists agree that the tear film layer between a soft contact lens and the cornea is important for successful lens wear. Although the role of this thin film with respect to lens wear is not well understood, it is generally believed that the post-lens tear layer cushions the soft lens against the cornea and allows the exchange of tears beneath the lens to facilitate the removal of trapped debris, metabolites, and potential pathogens. Thus, a measurement of the post-lens tear thickness (PLTT) would prove useful in exploring the impact of the tear thickness under a soft lens on tear mixing, lens wear comfort, lens design, and other contact lens-related issues.

Unfortunately, the thickness of this thin film between the cornea and a soft lens is difficult to measure and, to the best of our knowledge, no reliable technique is currently available. In this study we report a noninvasive method to measure the PLTT using optical pachometry. First, we investigated the feasibility of this optical technique by applying polymethylmethacrylate (PMMA) lenses with different sagittal depths to a plastic eye model and measuring the space between the model eye and the contact lens. After this feasibility investigation, we obtained a series of repeated human PLTT measurements using

etafilcon-A disposable lenses (ionic, 58% water) in situ. From the repeated measurement data, we were able to estimate sample sizes needed to detect given differences in PLTT between two groups of lens wearers.

MATERIALS AND METHODS

Optical Pachometry

A modified Haag–Streit optical pachometer was equipped with small light-emitting diodes to improve patient fixation and alignment. For each pachometry measurement, 20 replicate readings were taken within a period of 2 to 3 minutes and averaged. The setup of this instrument and the calibration techniques have been fully described elsewhere.^{1,2}

Phase I: Model Eye Study

We designed eight clear PMMA contact lenses with base curve radii of 8.6 to 8.2 mm and all other lens characteristics constant (Fig. 1). All lenses were ordered with specifications of 8.6-mm peripheral curve, 300- μm edge thickness, 11.5-mm overall diameter, 8.0-mm optic zone diameter, and +1.50-D lens power. Base curve radius and optic zone diameter were verified by radiuscope and reticule magnifier, respectively. After the verification process these lenses were applied to a plastic eye model with an anterior curve radius of 8.6 mm that was identical to the peripheral curve radius of each lens. This design resulted in a space (S) between the model eye and a lens of 0 to 55 μm .

To obtain the value of S by optical pachometry we measured the combined total thickness of S and the lens center thickness by aligning the posterior edge of S in the upper split-image with the front edge of the contact lens in the lower

From the Morton D. Sarver Laboratory for Cornea and Contact Lens Research School of Optometry, University of California at Berkeley.

Supported in part by NIH Grant R01 EY07728 (Bethesda, MD); NIH CORE Grant EY03176; and CIBA Vision Corporation (Duluth, GA).

Submitted for publication January 27, 1999; revised June 8, 1999; accepted July 6, 1999.

Commercial relationships policy: N.

Corresponding author: Meng C. Lin, School of Optometry, University of California, Berkeley, CA 94720-2020.

E-mail: mlin@spectacle.berkeley.edu

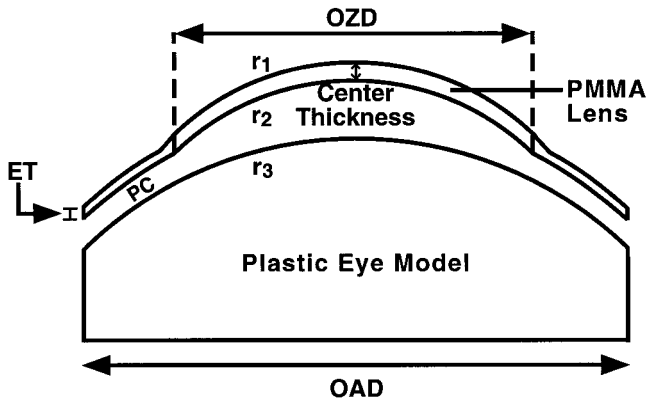

FIGURE 1. In the model eye study each PMMA contact lens had the same anterior (r_1) and posterior (r_2) base curve radius, ranging from 8.6 to 8.2 mm. The anterior curve radius of the plastic eye model ($r_3 = 8.6$ mm) matched the peripheral curve radius (PC = 8.6 mm) of the lens. All PMMA lenses were made with overall diameter (OAD) of 11.5 mm, optic-zone diameter (OZD) of 8.0 mm, and edge thickness (ET) of 300 μm . A space is created when the PMMA lens is placed on top of the model eye. The total thicknesses of this space and the lens are measured by optical pachometry. The center thickness of the lens is then subtracted from the total thickness pachometry measurement to obtain the depth of the space sandwiched between the lens and model eye.

split-image (Fig. 2a). After the pachometry measurement, the center thickness of the lens was measured with a SONY precision thickness gauge (DEC30BR model; SONY Precision Tech, Tokyo, Japan, accuracy of $\pm 1 \mu\text{m}$). The contact lens was placed on a flat stage with its concave side up, and a probe was lowered to the center of the lens for thickness measurements. The values of S were obtained by subtracting the center thickness of the lens from the pachometry measurements.

Fluorescent dye was used to highlight the S to improve the consistency of the pachometry alignment by sharpening the visibility of the interface between the model eye and the space created by the lens. The dye was prepared by extraction from five fluorescein sodium ophthalmic strips (1 mg/strip; BIO GLO) into 1.8 ml of saline. A sufficient amount of the dye was instilled to fill the concavity of each lens before it was applied to the model eye, allowing the lens and the model eye to be held securely by capillary attraction. Immediately after the lens was placed on the plastic eye model, pachometry readings were made to obtain the value of the S as described above. A total of four repeated pachometry measurements were taken for each lens. The order of measurement of the eight lenses was randomized.

To validate the accuracy of our pachometry measurements we used a method that allowed a direct measurement of the space between the model eye and lens. Using a high precision bench-top specular microscope, we placed the lens and model eye (with water-filled gap) on a flat stage beneath the microscope objective (40 \times ; water-immersion; 0.75NA and 1.2 mm working distance). S was then determined by measuring the distance traveled by the fine focus between the posterior and anterior surfaces of the water interface, using a SONY precision thickness gauge attached to the microscope. This thickness gauge has a repeatability of 1 μm over 30 mm of microscope stage motion.

Phase II: Clinical Study

For the clinical study we needed to obtain two independent pachometry measurements to determine the value of the

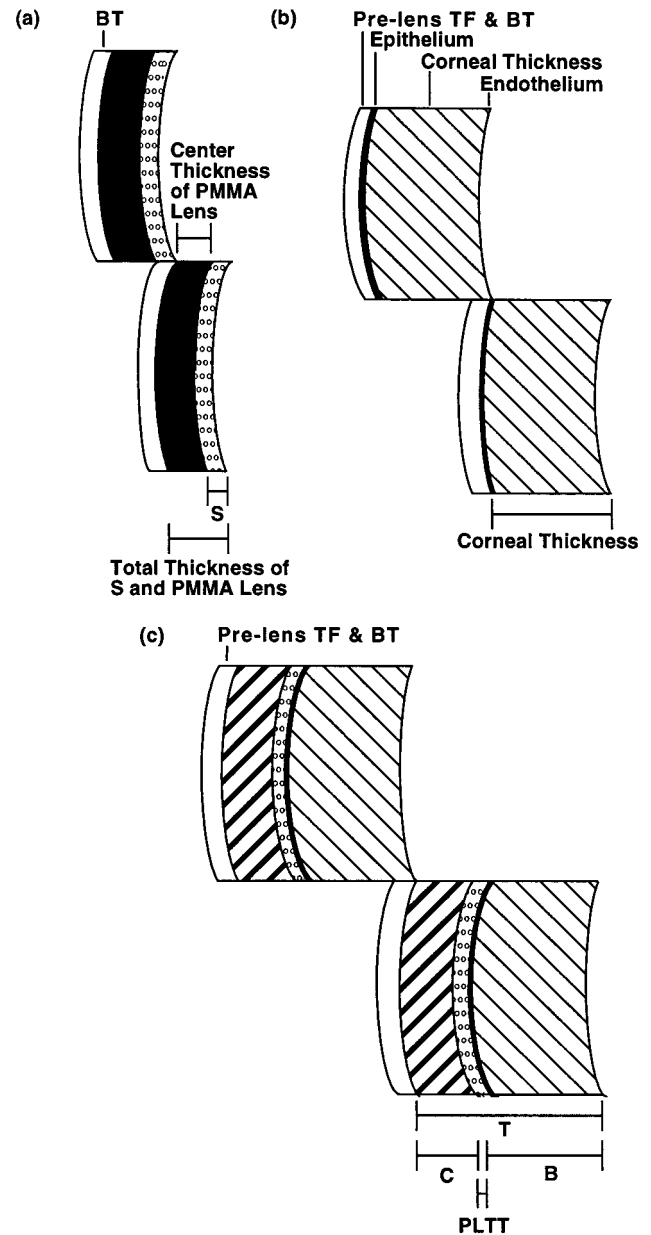

FIGURE 2. Pachometry alignments. BT and TF in each diagram represent the thickness of the optical light beam and tear film, respectively. (a) Model eye study. S is defined as the space between the PMMA lens and the model eye. The total thickness of S and the lens is obtained by aligning the posterior edge of S in the upper split image with the front edge of the lens in the lower split image. The value of S is obtained by subtracting the center thickness of the lens from the total thickness pachometry measurement. (b) Baseline corneal thickness. The posterior edge of the endothelium in the upper split image is aligned with the front edge of the epithelium in the lower split image. (c) Total thickness of the cornea, soft contact lens, and post-lens tear layer. Total thickness (T) is obtained by aligning the posterior edge of the endothelium in the upper split image with the front edge of the soft lens in the lower split image. The value of PLTT is obtained using the equation: $\text{PLTT} = T - (B + C)$, where B and C represent baseline corneal thickness and center thickness of the soft lens, respectively.

PLTT in situ: (1) the baseline corneal thickness (B) without a lens in place and (2) the total thickness (T) of the cornea, PLTT, and a soft contact lens (C). The value of B was obtained by aligning the posterior edge of the endothelium in the upper split-image with the front edge of the epithelium in the lower split-image (Fig. 2b). The value of T was measured by having the vernier alignment at the front edge of the soft contact lens in the lower split-image (Figs. 2c and 3). The value of PLTT was obtained by subtracting the sum of B and C from T [i.e., $PLTT = T - (B + C)$]. The center thickness of the soft contact lens was determined by taking the average of three measurements from an electronic thickness gauge specifically designed for measuring soft lenses (model ET-3; Rehder Development, Castro Valley, CA).³ The soft contact lens is centered on a steel ball carrier and a sensor automatically lowered to the anterior surface of the lens by a motorized drive. The ET-3 is preferred over previous models for measuring soft lenses because the sensor is lowered at a constant velocity and applies a constant amount of force to the lens, thereby increasing measurement precision while maintaining an accuracy of $\pm 2 \mu\text{m}$.

We recruited, from the campus of the University of California at Berkeley, 21 experienced soft contact lens wearers 18 to 35 years of age with no history of ocular disease. Informed consent was obtained after a full description of the study protocol and an explanation of the possible consequences. The research followed the tenets of the Declaration of Helsinki, and the research protocol was approved by the institutional review board (Committee for Protection of Human subjects). We excluded from the study any potential subjects who were currently taking medications or who were suffering from systemic conditions or seasonal allergies that could alter the quality or quantity of the tear film. Subjects with corneal abnormalities identified through biomicroscopy, keratometry, or video keratography were excluded from the study.

All participants reported for two visits scheduled at the same time of day to avoid bias induced by diurnal variation.⁴ At each visit, subjects reported to our laboratory a minimum of two hours after awakening⁵ and discontinued contact lens wear a minimum of 24 hours before the scheduled appointment because a period of lens wear or eye closure is known to alter corneal thickness⁶ and could possibly disrupt tear film stability.⁷ Pachometry measurements of B were taken, followed by insertion of a pair of etafilcon-A disposable lenses (8.8/14.0/-2.00, ionic, 58% water) onto the subject's corneas. Unlike the protocol with the model eye, the fluorescent dye was not used in the human eye because reflex tearing might be induced on instillation and the dye was not needed to acquire the pachometry alignment. To ensure good centration we assessed the lens fit ten minutes after lens insertion. The comfort of lens wear of each eye was rated independently by the subject on a scale of 0 to 50 (0 = impossible to wear; 50 = excellent comfort). Measurements were not taken if the lens did not center on the cornea or if the comfort level was below 35, thereby reducing the chance of bias due to reflex tearing triggered by discomfort. Pachometry measurements of T were made at 15 and 25 minutes after lens insertion with the alignment described previously, the lenses were removed and soaked in saline solution for 10 minutes, and then the same lenses were reinserted onto the subject's eyes and the pachometry

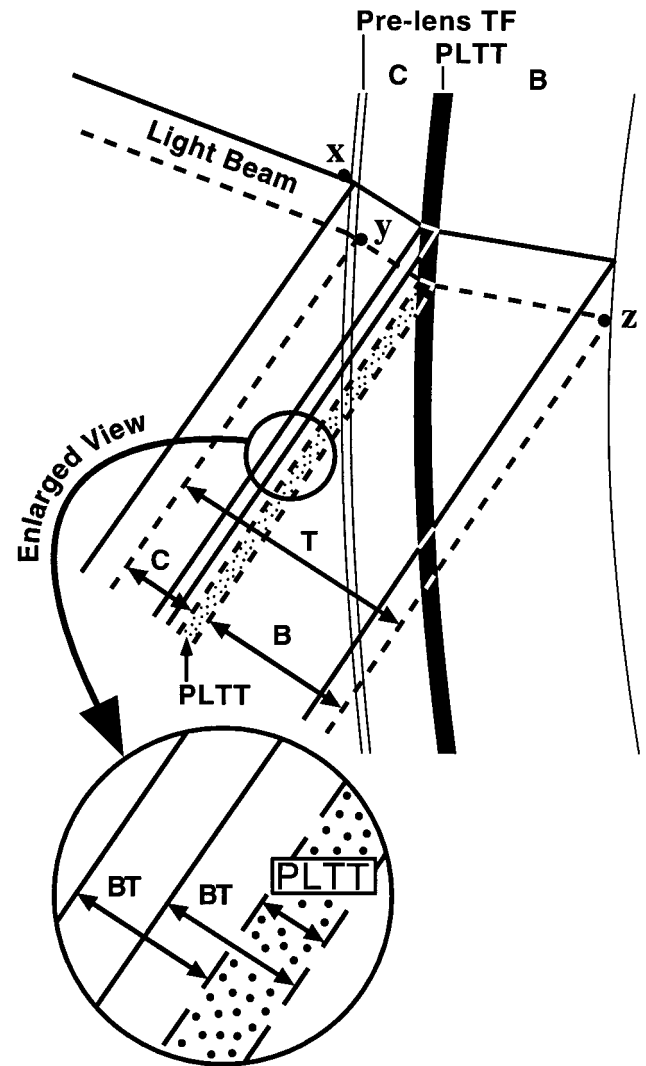

FIGURE 3. Absolute measurements of the corneal thickness by the usual technique of optical pachometry have a potential error caused by the inclusion of the optical beam thickness (BT) in the measurement. This illustration shows how the optical light beam travels through each medium and how its inherent thickness reflects off the front and back surfaces of the medium it travels through. As a result a pachometry measurement of the PLTT cannot be made directly because the image of the tear thickness appears as a section that also includes the image of the beam width. However, the PLTT can be measured indirectly by assuming that the PLTT will be included in the total apparent thickness (y to z, denoted as T) of the cornea, contact lens, and post-lens tear film, which can be measured by optical pachometry. The known contact lens and corneal thicknesses can then be subtracted from the total apparent thickness to obtain the value of PLTT. By using this alignment technique (Fig. 2c), the apparent thickness (x to y) of the pre-lens tear layer and the light beam width can be excluded. B, C, and TF in the illustration represent the baseline corneal thickness, center thickness of soft lens, and tear film, respectively.

measurements of T were repeated. After the repeat T measurements, the lenses were removed, and C was measured with the Rehder gauge. We chose to measure the C at the completion of each visit to assure lens sterility for our subjects. The eye to be measured first was randomized, and a fresh pair of lenses was used each day.

TABLE 1. Results of the Model Eye Study

BCR, mm	$S_{\text{Microscope}}, \mu\text{m}$	$S_{\text{Pachometry}}, \mu\text{m}$
8.60	0	-2
8.55	9	8
8.50	10	9
8.45	19	23
8.40	24	25
8.35	36	36
8.30	38	37
8.20	53	50

Data obtained by optical pachometry are compared with that obtained by specular microscope. S represents the space created by each PMMA lens when it is placed on the model eye.

RESULTS

Phase I: Model Eye Study

Table 1 and Figure 4 show the results of the model eye study. In Figure 4, S obtained by optical pachometry is plotted against the values of S measured by microscopy. Each point is the average of the four pachometry measurements made on a given contact lens. A simple linear regression of $S_{\text{Pachometer}}$ on $S_{\text{Microscope}}$ shows that our data lie very close to the 1:1 line of perfect agreement (estimated slope = 0.98, SE of the estimate = 0.05), and our regression R^2 of 0.99 shows minimal variation of our data about the regression line. These results suggested that optical pachometry could reliably measure the small aqueous reservoir formed between a contact lens and a model eye.

Phase II: Clinical Study

Variations in PLTT measurements may be due to real differences among subjects in their PLTT levels, lability of PLTT over the short period of repeated measurements, and measurement error. In order for our technique to be useful for clinical research, we must be certain that the phenomenon being

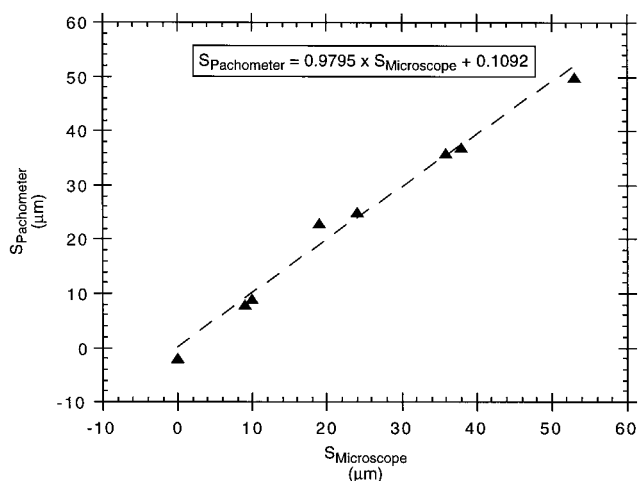

FIGURE 4. The results of the model eye study. The measurements of the space (S) between the PMMA lens and the model eye obtained by optical pachometer ($S_{\text{pachometer}}$) closely matched the microscopic measurements ($S_{\text{microscope}}$). Each triangle is the average of four pachometry measurements.

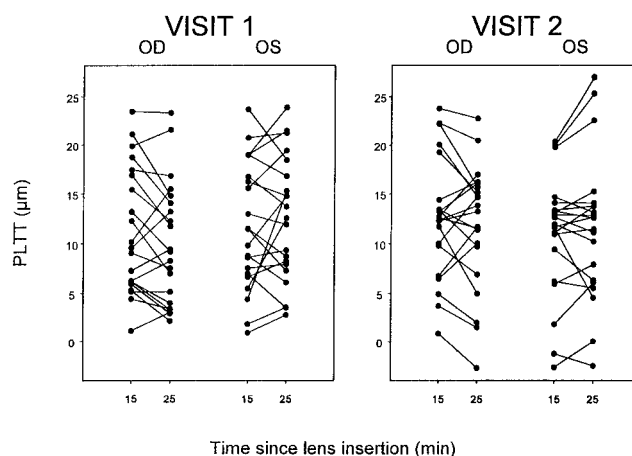

FIGURE 5. Fifteen-minute versus 25-minute PLTT measurements plotted for each eye on visits 1 and 2. Measurements of the same eye are connected by a solid line.

measured does not vary so widely in a short period (lability) that it cannot be measured reliably and that our readings agree closely when taken under virtually identical conditions on separate occasions (repeatability). After examining our within-visit data, we calculated mean values and 95% confidence intervals for mean PLTT at each visit, and examined difference-versus-mean plots and calculated 95% limits of agreement (LA) as suggested by Bland and Altman⁸ to assess the repeatability.

We estimated a subject's PLTT in each eye by taking the average of the four repeat measurements per visit. If the tear film under the CL was relatively stable during the two measurement periods, this approach reduced sampling bias and allowed us to better estimate a subject's PLTT. We therefore explored our within-visit data to determine whether short-term stability is a reasonable assumption for our subjects' PLTT. The results are shown in Figures 5 and 6.

The differences between the two 15-minute and between the two 25-minute postinsertion measurements were relatively small, as were the differences between the average 15-minute and 25-minute measurements. A plot of each subject's mean 15- and 25-minute measurements connected by a straight line, for both eyes at visit 1 and at visit 2 (Fig. 5), displays no obvious 15- versus 25-minute trends. Figure 6 shows the difference between the 15- and 25-minute measurements plotted against their mean, with horizontal dashed lines at the mean difference ± 2 standard deviations. In this figure the mean differences between 15- and 25-minute measurements are very close to zero and there does not appear to be any obvious dependence of the differences on the magnitude of the mean. From this examination of the data we conclude that the PLTT is relatively stable in the short-term and that it is a reasonable approach to estimate a subject's PLTT by averaging the four repeat measurements taken on each eye within this short period after lens insertion.

Using the approach described above, we examined the estimated values of PLTT and assessed their repeatability across visits. Histograms of all PLTT data were examined to verify normality assumptions. In Figure 7 a box plot shows the key features of the distributions of PLTT for each eye on both visits. The horizontal line inside each box represents the median value, and the top and bottom of the box mark

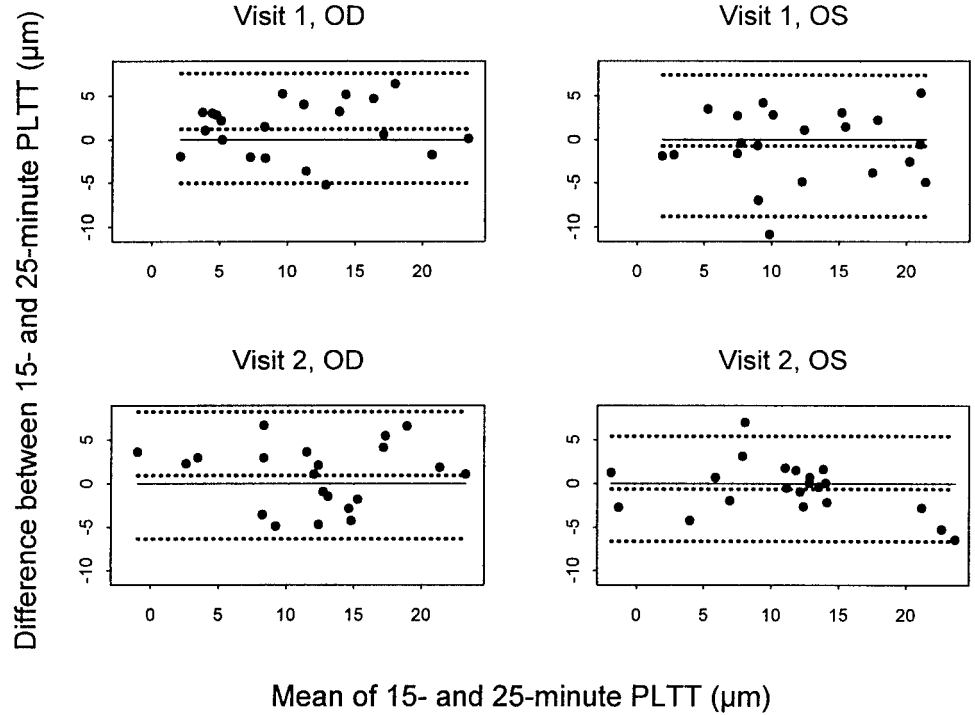

FIGURE 6. The differences in PLTT between the average 15- and 25-minute post-lens-insertion measurements are plotted separately against their overall mean for each eye and visit. The *solid horizontal line* indicates zero difference, and the *dashed lines* indicate the mean difference \pm 2 SD.

the 75th and 25th percentiles, respectively. The vertical lines extending from each box indicate the maximum and minimum PLTT values. The mean values (95% confidence intervals) for PLTT in the right eye for visits 1 and 2 are 11 (8, 13) and 12 (10, 15) μm , respectively. These results suggest that our technique yields reasonable estimates of the PLTT on average, which are similar across visits. The repeatability of our technique is illustrated in more detail below.

The 95% LAs, defined as the mean difference \pm 1.96 SD (assuming normality), are $-16, 13$ and $-12, 13 \mu\text{m}$ for OD and OS, respectively. That is to say, PLTT measured on the second visit may be as much as 16 μm below or 13 μm above that of the first visit. Because we are estimating the 95% LA for both eyes simultaneously, our overall type I error probability is actually larger than 0.05. Using Bonferroni's correction, we adjusted the confidence level for each set of limits such that

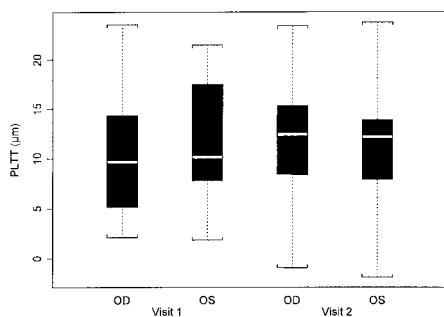

FIGURE 7. Box plot of PLTT for each eye and visit. The *line bisecting each box* represents the median value. Each box encompasses 50% of the data. The *vertical lines* extending from the top and bottom of each box mark the maximum and minimum values of the PLTT.

the overall type I error rate (i.e., for looking at both eyes simultaneously) remains 0.05, obtaining slightly broader LA of $-19, 15$ and $-13, 15 \mu\text{m}$ for OD and OS, respectively.

Figure 8 shows the mean PLTT at visits 1 and 2 (connected by a straight line) for each eye of our 21 subjects. Although inspection of the plot reveals no obvious systematic differences between the two visits, there were three right eyes and three left eyes with differences in estimated PLTT greater than 10 μm and three individual negative PLTT estimates. The difference-versus-mean plots for comparing visit 1 to visit 2 (Fig. 9) show that the mean difference between the two visits is very close to zero.

The fairly wide LA and negative PLTT estimates are due to the many sources of measurement error (see the Discussion section) and suggest that the technique is not sufficiently precise to reliably monitor PLTT on individual sub-

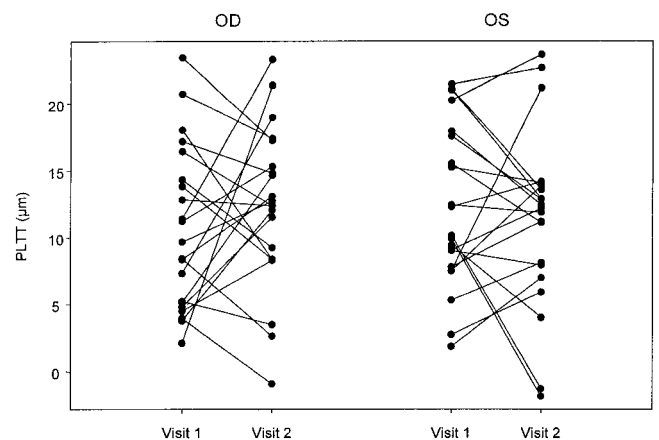

FIGURE 8. PLTT at each visit plotted for right and left eyes. Each eye's visit 1 and visit 2 estimates of PLTT are connected by a *solid line*.

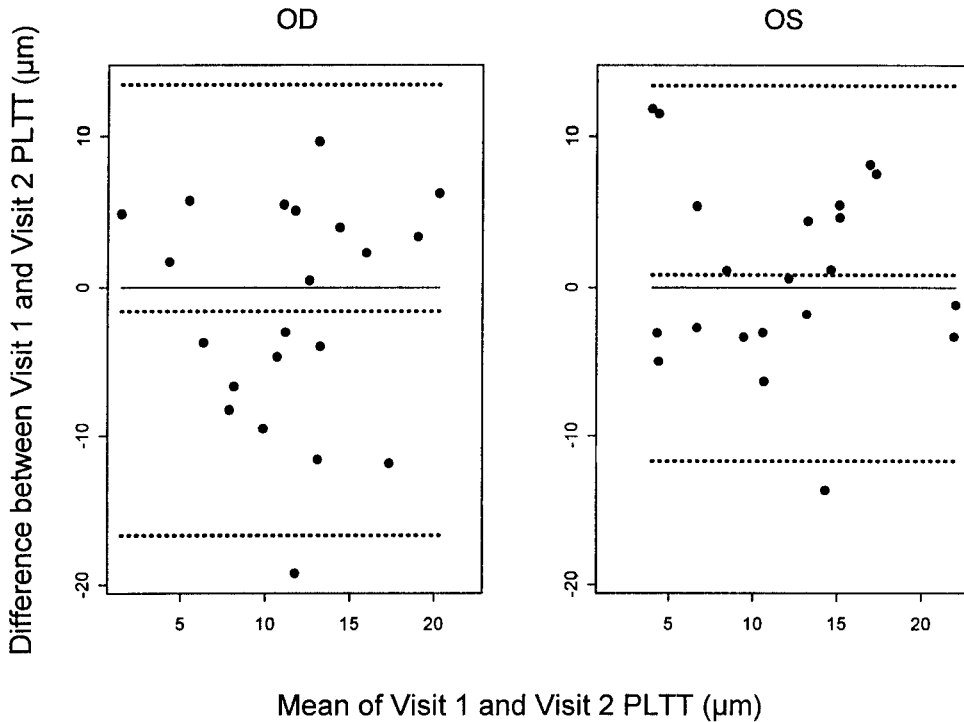

FIGURE 9. The differences between visit 1 and visit 2 PLTT estimates are plotted separately against the mean of the two visits for each eye. The solid horizontal line indicates zero difference, and the dashed lines indicate the mean difference \pm 2 SD.

jects. However, the technique may be appropriate for estimating the PLTT in group studies of sufficient sample size. To investigate the feasibility of this application of our technique, we estimated the sample sizes needed to detect various differences in PLTT between two groups of lens wearers with 95% confidence and 80% power. Table 2 presents the estimated sample sizes required for group studies of PLTT. Because these estimates are directly dependent on the variance of the measurement, we examined the variances in PLTT for each eye and visit and chose the largest variance (left eye, visit 2, variance = 43.55), which resulted in the most conservative sample size estimates. Because the other three variances (36.14, 36.70, and 37.23) were all similar and smaller than the one used in the above calculations, we repeated the sample size estimates using the second-largest variance of 37.23, which may better reflect the variability typically encountered in PLTT measurements. The more conservative sample size estimates ranged from 6 subjects per group (to detect a 7- μ m difference in PLTT) to

38 subjects per group (to detect a 3 μ m difference), showing that this technique is sufficiently precise for use in group studies of PLTT with moderate numbers of subjects.

DISCUSSION

We have shown that it is possible to use optical pachometry to measure the thickness of the tear film between the posterior surface of a soft contact lens and the cornea. Our estimates of mean PLTT ranged from 11 to 12 μ m. It is interesting that these thickness measurements are similar to the measurements of the precorneal tear thickness when there is no contact lens on the eye.⁹ This finding suggests that, at least for the lenses used in the present study, the soft lens conforms to the shape of the cornea without eliminating the tear layer, nor does it appear to retain an extra reservoir of tears. However, further investigation is required to determine whether the PLTT can be altered by changing soft lens designs.

Several external factors contribute to the measurement error associated with this technique. For example, the technique requires that the observer make a vernier alignment. This alignment has an inherent variability each time the measurement is made due to the possible shift in the endpoint criterion. The effect of the alignment error is compounded because the final PLTT value is the arithmetic difference of two pachometry measurements (i.e., corneal thickness alone, and total thickness of the cornea, soft contact lens, and PLTT). Other sources of variability include errors in the measurement of soft lens thickness, true variations of corneal thickness between measurements, and changes in PLTT induced by fluctuations in the ambient humidity. Finally, small amounts of tearing may occur that neither subject nor observer is aware of but that could conceivably affect the PLTT.

TABLE 2. Sample Size Estimates

Group Difference in PLTT, μ m	Sample Size Estimates, per group		Total Number of Subjects	
	σ^2_1	σ^2_2	σ^2_1	σ^2_2
3	38	33	76	66
5	14	12	28	24
7	7	6	14	12

Sample size estimates for detecting group differences in PLTT using 95% confidence and 80% power under two different variance assumptions ($\sigma^2_1 = 43.55$ and $\sigma^2_2 = 37.23$).

Unfortunately the high level of uncertainty for any given PLTT measurement limits the applicability of the technique to monitoring individual tear thickness. However, our sample size analysis shows that the technique is sufficiently precise for studies designed to assess the difference in PLTT between two groups of subjects wearing different types of soft lenses. For example, Table 2 shows that to detect a difference of 3 μm with 95% confidence and 80% power, 76 subjects (38 allocated to each lens type) are needed. Because the technique is relatively quick to perform and is noninvasive, it can be incorporated easily into studies ranging from small single sample lens assessments to large multicenter clinical trials.

In summary, we present a technique for measuring PLTT found between a soft contact lens and the cornea. With an experienced pachometrist researchers will now be able to explore various questions relevant to the effects of the PLTT on lens performance and the ocular response to soft contact lens wear.

Acknowledgment

The authors thank John Fiorillo for his assistance in preparing this manuscript.

References

1. Mandell RB, Polse KA. Keratoconus: spatial variation of corneal thickness as a diagnostic test. *Arch Ophthalmol*. 1969;82:182-188.
2. Mandell RB, Polse KA, Bananno J. Reassessment of optical pachometry. In: Cavanagh HD, ed. *The Cornea: Transactions of the World Cornea on the Cornea III*. New York: Raven Press; 1988:201-205.
3. Rivera R, Gan C, Polse K, Bonanno J, Fatt I. Contact lenses affect corneal stromal pH. *Optom Vis Sci*. 1993;70:991-997.
4. Patel S, Bevan R, Farrell JC. Diurnal variation in precorneal tear film stability. *Am J Optom Physiol Optics*. 1987;65:151-154.
5. Mandell RB, Fatt I. Thinning of the human cornea on awakening. *Nature*. 1965;208:292-293.
6. Polse KA, Brand R, Cohen S, Guillon M. Hypoxic effects on corneal morphology and function. *Invest Ophthalmol Vis Sci*. 1990;31:1542-1554.
7. Hamano H. The change of precorneal tear film by the application of contact lenses. *Contact Intraocul Lens Med J*. 1981;7:205-209.
8. Bland JM, Altman DG. Statistical methods for assessing agreement between two methods of clinical measurement. *Lancet*. 1986;i:307-310.
9. Creech JL, Do LT, Fatt I, Radke CJ. In vivo tear-film thickness determination and implications for tear-film stability. *Curr Eye Res*. 1998;17:1058-1066.