

## **UC Davis**

### **Recent Work**

#### **Title**

A Guide to Wildlands Conservation in the Greater Sierra Nevada Bioregion

#### **Permalink**

<https://escholarship.org/uc/item/9978b2rq>

#### **Authors**

Shilling, Fraser  
Girvetz, Evan  
Erichsen, Chris  
[et al.](#)

#### **Publication Date**

2002

A GUIDE TO

# *Wildlands Conservation*

in the Greater Sierra Nevada Bioregion



© Claus Sivert

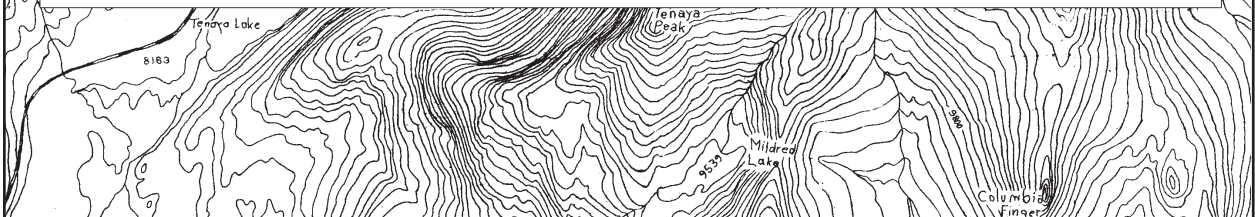

A GUIDE TO

*Wildlands Conservation*  
in the Greater Sierra Nevada Bioregion



*Prepared by:*

Fraser Shilling, Ph. D.

Evan Girvetz

Chris Erichsen

Brenda Johnson, Ph. D.

Peter C. Nichols

February, 2002



CALIFORNIA  
WILDERNESS  
COALITION

California Wilderness Coalition

2655 Portage Bay East, Suite 5

Davis, California 95616

(530) 758-0380

[www.calwild.org](http://www.calwild.org)

## ACKNOWLEDGMENTS

---

### *Project Steering Committee*

**Janet Cobb**, California Oak Foundation and Yosemite Regional Conservation Trust

**Barbara Dugelby, Ph.D.**, The Wildlands Project

**Robert Johnston**, University of California, Davis

**Jim Quinn, Ph.D.**, University of California, Davis

**Fraser Shilling, Ph.D.**, University of California, Davis

**Michael Soulé, Ph.D.**, The Wildlands Project

### *Wildlands Planning Team*

**Christen Erichsen**, California Wilderness Coalition

**Evan Girvetz**, University of California, Davis

**Brenda Johnson, Ph.D.**, California Department of Fish and Game

**Alison Sterling Nichols**, California Wilderness Coalition

**Peter C. Nichols**, California Wilderness Coalition

**Fraser Shilling, Ph.D.**, University of California, Davis

### *Acknowledgments*

This document would not be possible without the generous financial support of the Columbia Foundation and the Foundation for Deep Ecology. Many knowledgeable individuals helped refine and prepare this conservation vision by providing reviews, data, GIS coverages, and their expertise. The California Wilderness Coalition and planning team extend great thanks to Laurel Ames, Reginald Barrett, Eric Beckwitt, Steve Benner, Scott Hoffman-Black, Sam Blankenship, Vern Bleich, Gordon Gould, Sue Britting, John Buckley, Carlos Carroll, Janet Cobb, Kathy Daly, Barbara Dugelby, Jon Fischer, Steve Greco, Bill Haskins, Pat Huber, Rich Hunter, Mark Jennings, Bob Johnston, Walt Koenig, Levi Lewis, Eric Loft, Dan Macon, Peter Moyle, Jim Quinn, Ron Schlorff, Michael Soulé, Jim Strittholt, Craig Thomas, Jim Thorne, Steve Torres, Rick Truex, Jon Wehausen, and anonymous peer reviewers.

### *About the California Wilderness Coalition*

California Wilderness Coalition works to defend the pristine landscapes that make California unique, provide a home to our wildlife, and preserve a place for spiritual renewal. We protect wilderness for its own sake, for ourselves, and for generations yet to come. We identify and protect the habitat necessary for the long-term survival of California's plants and animals. And through our hard-hitting advocacy and public education, we enlist the support of citizens and policy-makers in our efforts to protect California's wildlands.

### *For more information, contact:*

**Alison Sterling Nichols**, [alison@calwild.org](mailto:alison@calwild.org)

**Pete Nichols**, [pnichols@calwild.org](mailto:pnichols@calwild.org)

P.O. Box 342, Grass Valley, CA 95945, (530) 271-5951

## *Table of Contents*

ACKNOWLEDGMENTS .....	ii
EXECUTIVE SUMMARY .....	vii
INTRODUCTION .....	1
<b>1. Sierra Nevada Overview .....</b>	<b>7</b>
1.1 Ecoregion profiles .....	9
1.2 Biodiversity .....	12
1.3 Land use .....	14
<b>2. Ecological Threats .....</b>	<b>19</b>
2.1 Introduction .....	21
2.2 Habitat fragmentation .....	22
2.3 Species loss .....	27
2.4 Suppressed wildfire cycles .....	31
2.5 Dammed wild rivers and creeks .....	31
2.6 Invasive plants and animals .....	31
2.7 Human population growth .....	32
2.8 Lack of evenly distributed protected areas .....	32
<b>3. Wildlands Conservation Planning .....</b>	<b>35</b>
3.1 What is a Wildlands Conservation Plan? .....	37
3.2 Wildlands planning in the Sierra Nevada .....	39
3.3 Elements of a Wildlands Conservation Plan .....	40
<b>4. Wildlands Conservation Plan .....</b>	<b>47</b>
4.1 Introduction to planning methodology .....	49
4.2 Goals for regional conservation .....	50
4.3 Planning objectives .....	50
4.4 Assumptions and limitations .....	50
4.5 The precautionary principle .....	51
4.6 Important terminology .....	51
4.7 Selection of focal species .....	51
4.8 Conservation targets .....	55
4.9 Data sources .....	57
4.10 Assessment of Wildland Integrity .....	58
4.11 Identification of Wildland Conservation Areas .....	64
4.12 Identification of Wildland Linkages .....	66
4.13 Comparative representation analysis .....	66

# TABLE OF CONTENTS

---

<b>5. Results and Discussion</b> .....	69
5.1 Wildland Conservation Areas .....	71
5.2 Wildland Linkages .....	81
5.3 Stewardship Zones .....	81
5.4 Threatened Wildlands.....	82
<b>6. Guidelines for Site Conservation Planning</b> .....	88
6.1 Introduction .....	89
6.2 Background .....	89
6.3 The site planning process .....	91
<b>7. Conservation and Management Guidelines</b> .....	97
7.1 Overview .....	99
7.2 Regional guidelines .....	101
7.3 Guidelines for Cascade and Modoc study area .....	103
7.4 Guidelines for north Sierra study area .....	111
7.5 Guidelines for south Sierra study area .....	124
7.6 Guidelines for east Sierra study area .....	132
7.7 Guidelines for focal species management .....	140
<b>8. Conclusion</b> .....	143
8.1 Overview .....	145
8.2 Future directions .....	145
8.3 Think globally, plan regionally, and act locally .....	146
<b>Glossary</b> .....	147
<b>References cited</b> .....	148
<b>APPENDICES:</b> .....	157
A. Summary of maps .....	159
B. Focal species profiles .....	161
C. Methodology .....	179

*List of Tables*

Table 1. Land ownership in the Sierra Nevada bioregion ..... 14

Table 2. Land management classes ..... 16

Table 3. Percent of land in management classes ..... 16

Table 4. Protected areas in the Sierra Nevada bioregion ..... 18

Table 5. Effects of habitat fragmentation on the environment ..... 23

Table 6. Mule deer mortality on Sierra highways ..... 27

Table 7. Prominent threats to wildlife ..... 28

Table 8. Major extinction events in past 100 years ..... 29

Table 9. Broad approach to regional conservation ..... 40

Table 10. Land use planning efforts underway in the Sierra Nevada ..... 45

Table 11. Human activities affecting potential focal species ..... 53

Table 12. Available habitat data and habitat models for focal species ..... 54

Table 13. Target for plant community representation in wildland conservation areas ..... 63

Table 14. Percent of target plant communities represented in  
Wildland Conservation Areas ..... 74

## *List of Maps and Figures*

### MAPS

Map 1.	Ecoregion of the Sierra Nevada bioregion .....	9
Map 2.	Land ownership in the Sierra Nevada bioregion .....	15
Map 3.	Forest integrity .....	58
Map 4.	Terrestrial habitat .....	59
Map 5.	Aquatic integrity .....	60
Map 6.	Wildland integrity .....	61
Map 7.	SITES model results .....	65
Map 8.	Actual and potential habitat threat.....	83
Map 9.	Wildland Conservation Plan..... <i>(Three perspectives: A. Sierra Nevada bioregion, B. North section, C. South section)</i>	84-86
Map 10.	Study areas .....	100
Map 11.	Cascade and Modoc study area .....	103
Map 12.	North Sierra study area .....	110
Map 13.	South Sierra study area .....	124
Map 14.	East Sierra study area .....	132

### FIGURES

Figure 1.	Distribution of land ownership in Sierra Nevada bioregion .....	13
Figure 2.	Road density and land management in Sierra Nevada bioregion .....	26
Figure 3.	Rapid decline of carnivore species in Sierra Nevada over past 100 years .....	30
Figure 4.	Case study: Florida Greenway Program .....	38
Figure 5.	Planning process .....	49
Figure 6.	Results. <i>(A. Percentage of region occupied by Wildland Conservation Areas. B. Percentage occupied by Wildland Conservation Areas within subregions. C. Comparative representation analysis for Wildland Conservation Areas.)</i> .....	73
Figure 7.	EMDS knowledge-base diagram .....	187



— *Executive Summary* —





## *Executive Summary*

*“Knowing who we are and knowing where we are are intimately linked.”*

— Gary Snyder, 1995

Unique in its geographic expanse and biological wealth, the Sierra Nevada is undoubtedly California’s hallmark of wild places. Nowhere else in California do four ecologically distinct regions meet in one vast system. Yet the fabric that holds the Sierra’s complexity of habitats and wildlife together is rapidly unraveling.

This report, presented by the California Wilderness Coalition, through its California Wildlands Project, identifies lands in California’s Sierra Nevada bioregion that should be conserved as part of a comprehensive statewide program to ensure the long-term survival (400+ years) of the state’s rich biological diversity.

Tested principles of conservation biology and state-of-the-art planning techniques were employed to meet these objectives cartographically. A Geographic Information System (GIS) was used to develop maps identifying a network of interconnected areas that should be protected. In addition, the planning team set out to respond to various adverse ecological impacts and threats by developing a set of protection and restoration objectives based on the biological needs of ten focal wildlife species, including wide-ranging carnivores, while at the same time taking into consideration habitat integrity values and areas representative of major plant communities.

To achieve a modulated and realistic approach, the proposed plan identifies three functionally unique land classes:

### ***1. Wildland Conservation Areas***

Wildland Conservation Areas (WCA) are core areas of habitat that will maintain the viability of species over time (Schonewald-Cox 1983). Wildland Conservation Areas are large, contiguous, relatively undisturbed expanses of habitat that act as nodes within a Wildlands network. A distinguishing characteristic of Wildland Conservation Areas, or cores, is that there be limited human access, meaning low road density or, ideally, roadlessness (Noss et al 1999).

### ***2. Wildlands Linkages***

Wildland Linkages are bands of habitat that facilitate movement of animals, genetic material, seeds, wildfire and pollen between the Wildland Conservation Areas. These linkages prove to be vital to the success of any Wildlands Network because they prevent the isolation of habitat remnants. Isolated habitat fragments are proven to result in cumulative loss of species (Penrod et al. 2000).

### 3. Stewardship Zones

Stewardship zones are lands that surround Wildland Conservation Areas and buffer them from human activities that are not consistent with the maintenance of biodiversity. Although Stewardship Zones are designed to protect the core Wildland Conservation Areas, they are also designed to enable compatible economic activities that will allow local landowners and resource users to continue their livelihoods while contributing to the long-term preservation of the natural heritage of the region (Foreman et al. 2000).

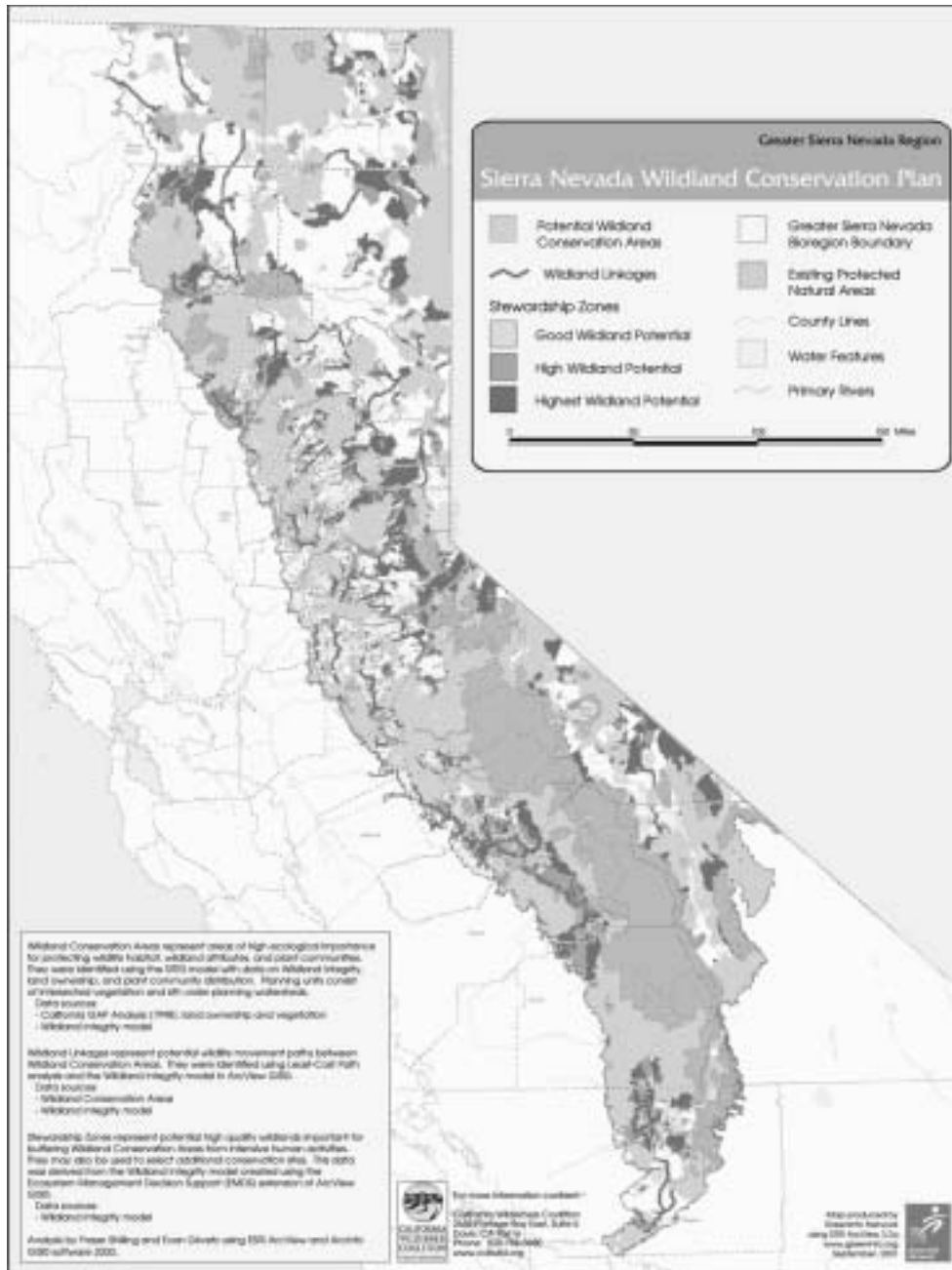

The above map of Sierra Nevada Wildland Conservation Plan is displayed in greater detail on page 84-86.

The proposed Wildland Conservation Areas, combined with existing protected areas, account for 15 million acres, or 52% of the land area in the Sierra Nevada bioregion, that is proposed for some degree of conservation. Given that a significant amount of this acreage is in existing wilderness areas and above the timber line, this percentage is reasonable and prudent.

Today less than 20% of the Sierra's ancient forests remain and four wildlife species have been pushed to local extinction. Additionally, many species are at risk or declining. Natural barometers of healthy, mature forests, such as the California spotted owl and Pacific fisher, have experienced dramatic population declines in the past few decades. Much of their forest habitat along the western slope of the Sierra Nevada lies in a patchwork of disconnected and simplified forest stands.

The Sierra has lost 16% of its diverse westside foothill habitats since 1960. The number of human residents in the foothill region is expected to triple within the next 40 years. Soon 40-80 people will inhabit every square mile of the north-central and southern foothills. Unless ecologically informed planning occurs, this will undoubtedly lead to a landscape of fragmented woodlands unable to sustain wildlife, such as mule deer, acorn woodpecker, and California spotted owl. In addition, critical wildlife migration routes are being severed or threatened throughout the region by development and roads.

Currently, our protected wildlands, such as parks, wilderness areas, and monuments, do not provide enough habitat to ensure the long-term survival of the many animal species in the region. Much of the biologically unique and diverse wildlands in the region are present at low to mid elevations, areas that are largely unprotected from development or resource extraction.

Somewhat paradoxically, the abundant and diverse natural heritage of the Sierra Nevada region is extremely valuable to local residents. A recent voter survey indicated over 60% of Sierra Nevada residents supported protecting the natural environment and preserving open space and agricultural lands (Sierra Business Council 1999). Moreover, as 60% of California's water supply flows from the Sierra Nevada, resource conservation in the region will ensure the protection of our water supply.

Guidelines for protecting and managing identified wildlands in the Sierra Nevada are included in this document to assist conservation practitioners and resource managers in the maintenance of vital wildlands and wildlife. These guidelines recommend limiting habitat fragmentation by controlling road density and habitat loss in wildlands. This will directly benefit wildlife species and maintain the health of ecosystems. Other guidelines recommend the establishment of conservation easements, wildlife friendly zoning ordinances, and wildlife under-and over-passes where roads prohibit movement. These guidelines will become more specific through the site planning process, which will be encouraged at the local scale.

## EXECUTIVE SUMMARY

---

Conservation planning is not a task that can be reduced to a series of equations. It is inherently a complex, and at times, untidy process requiring judgments on conservation priorities and planning approaches. Often, data on land cover (e.g. vegetation, habitat) are outdated or coarse in scale. This invariably means some areas identified by the conservation plan have already been degraded, which underscores the importance of refining the plan's configuration and boundaries at the local level. As planning moves forward, however, decision makers and stakeholders should recognize the accelerating trend of species and habitat loss that is occurring globally, nationally, and in the Sierra Nevada.

This study does not present a hard and fast measure of the minimum areas required for the long-term survival of the ten focal species. Questions of how much land the Pacific fisher or wolverine need to survive involve a complex understanding of population structure beyond the scope of this investigation. Indeed, the minimum may not be enough given environmental uncertainty at the landscape scale, for example, as a result of catastrophic fire or climate change.

The map in this section of Wildland Conservation Areas, Wildland Linkages, and Stewardship Zones (also found in greater detail in Maps 9 a, b, and c) is intended to guide the California Wilderness Coalition, partner organizations, decision makers, and stakeholders in land stewardship, conservation actions, and local-scale refinement. The Greater Sierra Nevada Wildlands Conservation Plan is designed to be an informative addition to the decision-maker's toolbox and should become integrated into local planning processes wherever possible. The California Wilderness Coalition anticipates developing this plan at the local level to reach a shared goal of protecting Sierra wildlands for future generations.

---

# *Introduction*

---



© Claus Sivert





## Introduction

The Sierra Nevada Wildlands Conservation Plan defines a long-term conservation horizon by identifying a system of wildlands and guidelines for their protection and management. Conceptually, it sets a regional context in which to guide local planning. The objectives of the Wildlands Conservation Plan are different from all other plans and policies in existence for the Sierra Nevada, because the Wildlands Conservation Plan promotes large and connected protected areas, maintenance and restoration of carnivores and keystone species, and the return of natural processes to Sierra Nevada ecosystems.

This document has multiple functions. First, it serves as a report of the processes used to develop a regional conservation plan, and their results. Secondly, it serves as a guide by recommending conservation and management guidelines and a template for conducting site planning. Two sets of complementary objectives summarize the document's purpose:

### PLANNING OBJECTIVES

- Assess the distribution of suitable habitat for focal species and of other important ecological attributes.
- Identify a minimum number of Wildland Conservation Areas that meet plant community representation goals and provide adequate habitat for focal species.
- Identify habitat linkages for focal species between Wildland Conservation Areas.
- Assess the effectiveness of this approach in protecting other important attributes of biodiversity.

### GUIDELINES

- To provide quantitative information on resource values to those interested in conservation planning and implementation in the Sierra Nevada.
- To identify areas that offer the greatest opportunity for conservation within the Sierra Nevada region.
- To provide a framework for initiating site conservation planning at local scales with links to regional needs.

Through the California Wildlands Project, the California Wilderness Coalition is developing a long-term strategy for preserving California's biological diversity. This strategy employs tenets of conservation biology, which suggest that an important aspect of conserving biological diversity is the protection of large, intact habitat areas for wide-ranging carnivores and other essential wildlife, and their migration routes. Through this program, we use the best available scientific information to identify a system of conservation opportunities throughout the state that will best preserve essential species of California wildlife. Planners, land managers, and policymakers can then use this information as they develop and update land use plans. To date, the Coalition has identified systems of wildlands in two ecoregions, the state's south coast and central coast. The Sierra Nevada is the subject of our third regional analysis.

How best to balance resource conservation with human use has long been, and continues to be, a primary subject of debate in the Sierra Nevada. The recently released Sierra Nevada Forest Plan Amendment, a management plan covering ten national forests within the Sierra, generated many thousands of public comments, with an overwhelming majority calling for increased natural resource protection.

Recent scientific reports have sharpened this debate. In 1996, after years of study, the University of California released a comprehensive study on the status of ecological, social, and economic health within the Sierra. The Sierra Nevada Ecosystem Project (SNEP) grew out of public concerns about the region's remaining old-growth forests; the four-volume report represents years of work by over 100 professionals and experts. The SNEP report is a seminal resource for land managers, planners, agency biologists, researchers, legislators, and the public.

Today, SNEP's findings are instrumental in helping guide land use, resource management and conservation decision making throughout the Sierra. The report details new information on current and projected land use, plant and animal diversity, the status of wildlife and plant communities, and threats to wildlife and forests. The report describes a dramatic loss of biological diversity as well as ongoing threats. Among the major findings are:

- Human population in the Sierra has doubled between 1970 and 1990, and is expected to triple between 1990 and 2040. Forty percent of this growth will largely be in the lower westside foothills, especially in Placer and El Dorado counties.
- Suburban and rural sprawl are the greatest threats to intact oak woodland habitats.
- Ancient forests of the Sierra have been reduced by 80% because of timber extraction.
- Forest-dwelling wildlife, especially those requiring specific old-growth habitat structure, are steadily declining toward local extinction.
- Aquatic habitats and amphibian species have been reduced and are imperiled by habitat loss because of roads, dams, and introduced non-native species.
- Pine forests on national forests, especially ponderosa and Jeffrey pine forests, have become greatly simplified in their structure due to repetitive timber extraction and wildfire suppression.
- Natural wildfires have historically been a vital component of healthy ecosystems in the Sierra.
- Ecosystem management should span political jurisdictions.

Unfortunately, SNEP does not provide policies for implementing its recommendations. In addition, while the Sierra Nevada Forest Plan Amendment presents an improvement in regional wildlife and wildlands management, it addressed National Forest lands only. Many of the issues that SNEP identified still await resolution.

A recent initiative of the California State Resources Agency, the California Legacy Project, aims to identify the state's conservation priorities and to target these areas for conservation. As California's population doubles in the next four decades, wildlife and wildlands will be affected both directly (sprawl) and indirectly (non-point source pollution). The Legacy Project advocates that California invest in habitat protection, and estimates it is necessary to protect an additional 80,000 to 1,800,000 acres of habitat statewide (Nichols 2001).

Implementing a long-term conservation blueprint will depend on strategic funding mechanisms at the national, state, and regional levels. The Legacy Project may prove instrumental in providing a real context for evaluating conservation tradeoffs within the Sierra Nevada. This evaluation process should shift from the state level to include more local representation about where conservation dollars are spent. In the meantime, regional plans, e.g. the Sierra Nevada Wildlands Conservation Plan outlined in this report, can inform land managers and land use planners of important conservation opportunities.

### USE OF THE WILDLANDS CONSERVATION PLAN

There are three sections of this publication that will guide those interested in conservation of wildlands in the Sierra Nevada: Results, Conservation and Management Guidelines, and Guidelines for Site Conservation Planning. The maps included in the results section will be of particular use in providing a framework for site conservation planning. The California Wilderness Coalition looks forward to working with stakeholders and other interested parties to apply the findings of this conservation plan.

### REPORT OVERVIEW

Section One provides an overview of the Sierra Nevada bioregion. Section Two details threats to biological diversity in the region. Section Three provides background on wildlands conservation planning in general. Section Four explains the methodology of our conservation planning effort. Section Five describes the results. Section Six provides a template for site conservation planning. Section Seven presents guidelines and management recommendations for implementation of the results, and Section Eight contains the report's conclusion. The appendices provide a summary of major maps, describe the species included in our planning effort, and describe our planning methodology in detail.



---

SECTION ONE

---

*Sierra Nevada Overview*





## Section One

### Sierra Nevada Overview

#### 1.1 ECOREGION PROFILES

The greater Sierra Nevada bioregion contains four distinct ecoregions: Sierra Nevada, Great Basin, Cascade Ranges, and the Modoc Plateau (Map 1). Together, these regions form a planning area of 119,785 (29 million acres), and cover approximately 29% of the state of California. Habitats include Great Basin high desert, coniferous forests, semi-desert scrub, and oak woodlands.

The spine of the Sierra Nevada extends some 870 kilometers south to north, linking the Mojave desert to the northwest forests of the Cascades. The diversity of life found in this terrain is profound. Not surprisingly, the Sierra Nevada is recognized as globally significant for its rare assemblage of biological and physical diversity. Following are descriptions of each distinct ecoregion.



*Map 1. Ecoregions of the Sierra Nevada bioregion.*

**Bioregion** is an assemblage of adjacent ecoregions sharing one or more natural phenomena.

**Ecoregion** is a large geographic unit that is distinctive in its assemblage of natural phenomena, such as ecosystems, geological structure, or range of plant and animal distributions.

##### *1.1.1 Modoc Plateau*

The volcanic tablelands of the Modoc Plateau are geologically distinct from the rest of the Sierra bioregion. Although the Modoc Plateau extends into Oregon, Nevada, and California, and is part of the Columbia Plateau, this assessment addresses only the California portion. Precipitation on the plateau ranges from 10" to 30" per year, increasing with elevation. The combination of volcanic soils, low temperatures, and precipitation extremes influences composition and structure of the dominant plant communities. The eastern portion of the plateau is largely covered by high desert Great Basin plant communities: sagebrush, bunchgrasses, bitterbrush, and western juniper, whereas the western slopes and higher elevations are vegetated with Jeffrey and yellow pine, white fir, incense cedar, other conifers, and aspen.

The Modoc Plateau has a rich history of large mammals; gray wolf, grizzly bear, and Roosevelt elk were once present, but have vanished through persecution and over-hunting. Pronghorn populations on the plateau were once diminishing, but are now generally stable. Sage grouse continue to inhabit sagebrush flats, yet are threatened by habitat destruction and harassment from motorized recreation and hunting. Livestock grazing in sage-scrub habitats of the Modoc Plateau pushed the sharp-tailed grouse to local

extinction in the 1800s (Jones and Stokes 1987). The Pacific Flyway crosses the plateau, providing a rest stop for the greater sandhill crane and other migratory birds.

The dominant land management agencies in the greater Sierra Nevada region are the Forest Service (32%) and the Bureau of Land Management (22%) (Davis et al. 1998). The majority of these lands are managed for multiple uses, including off-road vehicles, mining, grazing, and geothermal development that may or may not be conducive to protection of biological diversity. Private land comprises the smallest portion of land ownership in the region (Davis et al. 1998). Protected areas in the Modoc Plateau are small in terms of acreage and distribution compared to the amount of public land available. Lava Beds National Monument (46,949 acres) and the South Warner Wilderness Area (61,775 acres) provide the greatest biological protection in the region. The distribution of public land ownership in the Modoc Plateau provides many opportunities to expand existing protected areas as well as create new ones.

### *1.1.2 Cascade Ranges*

Volcanic cones, emblematic of Mount Shasta and Lassen Peak, characterize the volcanic history of the Cascade Ranges. Sharing a geologic history similar to the Modoc Plateau, the Cascades provide a unique connection between the northern Sierra Nevada and the rich biodiversity found in the Klamath-Siskiyou region.

Land ownership in the Cascade Ranges is nearly an inverse from the Modoc Plateau in that 54% of the ecoregion is in private ownership (Davis et al. 1998). Less than 10% of the ecoregion's biodiversity is protected by Lassen Volcanic National Park, Caribou Wilderness Area, Ishi Wilderness Area, Thousand Lakes Wilderness Area, Tehama Wildlife Area, and the Davis-Dye Creek Preserve. Due to the limited distribution and size of these protected areas, mid-elevation and foothill communities in the region are not adequately protected. As the US Forest Service manages 37.5% of the region, there are opportunities to expand and connect existing protected areas. Checkerboard ownership of Forest Service and private lands is present in the central and northern portions of the ecoregion.

Vegetation in the Cascade Ranges is diverse; it includes: chaparral and oak woodland mosaic, sagebrush scrub, grasslands, mixed conifer forests, and ponderosa and Jeffrey pine forests. A majority of the chaparral, grasslands, and oak forests at low to mid elevations are unprotected (Davis et al. 1998). The locally extinct grizzly bear and gray wolf historically inhabited portions of the Cascade Ranges. Old-growth pine and fir forests in the Lassen National Forest are a critical link between the northern Sierra and Klamath-Siskiyou ecoregions. This Cascade link promotes genetic exchange between populations of the Pacific fisher and the California spotted owl.

### *1.1.3 Sierra Nevada*

The Sierra Nevada is the most geographically and ecologically complex ecoregion in the bioregion. Encompassing numerous mountain ranges and river canyons between the North Fork of the Feather River and the Tehachapi range, the Sierra Nevada is rich in plant and animal diversity. The climatic variations of the region are unique, as shifts in elevation and latitude define subregional climate differences. The westside foothills of the Sierra have a Mediterranean climate of wet winters and dry summers. Middle and upper elevations have cool summers and wet, snowy winters.



Plant communities of the Sierra are incredibly varied. Representative are the arid, desert-influenced scrub communities of the south-facing foothills near the Tehachapi mountains, the lush oak forests along the westside foothills, grasslands, old-growth coniferous forests, riparian galleries along wild rivers and creeks, vast wet meadows, aspen groves, and high altitude tundra communities. The conifer forests of the Sierra ecoregion are considered globally distinct (Olson and Dinerstein 1998).

Biological diversity in the Sierra ecoregion is impressive, with 401 species of vertebrates (Graber 1996). These species account for two-thirds of all vertebrate species that occur in the state. The Sierra is inhabited by a diverse assemblage of predator species: Pacific fisher, marten, Sierra Nevada red fox, and mountain lion. Since the mid-1800s, the grizzly bear, gray wolf, condor, and Bell's vireo have disappeared in the region due to predator control, hunting, and habitat loss. The oak woodlands along the Sierra westside harbor more vertebrate species than any other habitat in California (Montroni et al. 1991).

Sixty-three percent of the Sierra Nevada is publicly owned (Davis et al. 1998). The Forest Service is the dominant land manager, overseeing 47% of the mid- and high elevation habitat throughout eight national forests (Davis et al. 1998). Most of the private lands in the region are located along the westside foothills, between 500' and 4000' elevation, which are approximately 85% privately owned. Just 15% of the Sierra ecoregion is well protected as wilderness, national park, state park, and other private preserve. The largest protected area complex is 3 million acres in the southern Sierra at mid- and high elevations: Yosemite National Park, Sequoia-Kings Canyon National Park, Sequoia National Monument, and adjacent wilderness areas (Davis et al. 1998).

#### *1.1.4 East Sierra*

The western portion of the Great Basin flanks the Sierra Nevada's steep eastern boundary. Known for its White Mountains and tranquil sagebrush basins, much of the Great Basin rests in the rain shadow of the Sierra range. Providing a connection to Mojave desert plant communities, the ecoregion is generally arid except in the winter months when there is snowfall.

Sagebrush and other scrub communities are dominant at lower elevations and are unprotected due to public land multiple-use policies. Jeffrey pine and aspen, found in the mountains, are also little protected. Only the desert scrub communities, Joshua tree forests, and bristlecone pine forests found in Death Valley National Park are well protected.

Wildlife is diverse in the region due to topographic variability. In the fir forests of the White Mountains, marten and wolverine occurred historically. Sagebrush habitats support populations of sage grouse and pronghorn. Mule deer migrate from valley floor wintering grounds to higher elevation rangelands during the summer.

Ninety-four percent of the Great Basin ecoregion is publicly owned, with the Forest Service and Bureau of Land Management managing 75% of the region (Davis et al. 1998). The California Desert Protection Act of 1994 established the Death Valley National Park and Inyo Mountain Wilderness in the region's southeast corner, where Mojave desert influences are visible. Less than 6% of the region is held in private ownership.

## 1.2 BIODIVERSITY

*Biodiversity: The variety of life and its processes, it includes the variety of living organisms, the genetic differences among them, the communities and ecosystems in which they occur, and the ecological and evolutionary processes that keep them functioning, yet ever changing and adapting.*

— Noss, Cooperider, 1994

California is the most floristically rich state and is renowned for its diversity of plants, animals, geology, and geography. The Sierra Nevada supports one-half of the more than 6,000 plant species found in California. Over four hundred of these Sierra plants are endemic, or naturally restricted to living within the Sierra's boundaries. Additionally, half of these endemic plants are rare to the Sierra Nevada and California (Shevock 1996).

The Sierra bioregion contains approximately 88 native plant communities (Davis et al. 1998). Moyle and Ellison (1991) identified 66 aquatic habitat communities in the Sierra ecoregion alone. Sixty percent of California's animal species are found in the Sierra ecoregion. Of these, 300 species, or 13%, are endemic to the Sierra Nevada ecoregion. Of these, 110 are mammals (Zeiner et al. 1990). Additionally, 365 species of wildlife use the Sierra ecoregion as a major component of their total range (CDFG 2000). The mosaic of habitats of the westside foothills provides 85 wildlife species with important seasonal or year-round habitat (Graber 1996). The Sierra harbors more endemic aquatic invertebrates than are found anywhere else on Earth (Erman 1996).

Geography plays a large role in where plant and animal species thrive and congregate. Patterns and levels of biodiversity are pronounced where changes in elevation are abrupt over a short distance, such as in the southern Sierra. Broad patterns of habitats run north to south along elevation zones: grasslands, oak woodlands, oak-pine forest intermix, mixed conifer forests, alpine, and Great Basin sage-scrub. Smaller patterns of plant diversity are found along east to west riparian corridors, river canyons, wet meadows near old-growth forests, and in drainages (Graber 1996).

An abundance of the biodiversity of the Sierra is found along the westside foothills and within prominent river canyons, especially the Kern, Kings, Merced, San Joaquin, Tuolumne, and Feather River canyons. Patterns of biodiversity are also distinct along the north and south axis due to changes in the distribution of many plant communities. In the mixed conifer forest ecosystem of the Sierra westside, plant diversity changes by two species for every mile north-south (Walker 1992). This is referred to as species turnover, a natural phenomenon, and is a significant measure of the remarkable biodiversity of the Sierra. Species turnover accounts for subregional distinctions in plant and animal diversity: conifer forests found in the northern region share only one half of their species with similar forests in the southern Sierra. Conservation goals should therefore be unique for the north and south zones.

### 1.3 LAND USE

#### 1.3.1 Distribution of land management

Land ownership in the greater Sierra Nevada bioregion is approximately 60% public, with the Forest Service managing 41%, the Bureau of Land Management 11%, the National Park Service 7%, the US Fish & Wildlife Service 0.3%, the state of California 1%, and the rest owned by county governments and the military (Davis et al. 1998). Other ownership in the region includes Native American tribal lands, private nature preserves, and private lands (Table 1, Map 2, and Figure 1).

Figure 1. Distribution of land ownership in the Sierra Nevada bioregion

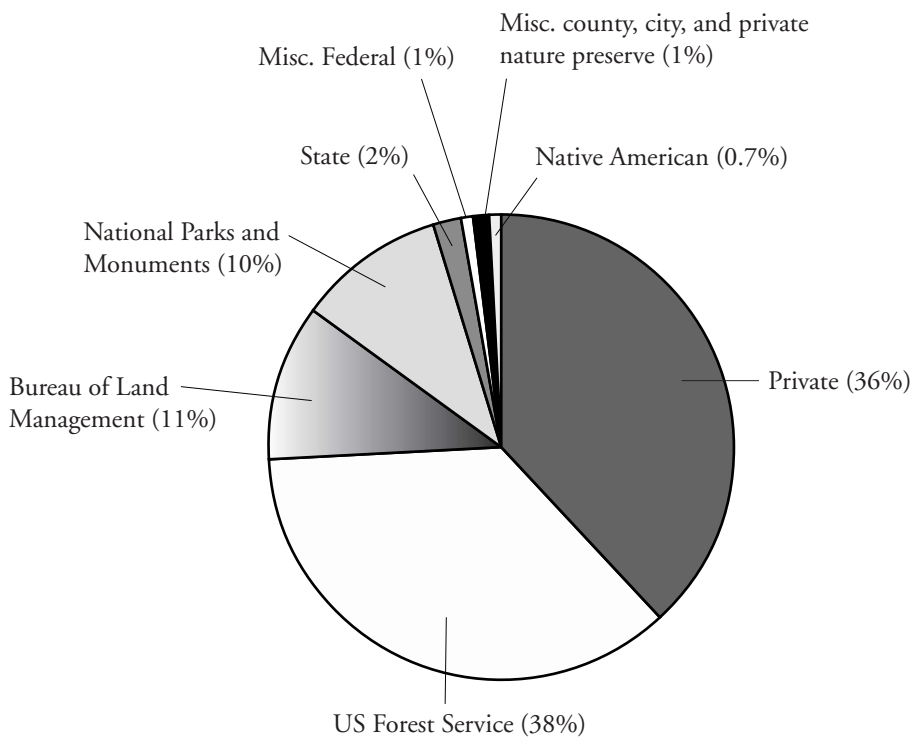

Table 1. Land ownership in greater Sierra Nevada bioregion

OWNERSHIP	ACRES
US National Forest Service	12,290,263
Private	10,866,115
Bureau of Land Management	3,141,047
National Park Service	1,935,021
Water Districts etc.	360,939
Waters	213,080
California Dept. of Fish and Game	179,283
US Fish and Wildlife Service	106,297
State Lands-State Lands Commission	97,223
Army	82,512
Native American Lands	78,563
California Dept. of Parks and Recreation	58,197
Army Corps of Engineers	47,568
National Monument	47,506
The Nature Conservancy	35,123
US Bureau of Reclamation	33,974
California Dept. of Forestry & Fire Protection	13,743
County-City-Regional Parks and Preserves	6,230
Military-unknown branch	2,031
National Seashore or National Recreation Area	1,431
Other Conservancy; Land Trust; Private University	640
County-City-Regional Lands	580
Air Force	256
<b>Total Acres</b>	<b>29,597,621</b>

The California GAP Analysis Project (Davis et al. 1998) categorized California's land ownership into four status types based on likelihood of current land management to maintain natural resources (Table 2). The GAP Analysis program analyzed existing land management, its distribution over landscapes, and the interrelationships between land management and the protection of biodiversity with an emphasis on plant communities. The distribution and extent of GAP management classes in the Sierra Nevada indicate the present level of nature protection and resource management in the region (Table 3). Changes in management due to the Sierra Nevada Forest Plan Amendment (USDA 2001) are not reflected in the GAP Analysis figures.

Map 2. Land ownership in the greater Sierra Nevada bioregion

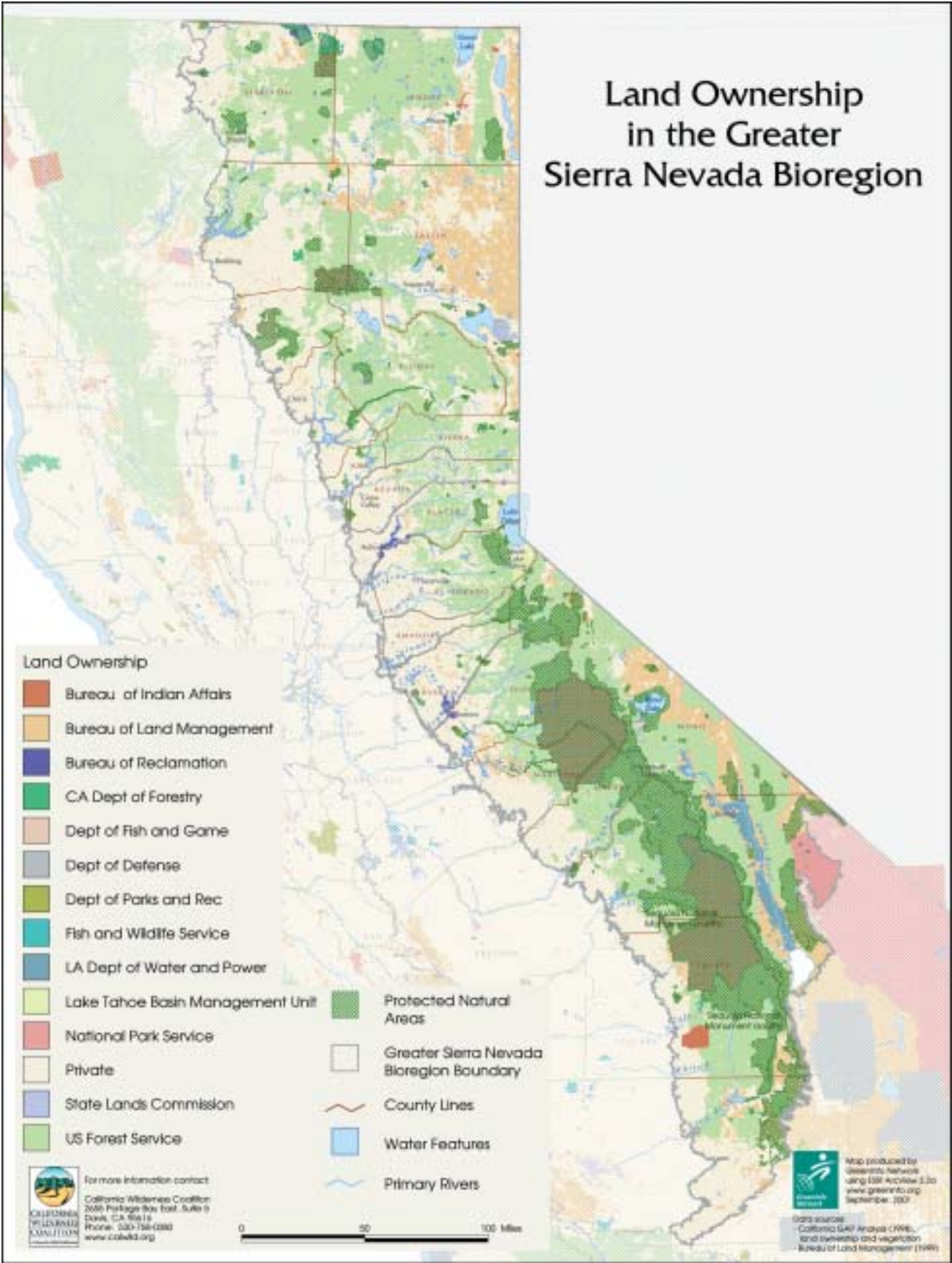

Table 2. Land management classes as defined by the GAP Analysis Program

<b>Status 1.</b>	An area having permanent protection from conversion of natural land cover and a mandated management plan in operation to maintain a natural state within which disturbance events are allowed to proceed without interference or are mimicked through management. Example: wilderness areas, national parks, national monuments, and private nature reserves.
<b>Status 2.</b>	An area having permanent protection from conversion of natural land cover and a mandated management plan in operation to maintain a primarily natural state, but which may receive use or management practices that degrade the quality of existing natural communities. Example: state parks.
<b>Status 3.</b>	An area having permanent protection from conversion of natural land cover for the majority of the area, but are subject to extractive uses of either a broad, low-intensity type or localized intense type. It also confers protection to federally listed endangered and threatened species throughout the area. Example: multiple-use National Forest and Bureau of Land Management lands, state forests, county and regional parks.
<b>Status 4.</b>	Lack of irrevocable easement or mandate to prevent conversion of natural habitat types to anthropogenic habitat types* and allow for intensive use throughout the tract, or existence of such restrictions is unknown. Examples: private lands, Native American lands, and some military bases.

\* Anthropogenic refers to human created habitat such as agricultural land.

Table 3. Percent of land by management status in the greater Sierra Nevada bioregion according to the California GAP Analysis (Davis et al. 1998).

GAP MANAGEMENT CLASS	% OF SIERRA BIOREGION
1	10
2	4
3	52
4	34



The distribution of GAP management status in the Sierra bioregion is highly varied. Many habitats, and in some cases entire ecosystems, are classified as GAP status 3 or 4, which means they are susceptible to human activities (such as development, motorized recreation, grazing, and timber extraction) that are not consistent with the maintenance of biodiversity. High elevation forests and shrub-lands are well protected by parks and wilderness areas, especially in the southern westside Sierra, leaving at risk the biologically rich Great Basin, mixed conifer, riparian, and oak woodland habitats. Of habitats below 1000 meters, 80% are privately owned. The most vulnerable sites of biodiversity in the northern Sierra are lower elevation montane forests and oak woodlands (Davis et al. 1998).

Most abundant in the bioregion is GAP status 3, which applies to general Forest Service and BLM lands that manage for multiple uses of natural resources. GAP status 3 lands occupy much of the mixed conifer forests on the Sierra's westside and sage-scrub habitats along the eastside and Modoc Plateau. Private lands interface in a checkerboard fashion with multiple use lands to confound ecosystem management. Regionally, private lands account for 80% of the westside oak woodland and half of the Cascade Ranges.

### *1.3.2 Gaps in protection of natural resources*

The present conservation arrangement in the bioregion consists of federal wilderness areas, national parks, national monuments, wildlife refuges, state parks, and private nature preserves (Table 4). The largest protected areas in the Sierra bioregion are in the southern forests at Yosemite National Park (746,121 acres) and Sequoia National Park (861,076 acres). These national parks combine with adjacent federal wilderness areas to form an impressive complex of approximately 13,500 (3.3 million acres) (Davis et al. 1998).

Nonetheless, the Sierra bioregion as a whole has sizable gaps in its distribution of protected areas. Nature protection is heavily oriented to the southern half of the bioregion's middle to high elevations in wilderness areas, national parks and monuments. Entire subregions remain wholly unprotected. For example, less than 1% of the westside foothill habitat is protected (Davis et al. 1998).

The majority of protected areas in the central Sierra are found at higher elevations, leaving much of the biologically rich mid-elevation forests at risk to development. Protected areas in the Cascade Ranges and Modoc Plateau subregions are generally not great in size and are significantly isolated from one another. A mere 13% of the habitats found in the Cascade Ranges and Modoc Plateau ecoregions are protected. This illustrates a lack of a regional strategy for preserving the habitats and wildlife of these ecoregions.

Table 4. Protected areas in the greater Sierra Nevada bioregion (CA GAP classes 1 and 2).

OWNER AND MANAGEMENT TYPE	ACRES (SUBTOTAL)	ACRES (TOTAL)
<i>Private natural areas and preserves</i>		37,587
The Nature Conservancy	35,123	
Private	1,824	
Other Conservancy; Land Trust; Private University	640	
<i>State of California</i>		
<b>California Dept. of Fish and Game</b>		178,400
Wildlife Area	202,845	
Ecological Reserve	2,390	
Preserve	1,691	
<b>California Dept. of Parks and Recreation</b>		24,775
State Park	24,775	
State Lands-State Lands Commission		444
<i>Federal</i>		
<b>Army Corps of Engineers</b>		1,323
South Fork Wildlife Area	1,323	
<b>US National Forest</b>		2,825,703
Wilderness Area	1,997,579	
Research Natural Area	376,430	
Special Interest Area	285,045	
Special Management Area	51,204	
Experimental Forest	25,034	
Scenic Area	90,411	
<b>National Monument</b>	47,506	47,506
<b>National Recreation Area</b>	1,431	1,431
<b>US Bureau of Land Management</b>		453,763
Wilderness Area	314,213	
Area of Critical Environmental Concern	136,265	
Wilderness Study Area	1,205	
Wild & Scenic	344	
Conservation Easement	1,736	
<b>US Fish and Wildlife Service</b>		106,297
Wildlife Refuge	106,297	
<b>US National Park Service</b>		1,935,021
National Park	1,856,988	
Wilderness	78,033	
<b>Total Acres Protected</b>		<b>5,612,250</b>



SECTION TWO

*Ecological Threats*



Quaking Aspen  
*Populus tremuloides*



## Section Two

### Ecological Threats

*One of the penalties of an ecological education is that one lives alone in a world of wounds. Much of the damage inflicted on land is quite invisible to laymen. An ecologist must either harden his shell and make believe that the consequences of science are none of his business, or he must be the doctor who sees the marks of death in a community that believes itself well and does not want to be told otherwise.*

— Aldo Leopold

#### 2.1 INTRODUCTION

The fabric of life that makes up the Sierra landscape is unraveling at a precipitous rate. Once-intact forests and woodlands are being broken up into smaller patches. Clear-cuts, roads, and development are causing tremendous impacts. What remains is a land fragmented, broken into smaller pieces that become “leaky ships” (Soulé 1999), habitat islands slowly eroding, losing their capacity to provide food and shelter for wildlife. The smaller and more isolated these remnant patches of habitat become, the leakier they are.

The settlement of Anglo-American immigrants in California in the early 1800s brought drastic changes to Sierra Nevada ecosystems. While there have been, and continue to be, numerous cases of sustainable land use practices in the Sierra on both public and private lands, the cumulative effects of land use practices have taken a major toll on biodiversity and natural processes. From commercial forestry to the eradication of majestic large predators, the Sierra landscape has clearly suffered from the “tyranny of small decisions.”

In the last 150 years, California has grown more populous and mechanized. The resulting demands for nature’s goods and services have left a very serious impact on the Sierra bioregion. Much of the old-growth forests have been removed, virtually every major river has been dammed, once-intact forests are now critically fragmented, and populations of large predators and keystone species have been removed or decimated. These impacts are not necessarily reversible. As the ecological insults have affected the Sierra bioregion as a whole, a vision to address them with current ecological understanding must address the whole region.

The biological diversity in the Sierra Nevada is in jeopardy because of our own population growth. The Sierra Nevada Ecosystem Project identified the following threats to the Sierra region’s assemblage of plants, wildlife, natural processes, and wildlands:

- Habitat fragmentation
  - Land subdivision and costly development
  - Roads that bisect wildlife movement routes

- Habitat loss
  - Removal of old-growth forests, riparian forests, oak woodlands, meadows, and grasslands
  - Loss of continuous forest cover
- Species loss, especially of important keystone species
- Introduction of non-native plants and animals
- Tampering with natural fire and flood cycles
- Simplification of forest species diversity and structure
- Overgrazing
- Disruption of river flows by dams
- Habitat degradation
  - Silt runoff into aquatic habitats from dirt roads near streams
  - Unregulated off-road vehicle recreation in wildlands
  - Commercial logging
  - Lack of management for whole ecosystems

### 2.2 HABITAT FRAGMENTATION

Habitat fragmentation can be generally defined as “the breaking up of a habitat, ecosystem, or land-use type into smaller parcels” (Forman 1995). Unless restored, the reduction of habitat into smaller, isolated blocks is the beginning of the end for many plants and animals that have adapted to a continuous and intact ecosystem. Recent ecological research has focused on measuring the direct and indirect effects of habitat fragmentation on the environment (Wilcox and Murphy 1985; Harris and Gallagher 1989; Debinski and Holt 2000). Although this research is only now gaining momentum, it has provided significant insight about the key effects that habitat fragmentation has on biodiversity (Table 5).

Table 5. Effects of habitat fragmentation on the environment

EFFECT	DESCRIPTION	SIERRA EXAMPLE
Area effect	Large patches of habitat are more likely to maintain species and be more resilient to impacts over time than small patches.	Montroni et al. (1991) found that larger habitat patches in oak woodlands supported more species of birds than smaller patches of the same habitat.  The Pacific fisher, a small carnivore of the weasel family, has vanished from the north and central Sierra (Truex 1998). What was once prime Pacific fisher habitat is now a mosaic of small patches, often isolated by severely altered landscapes.
Edge effect	The more complex a reserve's boundary is (zig-zag vs. straight), the more vulnerable its interior is to external impacts such as wind, fire, humans, and invasion by exotic pest species, parasites and predators. The boundary to area ratio indicates the vulnerability of the interior habitat to outside forces.	Brown-headed cowbirds reduce nesting success for Sierran songbirds at forest edges (CPIF 2000).
Isolation effect	Connected habitat is better than isolated habitat. If habitats are connected, then the landscape can support wildlife migration, genetic diversity, and natural cycles such as wildfire.	Parks and wilderness areas in the Sierra Nevada are too few and too isolated from each other to support populations of large carnivores that have demanding area needs, such as the wolverine (Newmark 1995).

### 2.2.1 Causes of habitat fragmentation

Habitat fragmentation is the transformation of intact habitat into smaller habitat islands that are isolated by man-made barriers (i.e. roads) or habitat modification (i.e. agriculture or clear-cuts) (Noss and Csuit 1994). Some events of fragmentation are more permanent than others. Major causes of habitat fragmentation in the Sierra Nevada include:

- **Roads**

Roads are a major and persistent source of habitat fragmentation in the Sierra. There are 26,000 miles of roads on National Forests in the Sierra (Teale Data Center, USFS). Major highway corridors Interstate 80 and Highway 50 bisect central Sierra woodlands and forests with high traffic and speed conditions. Roads segment forest habitat regionwide and are a documented source of mortality for Pacific fisher (Center for Biological Diversity 2000).

- **Development**

Westside foothill habitat is being destroyed and divided by small-lot residential development at an alarming rate, and will continue to be lost as population pressures accelerate in coming decades. Of the Sierra's oak woodlands, 16% have already been developed or converted to agricultural use and 98% of those remaining are unprotected and vulnerable to development. By way of example, a recent decision by the Placer County Board of Supervisors approved the Bickford Ranch development project, which will remove 10,000 blue oaks and replace them with homes and a golf course. It is decisions such as these that illustrate that adopting a wildlands network vision on the local level can assist the creation of appropriate local zoning that prioritizes the preservation of habitat and habitat linkages.

Habitat connectivity in the foothills is critical for migrating wildlife that use oak woodlands seasonally, such as mule deer herds, song birds, and rare species like the California spotted owl. Between 1990 and 1995, all counties in the southern Sierra (except Kern County) experienced significant loss of their oak woodlands to development.

- **Habitat conversion**

Oak woodlands have suffered the greatest impact from habitat conversion. Conversion of habitats, especially oak woodlands, to rangeland occurred mostly between 1945 and 1973, while the most recent trend is toward vineyard development in the foothill counties. In recent years, hardwood removal has been greatest in Kern, Madera, and Mariposa counties (Levien et al. 1999).

- **Timber harvest**

Logging is an historically recent land use throughout Sierra pine and fir forests (Helms and Tappeiner 1996). Commercial harvests account for a high degree of mixed-pine forest fragmentation on private and public land. Clear-cut harvest practices have resulted in a landscape of smaller habitat patches.

- **Wildfire**

Although wildfires are a desired natural process, poor forestry practices have created unnatural fire conditions that have resulted in large, devastating fires on public lands. Between 1990 and 1995, wildfires affected twice as many acres of mixed-pine forests in the southern Sierra as did logging. Also during this period, wildfires caused the greatest loss of vegetation in oak woodlands and mixed pine forests on public and private lands in the Sierra (Levien et al. 1999).

- **Checkerboard ownership**

Areas of Lassen and Tahoe National Forests are plagued with land ownership that is patterned in a checkerboard of private and public ownership. In the Tahoe National Forest, mixed-conifer forest, an important habitat of the Pacific fisher, is scarred by a patchwork of clear-cuts. True ecosystem management is made difficult to impossible by checkerboard ownership conditions.

**CASE STUDY: THE TAHOE GAP**

A classic example of the challenges that checkerboard ownership poses to biodiversity protection lies in the central Sierra. Highly fragmented Forest Service lands located between the Sierra Crest at Lake Tahoe and the westside oak woodlands, termed the Tahoe Gap, are plagued by clear-cuts, roads, and two major traffic corridors (Interstate 80 and Highway 50). The Plumas, Tahoe, and Eldorado National Forests comprise the Tahoe Gap, intermixed with checkerboard squares owned largely by timber companies. The Tahoe Gap is an artifact of the federal land giveaway to the railroad companies in the nineteenth century. In some areas, the railroad companies received 20 mile-wide tracts north and south of what is now Interstate 80. Eventually, railroad holdings were acquired by private timber corporations. Checkerboard ownership causes habitat fragmentation. Large blocks of contiguous closed canopy habitat, for example, are currently impossible to find.

**2.2.2 Roads**

Ecological impacts of roads in the Sierra Nevada are gaining the attention by researchers and public wildlife and land managers (SNERR 1999). While cumulative density of roads in habitats is not widely addressed by land agencies and local governments, a few roadkill hotspots are receiving attention from game management agencies, especially where mule deer are affected.

Roads impoverish habitat for terrestrial and aquatic species in the Sierra because they fragment once-intact habitat, provide access for resource extraction and motorized recreation, and increase soil erosion. Paved surfaces are generally a more formidable barrier to wildlife movement as they promote greater vehicle speeds and traffic volume. Unpaved roads invite timber and motorized recreation interests to the core of wildlife refugia.

Current research indicates that roads have many impacts on the natural world. Yet, all roads are not created equal. There are many types of roads, and each plays a unique role in the environment. Roads may fragment habitat, cause mortality to wildlife, spread invasive weeds, increase motorized access to sensitive habitats, and cause many other types of damage. As an example, paved roads, especially with high traffic volumes, pose a greater threat to dispersing wildlife than a lightly traveled rural route or primitive backcountry jeep trail. In contrast, a primitive backcountry trail provides hunters and motorized vehicles with access to the interior of forests where sensitive wildlife such as the wolverine and Pacific fisher seek refuge.

Roads have the following effects on wildlife and wildlands in the Sierra bioregion:

- Roads block wildlife movement.
- Areas with high road densities impact watersheds by increasing sediment load into streams, which is correlated with reduced aquatic species diversity and overall habitat conditions (Costick 1996, Moyle and Randall 1996, Kondolf et al. 1996).
- Roads provide conduits for non-native plant species to spread (Schwartz et al. 1996).
- Roads are a major cause of ancient forest fragmentation on Forest Service lands in the Sierra (Franklin and Fites 1996).
- Roads are a source of mortality to birds and forest-dwelling mammals.

In the summer season, these roads receive high use by motorized vehicles, and in the winter, snowmobile use is extensive (Shore 2000). The regional road network surrounds and threatens approximately 2.4 million acres of roadless areas in national forests. Although road building is declining on Forest Service land, the existing roads pose a continual threat to wildlife and wildlands (Figure 2).

*Figure 2. Road density and land management in the greater Sierra Nevada bio-region (Source data from CA-GAP Analysis, Teale Data Center, and USFS).*

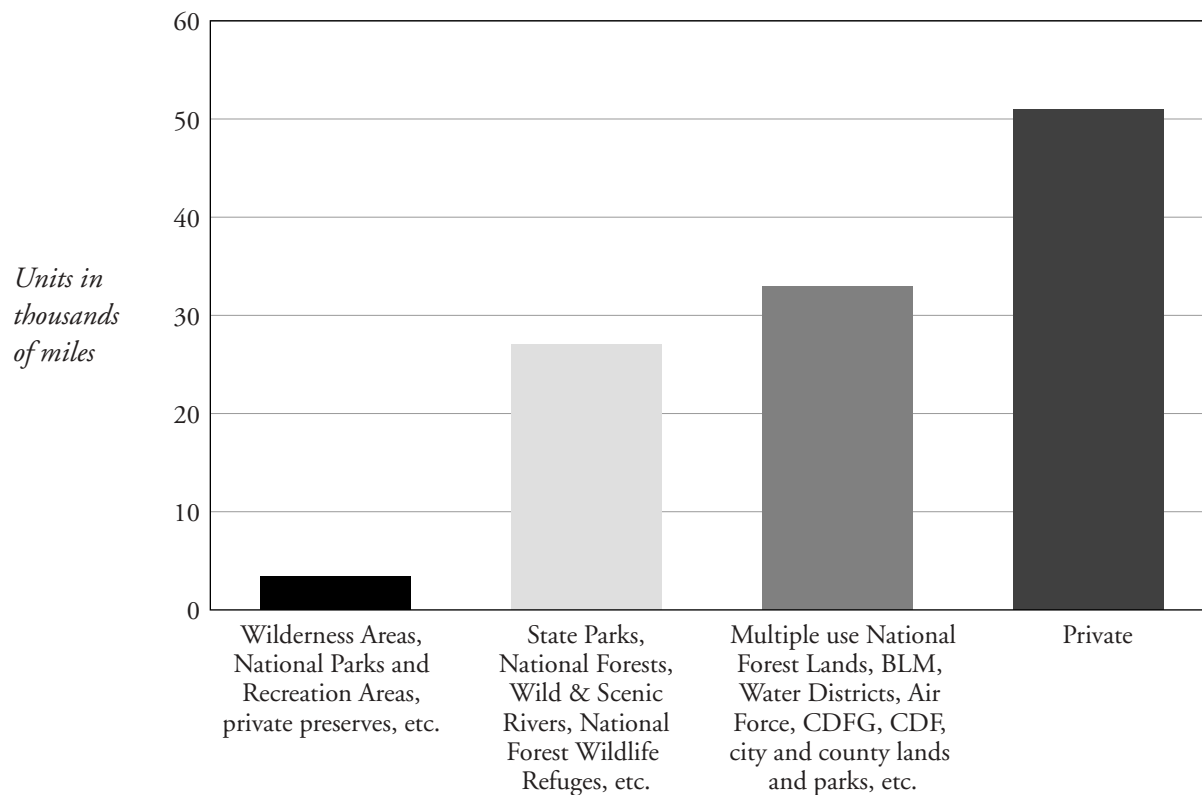

### *Impacts of roads on wildlife populations*

The impacts that roads have on wildlife and wildlands is an issue requiring immediate attention in both regional and site planning (Trombulak and Frissell 2000). Roads can be formidable long-term barriers to terrestrial and aquatic species. A recent review of the ecological effect of roads on wildlife identified seven impacts roads are known to have on their biological surroundings (Forman 1998):

1. Mortality from road construction;
2. Mortality from collision with vehicles;
3. Modification of animal behavior;
4. Alteration of physical environment;



5. Alteration of chemical environment;
6. Spread of exotics;
7. Increased human use (hunting, fishing, harassment of animals, and landscape modification).

For large predators such as the wolf, mountain lion, and grizzly bear, roadkill is the greatest source of mortality in North America (Paquet 1993, Harris and Gallagher 1989, Noss et al. 1996). In addition, major highways and rural routes in the Sierra, such as Interstate 80 through the Tahoe Gap and Highway 49 along the westside foothills, are well known roadkill hotspots for mule deer and Pacific fisher. Mule deer attempting to cross sections of Interstate 80 between 1984 and 1999 were killed by vehicles at a higher rate than other highways in that region during the same period (Table 6). Roads threaten 8 out of 24 Sierra Nevada linkages identified by conservation biologists (Penrod et al. 2000). Addressing these barriers will require more site-specific planning that defines alternative crossing paths for one or more target species (Smith 1999, Jackson 1999, Alexander and Waters 1999). Providing alternative crossing points is necessary for several reasons. For example, it allows prey species to avoid predator ambushes. Road densities on Forest Service lands correlate to increased logging and mining activity, which decrease the presence of large predators and the maintenance of biodiversity in general (Soulé 1999).

*Table 6. Mule deer mortality on Sierra highways from 1984 to 1999 (Source: California Dept. of Transportation).*

HIGHWAY OR ROUTE	MULE DEER KILLED
20	149
30	398
49	1163
50	605
80	1613
88	240
89	1131
120	120
140	247

### 2.3 SPECIES LOSS

Of the 401 species of vertebrates (mammals, birds, rodents, and amphibians) that occur in the Sierra Nevada (Modoc Plateau and Cascade Ranges excluded), 17% are at risk (Graber 1996). There are currently 200 rare plant species in the Sierra (Graber 1998). Lack of ecologically informed resource management has impacted wildlife populations region-wide (Table 7). Restoring the full spectrum of native biodiversity to the Sierra will require immediate shifts in how natural resources are managed.

**SIERRA NEVADA**  
**Wildland Conservation Plan**

*Table 7. Prominent threats to wildlife in Sierra Nevada bioregion*

<b>THREAT</b>	<b>SPECIES</b>	<b>SUBREGION</b>
<b>Human disturbance or persecution</b>	Gray wolf	Modoc, Cascades
	Wolverine	Sierra Nevada
	Bighorn sheep	East Sierra
	Bats (colonial)	All regions
	Sage grouse	Modoc, East Sierra
	Bald eagle	Modoc
	Colonial wetland birds	Modoc
<b>Barriers to movement (e.g. migration)</b>	Pronghorn	Modoc, East Sierra
	Bighorn sheep	East Sierra
<b>Timber harvest or firewood-cutting</b>	Pacific fisher	Sierra Nevada
	Pine marten	Sierra Nevada
	California spotted owl	Sierra Nevada
	Northern goshawk	Sierra Nevada
	Acorn woodpecker	Foothills
	Band-tailed pigeon	Foothills
	Wood duck	Foothills
	Nuttall's woodpecker	Foothills
	Red-shouldered hawk	Foothills
	Swainson's hawk	Modoc
	Riparian health indicators	All regions
<b>Sagebrush conversion</b>	Sage grouse	Modoc, East Sierra
	Pronghorn	Modoc, East Sierra
<b>Overgrazing or Competition with livestock</b>	Willow flycatcher	Sierra Nevada
	Pronghorn	Modoc, East Sierra
	Sage grouse	Modoc, East Sierra
	Pygmy rabbit	East Sierra
	White-tailed hare	Sierra Nevada
	Aspen community birds	East Sierra
<b>Disease transmission from livestock</b>	Bighorn sheep	East Sierra
<b>Multiple aquatic stressors</b>	Ranid frogs	All regions
	Most salamanders	All regions
<b>Insecticide use</b>	Bats	All regions
	Swifts, purple martin	Sierra Nevada
<b>Wetland drainage or diversion</b>	Greater sandhill crane	Modoc
	Sage grouse	Modoc, East Sierra
	American bittern	Modoc
<b>Predation</b>	Bighorn sheep	East Sierra
<b>Dams, reservoirs, and water withdrawal</b>	Migratory salmon	All regions
	Bank swallow	Modoc
	Belted kingfisher	Sierra Nevada
	American dipper	Sierra Nevada
	Yellow-breasted chat	Foothills
	Native aquatic species	All regions
<b>Nest parasitism</b>	Willow flycatcher	Sierra Nevada
	Various warblers	Sierra, Foothills
<b>Rodent control</b>	Badger	Modoc
<b>Urbanization</b>	Many species	Especially Foothills

We are currently in the world's sixth global extinction event. Prominent scientists of our day have measured current extinction rates with those that should normally occur, known as the "background" extinction rate. Based on these comparisons, current extinction is believed to be about 100 times the background rate, possibly 1000 times the background rate in the world's rainforests (Ehrlich and Ehrlich 1981; Wilson 1992). For the first time in the earth's history, human actions are responsible for the present extinction crisis.

In the past two centuries, five vertebrate species have been forced to local extinction in the Sierra bioregion: grizzly bear, gray wolf, California Condor, Least Bell's Vireo, and Sharp-Tailed Grouse (Table 8). Numerous plants and animals are in decline in the Sierra, holding on to a small fragment of their historic range. A few of these species are indicators of the quality of habitat in which they reside. The California red-legged frog, once well distributed through the region, is absent in the southern Sierra and only present in a few pockets in the northern Sierra Nevada. The Pacific fisher once extended throughout old-growth mixed conifer forests along the mid-elevation western slope. Unless restored, the present population of Pacific fisher in southern Sierra conifer forests is not expected to maintain genetic vigor beyond 50 years (Barrett 2000).

Table 8. Major extinction events in past 100 years

SPECIES	LAST WILD SIGHTING IN SIERRA	CURRENT PROTECTION STATUS
Least Bell's vireo	unknown	Endangered, state and federal
California condor	Kern County, 1987	Endangered, state and federal
Grizzly bear	Sequoia Nat. Forest, 1922	Endangered, federal
Gray wolf	Modoc Plateau, 1922	Endangered, federal
Sharp-tailed grouse	unknown, mid 1800s	not listed

### 2.3.1 Land birds

Land bird populations in the Sierra Nevada have been impacted by reduced breeding and wintering habitat availability, a consequence of human activities, such as: livestock grazing in montane wet meadows, sagebrush, and riparian habitat; logging; development; pesticide use; fire cycle suppression; and increased recreation (Graber, 1998). Where oak woodlands are degraded, oak-dependent species decline at a rate of -5.69% per year for the band-tailed pigeon population and -5.34% for the acorn woodpecker (CPIF 2000).

### 2.3.2 Aquatic species

The survival of native aquatic species in the Sierra is at great risk from dams, water withdrawal, flow regimes, siltation and channelization from roads, invasive species, livestock grazing, and hydraulic mining. Forty-seven percent of Sierra Nevada amphibians are threatened by these activities and require protection (Jennings 1996). Aquatic habitat and species are reduced and threatened region-wide and at all elevation zones (Moyle 1996). The introduction of non-native game fish, such as trout, into lakes has altered aquatic habitats and has negatively affected amphibian populations, such as the mountain yellow-legged frog (Knapp 1996).

Dams and water withdrawals have effectively eliminated anadromous (migratory from ocean to river) fish from 90% of their historic habitat on the Sierra’s west slope. Moyle et al. (1996) identified four major threats to native fisheries in the Sierra Nevada:

- Loss of anadromous fish species, especially chinook salmon
- Decline in abundance of native fish species
- Introduction of 30 species of non-native trout
- Shift of fisheries in the Sierra Nevada to non-native species

**2.3.3 Predators**

The Sierra Nevada is experiencing a steady loss of predator species diversity and populations. The gray wolf and grizzly bear were extirpated from the bioregion between 90 and 120 years ago, respectively (Storer and Tevis 1955). Storer and Tevis (1955) offer an interesting California grizzly bear to man ratio of 1:13 a century ago, compared to the current grizzly to man ratio of approximately 0:32,000,000. Populations of other predators, especially those dependent upon old-growth pine and fir forests or remote areas, have retracted from the central Sierra, where habitat removal and fragmentation have been severe (Figure 3). Predators play essential ecological roles in the ecosystems they inhabit and their presence serves as an indicator of ecological integrity. Their absence indicates a trend toward disintegration.

The largest predator remaining in the Sierra Nevada is the mountain lion (*Puma concolor*). A 1990 ban on mountain lion hunting in California has prevented further decline of its populations statewide and has allowed populations to rebound.

*Figure 3. Rapid decline of carnivore species in the greater Sierra Nevada bioregion over 100 years.*

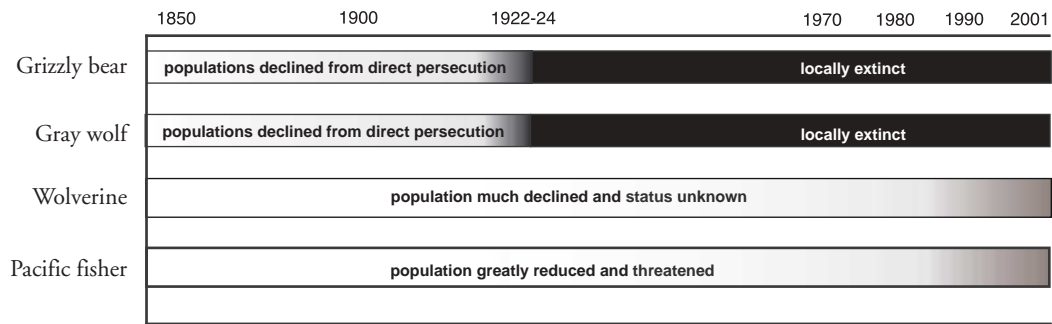

## 2.4 SUPPRESSED WILDFIRE CYCLES

Forest fires have played a significant evolutionary role in many habitats of the Sierra Nevada. This is most evident in mixed conifer and hardwood communities, where historically, low- to medium-intensity wildfires burned brush, thus enriching the soils and maintaining essential habitat conditions for wildlife. Fire history in the Sierra region is complex, as native Americans and early Anglo-European settlers started forest fires for different purposes.

Only recently has the Sierra experienced a drastic shift in the frequency and intensity of natural wildfires, since land managers of both public and private lands began suppressing the fires, affecting forest community structure and composition. Fire suppression and changing land use practices have dramatically changed the fire regimes of the Sierra Nevada, and have thereby altered ecological functions in Sierran plant communities. In addition, the presence of homes, especially in the west-central Sierra Nevada foothills and lower mixed conifer zones, can force changes in suppression strategies and increase suppression costs (SNEP 1996).

## 2.5 DAMMED WILD RIVERS AND CREEKS

Surpassing timber production and livestock grazing combined, water is the Sierra Nevada's resource of greatest value. Sixty percent of California's water is supplied by the Sierra Nevada (SNEP 1996). Because of the importance of the Sierra Nevada as a supplier of water for California, virtually every stream of any size has at least one dam or diversion on it (Kattelman, 1996). Today, dams exclude native fish, such as chinook salmon and steelhead, from 90% of their historic habitat along the Sierra's west slope rivers. Many of these populations have been severely reduced or have gone locally extinct, especially at low elevations, primarily as a consequence of dams and introduction of non-native fish species (SNEP 1996). These dams and other diversions have seriously disrupted water flows, a process upon which many riparian plants and animals depend. Dams and diversions also contribute to declines by flooding habitats, removing water, changing flow regimes, blocking movements and migrations, isolating populations, and causing increased human use of the watersheds (Moyle et al 1996).

## 2.6 INVASIVE PLANTS AND ANIMALS

Over the past few centuries, California and the Sierra Nevada have experienced introductions of non-native species that have altered millions of acres of habitat. The Spanish missionaries brought European horses, cattle, and annual grasses to California. Anglo-European settlers also introduced European varieties of grasses as livestock feed. McBride et al. (1996) estimated that non-native plants accounted for one-third, or 1,000 species, of California's plant diversity in 1993. Only recently have biologists taken stock of the diversity of non-native species and their abundance. Non-native wildlife and plants are found in virtually every habitat type, where, in some cases, they out-consume and out-compete native species. Non-native wildlife and plants are taking a serious toll on the native biodiversity of the Sierra Nevada.

Sierra stream, river, lake, and pond habitats have been assaulted by over 30 species of exotic fishes (Moyle et al. 1996). Introduced game fish, such as rainbow trout, compete with native fishes and prey on amphibian species, many of which are now in serious decline (Knapp 1996).

The most prevalent non-native species affecting Sierra ecosystems are plants, including cheatgrass, yellow star-thistle, scotch broom, salt cedar, Russian olive, and Ailanthus (tree of heaven). These and other non-native plants are heavily affecting many Sierra habitats, especially the valley grasslands and foothill oak woodlands, riparian zones, and eastern slope desert habitats. McBride et al. (1996) list the major habitat modifications that encourage invasion of non-native species in the Sierra Nevada: clear-cutting, fire, agriculture, road construction, urban expansion, and livestock grazing.

### 2.7 HUMAN POPULATION GROWTH

Almost every threat to biological diversity worldwide is caused directly or indirectly by the pressures of human population growth. Communities within the Sierra Nevada struggle to address this issue. It is obvious from the heated debates surrounding changes to General Plans and zoning ordinances that managing our own population is the greatest challenge. As the population booms to nearly 2 million in the Sierra Nevada in 2040, halting habitat fragmentation and species loss will require immediate attention at both local and regional scales.

Between 1970 and 1990, population doubled in the Sierra Nevada (Duane 1996). The foothill counties of Eldorado, Placer, and Nevada account for 40% of this growth. Of the 650,000 people now living in the Sierra Nevada, 68% live in the Sierra's westside foothills (Duane 1996). These foothills are rapidly being subdivided into small rural lots and recreational subdivisions. Between 1990 and 2040, population is expected to triple in the Sierra Nevada (Duane 1996).

Urban encroachment into oak woodlands and forests will continue at rates roughly proportional to regional population growth. Urban and rural growth impacts will be most significant where private lands interface with public lands. Development of private lands along the private-public interface will continue to influence adjacent public forests by increasing fire management activities such as fuel breaks and tree thinning. These impacts will likely result in a reduction of suitable habitat for sensitive species such as the California spotted owl.

As urbanization continues along the major traffic corridors and stretches further into oak woodlands, opportunities to connect existing preserves with habitat linkages will soon be lost. A recent survey of biologists determined that 73% of linkages in the Sierra Nevada are threatened by urban growth (Penrod et al. 2000).

## 2.8 LACK OF EVENLY DISTRIBUTED PROTECTED AREAS

Many of the cherished protected areas in the Sierra Nevada region had their boundaries delineated through a political process that did not fully consider ecological values. Therefore, many protected areas such as wilderness areas, national parks, and national monuments, do not protect habitats in less-scenic lower elevation areas. In the Sierra, a great wealth of biological diversity is found in old-growth forests, oak woodlands, riparian corridors, grasslands, and chaparral communities. Lower elevation habitats are important wintering habitat for migrating wildlife and serve as ideal linkages between ridges. In the Sierra Nevada bioregion, a majority of low- and middle-elevation habitats are unprotected, while high-elevation communities are well-represented by large protected areas (Map 2). Only one percent of westside foothill habitat in the Sierra Nevada is protected from development and livestock grazing (Davis et al. 1998), leaving a wealth of wildlife and wildlands at risk. Maintaining ecosystems and species diversity in the region will require an increase in protected areas at low and middle elevations.





SECTION THREE

*Wildlands Conservation  
Planning*



© Claus Sivert





## Section Three

### *Wildlands Conservation Planning*

#### 3.1 WHAT IS A WILDLANDS CONSERVATION PLAN?

A Wildlands Conservation Plan identifies a system of large Wildland Conservation Areas that are interconnected with Wildland Linkages. The strategy recommends that the Wildland Conservation Areas be buffered from intensive human activities by Stewardship Zones. The plan applies current ecological understanding to address major ecological impacts, such as habitat fragmentation, species loss, and habitat loss.

A Wildlands Conservation Plan is a long-term strategy for regional ecological recovery of wildlife, wildlands, and natural processes (e.g. wildfire, flooding and predation). It is long-term because, (1) wildlands planning is an iterative process that evolves over time as new data emerges, (2) restoration activities involving natural processes and wildlife populations within the region may take 50-100 years to complete, and (3) protecting wildlands at a much greater scale will require extraordinary funding and coordination. The Plan is a strategy as much as it is a vision, for guiding land managers, planners, citizens, and others in making informed decisions regarding the protection and restoration of functional wildlands in the region.

- **Wildland Conservation Areas** are geographic sites that meet the conservation goals and targets.
- **Wildland Linkages** are linear habitats that facilitate movement of animals, genetic material, seeds, wildfires, and pollen between large Wildland Conservation Areas. They primarily provide a path for stitching together habitats in a north-south direction within the major plant community types.
- **Stewardship Zones** are designated lands that surround Wildland Conservation Areas, buffering them from human activities that are not consistent with the maintenance of biological diversity. Boundaries are not explicit for the Stewardship Zones. Private practices and ideal land use regulations will play critical roles in maintaining functioning landscapes in the Stewardship Zones.

Together, these conservation area designations balance the need for the protection of wildlife and wildlands with the economic prosperity of Sierra Nevada communities. The intention of Wildland Conservation Areas and Wildland Linkages is to maintain the integrity of the biological diversity within the Sierra Nevada bioregion in a system of protected natural areas. The Stewardship Zones emphasize the long-term role of humans in future planning and management region-wide.

One of the first extensive wildlands conservation plans developed in the United States was a wildland vision for Florida (Noss 1985). The idea was first proposed in 1982 by Dr. Reed Noss, who suggested a system of core conservation areas, buffer zones, and corridors designed for large, mobile populations of predators such as the Florida panther and black bear. Further, Dr. Noss and his colleagues identified four objectives that should be addressed simultaneously in order to best maintain functional landscapes with healthy plant and animal populations (Noss 1985, Noss 1992, Noss and Cooperrider 1994):

1. Represent, in a system of protected areas, all native ecosystem types and seral stages across their natural range of variation.
2. Maintain viable populations of all native species in natural patterns of abundance and distribution.

3. Maintain ecological and evolutionary processes, such as disturbance regimes, hydrological processes, nutrient cycles, and biotic interactions, including predation.
4. Design and manage the system to be responsive to short-term and long-term environmental change and to maintain the evolutionary potential of lineages.

This comprehensive strategy is emerging to replace narrower conservation objectives that do not maintain connected and vital landscapes. Examples of the latter are single species, biological hot-spot, and habitat plans, which undervalue biological diversity and important ecological processes. The Wildlands Conservation Plan is largely based on Noss's strategy since it emphasizes the value of maintaining large wildlands, keystone species (including large predators), and habitat linkages.

*Figure 4. Case study: Florida Greenway Program*

#### **CASE STUDY: THE FLORIDA GREENWAY PROGRAM**

The Florida Greenway Program is a working example of how regional Wildlands Conservation Planning can be successful. Since the first statewide vision for an interconnected system of wildlands was proposed for Florida in 1985, the state's public awareness has grown in support of a greenway strategy. A greenway is a continuous strip of open space that provides habitat for wildlife and/or passive recreation opportunities. Greenways generally follow natural land forms connecting two or more large wildland areas. As large, highly mobile wildlife struggle to survive in Florida's ever-diminishing natural areas, greenways can facilitate wildlife travel between nature parks. In these and many other ways, the greenway strategy has taken root.

Florida has long been a destination for new families, industry, military, and the retired. This steadily growing human population has greatly affected Florida's dynamic natural world. As human communities sprout and extend into swamps, savannas, and pine forests, limited resources have become stressed. The Everglades National Park, a wetland of international importance, has been drained significantly to supply Florida's cities and suburban communities. The network of roads and highways fragments fragile habitat and subjects slow-reproducing wildlife such as the Florida panther to fatal vehicle collisions. Approximately 65% of Florida panther deaths are caused by vehicle collisions.

Realizing that the situation was degrading and threatening Florida's natural heritage, Dr. Reed Noss proposed a long-term vision for protecting and restoring whole ecosystems, large wildlife populations, and linkages. In 1985, Dr. Noss published a generalized map defining a system of "core" habitat areas and habitat "linkages" in addition to the current array of protected areas. Throughout the years, Dr. Noss's visionary map for Florida's wildlands has been cited as a model for long-term regional restoration and protection, emphasizing the need to maintain all native species, including large mammals, in a system of protected areas. Since then, Florida has investigated how Dr. Noss's model could evolve into a practical strategy for protecting the state's sensitive natural lands while providing direct benefits to society (Cox et al. 1994).

In 1993, Florida's governor, Lawton Chiles enacted the Florida Greenway Commission to realize a statewide system of greenways, consisting of large habitat blocks linked together to protect native ecosystems and wildlife, as well as provide public recreation opportunities. Many of Florida's proposed greenways are designed for human recreation: nature watching, hiking, horseback riding, and biking. This proactive program counters soaring urban and rural sprawl by protecting wildlands and migration routes for large native wildlife such as the black bear and the Florida panther. Florida's conservation vision, the Florida Greenway Program, will eventually add an additional 2.7 million acres of wildlands to the existing 7.4 million acres of conservation lands.

The Sierra Nevada Wildlands Conservation Plan is designed in much the same way; it connects large intact habitats (core areas) with linear connectors (linkages). The core/linkage model is regarded as an effective approach to protecting a region's natural diversity of plants and animals while allowing migrating wildlife and natural wildfire to move across the landscape.

The size of the Florida greenway core areas is important because these areas need to provide essential wildlife species with breeding and feeding habitat. Two ecologically important native wildlife species are the black bear and Florida panther. The Florida panther is federally endangered and is protected under the Endangered Species Act of 1973. Currently there are believed to be fewer than 400 Florida panthers in the state. It is hoped the Florida Greenway Program, as implemented, will not prove too little too late, and will allow the black bear and Florida panther populations to regain their numbers over time.

Today, Florida has protected many parts of the greenway system, using funding from Florida programs, such as the Preservation 2000 program, the Conservation and Recreation Lands (CARL) program, and many other incentives and funds. In addition to protecting wildlands, the Florida Department of Transportation is constructing wildlife crossing structures and land bridges across roads to improve migration of black bear, Florida panther, and the key deer.

To learn more about the Florida Greenway Program:

<http://www.geoplan.ufl.edu/projects/greenways/greenwayindex.html>

### 3.2 WILDLANDS PLANNING IN THE SIERRA NEVADA

The California Wilderness Coalition (CWC) initiated Wildlands Conservation Planning in the greater Sierra Nevada bioregion in August 1999. The first objective of the program was to conclude a big picture strategy, or vision map, for the Sierra bioregion. This map was the first sketch of a regional conservation system based on the habitat requirements of keystone wildlife, especially species requiring large habitat areas and migration routes. It was largely informed by existing databases and the knowledge of conservation biologists, land managers, and forest rangers.

In January 2000, CWC hosted a two day science mapping workshop at which over 30 experts worked together to identify important wildlife habitats, wildlife migration routes, aquatic habitats, and wildlands in need of restoration. Such mapping workshops are vital for collecting information on actual conditions of wildlands, distribution of wildlife, and existing or threatened habitat linkages. The results of the workshop were incorporated into a Sierra Nevada vision map that defines important wildland habitat for six wildlife species: wolverine, gray wolf, Pacific fisher, marten, California spotted owl, and mule deer.

### 3.3 ELEMENTS OF A WILDLANDS CONSERVATION PLAN

Conservation practitioners and scientists worldwide have studied historic and current approaches to preserving very large landscapes with their full assemblage of plants, animals, and natural processes. What they have noticed is that very large and connected nature preserves do a better job of maintaining regional biological diversity than do small, isolated nature preserves. They have also learned that maintaining wildlife, such as large predators, is essential for a balanced ecosystem. Conservation biologists believe it is critical to protect examples of all native plant communities in a region by distributing protected areas in a strategic manner. The Wildlands Conservation Plan provides a long-term strategy for large landscapes with these principles in mind.

The Wildlands Conservation Planning approach of establishing large and connected protected areas throughout ecoregions is a sound solution for halting continued degradation of our common natural heritage. General guidelines can be applied in Wildlands Conservation Planning to address major ecological impacts (Table 9).

*Table 9. Broad approach to regional conservation*

<b>ECOLOGICAL IMPACT</b>	<b>SOLUTION</b>
Fragmented habitat	Large protected areas and reserves
Reduction of habitats	Restore and maintain linkages to connect reserves Consolidate land uses to improve management of whole ecosystems; habitat restoration
Altered ecosystem function due to species loss and disruption of natural processes (fires and floods)	Restore and maintain keystone species and ecosystem regulators: large predators, fires, and floods

#### *3.3.1 Large and connected protected areas*

Conservation areas that actually maintain long-term species viability have great size requirements. Scientists have recommended that they be larger than 100,000 (Schonewald-Cox 1983). For large predators, this has been sufficiently documented, yet as Newmark (1985, 1995) observed, our western national parks do not come close to filling this need. Indeed, even our largest parks (e.g. Yellowstone) cannot support a viable grizzly bear population of 500 bears. To maintain populations of large mammals, especially predators with large home ranges, a system of protected areas must replace the present system of isolated parks (Noss and Cooperrider 1994).

In the Sierra Nevada, Yosemite and Sequoia-Kings Canyon National Parks combined (5,472 km<sup>2</sup>) are insufficient in size to support a viable population of wolverine beyond 100 years (Newmark 1985). Although these two parks adjoin higher elevation wilderness areas, they are isolated from the north Sierra, Cascade Ranges, and Modoc Plateau.

**The Value of Wildlands** (from Noss 1991)

- They provide a standard of relatively healthy and unmodified land, thus they serve as benchmarks or controls for our management experiments, as emphasized by Aldo Leopold;
- They serve as habitat refugia for species sensitive to human persecution or disturbances, such as large predators and furbearers;
- They provide a source of humility, a reminder that Nature remains more powerful than we are and is ultimately unconquerable;
- They and the wild species they contain have intrinsic or existence values recognized by many people.

**3.3.2 Habitat linkages (i.e. wildlife corridors)**

Habitat linkages serve to connect larger blocks of habitat. They are necessary for the movement of many species of wildlife, wildfires, songbirds and raptors, seeds, and pollen. Habitat linkages should be designed based on the habitat requirements of a particular species or suite of species to ensure their use and effectiveness. A linkage's intended function or structure must be made explicit. The more data and input the linkage planning process has, the more certain planners can be in defining the linkage's function or structure.

Because Sierra Nevada ecosystems have become fragmented, maintaining habitat linkages is critical for populations of forest species (i.e. Pacific fisher). Where habitat is broken up by logging, ranchette subdivision, or wildfire burns, as in the mixed conifer and fir forests along the westside Sierra, restoring linkages is essential.

**3.3.3 Preserving and restoring focal species**

To be considered complete, conservation plans should protect species by linking ecological patterns and processes into the plan's design. Species can provide planners with valuable information on habitats, natural processes, and reserve configuration (Lambeck 1997).

Seldom can a single species account for the spectrum of biodiversity of an ecosystem (Rubinoff in press). Past failures involving single-species protection efforts have illuminated the benefits of multiple-species approaches to ecosystem and ecoregion conservation (Miller et al. 1999).

Recently, key wildlife species have shown promise in representing natural processes and patterns in regional conservation planning (Jeo et al. 1999). Species used in conservation planning are termed focal species. Focal species are classified based on their unique response to habitat conditions (e.g. fragmented habitat as a result of development), dependency on food resources, or representing an essential ecological function such as migration, habitat alteration (e.g. beavers), or prey regulation (Noss 1992, Lambeck 1997). There are numerous focal species categories to consider and it is common to find a single species included in multiple categories.



### *Types of focal species*

Seven categories of focal species were recognized as useful in our planning phase: keystone, area limited, dispersal limited, process limited, resource limited, narrowly endemic, and special cases (Noss et al. 1997; Lambeck 1997). These categories enable planners to place focal species in an ecological context that will help meet the goals of the conservation plan. Multiple categories can apply to a single species. Below are the technical categories used for selecting project focal species.

**Keystone** species play a unique role not filled by other species. By definition, their effect is disproportionate to their abundance. Examples: gray wolf, beaver, acorn woodpecker.

**Area limited** species are wildlife that need a lot of habitat daily, seasonally, or throughout their lifetime. Examples: grizzly bear, wolverine.

**Dispersal limited** species are wildlife most reluctant to travel, or those incurring high mortality during seasonal movements. Example: sage grouse.

**Process limited** species that require a certain ecological process for their survival. Examples: deer and wild brush fires, willow flycatcher and riparian flooding.

**Resource limited** species are wildlife that require special habitats or prey to survive. Examples: acorn woodpecker, California spotted owl.

**Narrowly endemic** species are wildlife that occur at very few sites, within a small geographic range (e.g. 50,000 ).

**Special case** species include flagship species (e.g., “charismatic megafauna,” sage grouse, bighorn sheep, gray wolf).

### *Ecological value of predators*

A central principle of conservation biology is that the presence of predators is an indicator of functioning, healthy ecosystems (Terborgh et al. 1999). The removal of predators from an ecosystem has deleterious ecological effects such as the over-browsing of vegetation from booming prey populations (Estes et al. 1978, Messier 1994) and an increase in small to mid-size predators that prey heavily on songbirds or other small prey (Crooks and Soulé 1999). In general terms, an ecosystem without its full and historic suite of top predators is out of balance, ecologically speaking. Only recently has the pool of scientific studies on predator-ecosystem relationships become conclusive, the significant role of predators in ecosystems has long been recognized.

### *The Top-Down Force*

While ecosystems are complex, there are a few basic principles that suggest predators are a central component in maintaining ecological balance. One of these principles is the top-down regulatory force. Top predators, such as the grizzly bear, gray wolf, wolverine, mountain lion, or bobcat, by preying on other wildlife, control the abundance of their prey species, which are lower down on the food chain. The removal of these keystone species from the ecosystem has a disproportionate effect on the system. This often results in greater numbers of prey species than is viable within an ecosystem. The overabundance of deer, raccoons, or feral cats in suburban areas is testimony to this.



Predators have been removed, resulting in a new and unbalanced arrangement. Maintaining populations of native predators in ecosystems is a sound goal for the proper management of entire ecosystems. Yet, the practicality of ensuring that this goal is met requires an entirely new way of conducting regional land use planning.

### *Planning for predators*

Predators need space, and lots of it. It is typical for predators to travel great distances in search of food or new territory. Additionally, many predators are sensitive to human activities, including logging, off-road recreation, suburban and rural development, and road or highway traffic. Therefore the needs of predators should be carefully considered in conservation planning.

In direct relation to their body size, predators need large, protected wildlands to hunt, search for mates, and establish new territories. Such spatial requirements are an important measurement with which to guide wildlands planning. The often-raised question of how much land should be protected is answered by the predators. The solution to maintaining healthy populations of predators over the long-term (300+ years) requires the establishment of large wildlife areas such as parks, wilderness areas, and other protected natural areas.

#### *3.3.4 Restoring habitats and ecological processes*

A staggering amount of significant habitat has been removed, developed, altered, and degraded in the Sierra Nevada bioregion, so much so that it is impossible to really understand what has been lost from all levels of biological diversity. For this reason, it is important to consider less than pristine habitat for inclusion in a regional conservation strategy, and develop a vision for ecological recovery that looks beyond single species protection to comprehensive habitat restoration.

Maintaining ecological processes at appropriate levels usually requires active management and, in many cases, restoration (Noss 1997). It is important that habitat restoration is considered during the conservation planning process and carried through the implementation component of the process. Planning teams cannot count on natural processes operating effectively if we establish reserves and leave them alone. Many natural processes operate on spatial scales much more vast than our reserve networks (Noss 1997).

Within the greater Sierra Nevada bioregion, it will be important to identify areas within the wildlands network that will benefit most from restoration efforts. Restoring and revitalizing less than pristine habitats will enhance the possibility of restoring top carnivores such as grizzly bear or gray wolf back into their historic ranges.

#### *3.3.5 Representing all native plant communities*

To be considered complete, a regional conservation strategy must ensure that intact examples of each native plant community are represented in the proposed system of protected areas (Noss 1992, Noss and Cooperrider 1994). While wide-ranging predators set an ambitious scale for identifying new protected areas, larger than 100,000 acres, there is no evidence that reserves designed for predators also represent all native plant communities. Such an umbrella-effect theory is not supported by recent studies (Andelman and Fagan 2000).

The California GAP Analysis (Davis et al. 1998) identified 14 forest and chaparral plant communities in the Sierra Nevada as being unprotected by the present system of parks and wilderness areas.

Vegetation representation is a relatively straightforward goal to achieve at a coarse level, meaning that by using current vegetation maps, we can approximate available acreage of each major plant community in the region. What is not straightforward is defining the percentage of each plant community to include in the system of protected natural areas. Consideration should be given to the level of rarity or threat to individual communities in the region in defining the percentage to protect. These percentages then become the plant community targets that can be tested for at the end of the planning process to gauge its success. Another method for meeting representation goals in a reserve design scenario is to employ GIS mapping tools that search for an optimal solution by evaluating the costs and benefits of selecting potential reserves based on the minimum area required based on each plant community (Noss and Cooperrider 1994).

### *3.3.6 Geographic Scale*

Resource planning must give considerable attention to issues of geographic scale if it is to be meaningful to the conservation targets it addresses. Scale is defined simply as the geographic context in which planning objectives are best matched. An example is natural wildfire, which generally may burn large patches of vegetation and affect entire plant communities in its burn cycle. Watersheds or large forest patches may be an appropriate scale for mapping and planning for wildfire. Yet, something as small as a wide road may act as an artificial barrier to a low intensity fire, requiring detailed information to be considered, such as location and width of roads.

Scale issues vary between and within planning elements. Ultimately, existing information and data restrict a plan to certain scales, generally to larger areas such as watersheds and landscapes. A general rule common to landscape level planning is to conduct broad scale planning as a first tier, followed with fine scale, or site planning where opportunities, priorities, and data present themselves.

**A region or landscape** is a large land mass defined by its distinct geology, ecosystems, or climate. Examples are California's central coast region and the westside Sierra landscape. Regional and landscape scales require consideration of larger ecological issues such as the distribution of forests and wildlife populations, wildlife migration routes within regions and between neighboring ecoregions, and wildfire and flood cycles.

**A watershed** is a smaller land area defined by its association with one hydrologic drainage. The watershed scale is appropriate for addressing natural resource aspects such as fish migration, restoration of aquatic habitat, wildlife populations, wildlife migration routes, wildfire and floods.

**A site** is the smallest geographic planning area and is generally smaller than a watershed. The site scale is important when considering wildlife responses to "fine-grain" habitat elements such as fences, road traffic volume, or land parcel size.

### *3.3.7 Relation to other land use plans*

In the Sierra Nevada region, there are now many efforts to integrate ecological principles into land use planning, though the conservation objectives and scale of planning vary (Table 10). What is lacking is a perspective that extends beyond political boundaries, has a regional view, and is a vision for restoring natural processes and important species. A Wildlands Conservation Plan provides a regional perspective for long-term ecological recovery. Specifically, it provides a vision to reunite fragmented habitat and revive declined or extinct populations of focal species.

*Table 10. Land use planning efforts underway in the Sierra Nevada*

<b>PLAN</b>	<b>AREA OF INFLUENCE</b>
County general plans	county
Habitat Conservation Plans	county
Land trusts	state, region, county, watershed, basin, forest
Sierra Nevada Forest Plan Amendment	US Forest Service lands
Federal Roadless Policy	US Forest Service lands
The Nature Conservancy	ecoregional
Wildlands Conservation Plan	bioregional

### *Comparison between Wildlands Conservation Plan and Sierra Nevada Forest Plan Amendment*

Much of the Sierra Nevada's mid- to high-elevation landscape enters a new era of forest resource management under the policy of the Sierra Nevada Forest Plan Amendment. The Sierra Nevada Forest Plan Amendment (a.k.a. Sierra Nevada Framework) is a recent reform of forest management policy for ten national forests and one USFS management unit in the Sierra Nevada. This long awaited plan is founded on many of the scientific findings of the Sierra Nevada Ecosystem Project (SNEP). The Plan is currently being implemented and will serve as the guiding policy for over 11 million acres of US Forest Service lands for the next 10 years.

The Forest Plan Amendment is a significant improvement in Forest Service resource management in the Sierra Nevada, protecting 40% (4 million acres) of USFS lands as ancient forest reserves, 736,000 acres as critical forest carnivore and willow flycatcher habitat, and 1.4 million acres of remaining Pacific fisher habitat in the south Sierra.

Additionally, the Plan aims to protect and restore aquatic habitats and sensitive aquatic species with Riparian Conservation Areas and Critical Aquatic Refuges. In the general forest areas, the Plan reduces annual logging levels from 372 million board feet to 187 million board feet. Communities within or adjacent to Forest Service lands will be buffered by 400 meter wildfire clearings in an attempt to protect property from uncontrolled wildfires.

The Forest Plan Amendment presents promising implications for short-term implementation of a regional wildlands strategy by maintaining key components of wildlands and wildlife populations.

It also begins the process of population restoration for the Pacific fisher. In the meantime, the Plan buys wildlands and wildlife time until conservationists and decision-makers can enact permanent protection for essential wildlands in the region.

### *3.3.8 Private land conservation strategy*

A great part of the Sierra's biodiversity is distributed on private property. Oak woodland habitats, considered to harbor more species than any other habitat found in the Sierra ecoregion (Graber 1996), are almost entirely in private ownership, as is 37% of the Sierra bioregion (Davis et al. 1998). Some of these lands are seriously threatened. Development is already sweeping through many thousands of wildland acres in the Sierra westside foothills. For these reasons, private lands play a critical role in maintaining and restoring the region's biological wealth (Scott et al. 1995).

A growing toolbox of programs and incentives awaits land owners who choose to consider the rewards of private lands conservation. One of these options is conservation easements on private lands. By placing a conservation easement on their land, private landowners can maintain private ownership while simultaneously contributing to the overall health of the surrounding ecosystem. Oftentimes, many activities such as farming, ranching and selective timber harvesting can take place on conservation easement properties. In addition, there are also tax incentives for landowners who choose to protect the ecological integrity of their land through conservation easements.

---

SECTION FOUR

---

*Wildlands Conservation Plan*



© Claus Sivert



## Section Four

### *Wildlands Conservation Plan*

#### 4.1 INTRODUCTION TO WILDLANDS PLANNING METHODS

We used a three-part study approach to address the conservation goals defined by Noss (1992): (1) focal species and habitat analysis, (2) habitat linkage analysis, and (3) representation analysis. We set out to identify a regional system of Wildland Conservation Areas that would harbor the best habitat for focal species, achieve a high degree of plant community representation, preserve habitat linkages, and provide buffers from intense human activities.

Two GIS models were developed for the purpose of characterizing a Wildlands Integrity index for the region and selecting sites to meet plant representation goals and wildland values. Three land area classes were produced from this approach: (1) Wildland Conservation Areas, (2) Wildland Linkages, and (3) Stewardship Zones. We then tested the network of Wildland Conservation Areas and Wildland Linkages for its representation of special elements such as roadless areas and portfolio sites of The Nature Conservancy.

This research and analysis complete the first stage of regional wildlands planning in the Sierra Nevada bioregion. The GIS data and methods on which this assessment is based are available on CD to interested parties. A more detailed description of the planning method is provided in Appendix C.

*Figure 5. Planning process*

	<b>COMPLETED</b>	<b>NEXT STEPS</b>
	<i>Wildlands System Design Process</i>	<i>Site Planning Process</i>
<b>PURPOSE</b>	To map a regional system of significant conservation priorities	To identify boundaries of priority conservation targets
<b>BOUNDARIES</b>	Bioregional	Watershed, land parcel
<b>PARTICIPANTS</b>	Regional land managers, biologists, regional conservation groups	Stakeholders: county planners, land trusts, citizen groups
<b>SCOPE OF WORK</b>	<ul style="list-style-type: none"> <li>• Identify project goals</li> <li>• Select focal species</li> <li>• Develop biological database</li> <li>• Form planning approach</li> <li>• Identify potential Wildland Conservation Areas, Wildland Linkages and Stewardship Zones</li> <li>• Ensure system of potential protected areas represents all native plant communities</li> </ul>	<ul style="list-style-type: none"> <li>• Select prioritization criteria with stakeholders</li> <li>• Identify regional conservation priorities for wildland areas</li> <li>• Gather site information with site visits and interview land managers and biologists</li> <li>• Site design to define boundaries and land parcels for protection</li> </ul>
<b>TIME FRAME</b>	August, 1999-September 2001	Begin early 2002

### 4.2 GOALS FOR REGIONAL CONSERVATION

Four goals supported by contemporary conservation science (Noss 1992) were adopted for the Sierra Nevada bioregion. As data and GIS tools necessary to address these ambitious goals are just becoming available, we can progress toward these goals in planning for the region. Implementation of this plan at the local level will require more detailed maps and field data. The goals include:

1. Maintain and/or restore viable populations of all native species in their natural pattern of abundance and distribution.
2. Ensure representation of all native habitat types and seral stages across their natural range of variation.
3. Maintain ecological and evolutionary processes, such as disturbance regimes, hydrological processes, nutrient cycles, and biotic interactions, including predation.
4. Design and manage the system to be responsive to short-term and long-term environmental change and to maintain the evolutionary potential of lineages.

### 4.3 PLANNING OBJECTIVES

- Identify a minimum number of Wildland Conservation Areas that provide habitat for focal species.
- Identify habitat linkages for focal species between the Wildland Conservation Areas.
- Assess the effectiveness of this approach in meeting plant community representation goals and in protecting other important attributes of biodiversity.

### 4.4 ASSUMPTIONS AND LIMITATIONS

1. The conservation goals provide a direction for a long-term regional conservation strategy. As the goals are more specific than are the data used to address them, these goals will be met incrementally. It is not known at this moment if these goals have been met. Achievement of the goals for all species will take decades of work in the linking of Sierra habitats to ones in adjacent bioregions. As new information develops, it can be evaluated for inclusion into future revisions of the Wildlands Conservation Plan.
2. The configuration of Wildland Conservation Areas and their boundaries are addressed in this plan at the regional scale; their significance at the local or site scale is not yet well understood.
3. Habitat models used in this plan are intended for regional scale analysis and do not allow the planning process to infer more detailed assumptions at this point (i.e. they cannot be directly applied to a local, site specific analysis).
4. Due to the complexity of nature and the limitations of planning tools and data, determining an optimal system of protected areas is highly unlikely, while an approximation of such a system is possible if an empirical process is followed (Noss 1994).
5. Databases and computer-generated models are abstractions and are subjective. Therefore, models do not necessarily represent true on-ground conditions. Habitat models may be used as planning tools at the regional scale to encourage and direct research and analysis at the site level.



6. As we do not know the actual occurrences of many vertebrate species and of most non-vertebrate species of animals and of most non-vascular plants, we hope to protect their habitats by designating large Wildland Conservation Areas in each subregion, using focal species and plant communities as markers.

#### 4.5 THE PRECAUTIONARY PRINCIPLE

Land managers are limited by the quality of information available to them. Uncertainty is an inherent element of any profession or science. Land managers will likely never know all they wish on which to base decisions and cannot expect to set management and protection limits to a minimum threshold. There are numerous examples of failures of resource management programs operating under the minimum threshold paradigm for harvests or conservation. Protection of too little land results in continued species extinction. Conservation biologists implore decision makers and resource agencies to protect and manage with great precaution, acknowledging this uncertainty. Applying the precautionary principle lowers the odds of continued species extinction at the local and global level.

#### 4.6 IMPORTANT TERMINOLOGY

**Wildland Conservation Areas** are assemblages of planning units that contain high-quality focal species habitat and meet goals for representing plant community targets.

**Wildland Linkages** are linear paths connecting Wildland Conservation Areas through a terrain of high quality wildland and are intended to permit wildlife movement, seed dispersal, and wildfires.

**Stewardship Zones** are wildlands outside the system of Wildland Conservation Areas. Their function is to buffer the wildland values of adjacent Wildland Conservation Areas from intense human uses. There are three classes of Stewardship Zones, which are defined as the upper three best classes of the Wildland Integrity index. We list them as Good Wildland Potential, High Wildland Potential, and Highest Wildland Potential.

#### 4.7 SELECTION OF FOCAL SPECIES

Focal species were chosen through a four-step process, described below, that identified ten species, grouped by habitat suite: the oak woodland suite (acorn woodpecker, mule deer, California spotted owl), the mixed conifer/old growth/carnivore suite (Pacific fisher, marten, gray wolf, wolverine), east Sierra and Great Basin suite (bighorn sheep, pronghorn, and sage grouse). Suites of focal species were formed to represent the major plant communities and natural processes in each major vegetation belt (e.g. oak woodland, mixed conifer, alpine, eastside sagebrush) and also to address the major habitat threats in the region (e.g. address forest fragmentation by identifying habitat and linkages for forest carnivores). For example, in the westside oak woodland subregion, the acorn woodpecker represents oak species diversity and oak tree density at the regional scale, the mule deer represents a mosaic of habitats including chaparral and migration routes, and the California spotted owl represents intact, canopied oak-pine intermix forests among other habitat characteristics.

**Step 1. Native species**

The first step in the selection process was to identify all wildlife native to the region, including recently locally extinct species such as the grizzly bear and gray wolf. Potential geographic occurrence of wildlife in the bioregion was inferred from the California Wildlife Habitat Relationships system (Zeiner et al. 1988) and regional field guides. Table 1 in Appendix B lists all candidate focal species along with their respective habitats, conservation status, and focal species category.

**Step 2. Grouping by focal species category**

We considered the use of seven focal species categories currently applied in regional planning efforts world-wide. They include keystone, indicator, special case, area limited, dispersal limited, resource limited, and process limited. Recognizing the value of predators and their importance in the design of regional planning, large and medium-size carnivores were categorically selected to represent the carnivore guild. Additional wildlife were considered as candidate focal species if they met one or more of the following criteria:

Have large effects on community structure and function	Noss 1997; Power et al. 1996
Have effects that are disproportionately large relative to their abundance	Noss 1997; Power et al. 1996
Perform roles not performed by other species or processes	Noss 1997; Kotliar 2000
Are dispersal limited	Lambeck 1997
Are area limited	Lambeck 1997
Are resource limited	Lambeck 1997
Are process limited	Lambeck 1997

In-depth information on species ecology, life history, demography, and potential habitat threats was obtained from the primary literature, internet resources, and unpublished agency reports. As time permitted, wildlife experts and resource managers were also consulted.

**Step 3. Grouping by habitat threat**

We then grouped candidate focal species for which evidence of population decline is a major ecological threat (see Table 10). This step identified redundancies between the threats affecting candidate species. Species that addressed multiple threats regionally or sub-regionally (e.g. westside oak woodlands), or addressed a subregional threat (e.g. sagebrush fragmentation) exclusively were selected.

Table 11. Human activities affecting potential focal species.

THREAT	SPECIES	SUBREGION	
Human disturbance or persecution	Gray wolf	Modoc, Cascades	
	Wolverine	Sierra Nevada	
	Bighorn sheep	East Sierra	
	Bats (colonial)	All regions	
	Sage grouse	Modoc, East Sierra	
	Bald eagle	Modoc	
	Colonial wetland birds	Modoc	
	Barriers to movement (e.g. migration)	Pronghorn	Modoc, East Sierra
		Bighorn sheep	East Sierra
	Timber harvest or firewood-cutting	Pacific fisher	Sierra Nevada
Pine marten		Sierra Nevada	
California spotted owl		Sierra Nevada	
Northern goshawk		Sierra Nevada	
acorn woodpecker		Foothills	
Band-tailed pigeon		Foothills	
Wood duck		Foothills	
Nuttall's woodpecker		Foothills	
Red-shouldered hawk		Foothills	
Swainson's hawk		Modoc	
Riparian health indicators		All regions	
Sagebrush conversion		Sage grouse	Modoc, East Sierra
		Pronghorn	Modoc, East Sierra
		Willow flycatcher	Sierra Nevada
Overgrazing or competition with livestock		Pronghorn	Modoc, East Sierra
	Sage grouse	Modoc, East Sierra	
	Pygmy rabbit	East Sierra	
	White-tailed hare	Sierra Nevada	
	Aspen community birds	East Sierra	
Disease transmission from livestock	Bighorn sheep	East Sierra	
Multiple aquatic stressors	Ranid frogs	All regions	
	Most salamanders	All regions	
	Bats	All regions	
Insecticide use	Swifts, purple martin	Sierra Nevada	
Wetland drainage or diversion	Greater sandhill crane	Modoc	
	Sage grouse	Modoc, East Sierra	
	American bittern	Modoc	
Dams or reservoirs	Riparian health indicators	All regions	
	Bank swallow	Modoc	
	Belted kingfisher	Sierra Nevada	
	American dipper	Sierra Nevada	
	Yellow-breasted chat	Foothills	
Nest parasitism by cowbirds	Willow flycatcher	Sierra Nevada	
	Various warblers	Sierra, Foothills	
Rodent control	Badger	Modoc	
Urbanization	Many species	Especially foothills	

**Step 4. Consideration of available data**

The final list of focal species was also selected based on available habitat data and habitat models that cover the species' historic distribution in the Sierra region (Table 12). As more information on wildlife and habitat relationships becomes available, additional focal species should be added to this planning effort.

*Table 12. Available habitat data and habitat models for focal species.*

FOCAL SPECIES	HABITAT DATA/MODEL	DATA SOURCE
Pacific fisher	Predictive habitat computer model	USDA, 2000
Pine marten	Predictive habitat computer model	USDA, 2000
California spotted owl	Predictive habitat computer model	Carroll, 1999
Gray wolf	Predictive habitat computer model	Carroll, 2000
Wolverine	Predictive habitat computer model	Carroll, 2000
Mule deer	Winter range habitat maps	CDFG, 2000
Bighorn sheep	Species habitat relationship database	CDFG, 2000
Acorn woodpecker	Species habitat relationship database	CDFG, 2000
Sage grouse	Species habitat relationship database	CDFG, 2000
Pronghorn antelope	Species habitat relationship database	CDFG, 2000

*The grizzly bear*

Until the turn of the century, parts of the western and northern Sierra Nevada were home to the grizzly bear. A top carnivore in the food chain, the grizzly is an ideal focal species for regional wildlands planning (Jeo et al. 2000). Initially, the grizzly bear was selected as a project focal species, a member of the regional carnivore guild. Yet, due to lack of appropriate data necessary to determine plausible restoration sites in the region, the grizzly bear was taken off the list of candidate focal species. Carroll et al. (2001) assessed the feasibility of restoring grizzly bear to western states, including much of the Sierra Nevada planning area. While acorns constituted a portion of the California grizzly bear diet, salmon, especially migrating salmon were also important. As the grizzly bear model developed by Carroll et al. (2001) did not address these food resource issues, we felt the grizzly bear should be set aside until these issues can be addressed by future analysis.

*4.7.1 Selected focal species*

The acorn woodpecker, mule deer, and California spotted owl were selected to represent habitat diversity, migration processes, and threats in the westside low- to mid-elevation hardwood, hardwood-pine complex, and old-growth conifers. The acorn woodpecker, tightly correlated to hardwood resources, especially oak diversity, is considered a keystone species. Acorn woodpecker abundance is responsive to levels of hardwood disturbance and the presence of granary trees. Mule deer herds seasonally migrate between mid-elevation forests to lower elevation westside foothill habitats and east Sierra scrub habitats. Mule deer are an essential food resource for mountain lions in the region. The California spotted owl is an old forest specialist with strict dependency on prey availability, especially the dusky-footed woodrat and the flying squirrel (Verner et al. 1992). The owl is believed to migrate seasonally between dense stands of mature hardwoods and dense stands of mature mixed conifer. The California spotted owl is an indicator of healthy old-growth forests and the presence of its prey species.

The Pacific fisher and marten are forest carnivores of the weasel family. Their ranges in the Sierra Nevada differ; the Pacific fisher is limited to mid-elevation mixed conifer, closed canopy stands, while the marten's range is limited to mid- to high-elevation fir forests. Both species are subject to habitat loss and fragmentation as a result of clear cutting, road development, and off-road recreation.

Wolverine and gray wolf, both predators requiring remote locations far from human activity, are considered keystone species. Given their once important role and distribution in ecosystems of the Sierra bioregion, the gray wolf and wolverine are proposed for restoration to their historic range, although it is not certain what the exact historic range of the gray wolf was in California. However, specimens were collected in the Modoc Plateau and southward in the 1920s.

The Sierra bighorn sheep was selected as a focal species because it is a dispersal-limited species of high altitude, east Sierra habitats. Populations of bighorn sheep are in need of restoration, and appear to be highly sensitive to a host of human activities. The pronghorn antelope and sage grouse represent Great Basin habitats of the east Sierra and Modoc Plateau suites.

#### 4.8 CONSERVATION TARGETS

<b>Focal species habitat:</b>	Pacific fisher Marten Gray wolf Wolverine California spotted owl Mule deer Acorn woodpecker Bighorn sheep Pronghorn Sage grouse Presence of rare, sensitive, or threatened species
<b>Species richness:</b>	Bird richness Amphibian richness Reptile richness Mammal richness
<b>Forest integrity:</b>	Large patches of late seral, old growth forests Habitat patch density
<b>Aquatic integrity:</b>	Aquatic species richness (fish and amphibians) Presence of dams and reservoirs Effects of roads on aquatic habitat

#### 4.9 DATA AND DATA SOURCES

- Wildlife Habitat, California Wildlife Habitat Relationships (WHR) database (2000)
- Old Forest Emphasis Areas and Pacific Fisher and Marten Habitat Models, US Forest Service Sierra Nevada Forest Plan Amendment (2001)
- Recent Fires, US Forest Service (2001)
- Dams and Diversions, State Water Resources Control Board (1998)
- Streams and Rivers, US EPA National Hydrological Database (2000)
- State Roads (1:100,000), Teale Data Center, 1999
- Fish and Amphibian data, Dr. Peter Moyle, UC Davis 2001
- Gray Wolf and Wolverine Feasibility Models, Carlos Carroll et al. (2000)
- California Spotted Owl Habitat Model, Carlos Carroll et al. (2000)
- Rare and Threatened Species Occurrence, California Natural Diversity Database (2000)
- Land Ownership and Vegetation, California GAP Analysis (1998)
- Hardwood Vegetation, California Department of Forestry
- Human Population Density by Census Block, Census 1990
- Placer and Nevada Counties General Plan and Land Parcel Coverages

#### 4.10 ASSESSMENT OF WILDLAND INTEGRITY

Wildland Integrity was assessed throughout the bioregion to provide an information layer from which to define potential Wildland Conservation Areas and Wildland Linkages. The Wildland Integrity index (WI) was the result of a hierarchical model composed of a GIS decision-tree (as opposed to true/false, or 0, 1) between data sources (Figure 7). This model ranks grid cells according to a large set of criteria. The goal of this model was to analyze the bioregional planning area based on a combination of focal species habitat, species richness, and habitat integrity characteristics. We used Ecosystem Management Decision Support (EMDS), a spatial analysis software program, to build and analyze a knowledge-base that determined a Wildland Integrity value for each 500m<sup>2</sup> planning unit in the region. The WI knowledge-base consists of assertions and sub-assertions, each with a unique logical relationship based on its overall importance or data structure. An example of the OR relationship is if the knowledge-base determines a planning unit to contain high quality wolverine habitat, it is given a high value, regardless of its value for other focal species. An example of the fuzzy logic relationship is the gradually changing road density impact on habitat integrity where road density may vary from 0km/km<sup>2</sup> to 10km/km<sup>2</sup>; such a range of values would be lost if it were reduced to a 'good' or 'bad' scenario, which is appropriate for presence/absence of dams or the occurrence of rare species. See Appendix C for further discussion of the EMDS knowledge-base.

**Assertions and Sub-assertions**

- Terrestrial Habitat Integrity
  - Forest Integrity (Map 3)
    - Old-growth forests
    - Patch size
    - Oak woodlands
  - Terrestrial Vertebrate Habitat (Map 4)
    - Vertebrate species richness
    - Focal species habitat
    - Rare and endangered species
- Aquatic Integrity (Map 5)
  - Road effect
  - Dam/reservoir influence
  - Aquatic fauna

For each planning unit, the EMDS knowledge-base determined the result of the sub-assertions that defined terrestrial vertebrate habitat, forest integrity, and aquatic integrity, then determined the combined value of these three assertions based on their AND/OR relationships. The Wildland Integrity index (Map 6) ranges from 0 to 1000, where values greater than 700 represent areas with high-quality focal species habitat and high forest integrity, and/or high aquatic integrity are present.



SIERRA NEVADA  
Wildlands Conservation Plan

Map 3. Forest Integrity

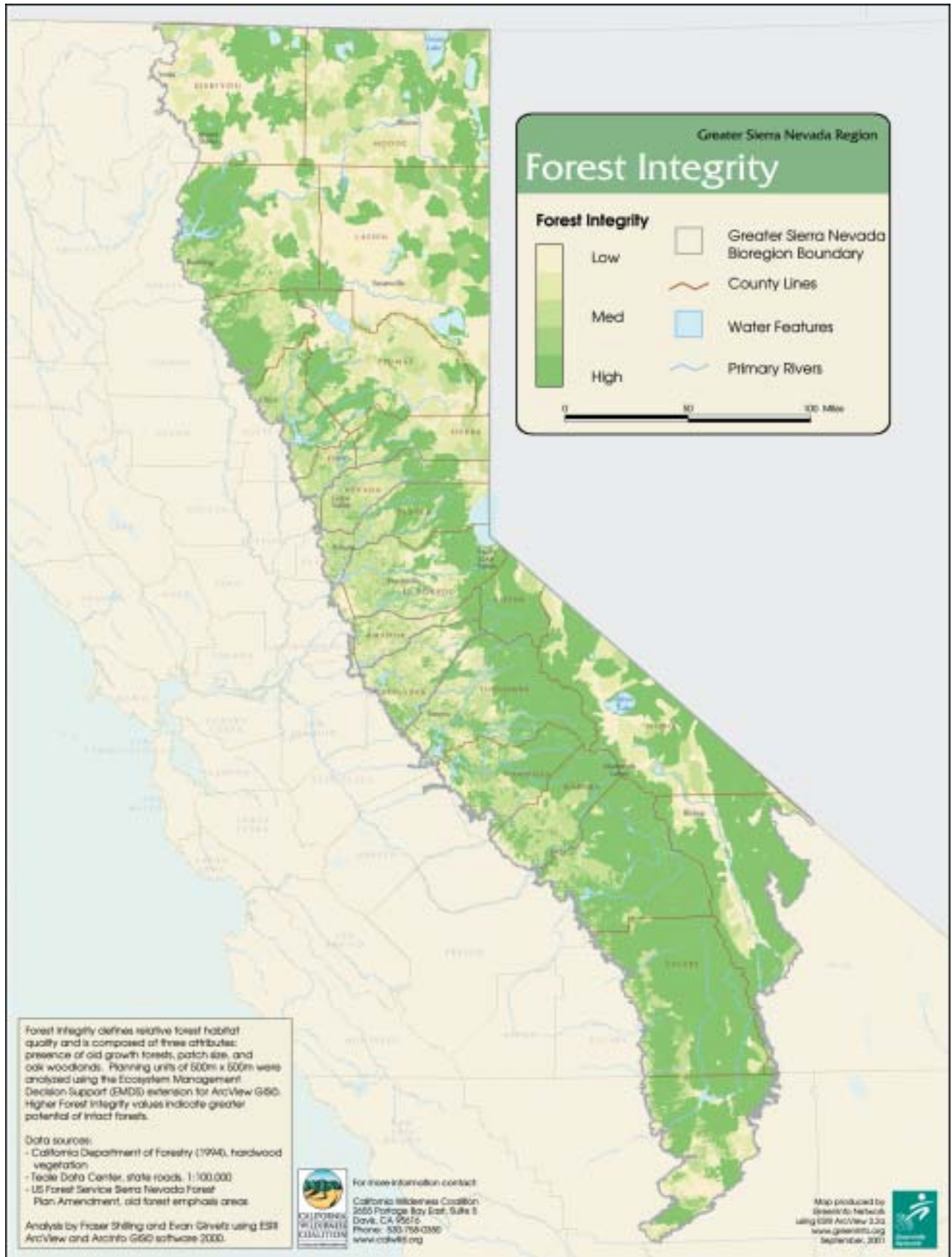



Map 4. Terrestrial Habitat

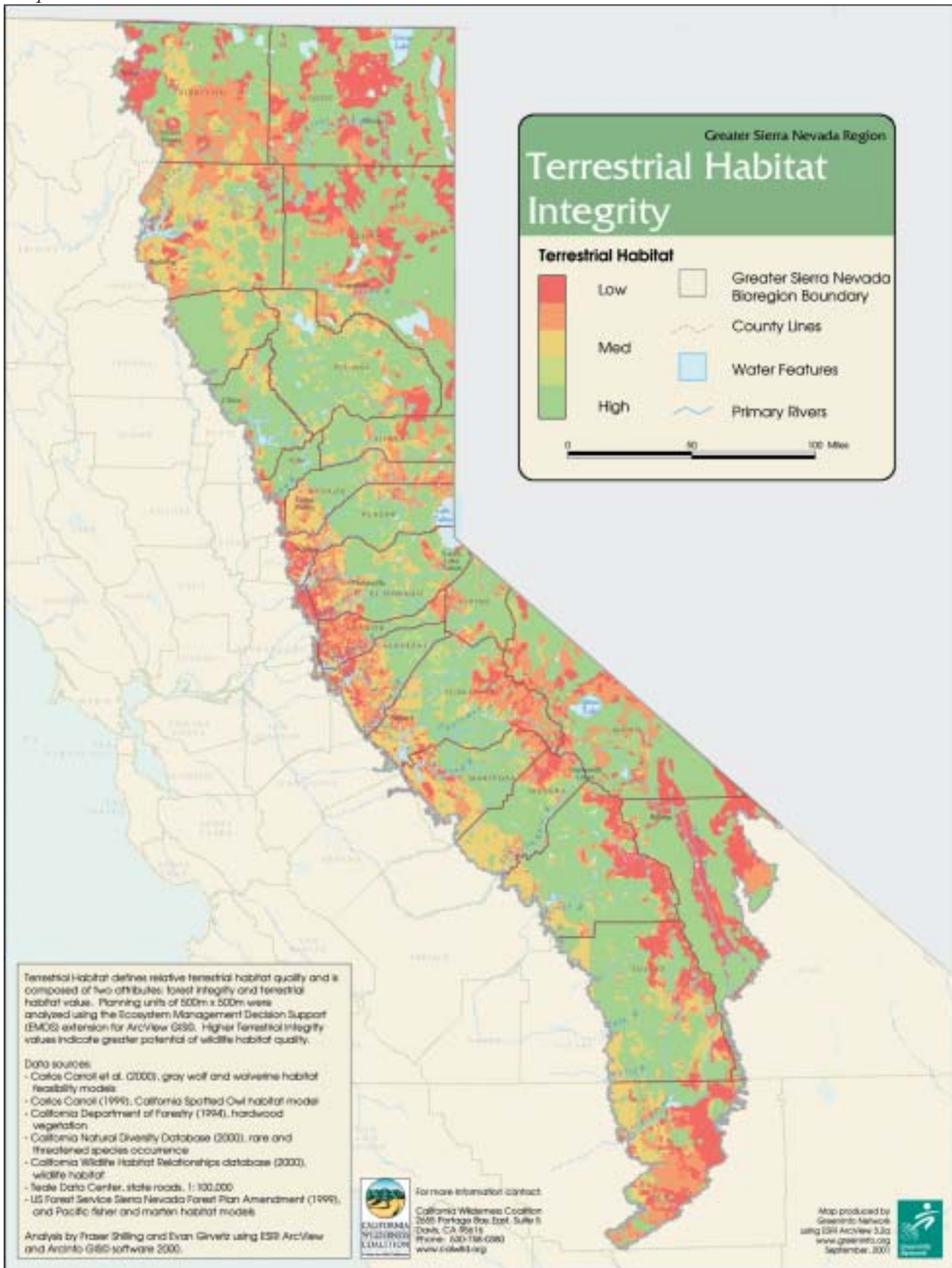

SIERRA NEVADA  
Wildlands Conservation Plan

Map 5. Aquatic Habitat Integrity

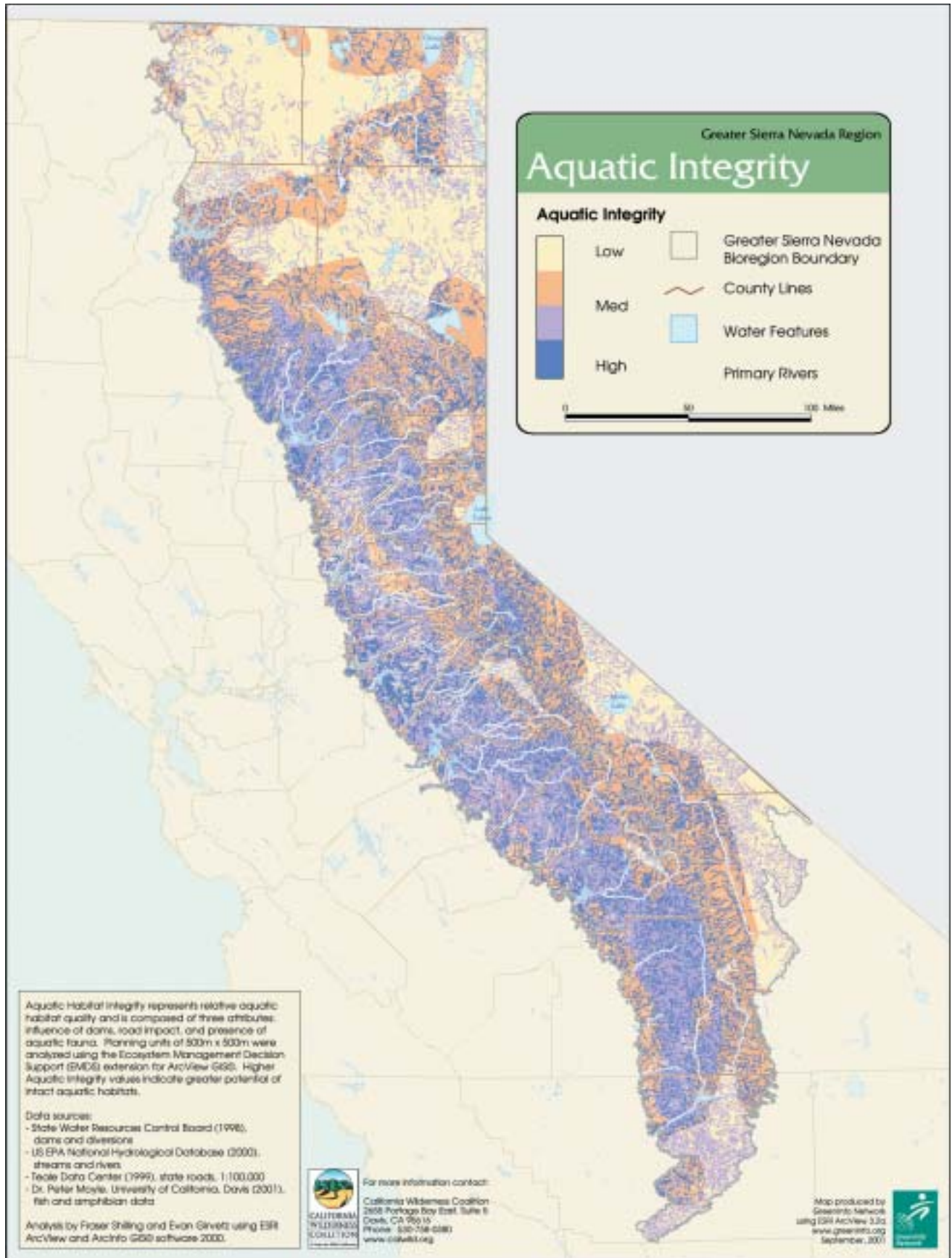



Map 6. Wildland Integrity

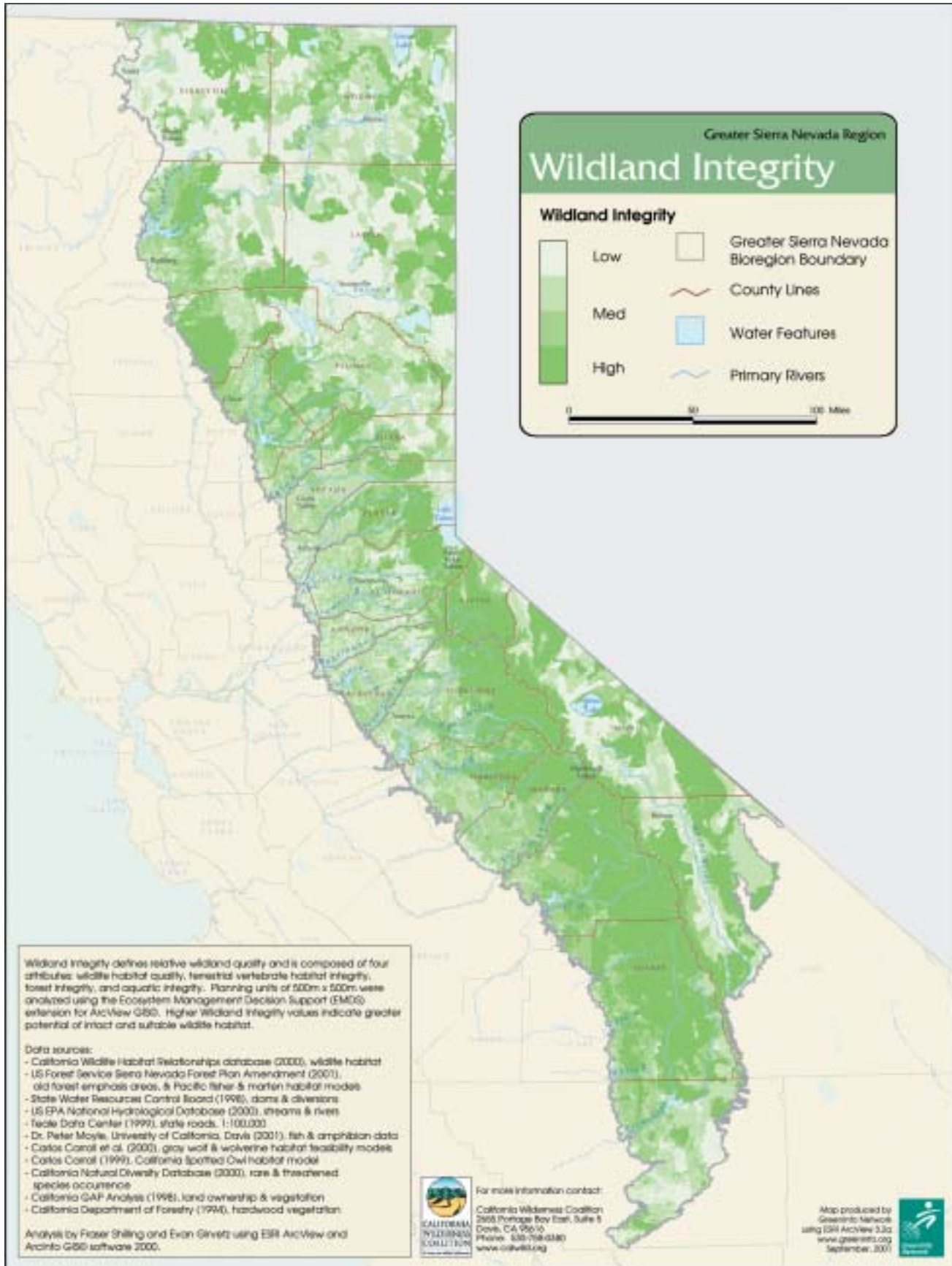

#### *4.11 Identification of Wildland Conservation Areas*

Wildland Conservation Areas are explicit land units, which represent high Wildland Integrity and achieve goals for representing target plant communities. These areas were selected by a model called SITES (Andelman et al. 1999) which uses a process called Simulated Annealing to select and group planning units together, testing various combinations of units as it attempts to meet pre-defined representation goals which accrue the least cost based on pre-defined cost variables. The objective of the SITES model is to produce a least-cost solution for meeting the goals.

We based the plant community representation goals on Andelman et al. (1999) (Table 13) and used two cost variables to guide the SITES model in selecting potential Wildland Conservation Areas:

1. Wildland Integrity, values from 0-1000 (low integrity = high cost)
2. Boundary Modifier (0.1), which resulted in individual sites, or Wildland Conservation Areas, to be greater than 10,000 acres.

The cost variables are used to challenge SITES to select not only units that meet the plant representation goals, but are also large and of high Wildland Integrity.

As plant community representation goals were an important element in site selection and the planning area was a vast and diverse bioregion, we divided the larger bioregion into four subregions, or stratification units: Cascade and Modoc subregion, north Sierra subregion, south Sierra subregion, and east Sierra subregion and ran SITES on each region, separately. Using these subregional planning areas forced the SITES model to meet representation goals in the context of the Wildland Integrity costs for each subregion. As an example, the fragmented westside of the north Sierra subregion has lower values of Wildland Integrity (higher cost) than similar habitats in the Cascade and Modoc subregion, making site selection more challenging in the westside Sierra subregion than if SITES was allowed to ignore this area and find equivalent habitats in areas with greater Wildland Integrity (lower cost) further north or south.

Planning units were formed by intersecting 6th order planning watersheds with California GAP vegetation and ownership polygons and Jepson bioregions. This provided smaller planning units than could be available from either watershed or vegetation polygons by themselves.

Existing protected areas were used as seeds, or starting places for the SITES model to begin meeting representation goals. The Simulated Annealing function of the SITES model can then span out from the seed areas or establish new sites that may be discontinuous from the seeds.

The team ran 10 runs of the SITES model each with 1,000,000 combinations of planning units. From these 10,000,000 runs, SITES recommended the best solution (Map 7). The SITES model result represents the portfolio of planning units that best meets the plant community goals with minimal costs of Wildland Integrity and Boundary Modifier.

Table 13. Target for plant community representation in wildland conservation areas:

COMMUNITY	REPRESENTATION GOAL (%)
<b>UNCOMMON SMALL PATCH</b>	
Coastal and Valley Freshwater Marsh	70
Sphagnum Bog	70
Upper Sonoran Manzanita Chaparral	70
Knobcone Pine Forest	70
Dry Salt Flat	70
Upper-Elevation Conifer Plantation	70
Bush Chinquapin Chaparral	70
Oregon Oak Woodland	70
Montane Riparian Scrub	70
Great Basin Wet Meadow	70
Mesic North Slope Chaparral	70
Aspen Forest	70
Leather Oak Chaparral	70
Huckleberry Oak Chaparral	70
Scrub Oak Chaparral	70
Great Valley Cottonwood Riparian Forest	70
Whitebark Pine Forest	70
Valley Oak Woodland	70
Whitebark Pine-Lodgepole Pine Forest	70
Rabbitbrush Scrub	70
Non-Serpentine Foothill Pine Woodland	70
<b>UNCOMMON LARGE PATCH</b>	
Tanoak Forest	60
Buck Brush Chaparral	60
Cercocarpus ledifolius woodland	60
Montane Meadow	60
Low Sagebrush Scrub	60
<b>UNCOMMON MATRIX</b>	
Silver Sagebrush Scrub	50
Interior Live Oak Chaparral	50
Northern Mixed Chaparral	50
Desert Saltbrush Scrub	50
Desert Greasewood Scrub	50
<b>FREQUENT SMALL PATCH</b>	
Subalpine or Alpine Meadow	60
Whitebark Pine-Mountain Hemlock Forest	60
Subalpine Sagebrush Scrub	60
Chamise Chaparral	60
Interior Live Oak Woodland	60
Canyon Live Oak Forest	60
Black Oak Woodland	60
<b>FREQUENT LARGE PATCH</b>	
Montane Manzanita Chaparral	50
Lodgepole Pine Forest	50
Montane Ceanothus Chaparral	50
Blue Oak Woodland	50
Big Sagebrush Scrub	50

*Target for plant community representation in wildland conservation areas, Continued*

<b>COMMUNITY</b>	<b>REPRESENTATION GOAL (%)</b>
<b>FREQUENT MATRIX</b>	
Sierran White Fir Forest	40
Open Foothill Pine Woodland	40
Great Basin Woodlands	40
Great Basin Mixed Scrub	40
<b>ABUNDANT SMALL PATCH</b>	
Mixed Montane Chaparral	50
Black Oak Forest	50
<b>ABUNDANT LARGE PATCH</b>	
Jeffrey Pine Forest	40
Jeffrey Pine-Fir Forest	40
Westside Ponderosa Pine Forest	40
Red Fir (Lodgepole Pine)- Western White Pine Forest	40
Interior Live Oak Forest	40
Red Fir Forest	40
Foothill Pine-Oak Woodland	40
<b>ABUNDANT MATRIX</b>	
Sierran Mixed Coniferous Forest	30
Eastside Ponderosa Pine Forest	30
Non-Native Grassland	30



Map 7. SITES model results

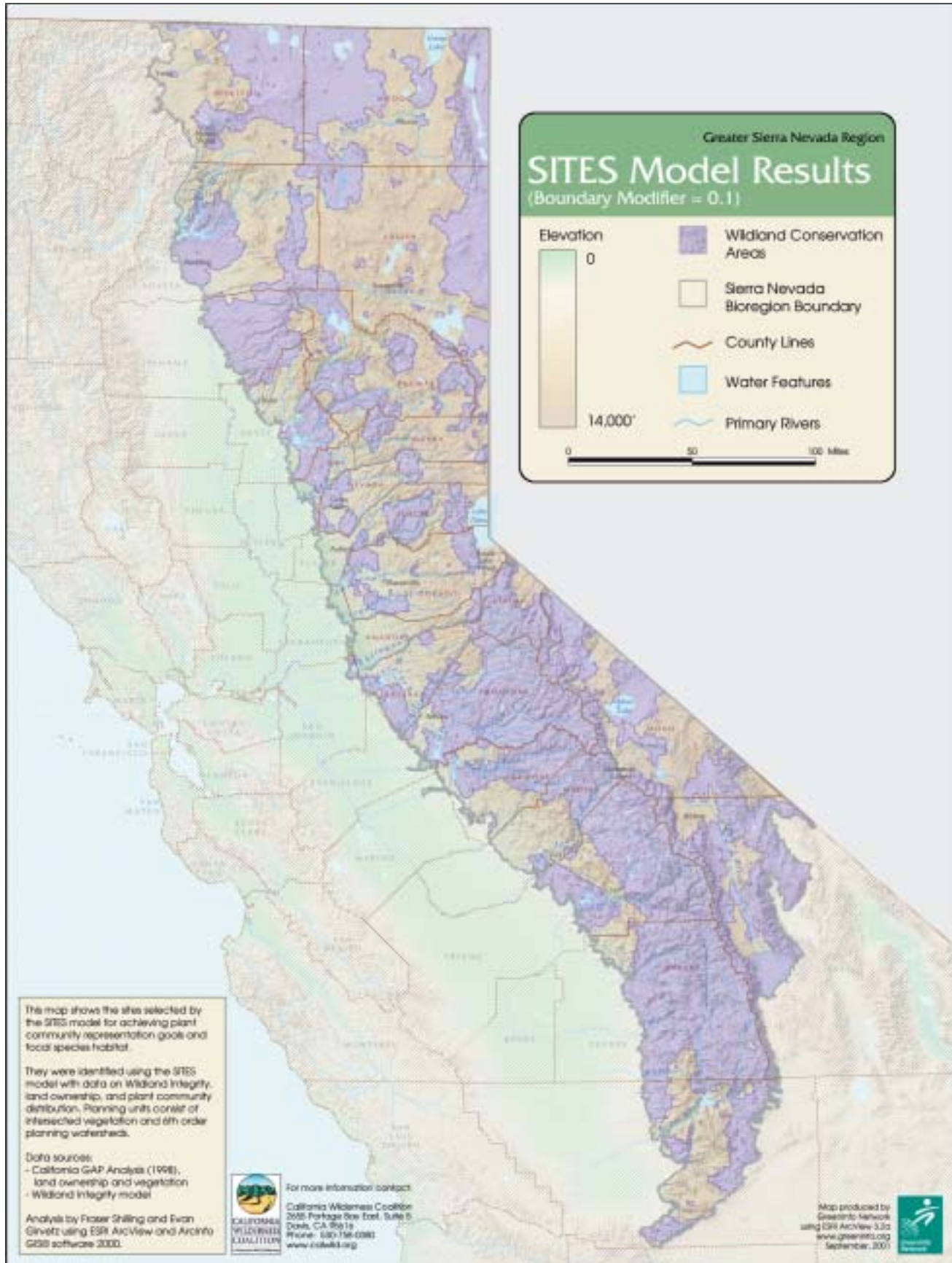

#### *4.12 Identification of Wildland Linkages*

We used a method called Least-Cost Path analysis to identify potential wildlife movement paths between the Wildland Conservation Areas defined by the SITES model. Wildland Linkages are intended to provide the following functions: (1) connect Wildland Conservation Areas together, (2) enable focal species to move between Wildland Conservation Areas, and (3) improve habitat connectivity for forest dwelling species. Least-Cost Path analysis finds the path of least resistance between two points, much in the same way electricity moves through an object. Cost for movement was influenced by four cost variables or constraints: (see Wildland Linkage Potential in Figure 6, page 73).

- Wildland Integrity
- Topography
- Plant community
- Human population

We made the following three assumptions in support of these costs: focal species are more likely to move within regional vegetation-type zones (e.g. oak woodlands, mixed conifer forests). The exception to this is upslope-downslope migrators such as mule deer and California spotted owl, which were accommodated by identifying east-west linkages between Wildland Conservation Areas. The second assumption was that wildlife movement most likely avoids steep slopes. While the Wildland Integrity index may state a patch of habitat is good habitat for movement, there may be steep river canyons and cliffs, which are not good for movement. To address this finer scale land characteristic, we created a slope cost surface, or topographic constraint, that encouraged the path model to avoid steep terrain in the selection of linkages. The third assumption made was that wildlife movement should avoid areas of high human population density to avoid wildlife-human conflicts and roadkill.

Lastly, to illustrate these linkages at the regional scale, we buffered each linkage by 1.0 km. This measurement has no bearing on the function or structure of the linkages.

#### *4.13 Comparative Representation Analysis*

We identified eight elements to test the effectiveness of the approach used to identify Wildland Conservation Areas. We did not explicitly set representation goals for these elements, so the questions “how much is enough,” or “do we have an optimal design” are not addressed here. Rather, this analysis tests the ability of the system of Wildland Conservation Areas to reflect regionally important criteria for biodiversity protection. These elements include:

1. Roadless areas larger than 1,000 acres. Roadless areas are believed to serve as harbors for biodiversity in an ever fragmenting landscape. One assumption of plans based on the needs of wide-ranging carnivores (gray wolf and wolverine) is that a majority of large roadless areas will be encompassed by the plan. Data was obtained from Sierra Nevada Biodiversity Institute.
2. Late seral - old-growth forests. These constitute a critical habitat in the Sierra Nevada. Data was obtained from the USFS Sierra Nevada Forest Plan Amendment (2000).



**3. Focal species habitat** (see methods section in Appendix C)

- a. Pacific fisher. High quality habitat, model values greater than 10,000.
- b. Marten. High quality habitat, model values greater than 8300.
- c. California spotted owl. High quality habitat, model values greater than 90.
- d. Gray wolf. High quality habitat, model values greater than 75.
- e. Wolverine. High quality habitat, model values greater than 75.
- f. The Nature Conservancy's portfolio sites. Through the Nature Conservancy's "Geography of Hope" approach to identifying biologically outstanding areas in the Sierra Nevada ecoregion, 573 sites were identified. As the criteria for selecting sites differs between the two approaches, it is of interest to see how much of the biodiversity criteria approach overlaps with a focal species criteria approach.



---

SECTION FIVE

---

*Results and Discussion*



© Claus Sinert



## Section 5

### Results and Discussion

#### 5.1 WILDLAND CONSERVATION AREAS

Wildland Conservation Areas (Maps 9a, b, and c, on pages 84-86) are areas that meet our goals for representing native plant communities within areas of high wildland integrity. In all, Wildland Conservation Areas proposed within this plan account for 9.8 million acres (33%) of the Sierra Nevada bioregion. This, in addition to the 5.6 million acres already protected would conceivably place 52% (15 out of 29 million acres) in some form of protected status (e.g. conservation easement, park, wilderness) (Figure 8, A).

A comparative representation analysis evaluated the proposed system of Wildland Conservation Areas as to how well they would meet regionally important criteria for biodiversity protection (Figure 8, C). The system of Wildland Conservation Areas includes 71% of roadless areas larger than 1,000 acres, 86% of mapped high-quality, late-seral old growth forests, 67% of predicted fisher habitat, 55% of predicted marten habitat, 65% of predicted California spotted owl habitat, 70% of predicted gray wolf habitat, 85% of predicted wolverine habitat, and 80% of The Nature Conservancy's portfolio sites. The roadless areas data are limited to U.S. Forest Service lands, thus do not include unroaded areas on Bureau of Land Management (BLM) or private lands. Mean road density in Wildland Conservation Areas is approximately 0.5 km/km<sup>2</sup>. Predicted focal species habitat represents all potential habitat available in the region. The Nature Conservancy's portfolio sites addressed different criteria than focal species habitat and wildlands.

Wildland Conservation Areas are evenly distributed throughout the four subregions: the Cascade and Modoc Plateau, north Sierra, south Sierra, and east Sierra (Figure 6, B).

##### **Cascade and Modoc subregion**

Five large Wildland Conservation Areas are found; these span Forest Service and BLM lands, and range from the Great Basin habitat along the Warner Mountains to mixed conifer forests around Mount Shasta and a remarkably intact foothill component in Lassen County. As the Wildland Conservation Areas encompass the subregion's large parks and wilderness areas, there are excellent opportunities for expanding the boundaries of these protected areas and restoring wide-range carnivores to this subregion. Restoration has a good chance of succeeding due to low road density, and abundant prey.

##### **Southern Sierra subregion**

In the southern Sierra, high- and middle-elevation forests are captured by a complex of large Wildland Conservation Areas beginning at Yosemite National Park and ending in the Sequoia National Forest and private lands in the Tehachapi Mountains. A large foothill component on the Sierra's westside is also prominent.

**Eastern Sierra subregion**

The Great Basin habitats of the Sierra Nevada's eastside are well represented in seven significant Wildland Conservation Areas. The current scattered protected areas would be expanded to include surrounding high-quality wildlands.

**Northern Sierra subregion**

A majority of the northern subregion lacks Wildland Conservation Areas larger than 1 million acres due to the severity of habitat fragmentation and high road density in foothill and middle-elevation forests. Higher-elevation wildlands in the subregion are relatively intact and therefore comprise the subregion's largest Wildland Conservation Areas. Another trouble spot for wildlands conservation is found in the Lassen National Forest, where forest fragmentation is high, yet road density is low to moderate. This suggests an opportunity for landscape level wildland restoration.

Figure 6. Results. (A. Percentage of region occupied by Wildland Conservation Areas. B. Percentage occupied by Wildland Conservation Areas within subregions. C. Comparative representation analysis for Wildland Conservation Areas.)

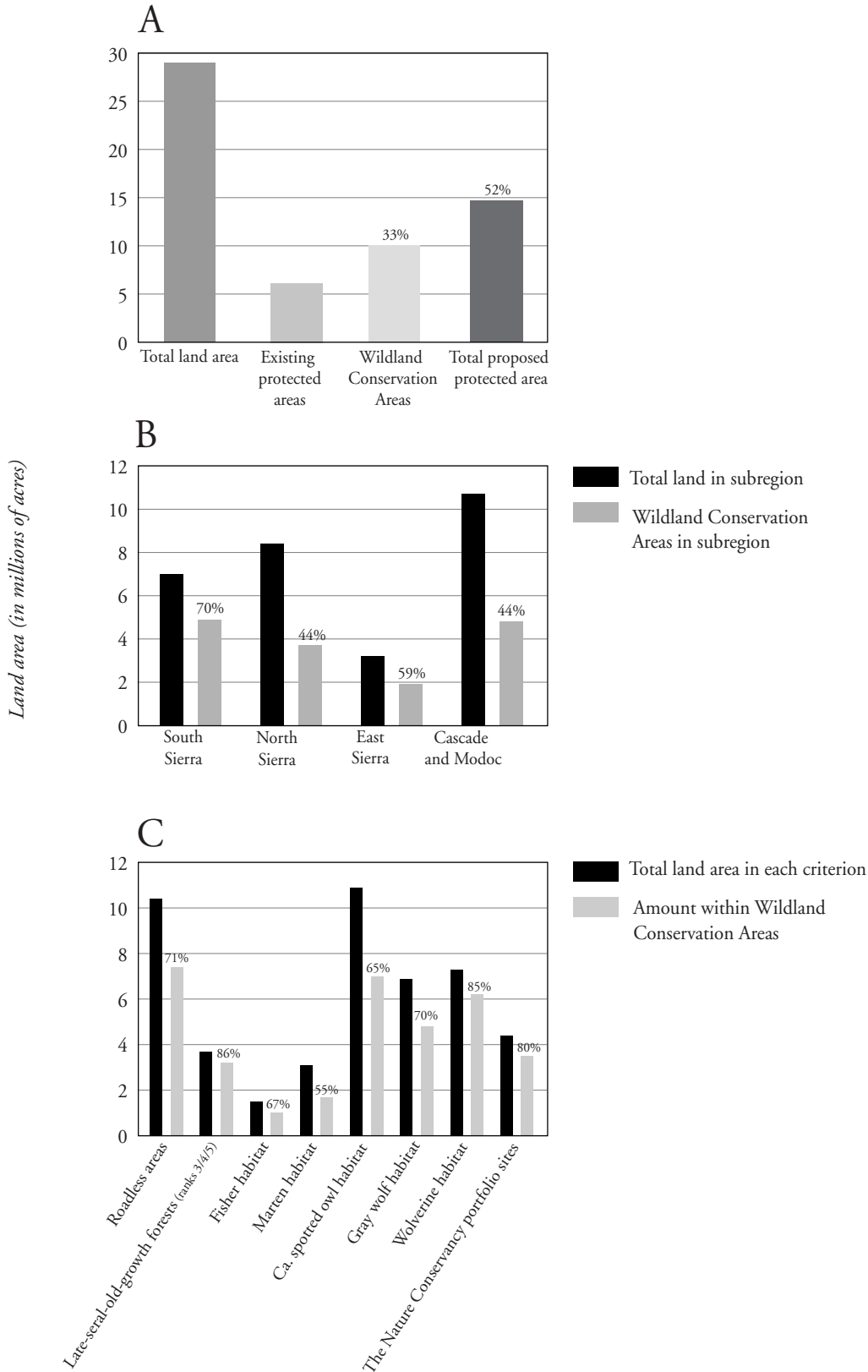

### 5.1.1 Representation of plant communities within Wildland Conservation Areas

Representation of plant communities was tested by calculating the area of each Sierra Nevada plant community within Wildland Conservation Areas and comparing the percentage of the total for each plant community to the plant community representation goals provided to the SITES model.

These results suggest that the system of Wildland Conservation Areas coarsely represent habitat types according to the goals set (Table 13). The fit is not perfect in part due to the constraint set on the boundary length (“edge”) of the Wildland Conservation Areas. In other words, a system of smaller and scattered Wildland Conservation Areas would likely perform better at meeting plant community representation goals than the present system of larger wildland areas, but such a system would not be ideal for maintaining populations of keystone species like the wolverine.

Of the 71 plant communities in the Cascade and Modoc subregion, 6 failed to come within 5% of the representation goal, while 32 exceeded the goal by >5%. Of the 67 plant communities (not including bare rock, agriculture, etc.) in the northern Sierra Nevada subregion, 5 failed to come within 5% of the representation goal for that community, while 21 exceeded the goal by >5%. Of the 69 plant communities in the southern Sierra Nevada subregion, 2 failed to come within 5% of the representation goal, while 43 exceeded the goal. Of the 43 plant communities in the eastern Sierra Nevada subregion, 7 failed to come within 5% of the representation goal, while 19 exceeded the goal. Special local planning will be necessary to protect more of the communities that did not meet the goals.

Table 14. Percent of target plant communities represented in Wildland Conservation Areas (Boundary Modifier = 0.1).

#### CASCADE & MODOC SUBREGION

PLANT COMMUNITY NAME	GOAL (HECTARES)	GOAL MET	HECTARES IN PORTFOLIO	PERCENT OF GOAL
Agricultural Land	0	yes	79,232	100%
Alkali Meadow	1,366	no	1,334	98%
Aspen Forest	1,463	yes	2,091	143%
Bare Exposed Rock	0	yes	52,646	100%
Big Sagebrush Scrub	154,897	yes	156,892	101%
Black Oak Forest	40,059	yes	41,452	103%
Black Oak Woodland	7,945	no	5,241	66%
Blue Oak Woodland	101,251	yes	137,899	136%
Buck Brush Chaparral	15,880	yes	19,694	124%
Bush Chinquapin Chaparral	2,856	yes	4,080	143%
Cercocarpus ledifolius woodland	5,630	yes	6,395	114%
Desert Greasewood Scrub	51,804	yes	66,318	128%
Desert Saltbrush Scrub	12,534	yes	25,007	200%
Dry Salt Flat	40,280	no	38,514	96%
Dryland Grain Crops	0	yes	13,998	100%
Eastside Ponderosa Pine Forest	410,902	yes	410,856	100%
Foothill Pine-Oak Woodland	88,351	yes	162,701	184%
Great Basin Grassland	9,844	yes	9,869	100%
Great Basin Mixed Scrub	427,850	yes	463,946	108%



CASCADE & MODOC SUBREGION, CONTINUED

PLANT COMMUNITY NAME	GOAL (HECTARES)	GOAL MET	HECTARES IN PORTFOLIO	PERCENT OF GOAL
Great Basin Wet Meadow	28,326	no	27,733	98%
Great Basin Woodlands	540,204	yes	540,323	100%
Great Valley Mixed Riparian Forest	3,790	yes	5,414	143%
Interior Live Oak Chaparral	5,897	yes	10,383	176%
Interior Live Oak Forest	12,057	yes	12,269	102%
Interior Live Oak Woodland	639	yes	1,065	167%
Intermittently flooded Lacustrine Habitat	52,627	yes	72,997	139%
Irrigated Grain Crops	0	yes	28,620	100%
Irrigated Hayfield	0	yes	281,699	100%
Jeffrey Pine Forest	15,904	no	13,136	83%
Jeffrey Pine-Fir Forest	21,897	no	21,881	100%
Juniper-Oak Cismontane Woodland	43,475	yes	55,248	127%
Klamath-Cascades Fell-Field	8,931	yes	14,886	167%
Knobcone Pine Forest	1,942	yes	2,147	111%
Lodgepole Pine Forest	32,019	yes	49,275	154%
Low Sagebrush Scrub	173,134	yes	181,491	105%
Mid-elevation Conifer Plantation	0	yes	85,449	100%
Mixed Barren Land	0	yes	0	100%
Modoc White Fir Forest	230,713	yes	231,095	100%
Modoc-Gr. Basin Cottonwood- Willow Riparian Forest	6,246	no	3,015	48%
Modoc-Great Basin Riparian Scrub	123	yes	205	167%
Montane Ceanothus Chaparral	19,867	no	19,497	98%
Montane Manzanita Chaparral	47,729	yes	49,201	103%
Montane Meadow	12,134	yes	12,286	101%
Montane Riparian Scrub	221	yes	242	109%
Mud Flats	6,746	yes	6,904	102%
Non-Native Grassland	61,012	yes	67,704	111%
Non-Serpentine Foothill Pine Woodland	18,228	yes	18,244	100%
Northern Basalt Flow Vernal Pool	791	yes	791	100%
Northern Interior Cypress Forest	2,399	no	1,979	83%
Northern Mixed Chaparral	5,210	yes	10,420	200%
Open Foothill Pine Woodland	74,963	yes	86,454	115%
Oregon Oak Woodland	78,571	no	78,255	100%
Pasture	0	yes	0	100%
Permanently flooded Lacustrine Habitat	0	yes	90,794	100%
Rabbitbrush Scrub	13,348	yes	13,583	102%
Red Fir Forest	99,441	yes	189,944	191%
Salvia dorri/Chamaebatiaria scrub	3,567	yes	5,945	167%
Shin Oak Brush	6,650	yes	8,397	126%
Sierran Mixed Coniferous Forest	515,326	yes	515,329	100%
Sierran White Fir Forest	15,278	yes	16,465	108%
Silver Sagebrush Scrub	5,072	no	4,608	91%
Subalpine or Alpine Meadow	4,706	no	3,756	80%
Subalpine Sagebrush Scrub	6,816	yes	7,075	104%
Transmontane Alkali Marsh	573	yes	818	143%
Transmontane Freshwater Marsh	26,181	yes	37,318	143%

# SIERRA NEVADA

## Wildland Conservation Plan

### CASCADE & MODOC SUBREGION, CONTINUED

PLANT COMMUNITY NAME	GOAL (HECTARES)	GOAL MET	HECTARES IN PORTFOLIO	PERCENT OF GOAL
Upper-elevation Conifer Plantation	11,722	yes	12,486	107%
Urban or Built-up Land	0	yes	14,013	100%
Westside Ponderosa Pine Forest	191,314	yes	191,501	100%
White Alder Riparian Forest	2,977	yes	4,253	143%
Whitebark Pine-Lodgepole Pine Forest	5,765	yes	8,236	143%
Whitebark Pine-Mountain Hemlock Forest	323	yes	539	167%
<b>Total</b>	<b>1,532,862</b>		<b>1,947,974</b>	

### NORTHERN SIERRA SUBREGION

PLANT COMMUNITY NAME	GOAL (HECTARES)	GOAL MET	HECTARES IN PORTFOLIO	PERCENT OF GOAL
Agricultural Land	0	yes	756	100%
Alpine Dwarf Scrub	1,425	yes	2,375	167%
Aspen Forest	5,334	yes	5,491	103%
Bare Exposed Rock	0	yes	270,666	100%
Big Sagebrush Scrub	48,554	no	47,914	99%
Big Tree Forest	993	yes	1,418	143%
Black Oak Forest	92,559	yes	92,568	100%
Black Oak Woodland	70,268	yes	70,321	100%
Blue Oak Woodland	105,814	yes	105,679	100%
Buck Brush Chaparral	1,838	yes	2,548	139%
Bush Chinquapin Chaparral	3,252	no	3,146	97%
Canyon Live Oak Forest	54,648	yes	61,653	113%
Cercocarpus ledifolius woodland	19,523	no	19,405	99%
Chamise Chaparral	56,485	yes	56,518	100%
Eastside Ponderosa Pine Forest	140,444	yes	140,459	100%
Foothill Pine-Oak Woodland	252,144	yes	252,106	100%
Great Basin Mixed Scrub	29,502	yes	29,452	100%
Great Basin Woodlands	32,481	yes	41,269	127%
Great Valley Cottonwood Riparian Forest	1,064	yes	1,102	104%
Huckleberry Oak Chaparral	17,699	yes	17,826	101%
Interior Live Oak Chaparral	271	yes	541	200%
Interior Live Oak Forest	79,110	yes	79,390	100%
Interior Live Oak Woodland	62,392	yes	62,458	100%
Ione Chaparral	194	yes	324	167%
Irrigated Hayfield	0	yes	79	100%
Jeffrey Pine Forest	146,652	yes	196,189	134%
Jeffrey Pine-Fir Forest	154,719	no	154,682	100%
Knobcone Pine Forest	278	no	0	0%
Leather Oak Chaparral	1,401	yes	1,604	114%
Limber Pine Forest	450	yes	642	143%
Lodgepole Pine Forest	114,698	yes	183,917	160%
Low Sagebrush Scrub	10,341	no	10,225	99%
Mesic North Slope Chaparral	4,060	no	3,452	85%

NORTHERN SIERRA SUBREGION, CONTINUED

PLANT COMMUNITY NAME	GOAL (HECTARES)	GOAL MET	HECTARES IN PORTFOLIO	PERCENT OF GOAL
Mid-elevation Conifer Plantation	0	yes	21,834	100%
Mixed Barren Land	0	yes	6,398	100%
Mixed Montane Chaparral	118,585	yes	118,516	100%
Montane Ceanothus Chaparral	18,160	yes	18,098	100%
Montane Manzanita Chaparral	24,241	yes	24,248	100%
Montane Meadow	14,909	no	14,117	95%
Montane Riparian Scrub	6,462	no	5,567	86%
Non-Native Grassland	73,401	no	71,544	97%
Non-Serpentine Foothill Pine Woodland	25,391	yes	25,412	100%
Northern Mixed Chaparral	2,356	yes	2,590	110%
Open Foothill Pine Woodland	14,461	yes	16,146	112%
Orchard or Vineyard	0	yes	0	100%
Oregon Oak Woodland	1,872	yes	1,925	103%
Permanently flooded Lacustrine Habitat	0	yes	36,903	100%
Rabbitbrush Scrub	412	yes	588	143%
Red Fir Forest	154,903	yes	159,422	103%
Red Fir Lodgepole- West. White Pine Forest	116,702	yes	228,878	196%
Scrub Oak Chaparral	631	yes	902	143%
Sierran Mixed Coniferous Forest	480,877	yes	480,910	100%
Sierran White Fir Forest	36,168	yes	36,048	100%
Silver Sagebrush Scrub	1,249	no	0	0%
Sphagnum Bog	80	yes	114	143%
Subalpine or Alpine Meadow	12,405	no	11,824	95%
Subalpine Sagebrush Scrub	9,619	yes	9,684	101%
Tanoak Forest	6,902	no	6,845	99%
Transitional Bare Areas	0	yes	0	100%
Upper Sonoran Manzanita Chaparral	10,709	yes	14,359	134%
Upper-elevation Conifer Plantation	669	no	640	96%
Urban or Built-up Land	0	yes	15,246	100%
Valley Oak Woodland	8,875	yes	9,326	105%
Westside Ponderosa Pine Forest	414,378	yes	414,421	100%
Whitebark Pine Forest	19,866	yes	19,961	100%
Whitebark Pine- Lodgepole Pine Forest	33,451	yes	37,444	112%
Whitebark Pine-Mountain Hemlock Forest	24,831	yes	39,329	158%
<b>Total</b>	<b>3,141,160</b>		<b>3,765,411</b>	

SOUTHERN SIERRA SUBREGION

PLANT COMMUNITY NAME	GOAL (HECTARES)	GOAL MET	HECTARES IN PORTFOLIO	PERCENT OF GOAL
Agricultural Land	0	yes	3,724	100%
Alpine Dwarf Scrub	61,318	yes	101,317	165%
Aspen Forest	1,302	yes	1,607	123%

## SOUTHERN SIERRA SUBREGION, CONTINUED

PLANT COMMUNITY NAME	GOAL (HECTARES)	GOAL MET	HECTARES IN PORTFOLIO	PERCENT OF GOAL
Bare Exposed Rock	0	yes	646,552	100%
Big Sagebrush Scrub	56,969	yes	62,182	109%
Big Tree Forest	23,003	yes	25,357	110%
Black Oak Forest	55,590	yes	56,051	101%
Black Oak Woodland	17,573	no	17,387	99%
Blackbush Scrub	1,318	yes	1,868	142%
Blue Oak Woodland	472,027	yes	472,552	100%
Buck Brush Chaparral	21,360	yes	22,021	103%
Canyon Live Oak Forest	77,729	yes	102,300	132%
Cercocarpus ledifolius woodland	12,937	yes	16,615	128%
Chamise Chaparral	62,017	yes	62,053	100%
Eastside Ponderosa Pine Forest	417	yes	792	190%
Foothill Pine-Oak Woodland	199,429	yes	199,428	100%
Foxtail Pine Forest	48,959	yes	69,942	143%
Great Basin Mixed Scrub	2,242	yes	2,450	109%
Great Basin Woodlands	63,694	yes	132,892	209%
Great Valley Cottonwood Riparian Forest	1,486	no	1,469	99%
Great Valley Mixed Riparian Forest	2,556	yes	2,820	110%
Huckleberry Oak Chaparral	7,533	yes	10,761	143%
Interior Live Oak Chaparral	24,270	yes	24,297	100%
Interior Live Oak Forest	78,605	yes	78,741	100%
Interior Live Oak Woodland	98,785	yes	98,821	100%
Jeffrey Pine Forest	53,758	yes	83,468	155%
Jeffrey Pine-Fir Forest	188,300	yes	438,955	233%
Joshua Tree Woodland	12,224	yes	17,463	143%
Knobcone Pine Forest	2,857	yes	3,045	107%
Lodgepole Pine Forest	186,406	yes	363,835	195%
Mesic North Slope Chaparral	15,370	yes	17,997	117%
Mid-elevation Conifer Plantation	0	yes	497	100%
Mixed Montane Chaparral	28,514	yes	39,834	140%
Mojave Creosote Bush Scrub	504	yes	841	167%
Mojave Mixed Woody Scrub	73,471	yes	115,089	157%
Mojavean Pinyon and Juniper Woodlands	101,885	no	100,005	98%
Montane Black Cottonwood Riparian Forest	139	yes	199	143%
Montane Ceanothus Chaparral	108	yes	215	200%
Montane Manzanita Chaparral	24,033	yes	24,113	100%
Montane Meadow	418	no	332	79%
Montane Riparian Scrub	1,093	yes	1,198	110%
Non-Native Grassland	48,691	yes	49,307	101%
Non-Serpentine Foothill Pine Woodland	5,563	no	5,353	96%
Northern Mixed Chaparral	13,911	yes	19,350	139%
Oak-Pinyon Woodland	30,547	yes	42,786	140%
Open Foothill Pine Woodland	27,109	yes	29,609	109%

**SOUTHERN SIERRA SUBREGION, CONTINUED**

<b>PLANT COMMUNITY NAME</b>	<b>GOAL (HECTARES)</b>	<b>GOAL MET</b>	<b>HECTARES IN PORTFOLIO</b>	<b>PERCENT OF GOAL</b>
Oregon Oak Woodland	86	yes	123	143%
Permanently flooded Lacustrine Habitat	0	yes	14,947	100%
Red Fir Forest	216,943	yes	518,810	239%
Red Fir Lodgepole- West. White Pine Forest	18,536	yes	43,729	236%
Scrub Oak Chaparral	9,696	no	9,624	99%
Semi-Desert Chaparral	8,937	no	8,662	97%
Shin Oak Brush	1,970	yes	2,610	133%
Sierra Nevada Fell-Field	9,842	yes	16,403	167%
Sierran Mixed Coniferous Forest	150,362	yes	244,949	163%
Sierran White Fir Forest	2,538	yes	5,177	204%
Silver Sagebrush Scrub	3,223	yes	6,445	200%
Southern Interior Cypress Forest	576	no	0	0%
Streams and Canals	0	yes	98	100%
Subalpine or Alpine Meadow	6,719	yes	11,198	167%
Upper Sonoran Manzanita Chaparral	15,243	no	15,019	99%
Upper Sonoran Subshrub Scrub	1,081	yes	1,286	119%
Urban or Built-up Land	0	yes	378	100%
Valley Oak Woodland	30,178	yes	30,979	103%
Westside Ponderosa Pine Forest	175,458	yes	255,732	146%
White Alder Riparian Forest	349	yes	498	143%
Whitebark Pine Forest	6,736	yes	8,661	129%
Whitebark Pine- Lodgepole Pine Forest	77,845	yes	102,210	131%
Whitebark Pine-Mountain Hemlock Forest	22,386	yes	36,110	161%
<b>Total</b>	<b>2,964,724</b>		<b>4,901,140</b>	

**EASTERN SIERRA SUBREGION**

<b>PLANT COMMUNITY NAME</b>	<b>GOAL (HECTARES)</b>	<b>GOAL MET</b>	<b>HECTARES IN PORTFOLIO</b>	<b>PERCENT OF GOAL</b>
Agricultural Land	0	yes	29,680	100%
Alkali Meadow	72,241	no	72,209	100%
Alpine Dwarf Scrub	33,895	yes	33,937	100%
Aspen Forest	3,363	no	2,963	88%
Aspen Riparian Forest	1,114	yes	1,270	114%
Bare Exposed Rock	0	yes	75,957	100%
Big Sagebrush Scrub	98,444	yes	99,590	101%
Blackbush Scrub	47,340	yes	47,370	100%
Bristlecone Pine Forest	13,139	yes	13,334	101%
Canyon Live Oak Forest	54	yes	91	168%
Cercocarpus ledifolius woodland	52,660	yes	58,136	110%
Desert Greasewood Scrub	37,790	yes	59,545	158%
Desert Saltbrush Scrub	75,461	yes	80,559	107%

SIERRA NEVADA

Wildland Conservation Plan

EASTERN SIERRA SUBREGION, CONTINUED

PLANT COMMUNITY NAME	GOAL (HECTARES)	GOAL MET	HECTARES IN PORTFOLIO	PERCENT OF GOAL
Desert Sink Scrub	78,112	yes	83,487	107%
Dry Salt Flat	49,211	yes	70,301	143%
Eastside Ponderosa Pine Forest	175	yes	180	103%
Great Basin Grassland	2,908	no	2,474	85%
Great Basin Mixed Scrub	234,606	yes	263,473	112%
Great Basin Woodlands	251,424	yes	306,209	122%
Irrigated Hayfield	0	yes	0	100%
Jeffrey Pine Forest	45,218	yes	45,220	100%
Jeffrey Pine-Fir Forest	272	no	0	0%
Joshua Tree Woodland	11,728	yes	16,341	139%
Lodgepole Pine Forest	4,806	yes	5,597	116%
Low Sagebrush Scrub	38,842	yes	39,131	101%
Mid-elevation Conifer Plantation	0	yes	0	100%
Mixed Barren Land	0	yes	393	100%
Mixed Montane Chaparral	175	no	99	56%
Modoc-Great Basin Riparian Scrub	4,423	no	4,104	93%
Mojave Creosote Bush Scrub	83,949	yes	134,810	161%
Mojave Mixed Woody Scrub	115,877	no	115,872	100%
Mojavean Pinyon and Juniper Woodlands	1,900	yes	2,352	124%
Montane Black Cottonwood Riparian Forest	1,250	no	1,045	84%
Montane Meadow	3,605	yes	3,803	105%
Montane Riparian Scrub	245	no	0	0%
Permanently flooded Lacustrine Habitat	0	yes	38,449	100%
Sandy Area Other than Beaches	573	yes	820	143%
Shadscale Scrub	159,956	yes	159,966	100%
Subalpine or Alpine Meadow	1,525	yes	1,856	122%
Transmontane Alkali Marsh	2,558	yes	3,655	143%
Transmontane Freshwater Marsh	16,840	yes	19,311	115%
Urban or Built-up Land	0	yes	0	100%
Whitebark Pine- Lodgepole Pine Forest	2,812	yes	3,850	137%
<b>Total</b>	<b>1,548,492</b>		<b>1,897,441</b>	
<b>TOTAL</b>			<b>15,377,521</b>	

## 5.2 WILDLAND LINKAGES<sup>5</sup>,

We defined 49 potential linear Wildland Linkages connecting Wildland Conservation Areas, providing north-south and occasionally east-west connections (Map 9a, b, and c). Wildland linkages are intended to provide wildlife movement between Wildland Conservation Areas based on the constraints and costs of the linkage model. While these linkages are represented as simple paths between wildlands, they are intended as indicators of linkage potential. The function of Wildland Linkages is to allow for wildlife movement, but their structure and detailed design are not specified in this regional scale analysis, nor were all possible linkages defined among the Wildland Conservation Areas. Function and structure of Wildland Linkages will be further developed through the site planning process.

The linkage model can be used to explore alternative linkages in the future. Although the linkages presented in this report were generated via a separate computer model, a number of Wildland Linkages correspond with the findings of the Missing Linkages Conference (Penrod et al. 2001), especially regarding areas for gray wolf, wolverine, and Pacific fisher connectivity.

Traffic volumes along the Interstate 80 and Highway 50 corridors are much higher than the values considered to inhibit large mammal migration (greater than 4,000 cars/day). Other highways (e.g., Highway 49) have traffic volumes greater than 4,000 cars/day and therefore may also function as “disturbance barriers” to animal movement. The California Department of Transportation has recognized the impacts of these barriers to wildlife on key highways and in some cases has mitigated impacts by using wildlife crossing structures (e.g., the wildlife underpasses constructed on Interstate 80, 10 miles west of the town of Truckee). However, the severity of disturbance may not be recognized due to inadequate data about actual disturbance and impacts to wildlife migration and reproduction. Areas where high traffic volume roads intersect with Wildland Conservation Areas and Wildland Linkages should receive immediate attention for mitigation using measures such as highway underpasses and overpasses.

## 5.3 STEWARDSHIP ZONES

Stewardship Zones (Map 9a) represent three classes of significant Wildland Integrity: 1) Good Wildland Potential, 2) High Wildland Potential, and 3) Highest Wildland Potential. The results of the Wildland Integrity model display a range of values arbitrarily set between 0 to 1000. A histogram was used to identify natural breaks in Wildland Integrity values. The best three classes, i.e. the highest values of Wildland Integrity, were chosen to represent areas outside of Wildland Conservation Areas that are important wildlands.

<sup>5</sup>Private and public land stewardship activities consistent with the maintenance of focal species populations should incorporate these wildlands.



#### 5.4 THREATENED WILDLANDS

Threatened wildlands are areas where existing or probable human activities will impact wildlands based on the assumptions of the threat component of the EMDS knowledge base model (Map 8). See the methods section for more information. Fragmentation of habitat from low-density, large-lot residential development hampers the existence of large intact wildlands in the westside foothills. In particular, the western portions of Nevada and Placer counties have been largely subdivided in recent years, though overall human population density remains low. This area, along with Eldorado County and other foothill counties, is probably under the greatest threat from development and therefore should be one of the prime foci of near-term local planning and action.

---

##### **CASE STUDY: NEVADA AND PLACER COUNTIES**

As local land-use decisions by counties and cities can influence landscape fragmentation as well as conservation strategies, the rapidly developing western Nevada and Placer counties are an ideal place to focus in and contrast likely development with conservation needs. One way to do this is to overlay parcel boundaries on Wildland Conservation Areas and Linkages to identify areas where habitat linkages may be lost or where Wildland Conservation Areas are threatened with development. Results show habitat linkages from the American River canyon through western Placer County toward the Spenceville and Collins Lake areas are particularly threatened by the prevalence of parcel sizes less than 20 acres in size. Similarly, the creation of any protected wildlands areas within western Placer and Nevada counties would be economically challenging given the dominance of small parcel sizes throughout this area. There are several larger parcels that could alleviate this problem if conservation easements were pursued.

In addition, changes in land-use zoning from “low-density residential” to “agricultural” in these areas could also maintain a greater diversity of wildlife and habitat.



Map 8. Actual and potential habitat threat

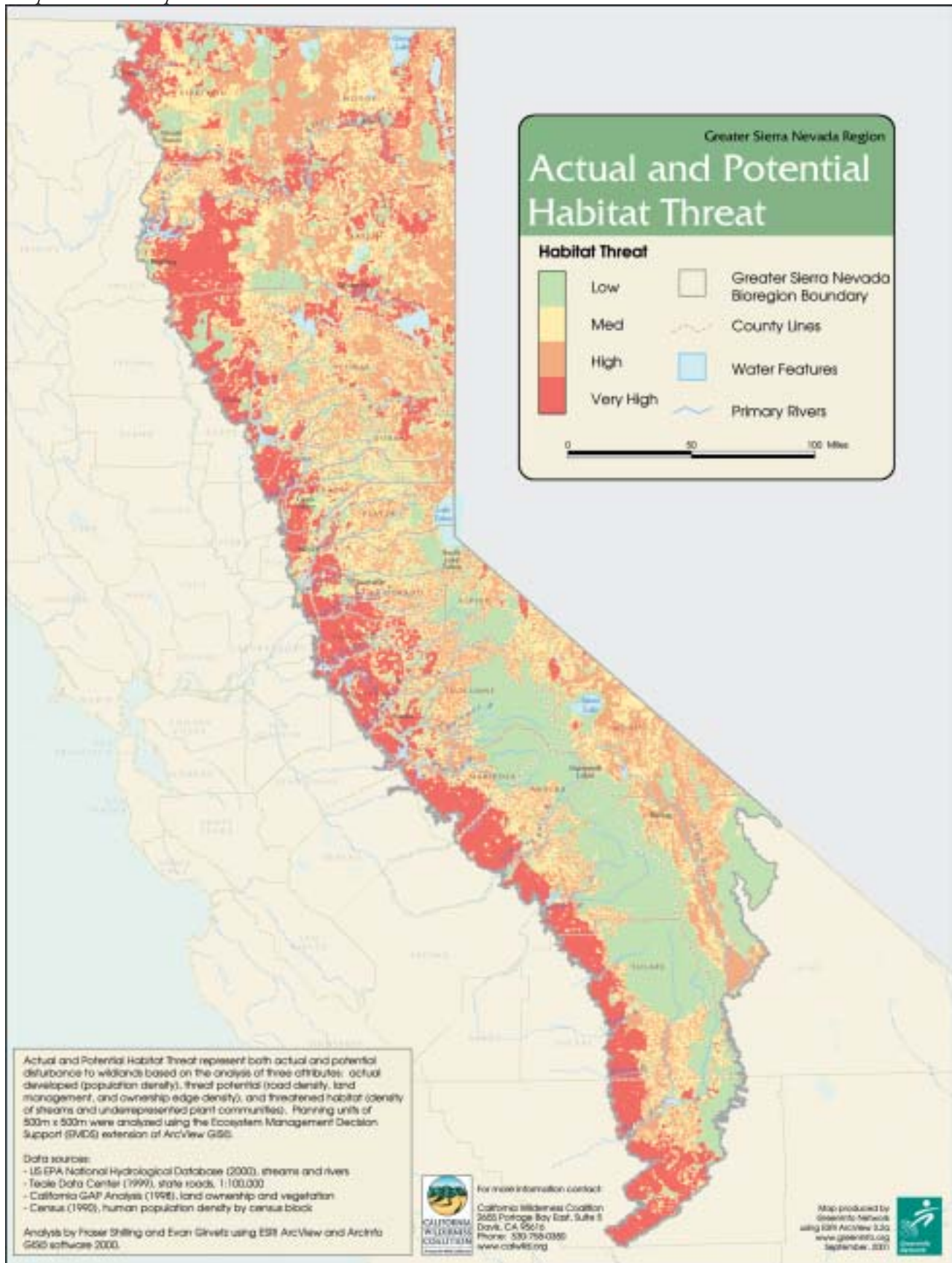

SIERRA NEVADA  
Wildland Conservation Plan

Map 9a. Wildland Conservation Plan (Sierra Nevada bioregion)

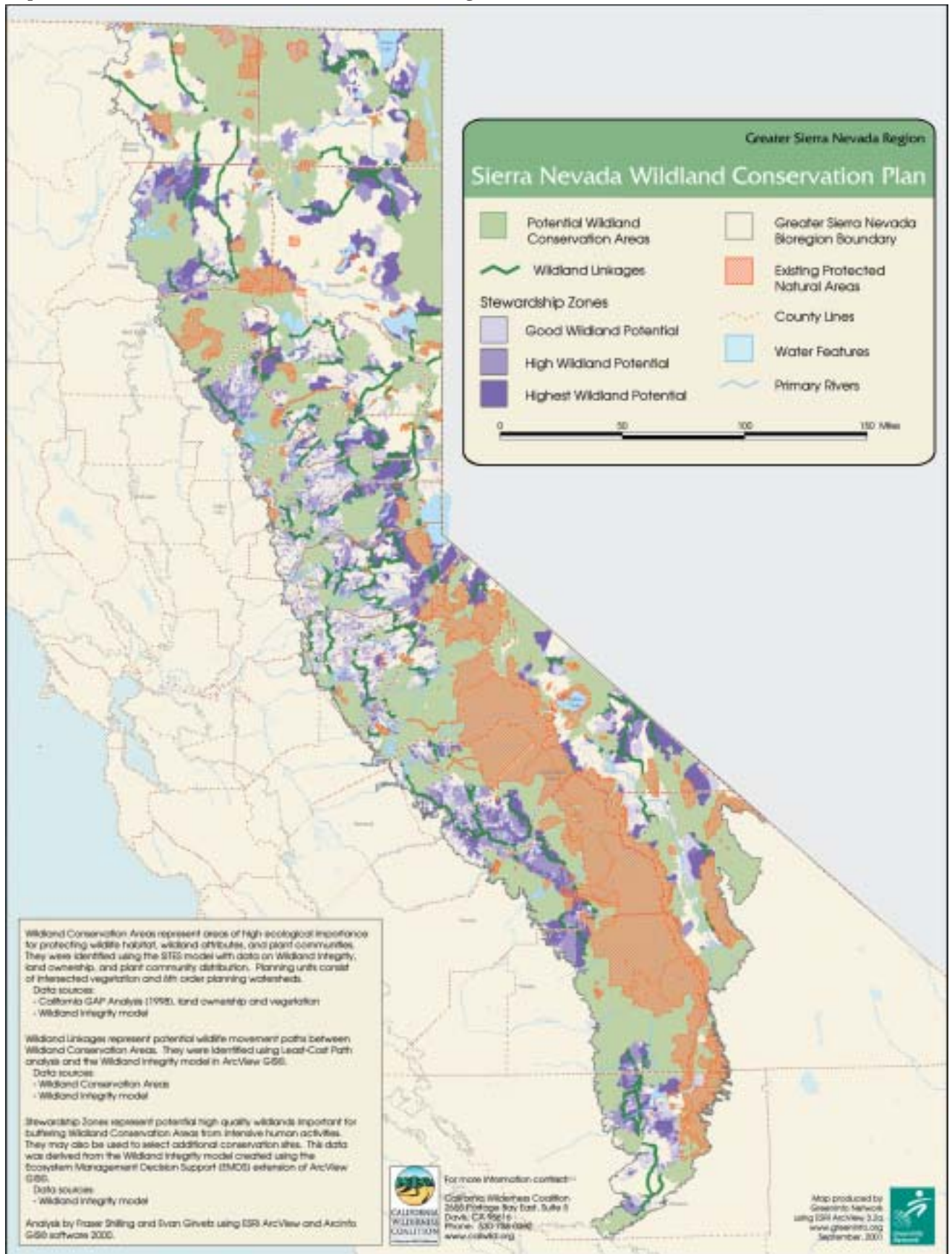



Map 9b. Wildland Conservation Plan (North half Sierra Nevada bioregion)

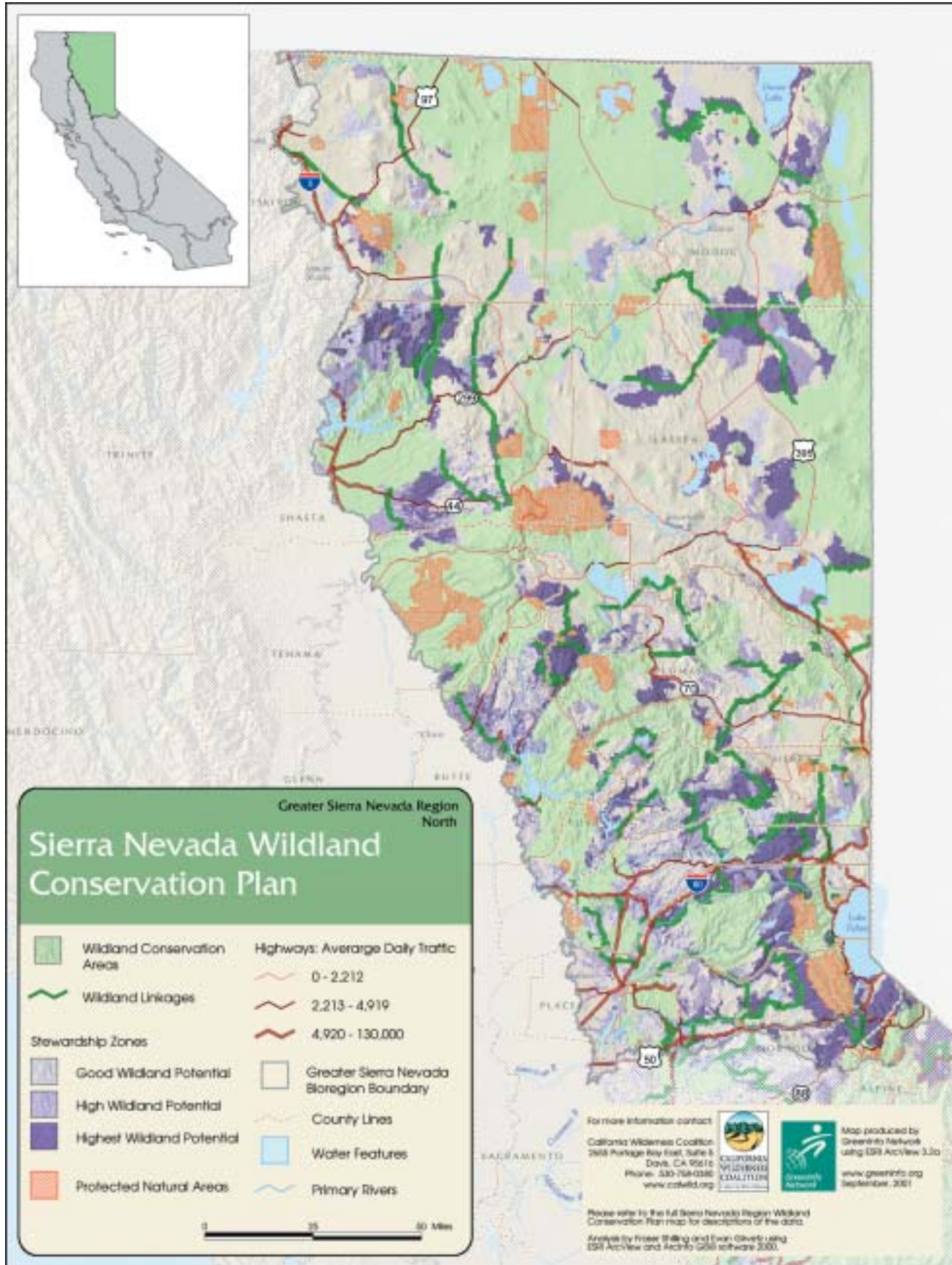



SIERRA NEVADA  
 Wildland Conservation Plan

Map 9c. Wildland Conservation Plan (South half Sierra Nevada bioregion)

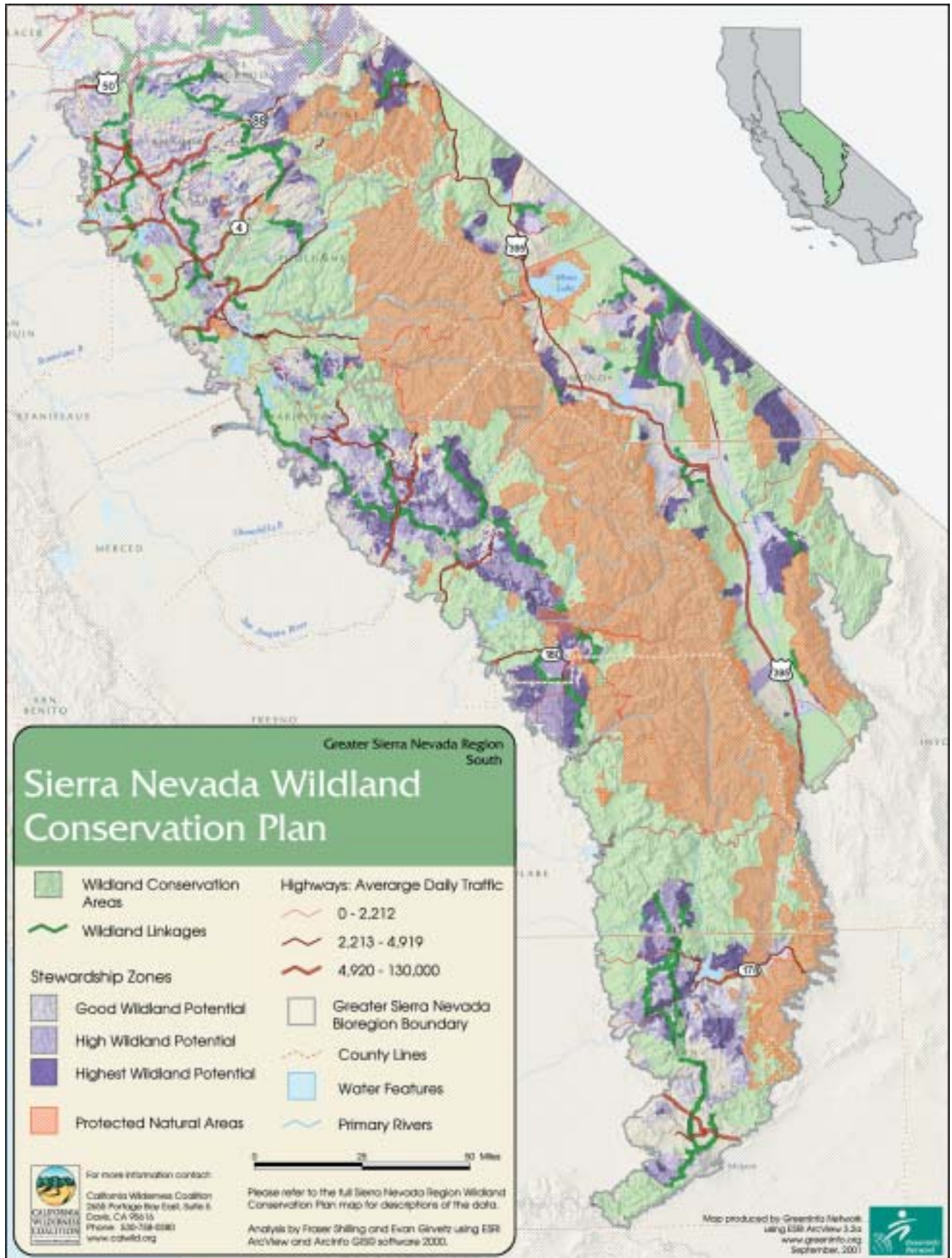

SECTION SIX

*Guidelines for Site  
Conservation Planning*

© Claus Sivert

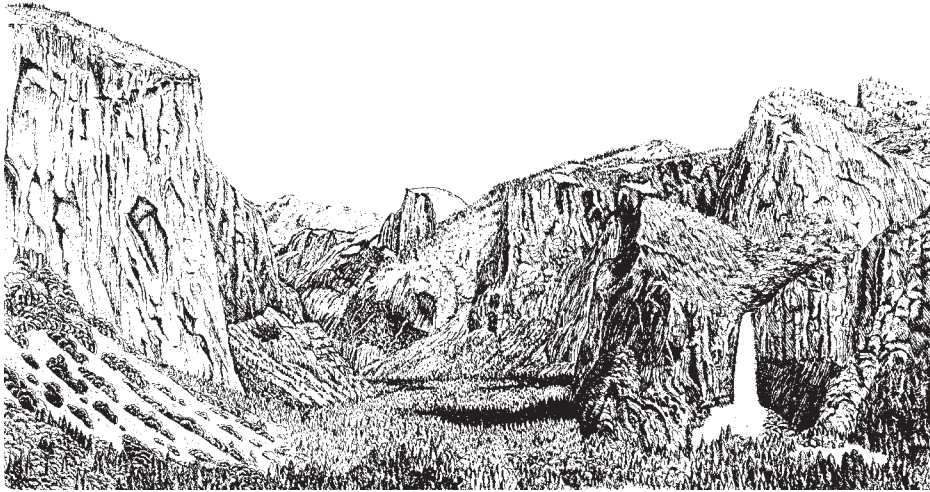



## *Section 6*

### *Guidelines for Site Conservation Planning*

#### 6.1 INTRODUCTION

The goal of site planning is to define an informed implementation strategy for the conservation of specific Wildland Conservation Areas, Wildland Linkages and Stewardship Zones. Specifically, site planning identifies a program for conservation action at the parcel level for a particular area and incorporates information and knowledge gathered from a larger planning team and stakeholders.

This section outlines a site planning process that can be applied throughout the regional planning area using the map results and conservation guidelines of the Wildlands Plan. The intention is to provide a 'How To' guide that the California Wilderness Coalition and other users of this Plan can apply locally.

#### 6.2 BACKGROUND

Organizations and agencies involved in habitat conservation have developed and refined sound approaches and tools for successful site planning (Poiani et al. 1998, The Nature Conservancy 2000). The basic components of site planning are straightforward:

1. Identifying conservation targets and goals,
2. Conducting a threat and opportunity analysis,
3. Conducting a stakeholder analysis,
4. Developing a conservation strategy and actions,
5. Assessing the feasibility of success by identifying monitoring checkpoints, and
6. Revising the information and plan as needed.

This site planning process is scale-independent (Poiani et al. 1998) meaning that it can be applied at any scale, such as regional (Sierra Nevada), intermediate (hardwood ecosystem), or local scale (Sierra County).

There are numerous site planning models to follow, yet each share the basic process for assessing fine-scale information, threats or stresses, stakeholder involvement, and mapping of parcels in need of protection or stewardship. The end product of a good site plan is a locally informed and supported document with parcel-specific maps that describe, in sufficient detail and language, the process, strategy, action steps, and measurements of success. To elucidate the site planning process further, Poiani et al. (1998) propose key questions to help guide the planning team through the six-step process:

**A. Identify conservation targets and goals.**

1. Who should be included in the planning process and implementation of the plan?
2. What are significant conservation targets and long term goals for those targets?
3. What biotic and abiotic attributes maintain targets over time?

**B. Conduct a threat and opportunity analysis.**

4. What are basic characteristics of the human community at the site?
5. What current or potential activities interfere with the attainment of conservation targets and maintenance of ecological processes that sustain them?

**C. Conduct a stakeholder analysis.**

6. Who are the organized groups and influential individuals at the site (i.e. stakeholders), what impacts will the goals have on them, and how might they help or hinder us in achieving those goals.

**D. Develop a conservation strategy and actions.**

7. What can we do to prevent or mitigate threatening activities, and how do we influence important stakeholders?
8. What are the areas on the ground where we need to act?
9. What kind of actions are necessary to accomplish our goals, who will do them, how long will they take, and how much will they cost?

**E. Assess the feasibility of success by identifying monitoring checkpoints.**

10. Can we reach our goals, based on assessment of both ecological and human concerns and programmatic results?
11. How will we know if we are making progress toward our goals and if our actions are bringing about desired results?

**F. Revise the information and plan as needed.**

12. Are there new and available information or data that can improve or otherwise affect the site plan?
13. How can new data be incorporated and how will it affect the goals, strategy, actions, and stakeholder support?

Due to the great uncertainty and complexity inherent in understanding ecological systems and wildlife populations, the process should be seen as an experimental design for adaptive management. The site planning process must be flexible to respond to new and improved planning techniques. Paiani et al. (1998) emphasize the importance of defining a comprehensive monitoring protocol and benchmarks to incrementally measure the success of the plan's strategy and actions.



Site planning requires a great deal of site-level research, as well as development and coordination of stakeholders. It is a labor-intensive process demanding resources from staff and organizations. Regional prioritization to identify priority sites based on highest of threats and opportunities should be addressed first. Priority-setting at the sub-regional scale, as in this plan, helps determine where to conduct site planning by providing a broad strategy.

### 6.3 THE SITE PLANNING PROCESS

Prior to site planning, two major steps are undertaken: identification of wildlands and wildland linkages, and regional threats and opportunities analysis. It should then be easy to determine the sequence of site planning events regionally. Sites with highest priority are addressed first.

Each of the following steps of the site planning process can have a geographic aspect, even the stakeholder analysis and monitoring for success. Of most importance geographically is the identification of the strategy that will, in most cases, identify land parcels and other pertinent data necessary for carrying out the conservation actions.

#### 6.3.1 IDENTIFY CONSERVATION TARGETS AND GOALS

- **Who should be included in the planning process and implementation of the plan?**

Successful site planning will best be achieved by an interdisciplinary team including, but not limited to scientists (i.e. wildlife biologists), planners (county, transportation), and implementers (wildlife agencies, NGOs, local governments). This is the first round of building a stakeholder group. The first task of this group will be to interpret the results of the Wildlands Plan for a particular site, identify key sites, conservation targets, and goals. Understanding this task up-front will help guide the assembly of the initial planning team.

- **What are significant conservation targets and long term goals for those targets?**

Recognized as one of the most important articulations of the site plan, the definition of conservation targets and goals sets the stage for the plan and should therefore be stated clearly. It is equally important for the planning team to articulate a long-term vision for the site.

Choosing a site planning area based on the regional priority analysis or other means will identify a limited number of Wildlands Areas and Wildland Linkages to address. Each Wildland Area or Wildland Linkage is considered a site. For each site, a list of conservation targets and goals will be articulated. Doing so in tabular form is helpful (See example).

*Example:*

CONSERVATION TARGET	CONSERVATION GOALS
Acorn woodpecker	Maintain viable population composed of >4 breeding pairs, >4 granary trees, and at least three species of native oak trees.
Grassland	<p>Conserve 100% of all native patches of grasslands &gt;20 acres and adjacent patches of non-native grasslands &gt;20 acres.</p> <p>Restore native grassland adjacent to patches of native grasslands &gt;20 acres.</p>

*6.3.2 Conduct a threat and opportunity analysis*

- **What are basic characteristics of human community at the site?**
- **What current or potential activities interfere with the survival of conservation targets and maintenance of ecological processes that sustain them?**

Once the conservation sites, their respective target elements and goals have been clearly identified, the next step is to assess the threats and opportunities at each site. Researching the demographics and political landscape with the planning team will identify stresses or opportunities for achieving the site plan goals. Examples of a stress are small parcel subdivision and clear-cut forestry. Opportunities may be in the form of a county sponsored open-space initiative, smart-growth strategy, willing sellers, or funding. Again, laying this information out in a table is extremely important in quantifying the severity of stresses and opportunities at each site and for documenting the planning process.

*6.3.3 Conduct a stakeholder analysis*

- **Who are the organized groups and influential individuals at the site (i.e. stakeholders), what impacts will the goal(s) have on them, and how might they help or hinder us in achieving those goal(s).**

At this point, the planning team has a strong sense of what the vision is and of the major obstacles that stand in the way. It is up to the planning team to identify every likely player that can influence the plan for better or for worse. A stakeholder is an organization or individual that either will be affected by the goals of the planning effort or can affect the outcome of the plan itself. Stakeholders will have a real affect on the plan based on their area of interest and can therefore be linked to specific goals. Examples of stakeholders are local governments, private landowners supportive of wildlife and wildland preservation, land trusts, historical societies, citizen groups, and public agencies. In addition, stakeholders can be identified as the source or potential solution to the previously identified threats.

Organizing this information in a table form will easily identify those stakeholders that affect one or more threats. Begin the with highest rated threat first.

#### 6.3.4 Develop a conservation strategy and actions

- What can we do to prevent or mitigate threatening activities, and how to influence important stakeholders?
- What are the areas on the ground where we need to act?
- What kind of actions are necessary to accomplish our goals, who will do them, how long will they take, and how much will they cost?

#### 6.3.5 Strategies

Conservation strategies set individual goals to reduce identified threats to the conservation targets. Actions define explicit on-the-ground steps necessary to accomplish the strategy. Together, this component of the site plan is one of the most important for the planning team to develop.

First, the planning team should review the high-priority threats and develop a list of potential strategies that abate them. Defining sound and explicit language for strategies will only be possible once the team has conducted thorough research on the political, economic, and cultural context of the planning area in which the sites are found.

A conservation strategy may consists of one or more broad approaches:

- Habitat protection (i.e. acquisition, easement, new management status)
- Adaptive management (i.e. on-going public policy, private land stewardship)
- Development alternatives (i.e. smart growth, sustainable timber harvests)
- Community relations (i.e. education, partnerships)
- Programmatic (i.e. fundraising, staff)
- Research (i.e. threat abatement, effects of threats, wildlife, restoration)

*Example:*

CONSERVATION GOAL	STRATEGIES
1. Maintain viable population of acorn woodpecker composed of >4 breeding pairs, >4 granary trees, and at least three species of native oak trees.	a. Secure a local development ordinance to limit subdivision and road projects in open space and agricultural areas. b. Seek easements of willing sellers to protect habitat on large parcels. c. Work to implement oak conservation practices on private lands.
2. Restore fire regimes to near historic cycle of low-intensity fires at 20-25 year intervals.	a. Determine character and impact of natural fire cycle prior to fire suppression. b. Work with county, state, and federal authorities to reintroduce fire to the site.

**6.3.6 Conservation Zones**

The next part of the conservation strategy is to identify the site conservation zones, a geographic area that strategies address. One site may consist of multiple zones, depending on the number of goals and strategies defined for it. Generally, this results in maps that identify current ownership by parcel, management, sources and sites of stresses, sites for protection, sites for management, sites for restoration, sites for mitigation, sites for education, etc.

**6.3.7 Actions**

Actions are the steps necessary to implement each strategy. Each strategy should be addressed by a list of actions that define programmatic issues.

*Example:*

STRATEGIES	ACTIONS
Improve habitat condition along wildlife migration route between protected wildlands to facilitate mule deer and mountain lion passage.	1. Determine potential habitat restoration sites. 2. Identify road and highway mitigation sites. 3. Contract restoration consultant to restore habitat to desired conditions. 4. Monitor wildlife movement along corridor. 5. Have wildlife crossings constructed across roads where necessary.

**6.3.8 Assess success by identifying monitoring checkpoints**

- **Can we succeed in our goals, based on assessment of both ecological and human concerns and programmatic results?**
- **How will we know if we are making progress toward our goals?**

A feasibility assessment should be conducted to define an expected level of success for achieving the goals. The purpose of the feasibility analysis is to identify flaws in assumptions of goals, strategies, programmatic issues such as funding, as well as risks to stakeholders.

Poiani et al. (1998) recommend setting short- and long-term benchmarks for success. Benchmarks should be tailored for each strategy, such as monitoring siltation loads of a river to support aquatic species restoration. Measurements of success can include the use of indicators, either species or habitat use (habitation or migration). Finally, the what, how, when, where, and who of monitoring should be clearly defined by the planning team, as well as who will pay for it.

### *6.3.9 Revise the information and plan as needed*

- **Are there new and available information or data that can improve or otherwise affect the site plan?**
- **How can new data be incorporated and how will they affect the goals, strategy, actions, and stakeholder support?**

As new information and data are developed that could considerably improve the site plan, the team or coordinating group should strongly reconsider redoing the site plan. New information will likely cause a change many aspects of the plan, so the cost vs. benefit should be considered judiciously.



SECTION SEVEN

*Conservation and  
Management Guidelines*



© Claus Sivert

BIGHORN SHEEP • OVIS CANADENSIS





## Section 7

### *Conservation and Management Guidelines*

#### 7.1 OVERVIEW

This section provides the California Wilderness Coalition (CWC) and other conservation practitioners, planners, and land managers guidelines for implementing the findings of the Sierra Nevada Wildlands Plan. The guidelines are intended for local wildlands planning. More site-specific guidelines along with measurable indicators of success will be identified through the site planning process.

Conservation and management guidelines are presented for each Wildland Conservation Area and Wildland Linkage.

- **Conservation guidelines** are recommended, non-management actions that initiate specific protection, mitigation, or policy activities in support of the wildlands and focal species.
- **Management guidelines** are science-supported management actions that help maintain and/or restore conservation targets such as focal species, road density, linkages, or plant communities.

#### **About the management guidelines:**

The management guidelines are intended to promote the conservation of project focal species and landscape characteristics important to healthy wildlands (i.e. low road density, smart growth planning). Focal species guidelines are a result of a preliminary literature review and do not represent the full spectrum of appropriate guidelines at this point. While the current list of focal species management guidelines are supported by field studies, it is unlikely that they alone present a complete picture for adaptive management of Wildland Conservation Areas, Wildland Linkages, and Stewardship Zones in the Sierra Nevada. Without consulting forest and aquatic biologists and other experts, it is unreasonable to specify which of these guidelines apply to specific Wildland Conservation Areas and Wildland Linkages. In the future, the CWC will work with biologists and land managers to articulate further management guidelines for specific wildlands. To minimize redundancy, focal species management guidelines are listed for each of the ten focal species in Section 7.7, which is referenced throughout the document.

Although these guidelines currently focus primarily on focal species, it is believed other conservation targets, such as habitat integrity, will benefit as well.

To improve the focus of planning within a 29-million acre planning area, guidelines are presented separately for our four subregional study areas: Cascade and Modoc, north Sierra, south Sierra, and east Sierra (See Map 10).

SIERRA NEVADA  
*Wildland Conservation Plan*

---

*Map 10. Study areas*



## 7.2 GREATER SIERRA NEVADA REGIONAL GUIDELINES

### *7.2.1 Description of wildlands in the Sierra Nevada bioregion*

#### **General area and ownership information**

The Sierra Nevada bioregion is approximately 29 million acres with 52% (15 million acres) identified as Wildland Conservation Areas and areas already protected. The bioregion is 70% publicly owned, mostly by US Forest Service, Bureau of Land Management, and US National Park Service. Privately owned lands account for the majority of westside foothill habitats.

There are numerous large protected areas (>10,000 acres) that are scattered in the northern half of the bioregion and also clustered in the south half of the bioregion at all elevations. The bioregional planning area contains all or part of 23 counties.

#### **Wildlands composition and status**

There are excellent opportunities for establishing large protected wildlands within the Sierra Nevada bioregion. There are 45 Wildland Conservation Areas that were identified within the Sierra Nevada bioregion. There are 49 Wildland Linkages that were identified through the analysis completed for this project, in addition to the 43 linkages identified at the Missing Linkages conference (Penrod et al. 2001).

Results of a recent large carnivore restoration feasibility study (Carroll et al. 2000) identified a large portion of the bioregion as highly suitable for gray wolf and wolverine restoration. The highest quality of habitat for gray wolf restoration occurs primarily in the Cascade and Modoc study area, while the area within the Sierra Nevada bioregion that best suits wolverine restoration is in the central and southern Sierra (Carroll et al. 2000).

#### **Fragmentation**

Habitat fragmentation is significant throughout the bioregion. A majority of forest and woodland habitat in the region is moderately to highly fragmented by roads, clearcuts, checkerboard management, and natural outcrops. Road density in the bioregion is highest on US Forest Service lands and developed westside foothill communities. The greatest road impact regionwide is likely to be siltation runoff to nearby aquatic habitats from logging roads.

Eastside habitats administered by the Bureau of Land Management are low to moderately fragmented, mostly by unpaved roads that receive high ORV recreation activity.

### *7.2.2 Conservation and management guidelines for the greater Sierra Nevada bioregion*

#### **Conservation guidelines**

- *Assist in development of wilderness policy*

Participate in public land management policy reform and support new wilderness designations for wildlands on public lands. Work with federal and state land managers to ensure protection of roadless areas on public lands.

- *Refine boundaries of Wildland Conservation Areas*

Consult with biologists and land managers with knowledge of regional flora, fauna, wildfire, hydrology, and different scales of biodiversity to gain a local perspective regarding the scope of the wildland conservation areas within a particular area.

- *Conduct regional prioritization for conservation activities*

Develop a bioregional implementation strategy that will identify a more complete set of criteria that combines current bioregional knowledge with that provided by local stakeholders. Start with Existing and Potential Threat analysis (See Methods).

Work with counties to ensure protection of critical wildlands, wildlife populations, and movement corridors via agricultural and open space zoning in General Plan development. Support smart growth zoning for expanding communities, including: minimum parcel size and wildlife friendly ordinances (See Sierra Business Council 1999).

- *Conduct site conservation planning*

Identify and prioritize threatened areas within the bioregion that would most benefit from site conservation planning efforts and work with local land trusts, governments and conservation organizations to seek easements or acquire threatened land in Wildland Conservation Areas and Wildland Linkages. Pursue effective economic incentives for private property owners to maintain and preserve habitat.

- *Species restoration*

Support efforts to restore gray wolf, wolverine and pacific fisher populations in areas within the Sierra Nevada bioregion in regions where they were historically present.

#### **Management guidelines**

- *Maintain and/or restore viable populations of focal species*

Apply focal species guidelines where appropriate in Wildland Conservation Areas, Wildland Linkages, and Stewardship Zones (See Section 7.7). Minimize the loss and fragmentation of existing contiguous forest and woodlands and restore historic pattern and intensity of wildfires.

- *Minimize the impacts of roads and associated activities*

Minimize the number of new road construction and encourage expansion of existing road infrastructure to accommodate higher traffic volume. Minimize road density levels on public lands by evaluating roads for decommissioning and reduce harmful effects or ORV use through rule enforcement, route designation, and area closures (Shore 2001). Ensure that wildlife and other environmental mitigation is part of plan, especially relating to focal species connectivity and migratory needs.

### 7.3 GUIDELINES FOR CASCADE AND MODOC STUDY AREA

*Map 11. Cascade and Modoc study area*

*(Note: Numbers are related to specific Wildland Conservation Areas (Site number) and letters refer to linkages within the subregion [see Table 7.3.4]).*

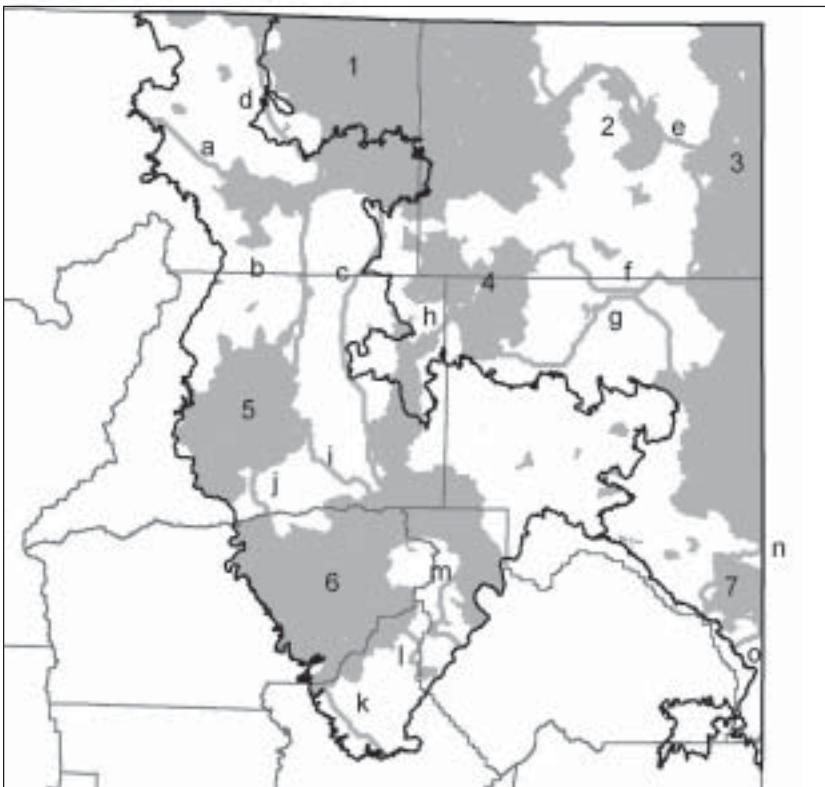

### *7.3.1 Description of wildlands in the Cascade and Modoc study area*

#### **General area and ownership information**

The Cascade-Modoc study area is 50% publicly owned, mostly by National Forests.

There are seven large protected areas (>10,000 acres) that are widely separated, yet are well connected by multiple-use National Forest and Bureau of Land Management lands.

The study area contains all or part of seven counties, including eastern half of Siskiyou, all of Modoc and Lassen, the majority of Shasta, and parts of Tehama, Butte, and Plumas Counties.

#### **Wildlands composition**

There are excellent opportunities for establishing large protected wildlands in the Cascade and Modoc study area study area. It is approximately 11 million acres with 44% (5 million acres) identified as suitable for Wildland Conservation Areas. There are seven Wildland Conservation Areas and 14 Wildland Linkages that have been identified in the study area. The Missing Linkages conference (Penrod et al. 2001) identified an additional 13 linkages in the study area.

Results of a recent large carnivore restoration feasibility study (Carroll et al. 2001) identifies a large portion of the study area as highly suitable for gray wolf and wolverine restoration.

#### **Fragmentation**

Fragmentation is significant in several areas. Road density in the study area is characterized as low to moderate, having an average road density of 1.7 km/km<sup>2</sup>, which includes both paved and non-paved roads.

However, some of the fragmentation is topographic in nature. In Lassen National Forest, northeast of Lassen Volcanic National Park habitat between lava outcrops of Sugarloaf Peak to Grasshopper Valley. This area is naturally fragmented by lava outcrops, but also has a moderate density (2-3 km/km<sup>2</sup>) of Forest Service roads.

In addition, north of the Pit River in north central Shasta County, lands owned privately and managed by the Shasta National Forest is fairly fragmented, having an average road density of 2 km/km<sup>2</sup>.

### *7.3.2 Conservation and management guidelines for Cascade and Modoc study area*

#### **Conservation guidelines**

- Prioritize protection in threatened areas first.
- Seek conservation easements or purchase of threatened land in Wildland Conservation Areas and Wildland Linkages.
- Support efforts to restore gray wolf and wolverine populations.
- Support efforts to restore Pacific fisher populations to available habitat in Lassen National Forest.
- Mitigate harmful impacts of roads to wildlife.



**Management guidelines**

- Minimize road density levels on public lands by evaluating roads for decommissioning.
- Practice sustainable resource use.
- Monitor wildlife movement to identify functioning landscape linkages.
- Monitor populations of focal species.
- Eliminate cross-country ORV use through the establishment of a route network.

**7.3.3 Wildland Conservation Areas****SITE 1**

---

**Name:** Klamath Wildland Conservation Area

**Size:** 1.5 million acres

**Dominant land owner(s):** Klamath and Modoc National Forests, Lava Beds National Monument, private

**Protected areas:** Lava Beds Wilderness Area, Lava Beds National Monument, Tule Lake National Wildlife Refuge, Lower Klamath National Wildlife Refuge, Clear Lake National Wildlife Refuge, Mount Shasta Wilderness Area

**Dominant vegetation:** juniper, eastside pine, sagebrush, perennial grasslands

**Conservation guidelines**

- Seek wilderness designation for roadless areas on USFS lands.
- Seek conservation easements or purchase of threatened land.
- Support efforts to restore gray wolf and wolverine populations.
- Participate in public land management policies of general forest and protected areas.
- Mitigate environmental impacts of roads and Highways 139 and 97.

**Management guidelines**

- Manage for viable populations for marten, California spotted owl, wolverine, pronghorn, sage grouse, and gray wolf (See Section 7.7).
- Monitor wildlife movement across Highways 139 and 97 to identify conflict areas.
- Complete ORV route designations for all public land.

**SITE 2**

---

**Name:** Alturas Wildland Conservation Area

**Size:** 85,000 acres

**Dominant land owner(s):** Modoc National Forest, some private

**Protected areas:** None

**Dominant vegetation:** juniper, sagebrush

**Conservation guidelines**

- Seek wilderness designation for roadless areas on USFS lands.
- Seek conservation easements or purchase of threatened land.
- Support efforts to restore gray wolf populations.
- Participate in public land management policies of general forest and protected areas.

**Management guidelines**

- Manage for viable populations of sage grouse, pronghorn, and gray wolf (See Section 7.7).
- Maintain forest integrity by limiting new road development and unsustainable resource use.
- Complete ORV route designations for all public land.
- Participate in public land management policies of general forest and protected areas.

**SITE 3**

---

**Name:** Lahontan Wildland Conservation Area

**Size:** 1 million acres

**Dominant land owner(s):** Modoc National Forest, Bureau of Land Management

**Protected areas:** South Warner Wilderness Area

**Dominant vegetation:** juniper, sagebrush

**Conservation guidelines**

- Seek wilderness designation for roadless areas on USFS lands.
- Support efforts to restore gray wolf and wolverine populations.
- Participate in public land management policies of general forest and protected areas.

**Management guidelines**

- Manage for viable populations of marten, wolverine, bighorn sheep, pronghorn, sage grouse, and gray wolf (See Section 7.7).
- Monitor wildlife movement across trafficked roads to identify conflict areas.
- Complete ORV route designations for all public land.

**SITE 4**

---

**Name:** Pit River Wildland Conservation Area

**Size:** 340,000 acres

**Dominant land owner(s):** Private, California State Parks, California Fish & Game, Modoc National Forest

**Protected areas:** Ash Creek Wildlife Area, Ahjumawi Lava Springs State Park

**Dominant vegetation:** juniper, sagebrush, Sierra mixed-conifer, montane-hardwood conifer, low sage

**Conservation guidelines**

- Seek conservation easements on private lands.
- Support efforts to restore gray wolf and wolverine populations.
- Monitor wildlife movement across Highway 299 to identify conflict areas.
- Participate in public land management policies of general forest and protected areas.

**Management guidelines**

- Manage for viable populations of marten, wolverine, pronghorn, sage grouse, and gray wolf (See Section 7.7).
- Monitor wildlife movement across Highway 299 to identify conflict areas.

**SITE 5**

---

**Name:** Whitmore River Wildland Conservation Area

**Size:** 450,000 acres

**Dominant land owner(s):** Private, Shasta National Forest

**Protected areas:** Hoffmeister Research Natural Area

**Dominant vegetation:** Blue oak - Foothill pine, Sierra mixed-conifer

**Conservation guidelines**

- Seek conservation easements on private lands.
- Manage for viable populations of wolverine, pronghorn, California spotted owl, Pacific fisher, and gray wolf (See Section 7.7).
- Support efforts to restore gray wolf and wolverine populations.
- Monitor wildlife movement across Highways 299, 5, and 44 to identify conflict areas.
- Support efforts to restore Pacific fisher population.

**Management guidelines**

- Manage for viable populations of wolverine, pronghorn, California spotted owl, Pacific fisher, and gray wolf (See Section 7.7).
- Monitor wildlife movement across Highways 299, 5, and 44 to identify conflict areas.

**SITE 6**

---

**Name:** Lassen Link Wildland Conservation Area

**Size:** 1.2 million acres

**Dominant land owner(s):** Lassen National Forest, Lassen Volcanic National Park

**Protected areas:** Lassen Volcanic National Park, California Fish & Game Tehama Wildlife Area, The Nature Conservancy Gray Davis-Dye Creek Preserve, Ishi Wilderness Area, Lassen Wilderness Area Caribou Wilderness Area

**Dominant vegetation:** Blue oak - Foothill pine, Blue oak woodland, Sierra mixed-conifer

**Conservation guidelines**

- Seek wilderness designation for roadless areas on USFS lands.
- Manage for viable populations of marten, wolverine, Pacific fisher, pronghorn, California spotted owl, and gray wolf (See Section 7.7).
- Support efforts to restore gray wolf and wolverine populations.
- Monitor wildlife movement across Highways 299, 89, 36, and 32 to identify conflict areas.
- Support efforts to restore Pacific fisher population.
- Participate in public land management policies of general forest and protected areas.

**Management guidelines**

- Manage for viable populations of marten, wolverine, Pacific fisher, pronghorn, California spotted owl, and gray wolf (See Section 7.7).
- Monitor wildlife movement across Highways 299, 89, 36, and 32 to identify conflict areas.

**SITE 7**

---

**Name:** Skedaddle Mountains Wildland Conservation Area

**Size:** 95,000 acres

**Dominant land owner(s):** Private

**Protected areas:** California Fish & Game Doyle Wildlife Area

**Dominant vegetation:** Sierra mixed-conifer

**Conservation guidelines**

- Seek conservation easements on private lands.
- Manage for viable populations of marten, pronghorn, wolf, wolverine, and California spotted owl (See Section 7.7).
- Support efforts to restore gray wolf and wolverine populations.
- Complete ORV route designations for all public land.
- Participate in public land management policies of general forest and protected areas.

**Management guidelines**

- Manage for viable populations of marten, pronghorn, wolf, wolverine, and California spotted owl (See Section 7.7).
- Complete ORV route designations for all public land

## 7.3.4 Wildland Linkages

SITE	FUNCTION	COMMENTS AND GUIDELINES
a	links Site 1 to wildlands in Klamath National Forest, follows Shasta River.	Mostly private lands. Crosses Highway 97. Manage for gray wolf and wolverine dispersal (See Section 7.7).
b	links Site 1 to Site 5.	Mostly Shasta National Forest, some private. Crosses Highway 89. Manage for gray wolf and wolverine dispersal (See section E).
c	links Site 1 to Lassen Volcanic National Park and adjacent wilderness areas in Site 6.	Mostly private, some Shasta National Forest. Crosses Pit River and Highway 89. Manager for Pacific fisher, marten, California spotted owl, wolverine, and gray wolf habitat connectivity (See Section 7.7).
d	links wildlands in Oregon to south end of Site 1. Landscape linkage (Penrod et al. 2001).	Mostly Klamath National Forest, some private. Crosses Highway 97. Manage for gray wolf and wolverine dispersal (See Section 7.7).
e	links Site 1 to Site 2 and Warner Mountain in Site 3.	Mostly Modoc National Forest, some private. Crosses Highway 395. Manage for sage grouse habitat connectivity, and pronghorn and gray wolf dispersal (See Section 7.7).
f, g	link Site 3 to Site 4, connecting sage brush habitats to Juniper and Sierra mixed conifer.	Very patchy mix of private and Modoc National Forest. Crosses Highways 139 and 395. Manage for habitat connectivity for sage grouse and marten and dispersal needs of wolverine, gray wolf, and pronghorn (See Section 7.7).
h	links Ahjumawi Lava Springs State Park in Site 4 to Lassen National Forest in Site 6.	Private. Crossed Pit River and Highway 295. Manage for pronghorn, gray wolf, and wolverine dispersal (See Section 7.7).
i, j	links Site 5 to Site 6. Landscape linkage (Penrod et al. 2001).	All private. Crosses Highway 44. Manage forest connectivity for California spotted owl and Pacific fisher. Maintain wintering habitat for Pronghorn and mule deer. Manage for wolverine and gray wolf dispersal (See Section 7.7).
K	links Site 6 to Site 14 in oak woodland belt.	All private. Crosses Highways 191, 70, and 32. Manage for habitat connectivity for California spotted owl and acorn woodpecker. Maintain mule deer wintering habitat and dispersal capability (See Section 7.7).
l, m	link Site 6 to Site 11 in Sierra mixed-conifer belt. Landscape linkage, choke-point (Penrod et al. 2001).	Lassen and Plumas National Forests and private timber firms. Crosses Highways 36, 70, and 89. Manage for restoration of Pacific fisher, and California spotted owl habitat connectivity.
n, o	link BLM land in Site 3 through private lands in Site 7 to Plumas Nation Forest in Site 9.	Private and BLM land. Crosses Highway 395. Manage for sage grouse habitat connectivity and dispersal of mule deer.

7.4 Guidelines for the North Sierra Study area

Map 12. North Sierra study area

(Note: Numbers are related to specific Wildland Conservation Areas (Site number) and letters refer to linkages within the subregion [see Table 7.4.4]).

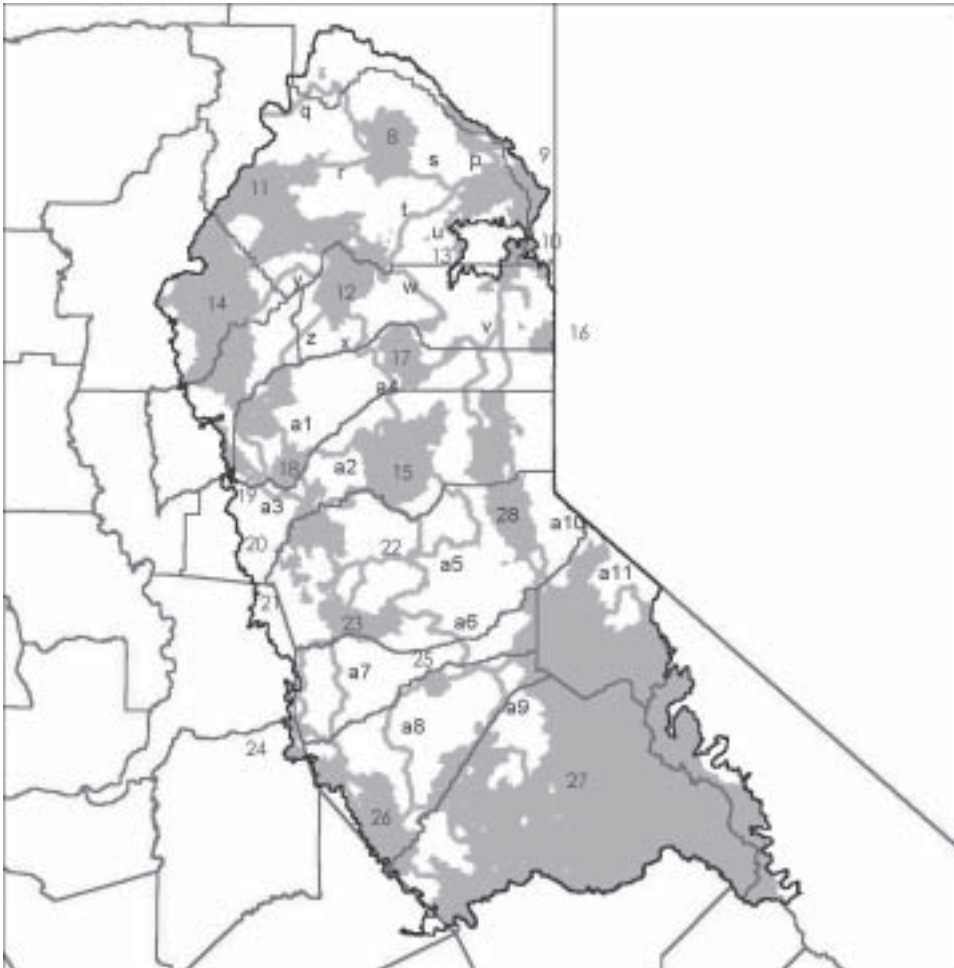

### *7.4.1 Description of Wildlands for North Sierra Study Area*

#### **General area and ownership information**

The North Sierra study area is 60% privately owned and 40% publicly owned, mostly by the U.S. Forest Service, Bureau of Land Management, and US National Park Service. There are seven large protected areas (>10,000 acres) restricted to higher elevations along the Sierra Crest, with the exception of the Feather River Wild & Scenic Area linking low to middle elevation mixed-conifer forests. The North Sierra study area contains all or part of thirteen counties, including all of Plumas, Nevada, El Dorado, Amador, Calaveras, Tuolumne, Alpine, and Sierra, as well as portions of Lassen, Butte, Yuba, Placer, and Sacramento Counties.

#### **Wildlands composition and status**

The North Sierra study area is approximately 8 million acres with 44% (4 million acres) identified as Wildland Conservation Areas. Establishing large protected wildlands in the study area is challenging due to widespread fragmentation, checkerboard land ownership, and surging development in privately owned oak woodlands.

There are 21 Wildland Conservation areas and 21 Wildland Linkages in the Study area. In addition, the Missing Linkages conference (Penrod et al. 2001) identified 15 additional linkages in the study area. Results of a recent habitat suitability study for the California spotted owl (Carroll 1999) identified a large portion of the study area as highly suitable for this declining forest specialist.

#### **Fragmentation**

Fragmentation is significant in several areas. Road density in the study area varies between major elevation belts due to differing land management and vegetation types.

The lower-elevation westside foothill belt has an average road density of 6km/km<sup>2</sup> (predominantly paved roads). The middle-elevation conifer belt has an average road density of 3.4 km/km<sup>2</sup> (mostly unpaved forest roads). The higher-elevation alpine, Sierra Crest belt has an average road density of 1.5 km/km<sup>2</sup> and the eastside Sierra belt of the study area has an average road density of 2 km/km<sup>2</sup>.

Checkerboard land ownership dominates areas of the middle-elevation mixed-conifer belt, especially in the Tahoe and Eldorado Nation Forests. Poor forestry practices have fragmented much of the Forest Service and private lands in the study area. Forest fragmentation is lowest along major river corridors, such as the Feather, north fork American, Tuolumne, and Cosumnes rivers. Forest fragmentation is high along the middle and south fork American, Rubicon, Stanislaus, and Mokelumne.

Recent forest fires in the Stanislaus National Forest have decimated prime habitat for Pacific fisher and California spotted owl. Central counties in the westside oak foothills are fragmented by sub-divided parcels and roads. Natural fragmentation in the form of granite rock outcrops is prevalent along the Sierra Crest, especially in eastern Tahoe National Forest.



*7.4.2 Conservation and Management Guidelines  
for the North Sierra Study Area*

**Conservation guidelines**

- Protect threatened areas first.
- Seek easement or purchase of threatened land in Wildland Conservation Areas and Wildland Linkages.
- Support efforts to restore gray wolf and wolverine populations.
- Support efforts to restore Pacific fisher populations in available habitat in Stanislaus, Eldorado, Tahoe, and Plumas National Forests, and private lands.
- Mitigate harmful impacts of roads to wildlife.

**Management guidelines**

- Minimize road density levels on public lands by evaluating roads for decommissioning.
- Practice sustainable resource management on public and private lands.
- Minimize impacts of roads to plants and wildlife.
- Monitor wildlife movement to identify functioning landscape linkages.
- Monitor populations of focal species.

*7.4.3 Wildland Conservation Areas*

**SITE 8**

---

**Name:** Genesee Wildland Conservation Area

**Size:** 125,000 acres

**Dominant land owner(s):** Plumas National Forest

**Protected areas:** None

**Dominant vegetation:** Sierra mixed-conifer

**Conservation guidelines**

- Seek wilderness designation for roadless areas on USFS lands.
- Participate in public land management policies of general forest and protected areas.

**Management guidelines**

- Manage for viable populations of marten, California spotted owl, wolverine, and gray wolf (See Section 7.7).

**SITE 9**

---

**Name:** Dixie Wildland Conservation Area

**Size:** 250,000 acres

**Dominant land owner(s):** Plumas National Forest

**Protected areas:** None

**Dominant vegetation:** Sierra mixed-conifer, sagebrush, Jeffrey pine, and Eastside pine

**Conservation guidelines**

- Seek wilderness designation for roadless areas on USFS lands.
- Participate in public land management policies of general forest and protected areas.
- Support efforts to restore gray wolf populations.

**Management guidelines**

- Manage for viable populations of marten, pronghorn, and gray wolf (See Section 7.7).
- Maintain forest integrity by limiting new road development and unsustainable resource use.

---

**SITE 10**

**Name:** Correco Wildland Conservation Area

**Size:** 60,000 acres

**Dominant land owner(s):** Tahoe National Forest, Bureau of Land Management, private

**Protected areas:** None

**Dominant vegetation:** Jeffrey pine, sagebrush

**Conservation guidelines**

- Seek wilderness designation for roadless areas on USFS lands.
- Support efforts to restore gray wolf and wolverine populations.
- Participate in public land management policies of general forest and protected areas.
- Seek conservation easements on private lands.

**Management guidelines**

- Manage for viable populations of marten, wolverine, mule deer and gray wolf (See Section 7.7).
- Monitor wildlife movement across trafficked roads to identify conflict areas.

---

**SITE 11**

**Name:** Feather Wildland Conservation Area

**Size:** 300,000 acres

**Dominant land owner(s):** Plumas National Forest

**Protected areas:** Bucks Lake Wilderness Area, Feather River National Wild & Scenic Area

**Dominant vegetation:** Sierra mixed-conifer, Ponderosa pine forest, Montane chaparral, Red fir

**Conservation guidelines**

- Seek wilderness designation for roadless areas on USFS lands.
- Participate in public land management policies of general forest and protected areas.
- Support efforts to restore Pacific fisher population.

**Management guidelines**

- Manage for viable populations of Pacific fisher, marten, and California spotted owl (See Section 7.7).

**SITE 12**

---

**Name:** Eureka Wildland Conservation Area

**Size:** 160,000 acres

**Dominant land owner(s):** Plumas and Tahoe National Forests

**Protected areas:** Plumas Eureka State Park

**Dominant vegetation:** Ponderosa pine forest, Red fir, Montane chaparral

**Conservation guidelines**

- Seek wilderness designation for roadless areas on USFS lands.
- Support efforts to restore Pacific fisher population.
- Participate in public land management policies of general forest and protected areas.

**Management guidelines**

- Manage for viable populations of Pacific fisher, marten, and California spotted owl (See Section 7.7).

**SITE 13**

---

**Name:** Folchi Meadows Wildland Conservation Area

**Size:** 20,000 acres

**Dominant land owner(s):** Tahoe National Forest, Bureau of Land Management, private

**Protected areas:** None

**Dominant vegetation:** Sierra mixed-conifer, Red fir, Ponderosa pine forest, White pine

**Conservation guidelines**

- Seek wilderness designation for roadless areas on USFS lands.
- Support efforts to restore gray wolf and wolverine populations.
- Seek conservation easements on private lands.
- Participate in public land management policies of general forest and protected areas.
- Support efforts to restore Pacific fisher population.

**Management guidelines**

- Manage for viable populations of marten, wolverine, and gray wolf (See Section 7.7).

**SITE 14**

---

**Name:** Ponderosa Wildland Conservation Area

**Size:** 350,000 acres

**Dominant land owner(s):** Plumas National Forest, California State Parks, Bureau of Land Management

**Protected areas:** California fish & Game Daugherty Wildlife Area

**Dominant vegetation:** Sierra mixed-conifer, Ponderosa pine, Blue oak pine, Montane hardwood

**Conservation guidelines**

- Seek wilderness designation for roadless areas on USFS lands.
- Participate in public land management policies of general forest and protected areas.
- Mitigate wildlife impacts of Highway 20.
- Support efforts to restore Pacific fisher population

**Management guidelines**

- Manage for viable populations of mule deer, acorn woodpecker, and California spotted owl (See Section 7.7).
- Monitor impacts of Highway 20 on wildlife and aquatic habitats.

**SITE 15**

---

**Name:** Sugar Pine Wildland Conservation Area

**Size:** 200,000 acres

**Dominant land owner(s):** Tahoe National Forest, private timber company

**Protected areas:** none.

**Dominant vegetation:** Sierra mixed-conifer, Ponderosa pine, Montane hardwood

**Conservation guidelines**

- Seek wilderness designation for roadless areas on USFS lands.
- Participate in public land management policies of general forest and protected areas.
- Seek conservation easements on private lands.
- Support efforts to restore Pacific fisher population.

**Management guidelines**

- Manage for viable populations of mule deer, acorn woodpecker, and California spotted owl (See Section 7.7).

**SITE 16**

---

**Name:** Mystic Wildland Conservation Area

**Size:** 15,000 acres

**Dominant land owner(s):** Tahoe and Toiyabe National Forests, private

**Protected areas:** none.

**Dominant vegetation:** Jeffrey pine, sagebrush

**Conservation guidelines**

- Seek wilderness designation for roadless areas on USFS lands.
- Participate in public land management policies of general forest and protected areas.
- Seek conservation easements on private lands.

**Management guidelines**

- Manage for viable populations of mule deer, sage grouse, pronghorn (See Section 7.7).

**SITE 17**

---

**Name:** Soda Springs Wildland Conservation Area

**Size:** 60,000 acres

**Dominant land owner(s):** Tahoe National Forests, private timber company

**Protected areas:** None

**Dominant vegetation:** Montane chaparral, Sierra mixed conifer, Red fir, Ponderosa pine

**Conservation guidelines**

- Seek wilderness designation for roadless areas on USFS lands.
- Participate in public land management policies of general forest and protected areas.
- Seek conservation easements on private lands.
- Support efforts to restore Pacific fisher population.

**Management guidelines**

- Manage for viable populations of marten, and California spotted owl (See Section 7.7).

**SITE 18**

---

**Name:** Wolf Creek Wildland Conservation Area

**Size:** 30,000 acres

**Dominant land owner(s):** Private

**Protected areas:** None

**Dominant vegetation:** Blue oak-pine, Ponderosa pine

**Conservation guidelines**

- Seek conservation easements on private lands.
- Mitigate wildlife impacts of Highway 49.

**Management guidelines**

- Manage for viable populations of mule deer, acorn woodpecker, and California spotted owl (See Section 7.7).
- Monitor impacts of Highway 49 on wildlife and aquatic habitats.

**SITE 19**

---

**Name:** Far West Wildland Conservation Area

**Size:** 20,000 acres

**Dominant land owner(s):** Private, California Fish & Game Spenceville Wildlife Area

**Protected areas:** None

**Dominant vegetation:** Blue oak-pine, Valley Oak Woodland

**Conservation guidelines**

- Seek conservation easements on private lands.

**Management guidelines**

- Manage for viable populations of mule deer, acorn woodpecker, and California spotted owl (See Section 7.7).

**SITE 20**

---

**Name:** Greenwood Wildland Conservation Area

**Size:** 125,000 acres

**Dominant land owner(s):** Private, Bureau of Land Management, Bureau of Reclamation

**Protected areas:** None

**Dominant vegetation:** Blue oak-pine, Montane hardwood, Ponderosa pine

**Conservation guidelines**

- Seek conservation easements on private lands.
- Mitigate wildlife impacts of Highways 49 and 193.

**Management guidelines**

- Manage for viable populations of mule deer, acorn woodpecker, and California spotted owl (See Section 7.7).
- Monitor impacts of Highways 49 and 193 on wildlife and aquatic habitats.

**SITE 21**

---

**Name:** Acorn Wildland Conservation Area

**Size:** 65,000 acres

**Dominant land owner(s):** Private, Bureau of Land Management

**Protected areas:** None

**Dominant vegetation:** Blue oak-pine, Montane hardwood

**Conservation guidelines**

- Seek conservation easements on private lands.

**Management guidelines**

- Manage for viable populations of mule deer, acorn woodpecker, and California spotted owl (See Section 7.7).

**SITE 22**

---

**Name:** Poho Wildland Conservation Area

**Size:** 12,000 acres

**Dominant land owner(s):** Eldorado National Forest

**Protected areas:** None

**Dominant vegetation:** Ponderosa pine, Montane hardwood

**Conservation guidelines**

- Seek wilderness designation for roadless areas on USFS lands.
- Participate in public land management policies of general forest and protected areas.
- Support efforts to restore Pacific fisher population.

**Management guidelines**

- Manage for viable populations of mule deer, Pacific fisher, and California spotted owl (See Section 7.7).

**SITE 23**

---

**Name:** Moco Creek Wildland Conservation Area

**Size:** 81,000 acres

**Dominant land owner(s):** Private, Bureau of Land Management

**Protected areas:** None

**Dominant vegetation:** Blue oak pine, Blue oak woodland

**Conservation guidelines**

- Seek conservation easements on private lands.
- Work with BLM to consolidate holdings consistent with maintaining populations of focal species and natural processes.
- Mitigate wildlife impacts of Highway 49.

**Management guidelines**

- Manage for viable populations of mule deer, acorn woodpecker, and California spotted owl (See Section 7.7).
- Monitor impacts of Highway 48 on wildlife and aquatic habitats.

**SITE 24**

---

**Name:** Mokelumne Wildland Conservation Area

**Size:** 65,000 acres

**Dominant land owner(s):** Private

**Protected areas:** None

**Dominant vegetation:** Blue oak woodland

**Conservation guidelines**

- Seek conservation easements on private lands.
- Work with BLM to consolidate holdings consistent with maintaining populations of focal species and natural processes.
- Mitigate wildlife impacts of Highways 88, 12, and 26.



**Management guidelines**

- Manage for viable populations of mule deer, acorn woodpecker, and California spotted owl (See Section 7.7).
- Monitor impacts of Highways 88, 12, and 26 on wildlife and aquatic habitats.

**SITE 25**

---

**Name:** Panther Creek Wildland Conservation Area

**Size:** 11,000 acres

**Dominant land owner(s):** Private, Bureau of Land Management

**Protected areas:** None

**Dominant vegetation:** Montane hardwood, Ponderosa pine

**Conservation guidelines**

- Seek conservation easements on private lands.
- Work with BLM to consolidate holdings consistent with maintaining populations of focal species and natural processes.
- Support efforts to restore Pacific fisher population.

**Management guidelines**

- Manage for viable populations of mule deer, acorn woodpecker, Pacific fisher, and California spotted owl (See Section 7.7).

**SITE 26**

---

**Name:** Wildcat Creek Wildland Conservation Area

**Size:** 13,000 acres

**Dominant land owner(s):** Private, Bureau of Land Management

**Protected areas:** None

**Dominant vegetation:** Blue oak pine, Blue oak woodland, Chamise-redshank chaparral

**Conservation guidelines**

- Seek conservation easements on private lands.
- Work with BLM to consolidate holdings consistent with maintaining populations of focal species and natural processes.

**Management guidelines**

- Manage for viable populations of mule deer, acorn woodpecker, and California spotted owl (See Section 7.7).

**SITE 27**

---

**Name:** Hetch Hetchy Wildland Conservation Area

**Size:** 2 million acres

**Dominant land owner(s):** Toiyabe, Eldorado, Stanislaus, and Inyo National Forests

**Protected areas:** Yosemite National Park and Hoover, Ansel Adams, Carson, Mokelumne, and Emigrant Wilderness Areas

**Dominant vegetation:** Blue oak pine, Blue oak woodland, Montane chaparral, Mixed chaparral, Sierra mixed conifer, Subalpine conifer, Lodgepole pine, Red fir, Pinyon-Juniper

**Conservation guidelines**

- Seek wilderness designation for roadless areas on USFS lands.
- Participate in public land management policies of general forest and protected areas.
- Mitigate wildlife impacts of Highways 4, 89, 108 and 120.
- Support efforts to restore Pacific fisher population.

**Management guidelines**

- Manage for viable populations of Pacific fisher, marten, wolverine, and California spotted owl (See Section 7.7).
- Monitor impacts of Highways 4, 89, 108 and 120 on wildlife and aquatic habitats.
- Set minimum snow depth for snowmobile use, especially in Hope Valley. Enforce existing snowmobile regulations.

**SITE 28**

---

**Name:** Sierra Crest Wildland Conservation Area

**Size:** 168,000 acres

**Dominant land owner(s):** Tahoe and Eldorado National Forests

**Protected areas:** Granite Chief and Desolation Wilderness Areas

**Dominant vegetation:** Blue oak pine, Blue oak woodland

**Conservation guidelines**

- Seek wilderness designation for roadless areas on USFS lands.
- Support efforts to restore wolverine populations.
- Participate in public land management policies of general forest and protected areas.

**Management guidelines**

- Manage for viable populations of marten, wolverine, mule deer, and California spotted owl (See Section 7.7).
- Designate and enforce an ORV route network.

**7.4.4 Wildland Linkages**

<b>SITE</b>	<b>FUNCTION</b>	<b>COMMENTS AND GUIDELINES</b>
P	links Site 7 to Site 9, continuation of Link o.	Plumas National Forest. Manage for sage grouse connectivity and pronghorn, and mule deer dispersal (See Section 7.7).
Q	links Site 6 to Site 8, continuation of Link m.	Plumas National Forest, some private. A Missing Link (Penrod et al. 2001). Manage for habitat connectivity for California spotted owl, Pacific fisher, gray wolf, and wolverine (See Section 7.7).
R	links Site 11 to Site 8.	Plumas National Forest, some private. Crosses Highway 89. Manage for habitat connectivity for marten, gray wolf, wolverine, and California spotted owl (See Section 7.7).
S	links Site 8 to Site 9.	Plumas National Forest. Manage for habitat connectivity for marten, gray wolf, and wolverine (See Section 7.7).
T	links Site 9 to Site 12.	Plumas National Forest. Crosses Highway 89. Manage for habitat connectivity for marten (See Section 7.7).
U	links Site 9 to Site 13.	Private. Crosses Highway 70. Manage for habitat connectivity for marten, and pronghorn, mule deer, gray wolf, and wolverine dispersal (See Section 7.7).
V	links Site 10 to Sites 17 and 28.	Tahoe National Forest and private. Crosses Highways 80 and 89. Manage for connectivity for California spotted owl, marten, wolverine, gray wolf, and mule deer dispersal (See Section 7.7).
W	links Site 12 to Site 17 along mixed fir and subalpine forests.	Tahoe and Plumas National Forest, some private. Crosses Highway 49. Manage for habitat connectivity for marten, gray wolf, and wolverine.
X	links Site 12 to Site 17 along mixed conifer belt.	Tahoe National Forest, some private.
Y	links Site 6 to Site 11 in Sierra mixed-conifer belt.	Lassen and Plumas National Forests and private timber firms. Crosses Highways 36, 70, and 89. Manage for restoration of Pacific fisher, California spotted owl, and marten habitat connectivity.
Z	links BLM land in Site 3 through private lands in Site 7 to Plumas Nation Forest in Site 9.	Private and BLM land. Crosses Highway 395. Manage for sage grouse habitat connectivity and dispersal of mule deer.  Private. Threatened by development. Crosses Highway 20.

*Wildland Linkages, Continued*

SITE	FUNCTION	COMMENTS AND GUIDELINES
a1	two parallel links from Site 14 to Site 18 through oak woodland and mixed chaparral.	Maintain oak woodland connectivity for California spotted owl, acorn woodpecker, and mule deer dispersal (See Section 7.7).
a2	parallel links from Site 18 and Site 20 to Site 15. Upslope-downslope connector between lower elevation mixed hardwood to middle elevation mixed conifer.	Tahoe National Forest, some BLM and private. Crosses Highway 80. Maintain habitat connectivity for California spotted owl, acorn woodpecker, and mule deer dispersal (See Section 7.7).
a3	parallel links Sites 18 and 19 to Site 20 along mixed hardwood belt. Follows Coon Creek and middle fork of the American River.	Private. Crosses Highways 49 and 80. Maintain habitat connectivity for California spotted owl, acorn woodpecker, and mule deer dispersal (See Section 7.7).
a4	link Site 15 to Site 17 along mixed conifer belt.	Tahoe National Forest and private timber company. Crosses Highways 80 and 20. Maintain habitat connectivity for California spotted owl, Pacific fisher, and marten (See Section 7.7).
a5	links Site 22 to Site 28. Upslope-downslope connector between middle elevation conifer forest to subalpine belt. Follows south fork of the American River and Cosumnes River.	Eldorado National Forest and private timber company. Crosses Highways 50 and 49. A landscape linkage (Penrod et al. 2001). Maintain habitat connectivity for California spotted owl, Pacific fisher, marten, wolverine, and mule deer dispersal (See Section 7.7).
a6	links Site 23 to Site 25.	Eldorado National Forest and private timber company. Maintain habitat connectivity for Pacific fisher, California spotted owl, and mule deer dispersal (See Section 7.7).
a7	parallel links from Site 23 to Site 24 and Site 26.	Private. Crosses Highways 16, 49, 104, and 12. Maintain habitat connectivity for acorn woodpecker, California spotted owl, and mule deer dispersal (See Section 7.7).

*Wildland Linkages, Continued*

SITE	FUNCTION	COMMENTS AND GUIDELINES
a8	links Site 25 to Site 26. Upslope-downslope connector between mixed hardwood and mixed conifer belts.	Private and BLM. A recovery linkage (Penrod et al. 2001). Maintain habitat connectivity for California spotted owl, Pacific fisher, and for mule deer dispersal (See Section 7.7).
a9	links Site 25 to site 27.	Stanislaus National Forest and private. A recovery linkage (Penrod et al. 2001). Maintain habitat connectivity for California spotted owl, wolverine, and Pacific fisher (See Section 7.7).
a10	parallel links between Site 28 and Site 27.	Eldorado National Forest. Crosses Highways 4, 10, and 8. Maintain habitat connectivity for marten and wolverine (See Section 7.7).
a11	links two area of Site 27 together on eastside.	Toiyabe National Forest. Crosses Highways 89 and 4. Maintain habitat connectivity for marten and wolverine, and for mule deer dispersal (See Section 7.7).

*7.4.5 Stewardship Zones**See Section 7.7*

7.5 Guidelines for South Sierra Study Area

Map 13. South Sierra study area

(Note: Numbers are related to specific Wildland Conservation Areas (Site number) and letters refer to linkages within the subregion [see Table 7.5.4]).

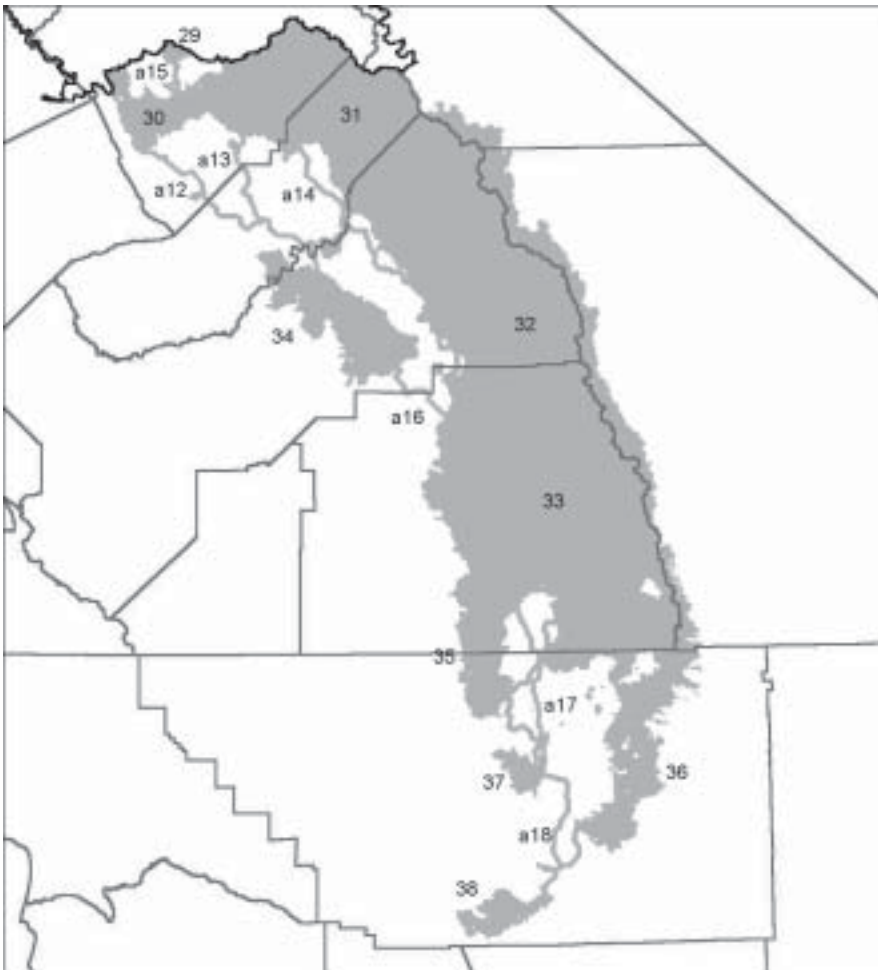

### *7.5.1 Description of Wildlands for South Sierra Study Area*

#### **General area and ownership information**

The South Sierra study area is 70% publicly owned, mostly by National Forests, Bureau of Land Management, and National Park Service. Westside foothill subregion is mostly in private ownership. There is one very large protected area complex at and above the mixed conifer belt and consists of Yosemite, Sequoia, and Kings Canyon National Parks, Sequoia National Monument, and numerous adjacent federal Wilderness Areas.

The South Sierra study area contains all or part of five counties, including all of Mariposa County, eastern halves of Madera, Fresno, Tulare Counties, and central Kern County.

#### **Wildlands composition and status**

The South Sierra study area is comprised of approximately seven million acres with 70% (5 million acres) identified as Wildland Conservation Areas. There are many opportunities for expanding the protected area complex to include vulnerable mixed conifer and hardwood habitats.

There are ten Wildland Conservation Areas and seven Wildland Linkages in the study area. In addition, the Missing Linkages conference (Penrod et al. 2001) identified eight additional linkages in the study area. Results of a recent habitat suitability study for the California spotted owl (Carroll 1999) identifies a large portion of the study area as highly suitable for this declining forest specialist.

#### **Fragmentation**

Fragmentation is significant in unprotected forested and woodland habitats. Road density in the study area is highest along lower elevation hardwood habitats.

The greatest concentration of road density (mostly paved roads), is in the foothill counties. While not nearly as roaded as foothill counties of the north Sierra, the south Sierra foothills have an average road density of 2km/km<sup>2</sup>. The lightest areas of road density in foothill habitats are found in portions of Tulare, Kern, and Fresno counties within the study area.

The public land managed by the U.S. Forest Service outside of Wilderness Areas have a moderate density of unpaved roads at an average of 1.8km/km<sup>2</sup>. Due to protective status of higher elevation areas, mountainous environs have low to zero road density.

Recent forest fires, clearcuts, and road networks fragment general US Forest Service lands. Middle elevation forests just west of the protected area complex include natural fragmentation in the form of granite rock outcrops and steep elevation gains. A large gap in forest continuity is found at the Tehachapi Pass, a vital middle elevation link between the Tehachapi Mountains and the Transverse Ranges.



### *7.5.2 Conservation and Management Guidelines for the South Sierra Study Area*

#### **Conservation guidelines**

- Protect threatened areas first.
- Seek conservation easement or purchase of threatened land in Wildland Conservation Areas and Wildland Linkages.
- Support efforts to restore gray wolf and wolverine populations.
- Support efforts to maintain existing Pacific fisher populations in study area.
- Mitigate harmful impacts of roads to wildlife.

#### **Management guidelines**

- Minimize road density levels on public lands by evaluating roads for decommissioning.
- Practice sustainable resource management.
- Minimize impacts of roads to plants and wildlife.
- Monitor wildlife movement to identify functioning landscape linkages.
- Monitor populations of focal species.

### *7.5.3 Wildland Conservation Areas*

#### **SITE 29**

---

**Name:** Merced Wildland Conservation Area

**Size:** 15,000 acres

**Dominant land owner(s):** Stanislaus National Forest

**Protected areas:** None

**Dominant vegetation:** Ponderosa pine

#### **Conservation guidelines**

- Seek wilderness designation for roadless areas on USFS lands.
- Participate in public land management policies of general forest and protected areas.
- Mitigate wildlife impacts of Highway 120.

#### **Management guidelines**

- Manage for viable populations of marten, California spotted owl, and Pacific fisher (See Section 7.7).
- Monitor impacts of Highway 120 on wildlife and aquatic habitats.

**SITE 30**

---

**Name:** Mariposa Wildland Conservation Area

**Size:** 140,000 acres

**Dominant land owner(s):** Private, Bureau of Land Management

**Protected areas:** None

**Dominant vegetation:** Blue oak woodland, Blue oak pine, Montane hardwood, Chamise-redshank chaparral

**Conservation guidelines**

- Seek conservation easements on private lands.
- Participate in public land management policies of general forest and protected areas.
- Mitigate wildlife impacts of Highways 132 and 49.

**Management guidelines**

- Manage for viable populations of acorn woodpecker, California spotted owl and mule deer (See Section 7.7).
- Maintain forest intactness by limiting new road development and unsustainable resource use.
- Monitor impacts of Highways 132 and 49 on wildlife and aquatic habitats.

**SITE 31**

---

**Name:** Mammoth Pool Wildland Conservation Area

**Size:** 1 million acres

**Dominant land owner(s):** Sierra National Forest, US National Parks

**Protected areas:** Yosemite National Park, Devil's Postpile National Monument, Ansel Adams and John Muir Wilderness Areas.

**Dominant vegetation:** Red fir, Ponderosa pine, Lodgepole pine, Sierra mixed conifer

**Conservation guidelines**

- Seek wilderness designation for roadless areas on USFS lands.
- Mitigate wildlife impacts of Highways 140 and 41.
- Participate in public land management policies of general forest and protected areas.
- Maintain existing population of Pacific fisher.

**Management guidelines**

- Manage for viable populations of wolverine, marten, Pacific fisher, bighorn sheep, and California spotted owl (See Section 7.7).
- Monitor impacts of Highways 140 and 41 on wildlife and aquatic habitats.
- Close the Middle Fork San Joaquin River drainage to snowmobile use. Enforce the closure.

**SITE 32**

---

**Name:** Tulare Wildland Conservation Area

**Size:** 1.3 million acres

**Dominant land owner(s):** Sequoia National Forest, US National Parks

**Protected areas:** Sequoia National Park, Sequoia National Monument, Dinky and John Muir Wilderness Areas

**Dominant vegetation:** Red fir, Lodgepole pine, Subalpine conifer, Alpine-dwarf shrub

**Conservation guidelines**

- Seek wilderness designation for roadless areas on USFS lands.
- Participate in public land management policies of general forest and protected areas.
- Maintain existing population of Pacific fisher.

**Management guidelines**

- Manage for viable populations of Pacific fisher, marten, wolverine, bighorn sheep, and California spotted owl (See Section 7.7).

**SITE 33**

---

**Name:** Sequoia Wildland Conservation Area

**Size:** 1.6 million acres

**Dominant land owner(s):** Sequoia National Forest, US National Parks, private, Bureau of Land Management

**Protected areas:** Sequoia and Kings Canyon National Parks, and multiple Wilderness Areas including Golden Trout, John Muir and Dome Land Wilderness Areas.

**Dominant vegetation:** Red fir, Lodgepole pine, Subalpine conifer, Alpine-dwarf shrub

**Conservation guidelines**

- Seek wilderness designation for roadless areas on USFS lands.
- Maintain existing population of Pacific fisher.
- Participate in public land management policies of general forest and protected areas.
- Mitigate wildlife impacts of Highway 198.

**Management guidelines**

- Manage for viable populations of Pacific fisher, marten, bighorn sheep, and California spotted owl (See Section 7.7).
- Monitor impacts of Highway 198 on wildlife and aquatic habitats.

**SITE 34**

---

**Name:** Kings River Wildland Conservation Area

**Size:** 340,000 acres

**Dominant land owner(s):** Sequoia National Forest, private

**Protected areas:** None

**Dominant vegetation:** Blue oak woodland, Blue oak pine, and Chamise-redshank chaparral

**Conservation guidelines**

- Seek wilderness designation for roadless areas on USFS lands.
- Maintain existing population of Pacific fisher.
- Seek conservation easements on private lands.
- Participate in public land management policies of general forest and protected areas.
- Mitigate wildlife impacts of Highways 168 and 180.

**Management guidelines**

- Manage for viable populations of acorn woodpecker, California spotted owl, and mule deer (See Section 7.7).
- Monitor impacts of Highways 168 and 180 on wildlife and aquatic habitats.

**SITE 35**

---

**Name:** Coho Wildland Conservation Area

**Size:** 230,000 acres

**Dominant land owner(s):** Private.

**Protected areas:** None

**Dominant vegetation:** Blue oak woodland, Blue oak pine

**Conservation guidelines**

- Seek conservation easements on private lands.
- Mitigate wildlife impacts of Highway 155.

**Management guidelines**

- Manage for viable populations of mule deer, acorn woodpecker, and California spotted owl (See Section 7.7).
- Monitor impacts of Highway 155 on wildlife and aquatic habitats.

**SITE 36**

---

**Name:** Alpine Creek Wildland Conservation Area

**Size:** 300,000 acres

**Dominant land owner(s):** Sequoia National Forest, private, Bureau of Land Management

**Protected areas:** Kiaveh Wilderness Area, Owens Peak Wilderness Area, Sacatar Wilderness Area, BLM Jawbone-Butterbred Springs ACEC

**Dominant vegetation:** Sagebrush, Pinyon-Juniper, Desert scrub

**Conservation guidelines**

- Seek conservation easements on private lands.
- Seek wilderness designation for roadless areas on USFS lands.

**Management guidelines**

- Manage for viable populations of mule deer, acorn woodpecker, and California spotted owl (See Section 7.7).
- Eliminate off-trail ORV use in ACEC.

**SITE 37**

---

**Name:** Tehachapi Wildland Conservation Area

**Size:** 55,000 acres

**Dominant land owner(s):** Private

**Protected areas:** None

**Dominant vegetation:** Blue oak woodland, Mixed chaparral

**Conservation guidelines**

- Seek conservation easements on private lands.
- Mitigate wildlife impacts of Highway 178.

**Management guidelines**

- Manage for viable populations of mule deer, acorn woodpecker, and California spotted owl (See Section 7.7).
- Monitor impacts of Highway 178 on wildlife and aquatic habitats.

**SITE 38**

---

**Name:** Nennach Wildland Conservation Area

**Size:** 85,000 acres

**Dominant land owner(s):** Private

**Protected areas:** None

**Dominant vegetation:** Mixed chaparral, Valley oak woodland, Montane hardwood

**Conservation guidelines**

- Seek conservation easements on private lands.

**Management guidelines**

- Manage for viable populations of mule deer and acorn woodpecker (See Section 7.7).

**7.5.4 Wildland Linkages**

SITE	FUNCTION	COMMENTS AND GUIDELINES
a12	links Site 30 to Site 34.	Private. Crosses Highway 140. Maintain habitat connectivity for acorn woodpecker and California spotted owl, as well as mule deer dispersal (See Section 7.7).
a13	links Site 13 to Site 34. Upslope-downslope connector between hardwood and mixed conifer belts.	Private. Crosses Highway 49. Manage for habitat connectivity for California spotted owl, Pacific fisher, as well as mule deer dispersal (See Section 7.7).
a14	links Site 31 and Site 32 to Site 34. Upslope-downslope connector between hardwood and mixed conifer belts.	Sierra National Forest, some private. Crosses Highway 168. Manage for habitat connectivity for Pacific fisher, California spotted owl, as well as mule deer dispersal (See Section 7.7).
a15	links Site 29 to Site 30.	Stanislaus National Forest. A recovery linkage for Pacific fisher (Penrod et al. 2001). Maintain habitat connectivity for Pacific fisher and California spotted owl, as well as mule deer dispersal (See Section 7.7).
a16	links Site 34 to Site 33.	Private. Crosses Highway 245. Manage for habitat connectivity for California spotted owl (See Section 7.7).
a17	parallel links from Site 33 and Site 35 to Site 37.	Sequoia National Forest. Crosses Highways 158 and 178. Manage for habitat connectivity for California spotted owl (See Section 7.7).
a18	links Site 37 and Site 36 to Site 38.	Private. A landscape linkage (Penrod et al. 2001). Manage for connectivity for California spotted owl and mule deer dispersal (See Section 7.7).

**7.5.5 Stewardship Zones**

See Section 7.7

## 7.6 GUIDELINES FOR EAST SIERRA STUDY AREA

*Map 14. East Sierra study area*

*(Note: Numbers are related to specific Wildland Conservation Areas (Site numbers) and letters refer to linkages within the subregion [see Table 7.6.4]).*

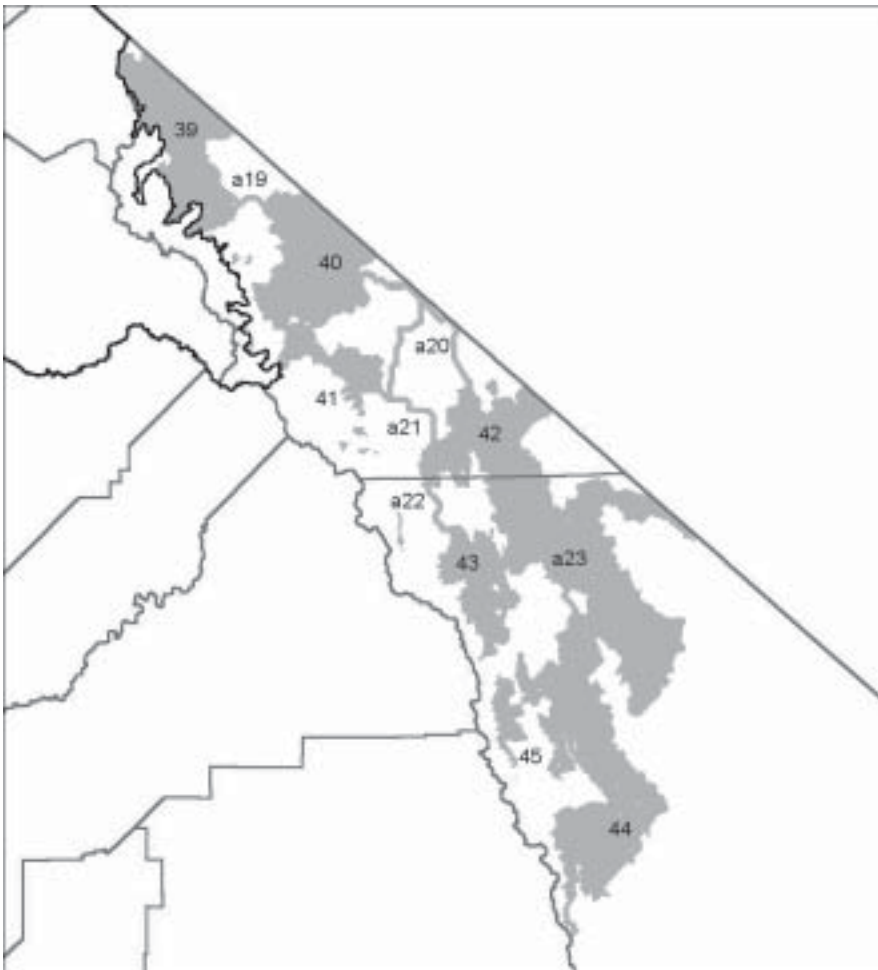



### *7.6.1 Description of Wildlands in East Sierra Study Area*

#### **General area and ownership information**

The East Sierra study area is 90% publicly owned, mostly by U.S. Forest Service, Bureau of Land Management, and US National Park Service. This area contains all of Mono County and part of Bishop County.

#### **Wildlands composition and status**

The East Sierra study area is approximately 3.7 million acres with 59% (2.3 million acres) identified as Wildland Conservation Areas. Due to the general intact nature of habitats in the study area, there are large wildlands available for protection. There are seven Wildland Conservation Areas and four Wildland Linkages that have been identified in the study area. In addition, the Missing Linkages conference (Penrod et al. 2001) identified seven linkages in the study area.

#### **Fragmentation**

The density of roads in the East Sierra study area is not significant. The greatest concentration of road density in the study area occurs along the valley bottoms and averages 2.8km/km<sup>2</sup>. Fragmentation in this region mostly affects the lower elevation, valley bottom habitats. There are two areas that exhibit the greatest level of fragmentation: the Owens Valley and the eastside Sierra portion of Inyo National Forest.

### *7.6.2 Conservation and Management Guidelines in the East Sierra Study Area*

#### **Conservation guidelines**

- Protect threatened areas first.
- Seek conservation easement or purchase of threatened land in Wildland Conservation Areas and Wildland Linkages.
- Support efforts to restore gray wolf and wolverine populations (See Section 7.7).
- Support efforts to maintain existing Pacific fisher populations in study area.
- Mitigate harmful impacts of roads to wildlife.

#### **Management guidelines**

- Minimize road density levels on public lands by evaluating roads for decommissioning.
- Practice sustainable resource management.
- Minimize impacts of roads to plants and wildlife.
- Monitor wildlife movement to identify functioning landscape linkages.
- Monitor populations of focal species.

*7.6.3 Wildland Conservation Areas in the East Sierra Study Area*

**SITE 39**

---

**Name:** Antelope Wildland Conservation Area

**Size:** 275,000 acres

**Dominant land owner(s):** Inyo National Forest, Bureau of Land Management

**Protected areas:** Slinkard Valley Area of Critical Environmental Concern

**Dominant vegetation:** Pinyon-juniper, sagebrush

**Conservation guidelines**

- Seek wilderness designation for roadless areas on USFS lands.
- Participate in public land management policies of general forest and protected areas
- Mitigate wildlife impacts of Highway 395.
- Support efforts to restore a wolverine population.

**Management guidelines**

- Manage for viable populations of pronghorn, bighorn sheep, marten, wolverine, sage grouse, and mule deer (See Section 7.7).
- Monitor impacts of Highway 395 on wildlife and aquatic habitats.

**SITE 40**

---

**Name:** Mono Wildland Conservation Area

**Size:** 350,000 acres

**Dominant land owner(s):** Inyo National Forest, Bureau of Land Management

**Protected areas:** USFS Mono Lake Scenic Area, BLM Bodie Area of Critical Environmental Concern.

**Dominant vegetation:** Juniper, sagebrush, Alkali desert scrub, low sage

**Conservation guidelines**

- Seek wilderness designation for roadless areas on USFS lands.
- Participate in public land management policies of general forest and protected areas.
- Mitigate wildlife impacts of Highways 167 and 120.

**Management guidelines**

- Manage for viable populations of pronghorn, bighorn sheep, sage grouse and mule deer (See Section 7.7).
- Maintain forest intactness by limiting new road development and unsustainable resource use.
- Monitor impacts of Highways 167 and 120 on wildlife and aquatic habitats.

**SITE 41**

---

**Name:** Glass Mountain Wildland Conservation Area

**Size:** 100,000 acres

**Dominant land owner(s):** Inyo National Forest

**Protected areas:** USFS Sentinel Meadow Research Natural Area

**Dominant vegetation:** Pinyon-juniper, sagebrush, lodgepole pine, limber pine

**Conservation guidelines**

- Seek wilderness designation for roadless areas on USFS lands.
- Participate in public land management policies of general forest and protected areas.

**Management guidelines**

- Manage for viable populations of pronghorn, bighorn sheep, sage grouse (See Section 7.7).

**SITE 42**

---

**Name:** Owens Wildland Conservation Area

**Size:** 800,000 acres

**Dominant land owner(s):** Inyo National Forest, Bureau of Land Management

**Protected areas:** USFS Ancient Bristlecone Pine Forest Special Interest Area, BLM Fish Slough Critical Area of Concern

**Dominant vegetation:** Alpine-dwarf scrub, Juniper, sagebrush, Alkali desert scrub, Desert scrub, Joshua tree, Barren

**Conservation guidelines**

- Seek wilderness designation for roadless areas on USFS lands.
- Participate in public land management policies of general forest and protected areas.
- Support efforts to restore wolverine populations.
- Mitigate wildlife impacts of Highways 6 and 168.

**Management guidelines**

- Manage for viable populations of pronghorn, bighorn sheep, marten, wolverine, and sage grouse (See Section 7.7).
- Monitor impacts of Highways 6 and 168 on wildlife and aquatic habitats.

**SITE 43**

---

**Name:** Birch Creek Wildland Conservation Area

**Size:** 150,000 acres

**Dominant land owner(s):** Inyo National Forest

**Protected areas:** None

**Dominant vegetation:** Sagebrush, Alkali desert scrub

**Conservation guidelines**

- Seek wilderness designation for roadless areas on USFS lands.
- Participate in public land management policies of general forest and protected areas.
- Mitigate wildlife impacts of Highways 168 and 395.

**Management guidelines**

- Manage for viable populations of pronghorn, bighorn sheep, sage grouse and mule deer (See Section 7.7).
- Monitor impacts of Highways 168 and 395 on wildlife and aquatic habitats.

**SITE 44**

---

**Name:** Lone Pine Wildland Conservation Area

**Size:** 500,000 acres

**Dominant land owner(s):** Inyo National Forest, Bureau of Land Management,  
US National Park Service

**Protected areas:** Death Valley National Park, BLM Piper Mountain Wilderness Area, BLM Sylvania  
Mountains Wilderness Area, USFS Inyo Wilderness Area

**Dominant vegetation:** Barren, Desert scrub, Juniper, Alkali desert scrub, Bristlecone pine

**Conservation guidelines**

- Seek wilderness designation for roadless areas on USFS lands.
- Participate in public land management policies of general forest and protected areas.
- Mitigate wildlife impacts of Highways 395, 136, and 190.

**Management guidelines**

- Manage for viable populations of pronghorn, bighorn sheep, mule deer, marten, and wolverine (See Section 7.7).
- Monitor impacts of Highways 395, 136, and 190 on wildlife and aquatic habitats.

**SITE 45**

**Name:** Pinyon Creek Wildland Conservation Area

**Size:** 70,000 acres

**Dominant land owner(s):** Inyo National Forest

**Protected areas:** None

**Dominant vegetation:** Sagebrush, Alkali desert scrub

**Conservation guidelines**

- Seek wilderness designation for roadless areas on USFS lands.
- Participate in public land management policies of general forest and protected areas.
- Mitigate wildlife impacts of Highway 395.

**Management guidelines**

- Manage for viable populations of pronghorn, bighorn sheep, and mule deer (See Section 7.7).
- Monitor impacts of Highway 395 on wildlife and aquatic habitats.

**7.6.4 Wildland Linkages**

<b>SITE</b>	<b>FUNCTION</b>	<b>COMMENTS AND GUIDELINES</b>
a19	links Site 39 and Site 40.	BLM. Crosses Highways 395 and 182. Maintain habitat connectivity for sage grouse and wolverine, as well as bighorn sheep and pronghorn dispersal (See Section 7.7).
a20	links Site 42 and Site 41 to Site 40.	BLM, Inyo National Forest. Crosses Highways 6 and 120. Maintain habitat connectivity for sage grouse and marten, as well as bighorn sheep and pronghorn dispersal (See Section 7.7).
a21	links Site 41 to Site 42.	Inyo National Forest. Maintain habitat connectivity for sage grouse and wolverine, as well as bighorn sheep and pronghorn dispersal (See Section 7.7).
a22	links Site 42 to Site 43.	BLM. Crosses Highways 395 and 168. A landscape linkage (Penrod et al. 2001). Maintain habitat connectivity for sage grouse and wolverine, as well as bighorn sheep and pronghorn dispersal (See Section 7.7).
a23	links Site 23 to Site 44.	Inyo National Forest. Maintain habitat connectivity for sage grouse and marten and wolverine, as well as bighorn sheep and pronghorn dispersal (See Section 7.7).

## 7.7 GUIDELINES FOR FOCAL SPECIES MANAGEMENT

### 7.7.1 GRAY WOLF (*Canis lupus*)

- Develop a strategy to restore the gray wolf into the Cascade/Modoc subregion. This area contains the most suitable habitat for the species within the Greater Sierra Nevada bioregion and has a relatively high proportion of public land (Carroll et al. 2000).
- Manage for a metapopulation size of 500 individuals (Paquet and Hackman 1995).
- Maintain deer populations at high enough levels to sustain a wolf population. This may include reducing hunting pressure.
- Prevent direct persecution and harm to individual wolves from activities such as hunting, trapping and predator control programs (Carroll et al. 2001).
- Maintain a density roads of less than 0.58 km/km<sup>2</sup>, especially in forested valley bottoms that exhibit favorable snow conditions and prey density (Paquet and Hackman 1995, and Carroll et al. 2001).

### 7.7.2 WOLVERINE (*Gulo gulo*)

- Protect subalpine cirque habitats with abundant rocky areas that are connected to montane coniferous forests (Biodiversity Legal Foundation 2000).
- Closely manage winter recreational activities, especially helicopter skiing and snowmobiling, in denning areas (Biodiversity Legal Foundation 2000).
- Minimize actions that would create openings in the forest canopy (Biodiversity Legal Foundation 2000).
- Closely manage use of logging roads by snowmobiles and ATVs, especially in winter (Biodiversity Legal Foundation 2000).
- Remove as quickly as possible roadkill to reduce wolverine use of road corridors (Biodiversity Legal Foundation 2000).
- Regulate deer harvest to ensure adequate numbers for wolverine use (Banci 1994).
- Manage for preservation and restoration of large continuous blocks of habitat (Banci 1994).

### 7.7.3 PACIFIC FISHER (*Martes pennanti pacifica*)

- Maintain canopy closure of at least 88% (Center for Biological Diversity and Sierra Nevada Forest Protection Campaign 2000).
- Maintain conifers of at least 77 cm dbh and hardwoods of at least 49 cm dbh (Center for Biological Diversity and Sierra Nevada Forest Protection Campaign 2000).
- Maintain stands that are greater than 100 ha in size (Center for Biological Diversity and Sierra Nevada Forest Protection Campaign 2000).
- Manage for a road density of less than .5 miles per square mile (Center for Biological Diversity and Sierra Nevada Forest Protection Campaign 2000).
- Prohibit trapping using hand sets (Powell and Zilinski 1994).

- Manage for snowshoe hare and porcupine populations (Powell and Zilinski 1994).
- Minimize open areas to facilitate movement between home ranges (Powell and Zielinski 1994).

#### 7.7.4 PINE MARTEN (*Martes americana*)

- Avoid large areas of clearcutting as a logging technique in marten habitat. If there is clearcutting, retain the forest cover on at least 25% of the area, with the cover constituting at least 25 m<sup>2</sup>/ha of at least pole stage trees (Strickland and Douglas 1987, USDA 2001).
- Use ecological management tools to minimize the potential for large unnatural fires (Strickland and Douglas 1987).
- Manage for mixed-age stands of trees (Strickland and Douglas 1987).
- Canopy closure should be greater than 30% (Strickland and Douglas 1987, USDA 2001).
- Conifers should comprise at least 25% of the forest overstory (Strickland and Douglas 1987).
- Retain stumps and fallen trees on 25 to 50% of the ground area (Strickland and Douglas 1987).
- Retain both large old trees and large logs for den sites (Strickland and Douglas 1987).
- Openings in the canopy should constitute less than 25% of the area (USDA 2001).
- Preserve riparian forests as foraging areas (USDA 2001).
- Small open areas should only occur adjacent to mature forest (USDA 2001).
- Manage for maximization of squirrel and vole populations (USDA 2001).
- Avoid ski area and snow park development in marten habitat (USDA 2001).
- Minimize the effect of roads through permanent or seasonal closures (USDA 2001).
- Maintain the overhead canopy in habitat linkage areas (Buskirk and Ruggiero 1994).
- Restore meadows and riparian areas through removal of livestock, reversal of the encroachment of trees, removal pack stations, reduction of roads and eliminating the salvage of timber (USDA 2001).

#### 7.7.5 CALIFORNIA SPOTTED OWL (*Strix occidentalis occidentalis*)

- See management guidelines for California spotted owl in Sierra Nevada Forest Plan Amendment (USDA 2001).

#### 7.7.6 ACORN WOODPECKER (*Melanerpes formicivorus*)

- Managers should seek to maximize the diversity of oak species at each site, optimally at least five (CPIF 2000, Koenig and Haydock 1999).
- Preserve all granary trees, even if not currently in use (CPIF 2000).
- Maintain 35 potential granary trees/100 h, especially those greater than 17 cm dbh (CPIF 2000).
- Seek to create structurally diverse oak stands through enhanced oak regeneration and less intensive methods of grazing (CPIF 2000).
- Maintain habitats that are at least 6 ha of open oak or oak/conifer that surround 0.4 to 0.8 ha stands of large oaks and pines, especially those areas below 3000' in elevation and are within 0.4 km of a water source (Ahlborn and Harvey 1990).



- Maximize oak regeneration in woodlands (Koenig et al. 1995).
- Maintain or restore links to areas of mixed conifer with black oak (Ahlborn and Harvey 1990).
- Regulate firewood cutting in acorn woodpecker habitat (CPIF 2000).
- Minimize starling populations, and maintain large tracts of undisturbed land (CPIF 2000).

#### 7.7.7 GREATER SAGE-GROUSE (*Centrocercus urophasianus*)

- Manage sagebrush habitat for plants 40-80 cm tall. The canopy should cover 10-25% of the total area. The herbaceous understory should consist of 15% grass cover and 10% forb cover that are at least 18 cm tall. These conditions should constitute 80% of the breeding habitat and 40% of the brood-rearing habitat (Interagency Sage-Grouse Planning Team 2000).
- Manage winter habitat to consist of sagebrush canopy of 10-30% that is 25-30 cm above the snow, over 80% of the total area (Interagency Sage-Grouse Planning Team 2000).
- Avoid large-scale mechanical treatments in sage-grouse habitat, and all mechanical treatments in winter habitat (Interagency Sage-Grouse Planning Team 2000).
- Reduce areas of cheatgrass cover through seeding or other means (Interagency Sage-Grouse Planning Team 2000, ICBEMP 2000).
- Avoid livestock activities such as winter-feeding, turnout and trailing, spring development, and salt supplements in sage-grouse habitat (Interagency Sage-Grouse Planning Team 2000, Connelly et al. 2000).
- Where development takes place in sage-grouse habitat, use existing rights-of-ways and utility corridors (Interagency Sage-Grouse Planning Team 2000).
- Install escape ramps in water troughs (Interagency Sage-Grouse Planning Team 2000).
- Only use prescribed fire when better sage-grouse habitat will be the result. However, only burn a maximum of 20% of any given habitat in a 20-year period and keep fires under 50 ha in size (Interagency Sage-Grouse Planning Team 2000, Connelly et al. 2000).
- Restore and protect spring, seep, and riparian areas (ICBEMP 2000).
- Eliminate pesticide use in agricultural areas contiguous to sage-grouse habitat (ICBEMP 2000).
- Carefully evaluate energy and mineral development for potentially negative effects on sage-grouse populations (Connelly et al. 2000).
- Eliminate sage-grouse hunting unless a population contains more than 300 breeding individuals (Connelly et al. 2000).
- Eliminate invasive non-native predator species, especially red fox (Connelly et al. 2000).
- Place flagging on fences and other structures within 1 km of sage-grouse populations (Connelly et al. 2000).
- Do not construct tall structures such as powerlines within 3 km of sage-grouse populations (Connelly et al. 2000).

### 7.7.8 MULE DEER (*Odocoileus hemionus californicus*)

- Manage areas for vegetative structural diversity, in order to provide for foraging, hiding, and fawning areas (USDA 2001).
- Eliminate herbicide use in mule deer habitat (USDA 2001).
- Use prescribed fire as opposed to mechanical harvest to regenerate habitat. Timing is important to achieve best vegetative results (USDA 2001, CDFG 1998).
- When using prescribed fire, burn areas larger than 400 acres. These fires should be a part of a larger watershed approach in order to establish a mosaic pattern (CDFG 1998).
- Minimize use of prescribed fire on shrub habitat east of the Sierras (CDFG 1998).
- Do not use salvage logging after prescribed fires (CDFG 1998).
- Reduce livestock grazing of forage and browse needed by deer on their winter range (USDA 2001).
- Minimize use of mechanical thinning in deer habitat to avoid decreasing thermal cover (CDFG 1998).
- Avoid using aerial herbicides that would reduce deer forage (CDFG 1998).
- Restore mountain meadows and montane riparian habitats through strict regulation of livestock use, possibly meaning exclusion (CDFG 1998).
- Manage for healthy aspen stands (CDFG 1998).
- In northeast California, reduce or eliminate livestock use of bitterbrush, and manage for reduction of juniper extension into shrub areas (CDFG 1998).
- Reduce impact of livestock on small meadows, seeps, springs, and riparian areas throughout deer habitat (CDFG 1998).
- Eliminate spring burning as it does not mimic natural processes (CDFG 1998).
- Consider using rotation grazing to reduce impact to deer populations (CDFG 1998).
- Reduce competition between livestock and deer for forage (CDFG 1998).

### 7.7.9 PRONGHORN (*Antilocarpa americana*)

- Manage habitat for 40-60% vegetative cover less than 45 cm tall, consisting of 10-20% sage species, 40-60% grass, 25-35% forbs, and 5-15% other browse species (Pyshora 1977).
- Minimize amount of fencing in pronghorn habitat. If fencing is used. See O’Gara and Yoakum (1992) for specifics on construction.
- Herding should be emphasized as a livestock management technique (O’Gara and Yoakum 1992).
- Remove livestock from fawning areas during the fawning period (O’Gara and Yoakum 1992).
- Manage range for habitat diversity (O’Gara and Yoakum 1992).
- Manage shrub areas for a maximum of 50% canopy cover consisting of shrubs over 30" tall (O’Gara and Yoakum 1992).
- Avoid range projects larger than 1000 acres in size (O’Gara and Yoakum 1992).

- For range projects, retain 5-20% shrub canopy cover. Only reduce shrubs on fawning grounds or winter range when the shrubs are decadent (O’Gara and Yoakum 1992).
- Use prescribed burning under the following conditions:
  - at least half the plant cover is sagebrush;
  - perennial forbs and grasses form at least 20% of the plant cover;
  - it takes place in late summer or fall;
  - at least 10 days after grass seed is ripe and scattered and the leaves are dry (O’Gara and Yoakum 1992).
- For range projects, use a mixture of seeds of 10-30 native grasses, forbs, and shrubs for reseeding (O’Gara and Yoakum 1992).
- In allocating forage, reserve pronghorn preferred forage for the pronghorn (O’Gara and Yoakum 1992).
- Implement seasonal restrictions on mineral exploration activities (O’Gara and Yoakum 1992).
- Prohibit oil and gas wells on wind-blown ridges and south-facing slopes in winter habitat (O’Gara and Yoakum 1992).
- Mitigate conveyers that are longer than 0.5 miles in length through over-passes or raising the conveyer at 0.5 mile intervals (O’Gara and Yoakum 1992).
- Restrict access of ATVs and snow machines to pronghorn winter ranges and fawning areas, either seasonally or year-round (ICBEMP 2000).

#### *7.7.10 BIGHORN SHEEP (Ovis canadensis)*

- Maintain a buffer zone between bighorn and domestic sheep populations to prevent transmission of pneumonia (Friends of the Inyo et al. 1999).
- Evaluate techniques to reduce mortality due to mountain lions (Friends of the Inyo et al. 1999).
- Manage for retention or restoration through fire of open terrain in steep rocky areas (Friends of the Inyo et al. 1999).
- Manage populations to protect the older individuals who know migration routes (Friends of the Inyo et al. 1999).
- Maintain seasonal travel corridors between summer alpine habitats and winter canyon habitats (Hopkins 1990).
- Strictly protect water sources, escape terrain, and lambing and feeding areas (Hopkins 1990).

---

SECTION EIGHT

---

*Conclusion*





## *Section 8*

### *Conclusion*

#### 8.1 OVERVIEW

Fifty-two percent of the Sierra Nevada region is recommended for protection. Other regional plans with similar goals have recommended comparable figures (Noss et al. 1999, Jeo et al. 1999). Based on the needs of wide-ranging species and other wildland attributes, such large protected areas are necessary.

This report concludes that a broad range of biodiversity attributes and natural processes can be protected by a focal species-based approach. As regional plans like the Sierra Nevada Forest Plan are implemented, biodiversity protection in the Sierra will be improved, but not ensured. If we are to stem the tide of species extinction and ecosystem degradation, appropriate measures must be taken. Land management policies will likely continue to fluctuate with changing political administrations, rather than being driven by public will. History indicates that only truly protected designations, such as wilderness, hold the promise of ensuring long-term protection of disturbance-sensitive wildlife, natural processes, and the full spectrum of biodiversity (Noss and Cooperrider 1994).

As consensus on the problems and solutions builds, measures such as wilderness designations will seem increasingly reasonable. Yet, the immediate message of this report is more complex than facts and figures. It involves regional thinking about these problems by decision-makers and land managers. Until consensus is reached with potential implementers, this report and ones like it will remain irrelevant.

#### 8.2 FUTURE DIRECTIONS

The findings and recommendations made by this report provide useful guidance at the regional scale, but say little about where exactly to place protection or management efforts at the watershed or local levels. The boundaries of Wildland Conservation Areas, for example, are flexible in that they are open to adjustment if doing so improves the site's conservation effectiveness. The data used in this project are coarse and likely miss local information, such as a mule deer migration route along a ridgeline or other essential habitat. The next stage of the planning process is to consult with local wildlife biologists and other experts in local planning efforts in order to refine the design of the regional plan and capture elements missed at the regional scale.

Plans are inherently works-in-progress because new information can increase their effectiveness in meeting the goals. Revising the Wildlands Conservation Plan will require case-by-case consideration on how new data improves conservation planning regionally or at the site level.

We have identified the following next steps as important in continuing the planning process:

- Refine boundaries of Wildland Conservation Areas and Wildland Linkages with biologists and other experts at local forums.
- Conduct a quality assessment of Wildland Conservation Areas and Wildland Linkages with stakeholders and wildlife biologists. Conduct site visits and analyze aerial photographs to evaluate current on-the-ground conditions of high-value or threatened wildlands.
- Conduct site planning of Wildland Conservation Areas and Wildland Linkages at the county level with stakeholders.
- Develop species conservation plans for individual focal species. Understand how the Wildlands Conservation Plan supports viable populations of focal species.
- Unite Wildland Conservation Areas with community smart growth and greenbelt planning. Link local park networks with surrounding wildland areas.
- Improve the predictability of Wildland Conservation Areas by including more accurate habitat models and land cover data when available.

### 8.3 THINK GLOBALLY, PLAN REGIONALLY, AND ACT LOCALLY

Ecological awareness is only a recent phenomenon; the first Earth Day was celebrated a mere 30 years ago. Research in the areas of biology and ecology has been most prolific during this period also. Thus, in contrast to other technical, scientific fields, our understanding of ecology and natural systems is relatively young. Therefore, land planning often lacks the application of ecological understanding. Although the land suffers, the tide is slowly turning.

Land is the basic natural capital of our society (Forman 1995). It is all we have left to pass on from generation to generation. Maintaining the wealth of ecological diversity should become our primary hope for the land, while restoring pieces that we have degraded. We can each be wildland advocates locally by applying the regional Wildlands Conservation Plan to issues at the local level.



## *Glossary*

**Biodiversity** is the variety of life present at various spatial scales: within a community, between communities, and within in a region.

**Bioregion** is an assemblage of adjacent ecoregions sharing one or more natural phenomena.

**Disturbance (cycles) regimes** are the periodic recurrence of particular natural disturbances such as fire or flooding. (Nocs and Cooperrider, 1994)

**Ecoregion** is a large geographic unit distinctive by its assemblage of natural phenomena, such as ecosystems, geological structure, or range of plant and animal distributions.

**Focal Species** are important wildlife species that provide an essential function or are indicative of essential habitat conditions. Plans that can incorporate the habitat requirements of focal species will have a greater chance in protecting species and biodiversity.

**Subregions** are smaller subsections of an ecoregion, such as the westside foothill subregion is a subsection of the larger Sierra Nevada ecoregion.

**Wildland Conservation Areas** are regionally significant wildlands requiring protection, stewardship, and/or restoration.

**Wildlands Conservation Plan** is the combination of the planning results and conservation guidelines for implementation.

**Wildland Linkages** are habitat areas connecting Wildland Conservation Areas. They function by allowing for the movement of migrating wildlife and natural processes through and between habitats.

## References Cited

- Ahlborn, G., and T. Harvey. 1990. Acorn woodpecker. In California Wildlife Habitat Relationships System. California Department of Fish and Game, Sacramento, CA.
- Alexander, S., and N. Waters. 1999. Decision support applications for evaluating placement requisites and effectiveness of wildlife crossing structures. In Evink, G.L., P. Garrett and David Zeugler, eds. Proceedings of the Third International Conference on Wildlife Ecology and Transportation. FL-ER-73-99. Florida Department of Transportation. Tallahassee, Florida. 330pp.
- Allen, A.W., J.G. Cook, and M.J. Armbruster. 1984. Habitat suitability index models: Pronghorn. U.S. Fish and Wildlife Service. FWS/OBS-82/10.65. Washington, D.C.
- Andelman, S., I. Ball, F. Davis, and D. Stoms. 1999. Sites v1.0: an analytical toolbox for designing ecoregional conservation portfolios. Santa Barbara, CA: University of California. Manual prepared for The Nature Conservancy.
- Andelman S.A. and W.F. Fagan. 2000. Umbrellas and Flagships: Efficient Conservation Surrogates or Expensive Mistakes? Proceedings from the Natural Academy of Sciences. 97(11): 5954-5959.
- Autenrieth, R.E., ed. 1978. Guidelines for the management of pronghorn antelope. Pronghorn Antelope Workshop Proc. 8: 473-526.
- Banci, V. 1994. Wolverine. The basis for conserving forest carnivores: American marten, fisher, lynx, and wolverine in the western United States. U.S. Forest Service General Technical Report RM-254. pp. 99-127.
- Barrett, R.H. 2000. A critique of the Sierra Nevada Forest Plan Amendment, Draft Environmental Impact Statement. Unpublished report.
- Biodiversity Legal Foundation. 2000. Petition for a rule to list the Wolverine (*Gulo gulo*) as Threatened or Endangered under the Endangered Species Act, 16 U.S.C. § 1531 et seq. (1973 as amended) within the contiguous United States. Biodiversity Legal Foundation. Louisville, CO. 130 pp.
- Block, W.M., and M. Morrison. 1990. Wildlife diversity of the Central Sierra Foothills. California Agriculture, March-April:19-22.
- Bourgeron, P., H. Humphries, and K. Reynolds. 2000. Conducting large-scale conservation evaluation and conservation area selection using a knowledge-based system. 4th international conference on Integrating GIS and Environmental Modeling (GIS/EM4): Problems, Prospects, and Research Needs. Banff, Alberta, Canada, September 2-8.
- Buskirk, S.W. and L.F. Ruggiero. 1994. American Marten. In Ruggiero, L.F., K.B. Aubry, S.W. Buskirk, L.J. Lyon, and W.J. Zielinski, eds. The scientific basis for conserving forest carnivores: American marten, fisher, lynx, and wolverine in the western United States. General Technical Report RM-254. U.S. Forest Service. Rocky Mountain Forest and Range Experiment Station. Fort Collins, CO.

- California Department of Fish and Game. 2000. California Wildlife Habitat Relationship Database System, Version 7.0. Computer database and program. California Department of Fish and Game, Sacramento, CA.
- California Department of Fish and Game. 1998. Report to the Fish and Game Commission: An assessment of mule and black-tailed deer habitats and populations in California. California Department of Fish and Game, Sacramento, CA.
- California Partners in Flight. 2000. Version 1.0. The draft oak woodland bird conservation plan: a strategy for protecting and managing oak woodland habitats and associated birds in California (S. Zack, lead author). Point Reyes Bird Observatory, Stinson Beach, CA. <http://www.prbo.org/CPIF/Consplan.html>.
- Carroll, C. 1999. Draft report on regional-scale predictive models of the distribution of the California spotted owl: An exploratory analysis. Klamath Center for Conservation Research.
- Carroll, C., R. F. Noss, N. H. Schumaker, and P. C. Paquet. 2001. Is the return of the wolf, wolverine, and grizzly bear to Oregon and California biologically feasible? In D. Maehr, R. Noss, and J. Larkin, eds. Large mammal restoration: ecological and sociological implications. Island Press, Washington, DC.
- Center for Biological Diversity and Sierra Nevada Forest Protection Campaign. 2000. Status review of the southern Sierra Nevada population of the fisher (*Martes pennanti*).
- Connelly, J.W., M.A. Schroeder, A.R. Sands, C.E. Braun. 2000. Guidelines for management of sage grouse populations and habitats. Wildlife Society Bulletin.
- Costick, L.A. 1996. Indexing current watershed conditions using remote sensing and GIS. In Sierra Nevada Ecosystem Project: Final report to Congress, vol. II, chap. 54. Davis: University of California, Center for Water and Wildlands Resources.
- Cox, J., R. Kautz, M. MacLaughlin, and T. Gilbert. 1994. Closing the gaps in Florida's wildlife habitat conservation system. Office of Environmental Services. Florida Game and Fresh Water Fish Commission.
- Crooks, K., and M.E. Soulé. 1999. Mesopredator release and avifaunal collapse in a fragmented system. *Nature* 400:563-566.
- Davis, F. W., D. M. Stoms, A. D. Hollander, K. A. Thomas, P. A. Stine, D. Odion, M. I. Borchert, J. H. Thorne, M. V. Gray, R. E. Walker, K. Warner, and J. Graae. 1998. The California Gap Analysis Project—Final Report. University of California, Santa Barbara, CA.
- Debinski, D., and R. Holt. 2000. A survey and overview of habitat fragmentation experiments. *Conservation Biology* 14(2): 342-355.
- Duane, T.P. 1996. Human settlement, 1850-2040. In Sierra Nevada Ecosystem Project: Final report to Congress, vol. II, chap. 54. Davis: University of California, Center for Water and Wildlands Resources.

- Ehrlich, P.R. and A.H. Ehrlich. 1981. *Extinction: the cause and consequence of the disappearance of species*. New York: Random House.
- Erman, N.A. 1996. Status of aquatic invertebrates. In *Sierra Nevada Ecosystem Project: Final report to Congress*, vol. II, chap. 33. Davis: University of California, Center for Water and Wildlands Resources.
- Estes, J.A., N.S. Smith, and J.F. Palmisano. 1978. Sea otter predation and community organization in the western Aleutian Islands, Alaska. *Ecology*. 75:822-833.
- Foreman, D., Dugelby, B., Humphrey, J., Howard, R., Johns, D., Mondt, R. Implementation of a Wildlands Network: An Example from the Sky Islands.
- Forman, R.T. 1995. *Land mosaics: the ecology of landscapes and regions*. Cambridge University Press. UK.
- Forman, R. T. T. and L. E. Alexander. 1998. Roads and their major ecological effects. *Annual Reviews of Ecology and Systematics* 29: 207-231.
- Franklin I.R. 1980. Evolutionary change{s?} in small populations. - In: Soulé M.E., Wilcox B.A. (eds.). *Conservation Biology: An Evolutionary-Ecological Perspective*. Sunderland (Mass.): Sinauer Associates, 61-78.
- Franklin, J.F., and J.A. Fites. 1996. Assessment of late-successional forests of the Sierra Nevada. In *Sierra Nevada Ecosystem Project: Final report to Congress*, vol. II, chap. 15. Davis: University of California, Center for Water and Wildlands Resources.
- Friends of the Inyo et al. 1999. Petition for a rule to list the Sierra Nevada bighorn sheep as endangered throughout its range, with a special request for emergency action. Unpublished report.
- Graber, D.M. 1996. Status of terrestrial vertebrates. In *Sierra Nevada Ecosystem Project: Final report to Congress*, vol. II, chap. 33. Davis: University of California, Center for Water and Wildlands Resources.
- Gutierrez, R.J., A.B. Franklin, and W.S. Lahaye. 1995. Spotted Owl (*Strix occidentalis*). In *The Birds of North America*, No. 179 (A. Poole and F. Gill, eds.). The Academy of Natural Sciences, Philadelphia, and The American Ornithologists' Union, Washington, D.C.
- Harris, L.D. and P.B. Gallagher. 1989. New initiatives for wildlife conservation: the need for movement corridors. Pages 11-34 in G. Mackintosh, editor. *Preserving communities and corridors*. Defenders of Wildlife, Washington D.C.
- Helms, J., and J. Tappeine. *Silviculture in the Sierra*. 1996. In *Sierra Nevada Ecosystem Project: Final report to Congress*, vol. II, chap. 15. Davis: University of California, Center for Water and Wildlands Resources.
- Holland, R.F. 1986. *Preliminary descriptions of the terrestrial natural communities of California*. CA: Department of Fish and Game. Sacramento, CA.
- Hopkins, R.A. 1990. Bighorn sheep. In *California Wildlife Habitat Relationships System*. California Department of Fish and Game, Sacramento, CA.

- ICBEMP (Interior Columbia Basin Ecosystem Management Project). 2000. Final Environmental Impact Statement. USDA Forest Service and USDI Bureau of Land Management, Interior Columbia Basin Ecosystem Management Project.
- Interagency Sage-Grouse Planning Team. 2000. Greater sage-grouse and sagebrush-steppe ecosystems: Management guidelines. Bureau of Land Management.
- Jackson, S. 1999. Overview of transportation related wildlife problems. In Evink, G.L., P. Garrett and David Zeugler, eds. Proceedings of the Third International Conference on Wildlife Ecology and Transportation. FL-ER-73-99. Florida Department of Transportation. Tallahassee, Florida. 330pp.
- Jennings, M.R. 1996. Status of amphibians. In Sierra Nevada Ecosystem Project: Final report to Congress, vol. II, chap. 15. Davis: University of California, Center for Water and Wildlands Resources.
- Jeo, R.M., M.A. Sanjayan, and Dennis Sizemore. 1999. A Conservation Area Design for the Central Coast Region of British Columbia, Canada. Round River Conservation Studies. Salt Lake City, UT.
- Jones & Stokes Associates, Inc. 1987. Sliding towards extinction: the state of California's natural heritage. The California Nature Conservancy. San Francisco, CA.
- Knapp, R.A. 1996. Non-native trout in natural lakes of the Sierra Nevada: An analysis of their distribution and impacts on native aquatic biota. In Sierra Nevada Ecosystem Project: Final report to Congress, vol. II, chap. 15. Davis: University of California, Center for Water and Wildlands Resources.
- Koenig, W.D., P.B. Stacey, M.T. Stanback, and R.L. Mumme. 1995. Acorn woodpecker (*Melanerpes formicivorus*). In A. Poole and F. Gill, eds. The Birds of North America, No. 194. The Academy of Natural Sciences, Philadelphia, and The American Ornithologists' Union, Washington, D.C.
- Koenig, W.D., and J. Haydock. 1999. Oaks, acorns, and the geographical ecology of acorn woodpeckers. *Journal of Biogeography*. 26(1):159-165.
- Kondolf, G.M., R. Kattelman, M. Embury, and D.C. Erman. Status of riparian habitat. 1995. In Sierra Nevada Ecosystem Project: Final report to Congress, vol. II, chap. 36. Davis: University of California, Center for Water and Wildlands Resources.
- Kotliar, N.B. 2000. Application of the new keystone-species concept to prairie dogs: how well does it work? *Conservation Biology* 14(6):1715-1721.
- Lambeck, R. 1997. Focal species: a multi-species umbrella for nature conservation. *Conservation Biology* 11:4:849-856.
- Laymon, S.,A. 1989. Altitudinal migration movements of spotted owls in the Sierra Nevada, California. *Condor* 91:837-841.
- Levien, L., C. Fisher, P. Roffers, and B. Maurizi. 1999. Monitoring landcover changes in California: A USFS and CDF Cooperative Change Detection Program. Southern Sierra Nevada Project Area. USDA Forest Service, Pacific Southwest Region.

- MacDonald, L., and S. Smith. 1999. Bridge replacements: an opportunity to improve habitat connectivity. In Evink, G.L., P. Garrett and David Zeugler, eds. *Proceedings of the Third International Conference on Wildlife Ecology and Transportation*. FL-ER-73-99. Florida Department of Transportation. Tallahassee, Florida. 330pp.
- Matroni, R. S., D. A. Airola, R. K. Marose, and N. D. Tasta. 1991. Using wildlife species richness to identify land protection priorities in California's hardwood woodlands. Pages 110-119 in R. B. Standiford (tech. coord.), *Proceedings of the Symposium on Oak Woodlands and Hardwood Rangeland Management*.
- McBride, J.R., W. Russell, and S. Kloss. 1996. Impact of human settlement on forest composition and structure. In *Sierra Nevada Ecosystem Project: Final report to Congress*, vol. II, chap. 33. Davis: University of California, Center for Water and Wildlands Resources.
- Messier, F. 1994. Ungulate population models with predation: a case study with the North American moose. *Ecology* 75(2):478-488.
- Moyle, P.B., and J.P. Ellison. 1991. A conservation oriented classification system for the inland waters of California. *California Fish and Game* 77:161-80.
- Moyle, P.B, R.M. Yoshiyama, and R.A. Knapp. 1996. Status of Fish and Fisheries. In *Sierra Nevada Ecosystem Project: Final report to Congress*, vol. II, chap. 33. Davis: University of California, Center for Water and Wildlands Resources.
- Moyle, P.B., and P.J. Randall. Biotic integrity of watersheds. 1996. In *Sierra Nevada Ecosystem Project: Final report to Congress*, vol. II, chap. 34. Davis: University of California, Center for Water and Wildlands Resources.
- Mychasiu, L. and M. Haefs. 1988. Access-related impacts of back country roads to wildlife and management approaches to mitigate them. Habitat and Research Section, Fish and wildlife Branch, Yukon.
- Newmark, W.D. 1985. A land-bridge island perspective on mammalian extinctions in western North American parks. *Nature* 325:430-432.
- Newmark, W.D. 1995. Extinction of mammal populations in western North American National Parks. *Conservation Biology* 9(3): 512-526.
- Nichols, M. 2001. First draft report on the methodology to identify state conservation priorities. California Resources Agency. Sacramento, CA.
- Noss, R.F. 1985. Wilderness recovery and ecological restoration: An example for Florida. *Earth First!* 5(8):18-19.
- Noss, R.F. 1987. Protecting natural areas in fragmented landscapes. *Natural Areas Journal* 7:2-13.
- Noss, R. F. 1991. Landscape linkages and biodiversity. W. E. Hudson. Washington, D.C. pp.27-39.
- Noss, R.F. 1992. The Wildlands Project: Land conservation strategy. *Wild Earth (Special Issue)* 1:10-25.

- Noss, R.F. 1983. A regional landscape approach to maintain diversity. *BioScience* 33(11):700-706.
- Noss, R.F. and A.Y. Cooperider. 1994. *Saving Nature's Legacy: Protecting and Restoring Biodiversity*. Island Press, Covelo, CA.
- Noss, R.F., and B. Csuti. 1994. Habitat fragmentation. In G.K. Meffe and C.R. Carroll, eds. *An introduction to conservation biology*. Sinauer, Sunderland, MA.
- Noss, R.F., H.B. Quigley, M.G. Hornocker, T. Merrill, and P.C. Paquet. 1996. Conservation biology and carnivore conservation in the Rocky Mountains. *Conservation Biology* 10:949-63.
- Noss, R.F., M.A. O'Connell, and D.D. Murphy. 1997. *The science of conservation planning*. Island Press, Washington, D.C.
- Noss, R.F., J.R. Strittholt, K. Vance-Boreland, C. Carroll, and P. Frost. 1999. A conservation plan for the Klamath-Siskiyou Ecoregion. *Natural Areas Journal* 19(4):392-411.
- Noss, R.F., E. Dinerstein, B. Gilbert, M. Gilpin, B.J. Miller, J. Terborgh, and S. Trombulack. 1999. Core areas: where nature reigns. Soulé, M.E. and J. Terborgh. eds. *Continental conservation: scientific foundations of regional reserve networks*. Island Press, Washington, D.C.
- Obbard, M. E. 1987. Fur grading and pelt identification. In M. Novak, J. A. Baker, and M. E. Obbard, comps and eds. *Wild furbeaerer management and conservation in North America*. Ch. 53, pp. 717-826. Toronto: Ontario Ministry of Natural Resources.
- O'Gara, B.W., and J.D. Yoakum, eds. 1992. *Pronghorn management guides: A compendium of biological and management principles and practices to sustain pronghorn populations and habitat from Canada to Mexico*. 15th Biennial Pronghorn Antelope Workshop. Rock Springs, WY. 101 pp.
- Olson, D.M., and E. Dinerstein. 1998. *The global 200: a representation approach to conserving Earth's distinctive ecoregions*. World Wildlife Fund. Washington, D.C.
- Paquet, P.C. 1993. Summary reference document - ecological studies of recolonizing wolves in the Central Canadian Rocky Mountains. Prepared by John/Paul & Associates for Canadian Parks Service. Banff National Park Warden Service, Banff, Alberta. 118pp.
- Paquet, P.C., and A. Hackman. 1995. *Large carnivore conservation in the Rocky Mountains*. World Wildlife Fund Canada and World Wildlife Fund U.S., Toronto, Ontario, and Washington, D.C.
- Paquet, P. C, J. Wierzchowski, and C. Callaghan. 1996. Effects of human activity on gray wolves in the Bow River Valley, Banff National Park, Alberta. Chapter 7 in J. Green, C. Pacas, S. Bayley and L. Cornwell, editors. *A Cumulative Effects Assessment and Futures Outlook for the Banff Bow Valley*. Prepared for the Banff Bow Valley Study, Department of Canadian Heritage, Ottawa, ON.
- Penrod, K., R. Hunter, and M. Merrifield. 2000. *Missing Linkages: Restoring Connectivity to the California Landscape*, Conference Proceedings. California Wilderness Coalition, The Nature Conservancy, US Geological Survey, Center for Reproduction of Endangered Species, and California State Parks.



- Poiani, K.A., J.V. Baumgartner, S.C. Buttrick, S.L. Green, E. Hopkins, G.D. Ivey, K.P. Seaton, and R.D. Sutter. 1998. A scale-independent, site conservation planning framework in The Nature Conservancy.
- Power, M.E., D. Tilman, J.A. Estes, B.A. Menge, W.J. Bond, L.S. Mills, G. Daily, J.C. Castilla, J. Lubchenco, and R.T. Paine. 1996. Challenges in the quest for keystones. *BioScience* 46:609-620.
- Powell, R.A. and W.J. Zielinski. 1994. Fisher. In Ruggiero, L.F., K.B. Aubry, S.W. Buskirk, L.J. Lyon, and W.J. Zilinski, eds. The scientific basis for conserving forest carnivores: American marten, fisher, lynx, and wolverine in the western United States. Gen. Tech. Rep. RM-254. U.S. Forest Service, Rocky Mountain Forest and Range Experiment Station.
- Pyshora, L. 1977. The pronghorn antelope in northeastern California. Wildlife Management Administrative Report No. 77-2. California Department of Fish and Game, Sacramento, CA.
- Reynolds K., P. Cunningham, and L. Bednar. 1996. A design framework for a knowledge-based information management system for watershed analysis in the Pacific Northwest U.S. AI Applications. 10:9-22.
- Reynolds K. 1999. Netweaver for EMDS user guide (version 1.1); a knowledge base development system. Gen. tech. Rep. PNW-GTR-471. Portland, OR: U.S. Department of Agriculture, Forest Service, Pacific Northwest Research Station.
- Rubinoff, D. In press. Evaluating the California Gnatcatcher as an Umbrella Species for conservation of Coastal Sage Scrub. *Conservation Biology*.
- Saunders, M.C., R.N. Coulson, J. Folse. 1990. Applications of artificial intelligence in agriculture and natural resource management. In Kent, A., Willeams, J., eds. *Encyclopedia of computer science and technology: volume 25*.
- Schonewald-Cox, C.M. 1983. Conclusions. Guidelines to management: a beginning attempt. Pages 141-145 in C.M. Schonewald-Cox, S.M. Chambers, B. MacBryde, and W.L. Thomas eds. "Genetics and Conservation: a reference for managing wild animal and plant populations." Benjamin/Cummings, Menlo Park, CA.
- Schonewald-Cox, C.M., and J.W. Bayless. 1986. The boundary mode: a geographic analysis of design and conservation of nature reserves. *Biological Conservation* 38:305-322.
- Schwartz, M.W., D.J. Porter, J.M. Randall, and K.E. Lyons. 1996. Impacts of non-indigenous plants. In *Sierra Nevada Ecosystem Project: Final report to Congress, vol. II, chap. 33*. Davis: University of California, Center for Water and Wildlands Resources.
- Scott, J.M., B. Csuti, J.D. Jacobi, and J.E. Estes. 1987. Species richness: a geographic approach to protecting future biological diversity. *Bio Science* 38(11):782-788.
- Scott, T.A., R. Standiford, and N. Pratini. 1995. Private landowners critical to saving California's biodiversity. *California Agriculture* 49(6)50-54.

- Shevock, J.R. 1996. Status of rare and endemic plants. In Sierra Nevada Ecosystem Project: Final report to Congress, vol. II, chap. 33. Davis: University of California, Center for Water and Wildlands Resources.
- Shore, T. 2001. *Off-road to ruin: How motorized recreation is unraveling California's landscapes*. California Wilderness Coalition, Davis, CA.
- Sierra Business Council. 1997. *Planning for prosperity: Building successful communities in the Sierra Nevada*. Sierra Business Council, Truckee, Ca.
- Smith, D. 1999. Identification and prioritization of the ecological interface zones on state highways in Florida. In Evink, G.L., P. Garrett and David Zeugler, eds. *Proceedings of the Third International Conference on Wildlife Ecology and Transportation*. FL-ER-73-99. Florida Department of Transportation. Tallahassee, Florida. 330pp.
- SNNER (Sierra Nevada Network for Education and Research). 1999. *Proceedings from workshop: Sociological and ecological effects of roads in the Sierra Nevada*. Unpublished report.
- Soulé, M.E. 1999. An unflinching vision: networks of people for network of wildlands. *Wild Earth* 9(4)38-46.
- Soulé, M.E. and J. Terborgh. eds. 1999. *Continental Conservation: Scientific foundations of regional reserve networks*. Island Press, Covelo, CA.
- Storer, T. I., and L. P. Tevis, Jr. 1955. *California grizzly*. University of California Press, Berkeley, CA.
- Strickland, M.A. and C.W. Douglas. 1987. Marten. In Novak, M., J.A. Baker, M.E. Obbard, and B. Malloch, eds. *Wild furbearer management and conservation in North America*. Ontario Trappers Association. North Bay, Ontario.
- The Nature Conservancy. 2000. *The five-s framework for site conservation: a practitioner's handbook for site conservation planning and measuring conservation success*. Vol.1, 2nd ed.
- Trombulak, S. C. and C. A. Frissell. 2000. Review of ecological effects of roads on terrestrial and aquatic communities. *Conservation Biology* 14(1):18-30.
- USDA Forest Service. 1990. *General Technical Report PSW 126*. U.S. Forest Service, Pacific Southwest Research Station. Berkeley, CA.
- USDA Forest Service. 2000. *Forest carnivore landscape habitat index and emphasis areas*. Sierra Nevada Forest Plan Amendment: Final Environmental Impact Statement. Volume 4, Appendix B-18-23. U.S. Forest Service, Pacific Southwest Region. Berkeley, CA.
- USDA Forest Service. 2001. *Sierra Nevada Forest Plan Amendment: Final Environmental Impact Statement, Record Of Decision*. U.S. Forest Service, Pacific Southwest Region. Berkeley, CA.
- Verner, J. , K.S. McKelvey, B.R. Noon, R.J. Gutierrez, G.L. Gould, Jr., and T.W. Beck, Technical Coordinators. 1992. *The California spotted owl: A technical assessment of its current status*. Gen. Tech. Rep. PSW-GTR-133. U.S. Forest Service, Pacific Southwest Research Station, Berkeley, CA.

Walker, R.E. 1992. Community models of species richness: Regional variation of plant community species composition on the west slope of the Sierra Nevada California. Master's thesis, Department of Geography, University of California, Santa Barbara, CA.

White, J. S. and W. B. Barrett. 1979. A review of the wolverine in California with recommendations for management. San Francisco: USDA Forest Service.

Wilcox, B.A. and D.D. Murphy. 1985. Conservation strategy: the effects of fragmentation on extinction. *American Naturalist* 125:879-87.

Wild Earth. 2000; Special Issue: The Wildlands Project 43-45.

Wilson, E.O. 1992. *The Diversity of Life*. W.W. Norton and Company, New York, NY.

Zeiner, D.C., W.F. Laudenslayer Jr., and K.E. Mayer, compiling eds. 1988. California's wildlife, vol.II, Birds. California Department of Fish and Game, Sacramento, CA.

Ziener, D.C. 1990. California's wildlife, vol. III, Mammals. California Department of Fish and Game, Sacramento, CA.

— *Appendices* —



## Appendix A

### Summary of Maps

#### *Map 3. Forest Integrity*

Forest Integrity defines relative forest habitat quality and is composed of three attributes: presence of old growth forests, patch size, and recent forest fires. Planning units of 500m<sup>2</sup> were analyzed using the Ecosystem Management Decision Support (EMDS) extension for ArcView GIS©. Higher Forest Integrity values indicate greater potential of intact forests.

#### *Map 4. Terrestrial Habitat*

Terrestrial Habitat defines relative terrestrial habitat quality and is composed of two attributes: species richness and potential suitable wildlife habitat. Planning units of 500m<sup>2</sup> were analyzed using the Ecosystem Management Decision Support (EMDS) extension for ArcView GIS©. Higher Terrestrial Integrity values indicate greater potential of wildlife habitat quality.

#### *Map 5. Aquatic Integrity*

Aquatic Habitat Integrity represents relative aquatic habitat quality and is composed of three attributes: influence of dams, road impact, and presence of aquatic fauna. Planning units of 500m<sup>2</sup> were analyzed using the Ecosystem Management Decision Support (EMDS) extension for ArcView GIS©. Higher Aquatic Integrity values indicate greater potential of intact aquatic habitats.

#### *Map 6. Wildland Integrity*

Wildland Integrity defines relative wildland quality and is composed of four attributes: wildlife habitat quality, terrestrial vertebrate habitat integrity, forest integrity, and aquatic integrity. Planning units of 500m<sup>2</sup> were analyzed using the Ecosystem Management Decision Support (EMDS) extension for ArcView GIS©. Higher Wildland Integrity values indicate greater potential of intact and suitable wildlife habitat.

#### *Map 7. SITES model results*

This map shows the sites selected by the SITES model for achieving plant community representation goals and focal species habitat.

***Map 8. Habitat Threat Potential***

Habitat Threat Potential represent both actual and potential disturbance to wildlands based on the analysis of three attributes: actual developed (population density), threat potential (road density, land management, and ownership edge density), and threatened habitat (density of streams and underrepresented plant communities). Planning units of 500m<sup>2</sup> were analyzed using the Ecosystem Management Decision Support (EMDS) extension of ArcView GIS©.

***Map 9. Wildland Conservation Plan***

*(Three perspectives: A. Sierra Nevada bioregion, B. North section, C. South section)*

Wildland Conservation Areas represent areas of high ecological importance for protecting wildlife habitat, wildland attributes, and plant communities. They were identified using the SITES model with data on Wildland Integrity, land ownership, and plant community distribution. Planning units consist of intersected vegetation, 6<sup>th</sup> order planning watersheds, GAP ownership and Jepson boundaries.

Wildland Linkages represent potential wildlife movement paths between Wildland Conservation Areas. They were identified using Least-Cost Path analysis and the Wildland Integrity model in ArcView GIS©.

Stewardship Zones represent potential high quality wildlands important for buffering Wildland Conservation Areas from intensive human activities. They may also be used to select additional conservation sites. This data was derived from the Wildland Integrity model created using the Ecosystem Management Decision Support (EMDS) extension of ArcView GIS©.



## Appendix B

### Focal Species Profiles

#### OVERVIEW

Focal species profiles are brief descriptions of natural history and threats to the ten focal species used in this iteration of the Wildlands Conservation Plan. Table 1 identifies additional focal species that have been identified through a focal species selection process and could be addressed in future iterations of the plan.

#### GRAY WOLF

##### FAMILY CANIDAE

*Canis lupus*

##### Overview of status and natural history

In the eyes of both modern and traditional conservation movements, the wolf has long been regarded as a symbol of healthy ecosystems. Considered a classic top-down regulator in predator-prey ecology, the gray wolf serves a keystone role in areas it inhabits. Mule deer, an historic prey of the wolf in California, has sufficient densities to support gray wolf populations in areas of the Sierra and Modoc Plateau (Carroll et al. 2000). The absence of the gray wolf in California has altered delicate and complex predator-prey relationships. This imbalance may be linked to the surge of coyote population densities statewide. Coyotes have established high population densities where they were historically low or absent. Coyotes are known to compete and predate on mesopredators such as the San Joaquin kit fox, a federally endangered species and indicator of healthy grassland ecosystems (O'Farrell 1984, Schmidt 1991).

Once well distributed throughout California, the gray wolf was presumably present where its prey (deer, elk, prong horn, bighorn sheep) were in greatest density (Schmidt 1991). It is commonly believed the last California gray wolf was shot by a rancher in the mid-1920's upon the Modoc Plateau (Grinnell et al. 1937). This record may mark the coup d'grâce for the California wolf population during a federally sponsored predator control campaign against native large carnivores. Interestingly, in 1939, six National Forests in California reported estimated wolf numbers, which ranged from 5 to 16 (Schmidt 1991). Eventually, the wolf was evicted from California, then Oregon. This may correlate with human settlement patterns of the areas in the 1800 and 1900s (Carroll et al. 2000). Human encroachment on wolf territories is not likely the direct cause for wolf decline as much as the predators control campaign. Babbitt's 'symbol of things American regard wild' is Federally Endangered, which speaks quite a bit for itself.

Wolves are thought to be prey generalists with complex habitat selection in response to population density, available prey, and insulation from humans (Carroll et al. 2000). In western states, principal prey species of the wolf are the mule deer and elk. Competition has long known to exist amongst wolves, coyotes, and bears for territory and somewhat, for prey. Wolf home ranges are generally very large, but vary in response to prey availability (Huggard 1993).

##### Threats

Direct mortality from roads and predator control actions will continue to deter wolf populations from expanding in western states. Wolf road mortality reduces wolf populations more than other forms of wolf-human conflict (Mech 1989). Although wolves may exhibit behavioral flexibility when among low density human settlements, minimizing encounters between wolves, high traffic roads, or livestock will improve the lifespan of entire wolf packs, and should be addressed in site specific planning (Paquet and Hackman 1995). Human attitudes, especially fears related to livestock loss should be addressed with economic incentives and education.

**WOLVERINE**

## FAMILY MUSTELIDAE

*Gulo gulo***Overview of status and natural history**

Known populations of wolverine have not been recorded in the Sierra Nevada for approximately 60 years, when the last official sighting was recorded in the southern Sierra (Grinnell et al. 1937). Although anecdotal sightings of wolverine persist, and are documented on Forest Service records as recently as 1991, the likelihood of a viable wolverine population in the Sierra wilderness is bleak. Due to the species low density across large areas and presumed sensitivity to human presence, the wolverine likely has been affected by trapping, roads, and recreational impacts. Possibly the Wilderness Act of 1964 that restricted trapping, logging, and motorized recreation in much of timberline habitat in the southern Sierra came too late for the wolverine. Restoring the wolverine to its former range in the Sierra could occur through establishment of new wilderness areas in the northern Sierra, Cascade Ranges, and Modoc Plateau. Our methodology identifies options for core areas as well as connectivity zones to link them.

A state listed mammal, the wolverine is considered threatened in its former range in California. Historic concepts of wolverine distribution do not recognize the suitable wolverine habitat found in the Modoc Plateau (Carroll et al. 2000), but do include most of the Sierra Nevada bioregion. The true causes of the wolverine's retreat from the Sierra have not been thoroughly investigated and can therefore only be speculated. Such speculations range from mortality effects from decades of trapping and carrion poisoning during the wolf extirpation campaign (Banci 1994).

Wolverines are area limited carnivores of the Mustelidae family whose life histories are dependent upon wilderness values of large, roadless, and insulated landscapes. Wolverines are known to thrive at very low densities within large home ranges, 40 – 800 (Banci 1994). Wolverines have been known to prey on mammals from porcupine to ungulates (Banci 1994). Habitat preferences of the wolverine are believed to be tied to sparsely inhabited areas with a year round food supply than to habitat associations, such as sub-alpine or boreal forests (Banci 1994).

**Threat**

Road development on private lands will increase with human population growth in the Sierra. Roads will continue to be barriers to wildlife movement as well as sources of mortality. Unpaved roads on public lands that encroach upon roadless areas and designated wilderness may reduce the suitability of these areas for the wolverine. Existing roads in areas of the high Sierra backcountry bring motorized recreation to the heart of wolverine territory, making restoration problematic.

**PACIFIC FISHER**

## FAMILY MUSTELIDAE

*Martes pennanti pacifica***Overview of status and natural history of Pacific Fisher**

The Pacific Fisher, *Martes pennanti*, is a symbolic species of old-growth fir forests. A mesocarnivore with resource dependency on late seral, complex forests, and limited dispersal across open habitat (Powell and Zielinski 1994), the fisher is particularly sensitive to a multitude of human caused disturbances. Poor forestry practices may likely account for the fisher's decline from most of its Sierra range, essentially a north and south range retraction from the central Sierra. For these reasons, the fisher is useful in landscape planning as it indicates old growth habitat conditions (Miller et al. 1999, Carroll et al. 1999).

The Pacific fisher is listed as a federal species of concern and a state species of special concern. Fisher population densities in the Sierra have seriously declined in the past decades. Presently, the California fisher population is isolated in two separate populations, a coast range mountain and southern Sierra population (Zielinski et al. 1995, Truex et al. 1998). These populations are quite distinct from one another in two ways, (1) a 400km gap separates them, and (2) the northwestern fisher population seems viable over the long term, while the southern Sierra fisher population is considered unviable over the long term (Truex et al. 1998, Lamberson et al. 2000). The southern Sierra fisher population remains imperiled and isolated in areas of Yosemite National Park, Sequoia National Forest, and Sequoia National Park. The number of individuals in the southern Sierra is estimated to range between 100-500 individuals (Lamberson et al. 2000). Fisher populations within Yosemite National Park are currently being monitored and their habitat parameters studied (R. Truex, pers comm). Data from this research will be vital in developing a recovery strategy for the fisher in the national forests of the Sierra.

In western states, fisher home range size is known to average at 15 for female, and 40 for males (Powell and Zielinski 1994). Fisher requirements for large, well insulated core areas with canopied forest linkages for dispersal is well documented (Powell and Zielinski 1994, Carroll et al. 1999). The fisher is a generalist predator whose diet may range from small birds, carrion, and medium-sized mammals (Powell 1993). Fishers in the Sierra are known to inhabit old-growth fir, pine, and occasionally mixed hardwood-pine between approximately 2,500 - 7000'. Denning sites are characterized by cavities in large trees or snags (Powell and Zielinski 1994). In the Sierra, fisher dispersal corridors should contain at least 40% canopy closure (Barrett 2000).

## **MARTEN**

### **FAMILY MUSTELIDAE**

*Martes americana*

#### **Status of Marten**

Marten distribution in the Sierra Nevada ranges beyond the fisher's distribution into pine and fir forests in the eastern Sierra and Modoc Plateau. The last marten trapping season in California was in 1952 (Buskirk and Ruggiero 1994). Knowledge of marten population levels in Sierra Nevada is not well known beyond individual forest jurisdictions. Track plate and camera surveys have resulted in marten occurrences in the north and central Sierra (R. Truex, pers. comm). Marten populations in the Sierra are not known to be at seriously low levels or in decline, although their denning habitat, late seral, well canopied, fir and pine forests are in a state of decline. Further population level studies should be investigated to monitor martens in the Sierra.

#### **Threats**

Logging of large diameter conifer and fir trees in public forests has likely made the most impact of the marten population in the past decades. The north and central Sierra are the most hard hit areas by logging, and presently maintain a dysfunctional system of isolated patches of old growth forests. This landscape condition will only worsen in the coming decade, long before any marten restoration and reintroduction efforts are underway. Checkerboard ownership in the central Sierra hampers management of national forests to effectively promote contiguous old growth habitat for forest carnivores. Beyond forest management issues, designated wilderness areas in the Sierra Nevada are not well represented across elevation gradients and therefore do not adequately protect mid-elevation fir and pine old growth.

**CALIFORNIA SPOTTED OWL**

## FAMILY STRIGIDAE

*Strix occidentalis occidentalis***Overview of status and natural history**

The California spotted owl is dispersal-limited with selective use of multiple habitats, typically those of well canopied old-growth (Verner et al. 1992). The owl is useful in planning for multiple habitats, their quality, and connectivity, as it is considered a habitat specialist (Lambeck 1997, Guitierrez et al. 1992). As old-growth mixed-conifer, fir, and hardwood forests decline throughout the Sierra range (Franklin and Fites-Kaufman 1996), the California spotted owl is a reasonable indicator for protecting and restoring these habitats in the Sierra. The owl is also a recognized management Indicator Species of the US Forest Service per regulations of the National Forest Management Act of 1976 (Beck et al. 1992).

A federal and state species of special concern, the California spotted owl is holding on precariously to its historic range in the Sierra Nevada. In the 1990's, concern for the Sierra population sparked several population studies of the owl, but due to insufficient field data were unable to identify a population decline in the Sierra Nevada (Verner et al. 1992). Recent demographic data conclusively mark a downward trend of the California spotted owl throughout its Sierra range (Gutierrez et al. 1998, Stegner et al. 1999). Loss of habitat and bottlenecks between remaining habitat are believed to be primary factors in the owl's decline.

The California spotted owl has historically been well distributed throughout California, with its northern boundary in Shasta County, where the California subspecies meet the southern extent of the Northern spotted owl (Verner et al. 1992). In the Sierra Nevada, the California spotted owl historically ranged through the Sierra's westside, south to the Tehachapi Pass (Verner et al. 1992). A resource limited species, the owl prefers old growth forest matrix found in mixed-conifer, hardwood, and riparian-hardwood. These habitats provide a diverse distribution in California, from the Sierra Nevada range to the coastal mountains of the south coasts. The present distribution of the owl in the Sierra Nevada is characterized as having a continuous and relative uniform density (Beck and Gould 1992), ranging from the southern Cascades to the Tehachapis in the south.

Home range size for the owl appears to be well correlated to habitat and prey availability (Verner et al. 1992), and can range from ~300 acres to ~1,500 acres in hardwood and mixed-conifer forests respectively (Zabel et al. 1992). Although the diet of the owl is somewhat diverse, the principle prey species for Sierra population are the dusky-footed woodrat and the flying squirrel (Verner et al. 1992). Seasonal migration is known to occur attitudinally from summer habitat in mixed-conifer forests to winter habitat in hardwood/pine forests (Verner et al. 1992, Laymon 1989).

**Threats**

The primary threat to the California spotted owl population in the Sierra range is direct loss of sufficient and continuous nesting and foraging habitat. These late seral old growth forests throughout the Sierra are greatly reduced from historic abundance and continue to decline (Franklin and Fites-Kaufman 1996). Remaining old-growth reserves are not very large nor are they contiguous. A significant amount of owl habitat is believed to fall on private lands. Privately owned hardwood forests are not recognized in county plans as providing owl wintering habitat and are therefore not protected from development under the California Environmental Quality Act (CEQA). Private forest management in the hardwood wildland-urban interface and disturbances from Forest Service roads should be considered as a vital component in a regional protection strategy for the owl in the Sierra. Disturbance from roads to owl nests or reserves is not well understood, although a study on the Northern spotted owl suggests higher stress to owls closer to roads than those further from roads (Wasser et al. 1997). Lack of uniform management of old growth forests in the checkerboard ownership regions of the central and northern Sierra have been responsible in the owl's decline in the Sierra. If not addressed, this problem will hamper any regional owl recovery strategy.

Beck and Gould (1992) characterize five habitat conditions and areas of concern that require immediate attention if the Sierra population is to be restored from its declining trend toward local extinction. The Center for Biological Diversity (2000) refined these Areas of Concern using updated owl occurrence data to support their assertion for listing the species under the Endangered Species Act, which would mandate the large scale habitat management and restoration that is needed. Areas of Concern for the Sierra population of the California spotted owl address the following regional conditions: (1) bottlenecks in the distribution of habitat or owl populations, (2) gaps in known distribution of owls, (3) locally isolated populations, (4) highly fragmented habitat, and, (5) areas of low crude density of spotted owl.

## ACORN WOODPECKER

### FAMILY PICIDAE

*Melanerpes formicivorus*

#### Overview of status and natural history

The acorn woodpecker is considered an oak obligate species. It is highly specialized for harvesting, storing, and defending caches of acorns, and not surprisingly, its distribution and abundance are affected by the predictability of acorn crops. It is resident in lower elevation oak woodlands on the west side of the Sierra Nevada, where it is dependent on acorns for supplemental food when winter conditions render insects, its primary prey, unavailable. The northern geographic limit of this species coincides with those areas where oak diversity drops to one common species (Bock and Bock 1974). Mean population size of acorn woodpeckers in California is determined by oak abundance, while annual variability in population size is determined by oak species number. When more than 4 species of oak are present, acorn crops occur virtually every year, and woodpeckers presumably remain at or near carrying capacity, buffered from catastrophic resource limitation (Bock and Bock 1974, Koenig and Haydock 1999).

Central to this species' ecology and behavior is the granary tree, in which the woodpeckers excavate holes, fill each with an acorn, and consume them later. A large granary tree may contain from a few to as many as 50,000 holes. Granaries are traditional, and large ones may represent the work of dozens of generations of the woodpeckers drilling for more than 100 years. Acorn woodpeckers live in cooperatively breeding groups of 2-15 individuals (average 4.4 adults) that exhibit delayed dispersal and helping behavior, both thought to have evolved as a result of dependence on granaries. Mast stores play a critical role in allowing breeding groups of acorn woodpeckers to remain on territories during the winter, when few alternative food sources are available. In California, the fate of acorn woodpecker family groups is closely tied to local acorn production; years of low mast are followed by less productive breeding seasons (Koenig and Mumme 1987). On average, acorn woodpecker breeding groups maintain 2.1 granary trees (range 1-7) per 6 ha territory (MacRoberts and MacRoberts 1976). In cases where a granary is exhausted, acorn woodpeckers will abandon their territory to search for alternative food, and widespread mast failure can cause permanent disappearance of a large proportion of the woodpecker population.

Acorn woodpecker dispersal distances are usually small, averaging 0.34 km for males and 0.48 for females (Koenig and Mumme 1987). But radiotelemetry of non-breeders in California (Hooge 1995) revealed that they can regularly make forays (primarily searching for reproductive vacancies) up to 15 km from their natal territory, and that mean dispersal distance of radio-tagged females was 6.1 km. Acorn woodpeckers are relatively good colonizers, regularly found outside their normal range, sometimes far from breeding habitat, although usually within 200 km of known populations. Population establishment near Independence, Inyo County, CA, and east across the Sierra Nevada near Susanville, Lassen County, CA (Small 1994) exemplifies this behavior.

### Threats

Damage from cattle grazing in pine-oak woodlands and montane riparian areas may threaten some populations of acorn woodpeckers. Low recruitment of new oaks on intensively grazed land will likely not sustain populations of woodpeckers in the future, and may already have contributed to population declines (CPIF 2000).

Land conversion from oak woodland to other uses can affect acorn woodpecker populations if adequate food resources are compromised. Managers should maintain large tracts of land that include a natural diversity of oak species or intraspecific oak varieties with different seeding phenologies, in order to avoid synchronous or wide scale acorn crop failures (CPIF 2000). Current woodpecker population levels may rely on a diverse age structure of oak trees and this structural heterogeneity should also be preserved.

Granary trees, because they are dead or have many dead limbs and are easier to bore into, are also vulnerable to fire-wood cutters. Managers should maintain a high density of snags and dead tree limbs (17 to >100 cm diameter), or soft-wooded live trees such as pines or sycamores (35 granary trees/100 ha, or 1 snag every 2.86 ha).

Competition for nest cavities by the European Starling may affect acorn woodpeckers, especially if the cavity is invaded before woodpecker nest initiation or egg laying. Starlings are most common near human settlement. Therefore, large tracks of oak woodland, away from disturbance, should be maintained wherever possible (CPIF 2000).

## GREATER SAGE GROUSE

### FAMILY PHASIANIDAE

#### *Centrocercus urophasianus*

### Overview of status and natural history

The sage grouse is intimately dependent on sagebrush mosaic habitats in western North America. This species occurs throughout foothills, plains, and mountain slopes where sagebrush of virtually any type is present. Unfortunately, little intact sagebrush habitat remains within the range of this species (Braun 1998). Populations of sage grouse began declining in the 1920' and 1930's, presumably due to livestock overgrazing, drought, and overharvesting, and declines continue to the present, due to cumulative loss and degradation of sagebrush habitats. The geographic distribution of sage grouse has contracted approximately 50% since European settlement and the species has been extirpated from 5 states and 1 province (Braun 1998).

In California, the species still inhabits sagebrush habitats in the Modoc Plateau and Eastside regions, and the status of these populations are of concern, even though they are peripheral. Management plans for California populations of sage grouse are currently under development by two interagency technical working teams, one focusing on grouse in adjacent habitats in northeastern California, southern Oregon, and northeastern Nevada, and the other on grouse in Mono and Inyo Counties, CA, and adjacent sections of Nevada (S. Blankenship, pers.com.). Until the management plans are finished, two documents are used as guidelines for sage grouse management by the Dept. of Fish and Game in California (Connelly et al. 2000, Interagency Sage-Grouse Planning Team 2000). Sage grouse populations in Modoc County appear to be a greatest risk, and causes of continuing declines there are currently under investigation. Conservation and stewardship of the species require a landscape perspective, as populations use extensive ranges and occur at low densities across a large geographic area.

Sage grouse habitat can be divided into three types, each used during a discrete portion of the yearly life cycle. Sage grouse require an extensive mosaic of sagebrush of varying densities and heights, high levels of grass cover for nesting, and areas rich in high-protein forbs and insects during nesting and brood-rearing. Grouse typically moves to wetter sites by late summer, and by winter they are entirely dependent on sagebrush for food.



Breeding habitat includes lek sites, and nesting and early brood-rearing habitats. These habitats are defined by sagebrush-dominated rangelands with a healthy herbaceous understory, and are critical for survival of sage grouse populations.

Leks (strutting grounds) typically occur in open areas surrounded by sagebrush, which is used for escape and protection (Connelly et al. 2000). These sites can include old lakebeds, low sagebrush flats, ridge tops, roads, landing strips, cropland, and burned areas (Connelly et al. 1981). The quality of adjacent nesting and brood-rearing habitat may be the most important factor in lek choice. Males appear to form leks opportunistically at sites within or adjacent to potential nesting habitat where female traffic is high (Connelly et al. 2000).

Distances between nest sites and leks average 1.1 to 6.2 km, but females may move up to 20 km from a lek to nest. Nesting and early brood-rearing takes place in sagebrush habitats characterized by 15-25% canopy cover of sagebrush, and a perennial herbaceous understory ((18 cm) of (10% canopy cover of forbs and (15% grasses. Nests are made in thick cover under a sagebrush or other shrub, and are composed of a shallow depression on the ground. Insects are an important component of early brood-rearing habitat, which should comprise a diversity of forbs during the spring (Connelly et al. 2000).

As sage-steppe habitats dry out in summer, sage grouse generally move to more mesic areas that are capable of producing succulent forbs. Such areas include meadows, farmland, dry lakebeds, sagebrush, riparian zones, and irrigated areas adjacent to sagebrush habitats. Although sage grouse have adjusted to altered habitats, including alfalfa, wheat, and crested wheatgrass, the usefulness of these altered habitats depends on their configuration with respect to native habitats (Schroeder et al. 1999). Connelly et al. (2000) recommends protecting all sagebrush habitats occurring within 300 m of these foraging areas.

Access to sagebrush for food and cover in all snow conditions is critical to sage grouse survival during winter. Grouse may move considerable distances to find good habitat and may require winter ranges exceeding 140 square km. Thus, even in winter they need a landscape mosaic of sagebrush of a diversity of canopy cover and heights over hundreds of square km (Connelly et al. 2000). Specific wintering locations for grouse in California are only known for a proportion of the population in Lassen County, 70% of which migrates into Nevada (S. Blankenship, pers. comm). California DFG plans to use radiotelemetry on 18 sage grouse this year to obtain these kinds of data for the birds in Modoc County. Grouse in Mono and Inyo Counties are little studied, and winter data do not yet exist for them.

### **Threats**

Excessive grazing by livestock or wild herbivores in breeding habitat may have negative impacts on sage grouse populations by degrading the grassy understory needed during the breeding season, as well as springs, wet meadows, and riparian areas required during brood-rearing (Connelly et al. 2000).

Reclamation of moist habitats, for example, by diversion of water from riparian zones, can be detrimental to sage grouse during summer and fall, when sagebrush habitats dry out.

Any structures, including trees, power poles, and fences, that provide perches for raptors, may increase mortality due to predation, and have population level impacts.

Human disturbance, and particularly mining and energy development, near lek sites and in other breeding habitats can cause sage grouse to abandon the areas.

Insecticide and herbicide use in or adjacent to brood-rearing areas (e.g., alfalfa croplands) can impact nesting females and broods by reducing availability of insect and forb food. Direct mortality from spraying of organophosphate insecticides on agricultural lands adjacent to sagebrush has been reported in Idaho (Blus et al. 1989).

**BIGHORN SHEEP**

## FAMILY BOVIDAE

*Ovis canadensis***Overview of status and natural history**

Bighorn sheep were formerly widely distributed in at least 92 populations across California, in naturally fragmented habitats in the northeast, the Sierra Nevada, and the Mojave and Sonoran deserts (Bleich et al. 1996). All populations in northeastern California are now extinct, as are at least 11 populations in the Sierra Nevada and 22 populations in the desert mountain ranges.

Bighorn sheep populations appear to be substructured as matrilineal groups, forming natural metapopulations that are inter- and intra-connected by the movement of males among groups and between mountain ranges. Although radiotelemetry has revealed that, in some areas, intermountain movements occur frequently, bighorns have evolved conservative behaviors, probably in response to the fragmented nature of their habitat. For example, successful seasonal migration patterns often become traditional, with one generation teaching the next. Most females occupy relatively predictable home ranges that often are restricted to a limited part of a particular mountain range and may have little or no overlap with ranges of other groups of females (see Bleich et al. 1996). Consequently, natural colonization of new habitats is slow. Population growth rates are also slow, but because bighorns are long-lived and physiologically buffered from short-term environmental changes, populations can persist for long periods even with little recruitment.

Female dispersal, when it does infrequently occur, may average only 7.5 miles. California populations within 15 miles of one another were considered by Bleich et al. (1996) to belong to the same metapopulation, but that view has been recently revised to include all bighorn populations in one regional metapopulation (V. Bleich, pers.com). Interconnectedness of local bighorn populations, and travel routes between them, may have particular import for regional population persistence, especially if local population extirpation occurs at the level proposed by Berger (1990), who concluded that populations of bighorns numbering fewer than 50 will not survive more than 50 years. Indeed, populations of bighorns in southern California are considered to have already become fragmented and isolated by the interstate highway system (Bleich et al. 1996). The challenge now may be to recreate linkages among them. Bleich et al. (1996, p.365) also cautioned that "...small patches of suitable habitat should not be undervalued...". Conservation planning considerations should heed the recommendations of Anthony and Blumstein (2000), that reserves for migratory species must include all areas that the species uses during all seasons.

Bighorns require open areas of low-growing vegetation for feeding in close proximity to precipitous terrain used for escape, lambing, and bedding (CWHR 1990). Such a spatial arrangement allows them to detect predators in time to reach the safety provided by steep and rocky slopes (Sierra Nevada Bighorn Sheep Interagency Advisory Group 1997). Bighorn sheep usually avoid forests and thick brush. In this regard, fire can play an important role in creating bighorn habitat, as well as in making existing patches of habitat safer for them (see Friends of the Inyo et al. 1999, p.5). However, very large open areas without precipitous escape terrain (e.g., Owen's Valley) may "represent substantial barriers to movement" (see Friends of the Inyo et al. 1999). Loss of any critical habitat (lambing and feeding areas, escape terrain, water sources, travel routes) may result in serious decline or loss of populations. The best chance for bighorn recovery lies in protecting critical habitat and encouraging expansion into prime habitat that is currently unoccupied, but adjacent to extant populations.



Two subspecies of bighorn sheep currently inhabit discrete habitat patches in the Sierra Nevada and eastside desert mountain ranges. The geographic distribution of Nelson's Bighorn (*Ovis canadensis nelsoni*), also known as the Desert Bighorn, extends from the White Mountains in Inyo and Mono counties south to the San Bernardino Mountains and southeast to Arizona and Mexico. This subspecies is restricted to the vicinity of water during the hot summer, dispersing at other times of the year (CWHR 1990). Livestock may compete with them for water and for forage. For the purposes of this project, only two populations of Nelson Bighorn are of interest, just east of the Sierra, in the White and Inyo Mountains. However, this subspecies should be incorporated as a focal species in planning for a reserve network in the Mojave and other desert ecoregions.

### Threats

The Sierra Nevada Bighorn Sheep (*Ovis canadensis californiana*) occurs only along the crest and eastside canyons of the central and southern Sierra Nevada (Wehausen 1999), in five extant populations (also referred to as herds), in aggregate now numbering fewer than 150 individuals (Wehausen 1999). Currently designated "endangered" at both federal and state levels, this subspecies is at very high risk of extirpation. The regional population is thought to have numbered at least 1,000 prior to 1850, when bighorns began to be extirpated by unregulated market hunting during the Gold Rush and by diseases contracted from domestic sheep. Fatal pneumonia transmitted by sheep is still a significant cause of Sierra Nevada Bighorn population declines and local extinction, but the most important threat to increasingly small populations of this subspecies during the past 15 years has been predation by mountain lions (*Felis concolor*). In addition to direct impacts, high mountain lion activity in traditional low elevation bighorn ranges that provided nutritious forage and refuge from deep snow has caused the sheep, since the 1980's, to abandon these areas. As a result, they have incurred poor nourishment in late winter and spring (resulting in later lambing and poor lamb survival), as well as exposure to extreme winter environmental conditions, including deep snow and avalanches (Wehausen 1999).

## PRONGHORN

### FAMILY ANTILOCAPRIDAE

#### *Antilocarpa americana*

#### Overview of status and natural history

Prior to the mid-1800's, many tens of thousands of pronghorn inhabited the grasslands, oak woodlands, and sagebrush-steppes of California. Three or four subspecies were represented, including *A. a. americana* in the Central Valley, *A. a. sonoriensis* and *A. a. peninsularis* in the Sonoran Desert and other parts of southern California, and *A. a. oregona* or *A. a. americana* in northeastern California. During the 20 years beginning with the Gold Rush in 1849, pronghorn numbers declined drastically due to market hunting, competition with livestock, conversion of range to agriculture, and other settlement-associated disruptions (CDFG 2000). By 1923, only 1,000 pronghorn remained in the state. Since 1960, the entire California pronghorn population, including several reintroduced populations, has steadily increased to approximately 7,000 animals (with yearly fluctuations apparently resulting from severe weather) due to hunting enforcement and more compatible land management policies. Increased production of alfalfa and grains, water development on public land, and more ecologically sound livestock grazing practices have likely benefited this species in the northeastern part of the state. Population levels in the Modoc Plateau are thought to be stable to increasing, but the relationship of pronghorn in this area to populations outside the state is not known. Pronghorn were reintroduced to historic range in Mono County (north of Mono Lake and at Adobe Valley), beginning in 1947 (Pyshora 1977).

Pronghorn evolved in response to expansive, level or rolling rangelands with low shrub or herbaceous cover. They can run at great speeds (up to 60 mph) in large herds, over rough rocky terrain with no serious injury (morphological adaptations include large hooves, no dew claws, and extremely strong leg bones). They rely on distant visibility for safety, and indeed, their eyesight is said to be the best of any mammal (Pyshora 1977). They also are good swimmers, with at least one being known to have swum 0.8 km across Clear Lake in Modoc County. Even so, natural barriers, such as large lakes and rivers, abrupt escarpments or ridges, thick high shrubs or trees, and deep canyons, affect pronghorn movements and occupancy of habitats.

Pronghorn in California are migratory, with disjunct summer and winter ranges, but the current locations of these areas are not generally known for particular populations. One important wintering area is on the Likely Tablelands, south of Alturas. The most recent maps of pronghorn distribution and winter range in northeastern California were published in 1977 (Pyshora 1977), but the degree to which this information is accurate today is unclear, especially with conversion of some sagebrush habitats to cropland (J. Fischer, CDFG, pers.comm.). Although Pyshora (1977) and O’Gara and Yoakum (1992) made recommendations to protect key winter ranges and kidding grounds, and to obtain more information on migration routes, this has apparently not been done in California. In the northern part of their distribution, pronghorn sometimes move 320 km (200 mi.) in response to deep snow or to reach winter forage. During dry seasons, southern pronghorn need mobility to reach free water and preferred forage. In California, it is likely that pronghorn might move 40-80 km (25-50 miles) seasonally (J. Fischer, CDFG, pers.comm.).

Optimal habitat for breeding contains <20% shrub cover, typically low sage, which loses snow early and provides good spring forage. Sagebrush browse and forbs comprise most of the year-round forage for this species.

### **Threats**

Competition with sheep for food plants has been the most serious threat to pronghorn in northeastern California. Pronghorn increases there since 1960 correspond to decreases in sheep ranching, although cattle grazing seems to have replaced it. Because cattle consume mostly grass, leaving more forbs than sheep, they are thought to be more compatible with pronghorn viability, but the extent to which intense cattle grazing has affected sagebrush ecosystems in the long-term is unknown. In addition, increased competition with feral horses and burros is becoming of greater concern.

Concomitant with sheep ranching is fencing that is intended to contain them, and which usually serves as a barrier to pronghorn. Pronghorn are not good jumpers, and at any rate, are reluctant to do so even when a fence is rather low. This can be a particular problem for kids and yearlings. Any fence that effectively controls sheep will most likely restrict pronghorn movements. Where fencing is deemed necessary in pronghorn range, provision should be made for passage by all pronghorn age classes, during all seasons, and under all climatic conditions. “Critical pronghorn habitats (winter concentration areas, seasonal movement corridors, fawning areas, and water sources) should be designated “problem biological areas requiring specific justification to be fenced.”” (O’Gara and Yoakum 1992). In the 1970’s, right-of-way and range fencing along Highways 395 and 299, near Alturas, Modoc County, caused some crossing problems (Pyshora 1977), but the problem has lessened with the decline in sheep ranching (J. Fischer, CDFG, pers.com.). O’Gara and Yoakum (1992) have recommended detailed fencing standards that allow pronghorn to pass. The extent to which they are actually used in California is unknown, but Modoc county ranchers are thought to be compliant with such protocols.

Railroad tracks can be attractive as snow-free bedding areas for wintering pronghorn in certain areas, and at least one collision between a train and bedded pronghorn has occurred in northeastern California (CDFG 2000).

## MULE DEER

### FAMILY CERVIDAE

*Odocoileus hemionus californicus*

#### Overview of status and natural history

As a primary prey species for top predators such as the mountain lion (*Felis concolor*) and gray wolf (*Canis lupus*), the mule deer is an important focal species for our planning process. Seasonal migration routes from winter to summer habitats are used during the autumn and spring months. Although mule deer migration routes shift over time depending on vegetation and cover availability (Thomas and Irby, 1990), herd management plans by state Fish & Game have approximated migration routes to follow distinct west-slope canyon bottoms (CDFG 1988).

Mule deer herds are common in the Sierra westside foothills, although individual herds have been steadily declining in the past 40 years due to loss of wintering habitat (CDFG, 1998). Habitat loss and conversion from urban and agricultural development are primary threats to mule deer forage and cover habitats in the foothills (CDFG 1998). Cattle are known to compete directly with mule deer for both winter and summer habitats, especially in riparian areas and wet montane meadows (Loft et al. 1991, Loft et al. 1993).

Mule deer in the Sierra respond to seasonal shifts in forage availability, migrating seasonally from higher elevation meadows and forests to lower elevation scrub, grassland, and chaparral during the winter months. With the gray wolf gone from the Sierra, mountain lions are the mule deer's primary predator, maintaining stable populations by following mule deer migrations.

#### Threats

Direct competition between mule deer and cattle is a recognized threat to mule deer foraging and cover habitats in the Sierra (Kie et al. 1991, Loft et al. 1991). Mule deer herds in the Sierra are declining due to overgrazing in conifer forests, wet meadows, aspen stands, and bitterbrush-scrub communities (CDFG 1998). The narrow band of winter habitat along the westside foothills is an immediate management concern requiring improved livestock grazing guidelines and habitat protection on private lands (CDFG 1998). Well traveled roads and highways that bisect known mule deer migration routes, especially around Cave Junction in the east Sierra, cause considerable harm to migrating herds.

Table 15: Additional potential focal species for Sierra Nevada Wildlands Conservation Plan

SUBREGION	COMMON NAME	SCIENTIFIC NAME	HABITAT	FUNCTIONAL TYPE	POP. STATUS <sup>2</sup>	CODE <sup>3</sup>
Sierra Nevada	American Beaver	<i>Castor canadensis</i>	riparian corridors, small lakes	keystone; build dams, burrows	common	K
Sierra Nevada	American Dipper	<i>Cinclus mexicanus</i>	fast water, riparian corridors	aquatic indicator	stable	P
Sierra Nevada	Belted Kingfisher	<i>Ceryle alcyon</i>	eroded banks	hydrologic indicator; piscivore	declining	P
Sierra Nevada	Black Swift	<i>Gypseloides niger</i>	steep moist cliffs (waterfalls)	small colonies; migratory	CSC	?
Sierra Nevada	California Condor	<i>Gymnogyps californianus</i>	extensive open areas, cliffs, snags	scavenger	FE, SE (recovering)	P, A, L
Sierra Nevada	Cascades Frog	<i>Rana cascadae</i>	montane lakes, streams, ponds	aquatic indicator	CSC, (FSC)	P
Sierra Nevada	Common Merganser	<i>Mergus merganser</i>	riparian corridors	aquatic indicator, cavity nester	?	P
Sierra Nevada	Fringed Myotis	<i>Myotis thysanodes</i>	pinyon juniper, hardwood, conifer	crevices, caves; large colonies	(FSC)	P
Sierra Nevada	Great Gray Owl	<i>Syrinx nebulosa</i>	montane meadows/forest	contrast species	SE	P
Sierra Nevada	Harlequin Duck	<i>Histrionicus histrionicus</i>	riparian corridors	aquatic indicator	CSC, (FSC)	P
Sierra Nevada	Lodgepole Chipmunk	<i>Tamias speciosus</i>	high elev. open-canopy forest	arboreal	(FSC)	?
Sierra Nevada	Long-Eared Myotis	<i>Myotis evotis</i>	coniferous woodland, forest	crevices, caves	(FSC)	P
Sierra Nevada	Long-Legged Myotis	<i>Myotis volans</i>	woodland, forest, shrub	trees, caves; large colonies	(FSC)	P
Sierra Nevada	Mountain Yellow-Legged Frog	<i>Rana muscosa</i>	high elev. streams, lakes, ponds	aquatic indicator	CSC	P; D
Sierra Nevada	Mount Lyell Salamander	<i>Hydromantes platycephalus</i>	massive rock areas/seeps	crevices, caves	CSC, (FSC)	P; D
Sierra Nevada	Northern Goshawk	<i>Accipiter gentilis</i>	mid-high elev. Late seral old growth	winter downslope movement	CSC, (FSC)	P
Sierra Nevada	Northern Leopard Frog	<i>Rana pipiens</i>	quiet water in brush, forests	highly aquatic (indicator)	CSC	P
Sierra Nevada	Pileated woodpecker	<i>Dryocopus pileatus</i>	mid-high elev. Late seral old growth	area-dependent, excavator	decreasing trend	P
Sierra Nevada	Ringtail	<i>Basariscus astutus</i>	riparian corridors	native carnivore	fully protected	P
Sierra Nevada	Sierra Nevada Mountain Beaver	<i>Aplodontia rufa californica</i>	montane riparian	fossorial	CSC, (FSC)	P
Sierra Nevada	Sierra Nevada Red Fox	<i>Vulpes vulpes necator</i>	high elev. conifers/openings	native carnivore	ST, (FSC)	P, A
Sierra Nevada	Sierra Night Lizard	<i>Xantusia vigilis sierrae</i>	variable arid habitats	secretive, needs cover	CSC, (FSC)	P
Sierra Nevada	Silvery Legless Lizard	<i>Anniella pulchra pulchra</i>	loose soil, leaf litter to 6000'	fossorial	CSC, (FSC)	P
Sierra Nevada	Swainson's Thrush	<i>Catharus ustulatus</i>	dense shrubs in moist forest	neotropical migrant	declining for 50 yrs	P
Sierra Nevada	Vaux's Swift	<i>Chaetura vauxi</i>	large hollow trees, snags	migratory	CSC	P
Sierra Nevada	Western Pond Turtle	<i>Clemmys marmorata</i>	wide variety; permanent water	aquatic indicator	CSC, (FSC)	P
Sierra Nevada	White-tailed Hare	<i>Lepus townsendii</i>	open, with scattered shrubs	seasonal elev. movements	CSC	P
Sierra Nevada	Willow Flycatcher	<i>Empidonax traillii</i>	riparian willow thickets	riparian indicator	SE	P
Sierra Nevada	Wrentit	<i>Chamaea fasciata</i>	montane chaparral	sedentary	slight increase	P; D
Sierra Nevada	Yellow-Eared Pocket Mouse	<i>Perognathus xanthonotus</i>	chaparral, pinyon-juniper	fossorial	G1G2S1S2	?
Sierra Nevada	Yosemite Toad	<i>Bufo canorus</i>	high elev. wet meadows, lakes	aquatic indicator	CSC, (FSC)	P; D
Sierra Nevada	Yuma Myotis	<i>Myotis yumanensis</i>	open forests, woodlands	large colonies; near water	CSC, (FSC)	P
Sierra Foothills	Acorn woodpecker	<i>Melanerpes formicivorus</i>	oak woodland; near water	acorn dependent	local declines?	R, P
Sierra Foothills	Band-Tailed Pigeon	<i>Columba fasciata</i>	oak woodland, near water	acorn dependent	?	R
Sierra Foothills	Blunt-Nosed Leopard Lizard	<i>Gambelia sila</i>	low elev. scrub/grassland	opportunistic carnivore	SE, FE	P
Sierra Foothills	California Horned Lizard	<i>Phrynosoma coronatum frontale</i>	open habitats; sandy areas	fossorial	CSC, (FSC)	P
Sierra Foothills	California Red-Legged Frog	<i>Rana aurora dreyfohii</i>	low elev. slower water	aquatic indicator	CSC, FT	P
Sierra Foothills	California Thrasher	<i>Toxostoma redivivum</i>	dense chaparral, riparian	needs considerable cover	?	P
Sierra Foothills	Foothill Yellow-Legged Frog	<i>Rana boylei</i>	lower elev. rocky streams	aquatic indicator	CSC, (FSC)	P

Table 15, Continued

SUBREGION	COMMON NAME	SCIENTIFIC NAME	HABITAT	FUNCTIONAL TYPE	POP. STATUS <sup>2</sup>	CODE <sup>3</sup>
Sierra Foothills	Kern Canyon Slender Salamander	<i>Batrachoseps similis</i>	stream courses, ridges, hillsides	riparian indicator	ST,(FSC)	NE
Sierra Foothills	Limestone Salamander	<i>Hydromantes brunus</i>	limestone in chaparral, oak, pine-oak	crevices, cliffs	ST, (FSC)	P, NE
Sierra Foothills	MacGillivray's Warbler	<i>Oporornis tolmiei</i>	moist montane riparian thickets	upslope dispersal	stable?	P
Sierra Foothills	Mount Lyell Shrew	<i>Sorex lyelli</i>	moist areas near streams	in grass, under willows	CSC	NE
Sierra Foothills	Nashville Warbler	<i>Vermivora nuficapilla</i>	pine-oak woodland	up-mountain drift into all habitats	possibly decreasing	P
Sierra Foothills	Northern River Otter	<i>Lutra canadensis</i>	riparian corridors	native carnivore	?	A, P
Sierra Foothills	Nuttall's woodpecker	<i>Picoides pilatus</i>	oaks near streams	prefers acorns; cavity excavator	?	P, R
Sierra Foothills	Oak Titmouse	<i>Baeolophus inornatus</i>	warm, dry oak woodland	cavity nester; upslope movement	may be decreasing	P, R
Sierra Foothills	Orange-Crowned Warbler	<i>Vermivora celata</i>	mod. dense, brushy woodlands	up-mountain drift	may be declining	P
Sierra Foothills	Purple Martin	<i>Progne subis</i>	open woodland, forests, riparian	cavity-nester; migratory	CSC	P
Sierra Foothills	Red-Shouldered Hawk	<i>Buteo lineatus</i>	riparian forest	resident raptor	has declined greatly	P, R
Sierra Foothills	Sierra Night Lizard	<i>Xantusia vigilis sierrae</i>	variable arid habitats	secretive, needs cover	CSC, (FSC)	P
Sierra Foothills	Silvery Legless Lizard	<i>Anniella pulchra pulchra</i>	loose soil, leaf litter to 6000'	fossorial	CSC, (FSC)	P
Sierra Foothills	Snowshoe Hare	<i>Lepus americanus</i>	dense montane riparian	edges, heterogeneous habitats	CSC, (FSC)	P
Sierra Foothills	Tehachapi Slender Salamander	<i>Batrachoseps stebbensi</i>	moist canyons and ravines	riparian indicator	ST,(FSC)	NE
Sierra Foothills	Western Mastiff	<i>Eumops perotis</i>	extensive open areas; rock crevices	solitary or small colonies	CSC, (FSC)	P
Sierra Foothills	Western Spadefoot	<i>Scaphiopus hammonii</i>	hardwoods, grasslands	need temporary pools	CSC,(FSC)	R
Sierra Foothills	White-Breasted Nuthatch	<i>Sitta carolinensis</i>	open woodland, forest	acorn dependent in winter	possibly decreasing	P, R
Sierra Foothills	Wood Duck	<i>Aix sponsa</i>	large trees near quiet water	acorns preferred; cavity-nester	declining	P, R
Sierra Foothills	Yellow Warbler	<i>Dendroica petechia brewsteri</i>	riparian woodland	nests in dense shrub understory	CSC	P
Sierra Foothills	Yellow-Breasted Chat	<i>Icteria virens</i>	low, dense riparian thickets	riparian indicator	CSC	P
Eastside Sierra	Black Toad	<i>Bufo exul</i>	Deep Springs Valley	needs permanent springs	ST, (FSC)	NE
Eastside Sierra	California Gull	<i>Larus californicus</i>	nests: islands in alkali/fresh lakes	colonial	CSC	P
Eastside Sierra	Inyo Mountains Slender Salamander	<i>Batrachoseps campi</i>	desert riparian	aquatic indicator	CSC, (FSC)	NE
Eastside Sierra	Nelson's Bighorn Sheep	<i>Ovis canadensis nelsoni</i>	desert mountain ranges	large migratory herbivore	G4T3S3	P, A, R
Eastside Sierra	Northern Goshawk	<i>Accipiter gentilis</i>	mid-high elev. Late seral old growth	aspen canyons	CSC, (FSC)	P
Eastside Sierra	Northern Sagebrush Lizard	<i>Sceloporus graciosus graciosus</i>	open sagebrush	ground-dweller	(FSC)	P
Eastside Sierra	Owens Valley Vole	<i>Microtus californicus vaillicola</i>	wet meadows, grassland	fossorial	CSC, (FSC)	?
Eastside Sierra (FSC)	Owens Valley Web-Toed Salamander		<i>Hydromante sp.</i>	cliffs, crevices, caves	moist terrestrial	CSC,
Eastside Sierra	Pallid Bat	<i>Antrozous pallidas</i>	open dry habitats with rocky areas	colonial roosts; ground feeder	CSC	P
Eastside Sierra	Panamint Alligator Lizard	<i>Elgaria panamintinus</i>	dense desert riparian	needs permanent water	CSC, (FSC)	P
Eastside Sierra	Panamint Kangaroo Rat	<i>Dipodomys panamintinus</i>	pinyon-juniper; sagebrush	nocturnal granivore	G5T3S3	?
Eastside Sierra	Pinyon Jay	<i>Gymnorhinus cyanocephalus</i>	open canopy pine woodlands	requires pine seeds	may be decreasing	R
Eastside Sierra	Pronghorn	<i>Antilocarpa americana</i>	sagebrush/grassland	large migratory herbivore	recovering	A, R, P
Eastside Sierra	Pygmy Rabbit	<i>Brachylagus idahoensis</i>	sagebrush, bitterbrush, pinyon-juniper	fossorial	CSC, (FSC)	P
Eastside Sierra	Sage Grouse	<i>Centrocercus urophasianus</i>	sagebrush/meadows	lekking; sage dependent	CSC	A, R
Eastside Sierra	Sierra Nevada Bighorn Sheep	<i>Ovis canadensis californiana</i>	open alpine/canyons	large migratory herbivore	SE, FE	P, A, R
Eastside Sierra	Spotted Bat	<i>Euderma maculatum</i>	variable	rock crevices	CSC, (FSC)	P

Table 15, Continued

SUBREGION	COMMON NAME	SCIENTIFIC NAME	HABITAT	FUNCTIONAL TYPE	POP. STATUS <sup>2</sup>	CODE <sup>3</sup>
Eastside Sierra	Townsend's Big-Eared Bat	<i>Corynorhinus townsendii</i>	variable, mesic, edges	needs caves, mines, tunnels	CSC, (FSC)	R, P
Eastside Sierra	White Mountains Pika	<i>Ochotona princeps sheltoni</i>	variable, edges	rocky slopes, talus	G5T1T2S1S2	P
Modoc Plateau	American Bittern	<i>Botaurus lentiginosus</i>	emergent wetlands	migratory	G5S3	P
Modoc Plateau	American White Pelican	<i>Pelecanus erythrorhynchos</i>	nests: small flat islands in lakes	colonial, migratory	CSC	P
Modoc Plateau	Badger	<i>Taxidea taxus</i>	friable soils, open	carnivore, burrow excavator	G5S4	K
Modoc Plateau	Bald Eagle	<i>Haliaeetus leucocephalus</i>	forested, aquatic	large-trees, lacustrine	SE, FT	A, R
Modoc Plateau	Bank Swallow	<i>Riparia riparia</i>	eroded river banks	burrow excavator	ST	R, P
Modoc Plateau	Black-Crowned Night-Heron	<i>Nycticorax nycticorax</i>	rookery: dense trees	local migrator	G5S3	P
Modoc Plateau	Double-Crested Cormorant	<i>Phalacrocorax auritus</i>	rookery: trees, cliffs	colonial	CSC	P
Modoc Plateau	Greater Sandhill Crane	<i>Grus canadensis tabida</i>	wet meadows, marshes	wetland dependent	ST	R, P
Modoc Plateau	Northern Leopard Frog	<i>Rana pipiens</i>	quiet water in brush, woods, forests	highly aquatic (indicator)	CSC	P
Modoc Plateau	Northern Sagebrush Lizard	<i>Sceloporus graciosus graciosus</i>	open sagebrush	ground-dweller	(FSC)	P
Modoc Plateau	Northern Spotted Owl	<i>Strix occidentalis caurina</i>	Late seral old growth	large trees	FT	A, D, R
Modoc Plateau	Pronghorn	<i>Antilocarpa americana</i>	sagebrush/grassland	large migratory herbivore	recovering	A, R, P
Modoc Plateau	Pygmy Rabbit	<i>Brachylagus idahoensis</i>	sagebrush, bitterbrush	fossorial	CSC, (FSC)	P
Modoc Plateau	Sage Grouse	<i>Centrocercus urophasianus</i>	sagebrush/meadows	lekking; sage dependent	CSC	A, R
Modoc Plateau	Spotted Frog	<i>Rana pretiosa</i>	swamps in woodlands	highly aquatic (indicator)	CSC, FC	P
Modoc Plateau	Swainson's Hawk	<i>Buteo swainsoni</i>	open habitats with large trees	migratory	ST	P
Modoc Plateau	Townsend's Big-Eared Bat	<i>Corynorhinus townsendii</i>	variable, mesic, edges	needs caves, mines, tunnels	CSC, (FSC)	R, P

<sup>1</sup> Primarily terrestrial vertebrates, based on procedures of Lambeck (1997) and Noss et al. (1997).

<sup>2</sup> Data from CDFG (2000a, b) and DeSante (1999). CSC=California Species of Concern, (FSC)=former federal Category 2 species, ST=state threatened, FT=federal threatened, SE=state endangered, FE=federal endangered. Others are CNDDDB/TNC rankings.

<sup>3</sup> Codes are for "vulnerability categories," defined as: A=area-limited, D=dispersal-limited, K=keystone, NE=narrowly endemic, P=process-limited, R=resource-limited.

## APPENDIX B: REFERENCES

- Anthony, L.L. and D.T. Blumstein. 2000. Integrating behavior into wildlife conservation: the multiple ways that behavior can reduce  $N_e$ . *Biological Conservation* 95:303-315.
- Banci, V. 1994. Wolverine. The basis for conserving forest carnivores: American marten, fisher, lynx, and wolverine in the western United States. U.S. Forest Service General Technical Report RM-254. pp. 99-127.
- Barrett, R.H. 2000. A critique of the Sierra Nevada Forest Plan Amendment, Draft Environmental Impact Statement. Unpublished report.
- Beck, T.W., and G.I. Gould, Jr. 1992. Background and the current management situation for the California spotted owl. In *The California spotted owl: a technical assessment of its current status*. USDA. Forest Service, Pacific Southwest Research Station.
- Berger, J. 1990. Persistence of different-sized populations: an empirical assessment of rapid extinctions in bighorn sheep. *Conservation Biology* 4(1): 91-98.
- Blankenship, Sam. California Dept. of Fish and Game, personal communication.
- Bleich, V., J.D. Wehausen, R.R. Ramey II, J.L. Rechel. 1996. Metapopulation theory and mountain sheep: implications for conservation. pages 453-473 In: McCullough, D.R. (ed.) *Metapopulations and Wildlife Conservation Management*. Island Press:Washington, D.C.
- Bleich, V. Personal communication.
- Blus, L.J., C.S. Staley, C.J. Henny, G.W. Pendleton, T.H. Craig, E.H. Craig, D.K. Halford. 1989. Effects of organophosphorus insecticides on sage grouse in southeastern Idaho. *J. Wildl. Manage.* 53:1139-1146.
- Bock, C.E. and J.H. Bock 1974. Geographical ecology of the acorn woodpecker: diversity versus abundance of resources. *Am. Nat.* 108:694-698.
- Braun, C.E. 1998. Sage grouse declines in western North America: what are the problems? *Proc. West. Assoc. State Fish and Wildl. Agencies* 78:139-156.
- Buskirk, S.W., and L.F. Ruggiero. 1994. Marten. The scientific basis for conserving forest carnivores: American marten, fisher, Lynx, and wolverine. USDA. Forest Service, Rocky Mountain Forest and Range Experiment Station.
- Carroll, C., W.J. Zielinski, and R.F. Noss. 1999. Using presence-absence data to build and test spatial habitat models for the fisher in the Klamath region, U.S.A. *Conservation Biology* 13:00-00.
- California Department of Fish and Game. 2000. Pronghorn Antelope Hunting. Final Environmental Document California Department of Fish and Game, Sacramento, CA. 100 pp.
- Center for Biological Diversity. 2000. Petition to list the California spotted owl (*Strix occidentalis occidentalis*) as a threatened or endangered species. Unpublished report.
- CPIF. 2000. Draft Oak Woodland Bird Conservation Plan. Chapter 5. Species Specific Recommendations and Population Targets. Acorn woodpecker (*Melanerpes formicivorus*). pp. 34-35.
- CWHR. 1990. California Wildlife Habitat Relationships System, Version 7.0. California Department of Fish and Game. Sacramento, CA.
- CWHR. 1990. Mountain Sheep. In *California Wildlife Habitat Relationships System, Version 7.0*. California Department of Fish and Game. Sacramento, CA.



- Connelly, J.W., W.J. Arthur, O.D. Markham. 1981. Sage grouse leks on recently disturbed sites. *J. Range Manage.* 34:153-4.
- Connelly, J.W., M.A. Schroeder, A.R. Sands, C.E. Braun. 2000. Guidelines for management of sage grouse populations and habitats. Unpubl. Manuscript for the Western States Sage and Columbian Sharp-tailed Grouse Technical Committee.
- Fischer, John. California Dept. of Fish and Game. personal communication.
- Franklin, J.F., J.A. Fites. 1996. Assessment of late-successional forests of the Sierra Nevada. In *Sierra Nevada Ecosystem Project: Final report to Congress, vol. II, chap. 15*. Davis: University of California, Center for Water and Wildlands Resources.
- Friends of the Inyo, National Parks and Conservation Assoc., Natural Resources Defense Council, Sierra Nevada Bighorn Sheep Foundation, The Wilderness Society. 1999. Petition to the U.S. Fish and Wildlife Service to list the Sierra Nevada Bighorn Sheep as endangered. Can be obtained at <http://www.sierrabighorn.org/About.htm>.
- Grinnel, J. 1937. Sierra Nevada pine marten. Fur-bearing mammals of California.
- Gutiérrez, R.J., J. Verner, K.S. McKelvey, B.R. Noon, G.N. Steger, D.R. Call, W.S. LaHaye, B.B. Bingham, and John S. Senser. 1992. Habitat relations of the California spotted owl. In *The California spotted owl: a technical assessment of its current status*. USDA. Forest Service, Pacific Southwest Research Station.
- Gutiérrez, R. J., J. E. Hunter, G. Chavez-Leon, and J. Price. 1998. Characteristics of spotted owl habitat in landscapes disturbed by timber harvest in northwestern California. *Journal of Raptor Research*, 32(2), 104-110.
- Hooge, P.N. 1995. Dispersal dynamics of the cooperatively breeding acorn woodpecker. Ph.D. Diss., Univ. of California, Berkeley.
- Interagency Sage-Grouse Planning Team. 2000. Greater Sage-Grouse and Sagebrush-Steppe Ecosystems: Management Guidelines. Aug. 21, 2000. by BLM, USFWS, USFS, Oregon Dept. of Fish and Wildlife, Oregon Dept. of State Lands.
- Kie, J. G., C. J. Evans, E. R. Loft, and J. W. Menke. Foraging Behavior by Mule Deer: The Influence of Cattle Grazing. *J. Wildl. Manage.* 55(4):665-674.
- Koenig, W.D. and J. Haydock. 1999. Oaks, acorns, and the geographical ecology of acorn woodpeckers. *J. Biogeography* 26(1):159-165.
- Koenig, W.D. and Mumme R.L. 1987. *Population Ecology of the Cooperatively Breeding acorn woodpecker*. Princeton Univ. Press: Princeton.
- Lamberson, R.H., R.L. Truex, W.J. Zielinski, and D. MacFarlane. 2000. Preliminary analysis of fisher population viability in the southern Sierra Nevada. Arcata, CA: Humbolt State University.
- Lambeck R. 1997. Focal species: a multi-species umbrella for nature conservation. *Conservation Biology* 11:4:849-856.
- Laymon, S.,A. 1989. Altitudinal migration movements of spotted owls in the Sierra Nevada, California. *Condor* 91:837-841.
- Loft, E. R., J. W. Menke, and J. G. Kie. 1991. Habitat Shifts by Mule Deer: The Influence of Cattle Grazing. *J. Wildl. Manage.* 55(1):16-26.

- Loft, E. R., J. G. Kie, and J. W. Menke. 1993. Grazing in the Sierra Nevada: Home Range and Space use Patterns of Mule Deer as Influenced by Cattle. *Calif. Fish and Game* 79(4):145-166.
- MacRoberts, M.H. and B.R. MacRoberts. 1976. Social organization and behavior of the Acorn woodpecker in central coastal California. *Ornithol. Monogr.* 21:1-115.
- Mech, L. D. 1989. Wolf population survival in an area of high road density. *American Midland Naturalist* 121: 387-389.
- Miller, B.; Reading, R.; Strittholt, J.; Carroll, C.; No s s, R.; Soulé, M. E.; Sanchez, O.; Terborgh, J.; Brightsmith, D.; Cheeseman, T., and Foreman, D. Using focal species in the design of nature reserve networks. *Wild Earth*. 1999; 8:81 - 92 . of large mammals. *Conservation Biology*. 1996; 10:1549-1556.
- Noon, B. R., and J. A. Blakesley. 1999. Demographic parameters of the California spotted owl on the Lassen National Forest; preliminary results (1990-1998) (Summary Report ). Arcata, CA: USDA Forest Service, Pacific Southwest Research Station.
- O'Farrell, T.P. 1984. Conservation of the endangered San Joaquin kit fox *Vulpes macrotis mutica* on the Naval Petroleum Reserves, California. *Acta Zool. Fennica* 172:207-208.
- O'Gara, B. and J.D. Yoakum (eds.). 1992. Pronghorn Management Guidelines: a compendium of biological and management principles and practices to sustain pronghorn populations and habitat from Canada to Mexico. Fifteenth Biennial Pronghorn Antelope Workshop, Rock Springs, Wyoming, 101 pp.
- Paquet, P.C., and A. Hackman. 1995. Large carnivore conservation in the Rocky Mountains. *World Wildlife Fund Canada and World Wildlife Fund U.S.*, Toronto, Ontario, and Washington, D.C.
- Powell, R.A. 1993. *The fisher: life, history, ecology and behavior*. 2d ed. Minneapolis, MN: University of Minnesota Press. 237 p.
- Powell, R.A., W.J. Zielinski. 1994. Fisher. *The scientific basis for conserving forest carnivores: American marten, fisher, Lynx, and wolverine*. USDA. Forest Service, Rocky Mountain Forest and Range Experiment Station.
- Pyshora, L. 1977. *The Pronghorn Antelope in Northeastern California*. California Dept. of Fish and Game. Wildlife Management Administrative Report No. 77-2.
- Schmidt, R.H. 1991. Gray wolves in California: their presence and absence. *Cal. Fish and Game* 77:79-85.
- Schroeder, M.A., J.R., Young, C.E. Braun. 1999. Sage grouse (*Centrocercus urophasianus*). pages 1-26 In: Poole, A. and F.Gill (eds.). *The Birds of North America*, No. 425. Cornell Laboratory of Ornithology and The Academy of Natural Sciences.
- Sierra Nevada Bighorn Sheep Interagency Advisory Group. 1997. *A conservation strategy for Sierra Nevada Bighorn Sheep*. Inyo National Forest, Bishop CA.
- Wehausen, J.D. 2000. Population Survey Results. On the website: <http://www.sierrabighorn.org/News.htm>.
- Small, A. 1994. *California Birds: Their Status and Distribution*. Ibis Publishing Co., Vista, CA.
- Steger, G. N., T. E. Munton, G. P. Eberlein, and K. D. Johnson. 1999. *A study of spotted owl demographics in the Sierra National Forest and Sequoia and Kings Canyon National Parks (Annual Progress Report)*. Fresno, California: USDA Forest Service, Pacific Southwest Research Station.

Thomas, T. T. and L. R Irby. 1990. Habitat Use and Movement Patterns by Migrating Mule Deer in Southeastern Idaho. Northwest Science, Vol. 64, No.1.

Thompson-Seton, E. 1925. Lives of game animals. Garden City, NY: Doubleday, Page, and Co.

Truex, R.L.. USDA Forest Service, Pacific Southwest Research Station, personal communications.

Truex, R.L., W.J. Zielinski, R.T. Golightly, R.L. Barrett, and S.M. Wisely. 1998. A meta-analysis of regional variation in fisher morphology, demography, and habitat ecology in California (Draft Report). Arcata, CA: USDA Forest Service Pacific Southwest Forest and Range Experimental Station.

Verner, J., R.J. Gutiérrez, and G.I. Gould, Jr. 1992. The California spotted owl: general biology and ecological relations. In The California spotted owl: a technical assessment of its current status. USDA. Forest Service, Pacific Southwest Research Station.

Wasser, S. K., K. Bevis, G. King, and E. Hanson. 1997. Noninvasive physiological measures of disturbance in the northern spotted owl. Conservation Biology, 11(4).

Wehausen, J. 1999. Sierra Nevada Bighorn Sheep: on the edge of extinction. Essay on the website: <http://www.sierrabighorn.org/Field.htm>.

Zabel, C.J., G.N. Steger, K.S. McKelvey, G.P. Eberlein, B.R. Noon, and J. Verner. 1992. Patterns of habitat use by California spotted owls in logged forests of the northern Sierra Nevada. The California spotted owl: a technical assessment of its current status. USDA. Forest Service, Pacific Southwest Research Station.

Zielinski, W.J., T.E. Kucera, and R.H. Barrett. 1995. Current distribution of the fisher, *Martes pennanti*, in California. California Fish and Game, 81(3):104-112.

## Appendix C

### Methodology

*By Fraser Shilling and Evan Girvetz*

#### OVERVIEW

We used the GIS (Geographic Information System) extension program Ecosystem Management Decision Support (EMDS, Reynolds et al. 1996, Reynolds, 1999) to combine the concepts of wildlands planning identified in the report and data sets for the ecoregions of the Sierra Nevada, East Sierra, Modoc Plateau, and the Cascade Ranges. The planning area was simulated using 500m x 500m grid cells. Each grid cell was scored for its presumed contribution to conservation of biodiversity and wildlands. Using the annealing function of SITES, a second GIS extension program, areas with high potential for conservation of biodiversity and wildlands were clumped together to create sites that represent a target percentage of each natural plant community in the region. Finally, to define Wildland Linkages, the “Least Cost Path” extension of ArcView GIS was used to identify potential linkages between the pre-determined sites.

The methods described below articulate the process followed to meet three objectives:

- Assess the distribution of suitable habitat for focal species and other important ecological attributes such as habitat integrity.
- Identify a minimum number of Wildland Conservation Areas that support a combination of biodiversity and focal species habitat requirements and meet plant community representation goals.
- Analyze habitat connectivity for project focal species between Wildland Conservation Areas.

#### METHODS

The California Wilderness Coalition has chosen to use suites of “focal species” as the primary way to represent the biodiversity of study regions through potential or actual occupancy by these species. The focal species for this project are California mule deer, pronghorn antelope, bighorn sheep, California spotted owl, acorn woodpecker, sage grouse, Pacific fisher, marten, wolverine, and gray wolf. These terrestrial species were chosen to represent large swaths of the forested and other habitats in the combined Sierra Nevada, Cascade and Modoc region. Their modeled or actual habitat were used as a source of data. Native aquatic fauna were included in the project based on richness. Habitat needs for pronghorn, bighorn sheep, sage grouse and acorn woodpecker could in all cases be expressed in a GIS as “likely habitat” for the species, where the spatial data (primarily about vegetation) was available. Deer occurrence maps were available from California Department of Fish and Game for wintering habitat and migration routes. Carlos Carroll has made available his models for potential high quality habitat for the gray wolf, wolverine, and fisher. Other focal species are having their likely habitats modeled, beyond the fairly limited CWHR model. These areas can be incorporated into the wildland system model as they become available. Other landscape attributes that would potentially contribute to habitat quality for native Sierra Nevada plants and wildlife were also included in the analysis (e.g., presence of old-growth forest).

Another way to analyze landscapes for the potential to support healthy populations of native species is to measure or estimate human impacts and the potential or actual ecological integrity of the landscape (terrestrial and aquatic). We have chosen several surrogates for estimating threats to ecological processes and features from human activities, including roads, public vs. private ownership, human population density, and presence of dams and reservoirs. Road effects are measured in terms of proximity to streams, fragmenting “habitat” into patches, and other disturbance (e.g., from traffic). The complexity of the edge between public and private ownership could slow the development of a wildlands network that relies on seamless connectivity among reserve areas.

### WHAT IS EMDS AND HOW DOES IT WORK?

EMDS was created by the U.S. Forest Service Pacific NorthWest Research Station as a tool to help resource managers make informed decisions about landscape processes. EMDS links the GIS program ArcView 3.2 (ESRI, 1999) with the knowledge base creation program “Netweaver” (Saunders, 1990). Netweaver is an object-based hierarchical network, with nodes calculated based on fuzzy logical relationships. EMDS provides Netweaver with the necessary GIS data for analysis (Reynolds et al. 1996 and Reynolds 1999a, b).

A fuzzy logic network was created in Netweaver with the end assertion stating “a grid cell has a high potential for being part of a Wildland Conservation Area”. This assertion was given a truth-value based on an “AND” relation between the three assertions regarding terrestrial habitat quality, aquatic integrity, and forest integrity; these three assertions themselves then were given truth-values based on relations between “sub-assertions” (intermediate calculations) nested within the overall network (Figure 6).

Eventually these sub-assertions connected to base data that addressed a single assertion, such as “the grid cell is in Marten habitat”. The fuzzy logic capabilities of this model allowed us to give intermediate truth-values to base data assertions; an assertion is given a truth-value between –1.0 (completely false), 0 (undetermined), and 1.0 (completely true).

Truth-values of assertions are combined using “OR”, and “AND” fuzzy logic relationships. The OR relationship gives the assertion the truth-value of the most true sub-assertion. Thus, for the OR relationship even if only one sub-assertion is “completely true” (+1) the entire assertion is “true”, even if all of the other sub-assertions are “false”. The “AND” relationship combines the truth-values of two sub-assertions or base data by using the formula:

$$\text{AND}(t) = \min(t) + [\text{average}(t) - \min(t)] * [\min(t) + 1] / 2$$

Thus, any AND-assertion is false if any of its sub-assertions is “false”; however if one sub-assertion is completely true (+1) and the other is undetermined (0), the assertion is given a truth-value of 0.25. Thus, the AND relation is a conservative estimate of truth.

The degree of truth given to values in each GIS base data set is determined by rules whose parameters are defined by the user. These rules can be Boolean, continuous, or discontinuous. Data such as GAP management status is discontinuous because its truth-value of cost increases step-wise from completely protected (e.g., wilderness areas) to unprotected (e.g. private lands). A continuous statement, such as human population density, could have a truth-value that linearly increases from zero to one as the density increases from zero to some threshold population density value. In addition, mathematical relationships can exist among data links and dependency networks, such as recalculating the truth-value of slope steepness to define its potential effect on erosion.

## CONSTRUCTION OF THE “KNOWLEDGE BASE” FOR ASSESSING WILDLAND INTEGRITY AS A BASIS FOR IDENTIFY WILDLAND CONSERVATION AREAS

The knowledge base we developed for this analysis is shown in Figure 6. It produced three separate EMDS products: Wildland Integrity, corridor potential, and actual and potential habitat threat.

### *Wildland Integrity*

Wildland Integrity was calculated based on aquatic integrity (aquatic fauna, road proximity to stream, etc.), forest integrity (LSOG, patch characteristics, etc.) and terrestrial vertebrate habitat (e.g. focal species distributions, WHR richness, etc). These indicators and data were chosen based on a combination of the project's conservation goals, the important features of the Sierra Nevada landscape, and data availability.

### *Corridor Potential*

The corridor area potential score was calculated based on the ecological value and plant community corridor area constraints combined together with a fuzzy logic AND calculation (Figure 6). Four different corridor area potential truth-values were calculated with different corridor constraints for each of the following areas: low elevation hardwood/grassland complex; mid-elevation mixed conifer and conifer-alone forest communities; high elevation alpine conifer communities and barren lands; east-side conifer/desert. The corridor constraint truth-value was calculated based on topographic properties (slope steepness), and plant community type constraint. This constraint ensured that the modeled corridors did not result in an animal living in a given plant community (e.g. the oak woodland/grassland complex) having to travel up an excessively steep slope (e.g., 60%), or through an unusable forest community type (e.g., fir forest).

### *Actual and Potential Habitat Threat*

As there is no single map or model calculating actual landscape condition (e.g., actual land-cover), surrogates for condition must be used. Urban areas, freeways and highways with high traffic volumes, and areas of relatively high human population density were not considered desirable for inclusion in the wildlands system. However, if there is no obvious corridor through such a developed region, it is conceivable that a path will be indicated in the system, but its implementation may require physical changes to the landscape, such as highway overpasses to allow wildlife passage. Areas that are not yet developed may be under threat of development. A grid cell that is considered to be “actually developed” was not a conservation opportunity for the wildlands network; in contrast, an area that is not developed, has high actual or potential ecological value, and is threatened, was considered to be an opportunity for inclusion within the wildlands network. This approach allows private lands facing development to be included within the network, assuming they serve a conservation role for biodiversity (such as focal species core or corridor area).

Actual development was calculated based on human population density. Areas of high population density were considered areas of low or no opportunity for core or corridor areas.

Threat potential was calculated based on stream density, GAP management status, road density, public/private ownership edge density, and under-represented plant community types. Streams in the Sierra Nevada were considered to be a threatened feature (from logging, grazing, housing development, etc.), therefore human activities in areas of greater stream density could result in greater impacts to aquatic species. Plant communities with poor representation in protected areas (from GAP) were considered to be potentially more threatened than those within these areas. Areas of high threat that also have high ecological value may be included within the wildlands network, high threat potential being considered both an inhibitor and opportunity, depending on the ecological condition within and surrounding the area threatened.

## DATA COLLECTION AND PROCESSING

We collected the most current and highest resolution publicly available data for this analysis from various sources, including: US Forest Service, US Census Bureau, ICE at UC Davis, CA GAP Analysis, Carlos Carroll (Oregon State University), and others. Information on focal species distributions and important habitat metrics were provided by Dr. Brenda Johnson. All data were clipped to the boundary of the four Jepson ecoregions previously used in the Sierra Nevada Wildlands Project analysis (east Sierra Nevada, Sierra Nevada, Modoc Plateau, and Southern Cascades). Base data used in the EMDS analysis (see Figure 6) were converted into 500m grid cells.

## AQUATIC INTEGRITY

The assessment of integrity for aquatic ecosystems consisted of a combination of data for native fish and amphibian species distribution, potential road impacts, and presence of dams or diversions. Road impacts could come from either stream crossings or being near a stream on a steep slope. The potential or actual presence of aquatic species was considered an essential indicator for “value” of the area.

### *Fish and Amphibians*

Two independent map coverages were created by selecting native fish and amphibian coverages from the US Forest Service list of the “Aquatic GAP” project (Principal Investigator Peter Moyle, see <http://ice.ucdavis.edu/aquadiv/>) where confidence in the accuracy of the information was described as “greater than 0”. The mapped polygons indicated current likely habitat for each species. For each taxon (fish and amphibians) these coverages were converted to grid, the “no data” areas given a value of 0, and the grids merged into a single grid coverage. Cells were more “true” for aquatic fauna as fish and amphibian species richness increased. The following fish species are included in the fish grid: Sacramento Tule Perch, Lahontan Lake tui chub, Lahontan Creek tui chub, Owens tui chub, Riffle sculpin, California Roach, Pacific Lamprey, Owens Sucker, Kern Brook lamprey, Hardhead, Sacramento hitch, Lahontan cutthroat trout, Chinook salmon, and Black crappie. The following amphibian species are included in the amphibian grid: Arboreal salamander, Black-bellied slender salamander, Breckenridge Mountain slender salamander, California slender salamander, California toad, California tiger salamander, Fairview slender salamander, Hell Hollow slender salamander, Kern Canyon slender salamander, Kern Plateau slender salamander, limestone salamander, Mount Lyell salamander, Northern leopard frog, Owens Valley web-toed salamander, Pacific slender salamander, Pacific tree frog, Northern rough-skinned newt, Relictual slender salamander, Southern long-toed salamander, Sierra newt, Tehachapi slender salamander, Foothill yellow-legged frog, and the Yosemite toad.

Fish (0=U - 11=T)

Amphibian (0=U - 9=T)

### *Potential Road Impacts*

To determine “road proximity to stream”, we turned the road coverage (1:100,000 TIGER data from the Teale Data Center) and stream coverages (from the National Hydrological Database) into grid coverages with 500m cells, then found grid cells that overlapped. To determine “roads on steep slopes” we combined a 500m cell-size slope steepness grid, with a 500m road grid by calculating the slope values equal to zero where road grid cells were not present. The statement that the “road is on a steep slope” was more true as slope steepness increased to the maximum for the area. All roads in the coverage were used.

Road proximity (2=U, 1=T)

Road on steep slope (0=U - 500=T)



*Dam and Reservoir Influenced*

To determine the river and stream reaches potentially impacted by dams and reservoirs, we used the State Water Resources Control Board dam/diversions point coverage and queried for storage capacity greater than 0 to create the dam coverage. We buffered all point occurrences by 500m, streams within the buffer were considered dam or reservoir influenced.

(0=U, 1=T)

## FOREST INTEGRITY

*Late Successional Old-Growth (LSOG)*

The “older forest emphasis areas” map from the US Forest Service Sierra Nevada Framework was turned into a grid coverage with 500m cells. This coverage includes existing old-growth forests (LSOG 4 & 5), mapped during the Sierra Nevada Ecosystem Project (1996), as well as areas that were not mapped and areas of younger forest that have older forest attributes (e.g., LSOG 3).

LSOG (0=U - 4=T)

*Patch Size*

To capture large forest “patches” we found areas where polygons defined by road edges were the largest. We built a roads coverage (Teale Data Center) with polygon topology. We converted this coverage to grid based on polygon size and then found the focal mean of polygon size within a 1000m radius of each grid cell.

(0=U - 15000=T)

*Oak Woodland*

We used the CDF-FRAP hardwoods grid data (1994) that maps vegetation for the foothills using 25 meter grid cells. For 500m cells, we found the percent of each cell that had oak woodland vegetation types present (mixed oak and other communities were considered oak woodland).

(0=U, 100%=T)

## TERRESTRIAL VERTEBRATE HABITAT

*Species Richness*

For each suite of species in the Wildlife Habitat Richness (WHR) database — birds, amphibians, mammals, reptiles — we found the number of species that have a habitat quality rank of 4 or 5 (out of 5) for each GAP-VEG polygon. Species richness for each taxon was then determined for each grid cell.

Amphibian (0=U - 10=T)

Bird (0=U - 85=T)

Mammal (0=U - 44=T)

Reptile (0=U - 26=T)

*Focal Species*

For sage grouse, pronghorn antelope, bighorn sheep, we used the products of the California Wildlife Habitat Relations model linked to GAP-VEG to find suitable habitat (habitat ranks 1 to 5, where 1 is low and 5 high). Polygons were converted to grid coverages. The habitat ranks were used to assess the “value” of grid cells for protecting that species habitat. (<http://www.dfg.ca.gov/whdab/html/cwhr.html>)

Bighorn sheep (2=U - 5=T)

Pronghorn antelope (1=U - 5=T)

Sage Grouse (1=U - 5=T)

Marten and Fisher: Data was obtained from US Forest Service Sierra Nevada Framework (1999). Data for the public lands was “expanded” by 3km to fill in private ownership gaps in the public lands. (<http://www.r5.fs.fed.us/sncl/>)

Marten (0=U - 8300=T)

Pacific fisher (0=U - 10,000=T)

Gray wolf: Data was obtained from a model developed by Carlos Carroll for determining the biological feasibility of wolf restoration in California and Oregon (Carroll et al. 2001). The higher the habitat “score” the greater the potential of restoring this mammal to its former habitat.

(<50=U - 75=T)

Wolverine: Data was obtained from a model developed by Carlos Carroll et al. (2001) for determining the biological feasibility of wolverine recovery in California and Oregon. The higher the habitat “score” the greater the potential of restoring this mammal to its former habitat.

(75=U - 90=T)

California spotted owl: Data was obtained from Carlos Carroll (1999).

(0=U - 90=T)

Deer Habitat: Deer wintering area data was obtained from the CA Department of Fish and Game. These areas (primarily in the foothills) are considered vital to the persistence of deer herds in the Sierra Nevada. These data are from their telemetry studies and surveys. All polygons in the coverage were converted to grid. (<http://www.dfg.ca.gov/hunting/deer.html>)

(0=U, 1=T)

NDDDB: Natural Diversity Database from Ca. Dept. Fish & Game. These data are for occurrences of plants, plant communities, and wildlife that are rare, threatened, endangered, or of management concern. All occurrence polygons were converted to grid. (<http://www.dfg.ca.gov/whdab/html/cnddb.html>)

(0=U, 1=T)

## ACTUAL AND POTENTIAL HABITAT THREAT

*Actual Human Development*

Human Population density: Data from 1990 census blocks. Number of persons per square mile. (<http://www.census.gov/dmd/www/2khome.htm>)

(0=T - 100=U - 1000=F)

### *Human Threat Potential*

GAP Management Status: From the CA GAP analysis project; protection/management status = 1-4; status = 1-2 considered already protected; status = 4 is private lands. ([http://www.biogeog.ucsb.edu/projects/gap/gap\\_home.html](http://www.biogeog.ucsb.edu/projects/gap/gap_home.html))  
(2=U - 4=T)

Road density: Road data from the Teale Data Center (see above). Used the GRID command LINEDENSITY to calculate density of roads for a 1km circle around each grid cell.  
(0=U - 600=T)

Ownership edge density: Ownership data from CA GAP analysis project. Built polygons as lines then used the GRID command LINEDENSITY to calculate density of ownership boundaries.  
(0=U - 200=T)

Stream Density: Stream data were from the National Hydrography Database. We used the GRID command LINEDENSITY to calculate density of streams per grid cell. The higher the density, the greater the potential threat from nearby activities affecting aquatic habitat. (<http://nhd.usgs.gov/>)  
(200=U - 800=T)

Under-represented Plant Communities: First we created representation percentage goals for all Holland vegetation community types based on the goals of Andelman et al. (1999). Then we intersected the GAP management status polygon coverage with the GAP vegetation polygon coverage using ARC command INTERSECT. We then found: a) the total area of each Holland vegetation community type and b) the total area of each Holland vegetation community type in a GAP management status 1 or 2. From this we found the percent of each vegetation type already protected, then the percentage of the representation goal already protected.  
(100=U - 0=T)

### *Corridor Constraints*

Slope Steepness: Slopes less than 30% were given a truth-value of true for “not steep”. Slopes greater than 60% were given a truth-value of false. Intermediate slopes were given intermediate truth-values that linearly increased from true to false.  
(>60%=F - <30%=T)

Human Population Density: Densities from census blocks less than 100 persons per square mile were given a truth-value of true. Densities from 100 to 1000 persons per square mile were given truth-values that linearly decreased from true to undetermined. Densities greater than 1000 persons per square mile were given a truth-value of false.  
(>1000= F; 1000=U - 100=T)

Plant Community Constraint: We separated the vegetation types up into four different plant community zones: foothill oak woodland/grassland complex; mid-elevation west-side conifer forest; high elevation conifer forest/barren; east side conifer/scrub. Different truth-values were assigned based on the reference plant community zone. A truth-value of true was given to plant communities in the same zone, a truth value of undetermined was given to plant communities in adjacent zones and a truth value of false was given to plant communities in all other zones. For example, when finding a corridor in zone 2, a truth-value of true was given to all vegetation types in zone 2, a truth-value of undetermined was given for vegetation types in zone 1 or zone 3, and a truth value of false was given to vegetation types in zone 4.

### *Use of Wildland Integrity and SITES to identify Wildland Conservation Areas*

The product of the EMDS Wildland Integrity analyses was used as the base score grid for two SITES (Andelman et al. 1999) simulated annealing analyses. Bourgeron et al. (2000) used a similar protocol to find conservation areas in the interior Columbia Valley. Planning watershed boundaries and GAP plant community boundaries were intersected (using a 500m fuzzy tolerance) to create polygons that reflected a combination of hydrologic and ecological landscape. Each polygon was then given the average EMDS core area score for the grid cells found within the polygon. SITES was then used to group polygons together into a portfolio of habitat patches such that the combined EMDS truth-value of the polygons in the patch is high, the patch has a good shape, and pre-defined plant community representation goals are met. We based the plant community representation goals on those used by Andelman et al. (1999) in their SITES example analysis for northern Sierra Nevada watersheds (Table 12). The “seeds” used for the SITES analyses were currently protected areas with a GAP management status of “1” (e.g., wilderness areas).

SITES allows the user to modify the constraints on edge length by introducing a modifiable multiplier to the edge length part of the cost formula. The greater the “boundary modifier” the greater impact edge has on cost; this drives selection of solutions that minimize edge length in order to minimize cost. Several variations of the SITES run were done to test effects of constraints on the edge:core ratio (boundary modifiers 0, 0.01, and 0.10). In addition, for each boundary constraint we found the best of ten runs using 1,000,000 annealing iterations. A solution was chosen (boundary modifier = 0.10) that resulted in the majority of core areas greater than 10,000 acres. In addition, we calculated how often particular areas were chosen by the ten runs in order to find “areas of emphasis beyond the bounds of the core areas chosen. We used the ArcView extension I-SITES to create the input files for these analyses (Theobald 2001).

### *Use of EMDS and SITES Product in Least Cost Path Analysis*

We used a least cost path analysis extension for ArcView with the EMDS corridor area potential grid (see above) to find corridor connections between the Wildland Conservation Areas identified by the SITES analysis. The least cost paths were determined using the EMDS truth-values as the “cost surface”, including the constraints for topography, human population density and plant community type. Plant community-based “zones” were used to modify the cost of creating a corridor beyond that from the EMDS cost surface. These zones were based on plant community groupings from Holland (1986). Traversing from one zone to another increased the “cost” and therefore decreased the chance of that corridor direction being chosen. Thus, the corridor option favored would be one that was faithful to a suite of plant communities (e.g., oak communities, east-side communities, etc.), and was on gentler slopes. This analysis was run several times using a series of “start” and “end” points to increase the number of possible connections among core reserve areas. These corridors were then buffered and joined to the core reserve areas they connect.

### *Assessment of Wildland Network Ability to Meet Conservation Goals*

We chose to use the 0.1 boundary modifier SITES portfolio to represent Wildland Conservation Areas. The total area in the Cascade and Modoc region portfolio contained 4,813,443 acres, the northern Sierra Nevada portfolio contained 3,765,344 acres, the southern Sierra Nevada portfolio contains 4,901,053 acres, and the eastern Sierra Nevada portfolio contained 1,897,406 acres.

Figure 7. EMDS knowledge-base diagram.

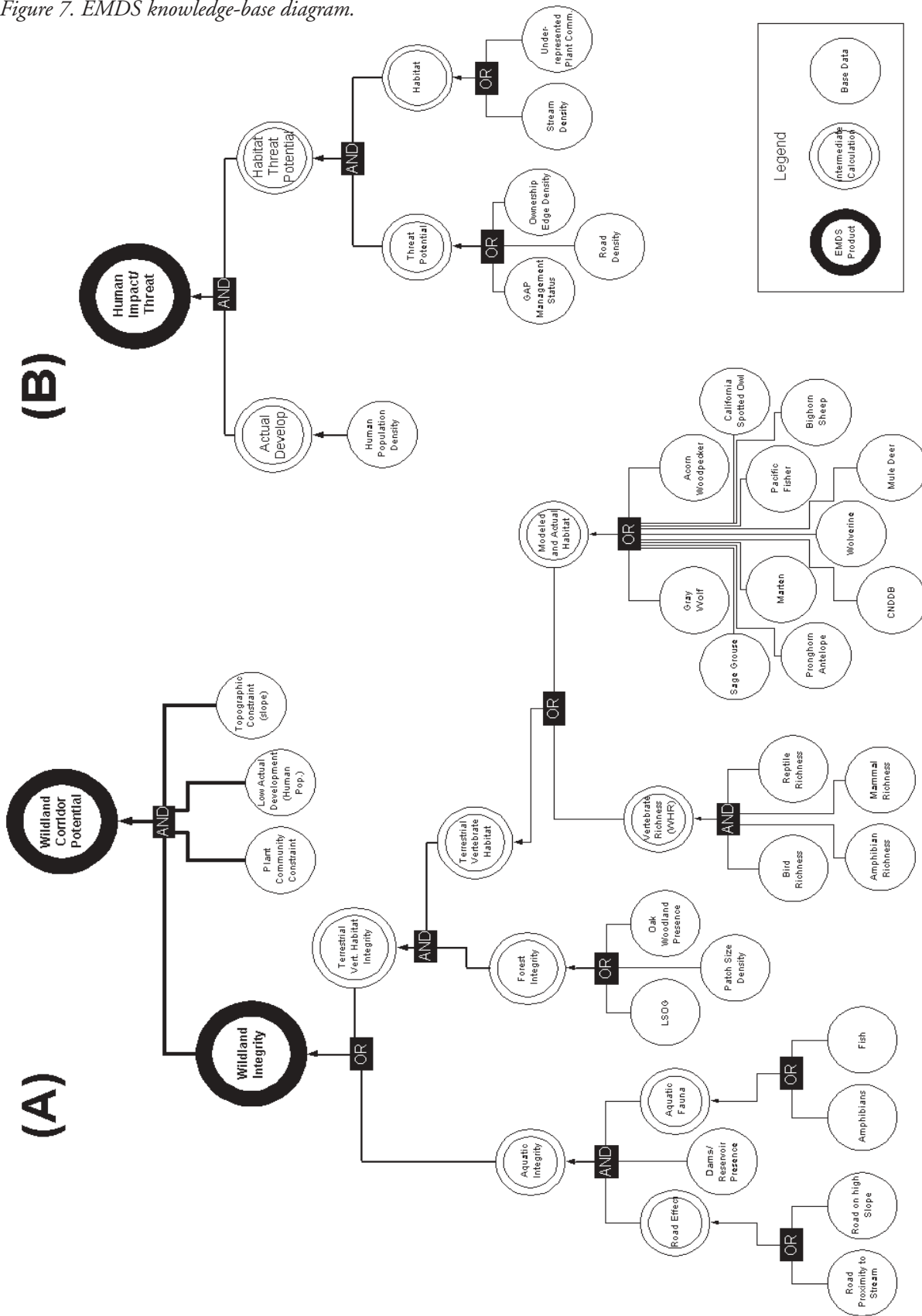



CALIFORNIA  
WILDERNESS  
COALITION

California Wilderness Coalition  
2655 Portage Bay East, Suite 5  
Davis, California 95616

(530) 758-0380  
[www.calwild.org](http://www.calwild.org)