

UC Davis

Research Reports

Title

Improved Energy and Emissions Modeling for Project Evaluation (MOVES-Matrix)

Permalink

<https://escholarship.org/uc/item/99w4w4cr>

Authors

Liu, Haobing
Xu, Yanzhi Ann
Rodgers, Michael O
et al.

Publication Date

2016-06-01

IMPROVED ENERGY AND EMISSIONS MODELING FOR PROJECT EVALUATION (MOVES-MATRIX)

June 2016

A Research Report from the National Center for Sustainable Transportation

Haobing Liu, School of CEE, Georgia Institute of Technology

Yanzhi (Ann) Xu, School of CEE, Georgia Institute of Technology

Michael O. Rodgers, School of CEE, Georgia Institute of Technology

Alper Akanser, School of CEE, Georgia Institute of Technology

Randall Guensler, School of CEE, Georgia Institute of Technology



About the National Center for Sustainable Transportation

The National Center for Sustainable Transportation is a consortium of leading universities committed to advancing an environmentally sustainable transportation system through cutting-edge research, direct policy engagement, and education of our future leaders. Consortium members include: University of California, Davis; University of California, Riverside; University of Southern California; California State University, Long Beach; Georgia Institute of Technology; and University of Vermont. More information can be found at: ncst.ucdavis.edu.

U.S. Department of Transportation (USDOT) Disclaimer

The contents of this report reflect the views of the authors, who are responsible for the facts and the accuracy of the information presented herein. This document is disseminated under the sponsorship of the United States Department of Transportation's University Transportation Centers program, in the interest of information exchange. The U.S. Government assumes no liability for the contents or use thereof.

Acknowledgments

This study was funded by a grant from the National Center for Sustainable Transportation (NCST), supported by USDOT through the University Transportation Centers program. The authors would like to thank the NCST and USDOT for their support of university-based research in transportation, and especially for the funding provided in support of this project. We would also like to thank Mehmet Belgin and his staff in Georgia Tech's PACE Center for his technical support in distributed computing.

Improved Energy and Emissions Modeling for Project Evaluation (MOVES-Matrix)

A National Center for Sustainable Transportation Research Report

June 2016

Haobing Liu, School of Civil and Environmental Engineering, Georgia Institute of Technology
Yanzhi (Ann) Xu, School of Civil and Environmental Engineering, Georgia Institute of Technology
Michael O. Rodgers, School of Civil and Environmental Engineering, Georgia Institute of Technology
Alper Akanser, School of Civil and Environmental Engineering, Georgia Institute of Technology
Randall Guensler, School of Civil and Environmental Engineering, Georgia Institute of Technology

[Page intentionally left blank]

TABLE OF CONTENTS

Introduction.....	1
MOVES Background.....	2
MOVES-Matrix Conceptual Approach	6
MOVES-Matrix Development	8
MOVES Configuration in PACE (Partnership for an Advanced Computing Environment)	9
MOVES Structure and Algorithm Design	11
Benefits of MOVES-Matrix.....	13
MOVES-Matrix Applications	14
MOVES-Matrix Result Verification.....	14
Model Run Time	14
Conclusions.....	15
References.....	18
Appendix A: MOVES-Matrix Structure.....	20
Input Module.....	20
Emission Rate Database	21
Output Module.....	25
Appendix B: MOVES-Matrix Algorithms	27
Speed-Matrix.....	27
Operating Mode Matrix.....	30
Appendix C: MOVES-Matrix Verification – Input and Results.....	36

Improved Energy and Emissions Modeling for Project Evaluation (MOVES-Matrix)

EXECUTIVE SUMMARY

The MOtor Vehicle Emission Simulator (MOVES) model was developed by the US Environmental Protection Agency (USEPA) to estimate emissions from on-road and off-road vehicles in the United States. The MOVES model represents a significant improvement over the older MOBILE series of models, primarily because emission rates are now much more modal in nature, representing emissions as a function of power surrogates, which depend on speed and acceleration. Traffic simulation model outputs and smartphone GPS data can provide second-by-second vehicle activity data in time and space, including vehicle speed and acceleration data. Coupling high-resolution vehicle activity data with appropriate MOVES emission rates further advances research efforts designed to assess the environmental impacts of transportation design and operation strategies. However, the MOVES interface is complicated and the structure of input variables and algorithms involved in running MOVES to assess operational improvements makes analyses cumbersome and time consuming. The MOVES interface also makes it difficult to assess complicated transportation networks and to undertake analyses of large scale systems that are dynamic in nature.

The MOVES-Matrix system developed by the research team can be used to perform emissions modeling activities in a fraction of the time compared to running MOVES. The approach involves running the MOVES model iteratively, across all potential input variable combination, and using the resulting multidimensional array of pre-run MOVES outputs in emissions modeling. The concept of iterative model processing and matrix generation was applied with the MOBILE model many years ago (Guensler, et al., 2004; Guensler, et al., 2000; Guensler and Leonard, 1995). However, it has taken some much longer to implement the same approach with MOVES, because the MOVES interface is more complex and because MOVES is much more computationally intensive, effectively requiring the application of supercomputing capabilities to implement the same matrix approaches previously applied to MOBILE.

The researcher team configured MOVES to run on a distributed computing cluster, obtaining MOVES energy consumption and emission rate outputs for Georgia and Vermont for each vehicle class, model year, and onroad operating condition, by calendar year, fuel composition (summer, winter, and transition fuels), local I/M program, meteorology (temperature in 1F-bins and relative humidity in 5%-bins), and other variables of interest. For Atlanta, MOVES was run 146,853 times to generate the speed-bin and operating mode-bin emission rate matrices, which generated more than 90 billion emission rates to populate the matrix. The resulting emission rate matrices allow users to link emission rates to big data projects and to and evaluate changes in emissions for dynamic transportation systems in near-real-time. In the case study, emission rate generation with MOVES-Matrix is 200-times faster than using the MOVES graphic user interface in the same computer environment and predicts exactly the same emissions result.

Introduction

The MOVES model provides significantly improved emission rates compared to the older MOBILE series of models, primarily because emission rates are more modal in nature, better representing emissions as a function of speed and acceleration. A variety of new fleet activity data are now available for use in emissions modeling, such as streaming machine vision data, smartphone location tracking, and traffic simulation modeling. Coupling MOVES emission rates with various sources of big data for vehicle activity can further advance research efforts designed to assess the environmental impacts of transportation design and operation strategies. Hot spot analysis and near-road air quality modeling for environmental impact assessment also benefit from the use of more accurate vehicle activity data and the application of high-resolution emission rates for onroad driving conditions. However, the MOVES interface is complicated, and the structure of input variables and algorithms involved in running MOVES to assess operational improvements makes such analyses cumbersome and time consuming.

The MOVES interface makes it difficult to assess complicated transportation networks and to undertake analyses of large scale systems that are dynamic in nature. For example, The Atlanta Regional Commission (ARC) Travel Demand Model network includes 74,500 roadway segment links. It is nearly impossible to perform emissions modeling for a dynamic network of this size using individual MOVES emission rates for each link when fleet composition and onroad operating conditions change dynamically over the course of a day. On a typical PC, MOVES requires around 11 seconds to process emissions for one link for a unique fleet and operating condition. To obtain the composite emission rates for 1000 roadway links in Atlanta, where the fleet composition and operating conditions vary every hour on every road segment, and where temperatures and humidity values vary by hour of day and month, and for the three Atlanta fuels (summer, winter, and transition), nearly 32 million individual MOVES runs would be required, which would take ten years to run on a typical PC.¹ⁱ Now, this is an exaggeration, in that a lot of shortcuts can be taken to reduce the number of runs required (many runs yield the exact same output), but modeling every operating condition described above is still impractical. A high-performance modeling approach is needed to assess large-scale dynamic networks. Yet, at the same time, regulations require that the latest approved regulatory model (i.e. MOVES 2014a) be used in all transportation and air quality planning and assessment work.

Previous studies have focused on optimizing model run speed for regulatory emissions models. For example, Guensler et, al. (2004) ran MOBILE6, the predecessor of MOVES model, tens-of-thousands of times to generate a matrix of emission rates (known as MOBILE-Matrix) by road class, fleet composition, fuel, I/M, temperature, etc., for Georgia, and applied emission rates in conformity analysis and CALINE4 dispersion model routines. The emission matrices developed for MOBILE6 facilitated rapid analysis via scripts. With the release of the more advanced

1 (1000 segments)*(24 hours)*(21 temperature bins, 10-110 F in 5F bins)*(21 humidity bins, 0%-100% in 5% bins)*(3 fuels) = 31,752,000 individual MOVES runs

MOVES model as replacement of MOBILE series models, Liu and Frey (2014) developed a simplified MOVES model called MOVES-Lite, based on the ratio of operating mode bin as the cycle adjustment factor, and the results are within 5% of MOVES outputs.

To improve modeling efficiency, but at the same time ensure that regulatory requirements for use of MOVES are met, the research team developed MOVES-Matrix. The MOVES model is run hundreds of thousands of times to generate an emission rate matrix for all combinations of MOVES input variables. The MOVES-Matrix emission rates described in this report can be queried from any analytical platform without ever having to launch MOVES or transfer MOVES modeling output files into the analyses. Obtaining regulatory approval for any modeling approach is predicated on the approval of the US Environmental Protection Agency, which requires that the latest MOVES model must be employed. Any modeling approach has to yield exactly the same emission rates as MOVES when run for the same conditions. As will be demonstrated in this report, because MOVES-Matrix is simply the comprehensive set of outputs from the MOVES model, and the application of MOVES-Matrix emission rates yields exactly the same results as MOVES. The matrix approach has to yield the same results, because MOVES generated the emission rates in the matrix.

MOVES Background

Historically, regulatory emissions models, such as the MOBILE series of models, defined emissions as a function of average speed, essentially irrespective of acceleration. That is, 25 mph on a congested freeway yielded the same gram/mile emission rate as 25 mph on a free-flowing arterial. In the MOVES model, emissions are now defined as a function of speed and vehicle-specific power (VSP), which better reflects acceleration and impacts on engine load and work. The United States Environmental Protection Agency's (USEPA's) MOVES model employs a "binning" approach in modeling emissions for different onroad fleets and onroad operating conditions, where activity that fall into the same operating mode bin receive the same emission rate. In MOVES, driving cycles (speed-acceleration activity) can be decomposed into operating mode bins and modeled as a function of time spent operating in each bin. This design enables MOVES to provide common emission rates for all modeling scales (macroscale, mesoscale, and microscale). MOVES requires refined input data, including meteorology, calendar year, fuel type, inspection and maintenance program elements, traffic volume, operating speed, fleet age distribution and vehicle type distribution. Baseline emission rates for specific operating modes are also adjusted in the model to account for the impacts of temperature, humidity, fuel composition, vehicle aging, and other factors on the emission rates. Figure 1 below presents the data processing flow of MOVES model.

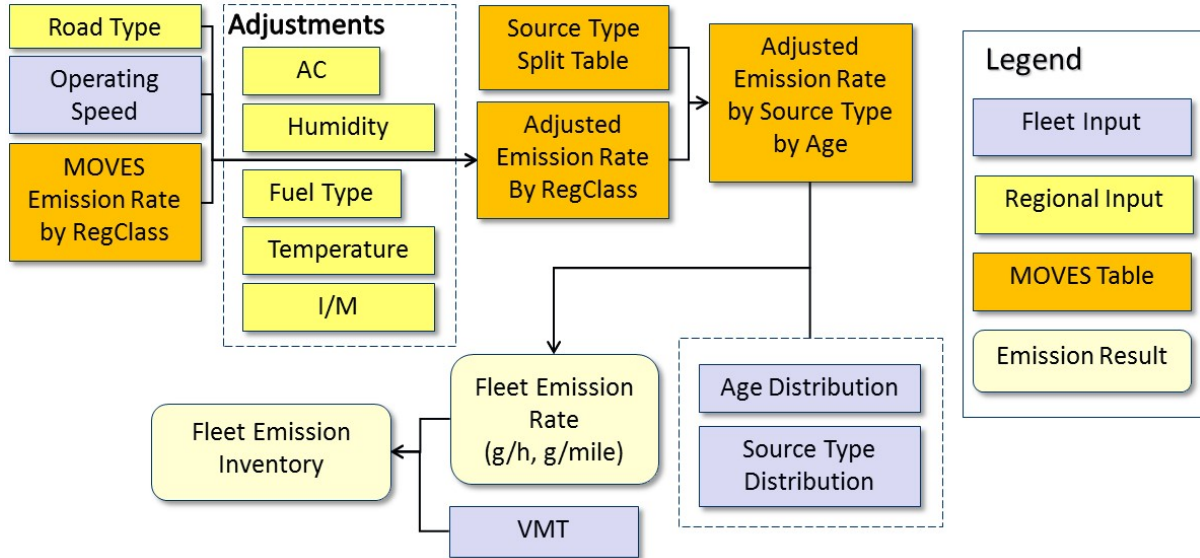

Figure 1: Data Processing Overview of MOVES

Because emissions are a function of the energy required to move the vehicle, which depends upon power demand, vehicle weight, and onroad operating conditions, the MOVES model employs surrogates for engine load: vehicle specific power (VSP) for light-duty vehicles, and scaled tractive power (STP) for heavy-duty vehicles. VSP and STP are a function of vehicle speed, acceleration, and vehicle mass. Second-by-second VSP and STP are calculated as (US EPA, 2016):

$$VSP = \left(\frac{A}{M}\right)v + \left(\frac{B}{M}\right)v^2 + \left(\frac{C}{M}\right)v^3 + \left(\frac{m}{M}\right)(acc + g * \sin \theta)v$$

$$STP = \left(\frac{A}{M}\right)v + \left(\frac{B}{M}\right)v^2 + \left(\frac{C}{M}\right)v^3 + \left(\frac{m}{M}\right)(acc + g * \sin \theta)v$$

Where:

VSP = vehicle specific power $\left(\frac{\text{kW}}{\text{tonne}}\right)$, power to weight ratio

STP = scaled tractive power $\left(\frac{\text{kW}}{\text{tonne}}\right)$

v = second – by – second velocity, m/sec

acc = second – by – second acceleration, m/sec²

g = gravitational acceleration(9.81 m/sec²)

θ = road grade (radians or degrees, as required by the sin calculation algorithm employed)

m = vehicle mass (tonnes), m=M for VSP calculations

A = rolling resistance (kW – sec/m)

B = rotating resistance (kW – sec²/m²)

C = aerodynamic drag (kW – sec³/m³)

M = fixed mass factor for the source type (tonnes), m=M for VSP calculations

The MOVES model uses a binning approach in emissions modeling. VSP and STP bins are established for three types of operations: braking, idle, and cruise-acceleration. Bins for cruise-acceleration are further separated into three average speed groups (0-25 mph, 25-50 mph, 50+ mph), and then into VSP ranges within each average speed group. Higher VSP and STP values within specific operating speed ranges are linked with higher fuel consumption, CO₂ emission rates, and criteria pollutant emission rates. Table 1 describes and defines each MOVES operating mode bin.

Table 1: MOVES VSP Operating Mode Bins

Operating Mode ID	Operating Mode Description	Vehicle-Specific Power (VSP _t)	Vehicle Speed (v _t)	Vehicle Acceleration (a _t)
		(kW/tonne)	(mph)	(mph/sec)
0	Deceleration/Braking			a _t ≤ -2.0 OR (a _t < -1.0 AND a _{t-1} < -1.0 AND a _{t-2} < -1.0)
1	Idle		-1.0 ≤ v _t < 1.0	Any
11	Coast	VSP _t < 0	0 ≤ v _t < 25	Any
12	Cruise/Acceleration	0 ≤ VSP _t < 3	0 ≤ v _t < 25	Any
13	Cruise/Acceleration	3 ≤ VSP _t < 6	0 ≤ v _t < 25	Any
14	Cruise/Acceleration	6 ≤ VSP _t < 9	0 ≤ v _t < 25	Any
15	Cruise/Acceleration	9 ≤ VSP _t < 12	0 ≤ v _t < 25	Any
16	Cruise/Acceleration	12 ≤ VSP _t	0 ≤ v _t < 25	Any
21	Coast	VSP _t < 0	25 ≤ v _t < 50	Any
22	Cruise/Acceleration	0 ≤ VSP _t < 3	25 ≤ v _t < 50	Any
23	Cruise/Acceleration	3 ≤ VSP _t < 6	25 ≤ v _t < 50	Any
24	Cruise/Acceleration	6 ≤ VSP _t < 9	25 ≤ v _t < 50	Any
25	Cruise/Acceleration	9 ≤ VSP _t < 12	25 ≤ v _t < 50	Any
27	Cruise/Acceleration	12 ≤ VSP _t < 18	25 ≤ v _t < 50	Any
28	Cruise/Acceleration	18 ≤ VSP _t < 24	25 ≤ v _t < 50	Any

Operating Mode ID	Operating Mode Description	Vehicle-Specific Power (VSP _t)	Vehicle Speed (v _t)	Vehicle Acceleration (a _t)
		(kW/tonne)	(mph)	(mph/sec)
29	Cruise/Acceleration	$24 \leq VSP_t < 30$	$25 \leq v_t < 50$	Any
30	Cruise/Acceleration	$30 \leq VSP_t$	$25 \leq v_t < 50$	Any
33	Cruise/Acceleration	$VSP_t < 6$	$50 \leq v_t$	Any
35	Cruise/Acceleration	$6 \leq VSP_t < 12$	$50 \leq v_t$	Any
37	Cruise/Acceleration	$12 \leq VSP_t < 18$	$50 \leq v_t$	Any
38	Cruise/Acceleration	$18 \leq VSP_t < 24$	$50 \leq v_t$	Any
39	Cruise/Acceleration	$24 \leq VSP_t < 30$	$50 \leq v_t$	Any
40	Cruise/Acceleration	$30 \leq VSP_t$	$50 \leq v_t$	Any

Figure 2 below presents an example of the MOVES CO₂ emission rates for model year (MY) 2016 passenger truck in each operating mode bin (defined by speed and VSP ranges). High speeds, moderate accelerations at high speed, and hard accelerations at moderate or high speed push onroad activity into higher VSP bins, which then use higher fuel consumption and emission rates in energy and emissions calculations. Eco-driving strategies that use the MOVES model as a basis for energy consumption therefore focus on trying to limit speed and acceleration rates to keep vehicle activity from jumping into higher VSP bins.

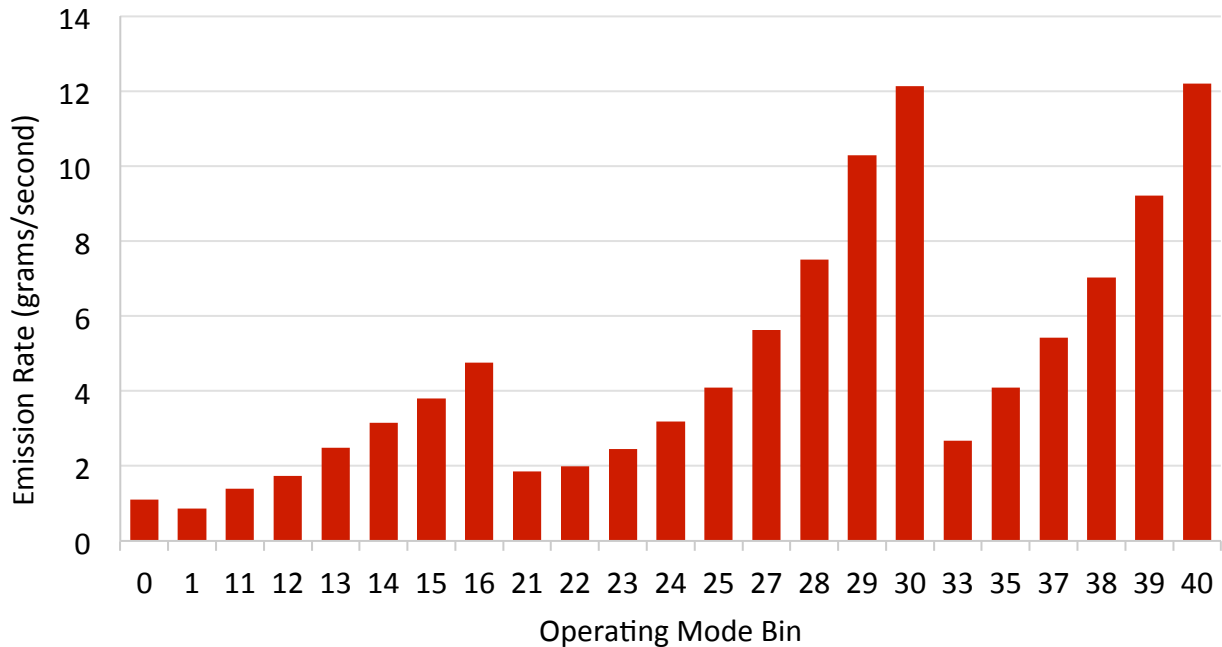

Figure 2: Example CO₂ Emission Rates by VSP Bin for Passenger Trucks (2016MY in 2016)

MOVES-Matrix Conceptual Approach

Because emissions are a complex function of many locally-dependent variables, and because MOVES integrates a number of aggregation functions for use in emission estimation at state and county levels, the interface is complex and requires numerous inputs to properly characterize any specific emission scenario modeled by a user. A lot of labor is required to prepare MOVES input files. In addition, running MOVES is time consuming, because emission calculations always begin with base emission rates, which are internally adjusted by various correction factors such as temperature, humidity, fuel property, etc. This also makes MOVES difficult to use for large-scale transportation networks that experience dynamic changes in on-road fleet composition and operating conditions that affect correction factors during the day.

MOVES-Matrix is composed of the outputs from a tremendous number of MOVES model runs. The basic process is to run MOVES across all variables that affect output emission rates, where each iteration yields a pollutant emission rate for: a uniform source type (all vehicles represented in the run are a specific type of vehicle), a uniform model year (age group), for a specific vehicle fuel type (gasoline, diesel, CNG, etc.), a specific onroad operating condition (average speed and road type, or a single on-road VSP/STP operating mode bin), a single calendar year, other applicable regional regulatory parameters (fuel properties, I/M program characteristics), and a specific temperature and humidity condition. After conducting hundreds of thousands of runs, the resulting MOVES emission rate matrix (MOVES-Matrix) can be queried to obtain the exact same emission rates that would be obtained for any MOVES model run, without ever having to launch MOVES again, or transfer MOVES outputs into the analyses.

Figure 3 below provides an overview of MOVES-Matrix application process. Users first identify the subset of the Matrix they need, by specifying calendar year, fuel month, and meteorology data. Then, the user can access each cell that contains an emission rate for a specific vehicle class and model year from MOVES-Matrix and weight each emission rate by on-road activity to reassemble the fleet emission rate. Because the weighting process is exactly the same as used in MOVES to generate a fleet composite emission rate for a link, the MOVES-Matrix process yields the exact same emission rates as a direct MOVES run, but in a fraction of the time.

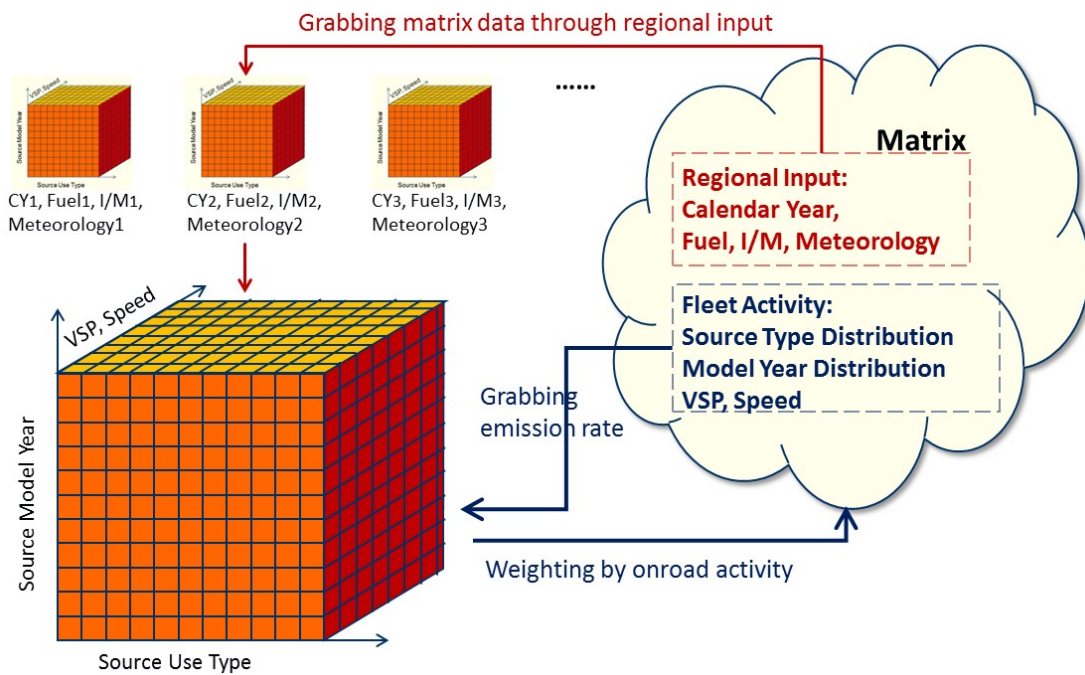

Figure 3: MOVES-Matrix Conceptual Flow

Figure 4 shows the emission rate assembly process for MOVES-Matrix. Because each MOVES run already performed the complex calculations emission rate and adjustments for temperature, humidity, fuel composition, I/M program, etc., and MOVES-Matrix simply contains the resulting emission rates, applying the matrix of emissions is a lot faster than running MOVES. The matrix emission rate assembly process is so fast, that it opens the door to using the matrix emission rates for large-scale and real-time emission estimation.

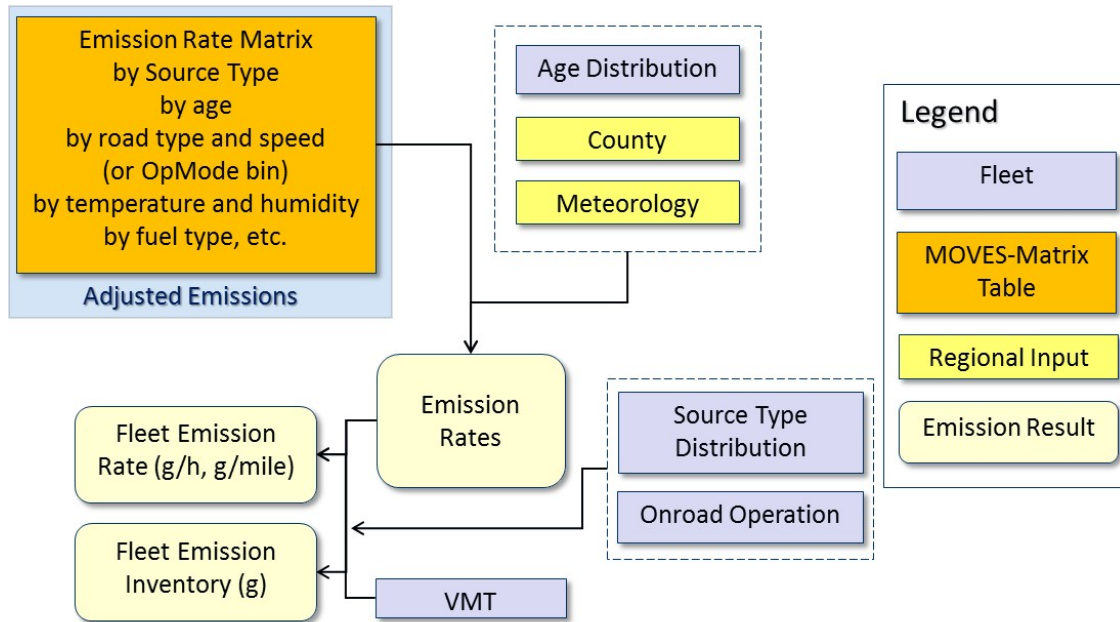

Figure 4: MOVES-Matrix Data Processing Overview

MOVES-Matrix Development

To develop the MOVES-Matrix emission rate database for each region of interest, a total of 146,853 MOVES runs were prepared by the research team (calendar years 2010-2025, 2030, 2035, 2040, 2045, 2050; winter, summer, and transition fuels, 10F-110F temperatures in 1F intervals, 0%-100% relative humidity in 5% intervals). Three emission rate processing steps are performed: 1) develop the set of MOVES input files to support the iterative run process across all relevant input variables; 2) run the MOVES input files in an advanced computing cluster to obtain multi-dimensional emission rates outputs, and; 3) design algorithms that can be used to pull applicable emission rates from the matrix for use in regional emissions inventory modeling, traffic simulation modeling, corridor-monitored second-by-second activity analysis, and microscale dispersion modeling. Georgia and Vermont served as the modeling test cases.

In addition to the csv input tables, each MOVES modeling run employs an import xml file and an execution xml file. In developing MOVES-Matrix, we noted that MOVES outputs multiple emission rate elements for a single input file and run, in about the same time that it takes to generate a single composite emission rate. For each MOVES input element representing a single transportation link, the user can assign a specific calendar year, road type and operating speed, temperature, humidity, fuel, and I/M settings. In addition to the composite emission rate output, MOVES also outputs the emission rates for each vehicle source and model year type (13 Source Types * 31 model years) and fuel types (gasoline, diesel, CNG, etc.). Hence, we obtain 403 (13*31) source type emission rates for every single MOVES run. Not only are fewer runs required, but significant time savings also accrue from not having to launch the model as frequently. The xml files support the processing of the output files to collect and transfer the 403 emission rates for each run into the matrix.

MOVES Configuration in PACE (Partnership for an Advanced Computing Environment)

The Georgia Tech team has priority access to the Partnership for an Advanced Computing Environment (PACE) high performance computing (HPC) cluster. PACE is a collaboration between Georgia Tech faculty and the Office of Information Technology, and was established for the primary purpose of providing an environment for distributed high performance computing. Participating researchers can benefit from the large scale computing and storage infrastructure, which is organized in the forms of shared queues and distributed computational runs (Figure 5). Dedicated technical services are provided to manage the hardware and software infrastructure for the cluster. Participating faculty members purchase additional nodes and storage through research funding, which are prioritized for their use by the PACE system by managing user priorities over each shared queue. Users submit jobs to PACE from a few select head nodes and the cluster assigns jobs to available cores. On its largest shared queue, PACE manages around 35,000 cores, with 90 terabytes of memory, 2 Petabyte of online commodity storage, and nearly 300 terabytes of high-performance scratch storage. The largest queue that the research team can currently access has 202 nodes with 8,200 cores.



Figure 5: PACE Center Parallel Computation

PACE nodes (each machine is called a node) are divided into two types.

1. Head Node – All PACE users have access to head nodes, which are used to launch jobs. No computation is performed on these nodes.
2. Cluster Node – Cluster nodes are where the actual jobs run. A user has access to a particular cluster node only during the time the user's job is running on the cluster.

Figure 6 below shows the PACE mechanism for MOVES Launch

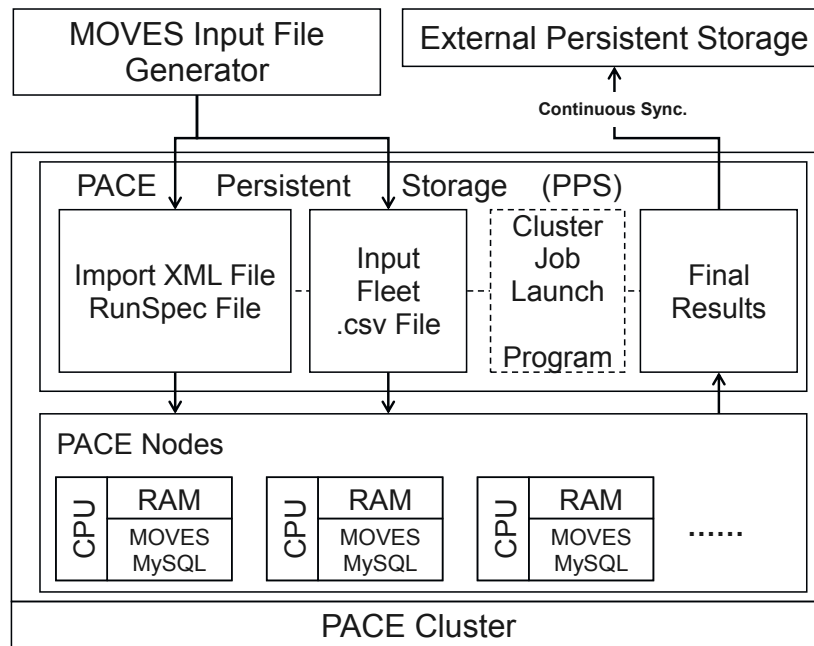

Figure 6: MOVES Configuration in the PACE System

When a MOVES job is launched on a cluster machine, the scripts first install MOVES on the machine by unzipping the MOVES source files on the disk. The script then proceeds to installing a thin version of MYSQL server, by unzipping its files onto the disk, and starts the SQL server on an available port. MOVES command line java processes are then launched to create input and output database files respectively. The output files are zipped and stored on PACE persistent storage. Figure 7 below presents the MOVES launching process in PACE.

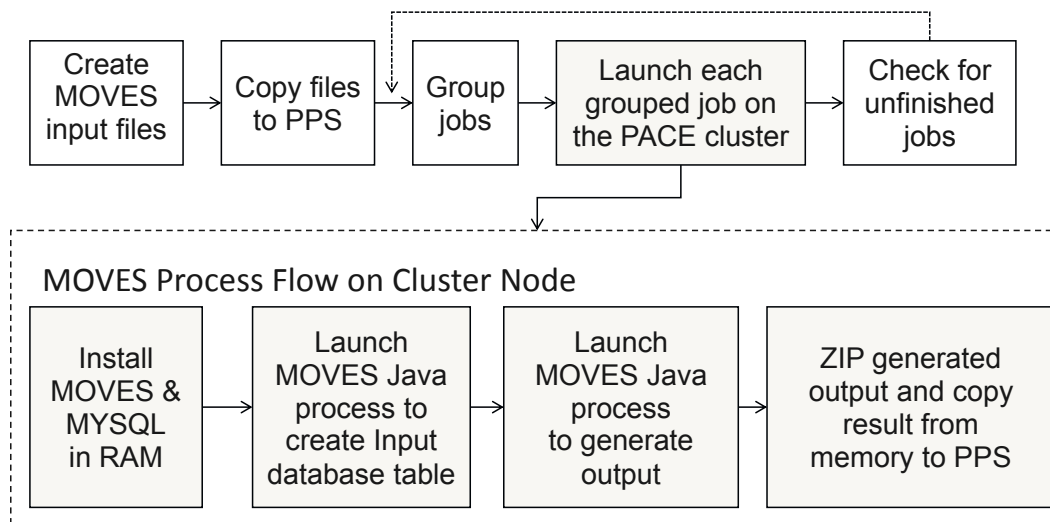

Figure 7: MOVES Launch Process in PACE

MOVES Structure and Algorithm Design

MOVES-Matrix is based upon 146,853 MOVES runs. The scripts iterate MOVES runs across all variables that affect output emission rates, where iterations yield emission rates applicable to:

- Specific air pollutants
- Uniform source type
- Uniform model year (age group)
- Given calendar year
- Specific onroad operating conditions
 - Average speed and road type, or
 - On-road VSP/STP operating mode bin
- Specific temperature and humidity
- Specific vehicle fuel type (gasoline, diesel, CNG, etc.)
- Regional regulatory parameters (fuels properties and I/M program)

To support varied levels of detail for onroad fleet composition and operating conditions that may be available to modelers, the research team prepared three MOVES-Matrix versions.

- **Average Speed and Facility Type Matrix (Speed-Matrix)**
In the speed matrix version, users provide average speed and road type (e.g. arterial vs. freeway) as inputs. The emission results are a function of internal MOVES default driving cycles. The fleet is specified by source type and model year, and MOVES default fuel type distributions (e.g., % of gasoline and diesel vehicles) are applied by source type.
- **Operating Mode Matrix**
In the operating mode bin matrix version, users need to provide a driving schedule, or operating mode distribution for onroad operations. The fleet is specified by source type and model year, with MOVES default fuel type distribution (e.g., % of gasoline and diesel vehicles) applied to each source type.
- **Matrix of Operating Mode and Fuel**
In the operating mode bin and fuel matrix version, users need to provide a driving schedule, or operating mode distribution for onroad operations. The fleet is then specified by source type, model year, and fuel type.

The MOVES-Matrix application consists of three modules: 1) input, 2) emission database, and 3) output. Input modules are created for each of the three versions of the modeling approach described above and emission databases are structured for query by average speed and facility or operating mode bin. Each module for each model version is described in Appendix A.

In designing MOVES-Matrix, it was important to first assess model user habits. Real-world applications of MOVES for emission inventory development or project-level conformity analyses currently use a variety of simplification approaches to limit the number of MOVES runs

that will be required. For example, analysts often assume that fleet composition does not vary (using a default regional registration mix for model years and technology groups) with heavy-duty truck fractions quantized in specific percentages by road class (e.g., 0% or 1% on certain local roads and arterials and 3% or 5% on certain freeways). Planning inventories may also assume a single temperature, humidity, and fuel. Every time another transportation scenario needs to be assessed, a new set of emission rates (e.g., new meteorology or fuel scenario) generally needs to be developed from MOVES and connected with the activity data.

To support typical applications, the MOVES-Matrix emission database was grouped into 146,853 sub-matrices, with each sub-matrix storing emission rates for all source types, all source model years, all onroad operations (speed bins or operating mode bins), for one specific calendar year, one month, one temperature, one relative humidity, one fuel supply (by year and month), and one I/M strategy (by year). This way, a small subset of emission rates can be extracted from the matrix based on the user's year, month, and meteorology inputs. This structure helps support emission control strategy analysis, given that users tended to assume a single temperature, humidity, and fuel, when exploring the impacts of strategies on traffic activity and emissions. Using a sub-matrix significantly is significantly faster than extracting data from the full 90-billion-cell emission rate matrix.

After the sub-matrix of emission rates is identified and accessed, the emission rate processing is the same as used by MOVES in project-level modeling. The emission rates in the sub-matrix are connected to vehicle activity data through MOVES-Matrix algorithms described in general below, and in script format in Appendix B. MOVES-Matrix weights the emission rates from individual source types to generate the composite emission rate. The weighting combines onroad vehicle activity, as defined by combined source type and model year distribution (newer vehicles typically represent a larger share of the onroad fleet than older vehicles) and the amount of onroad activity by operating mode bin to calculate a composite emission rate for each link. The emission rate weighting function is:

$$\text{fleetEmissionRate} = \sum_{\text{sourceType}} \sum_{\text{modelYear}} \sum_{\text{opMode}} \frac{\text{sourceType}\% \times \text{modelYear}\%_{\text{sourceType}} \times \text{opMode}\%_{\text{sourceType,modelYear}}}{\text{emissionRate}_{\text{sourceType,modelYear,opMode}}}$$

$$\text{emissions} = \text{VMT} \times \text{Emission Rate}$$

To assist in the implementation of MOVES-Matrix, Appendix B details the algorithm design of the MOVES-Matrix Speed-Bin version as well as the Operating Mode Bin and Operating Mode Fuel Bin versions.

Benefits of MOVES-Matrix

Figure 8 below compared MOVES with MOVES-Matrix in terms of overall working mechanisms. MOVES starts with a set of baseline emission rates, and these baseline emission rates are adjusted during each run before they are connected to activity data. MOVES-Matrix stores adjusted emission rates for all scenarios, and for the scenario of interest. MOVES-Matrix filters the pre-run emission rates for the specific scenario, rather than doing adjustment calculations.

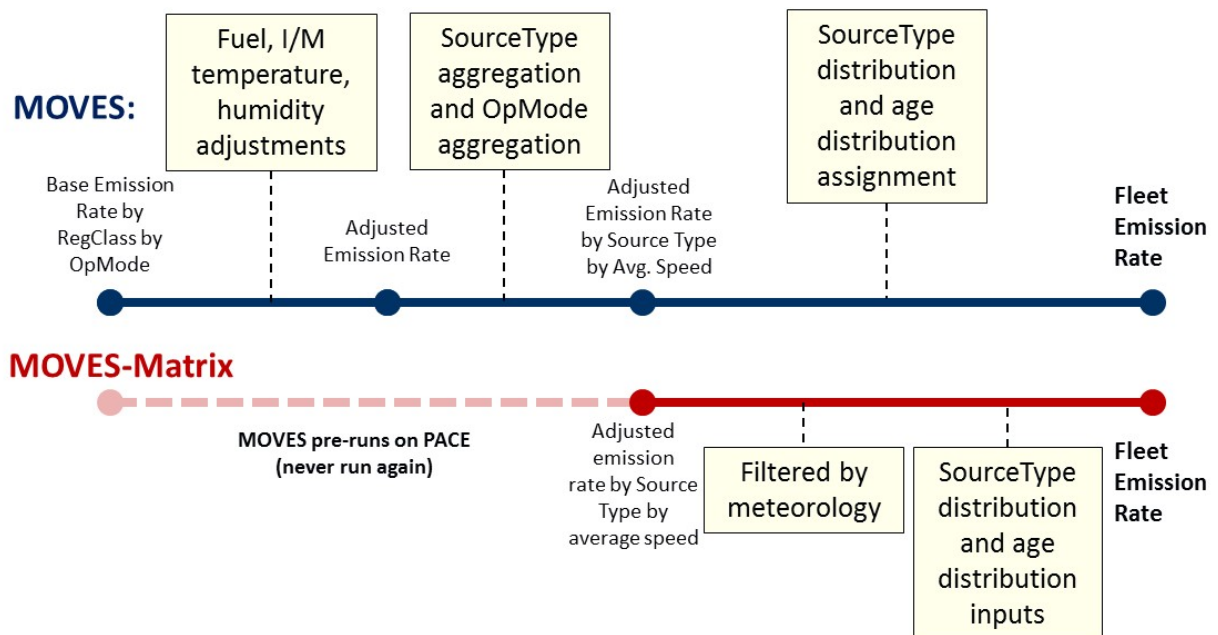

Figure 8: MOVES vs. MOVES-Matrix Working Mechanism

There are four design characteristics that contribute to the accuracy and fast processing speed of MOVES-Matrix:

- MOVES-Matrix emission rates are employed directly from MOVES runs. There are no code modifications, no correction factors, and no approximations involved, which ensure that the emission results obtained from MOVES-Matrix are exactly the same with from MOVES model.
- MOVES-Matrix allows users to assess impacts of changes in onroad operating conditions and onroad fleet composition. Rather than running MOVES again, MOVES-Matrix directly employs emission rates that have already been adjusted by fuel, meteorology and I/M strategy. No further MOVES calculations are needed. The matrix structure also facilitates sensitivity analysis of MOVES algorithms without having to run MOVES again.
- In MOVES-Matrix, the emission rates database is pre-organized by calendar year, fuel specification, I/M program, temperature, and humidity. Hence, the emission rate sub-matrix is ready to apply to specific scenarios of interest. This significantly increases the speed of the emission assignment process.

- MOVES-Matrix is open source and collaborative. Python, Java, Perl, or any other regular language scripts can be used to link MOVES-Matrix emission rates with travel demand models, traffic simulation, monitored data, and dispersion models. For example, the team recently integrated the model with VISSIM in Atlanta (Xu, et al., 2016b).

MOVES-Matrix Applications

The Georgia Tech team has implemented MOVES-Matrix in a variety of emission modeling research, including: emission impacts of HOV-HOT conversion (Xu, et al., 2014), transit eco-driving (Xu, et al., 2016), emissions benefits of transit deadheading reduction (Li, et al., 2016), individual vehicle emission modeling (Guensler, et al., 2016), MOVES sensitivity analysis (Liu, et al., 2015), a travel demand model application (Xu, et al., 2016a), and a VISSIM model applications (Xu, et al., 2016b). For each assessment, the research team demonstrated that the results from MOVES-Matrix were the same as using MOVES directly.

MOVES-Matrix Result Verification

The first assessment conducted by the research team to demonstrate that MOVES-Matrix obtains the same emissions results as applying MOVES directly was an assessment of the emission impacts of a HOV-to-HOT lane conversion in Atlanta, GA (Xu, et al., 2014). In October 2011, a 15-mile High Occupancy Vehicle (HOV) lane was converted to a High Occupancy Toll (HOT) lane on Interstate 85 in Atlanta, Georgia, as a measure to provide travel time reliability to carpools and individuals willing to pay a toll. This study investigated changes in fleet compositions and traffic operation, and utilized MOVES-Matrix to conduct the emission analysis for I-85 Highway. To verify the MOVES-Matrix application, the study also compared results from MOVES-Matrix matched with output from conventional MOVES graphic user interface (GUI). Six scenarios were considered, including the season of winter (February), spring (May), and summer (July), in the year before conversion (2011) and after conversion (2012). The detailed information for the case study is provided in Appendix C. The MOVES-Matrix outputs are within 0.0005% of the results obtained with the conventional MOVES GUI. Any potential round-off errors associated with any weighting calculations in MOVES are insignificant.

Model Run Time

A model performance comparison for run time was also conducted between the MOVES GUI and MOVES-Matrix. Per-mile segment emissions were processed for 120 transportation links, calculated for a range of 5-75 mph with specific fleet composition assigned to each link. Similarly, per mile segment emissions of 30 links were calculated for in range of 5-75 mph with specific fleet composition and operating mode distribution assigned to each link. The results of interest included THC, CO, NOx, VOC, PM₁₀, PM_{2.5}, CO₂, GHGs, and fuel consumption. The two models are set and run in the same computer with configuration of Intel(R) Xeon(R) CPU W3550 @3.07GHz, windows 7 64-bit, RAM: 6 GB.

Based on the same data input, the research team recorded the total running time for these runs in MOVES GUI and MOVES-Matrix. The comparison is shown in Table 2.

Table 2: Model Run Time Comparison

Model	Running 120 links in Speed Matrix		Running 30 links in Operating Mode Matrix	
	Run Time	Run Speed	Run Time	Run Speed
MOVES GUI	24.25 minutes	2.42 seconds	8.3 minutes	3.35 seconds
MOVES-Matrix	12 seconds	0.02 seconds	4 seconds	0.026 seconds

MOVES-Matrix saves a tremendous amount of computer run time relative to using the MOVES GUI. Using the MOVES GUI, the average speed model runs for the 120 links took 24.25 minutes to complete, while MOVES-Matrix completed the calculations in 2.42 seconds. The 30 operating mode bin runs took the MOVES GUI 8.3 minutes to complete, while MOVES-Matrix completed the runs in only 3.35 seconds. The fast calculation speed of MOVES-Matrix provides a platform that can be employed with newer and bigger datasets (e.g., INRIX GPS data, traffic simulations, smartphone data, etc.) and supports dynamic, real-time emission modeling.

Conclusions

This study introduced the MOVES-Matrix modeling approach; a high-performance emission modeling system that uses 90 billion emission rates pre-generated by MOVES, rather than performing MOVES modeling runs on the fly for transportation scenarios of interest. The MOVES-Matrix database for Atlanta and Vermont was each constructed from 146,853 MOVES runs. The scenario runs demonstrate that MOVES-Matrix can finish the emissions computation tasks 200 times faster than using the MOVES GUI and the generated results are exactly the same. In addition to its high-performance in calculation speed, we believe there are also other benefits below in applying MOVES-Matrix:

- MOVES emission rates are employed directly in MOVES-Matrix (there are no code modifications, no use of correction factors, nor any approximations employed).
- In project-level emissions analysis, users typically assume a single temperature, humidity, and fuel, and estimate the emissions impact of the changes in vehicle operations and fleet composition. Hence, the database is organized into sub-matrices that fit the users' work scheme, and allows users to conveniently and quickly assess impacts of changes in onroad operating conditions and fleet composition.
- MOVES-Matrix emission rates can be operationalized in Java, Python, Perl, or any similar scripting program to link MOVES emission rates with travel demand models, simulation models, monitored vehicle data, and dispersion modeling.
- Because the emission database of MOVES-Matrix is composed of MOVES outputs, and the model achieves the exact same results as the MOVES GUI, the research team believes that the model is ready for regulatory review and approval.
- MOVES-Matrix is an open source system that anyone can use.

- The research team is currently building an online version of MOVES-Matrix that will allow users to implement emission analysis online without ever having to run MOVES.

For regional-scale scenarios involving large number of (e.g., 74,500 in Atlanta) roadway links, the research team recommends that users track and manage fleet composition by road type and traffic analysis zones. Link speeds and volumes can be obtained from travel demand models, and/or dynamic traffic assignment. MOVES-Matrix supports batch mode processing and enable multitask runs, just as MOVES does. Each task specifies a single calendar year, meteorology, fuel supply, and fleet model year distribution. At the link level, links that have the same fleet composition could be grouped in the same task, allowing users to obtain emission rate for all speeds and for fleet compositions for multiple calendar years and meteorology scenarios. These emission rates can then be mapped back to specific links based on traffic analysis zone and link speed, and multiplied by link volumes to obtain fuel consumption and mass emissions for each link. The research team is currently implementing a MOVES-Matrix connection with the Atlanta Regional Commission's travel demand model, which will serve as a guide for MOVES-Matrix application in regional scale.

For project-level emission analysis, users can link MOVES-Matrix emission rates with traffic simulation model outputs. The simulated vehicle driving schedules (speed-time traces) for individual vehicles yield second-by-second onroad operating conditions (which translate to speed and VSP bin) that can be linked with operating mode emission rates in the matrix. For example, the research team linked MOVES-Matrix with VISSIM microscopic simulation software and predicted emissions as a function of VISSIM-simulated second-by-second vehicle trajectories (Xu, et al., 2016b). To accomplish the linkage, a local fleet composition (fleet composition for 13 source types and their onroad model year distributions) is developed for use in the VISSIM simulation and in emissions modeling. The VISSIM model is coded and calibrated to represent onroad traffic conditions. A Component Object Model (COM) interface is applied to collect network information and second-by-second speed profiles for the simulated vehicles on network. Second-by-second vehicle traces data are post-processed to obtain second-by-second operation mode bins. Finally, the applicable MOVES-Matrix operating mode bin emission rates (by county, fuel formulation, I/M strategy, and meteorology) are pulled from the MOVES-Matrix emission rate table. Emission results are calculated by matching the operation conditions for each second from simulation model with applicable MOVES-Matrix emission rates for the vehicle source type, model year, operating mode bin, and pollutant.

MOVES-Matrix also makes it easy to link onroad operating conditions, such as observed driving cycles or operating mode bin distributions. The development of MOVES-Matrix has simplified the use of large scale of traffic activity data in emission modeling, as is currently being demonstrated in a Department of Energy ARPA-E project (DOE, 2015) in Atlanta, making real-time MOVES energy consumption and emissions modeling possible.

While MOVES-Matrix provides analysts with a tremendous amount of modeling flexibility and speed to perform large-scale analysis, there are current limitations that must be addressed

before widespread use in inventory and conformity analyses can be achieved. The emission rate matrix for any region is large (around 2 GB) and must be developed through iterative runs of MOVES (146,853) on the supercomputing platform. Each matrix results from iterations across all variables except fuel specifications and inspection and maintenance program; these are defined in the matrix generation input files. This means that the matrix is only transferable from region to region if they use the same fuels and inspection and maintenance program. A new set of supercomputing runs must be implemented, and a new matrix developed, for fuel and I/M combination. The research team plans to coordinate with other research institutions to distribute the supercomputing load in 2017 and make additional matrices available to interested parties. The second major constraint to inventory modeling at this time is that the output matrix does not currently contain MOVES engine start and evaporative emissions rates. The research team plans to add both of these features in 2017. Finally, integration of the matrix approach into streamlined and automated analytical work requires, to some extent, the integration of Python programming capabilities into analytical and research teams.

References

- DOE, Department of Energy (2015). ARPA-E Announces Five New Projects to Reduce Energy Use for Transportation. ARPA-E Program Press Release. <http://arpa-e.energy.gov/?q=news-item/arpa-e-announces-five-new-projects-reduce-energy-use-transportation>.
- Guensler, R., H. Liu, X. Xu, Y. Xu, and M. Rodgers (2016a). MOVES-Matrix: Setup, Implementation, and Application. In 95th Annual Meeting of the Transportation Research Board. Washington, DC. January 2016.
- Guensler, R. H. Liu, Y. Xu, and M. Rodgers (2016b). MOVES-Matrix Energy Consumption and Emission Modeling Applied to Individual Vehicles. In *TAP 2016: 21st International Transport and Air Pollution Conference*. Lyon, France. May, 24-26, 2016.
- Guensler, R., K. Dixon, V. Elango, and S. Yoon (2004). MOBILE-Matrix: Georgia Statewide MTPT Application for Rural Areas. In *Transportation Research Record: Journal of Transportation Research Board*. Vol 1880, 2004, pp. 83-89.
- Guensler, R., M. Rodgers, J. Leonard II, and W. Bachman (2000). A Large Scale Gridded Application of the CALINE4 Dispersion Model. Transportation Planning and Air Quality IV. Arun Chatterjee, Ed. American Society of Civil Engineers. New York, NY.
- Guensler, R., and J.D. Leonard II (1995). A Monte Carlo Technique for Assessing Motor Vehicle Emission Model Uncertainty. Transportation Congress, Volume 2. American Society of Civil Engineers, New York, NY. October 1995.
- Li, H., H. Liu, X. Xu, Y. Xu, M. Rodgers, and R. Guensler (2016). Emissions Benefits from Reducing Local Transit Service Deadheading: An Atlanta Case Study. In *95th Annual Meeting of the Transportation Research Board*. Washington, DC. January 2016.
- Liu, B., and H.C. Frey (2012). Development and Evaluation of a Simplified Version of MOVES for Coupling with a Traffic Simulation Model. In *104th Annual Conference and Exhibition of Air & Waste Management Association*. San Antonio, TX, June 19-22, 2012.
- Liu, H., Y. Xu, C. Toth, M. Rodgers, and R. Guensler (2015). MOVES2014 Project-Level Sensitivity Analysis: Impacts of Onroad Fleet Composition and Operation Aggregation on Emission Results. In *108th Annual Conference and Exhibition of Air & Waste Management Association*. Raleigh, NC. June 22-25, 2015.
- USEPA, U.S. Environmental Protection Agency (2015). MOVES2014a. Retrieved from: <https://www3.epa.gov/otaq/models/moves/>
- USEPA, U.S. Environmental Protection Agency (2016). *Population and Activity of On-road Vehicles in MOVES2014*. EPA-420-R-16-003a. U.S. Environmental Protection Agency, 2016.
- Xu, X., H. Liu, Y. Xu, M. Rodgers, and R. Guensler (2016a). Regional Emission Analysis using Travel Demand Models and MOVES-Matrix. Accepted for Presentation at 2016

Transportation Planning and Air Quality Conference. Minneapolis, Minnesota. August 4-5, 2016a.

Xu, X., H. Liu, J. Anderson, Y. Xu, M. Hunter, M. Rodgers, and R. Guensler (2016b). Estimating Project-Level Vehicle Emissions with VISSIM and MOVES-Matrix. In *95th Annual Meeting of the Transportation Research Board*. Washington, DC. January 2016b.

Xu, Y., H. Liu, and R. Guensler (2015). Emission Impact of HOV to HOT Lane Conversion in I-85, Atlanta. In *107th Annual Conference and Exhibition of Air & Waste Management Association*. Long Beach, CA. June 24-27, 2015.

Xu, Y., H. Li, H. Liu, M. Rodgers, and R. Guensler (2016). *Eco-driving for Transit*. National Center for Sustainable Transportation. 2016.

Appendix A: MOVES-Matrix Structure

Input Module

Table A-1 below shows the input variables for the MOVES-Matrix. The input is generally the same with variables in the input spreadsheet for the MOVES model.

Table A-1: MOVES-Matrix Input

Table Name	Columns
calendarYear	cyld
link	linkId countyId (Optional) zoneId (Optional) roadTypeId (Optional) linkLength linkVolume linkAvgSpeed linkDescription (Optional) linkAvgGrade (Optional)
meteorology	monthId zoneId (Optional) hourId (Optional) temperature relHumidity
linkSourceTypeHour	linkId sourceTypeId sourceTypeHourFraction
sourceTypeAgeDistribution	sourceTypeId yearId ageId ageFraction
driveScheduleSecondLink*	linkId secondId in the drive schedule speed grade
opModeDistribution*	sourceTypeId hourDayId (optional) linkId opModeBin opModeFraction

** Just as with the MOVES model, if Speed-Matrix is applied, users can provide an average speed for each link (by facility type); if Operating Mode Matrix or Operating Mode Fuel Matrix is applied, besides average speed, users also need to provide either a drive schedule table (driveScheduleSecondLink) or operating mode distribution table*

(opModeDistribution) to describe onroad operations. In the MOVES opModeDistribution input table, there is a column named "polProcessId" which is required for distinguishing emissions from different vehicle activities, such as onroad exhausted emissions and start emissions. Because the current MOVES-Matrix setup provides emission rates only for onroad activity, "polProcessId" remains in the input table.

Emission Rate Database

The emission rate data in Matrix database are obtained from billions of MOVES runs across multiple scenarios. That is to say, the emission data in Matrix has been adjusted with meteorology, I/M, and fuel property, which enabled Matrix to have faster computation speed and more convenient operations compared with the MOVES model.

Database for MOVES-Matrix contains emission rates in following ranges:

- County
 - Combined with calendar year and month to apply appropriate monthly I/M strategy and fuel supply
- Pollutant:
 - All pollutant that MOVES can obtain
- Calendar years:
 - 2010-2024 (1-Year Interval)
 - 2025-2050 (5-Year Interval)
- Meteorology:
 - Temperature: 0F - 110F (1F bins)
 - Humidity (%): 0 - 100 (5% bins)
- Fuel Supply:
 - Winter (January, applies to November – March, with adequate meteorology)
 - Summer (July, applies to May – September, with adequate meteorology)
 - Transition (April, applies to April and October, with adequate meteorology)
- Source Use Type
 - All 13 MOVES source use types
- Vehicle Model Years
 - All 31 MOVES age groups (age 0-30 years)
- Average speed and road type (for Speed-Matrix)
 - Average Speed: 5 – 77 mph (1mph-bins)
 - roadTypeId: Urban unrestricted road and urban restricted road
- Operating Modes (for Operating Mode Matrix and Operating Mode Fuel Matrix)
 - All 23 running operating mode bins (opModeBin 0-40): for THC, criteria pollutants, CO₂, GHGs, and Energy

- opModeBin 300: for CH₄, N₂O

Database for Average Speed and Facility Type (Speed) Matrix

The emission rate database for Speed-Matrix consists of 146,853 tables in a comma separated variable format. A standard file naming convention is employed:

- [county]_[yyyy]_[mm]_[tt]_[hh].csv

The file name indicates a unique set of stored emission rates by County, calendar year (yyyy), month (mm), temperature (tt) in Fahrenheit, and humidity (hh) in percent. Table A-2 below presents the information of each column within the emission rate tables for Speed-Matrix.

Table A-2: Column Description of Speed-Matrix

Column	Column Name	Character Type	Description
1	cyld	Integer	Calendar year
2	monthld	Integer	Month of evaluation
3	roadTypeSpeed	Integer	Road Type and Speed roadTypeId: 4-Urban Restricted Access 5-Urban Unrestricted Access speed: 5-77 mph
4	pollutantld	Integer	MOVES pollutant ID
5	sourceTypeld	Integer	MOVES source type ID
6	modelYearld	Integer	-
7	emissionRate	Float	emissionRate: Energy unit: KJ per hour Emission unit: grams per hour

Database for the Operating Mode Matrix

The emission rate database for the Operating Mode Matrix consists of 146,853 tables in a comma separated variable format. A standard file naming convention is employed:

- [county]_[yyyy]_[mm]_[tt]_[hh].csv

The file name indicates a unique set of stored emission rates by County, calendar year (yyyy), month (mm), temperature (tt) in Fahrenheit, and humidity (hh) in percent.

Table A-3 below presents the information of each column within the emission rate tables for Operating Mode Matrix.

Table A-3: Column Description of Operating Mode Matrix

Column	Column Name	Character Type	Description
1	cyld	Integer	Calendar year
2	monthld	Integer	Month of evaluation
3	opModeBin	Integer	MOVES running operating mode bin ID
4	pollutantld	Integer	MOVES pollutant ID
5	sourceTypeld	Integer	MOVES source type ID
6	modelYearld	Integer	-
7	emissionRate	Float	Emission rate Energy in KJ per hour Emissions by pollutant in grams per hour

Database for the Operating Mode Fuel Matrix

The emission rate database for the Operating Mode Fuel Matrix consists of 146,853 tables in a comma separated variable format. A standard file naming convention is employed:

- [county]_[yyyy]_[mm]_[tt]_[hh].csv

The file name indicates a unique set of stored emission rates by County, calendar year (yyyy), month (mm), temperature (tt) in Fahrenheit, and humidity (hh) in percent. Table A-4 below presents the information of each column within the emission rate tables for the Operating Mode Fuel Matrix.

Table A-4: Column Description of Operating Mode Fuel Matrix

Column	Column Name	Character Type	Description
1	cyld	Integer	Calendar year
2	monthld	Integer	Month of evaluation
3	opModeBin	Integer	MOVES running operating mode bin ID
4	pollutantld	Integer	MOVES pollutant ID
5	sourceTypeld	Integer	MOVES source type ID
6	fuelTypeld	Integer	MOVES fuel type ID
7	modelYearld	Integer	Model year
8	emissionRate	Float	Emission rate: Energy in KJ per hour Emissions by pollutant in grams per hour

Emission rate in MOVES is presented as a function of many factors. The factors affecting emission rates, and the features of MOVES-Matrix database used to quantify each factor, are summarized in

Table A-5.

Table A-5: Emission-related Factors and Corresponding Features

Factors	Variable and Features
Air pollutant	pollutantId
Source type	sourceTypeId
Model year (age group)	modelYearId
Fuel type	fuelTypeId
Road type and average speed	roadTypeSpeed
Operating mode bin	opModeBin
Calendar year	cyId
Fuels supply	cyId and monthId (local fuel) Summer: 7(Jul), applicable to month May-Sep Winter: 1(Jan), applicable to month Dec-Mar Transition: 4(Apr), applicable to month Apr, Oct
I/M	cyId for local I/M program
Temperature	Temperature (tt)
Humidity	Humidity (hh)

- Example:

For extracting CO emission rate of a transit bus (default fuel type distribution, local fuel supply) in age of 5 years, at average speed 55mph in freeway (roadTypeId=4), under the temperature of 75F and humidity 80%, on August, 2014 in Fulton County, Atlanta. August is in range of summer in MOVES, so monthId = 7 (July) since the same fuel supply are applied. In this case, the filtering command in SQL language is:

```
SELECT emissionRate
  from Fulton_2014_7_75_80 # use Speed-Matrix outputs
WHERE
  sourceTypeId = 42 # transit bus
  and
  modelYearId = 2009 # 2014 (cyId) - 5 (age)
  and
  roadTypeSpeed = 455 # roadTypeId = 4, Average speed = 55 mph
  and
  pollutantId = 2 # pollutantId of CO
```

For extracting CO emission rate of a transit bus (default fuel type distribution, local fuel supply) in age of 5 years, at operating mode bin 21, under the temperature of 75F and humidity 80%, on August, 2014 in Fulton County, Atlanta. August is in range of summer in MOVES, so monthId = 7 (July) since the same fuel supply are applied. In this case, the filtering command in SQL language is:

```
SELECT emissionRate
  from Fulton_2014_7_75_80 # use Operating Mode Matrix outputs
WHERE
  sourceTypeId = 42 # transit bus
  and
  modelYearId = 2009 # 2014 (CYID) – 5 (age)
  and
  opModeBin = 21 # operating mode ID = 21
  and
  pollutantId = 2 # pollutantId of CO
```

For extracting CO emission rate of a diesel transit bus (local fuel supply) in age of 5 years, at operating mode bin 21, under the temperature of 75F and humidity 80%, on August, 2014, in Fulton County, Atlanta. August is in range of summer in MOVES, so the monthId = 7 (July) since the same fuel supply are applied. In this case, the filtering command in SQL is:

```
SELECT emissionRate
  from Fultonfuel_2014_7_75_80 # use Operating Mode Fuel Matrix Outputs
WHERE
  sourceTypeId = 42 # transit bus
  and
  modelYearId = 2009 # 2014 (CYID) – 5 (age)
  and
  opModeBin = 21 # operating mode ID = 21
  and
  fuelTypeId = 2 # fuelTypeId of diesel
  and
  pollutantId = 2 # pollutantId of CO
```

Output Module

The MOVES-Matrix output module reports contain the same emission results as MOVES model runs. Mass emissions results are stored by vehicle source type and link in table “resultEmissionAmountByLinkSourceType,” and for each link in table “resultEmissionAmountByLink.” Emission rate results are stored by vehicle source type and link in table “resultEmissionRateByLinkSourceType” and by link in table “resultEmissionRateByLink.” Because the MOVES-Matrix input files are iterated through specific uniform sub-fleets, where all vehicles per iteration are assumed to be composed of one source type, model year, etc., the MOVES-Matrix output files provide very specific emission rates for use in any scenario. For

traditional regional emissions inventory analyses that employ emission rates by average speed and facility type, the emission rates in Speed-Matrix can be employed. Given a second-by-second driving schedule, and a specified onroad fleet composition, the Operating Mode Matrix and Operating Mode Fuel Matrix emission rate outputs can be used to generate second-by-second emission rates for all manner of microscale analyses. Table A-6 summarizes the MOVES-Matrix output tables and their contents.

Table A-6: MOVES-Matrix Output Structure

Category	Tables	Variables
Emission Amount	resultEmissionAmountByLinkSourceType	linkId sourceTypeId pollutantId emissionByLinkSourceType
	resultEmissionAmountByLink	linkId pollutantId emissionByLink
Emission Rate	resultEmissionRateByLinkSourceType	linkId sourceTypeId pollutantId emissionRateByLinkSourceType
	resultEmissionRateByLink	linkId pollutantId emissionRateByLink
Second-by-second Emission Rate	resultSecEmission	linkId timeId emissionRate

The research team has generated MOVES Matrix emission rates for Atlanta and Vermont for all 13 source types, all 31 model years, calendar years in intervals of 1 year from 2010 to 2025, and in intervals of 5 years for 2025 to 2050 (a total of 21 years, and I/M strategy by calendar year), for each local fuel (Summer fuel, Winter fuel, and Transition fuel), meteorology (Temperature: 0-110° F in 1° F-bin intervals, 111 bins in total; humidity: 0%-100% in 5%-bin intervals, 21 bins in total). A total of 146,853 scenarios were created for each MOVES-Matrix version for regional analysis (21 years * 3 local fuels for each year * 111 temperatures * 21 humidity). The fuel region and I/M program of counties throughout the Atlanta Metro area and throughout all of Vermont are the same. So, it was not necessary to run all counties for these two regions. Fulton County was run for Atlanta, and Bennington County was run for Vermont. In total, 90 billion emission rates were generated for MOVES-Matrix for these two regions.

Appendix B: MOVES-Matrix Algorithms

The MOVES-Matrix process uses almost the exact same input as MOVES, but records the quantities and rate of emissions in spreadsheet form. Depending on the input resource, users can choose to use the Speed Bin Matrix calculator, which uses average speed inputs, or the Operating Mode Bin matrix calculator, which uses a driving schedule or operating mode distribution as an input. Detailed algorithms for these two calculators are presented below.

Speed-Matrix

The overview of data flow diagram and calculation steps for speed-bin matrix is presented in Figure A-1 and Table A-7 below.

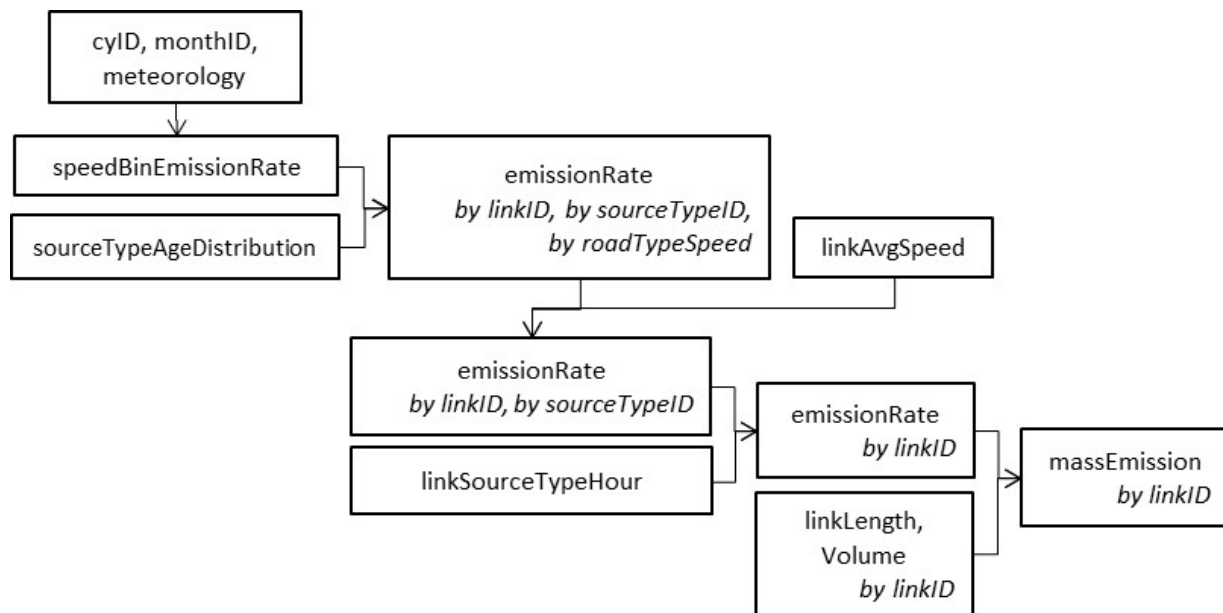

Figure A-1: Speed-Matrix Data Flow Diagram

Motivated by the display form in MOVES Software Design and Reference Manual, the algorithm lists the input variables, output variables, and calculation logistics for each step.

Table A-7: Overview of Calculation Steps for Speed-bin Matrix

Step 1	Select the emission rate table need to be used by calendar year, month, temperature and humidity of interest
Step 2	Calculate emission rate by source type, by speed bin and by road type with age distribution applied
Step 3	Calculate emission rate by source type by link of interest
Step 4	Calculate emission rate (per mile) by link
Step 5	Calculate mass emission by link

Step 1: Select the Emission Rate Table
(calendar year, month, temperature and humidity of interest)

Input Variables:

calendarYear.cylId
meteorology.monthId
meteorology.temperature
meteorology.relHumidity

Output Variables:

county_yyyy_mm_tt_hh

Calculation:

Select Table county_yyyy_mm_tt_hh as the emission calculation table

Where:

county = countyId
yyyy = calendarYear.cylId
mm = [if meteorology.monthId is between November and March, select 1 (January), else if meteorology.monthId is between May and September, select 7 (July), else if meteorology.monthId is April or October, select 4 (April)]
tt = meteorology.temperature
hh = meteorology.relHumidity
pollutantId = {pollutant of interest}

**The unit of emission rate in emission rate database grams per mile for pollutant and GHGs, and KJ per mile for energy.*

Step 2: Calculate emission rate by source type, by speed bin and by road type with age distribution applied

Input Variables:

county_yyyy_mm_tt_hh (from step 1)
sourceTypeAgeDistribution.sourceTypepeld
sourceTypeAgeDistribution.ageId
sourceTypeAgeDistribution.ageFraction

Output Variables:

emissionRate (per mile)
by sourceTypepeld , by roadTypeSpeed with age distribution applied

Calculation:

For each pollutant, each source type, each road type, and for each speed bin:

$$\text{emissionRate}_{\text{sourceTypeID,roadTypeSpeed}} = \sum_{\text{AgeID}=0}^{30} (\text{ageFraction} \times \text{county_yyyy_mm_tt_hh. emissionRate})$$

Step 3: Calculate emission rate (per mile) by source type by link of interest**Input Variables:**

link.linkId
 link.roadTypeId
 link.linkAvgSpeed
 emissionRate (from Step 2)

Output Variables:

emissionRate (per mile) (by sourceTypeId and by linkId)

Calculation:

For each pollutant, each link, and each source type:

$$\text{emissionRate}_{\text{linkID,sourceTypeID}} = \text{emissionRate}_{\text{sourceTypeID,roadTypeSpeed}}$$

Where:

Road type = link.roadTypeId
 and
 Speed = link.linkAvgSpeed

Step 4: Calculate emission rate (per mile) by Link**Input Variables:**

linkSourceTypeHour.linkId
 linkSourceTypeHour.sourceTypeId
 linkSourceTypeHour.sourceTypeHourFraction
 link.linkId
 emissionRate (from Step 3)

Output Variables:

emissionRate (per mile), by linkId

Calculation:

For each pollutant, each link:

$$\text{emissionRate}_{\text{linkID}} = \sum_{\text{sourceTypeID}}^{13} (\text{sourceTypeHourFraction} \times \text{emissionRate}_{\text{linkID,sourceTypeID}})$$

Step 5: Calculate mass emission by Link

Input Variables:

- link.linkId
- link.linkLength
- link.linkVolume
- emissionRate (from Step 4)

Output Variables:

- massEmission (by linkId)

Calculation:

For each pollutant, each link:

$$\text{massEmission}_{linkID} = \text{emissionRate}_{linkID} \times \text{linkLength} \times \text{linkVolume}$$

Operating Mode Matrix

Figure A-2 and Table A-8 below present an overview of the data flow diagram and calculation steps for the operating mode matrix. The overall procedure is similar with speed-bin matrix except the added steps to calculate VSP and generate operation mode distribution.

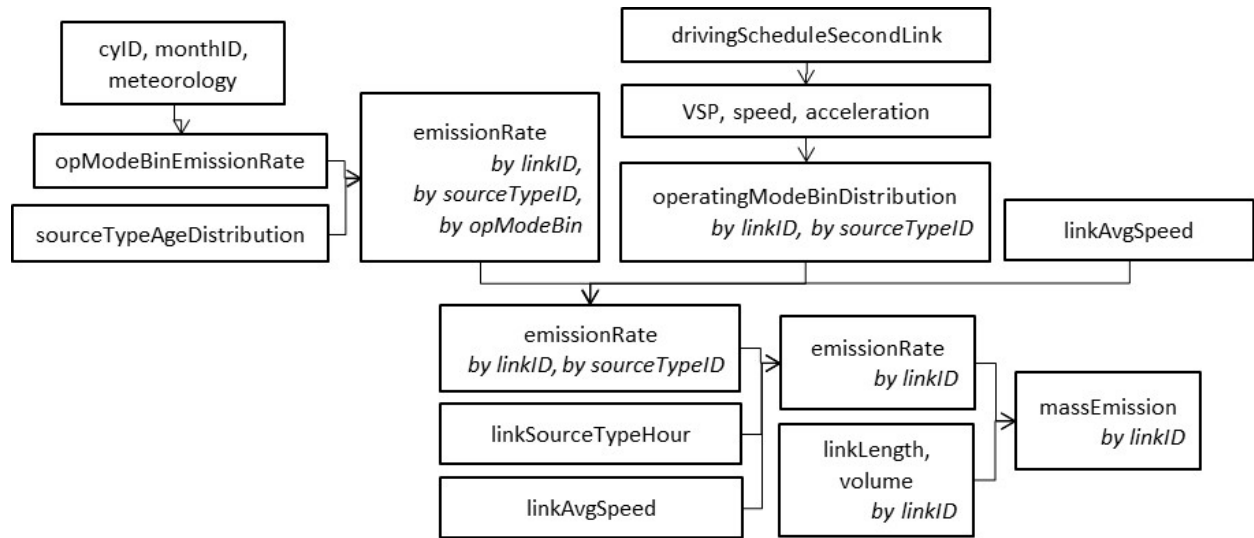

Figure A-2: Operating Mode Matrix Data Flow Diagram

The recommended algorithm for mass emission and emission rate processing are described below. The description is for the Operating Mode Matrix version. Users who need to obtain the emissions for specific fuel types can use Operating Mode Fuel Matrix version, which adds a simple filter condition to specify fuel type for the matrix pull.

Table A-8: Overview of Calculation Steps for Operating Mode Bin Matrix

Step 1	Select the emission rate table need to be used by calendar year, month, temperature and humidity of interest
Step 2*	Calculate second-by-second VSP by source type and by link of interest
Step 3*	Classify second-by-second operating mode bin by source type and by link of interest
Step 4*	Generate operating mode distribution by source type and by link of interest
Step 5	Calculate emission rate by source type and by operating mode bin with age distribution applied
Step 6	Calculate emission rate by source type by link of interest
Step 7	Calculate emission rate (per mile) by link
Step 8	Calculate mass emission by link

**Steps 2 through 4 are needed only when a driving schedule is provided. If operating mode distribution is directly used for operation, then the users can skip these 3 steps and go to Step 5*

Step 1: Identify the emission rate table needed (use calendar year, month, temperature, and humidity of interest)

Input Variables:

calendarYear.cylId
 meteorology.monthId
 meteorology.temperature
 meteorology.relHumidity

Output Variables:

county_yyyy_mm_tt_hh

Calculation:

Select Table county_yyyy_mm_tt_hh as emission calculation table

Where:

yyyy = calendarYear.cylId
 mm = [if meteorology.monthId is between November and March, select 1 (January), else if meteorology.monthId is between May and September, select 7 (Jul.), else if meteorology.monthId is April or October, select 4 (April)]
 tt = meteorology.temperature
 hh = meteorology.relHumidity
 pollutantId in {pollutant of interest}

Step 2: Calculate second-by-second VSP by source type and by link of interest

Input Variables:

driveScheduleSecondLink.linkId
driveScheduleSecondLink.secondId
driveScheduleSecondLink.speed
driveScheduleSecondLink.grade
sourceUseTypePhysics.sourceTypeId
sourceUseTypePhysics.rollingTermA
sourceUseTypePhysics.rotatingTermB
sourceUseTypePhysics.dragTermC
sourceUseTypePhysics.sourceMass
sourceUseTypePhysics.fixedMassFactor
constantTerm1: 0.44704-conversion miles per hour to meters per second
constantTerm2: 9.81-gravitational constant meter per sec²

Output Variables:

linkDriveSchedule.speed, acceleration, and VSP

Calculation:

For each source type and each second:

VSP =

$$\begin{aligned} & \left(\frac{\text{rollingTermA}}{\text{fixedMassFactor}} \right) \times \text{speed} \times 0.44704 \\ & + \left(\frac{\text{rollingTermB}}{\text{fixedMassFactor}} \right) \times (\text{speed} \times 0.44704)^2 \\ & + \left(\frac{\text{rollingTermB}}{\text{fixedMassFactor}} \right) \times (\text{speed} \times 0.44704)^3 \\ & + \left(\frac{\text{sourceMass}}{\text{fixedMassFactor}} \right) \left(\text{acceleration} + \sin \left(\text{atan} \left(\frac{\text{grade}}{100} \right) \right) \times 9.81 \right) \times \text{speed} \times 0.44704 \end{aligned}$$

Where:

$$\text{acceleration} = \text{speed}(t) - \text{speed}(t-1)$$

Step 3: Classify second-by-second operating mode by source type and by link of interest

Input Variables:

linkDriveSchedule.speed, acceleration, and VSP (from Step 2)

Output Variables:

Operating Mode Bin (opModeBin)

Calculation:

Classify second-by-second operating mode bin according to VSP, speed, and acceleration (for brake bin).

Table A-9 below shows the classification scheme of operating mode.

Table A-9: Operating Mode Definitions

opModeBin	Operating Mode Description
0	Braking
1	Idling
11	Low Speed Coasting; $VSP < 0$; $1 \leq \text{Speed} < 25$
12	Cruise/Acceleration; $0 \leq VSP < 3$; $1 \leq \text{Speed} < 25$
13	Cruise/Acceleration; $3 \leq VSP < 6$; $1 \leq \text{Speed} < 25$
14	Cruise/Acceleration; $6 \leq VSP < 9$; $1 \leq \text{Speed} < 25$
15	Cruise/Acceleration; $9 \leq VSP < 12$; $1 \leq \text{Speed} < 25$
16	Cruise/Acceleration; $12 \leq VSP$; $1 \leq \text{Speed} < 25$
21	Moderate Speed Coasting; $VSP < 0$; $25 \leq \text{Speed} < 50$
22	Cruise/Acceleration; $0 \leq VSP < 3$; $25 \leq \text{Speed} < 50$
23	Cruise/Acceleration; $3 \leq VSP < 6$; $25 \leq \text{Speed} < 50$
24	Cruise/Acceleration; $6 \leq VSP < 9$; $25 \leq \text{Speed} < 50$
25	Cruise/Acceleration; $9 \leq VSP < 12$; $25 \leq \text{Speed} < 50$
27	Cruise/Acceleration; $12 \leq VSP < 18$; $25 \leq \text{Speed} < 50$
28	Cruise/Acceleration; $18 \leq VSP < 24$; $25 \leq \text{Speed} < 50$
29	Cruise/Acceleration; $24 \leq VSP < 30$; $25 \leq \text{Speed} < 50$
30	Cruise/Acceleration; $30 \leq VSP$; $25 \leq \text{Speed} < 50$
33	Cruise/Acceleration; $VSP < 6$; $50 \leq \text{Speed}$
35	Cruise/Acceleration; $6 \leq VSP < 12$; $50 \leq \text{Speed}$
37	Cruise/Acceleration; $12 \leq VSP < 18$; $50 \leq \text{Speed}$
38	Cruise/Acceleration; $18 \leq VSP < 24$; $50 \leq \text{Speed}$
39	Cruise/Acceleration; $24 \leq VSP < 30$; $50 \leq \text{Speed}$
40	Cruise/Acceleration; $30 \leq VSP$; $50 \leq \text{Speed}$

Step 4: Generate operating mode distribution by source type and by link of interest**Input Variables:**

opModeBin (from Step 3)

Output Variables:

opModeDistribution.sourceTypeID
opModeDistribution.linkID
opModeDistribution.opModeBin
opModeDistribution.opModeFraction

Calculation:

For each sourceTypeID and each pollutant within the link, generate percentage of each operating mode bin (opModeBin) based on the Step 3

Step 5: Calculate emission rate (per hour) by source type and by operating mode bin with age distribution applied

Input Variables:

sourceTypeAgeDistribution.sourceTypeID
sourceTypeAgeDistribution.ageID
sourceTypeAgeDistribution.ageFraction
opModeDistribution.opModeBin

Output Variables:

emissionRate (per hour)
(by sourceTypeID and by opModeBin with age distribution applied)

Calculation:

For each pollutant, each source type, and each opModeBin:

$$\text{emissionRate}_{\text{sourceTypeID,opModeBin}} = \sum_{\text{ageID}=0}^{30} (\text{ageFraction} \times \text{county_yyyy_mm_tt_hh. emissionRate})$$

Step 6: Calculate emission rate (per hour) by source type by link of interest

Input Variables:

opModeDistribution.sourceTypeID
opModeDistribution.linkID
opModeDistribution.opModeBin
opModeDistribution.opModeFraction
emissionRate (from Step 5)

Output Variables:

emissionRate (per hour) (by sourceTypeID and by linkID)

Calculation:

For each pollutant, each link, and each source type:

$$\text{emissionRate}_{\text{LinkID,SourceTypeID}} = \sum_{\text{opModeBin}}^{23} (\text{opModeFraction}_{\text{linkID,sourceTypeID}} \times \text{emissionRate}_{\text{sourceTypeID,opModeBin}})$$

Step 7: Calculate Emission Rate (per mile) by Link**Input Variables:**

linkSourceTypeHour.linkId
 linkSourceTypeHour.sourceTypeId, linkSourceTypeHour.sourceTypeHourFraction
 link.linkId
 link.linkAvgSpeed
 emissionRate (from Step 6)

Output Variables:

emissionRate (per mile), by linkId

Calculation:

For each pollutant, for each link:

$$\text{emissionRate}_{\text{linkID}} = \sum_{\text{sourceTypeID}}^{13} (\text{sourceTypeHourFraction} \times \text{emissionRate}_{\text{linkID,sourceTypeID}}) / \text{linkAvgSpeed}$$

Step 8: Calculate Mass Emission by Link**Input Variables:**

link.linkId
 link.linkLength
 link.linkVolume
 emissionRate (from Step 7)

Output Variables:

massEmission (by linkId)

Calculation:

For each pollutant, each linkId:

$$\text{massEmission}_{\text{linkID}} = \text{emissionRate}_{\text{linkID}} \times \text{linkLength} \times \text{linkVolume}$$

Appendix C: MOVES-Matrix Verification – Input and Results

In general, after the HOV/HOT conversion, more passenger cars, fewer light-duty trucks, and fewer heavy duty trucks were using the HOT lane. The share of buses stayed relatively stable because express bus use dominates bus activity. In the general purpose lanes, the share of passenger cars decreased by 4%, and light-duty trucks increased by about 4%.

Table A-10: Vehicle Type Distribution, Traffic Volume, and Operating Speed

	2011-Genral Purpose Lanes	2012-Genral Purpose Lanes	2011-HOV Lane	2012-HOT Lane
Vehicle Type Distribution				
Motorcycle	0.09%	0.09%	1.95%	0.84%
Passenger Car	50.22%	50.76%	42.73%	53.78%
Passenger Truck	13.41%	10.96%	0.00%	28.44%
Light Commercial Truck	29.82%	32.81%	53.69%	14.98%
Intercity bus	0.00%	0.01%	0.13%	0.45%
Transit Bus	0.00%	0.00%	1.04%	1.18%
School Bus	0.01%	0.05%	0.00%	0.00%
Refuse Truck	0.01%	0.05%	0.00%	0.00%
Single Short-haul Truck	1.55%	1.37%	0.43%	0.31%
Single Long-haul Truck	0.11%	0.10%	0.03%	0.02%
Motor Home	0.01%	0.04%	0.00%	0.00%
Combination Short-haul Truck	2.00%	1.58%	0.00%	0.00%
Combination Long-haul Truck	2.77%	2.19%	0.00%	0.00%
Volume (veh per hour)	8568	7920	1260	1200
Speed (mph)	39	37	41	39

In terms of age distribution, HOT lanes exhibit a higher percentage of newer vehicles than the HOV lanes did. The general purpose lanes saw a slight decrease in the percentage of newer passenger cars and light-duty trucks after conversion. For all lanes combined, the average vehicle age increased by about 0.6 years between 2011 (before conversion) and 2012 (after conversion), which can be largely attributed to the region-wide trend that fleets grow older each year, irrespective of the corridor. A slight shift in older vehicles from the HOV lane to the general purpose lanes does appear to have occurred and the overall fleet did age, but by less than one year over the one-year period. Total traffic volume across all lanes decreased by about 5% (with a larger decrease in the morning than in the afternoon) after HOV/HOT conversion.

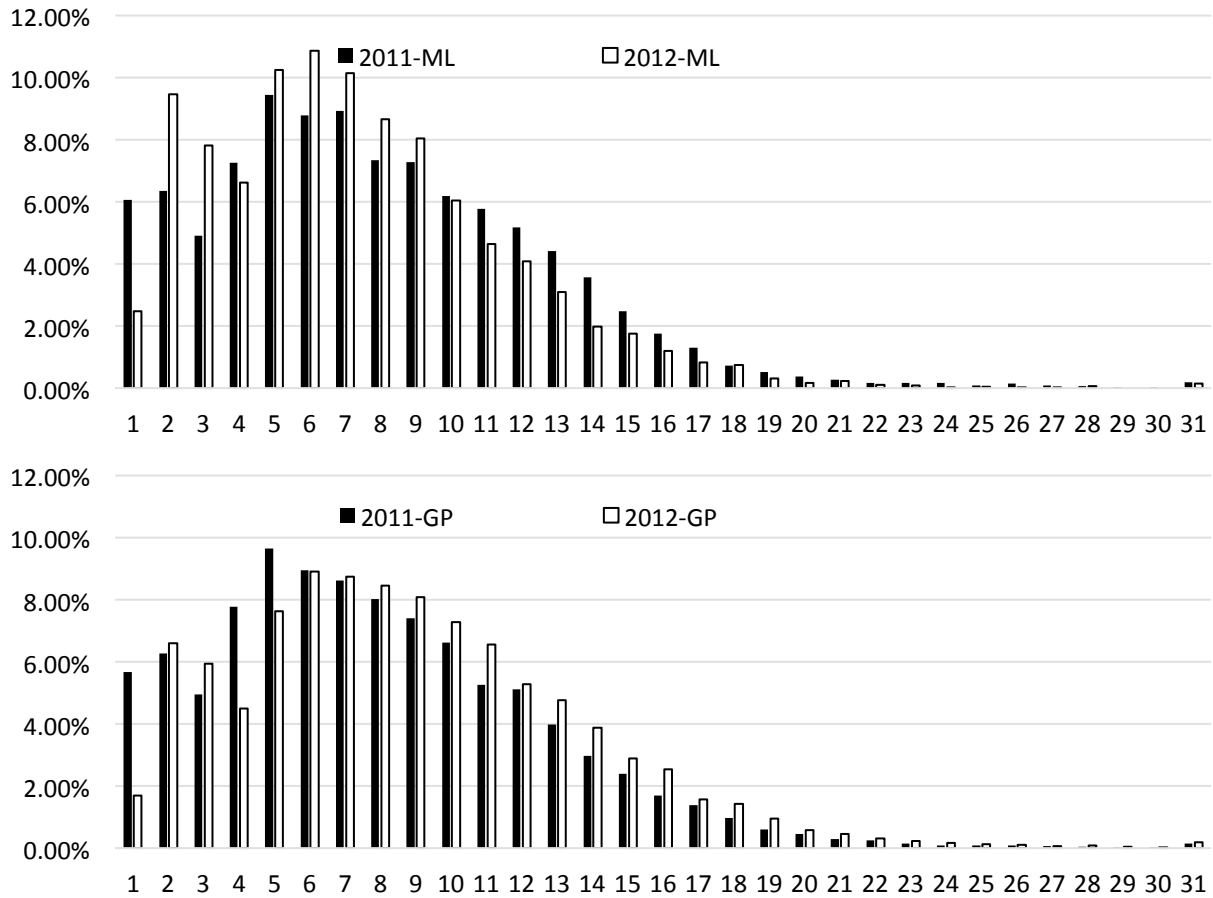

Figure A - 3 Age distribution of managed lane (HOV and HOT) and general purpose (GP) lanes

Table A-11 and Table A-12 below shows the CO₂, HC, VOC, CO, NO_x, PM₁₀ and PM_{2.5} emission results of general purpose lanes and managed lanes in six scenarios. The output of MOVES-Matrix is consistent with conventional MOVES GUI with round off errors within 0.0005%.