

# Lawrence Berkeley National Laboratory

## Recent Work

### **Title**

PHYSICS DIVISION ANNUAL REPORT, 1 JAN-31 DEC 1984

### **Permalink**

<https://escholarship.org/uc/item/9fn8v6tf>

### **Author**

Trilling, G.H.

### **Publication Date**

1985-10-01

LBL-19445-2

RECEIVED UC-34  
LAWRENCE  
BERKELEY LABORATORY

APR 7 1986

LIBRARY AND  
DOCUMENTS SECTION

# PHYSICS DIVISION

**TWO-WEEK LOAN COPY**

*This is a Library Circulating Copy  
which may be borrowed for two weeks*

**ANNUAL REPORT**

October 1985

**Lawrence Berkeley Laboratory  
University of California  
Berkeley, California**

Prepared for the U.S. Department of Energy  
Under Contract No. DE-AC03-76SF00098

LBL-19445-2

## **DISCLAIMER**

This document was prepared as an account of work sponsored by the United States Government. While this document is believed to contain correct information, neither the United States Government nor any agency thereof, nor the Regents of the University of California, nor any of their employees, makes any warranty, express or implied, or assumes any legal responsibility for the accuracy, completeness, or usefulness of any information, apparatus, product, or process disclosed, or represents that its use would not infringe privately owned rights. Reference herein to any specific commercial product, process, or service by its trade name, trademark, manufacturer, or otherwise, does not necessarily constitute or imply its endorsement, recommendation, or favoring by the United States Government or any agency thereof, or the Regents of the University of California. The views and opinions of authors expressed herein do not necessarily state or reflect those of the United States Government or any agency thereof or the Regents of the University of California.

LBL-19445  
UC-34

## **PHYSICS DIVISION**

G. H. Trilling  
Division Head

### **ANNUAL REPORT** **1 January - 31 December 1984**

Lawrence Berkeley Laboratory  
University of California  
Berkeley, California 94720

Major portions of this work were supported by the Director, Office of Energy Research, Offices of High Energy and Nuclear Physics and Basic Energy Sciences of the U.S. Department of Energy under Contract No. DE-AC03-76SF00098. Additional support was provided by the National Science Foundation, the National Aeronautics and Space Administration, and the University of California.



# CONTENTS

|                    |   |
|--------------------|---|
| Introduction ..... | 1 |
|--------------------|---|

## EXPERIMENTAL PHYSICS

|  |    |
|--|----|
| <b>Research on <math>e^+e^-</math> Annihilation</b> .....                    | 5  |
| PEP-4/9 TPC Collaboration .....  | 5  |
| The MARK II Detector .....   | 18 |
| <b>Research at Fermilab</b> .....  | 24 |
| Hadron Calorimeter for CDF Collaboration .....                               | 24 |
| DØ Experiment at the Fermilab Antiproton-proton Collider .....               | 25 |
| Neutrino Interactions at Fermilab .....                                      | 27 |
| <b>Experiments at TRIUMF</b> .....   | 27 |
| Search for Effects of a Right-Handed Gauge Boson .....                       | 27 |
| Measurement of the Muon Decay Asymmetry Parameter .....                      | 28 |
| <b>Superconducting Super Collider (SSC)</b> .....                            | 29 |
| SSC Dipole Designs .....   | 29 |
| Experiments at the SSC .....   | 29 |
| <b>Double Beta Decay</b> .....   | 31 |
| Neutrinoless Double Beta Decay of Molybdenum 100 .....                       | 31 |
| $^{76}\text{Ge}$ Double Beta Decay .....                                     | 31 |
| <b>Berkeley Particle Data Center</b> .....                                   | 32 |
| <b>High Energy Astrophysics and Interdisciplinary Experiments</b> .....      | 36 |
| Supernovae Detection .....   | 36 |
| Nemesis Search .....   | 36 |
| Pulsar Observations .....  | 37 |
| The Cyclotron .....  | 37 |
| Cosmic Background Radiation/Primordial Blackbody Radiation .....             | 37 |
| <b>Detector Research and Development</b> .....                               | 39 |
| R&D Using the TPC Concept .....  | 39 |
| Scintillating Glass R&D .....  | 40 |
| Feasibility Studies of a High Resolution Sampling Radial Drift Chamber ..... | 40 |
| Gas-Filled and Solid State Detectors .....                                   | 41 |
| <b>Computation and Communication</b> .....                                   | 43 |
| <b>Instrument Science and Engineering</b> .....                              | 45 |

## THEORETICAL PHYSICS RESEARCH

|  |    |
|--|----|
| <b>Particle Physics</b> .....                        | 51 |
| Electroweak Interactions .....                       | 51 |
| Strong Interaction Phenomenology .....               | 52 |
| Nonperturbative Dynamics .....                       | 52 |
| Supersymmetry .....                                  | 52 |
| Cosmology and Particle Physics .....                 | 53 |
| 1984 Workshop on Electroweak Symmetry Breaking ..... | 56 |

## MATHEMATICS

|  |    |
|--|----|
| <b>Mathematics</b> .....                                   | 61 |
| Applied Analysis .....                                     | 61 |
| Computational Mathematics .....                            | 62 |
| Numerical Methods for Partial Differential Equations ..... | 62 |
| <b>Appendix: Research Progress Meetings</b> .....          | 69 |

## INTRODUCTION

This report summarizes the research programs of the Physics Division of the Lawrence Berkeley Laboratory during calendar 1984. The Division's principal activity is research in theoretical and experimental high energy physics, and development of such tools as sophisticated detectors to carry out that research. The physics activity also includes a program in astrophysics, and the activities of the Particle Data Group whose compilations serve the worldwide high energy physics community. Finally, in addition to the physics program, there is a smaller but highly significant research effort in applied mathematics.

The Division draws strength from its close association with the Berkeley campus of the the University of California. Both faculty and graduate students from the campus are actively involved in the research programs of the Division. Within the physics area, seven students completed their Ph.D.'s in 1984.

The year 1984 was an important one for the Division's largest single effort, the Time Projection Chamber (TPC) program. The two collaborations involved with the TPC and the other elements of that sophisticated detector, namely PEP-4 and PEP-9, merged to provide a single enlarged group with greater strength and flexibility. This group now consists of institutions besides LBL. Its responsibilities for 1984 involved on the one hand the preparation of the full detector with all systems up to design specifications for operation in fall 1984, and on the other hand the analysis of the data taken in earlier running.

Due to the failure of the superconducting magnet mechanical support system, the TPC had been out of the PEP beam since fall 1983. The preparation efforts included the design and installation of a new magnet support system, reconstruction of two calorimeter modules which had been damaged by unexpected chemical processes, search for a new calorimeter gas to avoid these harmful reactions, and the construction of a pulsed grid system to eliminate distortions due to positive ion loading. This whole program was successfully completed in time for turn-on in October 1984 and preliminary results from the new running show remarkable improvement in the data quality.

The analysis of earlier TPC data has led to numerous published papers with particular emphases on studies of the fragmentation of quarks and gluons into hadrons. In these, the TPC particle identification capability has provided a hitherto unattained level of detail. Toward the end of 1984, the PEP-4/PEP-9 group played a major role in a workshop intended to examine the potential physics interest in a PEP luminosity increase by a factor of about 5. This workshop activity extended into 1985, but its conclusion was a strong physics case for the luminosity upgrade.

The MARK II program at PEP, involving a collaboration with SLAC and Harvard, terminated in the spring of 1984 to permit the detector modifications required for eventual operation at the Stanford Linear Collider (SLC). The data analysis has continued with particular emphasis on measurements of lifetimes of heavy quarks and leptons.

The Division has been involved in a major way in the MARK II detector modifications for SLC. It had full responsibility for the construction of end cap electromagnetic calorimeters which were essentially complete by the end of 1984. Beam tests in early 1985 have confirmed that the calorimeter performance fully meets design goals.

LBL scientists are also involved in a collaborative effort with SLAC physicists in the development of an ultra-high-resolution vertex drift chamber for use with the MARK II at SLC. This effort made substantial progress in 1984 and is vigorously continuing in 1985.

The Division is participating in a very substantial way in the collaborative construction of the Collider Detector at Fermilab (CDF) facility intended for the study of  $p\bar{p}$  collisions at the Tevatron at an energy close to 2 TeV, the highest available anywhere in the world. Major progress in the construction and testing of the approximately 500 modules of the end-plug hadron calorimeter was achieved. An extensive beam test of two full length 30 degree sectors of the calorimeter is being carried out in early 1985. First physics with CDF is scheduled for late 1986.

In the summer of 1984, LBL physicists joined another large collaborative detector effort intended to develop an instrument complementary to the CDF for use at the  $D\bar{D}$  interaction region of the Tevatron collider. LBL

responsibilities include coordination of the central detector part of the  $D\bar{D}$  facility and construction of a micro-vertex drift chamber to provide high resolution tracking.

Detector research and development activities have traditionally been a strong component of the Physics Division experimental program. Part of these activities are in direct support of construction responsibilities for specified detectors while another part is of a more long range character.

The MARK II and the TPC both required substantial R&D activities in 1984 in support of the construction efforts. In addition, longer range developmental work included feasibility studies for a novel high resolution radial drift chamber, investigations of CCD devices as high resolution particle detectors, studies of scintillating glass, development of tracking imaging Cerenkov counters, and studies of non-crystalline solid state detectors.

For some fundamental issues of elementary particle physics such as the detection of finite neutrino mass, non-accelerator experiments may be best suited. One class of such experiments is the search for neutrinoless double beta decay. A collaboration between a U.C. Santa Barbara group and an LBL group from the Engineering and Technical Services Division has developed a rather large germanium detector to observe double beta decay in  $^{76}\text{Ge}$  and has, by early 1985, begun underground counting at the Oroville Power Dam in Northern California. A totally different detector to search for decay of  $^{100}\text{Mo}$  is being developed by an LBL-Mt. Holyoke-University of New Mexico collaboration.

The Particle Data Group has continued to provide the world high energy physics community with the latest compiled data on elementary particles and their interactions, as well as information on current detectors and experiments. Highlights for 1984 included a new edition of the Review of Particle Properties, the development of a proposal to standardize the names of hadrons, and major progress on the PDG SLAC-SPIRES interactive computer system of high energy physics databases.

Research by the Theoretical Physics Group has ranged over a broad spectrum from highly theoretical work to activity closely related to current experiments and to the design of future facilities. The major interests are in the areas of electroweak interactions, strong interaction phenomenology, non-perturbative dynamics, supersymmetry and the relation between cosmology and particle physics. Much effort has been devoted to studies in support of the Superconducting Super Collider (SSC) including the organization at LBL of a three week workshop on Electroweak Symmetry Breaking, just prior to the 1984 Snowmass meeting on the SSC.

A small but important part of the Division's experimental research program is devoted to topics in Astrophysics. One substantial activity was the completion of a charge-coupled imaging system to be used in 1985 for two purposes: 1) the search of several thousand galaxies for new supernovae in the early periods of their explosion and 2) the search for Nemesis, a hypothesized companion star of the sun. The Nemesis proposal is intended to explain apparent periodicities in major extinctions of living species (such as the dinosaurs) and in the ages of large impact craters. Another major activity is the study of the cosmic background radiation, including its angular distribution, polarization and spectrum.

The research efforts in Mathematics cover a broad range in the areas of Applied Analysis (capillarity, inverse problems, lattice models), Computational Mathematics (elliptic partial differential equations, stochastic differential equations) and Numerical Methods in Partial Differential Equations (turbulence, hyperbolic equations, fronts and interfaces, reacting flows).

It is noteworthy that in summer 1984 the SSC Central Design Group, under the leadership of Maury Tigner, chose LBL as the site for its headquarters. J. D. Jackson, the previous Head of the Physics Division who, in fact, still guided the Division in the first half of 1984, has become Deputy Director of the SSC-CDG. The Division owes much to his leadership and wishes him well in his new responsibilities.

The above introduction has only given a glimpse into the activities of the Physics Division. These are exciting times for high energy physics and we at LBL are pleased and proud to be on the vanguard in the development of new knowledge and new technology.

George H. Trilling

# **EXPERIMENTAL PHYSICS**

## EXPERIMENTAL PHYSICS STAFF

Abrams, Gerald S.  
Alvord, Charles W.  
Armstrong, Frances E.  
Baird, Joan G.  
Barnes, Alan V.  
Barnett, R. Michael  
Barrera, Josephine R.  
Bingham, Harry H.  
Birge, Robert W.  
Bistirlich, James A.  
Blackman, Donald L.  
Bronnenberg, Patricia A.  
Bross, Alan D.  
Carithers, William C., Jr.  
Carr, John  
Chamberlain, Owen  
Chew, Denyse M.  
Chinowsky, William  
Clark, Alan R.  
Cordier, Alain  
Covey, Charles L.  
Crawford, Frank S.  
Crowe, Kenneth M.  
Dahl, Orin I.  
Daly, Sue  
Davenport, Julia A.  
Davis, Richard L.  
Dodge, William J.  
Drell, Persis

Eberhard, Philippe H.  
Edwards, Pamela  
Ely, Robert P., Jr.  
Franklin, Melissa E.  
Fuzesy, Raymond Z.  
Galtieri, Angela  
Garnjost, Margaret A.  
Gibson, George H.  
Gidal, George  
Golden, Marian P.  
Goldhaber, Gerson  
Goozen, Frederick R.  
Greer, Rebecca  
Haber, Carl  
Haggerty, John S.  
Harding, Peter C.  
Heatlie, Valerie K.  
Herrup, David A.  
Hodess, Beth  
Hofmann, Werner  
Johansen, Walter E.  
Johnson, Alfred  
Jones, Donna G.  
Kadyk, John A.  
Kaplan, Selig N.  
Kaye, Stephen  
Kennedy, Jane  
Kenney, Robert W.  
Kerth, Leroy T.

Koellner, Werner O.  
Koop, Beverly C.  
Lee, Edward E.  
Lew, Brenda J.  
Loken, Stewart C.  
Long, Michael R.  
Lynch, Gerald R.  
Madaras, Ronald J.  
Marburg, Sandra L.  
Marquez, Susan A.  
Marx, Jay N.  
Mast, Terry S.  
Mesetz, Katherine  
Miller, Jeanne M.  
Mulera, Terrance A.  
Muller, Richard A.  
Nelson, Jerry E.  
Nuzum, Timothy E.  
Nygren, David R.  
Oddone, Piermaria J.  
Orlich, Barbara R.  
Palmerston, Evan H.  
Perez-Mendez, Victor  
Pripstein, Morris  
Prunty, Daurice D.  
Przybylski, Gerald T.  
Rittenberg, Alan  
Ronan, Michael T.  
Ross, Ronald R.

Sauerwein, Rainer R.  
Scales, Laura C.  
Schnurmacher, Gerald L.  
Shapiro, Gilbert  
Shaver, M. Robin  
Shigley, Douglas B.  
Siegrist, James L.  
Simpson, Kenneth H.  
Smith, Garth W.  
Smits, Robert G.  
Smoot, George F.  
Steiner, Herbert M.  
Stevenson, M. Lynn  
Strovink, Mark W.  
Tans, Peter P.  
Taylor, John D.  
Trilling, George H.  
Tripp, Robert D.  
Trippe, Thomas G.  
Van Slyke, Harold W.  
Vuletich, Tony  
Wang, Edward M.  
Waters, John N.  
Weber, P. Wes  
Weber, Thomas F.  
Wenzel, William A.  
Whipple, Edgar T.  
Wissmar, Joel C.  
Wohl, Charles G.  
Yamamoto, Hiroaki

## GRADUATE STUDENT RESEARCH ASSISTANTS

Aihara, Hiroaki  
Amidei, Dante E.  
Avery, Robert E.  
Baden, Andrew R.  
Balke, Brian K.E.  
Bertsche, Kirk J.  
Boyer, John H.  
Burns, Michael S.  
Butler, Frederick E.  
Clegg, Derek B.  
Cowan, Glen D.  
Derby, Kevin A.  
Dougherty, Brian L.  
Eastman, James J.

Edberg, Timothy K.  
Enomoto, Ryoji  
Friedman, Peter G.  
Fujiada, Ichiro  
Garnett, James D.  
Gary, John W.  
Gold, Michael  
Goulding, Laurence J.  
Harris, Robert  
Heiskanen, Kaarlo  
Hubbard, Bradley  
Hunt, Nathaniel G.  
Huth, John E.  
Itoh, Ryosuke

Jodidio, Alexander E.  
Juricic, Ivanna  
Krivicich, Joseph  
Lashof, Daniel A.  
Levin, Steven  
Mathis, Lisa G.  
Meyers, Peter D.  
Miki, Takeo  
Morel, James  
Moses, William W.  
Perlmutter, Saul  
Rouse, Forest R.  
Rowson, Peter C.

Schellman, Heidi M.  
Schmidke, William B.  
Schwartz, Gary M.  
Shapiro, Marjorie D.  
Sheldon, Paul D.  
Stoker, David P.  
Takahashi, Tadayuki  
Toge, Nobukazu  
Van Tyen, Raymond E.  
Welch, James J.  
Wolf, Zachary  
Wood, Darien  
Yamauchi, Masanori

# EXPERIMENTAL PHYSICS

## Research on $e^+e^-$ Annihilation

### PEP-4/9 TPC Collaboration

In November of 1984 the PEP-4/TPC Collaboration and the PEP-9/ $2\gamma$  collaboration merged into a single collaboration, with the goal of improving productivity and planning jointly for running after the High Luminosity PEP upgrade. The new collaboration has about 100 members from fourteen institutions, including about 30 graduate students (See Table I). The activities of the collaboration during 1984 have concentrated in three main areas:

- the analysis of the data collected during the 82/83 running cycle
- the commissioning of the upgraded TPC (superconducting magnet, improved field cages, rebuilt hexagonal calorimeter modules) by the fall 1984 in time for the 84/85 running cycle, and
- the planning for future operation with a factor of 5 increase in the PEP luminosity.

In the paragraphs below we discuss these activities in more detail.

#### I. Continuing Physics Analysis of the Data from the 82/83 Running Cycle

The analysis of the approximately  $80\text{pb}^{-1}$  of electron positron data at 29 GeV total energy collected during 82/83 running cycle continues. Twenty physics publications have been completed. We have given several talks at conferences on these results and on work in progress. Twelve Ph.D. theses have been completed.

It is not possible to give a comprehensive review of all the physics results and all the work in progress in this short report. Four topics have been selected which illustrate the progress being made. The first two based on electron-positron annihilation reactions are in the quark fragmentation area, and provide significant tests of current fragmentation models. The other two topics are from the study of  $\gamma\gamma$  collisions, processes in which the electron and positron scatter rather than annihilate and each produces a virtual photon. The first of the  $\gamma\gamma$  topics discussed involves the elucidation of the behavior of the photon structure function at low momentum transfer; the second is the study of the  $\gamma\gamma$  cross section with good energy resolution made possible by the detection of the final

state electron and positron in the NaI taggers (double-tag events).

The study of quark and gluon fragmentation into hadrons is important, both for its own sake, and to provide refinements in the Monte Carlo calculations essential to the interpretation of future high energy experiments. Electron-positron annihilation into quark, antiquark and gluon with subsequent fragmentation into three jets provides a particularly valuable vehicle for the detailed study of the fragmentation process.

There are currently three types of models used to describe fragmentation, (i) the Independent Fragmentation (IF), (ii) the Lund and (iii) the cluster models, with jet structures indicated in Figure 1.

MANPOWER TABLE FOR PEP-4/9

| Institution | Faculty and Permanent Staff Heads [1] | Postdoctoral Fellows Heads [2] | Graduate Students Heads [3] |
|-------------|---------------------------------------|--------------------------------|-----------------------------|
| LBL         | 20                                    | 4                              | 10                          |
| UCLA        | 3                                     | 2                              | 5                           |
| UCD         | 3                                     | 2                              | 2                           |
| UCR         | 4                                     | 2                              | 0                           |
| UCSD        | 3                                     | 1                              | 2                           |
| UCSB        | 2                                     | 2                              | 3                           |
| J. HOPKINS  | 3                                     | 1                              | 2                           |
| U. MASS     | 1                                     | 2                              | 0                           |
| NIKHEF      | 3                                     | 0                              | 3                           |
| U. TOKYO    | 1                                     | 1                              | 2                           |
| IIRPA       | 3                                     | 0                              | 0                           |
| AMES        | 1                                     | 0                              | 2                           |
| CMU         | 1                                     | 0                              | 0                           |
| NYU         | 1                                     | 0                              | 0                           |
| TOTALS      | 49                                    | 17                             | 31                          |

- [1] FTE's  $\approx 0.6$  HEADS
- [2] FTE's  $\approx 0.85$  HEADS
- [3] FTE's  $\approx 0.95$  HEADS

#### A. Tests of Models of Parton Fragmentation from Study of 3-Jet Events

In IF models, each parton fragments into a jet independently. Thus in three-jet events the regions between the jets are populated by the same mechanism, namely, the finite transverse momentum distribution relative to the jet axis (Figure 1a).

In the LUND model 3-jet events are represented by a string that stretches from the quark to the gluon

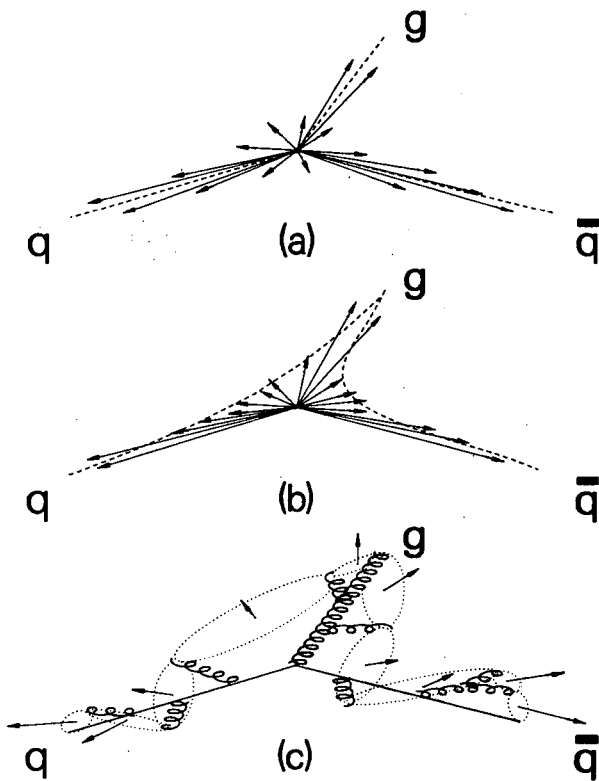

XBL 8410-4273

Fig. 1. The 3-jet event structure for the (a) Independent Fragmentation (IF), (b) LUND String Fragmentation (SF), and (c) Webber Cluster Fragmentation (CF) models. The arrows in (a) and (b) indicate the momentum space distribution of particles. The dashed lines in (a) represent the parton directions and in (b) the strings; (c) shows the quark-gluon cascade (solid and curly lines) and the clusters (dotted ellipses).

and then to the anti-quark (Figure 1b). The two string segments fragment in their respective rest frames. Hadrons thus receive a Lorentz boost as observed in the overall center of mass system. As a result the distribution of hadrons in the regions between the jets is altered: the region  $qg$  and the region  $\bar{q}g$  are favored by the boost, while the region  $q\bar{q}$  is comparatively depleted.

In the Webber cluster model the initial partons initiate a quark-gluon cascade described by leading-log QCD. Soft gluon interference is included leading to angle ordering in the cascade: successive parton emission angles are smaller than the preceding ones. Since the angle between the  $q$  and  $\bar{q}$  is usually large, this ordering causes the formation of clusters to preferentially populate the  $\bar{q}g$  and  $qg$  regions rather than

the  $q\bar{q}$  region. The decay of the moving clusters then produces a "boost signal" similar to that of the LUND model. Not all cluster models predict the same behavior. For instance, the Gottschalk model which does not have angle ordering in the quark-gluon cascades does not predict the depopulation of the  $q\bar{q}$  region relative to the  $qg$  and  $\bar{q}g$  regions.

Approximately 10% of the 2900 events used in the TPC analysis are classified as three jet events with fairly standard jet finding algorithms. The jets are labeled 1, 2, and 3 such that jet 1 is opposite the smallest angle between jets, and jet 3 is opposite the largest angle. The angle  $\phi$  is defined in the event plane and proceeds from jet 1 ( $\phi = 0^\circ$ ) to jet 2 ( $\phi \approx 155^\circ$ ) to jet 3 ( $\phi \approx 230^\circ$ ) and back to jet 1 ( $\phi = 360^\circ$ ).

Figure 2 shows the normalized particle density  $(1/N)dN/d\phi$  along with the predictions of the three models described above (IF, LUND and Webber's) for all charged particles and photons (2a), for particles with large momentum out of the event plane (2b) and for heavy particles (2c). The highest particle density occurs in the jet 1 peak and the lowest in the jet 1-2 valley. The LUND model provides a reasonable description of the data over the entire  $\phi$  range. The IF model provides nearly as good a description, except in the jet 1-2 valley where it predicts a density 30% higher than the data. As expected from the nature of the Lorentz boost, the effects are accentuated for particles with large transverse mass  $m = \sqrt{m^2 + p^2}$ . Thus the discrepancy with the IF model increases to a factor of 2 for either particles with large momentum relative to the event plane or for particles with large mass. The discrepancy is fundamental and cannot be "patched-up" in the present variants of the IF model: the IF model cannot be tuned to fit the 1-2 valley and provide reasonable fits of global event distributions. For the Webber model the predictions are too large for all regions between jets, but this result is sensitive to model parameters which have not been tuned for this particular analysis.

A quantitative summary can be made by studying the "normalized particle populations"  $N_{ij}$ . For each particle between jets  $i$  and  $j$  the angle between the jet  $i$  and the particle is divided by the angle between jets  $i$  and  $j$ .  $N_{ij}$  is the number of particles between .3 and .7 in this normalized angular region (the most sensitive to boost effects). The comparison of the jet 1-2 region and the jet 1-3 region is made by the ratio  $N_{31}/N_{12}$ . This ratio is insensitive to the variants of the IF model, to tuning of the Webber model and to detector acceptance. For IF models we expect  $N_{31}/N_{12} \approx 1$  independent of particle mass or



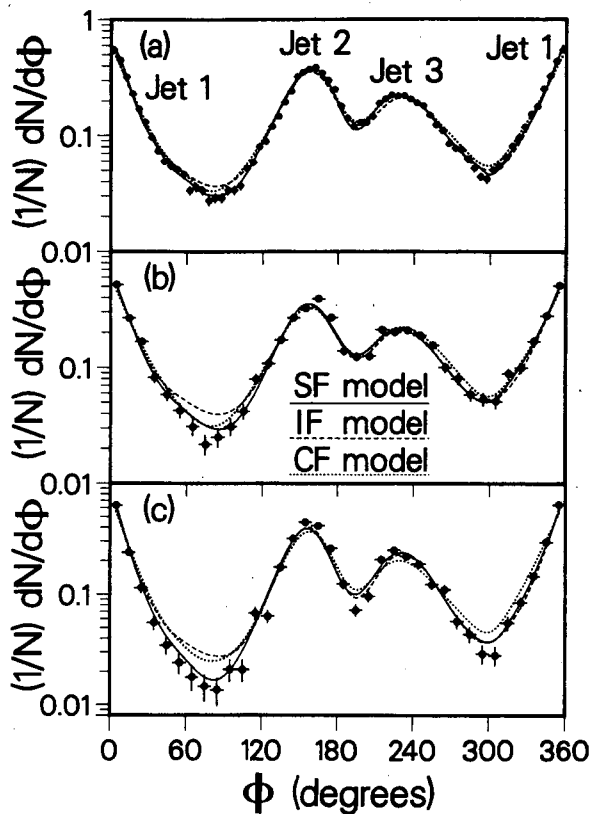

XBL 8410-4274

Fig. 2. Particle density  $(1/N)dN/d\phi$  in 3-jet events for (a) all charged particles and photons, (b) those charged particles and photons satisfying  $0.3 < p_{out} < 0.5$  GeV, where  $p_{out}$  is the momentum out of the event plane, and (c) a heavy particle sample of charged and neutral K's, p's and  $\Lambda$ 's. Also shown are the predictions of the Independent Fragmentation (IF), LUND String Fragmentation (SF), and Webber Cluster Fragmentation (CF) models. The data are from the TPC.

transverse momentum out of the plane, while for boosted hadron sources in the LUND and Webber models we expect the ratio to be greater than 1 and to increase with mass and momentum out of the plane.

The ratio  $N_{31}/N_{12}$  is shown in Figure 3. The data show that the ratio increases with mass and with momentum out of the plane. The LUND and the Webber model give a good description of the behavior of this ratio, while the IF model does not fit the data.

### B. Baryon-Baryon Correlations

QCD cluster models evolve the parton showers to the point where low mass color singlet clusters are

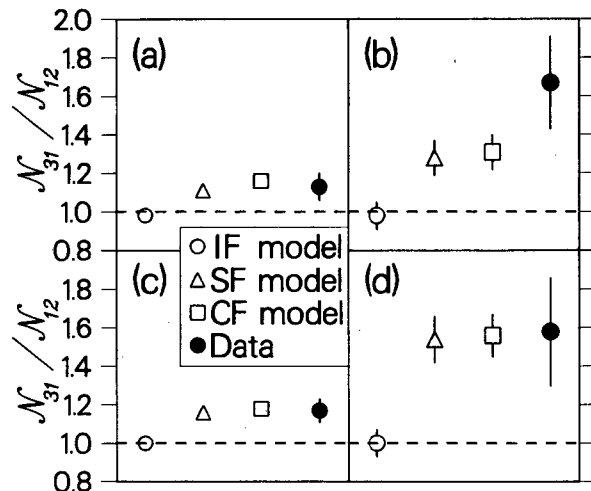

XBL 8410-4275

Fig. 3. The ratio  $N_{31}/N_{12}$  of the populations between jets, for the data and the models: (a) shows the ratio for pions with  $p_{out} < 0.2$  GeV, and (b) shows the ratio for pions in the range  $0.3 < p_{out} < 0.5$  GeV, (c) shows the ratio for all pions, and (d) for the heavy particle sample. The data are from the TPC.

formed (Figure 4a). Some of these clusters are heavy enough to decay into baryons. A typical cluster model, such as Webber's, decays these clusters isotropically. Such a mechanism would imply that the produced baryon does not "remember" the sphericity axis of the event. As a consequence, the distribution of events as a function of  $\theta^*$ , the angle between the baryon and the sphericity axis, should be flat.

In contradistinction to cluster models, string models such as LUND's produce baryons via a diquark mechanism: fundamental diquarks with binding energies large compared to the momentum transfers involved in the process are created. Once produced through diquark-antidiquark creation, a diquark combines with an ordinary quark to form a baryon (Figure 4b). In these models, the diquark ( $qq$ ) and the anti-diquark ( $\bar{q}\bar{q}$ ) are pulled apart by the tension of the color string. Therefore the baryon-antibaryon momentum difference has a tendency to align with the jet axis, and the distribution of  $\cos\theta^*$  will peak near  $\cos\theta^* \simeq 1$ .

The  $\cos\theta^*$  distribution for the produced baryons is shown in Figure 5a for the Webber cluster model and for the LUND model. These distributions, modified by the detector acceptance, are shown in Figure 5b, together with the data of the TPC on proton-antiproton pairs in the momentum range 0.5 to 1.5

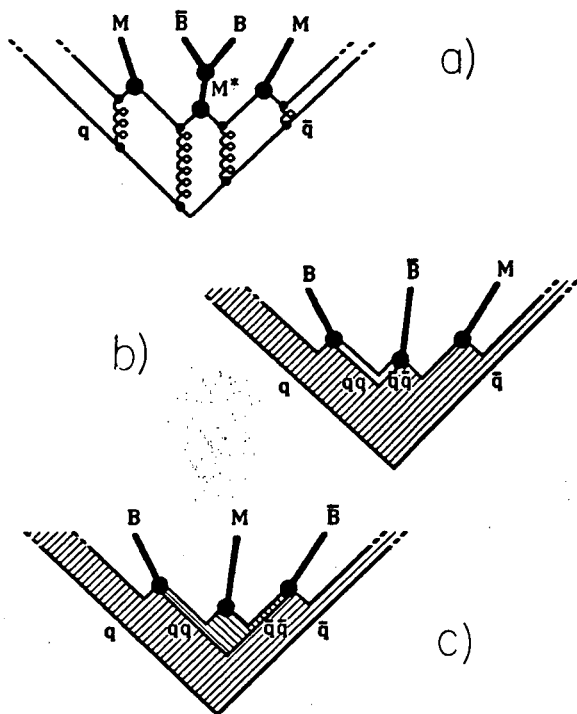

XBL 8512-4910

Fig. 4. Schematic representation of baryon production mechanisms in (a) QCD cluster models, (b) string model with stable diquarks, and (c) string models with diquarks, which are allowed to break up.

GeV/c. The data exclude the Webber model with isotropic cluster decay at the 98% C.L.

### C. Behavior of the Photon Structure Function at Low $Q^2$

The study of the photon structure function  $F_2^\gamma$  has generated considerable interest because it has the promise of testing QCD and of providing the best measurement of the scale parameter  $\Lambda$ . As it is true of QCD calculations about the real world, some pieces are calculable in QCD and others are not. The latter need to be gotten from experiment. The photon structure function can be separated into two pieces: one point-like piece which is calculable in QCD and a piece which presumably can be modeled by the Vector Dominance Model (VDM) and measured.

We have measured the VDM contribution where it is expected to be dominant, namely at low  $Q^2$ . This measurement is shown in Figure 6 for the PEP-4/9 data; it is the only one available in this low  $Q^2$  range. The program is now to look at the final state in this

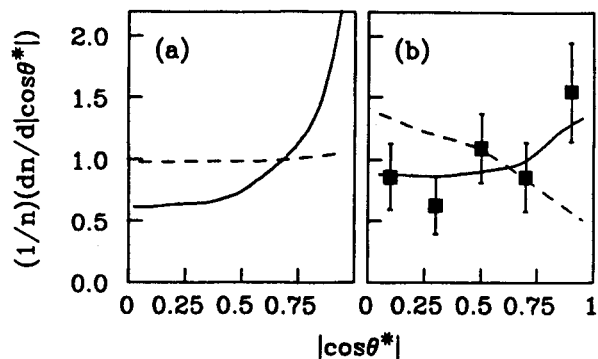

XBL 8512-4911

Fig. 5. Distribution of proton-antiproton pairs in the angle  $\theta^*$  between the proton direction and the sphericity axis, measured in the  $p\bar{p}$  rest frame, after subtraction of the corresponding distribution for like-sign baryon combinations. (a) Predictions of the LUND diquark model with stable diquarks (solid lines) and of the Webber cluster model (dashed lines). Allowing diquarks to break up will slightly increase the distribution for the LUND model at  $\cos\theta \approx 1$ . (b) Experimental distribution of  $p\bar{p}$  pairs where the  $p$  and  $\bar{p}$  momenta are in the 0.5 - 1.5 GeV/c range. Solid and dashed lines: model predictions [as in (a)].

low  $Q^2$  range and to try to determine the point-like contribution by studying the jet structure of the final state. Once determined, this contribution could be subtracted and the remaining part would be the best determination of the VDM level.

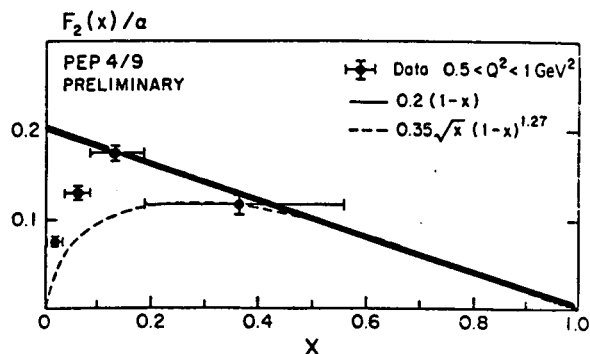

XBL 8512-4912

Fig. 6. Comparison of the photon structure function at the lowest available  $Q^2$  with two different fits to the pion structure function.

#### D. Missing Mass Scan in $\gamma\gamma$

A unique capability of the PEP-4/9 apparatus is the ability to measure the scattered electron and positron in the NaI shower counters. The energy determination in these counters is typically 1% at 14.5 GeV. One can use the precision of these counters to measure the mass of  $X$  in the reaction  $\gamma\gamma \rightarrow X$  by detecting the scattered electrons in the process  $e^+ + e^- \rightarrow e^+ + e^- + X$ . Using this technique we have made the most reliable measurement of the  $\gamma\gamma$  total hadronic cross section. Figure 7a shows the spectrum of observed missing mass for events which contain a hadronic track in the TPC (to insure we are not measuring a purely electromagnetic process). Obviously additional selections can be required to search

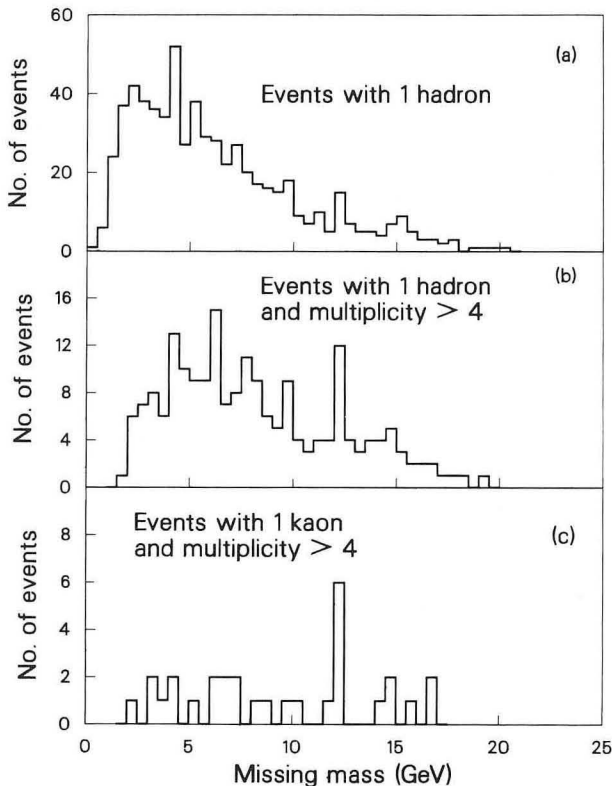

XCG 861-7053

Fig. 7. (a) The missing mass spectrum calculated from the electron and positron in double tag events. To avoid purely electromagnetic processes, one hadron track is required in the TPC. (b) Same events with the added requirements that the charge multiplicity be greater than 4. (c) Similar to (b) but with two additional requirements: more than four tracks in the TPC and at least one track identified as a K.

for potentially new objects. Figure 7b shows the same events with the added requirements that the charge multiplicity be greater than 4, and Figure 7c further requires a  $K^\pm$ . Clearly in Figure 7c the statistical level is extremely poor, but there is an interesting suggestion of a narrow peak. This is an area where PEP can make a unique contribution with a much higher level of integrated luminosity.

#### II. Performance of the Detector in the 84/85 Running Cycle

The upgraded TPC was installed in the summer and fall of 1984 in time for the 84/85 running cycle. Figure 8 shows the installation crew working on the wiring of the TPC.

The detector has operated extremely well during this cycle. It took approximately one month, the month of November, to study and adjust triggers for the new configuration. After that period, the detector has been collecting data continuously. Approximately  $5\text{pb}^{-1}$  of data were collected during the three weeks of running in December, a period in which the LINAC was seriously impacted by SLC-related testing. A late and rocky start of the LINAC and PEP ruined February as a data collecting month. Since then, by April 8th, we had collected  $20\text{pb}^{-1}$ ; optimistically we expect to collect another  $30\text{pb}^{-1}$  by the end of May. Thus the total for the year will be at most  $55\text{pb}^{-1}$ .

The TPC proper has operated very well. The new thin inner insulator has been trouble free, the gated grid has operated even better than expected, and the electrostatic distortions are largely gone. Figure 9



CBB 840-8714

Fig. 8. The installation crew working on the wiring of the TPC.

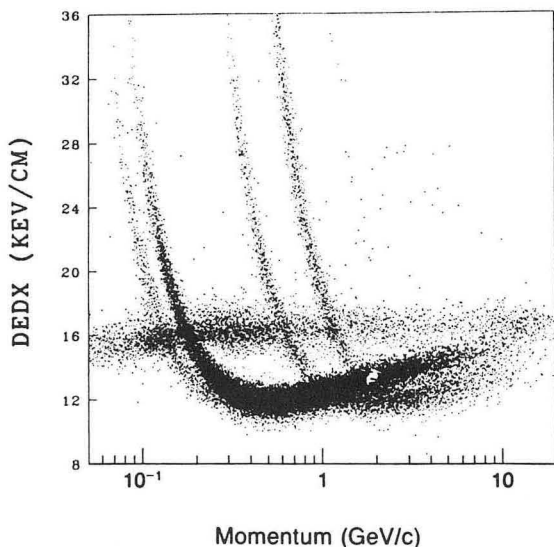

XBL 861-92

Fig. 9. The  $dE/dx$  vs.  $p$  scatter plot for the data collected in spring 1985.

shows the new  $dE/dx$  vs.  $p$  curves. The improved momentum resolution dramatically sharpens the particle bands in the horizontal direction. For instance, the low momentum muon band is now distinct, whereas in the “old” data this band could not be seen. These  $dE/dx$  curves did not require any corrections for the gated grid operation since the baseline is restored before we start to collect data. The net spatial loss introduced by the delay due to the gated grid operation has been 8cm. The only problem encountered was with the inner 80 wires of one sector. Starting with an especially bad running period, with many beam splashes, the inner 80 wires of this sector could not be brought up to normal operating voltage. After some experimentation we have found a fairly stable operating point for these wires, 200v below their normal operating point. While this is a nuisance for the data analysis, we expect to have no losses due to this problem: the tracking is efficient and we will be able to measure  $dE/dx$  fairly well even though the wire gain is lower. The outer 110 wires in that sector continue to operate at the nominal voltage.

The momentum resolution is improved by a factor of about 3 at low momentum, where errors are dominated by multiple scattering, and about 5 at the highest momenta. Mass resolutions have correspondingly improved. In some instances, especially at low momenta, they have become limited by the measurement of angles, where scattering from the material in front of the TPC still plays the dominant role. Many

resonances which were not directly observable in the previous running at the field of 4Kg, have become detectable. This is especially true for charm mesons which are fast. For some particles, like  $\Lambda$ 's, the improvement leads to much better signal to noise, or correspondingly, a greater acceptance for a fixed signal to noise. Some of these points are illustrated in the following figures.

Figure 10a shows the mass spectrum for  $K\pi$  combinations with combined momentum greater than 5GeV. A  $D^0$  signal is clearly visible with good signal to noise. Figure 10b shows the  $D^0$  signal in the  $K\pi\pi\pi$  channel, albeit with a poorer signal to noise ratio due to the increased combinatorics. These two signals were not observable in the prior data sample. Figure 10c shows a very pure  $D^{*\pm}$  signal. Figure 10d shows  $KK\pi$  combinations with a strong indication of an F signal. This signal was not present in the old data prior to association with  $\gamma$ 's from the  $F^*$ .

Figure 11 shows a comparison of the new and old data samples for  $\Lambda$ 's, for two momentum ranges: 1–2 GeV and 5–10 GeV. The improvement is dramatic, especially in the higher momentum data. Figure 12 illustrates how these gains in resolution can translate in gains in efficiency for a given signal to noise ratio. In the case of  $\Lambda$ 's a factor of about 2.5 in acceptance can be achieved. This is especially important for correlation studies where such a gain translates to a gain greater than a factor of 6 for  $\Lambda\Lambda$  pairs.

In all the results described above, no distortion corrections have been made. We expect a small improvement after making corrections for the small remaining distortions.

The other systems in the facility are operating well. The Hexagonal Calorimeter is operating with its six modules and has reached a performance with the new gas comparable, although slightly inferior, to the performance achieved with Ethyl Bromide.

Our data analysis system is now able to keep up with a rate of  $1\text{pb}^{-1}$  of data per day. We typically have data summary tapes for annihilation events (really an updated data summary disk) from one to a few days after the data are collected.

### III. Upgrades and Physics for the Present and Future Runs

In the next four years PEP will contribute significantly in the following areas:

a) The TPC at PEP will make the definitive studies on quark and gluon fragmentation and hadron confinement in the PEP energy regime. Beyond the

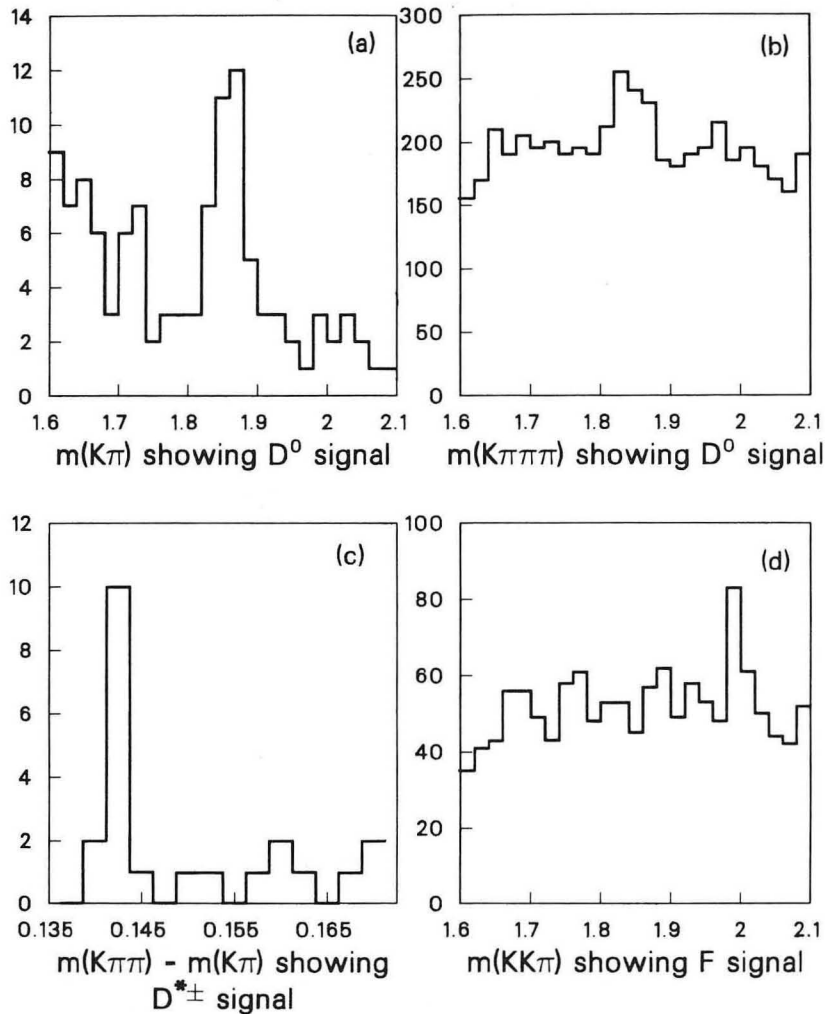

XCG 861-7052

Fig. 10. D's and F's in the new data sample.

PEP energy range, there will be competitive studies of fragmentation only when the SLD detector at the SLC, and the DELPHI and ALEPH detectors at LEP start operating. It is only then that the required particle identification will be available for these detailed studies. Even then, it will be necessary to have the PEP data to help understand the more complex parton configuration at higher energies.

b) The TPC at PEP will make the definitive studies of two photon physics. The subject is more easily studied at PEP rather than at lower energy machines like CESR or higher energy machines like the SLC and LEP. The particle identification of the TPC is again unmatched in this area for another half decade.

c) The TPC will be competitive with the SLC in B physics studies during the early years of the SLC, when the machine will suffer from low luminosity

and have the MKII as the initial detector. In particular, the advantage that SLC has in tagging  $B\bar{B}$  events (smaller beam-pipe, reduced multiple scattering) can be overcome by the ability to identify decay particles like D's and F's in the final state (which the TPC at PEP does better than the MKII at SLC).

d) Measurements of interesting parameters such as the electroweak asymmetries of tagged jets, the decay branching fractions of  $\tau$  leptons, and searches for new particles.

The only needed detector upgrade to fully carry out the above program is the addition of a high spatial resolution vertex detector. This detector would be placed between 5cm and 15cm from the beam collision point. A possible candidate for the TPC vertex detector is the Radial Drift Chamber described elsewhere in this report.

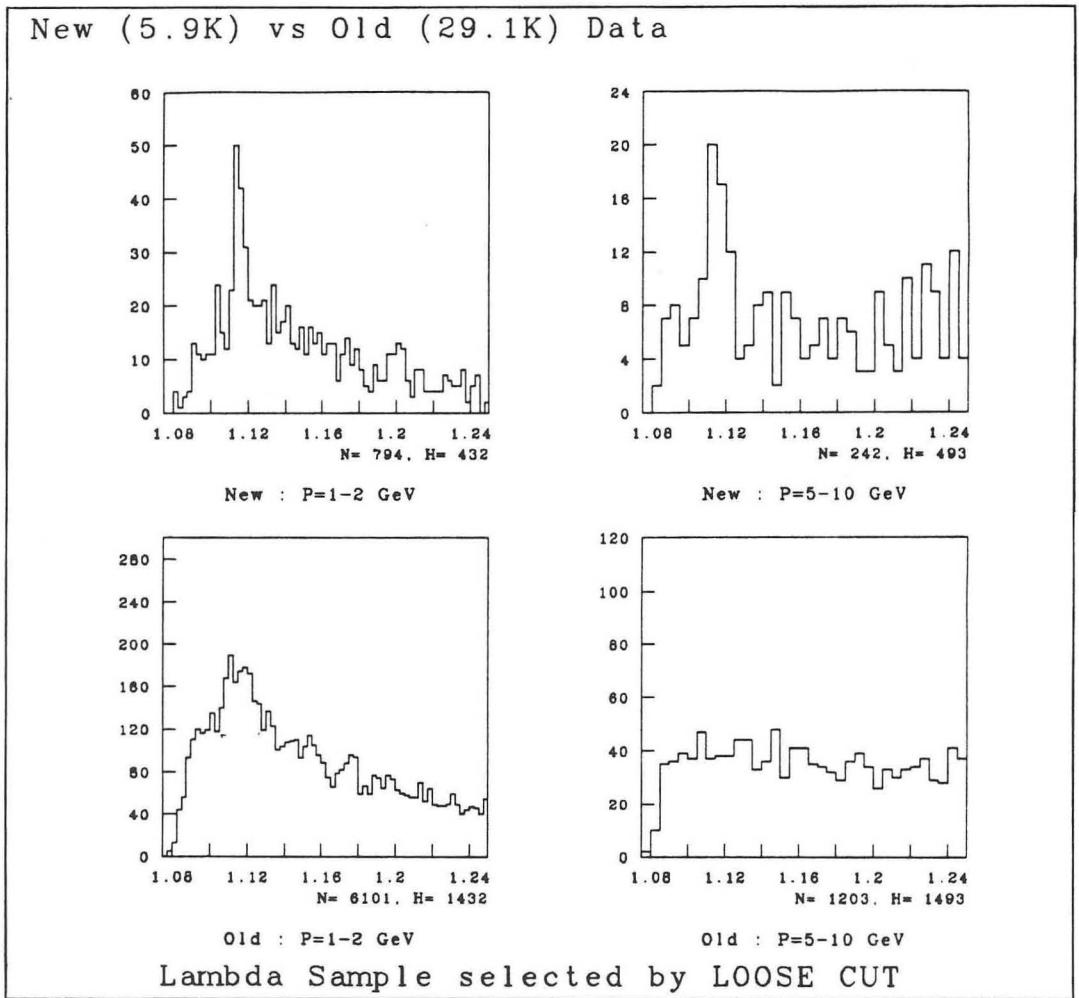

XBL 8512-4913

Fig. 11. The  $\Lambda$ 's in the new data sample (upper two plots) compared to the  $\Lambda$ 's in the old data sample (lower two plots).

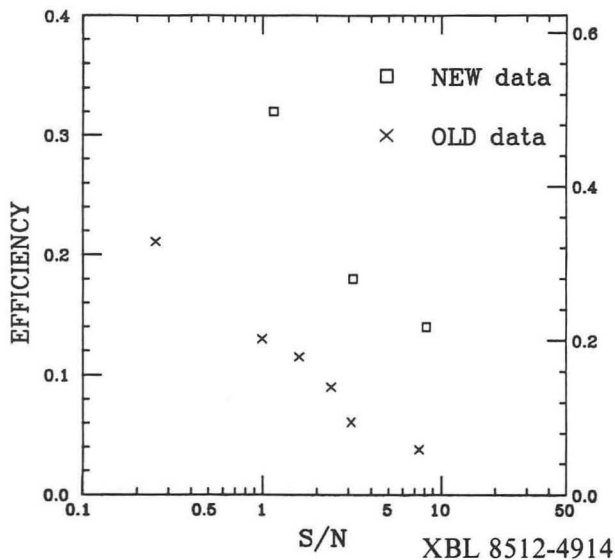

There are other possible upgrades for the TPC, but these will wait until some further motivation is derived from the high luminosity running.

Fig. 12. Efficiency vs. signal-to-noise ratio for  $\Lambda$ 's in the old and new data samples.



## Research Staff

M. Alston-Garnjost, R. Avery, A. Barbaro-Galtieri, A.V. Barnes, A. Bross, O. Chamberlain, A.R. Clark, O.I. Dahl, C. Day, K.A. Derby, P.H. Eberhard, T. Edberg, B. Gabioud, J.W. Gary, W. Hofmann, H. Huth, S. Kaye, R.W. Kenney, L.T. Kerth, R. Kofler, S.C. Loken, G.R. Lynch, R.J. Madaras, J.N. Marx, W. Moses, P. Nemethy, D.R. Nygren, P.J. Oddone, M. Pripstein, P. Robrish, M.T. Ronan, R.R. Ross, F.R. Rouse, R. Sauerwein, M.D. Shapiro, M.L. Stevenson, R. Van Tyen, E. Wang, Z. Wolf.

## Publications

Search for Charge  $4/3e$  Particles in  $e^+e^-$  Annihilations, H. Aihara, M. Alston-Garnjost, D.H. Badtke, J.A. Bakken, A. Barbaro-Galtieri, A.V. Barnes, B.A. Barnett, B.J. Blumenfeld, A. Bross, C.D. Buchanan, W.C. Carithers, O. Chamberlain, C.-Q. Chen, J. Chiba, C.-Y. Chien, A.R. Clark, O.I. Dahl, C.T. Day, P. Delpierre, K.A. Derby, P.H. Eberhard, D.L. Fancher, H. Fujii, T. Fujii, B. Gabioud, J.W. Gary, W. Gorn, W.-X. Gu, N.J. Hadley, J.M. Hauptman, H.J. Hilke, W. Hofmann, J.E. Huth, J. Hylen, H. Iwasaki, T. Kamae, R.W. Kenney, L.T. Kerth, R.I. Koda, R.R. Kofler, K.K. Kwong, J.G. Layter, C.S. Lindsey, G. London, S.C. Loken, X.-Q. Lu, G.R. Lynch, L. Madansky, R.J. Madaras, R. Majka, J. Mallet, P.S. Martin, K. Maruyama, J.N. Marx, J.A.J. Matthews, S.O. Melnikoff, W. Moses, P. Nemethy, D.R. Nygren, P.J. Oddone, D. Park, A. Pevsner, M. Pripstein, P.R. Robrish, M.T. Ronan, R.R. Ross, F.R. Rouse, R.R. Sauerwein, G. Shapiro, M.D. Shapiro, B.C. Shen, W.E. Slater, M.L. Stevenson, D.H. Stork, H.K. Ticho, N. Toge, M. Urban, R.F. vanDaalen Wetters, G.J. VanDalen, R. van Tyen, H. Videau, M.R. Wayne, W.A. Wenzel, M.Yamauchi, M.E. Zeller, and W.-M. Zhang, *Phys. Rev. Letters* 52, 168 (16 January 1984).

Charged Hadron Production in  $e^+e^-$  Annihilation at 29 GeV, H. Aihara, M. Alston-Garnjost, D.H. Badtke, J.A. Bakken, A. Barbaro-Galtieri, A.V. Barnes, B.A. Barnett, B.J. Blumenfeld, A.D. Bross, C.D. Buchanan, O. Chamberlain, C. Chen, J. Chiba, C.-Y. Chien, A.R. Clark, O.I. Dahl, C.T. Day, P. Delpierre, K.A. Derby, P.H. Eberhard, D.L. Fancher, H. Fujii, T. Fujii, B. Gabioud, J.W. Gary, W. Gorn, W. Gu, N.J. Hadley, J.M. Hauptman, H.J. Hilke, W. Hofmann, J.E. Huth, J. Hylen, H. Iwasaki, T. Kamae, R.W. Kenney, L.T. Kerth, R.I. Koda, R.R. Kofler, K.K. Kwong, J.G. Layter, C.S. Lindsey, S.C. Loken, G.W. London, X.-Q. Lu, G.R. Lynch, L. Madansky, R.J. Madaras, R. Majka, J. Mallet, P.S. Martin, K. Maruyama, J.N. Marx, J.A. Matthews, S.O. Melnikoff, W. Moses, P. Nemethy, D.R. Nygren, P.J. Oddone, D.A. Park, A. Pevsner, M. Pripstein, P.R. Robrish, M.T. Ronan, R.R. Ross, F.R. Rouse, R.R. Sauerwein, G. Shapiro, M.D. Shapiro, B.C. Shen, W.E. Slater, M.L. Stevenson, D.H. Stork, H.K. Ticho, N. Toge, M. Urban, R.F. van Daalen Wetters, G.J. Van Dalen, R. van Tyen, H. Videau, M.R. Wayne, W.A. Wenzel, H.A. Yamamoto, M. Yamauchi, M.E. Zeller, and W.-M. Zhang, *Phys. Rev. Letters* 52, 577 (20 February 1984).

Prompt Electron Production in  $e^+e^-$  Annihilations at 29 GeV, H. Aihara, M. Alston-Garnjost, D.H. Badtke, J.A. Bakken, A. Barbaro-Galtieri, A.V. Barnes, B.A. Barnett, B. Blumenfeld, A. Bross, C.D. Buchanan, O. Chamberlain, J. Chiba, C.-Y. Chien, A.R. Clark, A. Cordier, O.I. Dahl, C.T. Day, K.A. Derby, P.H. Eberhard, D.L. Fancher, H. Fujii, T. Fujii, B. Gabioud, J.W. Gary, W. Gorn, N.J. Hadley, J.M. Hauptman, H. Hilke, W. Hofmann, J.E. Huth, J. Hylen, H. Iwasaki, T. Kamae, R.W. Kenney, L.T. Kerth, R. Koda, R.R. Kofler, K.K. Kwong, J.G. Layter, C.S. Lindsey, S.C. Loken, X.-Q. Lu, G.R. Lynch, L. Madansky, R.J. Madaras, R. Majka, P.S. Martin, K. Maruyama, J.N. Marx, J.A.J. Matthews, S.O. Melnikoff, W. Moses, P. Nemethy, D.R. Nygren, P.J. Oddone, D. Park, A. Pevsner, M. Pripstein, P.R. Robrish, M.T. Ronan, R.R. Ross, F.R. Rouse, R.R. Sauerwein, G. Shapiro, M.D. Shapiro, B.C. Shen, W.E. Slater, M.L. Stevenson, D.H. Stork, H.K. Ticho, N. Toge, G.J. Van Dalen, R. van Tyen, H. Videau, M. Wayne, W.A. Wenzel, R.F. vanDaalen Wetters, H. Yamamoto, M. Yamauchi, M.E. Zeller, and W.-M. Zhang, *LBL-17545*, March 1984, submitted to *Z. Physik* C.

Search for  $Q = (2/3)e$  and  $Q = (1/3)e$  Particles Produced in  $e^+e^-$  Annihilations, H. Aihara, M. Alston-Garnjost, D.H. Badtke, J.A. Bakken, A. Barbaro-Galtieri, A.V. Barnes, B.A. Barnett, B.J. Blumenfeld, A.D. Bross, C.D. Buchanan, O. Chamberlain, J. Chiba, C.-Y. Chien, A.R. Clark, A. Cordier, O.I. Dahl, C.T. Day, K.A. Derby, P.H. Eberhard, D.L. Fancher, H. Fujii, T. Fujii, B. Gabioud, W.J. Gary, W. Gorn, N.J. Hadley, J.M. Hauptman, H. Hilke, W. Hofmann, J.E. Huth, J. Hylen, H. Iwasaki, T. Kamae, R.W. Kenney, L.T. Kerth, R. Koda, R.R. Kofler, K.K. Kwong, J.G. Layter, C.S. Lindsey, S.C. Loken, X.-Q. Lu, G.R. Lynch, L. Madansky, R.J. Madaras, R. Majka, P.W. Martin, K. Maruyama, J.N. Marx, J.A.J. Matthews, S.O. Melnikoff, W. Moses, P. Nemethy, D.R. Nygren, P.J. Oddone, D. Park, A. Pevsner, M. Pripstein, P.R. Robrish, M.T. Ronan, R.R. Ross, F.R. Rouse, R.R. Sauerwein, G. Shapiro, M.D. Shapiro, B.C. Shen, W.E. Slater, M.L. Stevenson, D.H. Stork, H.K. Ticho, N. Toge, G.J. Van Dalen, R. van Tyen, H. Videau, M. Wayne, W.A. Wenzel, R.F. vanDaalen Wetters, H. Yamamoto, M. Yamauchi, M.E. Zeller, and W.-M. Zhang, *Phys. Rev. Letters* 52, 2332 (25 June 1984).

Phi Meson Production in  $e^+e^-$  Annihilations at 29 GeV, H. Aihara, M. Alston-Garnjost, D.H. Badtke, J.A. Bakken, A. Barbaro-Galtieri, B.A. Barnett, A.V. Barnes, B.J. Blumenfeld, A.D. Bross, C.D. Buchanan, O. Chamberlain, J. Chiba, C.-Y. Chien, A.R. Clark, A. Cordier, O.I. Dahl, C.T. Day, K.A. Derby, P.H. Eberhard, D.L. Fancher, H. Fujii, T. Fujii, B. Gabioud, J.W. Gary, W. Gorn, N.J. Hadley, J.M. Hauptman, H.J. Hilke, W. Hofmann, J.E. Huth, J. Hylen, H. Iwasaki, T. Kamae, R.W. Kenney, L.T. Kerth, R. Koda, R.R. Kofler, K.K. Kwong, J.G. Layter, C.S. Lindsey, S.C. Loken, X.-Q. Lu, G.R. Lynch, L. Madansky, R.J. Madaras, R. Majka, P.S. Martin, K. Maruyama, J.N. Marx, J.A. Matthews, S.O. Melnikoff, W. Moses, P. Nemethy, D.R. Nygren, P.J. Oddone, D. Park, A. Pevsner, M. Pripstein, P.R. Robrish, M.T. Ronan, R.R. Ross, F.R. Rouse, R.R. Sauerwein, G. Shapiro, M.D. Shapiro, B.C. Shen, W.E. Slater, M.L. Stevenson, D.H. Stork, H.K. Ticho, N. Toge, G.J. Van Dalen, R. van Tyen, H. Videau, M. Wayne, W.A. Wenzel, R.F. vanDaalen Wetters, H. Yamamoto, M. Yamauchi, M.E. Zeller, and W.-M. Zhang, *Phys. Rev. Letters* 52, 2201 (18 June 1984).

Characteristics of Proton Production in Jets From  $e^+e^-$  Annihilation at 29 GeV, H. Aihara, M. Alston-Garnjost, D.H. Badtke, J.A. Bakken, A. Barbaro-Galtieri, A.V. Barnes, B.A. Barnett, B.J. Blumenfeld, A.D. Bross, C.D. Buchanan, O. Chamberlain, J. Chiba, C.-Y. Chien, A.R. Clark, A. Cordier, O.I. Dahl, C.T. Day, K.A. Derby, P.H. Eberhard, D.L. Fancher, H. Fujii, B. Gabioud, J.W. Gary, W. Gorn, N.J. Hadley, J.M. Hauptman, H.J. Hilke, W. Hofmann, J.E. Huth, J. Hylen, H. Iwasaki, T. Kamae, R.W. Kenney, L.T. Kerth, R.I. Koda, R.R. Kofler, K.K. Kwong, J.G. Layter, C.S. Lindsey, S.C. Loken, X.-Q. Lu, G.R. Lynch, L. Madansky, R.J. Madaras, R.M. Majka, P.S. Martin, K. Maruyama, J.N. Marx, J.A.J. Matthews, S.O. Melnikoff, W. Moses, P. Nemethy, D.R. Nygren, P.J. Oddone, D.A. Park, A. Pevsner, M. Pripstein, P.R. Robrish, M.T. Ronan, R.R. Ross, F.R. Rouse, R.R. Sauerwein, G. Shapiro, M.D. Shapiro, B.C. Shen, W.E. Slater, M.L. Stevenson, D.H. Stork, H.K. Ticho, N. Toge, G.J. Van Dalen, R. van Tyen, H. Videau, M.R. Wayne, W.A. Wenzel, R.F. van Daalen Wetters, H. Yamamoto, M. Yamauchi, W.-M. Zhang, Phys. Rev. Letters 53, 130 (9 July 1984).

Tau Lepton Branching Fractions, H. Aihara, M. Alston-Garnjost, D.H. Badtke, J.A. Bakken, A. Barbaro-Galtieri, A.V. Barnes, B.A. Barnett, B. Blumenfeld, A. Bross, C.D. Buchanan, O. Chamberlain, J. Chiba, C.-Y. Chien, A.R. Clark, A. Cordier, O.I. Dahl, C.T. Day, K.A. Derby, P.H. Eberhard, D.L. Fancher, H. Fujii, T. Fujii, B. Gabioud, J.W. Gary, W. Gorn, N.J. Hadley, J.M. Hauptman, W. Hofmann, J.E. Huth, J. Hylen, H. Iwasaki, T. Kamae, R.W. Kenney, L.T. Kerth, R. Koda, R.R. Kofler, K.K. Kwong, J.G. Layter, C.S. Lindsey, S.C. Loken, X.-Q. Lu, G.R. Lynch, L. Madansky, R.J. Madaras, R. Majka, P.S. Martin, K. Maruyama, J.N. Marx, J.A.J. Matthews, S.O. Melnikoff, W. Moses, P. Nemethy, D.R. Nygren, P.J. Oddone, D. Park, A. Pevsner, M. Pripstein, P.R. Robrish, M.T. Ronan, R.R. Ross, F.R. Rouse, R.R. Sauerwein, G. Shapiro, M.D. Shapiro, B.C. Shen, W.E. Slater, M.L. Stevenson, D.H. Stork, H.K. Ticho, N. Toge, G.J. Van Dalen, R. van Tyen, M. Wayne, W.A. Wenzel, R.F. vanDaalen Wetters, H. Yamamoto, M. Yamauchi, W.-M. Zhang, Phys. Rev. D30, 2436 (December 1984).

Observation of Strangeness Correlations in  $e^+e^-$  Annihilation at  $\sqrt{s} = 29$  GeV, H. Aihara, M. Alston-Garnjost, D.H. Badtke, J.A. Bakken, A. Barbaro-Galtieri, A.V. Barnes, B.A. Barnett, B. Blumenfeld, A. Bross, C.D. Buchanan, O. Chamberlain, J. Chiba, C.-Y. Chien, A.R. Clark, A. Cordier, O.I. Dahl, C.T. Day, K.A. Derby, P.H. Eberhard, D.L. Fancher, H. Fujii, T. Fujii, B. Gabioud, J.W. Gary, W. Gorn, N.J. Hadley, J.M. Hauptman, H. Hilke, W. Hofmann, J.E. Huth, J. Hylen, H. Iwasaki, T. Kamae, H.S. Kaye, R.W. Kenney, L.T. Kerth, R. Koda, R.R. Kofler, K.K. Kwong, J.G. Layter, C.S. Lindsey, S.C. Loken, X.-Q. Lu, G.R. Lynch, L. Madansky, R.J. Madaras, R. Majka, P.S. Martin, K. Maruyama, J.N. Marx, J.A.J. Matthews, S.O. Melnikoff, W. Moses, P. Nemethy, D.R. Nygren, P.J. Oddone, D. Park, A. Pevsner, M. Pripstein, P.R. Robrish, M.T. Ronan, R.R. Ross, F.R. Rouse, R.R. Sauerwein, G. Shapiro, M.D. Shapiro, B.C. Shen, W.E. Slater, M.L. Stevenson, D.H. Stork, H.K. Ticho, N. Toge, G.J. Van Dalen, R. van Tyen, H. Videau, M. Wayne, W.A. Wenzel, R.F. vanDaalen Wetters, H. Yamamoto, M. Yamauchi, E. Wang, and W.-M. Zhang, Phys. Rev. Letters 53, 2199 (December 1984).

Evidence for the  $F^*$  Meson, H. Aihara, M. Alston-Garnjost, D.H. Badtke, J.A. Bakken, A. Barbaro-Galtieri, A.V. Barnes, B.A. Barnett, B. Blumenfeld, A. Bross, C.D. Buchanan, O. Chamberlain, J. Chiba, C.Y. Chien, A.R. Clark, A. Cordier, O.I. Dahl, C.T. Day, K.A. Derby, P.H. Eberhard, R. Enomoto, D.L. Fancher, H. Fujii, T. Fujii, B. Gabioud, J.W. Gary, W. Gorn, N.J. Hadley, J.M. Hauptman, W. Hofmann, J.E. Huth, J. Hylen, H. Iwasaki, T. Kamae, H.S. Kaye, R.W. Kenney, L.T. Kerth, R. Koda, R.R. Kofler, K.K. Kwong, J.G. Layter, C.S. Lindsey, S.C. Loken, X.-Q. Lu, G.R. Lynch, L. Madansky, R.J. Madaras, R. Majka, P.S. Martin, K. Maruyama, J.N. Marx, J.A.J. Matthews, S.O. Melnikoff, W. Moses, P. Nemethy, D.R. Nygren, P.J. Oddone, D.A. Park, A. Pevsner, M. Pripstein, P.R. Robrish, M.T. Ronan, R.R. Ross, F.R. Rouse, R.R. Sauerwein, G. Shapiro, M.D. Shapiro, B.C. Shen, W.E. Slater, M.L. Stevenson, D.H. Stork, H.K. Ticho, N. Toge, G.J. VanDalen, R. van Tyen, E.M. Wang, M.R. Wayne, W.A. Wenzel, R.F. van Daalen Wetters, H. Yamamoto, M. Yamauchi, M.E. Zeller, and W.-M. Zhang, Phys. Rev. Letters 53, 2465 (December 1984).

$K^*0$  and  $K_s^0$  Meson Production in  $e^+e^-$  Annihilation at 29 GeV, H. Aihara, M. Alston-Garnjost, J.A. Bakken, A. Barbaro-Galtieri, A.V. Barnes, B.A. Barnett, B.J. Blumenfeld, A. Bross, C.D. Buchanan, O. Chamberlain, C.-Y. Chien, A.R. Clark, A. Cordier, O.I. Dahl, C.T. Day, K.A. Derby, P.H. Eberhard, D.L. Fancher, H. Fujii, T. Fujii, B. Gabioud, J.W. Gary, W. Gorn, N.J. Hadley, J.M. Hauptman, W. Hofmann, J.E. Huth, J. Hylen, T. Kamae, H.S. Kaye, R.W. Kenney, L.T. Kerth, R. Koda, R.R. Kofler, K.K. Kwong, J.G. Layter, C.S. Lindsey, S.C. Loken, X.-Q. Lu, G.R. Lynch, L. Madansky, R.J. Madaras, K. Maruyama, J.N. Marx, J.A.J. Matthews, S.O. Melnikoff, W. Moses, P. Nemethy, D.R. Nygren, P.J. Oddone, D.A. Park, A. Pevsner, M. Pripstein, P.R. Robrish, M.T. Ronan, R.R. Ross, F.R. Rouse, R.R. Sauerwein, G. Shapiro, M.D. Shapiro, B.C. Shen, W.E. Slater, M.L. Stevenson, D.H. Stork, H.K. Ticho, N. Toge, G.J. VanDalen, R. van Tyen, E.M. Wang, M. Wayne, W.A. Wenzel, R.F. vanDaalen Wetters, H. Yamamoto, M. Yamauchi, and W.-M. Zhang, Phys. Rev. Letters 53, 2378 (December 1984).

Lambda Production in  $e^+e^-$  Annihilation at 29 GeV, H. Aihara, M. Alston-Garnjost, J.A. Bakken, A. Barbaro-Galtieri, A.V. Barnes, B.A. Barnett, B. Blumenfeld, A. Bross, C.D. Buchanan, O. Chamberlain, C.-Y. Chien, A.R. Clark, A. Cordier, O.I. Dahl, C.T. Day, K.A. Derby, P.H. Eberhard, D.L. Fancher, H. Fujii, T. Fujii, B. Gabioud, J.W. Gary, W. Gorn, N.J. Hadley, J.M. Hauptman, W. Hofmann, J.E. Huth, J. Hylen, T. Kamae, H.S. Kaye, R.W. Kenney, L.T. Kerth, R. Koda, R.R. Kofler, K.K. Kwong, J.G. Layter, C.S. Lindsey, S.C. Loken, X.-Q. Lu, G.R. Lynch, L. Madansky, R.J. Madaras, K. Maruyama, J.N. Marx, J.A.J. Matthews, S.O. Melnikoff, W. Moses, P. Nemethy, D.R. Nygren, P.J. Oddone, D. Park, A. Pevsner, M. Pripstein, P.R. Robrish, M.T. Ronan, R.R. Ross, F.R. Rouse, R.R. Sauerwein, G. Shapiro, M.D. Shapiro, B.C. Shen, W.E. Slater, M.L. Stevenson, D.H. Stork, H.K. Ticho, N. Toge, G.J. Van Dalen, R. van Tyen, E.M. Wang, M.R. Wayne, W.A. Wenzel, R.F. van Daalen Wetters, H. Yamamoto, M. Yamauchi, and W.-M. Zhang, Phys. Rev. Letters 54, 274 (January 1985).

Inclusive Gamma and Pi-zero Production Cross Sections and Energy Fractions in  $e^+e^-$  Annihilation at 29 GeV, H. Aihara, M.



Alston-Garnjost, J.A. Bakken, A. Barbaro-Galtieri, A.V. Barnes, B.A. Barnett, H.-U. Bengtsson, B.J. Blumenfeld, A. Bross, C.D. Buchanan, O. Chamberlain, J. Chiba, C.-Y. Chien, A.R. Clark, A. Cordier, O.I. Dahl, C.T. Day, K.A. Derby, P.H. Eberhard, D.L. Fancher, H. Fujii, T. Fujii, B. Gabioud, J.W. Gary, W. Gorn, N.J. Hadley, J.M. Hauptman, W. Hofmann, J.E. Huth, J. Hylen, H. Iwasaki, T. Kamae, H.S. Kaye, R.W. Kenney, L.T. Kerth, R.I. Koda, R.R. Kofler, K.K. Kwong, J.G. Layter, C.S. Lindsey, S.C. Loken, X.-Q. Lu, G.R. Lynch, L. Madansky, R.J. Madaras, K. Maruyama, J.N. Marx, J.A.J. Matthews, S.O. Melnikoff, W. Moses, P. Nemethy, D.R. Nygren, P.J. Oddone, D. Park, A. Pevsner, M. Pripstein, P.R. Robrish, M.T. Ronan, R.R. Ross, F.R. Rouse, R.R. Sauerwein, G. Shapiro, M.D. Shapiro, B.C. Shen, W.E. Slater, M.L. Stevenson, D.H. Stork, H.K. Ticho, N. Toge, G.J. Van Dalen, R. van Tyen, H. Videau, E.M. Wang, M.R. Wayne, W.A. Wenzel, R.F. van Daalen Wetters, H. Yamamoto, M. Yamauchi, and W.-M. Zhang, LBL Report LBL-18326 (October 1984), to be published in *Z. Physik. C*.

Tests of Models for Parton Fragmentation Using 3-Jet Events in  $e^+e^-$  Annihilation at  $\sqrt{s} = 29$  GeV, H. Aihara, M. Alston-Garnjost, J.A. Bakken, A. Barbaro-Galtieri, A.V. Barnes, B.A. Barnett, H.-U. Bengtsson, B.J. Blumenfeld, A.D. Bross, C.D. Buchanan, O. Chamberlain, C.-Y. Chien, A.R. Clark, A. Cordier, O.I. Dahl, C.T. Day, K.A. Derby, P.H. Eberhard, D.L. Fancher, H. Fujii, T. Fujii, B. Gabioud, J.W. Gary, W. Gorn, N.J. Hadley, J.M. Hauptman, W. Hofmann, J.E. Huth, J. Hylen, T. Kamae, H.S. Kaye, R.W. Kenney, L.T. Kerth, R.I. Koda, R.R. Kofler, K.K. Kwong, J.G. Layter, C.S. Lindsey, S.C. Loken, X.-Q. Lu, G.R. Lynch, L. Madansky, R.J. Madaras, K. Maruyama, J.N. Marx, J.A. Matthews, S.O. Melnikoff, W. Moses, P. Nemethy, D.R. Nygren, P.J. Oddone, D.A. Park, A. Pevsner, M. Pripstein, P.R. Robrish, M.T. Ronan, R.R. Ross, F.R. Rouse, R.R. Sauerwein, G. Shapiro, M.D. Shapiro, B.C. Shen, W.E. Slater, M.L. Stevenson, D.H. Stork, H.K. Ticho, N. Toge, G.J. Van Dalen, R. van Tyen, E.M. Wang, M.R. Wayne, W.A. Wenzel, R.F. van Daalen Wetters, H.A. Yamamoto, M. Yamauchi, W.-M. Zhang, LBL Report LBL-18407 (October 1984), TPC-LBL-84-44, *Phys. Rev. Letters*. 54, 270 (January 1985).

Study of Bose-Einstein Correlations in  $e^+e^-$  Annihilation at 29 GeV, H. Aihara, M. Alston-Garnjost, J.A. Bakken, A. Barbaro-Galtieri, A.V. Barnes, B.A. Barnett, H.-U. Bengtsson, B.J. Blumenfeld, A.D. Bross, C.D. Buchanan, O. Chamberlain, C.-Y. Chien, A.R. Clark, A. Cordier, O.I. Dahl, C.T. Day, K.A. Derby, P.H. Eberhard, D.L. Fancher, H. Fujii, T. Fujii, B. Gabioud, J.W. Gary, W. Gorn, N.J. Hadley, J.M. Hauptman, W. Hofmann, J.E. Huth, J. Hylen, T. Kamae, H.S. Kaye, R.W. Kenney, L.T. Kerth, R.I. Koda, R.R. Kofler, K.K. Kwong, J.G. Layter, C.S. Lindsey, S.C. Loken, X.-Q. Lu, G.R. Lynch, L. Madansky, R.J. Madaras, K. Maruyama, J.N. Marx, J.A.J. Matthews, S.O. Melnikoff, W. Moses, P. Nemethy, D.R. Nygren, P.J. Oddone, D.A. Park, A. Pevsner, M. Pripstein, P.R. Robrish, M.T. Ronan, R.R. Ross, F.R. Rouse, R.R. Sauerwein, G. Shapiro, M.D. Shapiro, B.C. Shen, W.E. Slater, M.L. Stevenson, D.H. Stork, H.K. Ticho, N. Toge, G.J. Van Dalen, R. van Tyen, E.M. Wang, M.R. Wayne, W.A. Wenzel, R.F. van Daalen Wetters, H. Yamamoto, M. Yamauchi, W.-M. Zhang, LBL Report LBL-18478 (October 1984), TPC-LBL-84-46, to be published in *Phys. Rev.*

Test of Models for Quark and Gluon Fragmentation in  $e^+e^-$  Annihilation  $\sqrt{s} = 29$  GeV, H. Aihara, M. Alston-Garnjost, J.A. Bakken, A. Barbaro-Galtieri, A.V. Barnes, B.A. Barnett, H.-U. Bengtsson, B.J. Blumenfeld, A.D. Bross, C.D. Buchanan, O. Chamberlain, C.-Y. Chien, A.R. Clark, A. Cordier, O.I. Dahl, C.T. Day, K.A. Derby, P.H. Eberhard, D.L. Fancher, H. Fujii, T. Fujii, B. Gabioud, J.W. Gary, W. Gorn, N.J. Hadley, J.M. Hauptman, W. Hofmann, J.E. Huth, J. Hylen, T. Kamae, H.S. Kaye, R.W. Kenney, L.T. Kerth, R.I. Koda, R.R. Kofler, K.K. Kwong, J.G. Layter, C.S. Lindsey, S.C. Loken, X.-Q. Lu, G.R. Lynch, L. Madansky, R.J. Madaras, K. Maruyama, J.N. Marx, J.A.J. Matthews, S.O. Melnikoff, W. Moses, P. Nemethy, D.R. Nygren, P.J. Oddone, D.A. Park, A. Pevsner, M. Pripstein, P.R. Robrish, M.T. Ronan, R.R. Ross, F.R. Rouse, R.R. Sauerwein, G. Shapiro, M.D. Shapiro, B.C. Shen, W.E. Slater, M.L. Stevenson, D.H. Stork, H.K. Ticho, N. Toge, G.J. Van Dalen, R. van Tyen, E.M. Wang, M.R. Wayne, W.A. Wenzel, R.F. van Daalen Wetters, H. Yamamoto, M. Yamauchi, W.-M. Zhang, LBL Report LBL-18408 (October 1984) submitted for publication to *Z. Physik*.

Quark Fragmentation Functions and Long-Range Correlations in  $e^+e^-$  Annihilation at 29 GeV, H. Aihara, M. Alston-Garnjost, J.A. Bakken, A. Barbaro-Galtieri, A.V. Barnes, B.A. Barnett, H.-U. Bengtsson, B.J. Blumenfeld, A.D. Bross, C.D. Buchanan, O. Chamberlain, C.-Y. Chien, A.R. Clark, A. Cordier, O.I. Dahl, C.T. Day, K.A. Derby, P.H. Eberhard, D.L. Fancher, H. Fujii, T. Fujii, B. Gabioud, J.W. Gary, W. Gorn, N.J. Hadley, J.M. Hauptman, W. Hofmann, J.E. Huth, J. Hylen, T. Kamae, H.S. Kaye, R.W. Kenney, L.T. Kerth, R.I. Koda, R.R. Kofler, K.K. Kwong, J.G. Layter, C.S. Lindsey, S.C. Loken, X.-Q. Lu, G.R. Lynch, L. Madansky, R.J. Madaras, K. Maruyama, J.N. Marx, J.A.J. Matthews, S.O. Melnikoff, W. Moses, P. Nemethy, D.R. Nygren, P.J. Oddone, D.A. Park, A. Pevsner, M. Pripstein, P.R. Robrish, M.T. Ronan, R.R. Ross, F.R. Rouse, R.R. Sauerwein, G. Shapiro, M.D. Shapiro, B.C. Shen, W.E. Slater, M.L. Stevenson, D.H. Stork, H.K. Ticho, N. Toge, G.J. Van Dalen, R. van Tyen, E.M. Wang, M.R. Wayne, W.A. Wenzel, R.F. van Daalen Wetters, H. Yamamoto, M. Yamauchi, W.-M. Zhang, LBL Report LBL-18911 (January 1985), submitted to *Z. Physik*.

Prompt Muon Production in  $e^+e^-$  Annihilations at 29 GeV, H. Aihara, M. Alston-Garnjost, D.H. Badtke, J.A. Bakken, A. Barbaro-Galtieri, A.V. Barnes, B.A. Barnett, H.-U. Bengtsson, B.J. Blumenfeld, A.D. Bross, C.D. Buchanan, O. Chamberlain, C.-Y. Chien, A.R. Clark, A. Cordier, O.I. Dahl, C.T. Day, K.A. Derby, P.H. Eberhard, D.L. Fancher, H. Fujii, T. Fujii, B. Gabioud, J.W. Gary, W. Gorn, N.J. Hadley, J.M. Hauptman, W. Hofmann, J.E. Huth, J. Hylen, T. Kamae, H.S. Kaye, R.W. Kenney, L.T. Kerth, R.I. Koda, R.R. Kofler, K.K. Kwong, J.G. Layter, C.S. Lindsey, S.C. Loken, X.-Q. Lu, G.R. Lynch, L. Madansky, R.J. Madaras, K. Maruyama, J.N. Marx, J.A.J. Matthews, S.O. Melnikoff, W. Moses, P. Nemethy, D.R. Nygren, P.J. Oddone, D.A. Park, A. Pevsner, M. Pripstein, P.R. Robrish, M.T. Ronan, R.R. Ross, F.R. Rouse, R.R. Sauerwein, G. Shapiro, M.D. Shapiro, B.C. Shen, W.E. Slater, M.L. Stevenson, D.H. Stork, H.K. Ticho, N. Toge, G.J. Van Dalen, R. van Tyen, E.M. Wang, M.R. Wayne, W.A. Wenzel, H. Yamamoto, M. Yamauchi, W.-M. Zhang, TPC-JHU-85-1, January 1985, to be published in *Phys. Rev. D*.

Measurement of the Total Hadronic Cross Section in Virtual Photon-Photon Interactions, J.C. Armitage, D. Bintinger, A. Buijs, D.O. Caldwell, M.P. Cain, A.M. Eisner, F.C. Erne, U.P. Joshi, K.H. Kees, W. Ko, R.L. Lander, W.G.J. Langeveld, A. Lu, K. Maeshima, G.E. Masek, R.R. McNeil, E.S. Miller, H.P. Paar, D.A. Palmer, D.E. Pellett, K.A. Schwitkis, J.C. Sens, J.E. Smith, M.K. Sullivan, J.R. Thompson, J. Timmer, M.A. Van Driel, B. Van Uitert, W. Vernon, J.T. White, M.C.S. Williams, S.J. Yellin, Phys. Rev. Lett. 25, 763 (February 1985).

Exclusive Production of  $K^+K^-\pi^+\pi^-$  in Photon-Photon Collisions, H. Aihara, M. Alston-Garnjost, J.C. Armitage, J.A. Bakken, A. Barbaro-Galtieri, A.R. Barker, A.V. Barnes, B.A. Barnett, H.-U. Bengtsson, D.L. Bintinger, B.J. Blumenfeld, G.J. Bobbink, A.D. Bross, C.D. Buchanan, A. Buijs, M.P. Cain, D.O. Caldwell, O. Chamberlain, C.-Y. Chien, A.R. Clark, A. Cordier, O.I. Dahl, C.T. Day, K.A. Derby, M.A. van Driel, P.H. Eberhard, A.M. Eisner, F.C. Erne, D.L. Fancher, H. Fujii, T. Fujii, B. Gabioud, J.W. Gary, W. Gorn, N.J. Hadley, J.M. Hauptman, W. Hofmann, J.E. Huth, J. Hylen, U.P. Joshi, T. Kamae, H.S. Kaye, K.H. Kees, R.W. Kenney, L.T. Kerth, W. Ko, R.I. Koda, R.R. Kofler, K.K. Kwong, R.L. Lander, W.G.J. Langeveld, J.G. Layter, F.L. Linde, C.S. Lindsey, S.C. Loken, A. Lu, X.-Q. Lu, G.R. Lynch, L. Madansky, R.J. Madaras, K. Maeshima, B.D. Magnuson, J.N. Marx, K. Maruyama, G.E. Masek, J.A.J. Matthews, S.O. Melnikoff, E.S. Miller, W. Moses, R.R. McNeil, P. Nemethy, D.R. Nygren, P.J. Oddone, H.P. Paar, D.A. Palmer, D.A. Park, D.E. Pellett, A. Pevsner, M. Pripstein, P.R. Robrish, M.T. Ronan, R.R. Ross, F.R. Rouse, R.R. Sauerwein, K.A. Schwitkis, J.C. Sens, G. Shapiro, M.D. Shapiro, B.C. Shen, W.E. Slater, J.R. Smith, M.L. Stevenson, D.H. Stork, M.K. Sullivan, J.R. Thompson, H.K. Ticho, J. Timmer, N. Toge, R. van Tyen, B. van Uitert, G.J. VanDalen, R.F. vanDaalen Wetters, W. Vernon, W. Wagner, E.M. Wang, Y.X. Wang, M.R. Wayne, W.A. Wenzel, J.T. White, M.C.S. Williams, H. Yamamoto, M. Yamauchi, S.J. Yellin, W.-M. Zhang, TPC-UCR-85-4, March 1985, to be published in Phys. Rev. Letters.

Baryon Production in  $e^+e^-$  Annihilation at  $\sqrt{s} = 29$  GeV: Clusters, Diquarks, Popcorn?, H. Aihara, M. Alston-Garnjost, J.A. Bakken, A. Barbaro-Galtieri, A.V. Barnes, B.A. Barnett, H.-U. Bengtsson, B.J. Blumenfeld, A.D. Bross, C.D. Buchanan, O. Chamberlain, C.-Y. Chien, A.R. Clark, A. Cordier, O.I. Dahl, C.T. Day, K.A. Derby, P.H. Eberhard, D.L. Fancher, H. Fujii, T. Fujii, B. Gabioud, J.W. Gary, W. Gorn, N.J. Hadley, J.M. Hauptman, W. Hofmann, J.E. Huth, J. Hylen, T. Kamae, H.S. Kaye, R.W. Kenney, L.T. Kerth, R.I. Koda, R.R. Kofler, K.K. Kwong, J.G. Layter, C.S. Lindsey, S.C. Loken, X.-Q. Lu, G.R. Lynch, L. Madansky, R.J. Madaras, K. Maruyama, J.N. Marx, J.A.J. Matthews, S.O. Melnikoff, W. Moses, P. Nemethy, D.R. Nygren, P.J. Oddone, D.A. Park, A. Pevsner, M. Pripstein, P.R. Robrish, M.T. Ronan, R.R. Ross, F.R. Rouse, R.R. Sauerwein, G. Shapiro, M.D. Shapiro, B.C. Shen, W.E. Slater, M.L. Stevenson, D.H. Stork, H.K. Ticho, N. Toge, G.J. VanDalen, R. van Tyen, E.M. Wang, M.R. Wayne, W.A. Wenzel, R.F. van Daalen Wetters, H. Yamamoto, M. Yamauchi, W.-M. Zhang, LBL-19566, April 1985 submitted for publication.

Hadron Production in  $e^+e^-$  Annihilation at PEP, W. Hofmann, invited talk presented at the Symposium on High Energy  $e^+e^-$  Interactions, Vanderbilt University, Nashville, TN, April 5-7, 1984, LBL-17845.

Recent Results from the PEP-4 TPC, R.J. Madaras, Invited talk presented at the XIXth Rencontre de Moriond, "New Particle Production at High Energies," La Plagne, France, March 4-10, 1984, LBL-17806.

New Results on Flavor Production at PEP, L. Galtieri, Invited talk presented at the Erice Conference on Flavor Mixing, Erice, Italy, March 4-11, 1984, LBL-17899.

Quark Fragmentation in  $e^+e^-$  Annihilation, L. Galtieri, Invited talk presented at the XVth Symposium on Multiparticle Dynamics, Lund, Sweden, June 10-16, 1984, LBL-18424.

Inclusive  $\gamma$  and  $\pi^0$  Production in  $e^+e^-$  Annihilation at 29 GeV, H. Aihara, LBL-84-1, 1/17/84.

Washington Meeting Abstracts, PEP-4/PEP-9, LBL-84-2, 1/31/84.

Washington Meeting Abstracts, P. Oddone, LBL-84-3, 1/31/84.

Comparison of MC for  $e^+e^- \rightarrow$  Hadrons Inclusive Spectra, W. Hofmann, LBL-84-4, 2/2/84.

Lund Version 5.2, H. Bengtsson, UCLA-84-1, 2/17/84.

RSPLIB — General Description, J. Wissmar, LBL-84-5, 2/23/84.

Exp. 11/12 Event Vertex Locations and Comparisons with FMC, N. Toge, UT-84-1, 6/27/84.

Estimates of Backgrounds in Hadronic Event Samples, H. Yamamoto and N. Toge, UT-84-2, 6/27/84.

Comparisons of TUBES, Lund 52, CITQCD vs Exp. 11/12 — Event Topology Correction and Invariant Mass, H. Yamamoto, UT-84-4, 2/28/84.

Beam Position in the TPC in Experiments 10, 11, and 12, G. Lynch, LBL-84-6, 3/8/84.

Vax Utilities — CERN Library — LBL Library Routines — Fourth Edition, R.W. Kenney, LBL-84-7, 2/15/84.

Recent PEP-4 TPC Results, R. Madaras, LBL-84-8, 3/21/84.

Joint US/Japan Agreement: Participation in the PEP-4 TPC, P. Oddone, LBL-84-9, 3/28/84.

Recent Results with the TPC at PEP, L. Galtieri, LBL-84-10, 4/5/84.

FMC- Verlund Users Guide, G. VanDalen, UCR-84-1, 4/10/84.

- Study of PEP-4 Trigger Efficiency Using PEP-9 Single Tagged Events, C. Lindsey, UCR-84-2, 4/10/84.
- $p_T$  Smearing in the Equivalent Photon Monte Carlo- TWOLUND, G. VanDalen, UCR-84-3, 4/10/84.
- Proposal for a PEP-4/PEP-9 Upgrade with Small Angle BGO Calorimeters, LBL-84-11, 4/13/84.
- The Radial Drift Chamber — Vertex Detector for TPC, D. Nygren, LBL-84-12, 4/19/84.
- The PEP-4 TPC April 1984, P. Oddone, LBL-84-13, 4/23/84.
- Study of Untagged  $\gamma\gamma \rightarrow \pi^+\pi^-$ , PEP-4/PEP-9 Collaboration, UCR-84-4, 5/7/84.
- Four Charged Particle Final States Untagged  $\gamma\gamma$  Interactions, PEP-4/PEP-9 Collaboration, UCR-84-5, 5/7/84.
- PEP-4 Monte Carlo Data Tape Format, W. Koellner and M. Garnjost et al, LBL-84-14, 5/9/84.
- LDBSUP, A. Clark, LBL-84-15, 5/10/84.
- Safety Status of TPC Gas System Tube Trailer No. 11 (Argon I), G. Schnurmacher, LBL-84-16, 5/15/84.
- Abstracts Leipzig Meeting QQ Events, W. Hofmann and J.A.J. Matthews, LBL-84-17, 5/15/84.
- Gas System Tube Trailer #10 Rework and Modifications Done During Spring '84, G. Schnurmacher, LBL-84-18, 5/15/84.
- Calculated Axial Values of  $\int \vec{B} \cdot d\vec{\ell}$  Superconducting Magnet, L. Stevenson, LBL-84-19, 5/23/84.
- Two Photon Physics — Leipzig Abstracts, PEP-4/PEP-9, LBL-84-20, 5/24/84.
- Summary of New Resistive Coatings Tests, A. Bross, LBL-84-21, 5/29/84.
- Energy Resolution in Three HEX Gas Mixtures, J. Hauptman, ISU-84-1, 5/29/84.
- DOE Review, P. Oddone, LBL-84-22, 6/4/84.
- Proposal to Improve TPC Data Structure, B. Gabioud, LBL-84-23, 6/7/84.
- Improvements of the TPC On-Line Data Acquisition System, B. Gabioud, LBL-84-24, 2/6/84.
- dE/dx Studies in Experiment 11, N. Hadley, Yale-84-1, 6/14/84.
- A Pedestrians Guide to DST Analysis, B. Moses, LBL-84-27, 6/25/84.
- $D^* \rightarrow D^0$  Reconstruction in Exps. 10+11+12, J. Hauptman, ISU-84-2, 6/26/84.
- Quark Fragmentation in  $e^+e^-$  Annihilation — Invited talk given at the Lund Conference on “Multiparticle Dynamics” — June 10–16, 1984, L. Galtieri, LBL-84-28, 6/27/84.
- TPC Q-Q Bar Workshop 6/1-2/84 UC Campus Faculty Club, L. Galtieri, LBL-84-32, 7/2/84.
- Study of  $f^0$  Formation and its Decay Into  $\pi^+\pi^-$  in Photon-Photon Collisions at PEP, J. Layter and PEP-4/PEP-9, UCR-84-6, 7/2/84.
- Exclusive Production of  $K^+K^-\pi^+\pi^-$  and  $\pi^+\pi^-\pi^+\pi^-$  in Photon-Photon Collisions, J. Layter and PEP-4/PEP-9, UCR-84-7, 7/3/84.
- Study of  $\eta'$  Formation in Photon-Photon Collisions at PEP, PEP-4/PEP-9 (Leipzig) TPC-TWG-84-1, 7/3/84.
- TPC Data Tape Format Changes, O. Dahl, LBL-84-35, 7/16/84.
- TPC Electronic Calibration Data Base Version 2, A. Clark, LBL-84-36, 7/18/84.
- TPC Magnet Mapping: Data Analysis Meeting Talk — 7/13/84, L. Stevenson, LBL-84-37, 7/27/84.
- Routines for Doing Vertex Fits at the DST Level, G. Lynch and M. Garnjost LBL-84-38, 7/24/84.
- 1984 Topical Conference, P. Oddone, LBL-84-39, 7/30/84.
- Prompt Muon Production in  $e^+e^-$  Annihilations at 29 GeV, J.A.J. Matthews, JHU-84-1, 7/31/84.
- XXII International Conference on High Energy Physics — Leipzig — 7/19-25/84, J.A.J. Matthews, JHU-84-2, 7/31/84.
- Delphi Progress Report, H. Hilke, CERN-84-1, 8/9/84.
- Magnetic Mapping: Data Analysis Perspective, G. Przybylski, LBL-84-40, 8/2/84.
- Heavy Quark Semi-Leptonic Decays and Tau-Lepton Branching Fractions, J.A.J. Matthews, JHU-84-3, 8/27/84.
- The Aleph TPC-Mainly TPC 90, R. Settles, LBL-84-41, 8/30/84.
- Baryon Production in  $e^+e^-$  Annihilation at 29 GeV, K. Maruyama, UT-84-11, 9/13/84.
- Inclusive Rapidity Distributions, M. Shapiro, LBL-84-43, 9/18/84.
- HERA Workshop at Genoa, Italy, L. Stevenson, LBL-84-48, 11/13/84.
- Dependence of MC Predictions on s/u (SF, IF) and CLMAX (CF), N. Toge, UT-84-16, 11/15/84.

Effect of Reference Voltage on Gated Grid Pick-up, J. Huth, LBL-84-49, 11/27/84.

Hyperon Physics in  $e^+e^-$  Annihilation Process at High Luminosities, H. Yamamoto, UT-84-17, 11/27/84.

Status of the PEP 4/9 TPC EPAC, P. Oddone, LBL-84-50, 12/12/84.

Proceedings of the DPF Symposium, Santa Fe, 1984, B. Shen, UCR-85-1, 1/7/85.

Subtraction of the  $ee \rightarrow ee \mu\mu$  Final Status from the Two Prong Data, W.J. Langeveld and F.C. Erne, UCR-85-2, 1/25/85.

Prompt Muon Production in  $e^+e^-$  Annihilations, J. Hylen and X-Q Lu, JHU-84-1, 1/25/85.

### PEP-4/9 TPC Dissertations Completed

"An Experimental Study of Muons Produced by Two Photon Interactions at PEP," Kaori Maeshima, Ph.D. Dissertation, University of California at Davis, December 1981.

"Prompt Muon Rate From  $e^+e^-$  Annihilations at 29 GeV," Jon Alan Bakken, Ph.D. Dissertation, Johns Hopkins University, April 1983.

"Charged Hadron Production in  $e^+e^-$  Collisions at PEP with the TPC," Nicholas John Hadley, Ph.D. Dissertation, Lawrence Berkeley Laboratory, University of California at Berkeley, May 1983.

"A Study of Small Angle Radiative Bhabhas at 29.0 GeV," Umeshwar Prasad Joshi, Ph.D. Dissertation, University of California at Santa Barbara, January 1984.

"Measurement of the Leptonic Structure Functions of the Photon at PEP," Michael Patrick Cain, Ph.D. Dissertation, University of California at Davis, April 1984.

"Four Charged Particle Final States in Untagged Two-Photon Events at PEP," Clark Sergent Lindsey, Ph.D. Dissertation, University of California at Riverside, August 1984.

"The Study of Untagged  $\gamma\gamma \rightarrow \pi^+\pi^-$  at PEP," Kenneth Kin Man Kwong, Ph.D. Dissertation, University of California at Riverside, August 1984.

"A Search for Fractionally Charged Particles in  $e^+e^-$  Annihilations," John E. Huth, Ph.D. Dissertation, Lawrence Berkeley Laboratory, University of California at Berkeley, September 1984.

"Semileptonic Decay of Heavy Quarks in  $e^+e^-$  Collisions at 29 GeV," Hiroaki Aihara, Ph.D. Dissertation, University of Tokyo, October 1984.

"Inclusive Distributions and Two Particle Correlations in  $e^+e^-$  Annihilation at 29 GeV Center-Of-Mass Energy," Marjorie

Shapiro, Ph.D. Dissertation, Lawrence Berkeley Laboratory, University of California at Berkeley, December 1984.

"Inclusive Production of  $\phi$ ,  $K^{*0}$  and  $K_S^0$  Mesons in  $e^+e^-$  Annihilations at 29 GeV," Nobukazu Toge, Ph.D. Dissertation, University of Tokyo, January 1985.

"A Study of Resonance Production in Double-Tagged Two-Photon Reactions," John Robert Thompson, Ph.D. Dissertation, University of California at San Diego, March 1985.

"Inclusive Photon and  $\pi^0$  Production in  $e^+e^-$  Annihilation at 29 GeV," Masanori Yamauchi, Ph.D. Dissertation, National Laboratory for High Energy Physics, KEK, Japan, February 1985.

## The MARK II Detector

The MARK II Detector program during 1984 was primarily devoted to the major upgrade of the detector in collaboration with groups from Caltech, UC Santa Cruz, Colorado, Hawaii, Johns Hopkins, Michigan, and SLAC, in preparation for physics at the SLC. The main LBL responsibility in this upgrade is the construction and testing of two end-cap electromagnetic calorimeters. Other LBL involvements in this upgrade include collaborative efforts in the writing of track reconstruction software for the new drift chamber under construction at SLAC, and in the development of a new high resolution vertex detector.

To accomplish these upgrades the MARK II detector was removed from the beam line in April 1984. The physics program was thus mainly concerned with analysis of the data in hand which amounted to over  $220 \text{ pb}^{-1}$  all taken at 29 GeV.

### PEP Data Analysis

The use of the high resolution vertex detector coupled with the relatively high luminosity collected has remained the strong point of the MARK II in the 1984 analysis work. The major results include the following:

1. Further improvement in the  $\tau$  lifetime measurement. The latest result based on 807 events is  $(2.86 \pm 0.16 \pm 0.25) \times 10^{-13}$  sec. This is remarkably close to the theoretical value of  $(2.82 \pm 0.18) \times 10^{-13}$  sec. To check more precisely for deviations from theory, the leptonic branching ratio measurement would have to be improved to reduce the error in the theoretical



number. This result is quoted in Dan Amidei's thesis and will be published shortly.

2. A new and independent measurement of the B lifetime has been carried out. This measurement consists of reconstructing B decay vertices. The result is based on a 64% B enriched sample yielding 551 jets and gives  $(1.25 \pm_{0.19}^{0.26}) \times 10^{-12}$  sec. This is in good agreement with our earlier measurements and with measurements from other detectors. It confirms the surprising result of a B lifetime substantially longer than originally expected.
3. Further measurements of the  $D^0$  lifetime, based on improved statistics and additional  $D^0$  decay modes, viz.  $D^0 \rightarrow K^- \pi^+$  and  $D^0 \rightarrow K^- \pi^+ \pi^0$ . This gives  $(4.5 \pm_{0.8}^{0.9} \pm 0.5) \times 10^{-13}$  sec. based on 73 events.
4. Our first attempt to measure the  $D^+$  lifetime, based on 23 events, gives  $(8.5 \pm_{2.5}^{3.4} \pm 1.0) \times 10^{-13}$  sec.
5. From a study of 1600  $\Lambda$  and  $\bar{\Lambda}$  events we determined the production of  $\Lambda$ ,  $\bar{\Lambda}$  hyperons in  $e^+e^-$  annihilation as a function of their total momenta, transverse momenta, and the event thrust. The total production rate is  $0.213 \pm .012 \pm .018$   $\Lambda$  or  $\bar{\Lambda}$  per hadronic event. The observation of correlations in rapidity and angles for events with detected  $\Lambda$  and  $\bar{\Lambda}$  decays supports fragmentation models with local baryon number compensation. Fig. 13 shows that the transverse momentum distribution for  $\Lambda(\bar{\Lambda})$  differs substantially from that of charged particles most of which are pions.
6. We have studied the production rates for  $\rho^0$ ,  $K^{*0}$  and  $K^{*\pm}$  mesons in  $e^+e^-$  annihilation with the MARK II detector at PEP. These rates can be interpreted in terms of a suppression factor of  $0.52 \pm 0.12 \pm 0.16$  for strange relative to non-strange vector meson production in jet fragmentation.
7. The charged particle multiplicities of hadronic events deriving from produced bottom or charm quarks have been measured. For events containing one semi-leptonic and one hadronic weak decay, we find event multiplicities of  $15.2 \pm 0.5 \pm 0.7$  for bottom and  $13.0 \pm 0.5 \pm 0.8$  for charm. The corresponding multiplicities of the charged particles accompanying the pair of heavy hadrons are  $5.2 \pm 0.5 \pm 0.9$  for bottom, and  $8.1 \pm 0.5 \pm 0.9$  for charm.

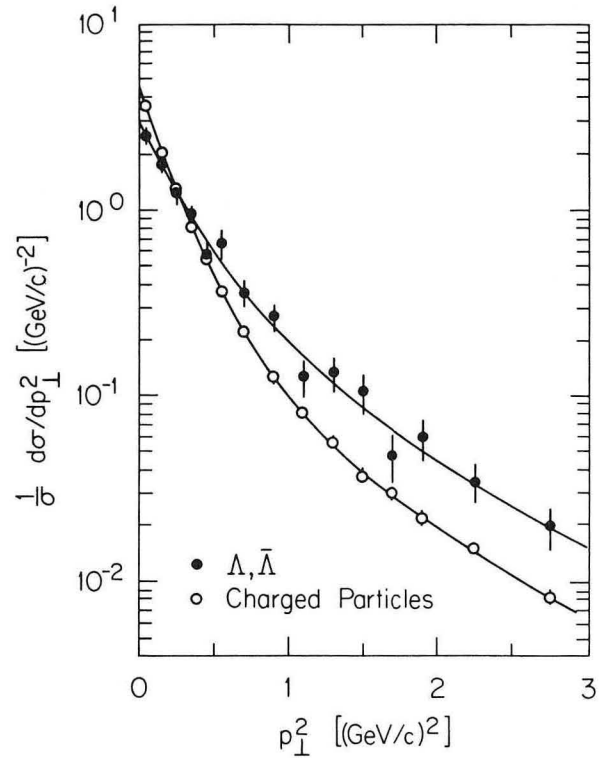

XBL 8512-4915

Fig. 13. Distribution of the transverse momentum squared for  $\Lambda$  hyperons and all charged particles, normalized to the total number of particles. The curves represent empirical fits to the data.

8. We have updated our previous analysis of the  $\tau \rightarrow 3\pi^\pm \pi^0 \nu$  decay mode by the addition of new data and obtain an improved upper limit on the  $\nu_\tau$  mass of  $143 \text{ MeV}/c^2$  at the 95% confidence level. Fig. 14 shows the observed four pion mass distribution.

## Upgrade of the MARK II Detector

### Introduction

The MARK II is the first detector scheduled for doing an experiment at the Stanford Linear Collider (SLC), the newest and highest energy particle collider at SLAC. Based upon an entirely new and untried concept, the SLC scheme offers a means of reaching even higher energies in electron-positron ( $e^+e^-$ ) collision without prohibitive cost. In addition to testing this new collider concept, there will be very interesting physics at the SLC energy. The recently discovered  $Z^0$ , the most massive of all known fundamental particles and the basis for the weak force in nature, will be produced for the first time in  $e^+e^-$  collisions. The SLC, now under construction at SLAC,

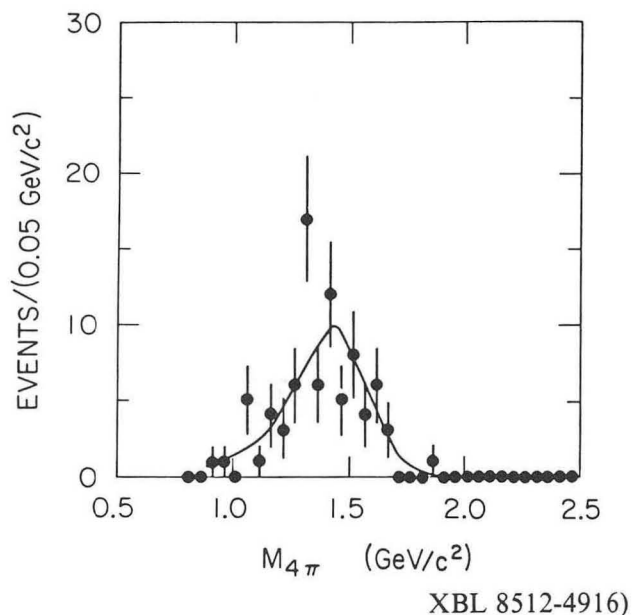

Fig. 14. Four-pion invariant mass distribution of  $\tau$  decays in the MARK II. The curve shows the expected spectrum for  $m(\nu_\tau) = 0$  under the assumption that the four-pion  $\tau$  decay mode is dominated by the  $\rho'$  resonance.

is scheduled to turn on in late 1986 or early 1987. This physics will also be the subject of an intensive research program in Europe by a more conventional means, viz. with a large  $e^+e^-$  storage ring called LEP, which is now under construction. Although turning on somewhat later, LEP will be competing with SLC for the same physics.

Several components of the MARK II are being replaced or improved, and some new ones are added, to be ready for the higher energy of SLC. These include a central tracking drift chamber of a new design, a set of end-cap shower calorimeters, and a new drift chamber vertex detector. All of these projects involve direct participation of LBL. The end-cap calorimeter, in particular, is entirely an LBL project, and will be described below. The construction of the new central drift chamber, the largest of the upgrade projects, involved design and system-development contributions from LBL. The new drift chamber precision vertex detector is a collaborative LBL and SLAC upgrade project, with mechanical prototype development and construction taking place at LBL. This will also be discussed below. Other upgrade projects for the MARK II not involving LBL directly are the new time-of-flight system, the luminosity and small angle monitors, the trigger chamber (for PEP only), and the potential use of solid state vertex detectors inside the drift chamber vertex

detector. The plan calls for running at PEP for several months before moving to SLC, in order to test and prove the new components in a familiar environment, and this running is now scheduled for Fall 1985. Only the vertex detectors and small angle monitors will *not* be installed at PEP since they are designed for the small SLC beam pipe, and incompatible with that of PEP.

#### End-Cap Calorimeter Construction

The end-cap calorimeter project was nearly completed in 1984, the first calorimeter being finished just before Christmas, and the second following about two months later. The calorimeters use the scheme of gas sampling proportional tubes and lead sheets arranged in 36 layers or planes. Tube layer segments, four per layer, were made by bonding together the individual tubes under heat and pressure in specially made tube layer gluing fixtures. A total of over 18,000 tubes were bonded into the two kinds of segments of 69 or 53 tubes each. Then each tube was fitted with a 0.002 inch diameter central wire, held at tube ends by specially made insulator caps. These segments were all checked for high voltage integrity, and most were also checked for uniformity of gain, a crucial element in obtaining good calorimeter performance. All segments were epoxy bonded (at room temperature) into modules of either 16 or 20 tube layers, each layer sandwiched between lead sheets of 0.111 inches thickness. The tubes were arranged to lie successively along four different coordinate directions: x, y, u, and v. The entire package was contained within a doughnut-shaped gas shell of 116 inch outer diameter and 27 inch inner diameter. The electrical signals for each calorimeter are brought out via 1276 coaxial cables, corresponding to a scheme of ganging together of the 9100 tubes to achieve a "projective" geometry aimed at the beam interaction point at the center of the MARK II. A major development effort was successful in keeping within the required tolerance of about 0.020 inches for straightness of tubes: first in making the layer segments, and then in keeping these segments flat as they were glued into layers. The first end cap completed was sent to SLAC for beam testing, first with high energy positrons, then with pions, while the second end cap is to be mounted directly in the MARK II. Both will be tested in PEP running during Fall 1985. Figure 15 shows a "D" section of one of the calorimeter layers in the jig being glued together. Figure 16 shows one of the 16 layer sections of the calorimeter being wired. Figure 17 shows a completed end cap ready to be transported to SLAC. Figure 18, from beam test data, shows the response of the calorimeter to 10 GeV positrons.



CBB 843-2496

Fig. 15. A "D" section of the end-cap calorimeter in the glueing jig.



XBC 851-99

Fig. 17. A completed end cap ready to be transported to SLAC.

#### Vertex Chamber Development

LBL and SLAC scientists are collaborating in the development of a vertex drift chamber detector for the upgraded MARK II to be installed at SLC. The design goals of the vertex chamber are:

- (i)  $\leq 25 \mu\text{m}$  extrapolated impact parameter error
- (ii)  $\leq 5 \text{ mr}$  double track separation.

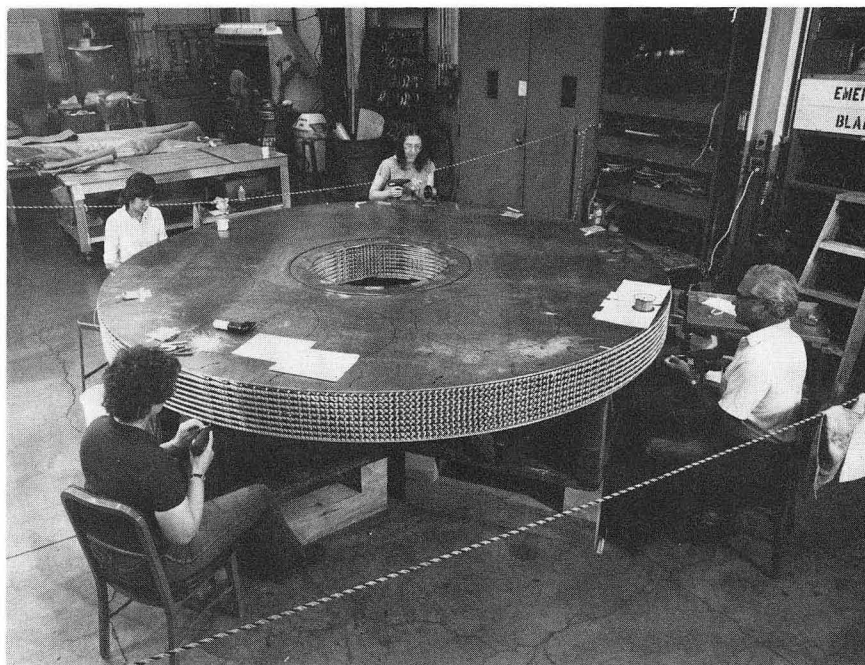

CBB 843-6506

Fig. 16. The 16-layer rear section of an end-cap calorimeter being wired. Groups of several tubes each are electrically ganged together in the same layer and in depth, to form a "projective" geometry.

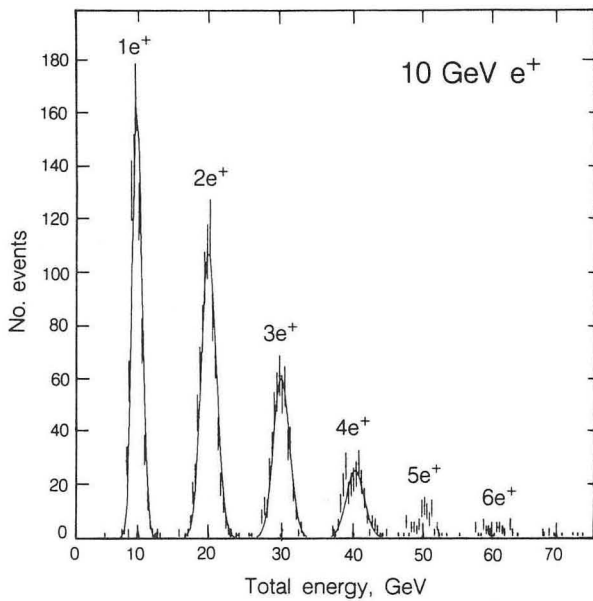

XBL 855-9538

Fig. 18. A pulse-height distribution for an end-cap calorimeter recently tested in a positron beam at SLAC. Peaks correspond to the calorimeter energy response to a distribution of numbers of 10-GeV positrons on different beam pulses. The position of the peaks corresponds to the total deposited energy, and the width to the energy resolution.

The detector will be used both to make high precision measurements of the lifetimes of short-lived particles and to tag interactions in which such particles are produced. The vertex drift chamber is in an R&D phase and will be developed as a component of the MARK II after an evaluation based on both the success of the R&D effort and the status of alternative vertex detectors based on solid-state devices: A decision on which vertex detector or detectors will surround the SLC beam pipe will be made in Summer 1985.

The detailed design of the vertex drift chamber has not been finalized but all designs that are considered involve very accurate wire placement and necessitate high voltage isolation of closely spaced ( $\leq 1$  mm) wires. In 1984 a prototype chamber was built at LBL which pioneered solutions to both of these problems. Planes of .152 mm and .020 mm diameter wire with wire to wire spacings of 750  $\mu\text{m}$  were positioned with 10  $\mu\text{m}$  r.m.s. deviations within the plane of individual wire positions. Kapton circuitry for the high voltage isolation of sense and potential wires was designed and built. The prototype was tested at SLAC and single wire resolutions of 37  $\mu\text{m}$  after 1 cm of drift in 3 atmosphere  $\text{CO}_2$ -isobutane were

achieved. Figure 19 shows a possible design of a sector of the vertex chamber with lines drawn to indicate equipotentials.

There has also been a considerable effort aimed towards the design of the final vertex chamber. Work is in progress to develop methods of accurately locating planes of wires relative to one another and calculations are in progress to determine a field cage configuration for the chamber. The drift fields in the chamber will be defined by wire planes with the wires at appropriate potentials. The design resolution for the chamber requires electric fields in the central region of the chamber to be uniform to 1 part in  $10^3$ .

In the Spring of 1985 a prototype is to be built with the actual cell structure and hope to demonstrate both the expected double track separation and resolution. The effort will then turn towards the design and building of a prototype sector of the actual chamber. The final chamber will be built in 1986 and installed when the MARK II is moved to SLC in the Fall of 1986.

#### Research Staff

G.S. Abrams, D.E. Amidei, A.R. Baden, J.H. Boyer, F.E. Butler, P.S. Drell, G. Gidal, M.S. Gold, G. Goldhaber, L.J. Golding, J.S. Haggerty, D.A. Herrup, I. Juricic, J.A. Kadyk, P.C. Rowson, H.M. Schellman, W.B. Schmidke, P.D. Sheldon, G.H. Trilling, D. Wood.

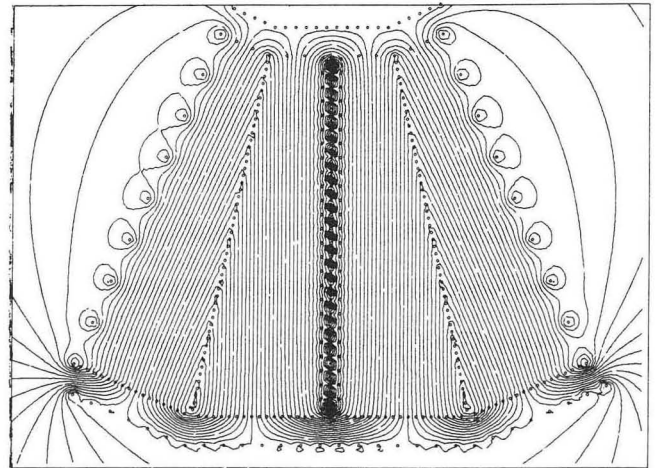

XBL 8512-4917

Fig. 19. The central region shows a possible design of a sector of the vertex chamber. Two adjacent half sectors are represented on either side. The lines drawn are equipotentials.



## Publications

Decays of the  $\Psi$  (3097) to Baryon-Antibaryon Final States, M.W. Eaton, G. Goldhaber, G.S. Abrams, C.A. Blocker, W.C. Carithers, W. Chinowsky, M.W. Coles, S. Cooper, W.E. Dieterle, J.B. Dillon, G. Gidal, A.D. Johnson, J.A. Kadyk, A.J. Lankford, M. Levi, R.E. Millikan, M.E. Nelson, C.Y. Pang, J.F. Patrick, J. Strait, G.H. Trilling, E. Vella, I. Videau, M.S. Alam, A.M. Boyarski, M. Breidenbach, D.L. Burke, J. Dorenbosch, J.M. Dorfan, G.J. Feldman, M.E.B. Franklin, G. Hanson, K.G. Hayes, T. Himel, D.G. Hitlin, R.J. Hollebeek, W.R. Innes, J.A. Jaros, P. Jenni, R.R. Larsen, V. Lüth, M.L. Perl, B. Richter, A. Roussarie, D.L. Scharre, R.H. Schindler, R.F. Schwitters, J.L. Siegrist, H. Taureg, M. Tonutti, R.A. Vidal, J.M. Weiss, and H. Zacccone, *Phys. Rev. D* 29, 804 (1984).

Upper Limit on the  $\nu_r$  Mass, C. Matteuzzi, G.S. Abrams, C. de la Vaissière, D. Amidei, A.R. Baden, A.M. Boyarski, J. Boyer, M. Breidenbach, P. Burchat, F. Butler, D.L. Burke, J.M. Dorfan, G.J. Feldman, G. Gidal, L. Gladney, M.S. Gold, G. Goldhaber, L. Golding, G. Hanson, D. Herrup, R.J. Hollebeek, W.R. Innes, J.A. Jaros, I. Juricic, J.A. Kadyk, A.J. Lankford, R.R. Larsen, B.W. LeClaire, M. Levi, N.S. Lockyer, V. Lüth, M.E. Nelson, R.A. Ong, M.L. Perl, B. Richter, M.C. Ross, P.C. Rowson, T. Schaad, H. Schellman, D. Schlatter, P.D. Sheldon, W.B. Schmidke, G.H. Trilling, D. Wood, J.M. Yelton, and C. Zaiser, *Phys. Rev. Lett.* 52, 1869 (1984).

Measurement of the  $D^0$  Lifetime, J.M. Yelton, L. Gladney, G. Goldhaber, G.S. Abrams, D. Amidei, A.R. Baden, A.M. Boyarski, J. Boyer, M. Breidenbach, P. Burchat, F. Butler, D.L. Burke, J.M. Dorfan, G.J. Feldman, G. Gidal, M.S. Gold, L. Golding, G. Hanson, D. Herrup, R.J. Hollebeek, W.R. Innes, J.A. Jaros, I. Juricic, J.A. Kadyk, A.J. Lankford, R.R. Larsen, B.W. LeClaire, M.E. Levi, N.S. Lockyer, V. Lüth, C. Matteuzzi, M.E. Nelson, R.A. Ong, M.L. Perl, B. Richter, M.C. Ross, P.C. Rowson, T. Schaad, H. Schellman, D. Schlatter, W.B. Schmidke, P.D. Sheldon, G.H. Trilling, C. de la Vaissière, D.R. Wood, and C. Zaiser, *Phys. Rev. Lett.* 52, 2019 (1984).

Pion Pair Production from  $\gamma\gamma$  Collisions at PEP, J.R. Smith, D.L. Burke, A.M. Boyarski, M. Breidenbach, J.M. Dorfan, G.J. Feldman, L. Gladney, G. Hanson, R.J. Hollebeek, W.R. Innes, J.A. Jaros, A.J. Lankford, R.R. Larsen, B. LeClaire, N. Lockyer, V. Lüth, C. Matteuzzi, M.L. Perl, B. Richter, D. Schlatter, J. Weiss, J.M. Yelton, C. Zaiser, G.S. Abrams, D. Amidei, W. Chinowsky, W.E. Dieterle, J.B. Dillon, M.W. Eaton, M.E.B. Franklin, G. Gidal, M.S. Gold, G. Goldhaber, L.J. Golding, A.D. Johnson, J.A. Kadyk, M.E. Nelson, J.F. Patrick, P.C. Rowson, H.M. Schellman, P.D. Sheldon, J. Strait, C. de la Vaissière, C.A. Blocker, M. Levi, T. Schaad, and R.F. Schwitters, *Phys. Rev. D* 30, 5 (1984).

Inclusive Production of Vector Mesons in  $e^+e^-$  Annihilation at 29 GeV, H. Schellman, G.H. Trilling, G.S. Abrams, D. Amidei, A.R. Baden, T. Barklow, A.M. Boyarski, J. Boyer, M. Breidenbach, P. Burchat, D.L. Burke, F. Butler, J.M. Dorfan, G.H. Feldman, G. Gidal, L. Gladney, M.S. Gold, G. Goldhaber, L.J. Golding, J. Haggerty, G. Hanson, K. Hayes, D. Herrup, R.J. Hollebeek, W.R. Innes, J.A. Jaros, I. Juricic, J.A. Kadyk, D. Karlen, A.J. Lankford,

R.R. Larsen, B.W. LeClaire, M.W. Levi, N.S. Lockyer, V. Lüth, C. Matteuzzi, M.E. Nelson, R.A. Ong, M.L. Perl, B. Richter, K. Riles, M.C. Ross, P.C. Rowson, T. Schaad, D. Schlatter, W.B. Schmidke, P.D. Sheldon, C. de la Vaissière, D.R. Wood, J.M. Yelton, and C. Zaiser, submitted to *Phys. Rev. Lett.*, SLAC-PUB-3448, LBL-18391.

$\Lambda$  Production in  $e^+e^-$  Annihilation at 29 GeV, C. de la Vaissière, V. Lüth, G.S. Abrams, D. Amidei, A.R. Baden, T. Barklow, A.M. Boyarski, J. Boyer, M. Breidenbach, P. Burchat, D.L. Burke, F. Butler, J.W. Dillon, J.M. Dorfan, G.J. Feldman, G. Gidal, L. Gladney, M.S. Gold, G. Goldhaber, L. Golding, G. Hanson, J. Haggerty, D. Herrup, T. Himel, R.J. Hollebeek, W.R. Innes, J.A. Jaros, I. Juricic, J.A. Kadyk, S.R. Klein, A.J. Lankford, R.R. Larsen, B.W. LeClaire, M. Levi, N.S. Lockyer, C. Matteuzzi, M.E. Nelson, R.A. Ong, M.L. Perl, B. Richter, M.C. Ross, P.C. Rowson, T. Schaad, H. Schellman, W.B. Schmidke, P.D. Sheldon, G.H. Trilling, J.M. Yelton, D.R. Wood, and C. Zaiser, *Phys. Rev. Lett.* 54, 19 (5/85).

Searches for Unstable Neutral Leptons in Low Multiplicity Events from Electron-Positron Annihilation, M.L. Perl, T. Barklow, A.M. Boyarski, M. Breidenbach, P.R. Burchat, D.L. Burke, J.M. Dorfan, G.J. Feldman, L. Gladney, G. Hanson, K. Hayes, R.J. Hollebeek, W.R. Innes, J.A. Jaros, D. Karlen, A.J. Lankford, R.R. Larsen, B.W. LeClaire, N.S. Lockyer, V. Lüth, C. Matteuzzi, R.A. Ong, B. Richter, K. Riles, M.C. Ross, D. Schlatter, J.M. Yelton, C. Zaiser, G.S. Abrams, D. Amidei, A.R. Baden, J. Boyer, F. Butler, G. Gidal, M.S. Gold, G. Goldhaber, L. Golding, J. Haggerty, D. Herrup, I. Juricic, J.A. Kadyk, M.E. Nelson, P.C. Rowson, H. Schellman, W.B. Schmidke, P.D. Sheldon, C. de la Vaissière, D.R. Wood, M. Levi, and T. Schaad, submitted to *Phys. Rev. D* (LBL-18707, Nov. 1984).

Measurement of  $K^\pm$  and  $K^0$  Inclusive Rates in  $e^+e^-$  Annihilation at 29 GeV, H. Schellman, G.H. Trilling, G.S. Abrams, D. Amidei, A.R. Baden, J. Boyer, F. Butler, J.B. Dillon, G. Gidal, M.S. Gold, G. Goldhaber, L.J. Golding, J. Haggerty, D. Herrup, I. Juricic, J.A. Kadyk, M.E. Nelson, P.C. Rowson, W.B. Schmidke, P.D. Sheldon, C. de la Vaissière, D.R. Wood, T. Barklow, A.M. Boyarski, M. Breidenbach, P. Burchat, D.L. Burke, J.M. Dorfan, G.J. Feldman, L. Gladney, G. Hanson, K. Hayes, T. Himel, R.J. Hollebeek, W.R. Innes, J.A. Jaros, D. Karlen, A.J. Lankford, R.R. Larsen, B.W. LeClaire, N.S. Lockyer, V. Lüth, C. Matteuzzi, R.A. Ong, M.L. Perl, B. Richter, K. Riles, M.C. Ross, D. Schlatter, J.M. Yelton, C. Zaiser, M.E. Levi, and T. Schaad, *Phys. Rev. D Rapid Comm.* 31 (1985) (LBL-18761, Dec. 1984).

## Invited Talks/Conference Proceedings

G.S. Abrams, Mark II Collaboration, Study of the Decay  $\tau^\pm \rightarrow \pi^\pm \pi^\pm \pi^\mp \nu$  at PEP, presented at the Santa Fe APS Meeting, Oct. 31–Nov. 3, 1984.

J.A. Kadyk, A Measurement of the Branching Ratios for  $\tau \rightarrow \rho\nu$  and  $\tau \rightarrow K^*\nu$ , presented at Leipzig Conference, July 19–25, 1984.

J.A. Kadyk, An Upper Limit on the  $\nu_r$  Mass, presented at Leipzig Conference, July 19–25, 1984.

G. Goldhaber, XIXth Rencontre de Moriond on Electroweak Interactions and Unified Theories, summary talk, Feb. 26–Mar. 4, 1984.

G. Goldhaber, The Discovery of Charm, presented at “Wingspread,” Racine, Wisconsin, June 1, 1984.

L.J. Golding, G. Goldhaber, J. Jaros, G.H. Trilling, Mark II Collaboration — LBL, SLAC, Harvard University, Lifetime Measurement of B Mesons by a Vertex Reconstruction Method, presented at the Santa Fe APS Meeting, Oct. 31–Nov. 3, 1984.

## Research at Fermilab

### Hadron Calorimeter for CDF Collaboration

The Collider Detector at Fermilab (CDF) is a large, general purpose detector for studying proton-antiproton collisions at 2 TeV center of mass energy. It is located in the  $B\bar{0}$  interaction hall of the Fermilab Collider. The detector features highly segmented, fine-grained calorimetry (electromagnetic and hadronic) and magnetic analysis for charged particles in the central region.

CDF is being assembled by a large collaboration of U.S. universities, national laboratories (LBL, ANL, FNAL), and groups from Japan and Italy. The collaboration now includes 19 institutions and 180 physicists.

The LBL group of CDF is responsible for the hadron calorimeter in the End Plug region. We have completed the construction of 520 proportional tube chambers to instrument the calorimeter. Figures 20

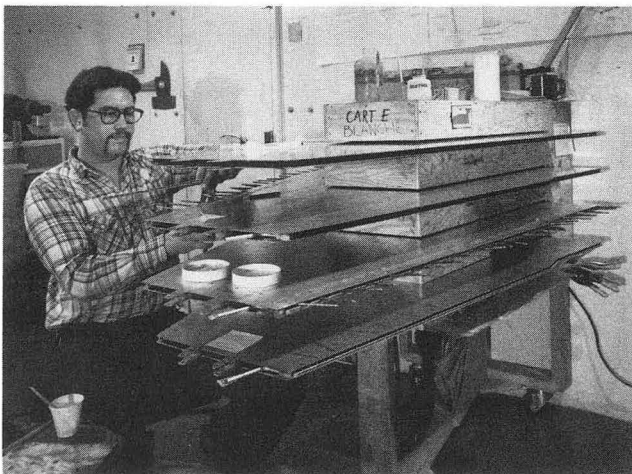

CBB 848-5796

Fig. 20. Some of the 520 proportional tube chambers during construction.

and 21 show some of the proportional tube chambers during construction and testing. Figure 22 shows the iron framework, into which the chambers will be placed, as it lies on the floor prior to installation.

The group's current activity is directed toward an extensive testing and calibration program for the chambers. Each chamber is first tested for gas tightness, high voltage integrity, and electronic readout continuity. Each channel of every chamber is then calibrated by measuring the response to a radioactive source.

A representative set of chambers (approximately 15% of the total) are also calibrated in the MB test beam at Fermilab. We measure the response to electron, pion, and muon beams from 20–200 GeV, with the hadron calorimeter alone and in conjunction with the electromagnetic calorimeter. These data will establish the energy scale for subsequent physics analysis at  $B\bar{0}$  and will also provide a correspondence map for relating the radioactive source response to the test beam data.

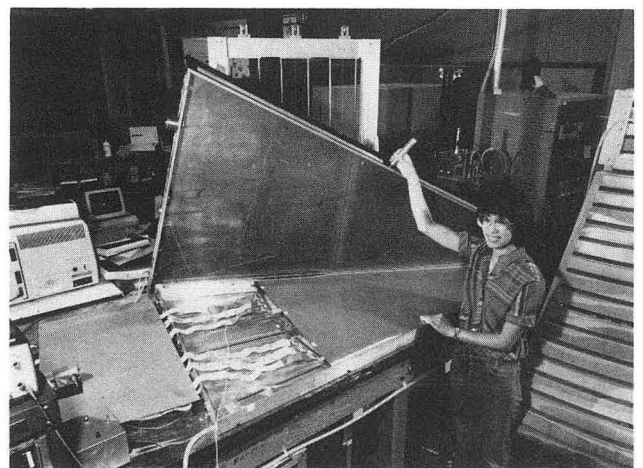

CBB 856-4920

Fig. 21. Some of the 520 proportional tube chambers during testing.

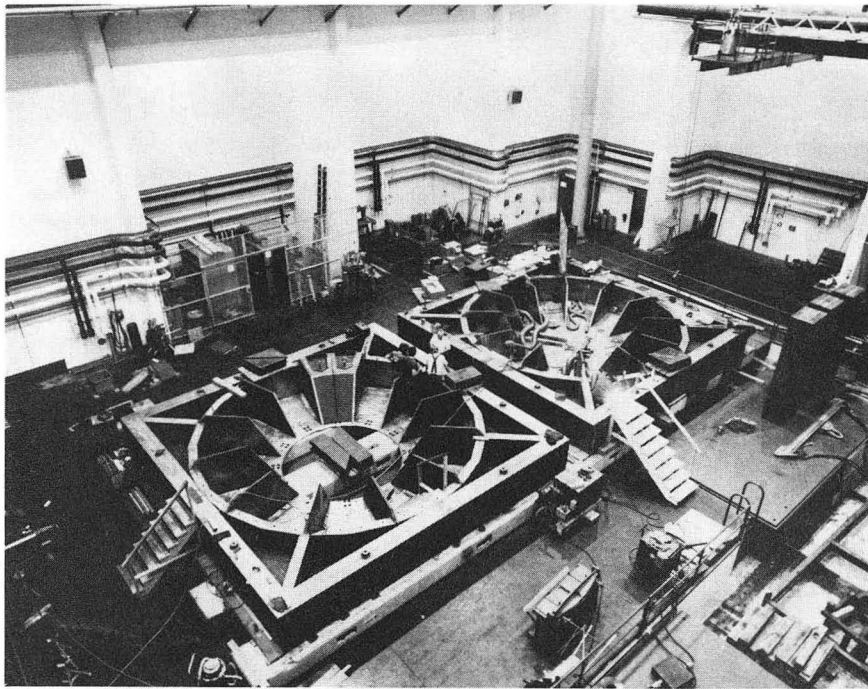

XBB 8511-9904

Fig. 22. The iron framework into which the hadron calorimeter chambers will be placed.

The LBL group of CDF has also undertaken two smaller projects for the collaboration. The first of these is the development of a programmable interface between FASTBUS front-end electronics modules and the CDF Data Acquisition System. We chose a modified version of the SLAC Scanner Processor (SSP) system for this purpose. A preliminary version has been built and tested at LBL and is now operational at Fermilab. We will build and test a total of 20 of these modules for first physics runs.

The second electronics project now underway at LBL is the development of circuitry for the distribution and current monitoring of the high voltage for all the gas calorimeters in CDF. The circuitry is designed to detect over-currents and allow remote disconnection of damaged chambers.

We expect that chamber calibration, testing, and installation in  $B\bar{0}$  will continue through 1985. The central calorimetry and vertex TPC tracking devices will be assembled for a short engineering run in September 1985. The full detector will be assembled for the first physics run in the Fall of 1986.

#### Research Staff

W. Carithers, W. Chinowsky, R. Ely, C. Haber, R. Harris, B. Hubbard, M. Franklin, J. Siegrist.

### **$D\bar{0}$ Experiment at the Fermilab Antiproton-proton Collider**

The Fermilab Collider, TeV I, will provide the opportunity to study antiproton-proton collisions at an energy of 2 TeV and open an enormous range of physics for investigation. To exploit fully the potential of TeV I, a second major detector will be constructed at the  $D\bar{0}$  interaction region intended to complement the first large detector CDF. In addition,  $D\bar{0}$  will be the first major detector designed to take advantage of the experiences of the UA1 and UA2 detectors at the CERN antiproton-proton collider.

The UA1 and UA2 experiences illustrate the importance of calorimetry and lepton identification.

A calorimeter with good energy resolution and with no cracks that permit leakage of unsampled particle energy, is vital for the determination of missing transverse energy. This determination in turn identifies missing neutrinos down to low transverse energy. Many events of interest will contain electrons or muons. To isolate these particles with high efficiency requires a more powerful lepton identifier than in any existing detector. While other detectors are being upgraded to enhance these features, the  $D\emptyset$  detector is being designed to take advantage of the UA1 — UA2 experience in its first phase.

Since June 1984, LBL scientists have been collaborating with physicists from three other laboratories (Fermilab, Brookhaven and Saclay), and from 10 universities, to finalize the detector design. LBL has taken responsibility for the design and construction of some parts of the detector and has helped to formulate plans for other components. A diagram of the  $D\emptyset$  detector is shown in Figure 23.

LBL is designing the micro-vertex chamber, the first detector crossed by particles produced in the event. It is essential for identifying heavy quarks and leptons by lifetime measurement and for rejecting photons converting in the material outside as possi-

ble electron candidates. Studies of Monte Carlo simulated events have emphasized the need to measure many closely spaced tracks in the micro-vertex chamber to achieve high efficiency. Work is continuing on the design of a chamber with very finely spaced wires to satisfy the tracking requirement.

Scientists from LBL will provide overall coordination of the central detector, which in addition to the micro-vertex chamber includes central and end-cap drift chambers and central and end-cap transition radiation detectors. The transition radiation detectors provide enhanced electron identification when used in conjunction with the calorimeter modules, which will be built at Fermilab and Brookhaven. In collaboration workshops LBL physicists have made significant contributions to the conceptual design of these detectors. In particular, work has focussed on the achievement of projective readout without introduction of projective cracks throughout the calorimeter's depth, the avoidance of large dead space in the region between the central and end-cap calorimeters, and provision for easy assembly and repair.

The muon detectors for  $D\emptyset$  will be built at Fermilab. LBL has contributed the early design effort with

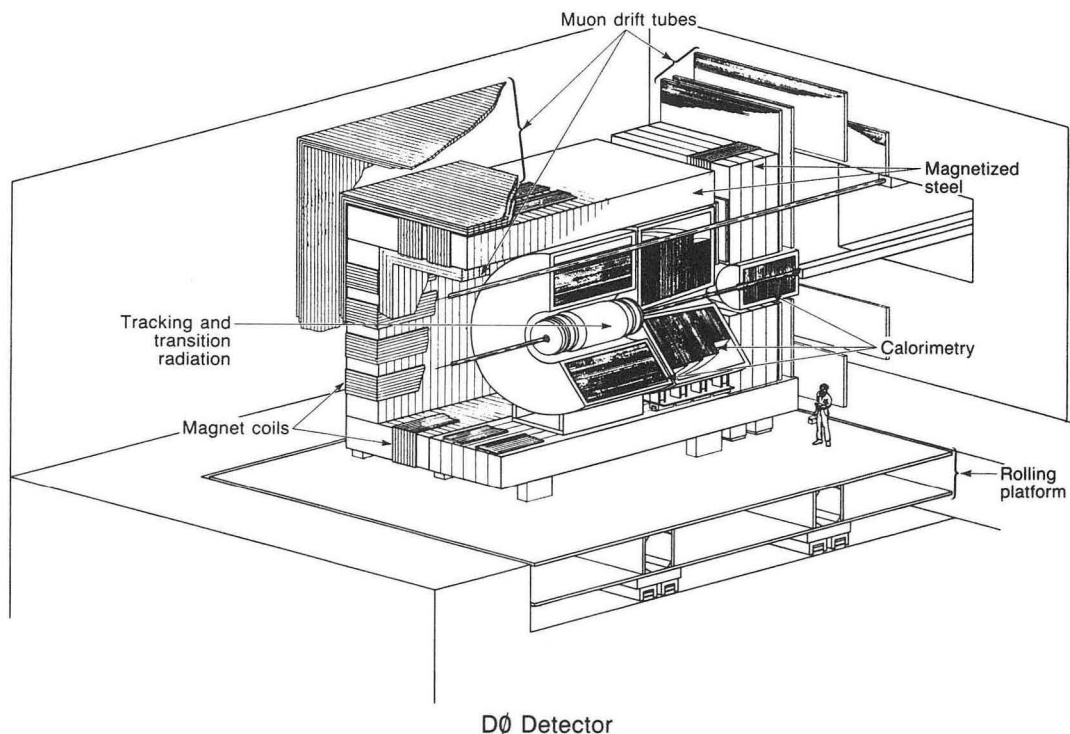

XBL 8501-7002

Fig. 23. Diagram of  $D\emptyset$  detector.



calculations, engineering and mechanical modeling. Since the chambers will be very large and their principles of operation relatively straightforward, the main emphasis has been on cost reduction through simplification of the proportional-tube cell design and fabrication technique.

The trigger system will use powerful micro-VAX computers to isolate events of interest. We have installed a micro-VAX with VAXELN real-time software to develop utilities and services needed to support development of large programs needed for making trigger decisions.

We expect that parts of the central detector will be operational in FY 1987 and that the full detector will be operational in FY 1989.

#### Research Staff

A.R. Clark, F. Goozen, L.T. Kerth, S.C. Loken, M. Strovink, T. Trippe, W.A. Wenzel.

#### Publications

The  $D\bar{0}$  Experiment at the Fermilab Antiproton-Proton Collider, November 1984.

## Neutrino Interactions at Fermilab

### Up-down Asymmetry

In charged-current neutrino neon events (mean energy 100 GeV), fast charged hadrons show an up-down asymmetry with respect to the lepton plane. The asymmetry may be associated with reinteractions in the neon nuclei. For  $z > 0.3$  hadrons the asymmetry is  $-0.054 \pm 0.017$ ; for those events showing evidence for reinteractions the asymmetry is  $-0.111 \pm 0.028$ . For all hadrons the asymmetry is  $0.0010 \pm 0.0048$ .

## Search for Tau Neutrinos

It was expected that there should be far fewer tau neutrinos than muon neutrinos in the Fermilab neutrino beam. A search was made for their interaction in the bubble chamber by looking for the decay of the produced- $\tau$  into three charged pions and a neutrino. No clear events were found. This lack of evidence was used to put an upper limit of 0.053 on the probability that the muon neutrino would oscillate into a tau neutrino.

#### Research Staff

G.R. Lynch, M.L. Stevenson.

#### Publications

Hadron Up-Down Asymmetry in Neutrino-Neon Charged-Current Interactions, H.C. Ballagh, H.H. Bingham, T.J. Lawry, G.R. Lynch, J. Lys, M.L. Stevenson, F.H. Huson, E. Schmidt, W. Smart, M.D. Sokoloff, E. Tredwell, R.J. Cence, F.A. Harris, M.D. Jones, A. Koide, S.I. Parker, M.W. Peters, V.Z. Peterson, H.J. Lubatti, K. Moriyasu, E. Wolin, U. Camerini, W. Fry, D. Gee, M. Gee, R.J. Loveless, and D.D. Reeder, Phys. Rev. D 30, 1130 (1984).

Search for Narrow  $\mu^\mp \pi^\pm$  Mass Enhancement in a Neutrino Bubble-Chamber Experiment, H.C. Ballagh, H.H. Bingham, T.J. Lawry, G.R. Lynch, J. Lys, M.L. Stevenson, F.H. Huson, E. Schmidt, W. Smart, M.D. Sokoloff, E. Tredwell, R.J. Cence, F.A. Harris, M.D. Jones, A. Koide, S.I. Parker, M.W. Peters, V.Z. Peterson, H.J. Lubatti, K. Moriyasu, E. Wolin, U. Camerini, W. Fry, D. Gee, M. Gee, R.J. Loveless, and D.D. Reeder, Phys. Rev. D 29, 1300 (1984).

Search for High-Energy Tau-Neutrino Interactions, H.C. Ballagh, H.H. Bingham, G.R. Lynch, J. Lys, M.L. Stevenson, F.R. Huson, E. Schmidt, W. Smart, E. Tredwell, R.J. Cence, F.A. Harris, M.D. Jones, A. Koide, S.I. Parker, M.W. Peters, V.Z. Peterson, H.J. Lubatti, K. Moriyasu, E. Wolin, and D. Gee, Phys. Rev. D 30, 2271 (1984).

## Experiments at TRIUMF

### Search for Effects of a Right-Handed Gauge Boson

Experiment 185 completed taking data at TRIUMF in 1984 and is in the final stages of analysis. First results from its precise search for right-handed currents in  $\mu^+$  decay were published in Physical

Review Letters in 1983. To these have now been added limits of comparable stringency based on a different technique and data set. These latest results were published in the April 29, 1985 issue of Physical Review Letters.

Both sets of data were taken with a beam of surface  $\mu^+$  incident on pure metal foil targets. Decay posi-

trons emitted near the beam direction were momentum-analyzed to 0.2% accuracy using a focusing dipole spectrometer. In the new measurements, the spin of the stopped muon was processed by ambient 70- or 100-G transverse fields, creating a sinusoidal time dependence in the forward decay rate. This modulation is maximal for decays mediated by a purely left-handed weak boson  $W_L$ , but would be reduced if a right-handed weak boson  $W_R$ , of the type predicted in "left-right-symmetric" models of the electroweak interaction, were also exchanged. After factoring out the  $\mu^+$  lifetime, the experimentally observed modulation is shown in Fig. 24.

Careful analysis of these data shows consistency with the signal expected without any  $W_R$ . If the two bosons are assumed not to mix, the analysis sets the mass limit  $M(W_R) > 440$  GeV.

Work is nearly complete on final analysis of the full data sample using the experimental technique initially proposed and published. For both experimental techniques the directly measured quantity is  $\xi P_\mu/\rho$ , where  $P_\mu$  is the polarization of a  $\pi^+$  from  $\mu^+$  decay and  $\xi$  and  $\rho$  are muon decay parameters related

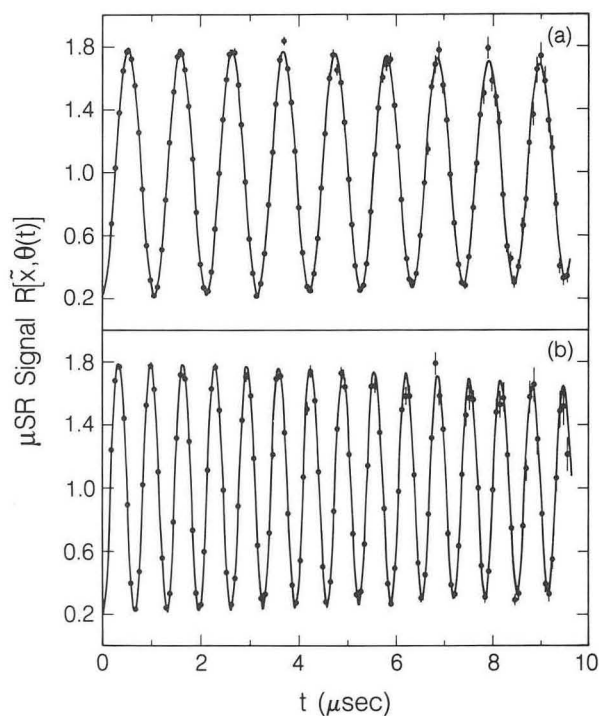

XBL 8412-6004

Fig. 24. Muon spin rotation forward decay rate with (a) 70-G and (b) 100-G transverse fields. The exponential decay with  $\mu^+$  lifetime has been factored out.

to muon polarization and positron energy. Data published up to this point have produced a statistical error of 0.0016 to 0.0018 in this quantity. The corresponding statistical error from the analysis nearing completion is 0.00045.

## Measurement of the Muon Decay Asymmetry Parameter

Experiment 247 finished taking data at TRIUMF in 1984 and is well along in analysis. This experiment built on the techniques developed for Experiment 185 particularly in the area of momentum calibration, in order to measure a much broader range of decay positron momenta. Our preliminary measurement of the muon decay rate modulation (of the type described above) as a function of positron energy is shown in Fig. 25. This led to a preliminary result for the muon decay asymmetry parameter  $\delta$ , communi-

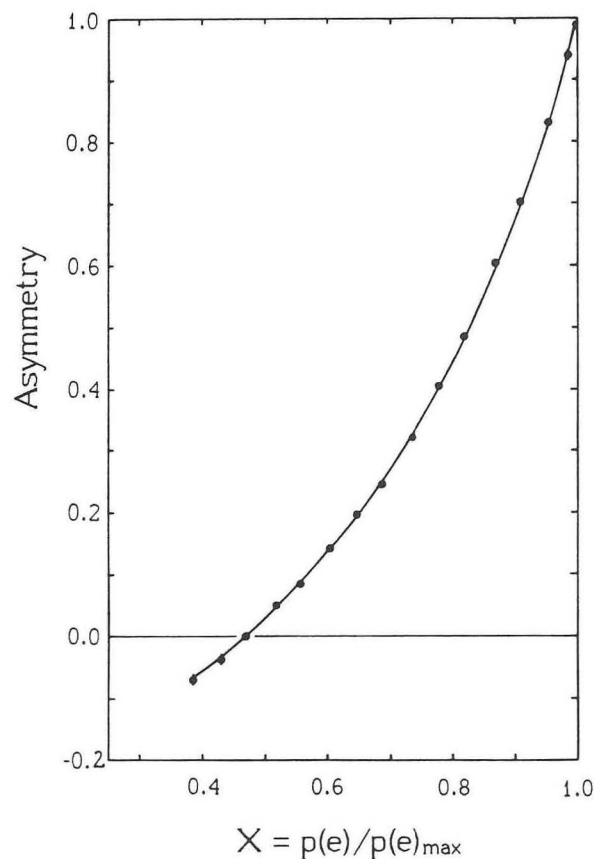

XBL 848-3307

Fig. 25. Muon spin rotation asymmetry used for the preliminary determination of the muon decay parameter  $\delta$ . Where not visible the error bars are smaller than the dots.

cated at conferences in 1984 (LBL-18231 and LBL-18320). We expect the ultimate accuracy in the measurement of  $\delta$  to be approximately 0.003, as proposed.

#### Research Staff

B. Balke, J. Carr, G. Gidal, B. Gobbi (Northwestern Univ.), A. Jodidio, C. Oram (TRIUMF), K. Shinsky,\* H. Steiner, D. Stoker, M. Strovink, R. Tripp.

#### Publications

Precision Measurement of Muon Decay Parameters, R.D. Tripp, in Proc. Nineteenth Rencontre de Moriond, La Plagne-Savoie, France, Feb. 26–Mar. 4, 1984, Vol. I, Phenomenology of Gauge Theories, J. Tran Thanh Van, ed. (Editions Frontieres, Gif-Sur-Yvette, France), pp. 35–45.

Structure of Charged-Current Interactions, M. Strovink, in Proc. XIth Int. Conf. on Neutrino Physics and Astrophysics, Nordkirchen near Dortmund, June 11–16, 1984, K. Kleinknecht and E.A. Paschos, eds. (World Scientific Publishing, Singapore, 1984), pp. 699–729; LBL-18231.

Search for Right-Handed Currents in Muon Decay, B. Balke, J. Carr, G. Gidal, B. Gobbi, A. Jodidio, C.J. Oram, K.A. Shinsky, H.M. Steiner, D.P. Stoker, M. Strovink, and R.D. Tripp, LBL-18320, presented at PANIC, Particles and Nuclei — Tenth Int. Conf., Heidelberg, West Germany, July 30–August 3, 1984.

Search for Right-Handed Currents in Muon Decay, H.M. Steiner, in Proc. XII Int. Conf. on High Energy Physics, Leipzig, E. Germany, July 19–25, 1984, A. Meyer and E. Wieczorek, eds. (Akademie der Wissenschaften der DDR, Zeuthen), Vol. I, p. 208.

Search for Right-Handed Currents by Means of Muon Spin Rotation, D.P. Stoker, B. Balke, J. Carr, G. Gidal, A. Jodidio, K.A. Shinsky, H.M. Steiner, M. Strovink, R.D. Tripp, B. Gobbi, and C.J. Oram, Phys. Rev. Lett. 54, 1887 (1985).

## Superconducting Super Collider (SSC)

### SSC Dipole Designs

The Physics Division is collaborating with the Texas Accelerator Center and other institutions in studying the efficient use of steel for the SSC dipoles. Since all active SSC designs require considerable amounts of steel to contain the magnetic flux we have investigated geometries which minimize superconductor requirements and also provide conservative overall designs with respect to fabrication and performance. One approach with general applicability is to superimpose in a single rectangular aperture the distinctly different but well known dipole current distributions required below 2 Tesla, where the permeability is effectively infinite, and above 2 Tesla where the differential permeability is unity. For any field in the range considered for SSC dipoles (2–6.5 Tesla), this two-current rectangular-aperture approach, as compared with conventional cost designs, will reduce superconductor requirements, field sensitivity to conductor placement errors, stored energy, and forces on insulators. Also, as demonstrated by the early TAC models, the rectangular geometry is especially well suited to simple fabrication procedures.

\*Deceased.

#### Research Staff

W.A. Wenzel

### Experiments at the SSC

Scientists from the Physics Division have been active in a series of meetings to plan experiments at the SSC and to study physics considerations that would affect the design of the Collider. This effort has included work as part of the PSSC (Physics at the Superconducting Super Collider), attendance at many workshops, and participation in the DPF Meeting at Snowmass.

The PSSC was a national effort, meeting at locations around the United States to discuss issues related to Physics at the SSC. Task forces worked on the following issues:

1. General  $4\pi$  detectors
2. Special purpose detectors
3. Interaction regions
4. Detector development
5. Fixed target physics at the SSC
6. ep physics at the SSC
7. Theoretical physics and experimental signatures

These groups concluded these discussions in the Spring of 1984 and prepared written reports which were distributed widely and formed the basis for work done later at Snowmass.

LBL physicists participated in, and helped to organize other workshops and meetings to study accelerator and detector issues. These meetings included a Workshop on Fixed Target Physics, a Workshop on Antiproton-proton Colliders and a Workshop on Accelerator Physics.

A three-week meeting at Snowmass, Colorado provided an opportunity for more extensive discussion and planning. LBL physicists contributed to detector design and to accelerator physics, as well as to theoretical physics. Members of the Physics Division helped to organize this meeting and to lead many of the working groups.

## Research Staff

S.C. Loken

## SSC Publications

- I. Proceedings of the SSC Fixed Target Workshop, The Woodlands, Texas, January 26–30, 1984.

Extraction Modes from the Superconducting Supercollider, A. Bodek, D. Cossairt, R. Huson, E. Keil, W. Wenzel, and M. Zisman, p. 14.

Secondary Beams from Internal Targets, W.A. Wenzel, p. 15.

Structure Functions at Very High Momentum Transfer, Stewart C. Loken, p. 29.

- II.  $\overline{P}\overline{P}$  Options for the Supercollider — Proceedings of DPF Workshop sponsored by ANL and the University of Chicago, February 13–17, 1984.

New Particles and Interactions Working Group, R. Barnett, D. Burke, E. Eichten, B. Gavela, F. Gilman, P. Grannis, H. Haber, G. Kane, K. Lane, L. Littenberg, R. Loveless, S. Meshkov, S. Mikamo, M. Mishina, K. Nishikawa, F. Paige, S. Parker, J. Pilcher, S. Pinsky, C. Quigg, D. Reeder, J. Rosner, X. Tata, W. Wenzel, A. Wicklund, F. Wilczek, and B. Winstein, p. 233.

$B^0\text{-}\overline{B}^0$  Oscillations at the SSC, D. Loveless, K. Nishikawa, F. Paige, D. Reeder, W. Wenzel, and B. Winstein, p. 294.

- III. Physics at the Superconducting Super Collider, Summary Report, June, 1984.

Report of the Fixed/Internal Target Group, S.C. Loken, p. 57.

- IV. Proceedings of the 1984 Summer Study on the Design and Utilization of the Superconducting Super Collider, June 23–July 13, 1984, Snowmass, Colorado.

PP Interaction Regions, R. Diebold, D.E. Johnson, M. Allen, K. Brown, J. Claus, J. Cooper, J. Dugan, A. Garren, L. Jones, L. Lederman, C. Moore, C.T. Murphy, J. Orear, J. Peoples, R. Siemann, D. Stork, Y. Suzuki, and W. Wenzel, p. 399.

Fixed-Target Option for the SSC, E. Colton, S. Childress, G. Dugan, D. Gustafson, T. Kirk, L. Lederman, S. Loken, J. Marriner, J. Morfin, D. Neuffer, W. Scandale, R. Shafer, D. Stork, C.R. Sun, T.E. Toohig, W.A. Wenzel, R.R. Wilson, and S. Wojcicki, p. 457.

Measuring Structure Functions at SSC Energies, J.G. Morfin, J.F. Owens, J.C. Collins, S. Loken, Wu-Ki Tung, and G.S. Tzanakos, p. 243.

A Fixed Target Facility at the SSC, S. Loken, J.G. Morfin, S. Childress, G. Gollin, R. Heinz, L. Jones, J. Ritchie, D. Stork, C.R. Sun, and W. Walker, p. 663.

Computing Requirements at the SSC, A. Firestone, J. Ballam, E. Fernandez, V. Hagopian, D. Imrie, S. Loken, D. Meyer, R. Mount, J. Niederer, D. Pellet, R. Shafer, G. Tzanakos, and G. VanDalen, p. 691.

Standard Electroweak Interactions and Higgs Bosons, B. Cox, F.J. Gilman, G. Abrams, F. Bulos, J. Gunion, H. Iwasaki, B. Kayser, K. Lane, M. Machacek, S. Matsuda, R. Partridge, L. Pondrom, and M. Soldate, p. 87.

Search for  $H^0 \rightarrow t\overline{t}$ :  $t$  Quark Jet Identification Problems, G.S. Abrams and B. Cox, p. 94.

Electron Identification, M. Gilchriese, R. Imlay, G. Abrams, G.A. Alverson, J. Carr, J.W. Cooper, A. Kanofsky, J. Marriner, S. Mikamo, R.J. Morrison, Y. Suzuki, and G.B. Yodh, p. 523.

Report of Working Group on CP Violation and Rare Decays, M.E. Machacek, G.H. Trilling, J.W. Cronin, N.G. Deshpande, G.L. Kane, V.C. Luth, A.C. Odian, F. Paige, M.P. Schmidt, J. Slaughter, M. Witherell, and S.G. Wojcicki, p. 161.

Charged Particle Tracking and Vertex Detection Group Summary Report, G. Hanson, D. Meyer, D. Binnie, D. Brick, J. Cronin, M.G.D. Gilchriese, N. Giotaris, L. Gladney, T. Kondo, A. Odian, D. Potter, R. Ruchti, R. Shafer, G. Theodosiou, G. Trilling, and H. Williams, p. 585.

Tracking Efficiency in SSC Tracking Detectors, G. Trilling, p. 621.

SSC Magnetic Field Quality Considerations, H.E. Fish, K. Asano, B. Brown, W. Gilbert, W. Hassenzahl, R. Louttit, P. Martin, T. Murphy, R. Perin, S. Pissanetsky, Y. Sato, Y. Tanaka, C. Taylor, P. Wanderer, W. Wenzel, E. Willen, and R. Wolgast, p. 329.

2 Tesla Ring Magnets for SSC, W.A. Wenzel, p. 345.



# Double Beta Decay

## Neutrinoless Double Beta Decay of Molybdenum 100

We have studied the performance of our prototype detector array and have concluded that the proposed double beta decay experiment is feasible. It can advance the limit on half life for this decay by nearly an order of magnitude equivalent past the ultimate level we estimate for efforts using germanium.

Silicon detector problems have been essentially solved, it now being possible to make 1.5mm thick Li drifted detectors of 3" diameter having very thin windows on both sides. The high purity detector problems, mostly different in nature from Li drifted problems, are also essentially solved, there now being a commercial source of these devices in England. The detector array we require is, therefore, available with reasonable delivery times for the devices and for costs of approximately \$500 per channel at the present time. Costs have been steadily declining with time and it is hoped that the full array can be realized, including cheaper and better electronics, with less than the presently indicated \$500 per channel.

A proposal has been completed for the funding request we expect to make in the near future. It presents results of our proof test for the experiment and a plan for the future, including budget forecasts. We have an operational low background counting facility in which we test all materials used in detector arrays for this effort. It is based upon an ultra quiet Ge detector from Ortec, provided by our Mt. Holyoke collaborators. Our new computer, a PDP 11/73, has passed its tests and will be operational shortly. It has been provided by our collaborators from the University of New Mexico. The experiment must be done in a deep mine in order to avoid cosmic rays. A suitable site has been located in the Consolidated Silver mine in Idaho.

We consider the project to be a viable one and are now seeking approval by the Division, and if successful, a funding request will be made to DOE.

### Research Staff

M. Alston-Garnjost, M. Deady, B. Dieterle, B. Dougherty, R. Kenney, J. Krivicich, C. Leavitt, R. Muller, H. Nicholson, R. Tripp.

## $^{76}\text{Ge}$ Double Beta Decay

In a collaboration with a UC Santa Barbara group headed by David Caldwell, a germanium detector system has been developed to observe the decay of  $^{76}\text{Ge}$  atoms that constitutes almost 8% of natural germanium. The system design allows for a dense array of eight coaxial germanium detectors each approximately  $160\text{ cm}^3$  in volume (total weight = 7.5 kg) surrounded by 10 six-inch thick sodium iodide scintillation detectors that act as a Compton shield to drastically reduce gamma-ray background. The detector system is enclosed in a lead shield weighing almost ten tons. It is now operating (with four Ge detectors) in the underground generator room of the Oroville Power Dam in Northern California, where an overburden in excess of 700 feet of rock and soil is present.

Extreme precautions have been taken in the design and fabrication of the system to reduce background. All materials employed have been measured in the LBL low-background facility and a number of special fabrication techniques have been employed. For example, the thin-walled vacuum cryostat housing the germanium detectors is fabricated by a copper plating technique. Also silicon cold fingers are used for cooling the germanium detectors, thereby reducing gamma-ray absorbing material between the germanium and sodium iodide detectors to a minimum and enhancing the efficiency of the Compton shield.

The system is designed with the capability to establish a half life limit  $> 10^{24}$  years for the neutrinoless decay of  $^{76}\text{Ge}$  in an experiment of one to two years duration. While the detailed interpretation of this half life in terms of neutrino mass and righthanded current depends on development of more refined theoretical analyses, a half life  $> 10^{24}$  years certainly corresponds to establishing a mass limit of a few electron volts for the Majorana neutrino. The capability of the system to observe the  $0^+$  to  $2^+$  transitions ( $^{76}\text{Ge} \rightarrow ^{76}\text{Se}$ ) as well as the  $0^+$  to  $0^+$  transition may also permit separation of the neutrino mass and righthanded current contributions if the neutrinoless double beta decay process is observed.

Following above-ground system testing, counting has recently (February 1985) started underground using four of the germanium detectors. While the background values are presently higher than expected

(possibly due to beta emitters produced by cosmic-ray neutron activation prior to moving underground) they are equal to or better than any existing deep-underground system. Since the amount of germanium exceeds that of competitive experiments by a substantial factor, we expect to establish new half life limits in one to two months of the experiment. The limit currently established by the system in a short ( $\sim$  two weeks) experiment is approximately  $6 \times 10^{23}$  years.

In parallel with acquiring further data several methods are being worked on to achieve a better understanding of the background and to improve it. Two additional germanium detectors will be installed by mid-1985 and the complete set of eight detectors will be in operation by December 1985.

## Research Staff

F. Goulding, C. Cork, D. Landis, P. Luke, N. Madden, R. Pehl, A. Smith.

## Publications

Semiconductor Detectors and Double Beta Decay, F. Goulding, D. Landis, P. Luke, N. Madden, D. Malone, R. Pehl, and A. Smith, IEEE Trans. Nucl. Sci., NS-31, No. 1 (1984), LBL-16682.

The LBL/UCSB  $^{76}\text{Ge}$  Double Beta Decay Experiment: First Results, F. Goulding, C. Cork, D. Landis, P. Luke, N. Madden, D. Malone, R. Pehl, A. Smith, D. Caldwell, R. Eisberg, D. Grumm, D. Hale, and M. Witherell, IEEE Trans. Nucl. Sci., NS-32, No. 1 (1985), LBL-18043.

Limit on Lepton Nonconservation and Neutrino Mass from Double Beta Decay, D. Caldwell, R. Eisberg, D. Grumm, D. Hale, M. Withereli, F. Goulding, D. Landis, N. Madden, D. Malone, R. Pehl, and A. Smith, Phys. Rev. Lett., 54, No. 4 (1985).

# Berkeley Particle Data Center

The Berkeley Particle Data Center provides physicists with the latest compiled data on elementary particles and their interactions, as well as information on current experiments and detectors. The Center, usually referred to as the Particle Data Group (PDG), works in collaboration with a large number of institutions including the European Laboratory for Particle Physics (CERN), the University of Durham (England), the University of Helsinki, the Institute for High Energy Physics (Serpuukhov, USSR), and the Stanford Linear Accelerator Center (SLAC).

1984 was a productive year for the PDG. The group's main project, "The Review of Particle Properties," extensive revision and improvement. The resulting 1984 edition received praise throughout the physics community and was even the subject of a full-page editorial in *Nature* (May 24, 1984) which referred to the Review as "a model of how data should be compiled in a fast-moving field." In preparation for the next edition of the Review, a proposal to standardize the names of hadrons was developed and presented to the high energy physics community. Major progress brought the PDG's SLAC-SPIRES interactive computer system of high energy physics databases close to completion in preparation for public announcement in the spring of 1985. In addition, the PDG's ongoing compilations, to be described below, were updated as planned.

With the continued strong support of the LBL Physics Division, the PDG physics staff was restored to full strength through the addition of Michael Barnett, a well-known theorist whose research is in supersymmetry, new particle production at the SSC, Higgs bosons, and QCD. A computer scientist, Gary Wagman, was hired to replace Barbara Levine and will lead the modernization of the "Review of Particle Properties" system.

Robert Cahn retired from the PDG Steering Committee after making major contributions to modernizing the contents of the "Review of Particle Properties," and was replaced by Robert Tripp, who joins George Gidal as the current non-PDG, Senior Staff members of the committee. Their support is invaluable and especially important in the present financial climate.

## Activities

The PDG engages in five major activities:

1. Compilation of particle properties, and the biennial publication of the "Review of Particle Properties," with the associated Data Booklet and Pocket Diary.
2. Compilation of information on experiments, including physics information such as beam and target particles, momentum, and reaction

or particle studied. Annual publication of "Current Experiments in Elementary Particle Physics" (LBL-91) and "Major Detectors in Elementary Particle Physics" (LBL-91 Supplement).

3. Compilation of physics information similar to that described in (2) above for published articles and preprints which are sources of new data. Publication of the "Guide to Published or Preprinted Data in Elementary Particle Physics" (LBL-90).
4. Distribution of the latest compiled information described above via the SLAC-SPIRES system, an interactive computer database management system.
5. Participation in various research projects in collaboration with LBL and other research groups.

## Accomplishments

During 1984, the PDG accomplished the following significant tasks:

1. The 1984 edition of the "Review of Particle Properties" was published and distributed. A major modernization of the Review's contents was achieved by eliminating or condensing many older sections to make way for new material of current interest such as Young diagrams, tests of conservation laws, the standard model of electroweak interactions, Kobayashi-Maskawa mixing, the QCD coupling constant, etc. The particle properties compilation and summary tables were completely updated to include current activity such as studies of weak gauge bosons, heavy quark states, lepton and baryon conservation, and searches for hypothetical states. The appearance and usefulness of the Review were improved by phototypesetting it and by adding an index.
2. A proposal for the systematic naming of hadrons was developed. It was presented to the high energy physics community at the Santa Fe APS-DPF 1984 meeting to obtain their feedback in preparation for the 1986 edition of the Review. Figure 26 shows the "alphabet soup" of meson names.
3. The Particle Properties Data Booklet, Diary, and Address-Phone List were produced and distributed.

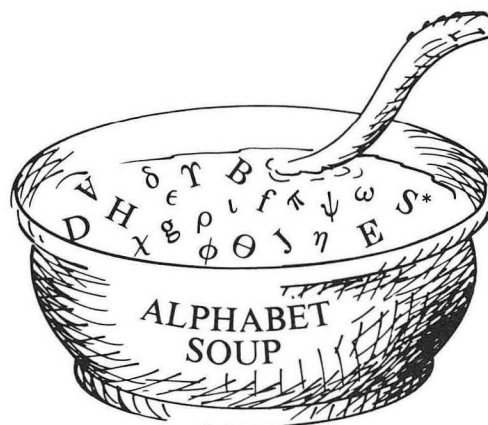

XBL 8512-4918

Fig. 26. The need for a rational particle naming scheme is illustrated by this "alphabet soup" of meson names. This shows the names of some mesons, only those without strangeness, charm, or beauty. The PDG's "Proposal for the Systematic Naming of Mesons and Baryons" addresses this need.

4. The SLAC-SPIRES database of particle properties, called PARTICLES, was expanded to include meson and baryon resonances. This database will be updated between regular editions of the Review, allowing interactive access to the most recent data. A fiche listing of the updated database will be mailed to the 1000 people who have requested it.
5. Design work continues on the modernization of the "Review-of-Particle-Properties" system. By the end of 1985 the basic design will have been completed and implementation of some areas of the design will have taken place.
6. The sixth edition of "Current Experiments in Elementary Particle Physics," was brought nearly to completion and will be distributed in the spring of 1985. The corresponding SLAC/SPIRES EXPERIMENTS database was updated. Three new laboratories were added: ITEP (Moscow), Leningrad, and Saclay.
7. "Major Detectors in Elementary Particle Physics" was augmented with descriptions for the EHS and PEP-9 detectors. Work began on the next edition, which will be published early in 1985 and will include proposed LEP, Tristan, Tevatron and SLC detectors as well as existing detectors.

8. The DOCUMENT database (LBL-90 project) has been converted to the SLAC-SPIRES system and is now called DATAGUIDE. It has been linked to the SLAC library's HEP bibliographic database to facilitate searches for documents that report data. The database has reached steady-state operation and will be publicized in the spring of 1985. A new printed version of this database, "Guide to Published or Preprinted Data in Elementary Particle Physics" (LBL-90), will be published by the fall of 1985.
9. The SLAC-SPIRES system of high energy physics databases is nearing completion. In addition to providing the PARTICLES, DATAGUIDE, and EXPERIMENTS databases listed above, we collaborated with the UK-PDG (Durham) in adding the REACTIONS database, which contains data on reactions, to the SLAC-SPIRES system. This database will be updated in the summer of 1985 with new information provided by the Durham UK-PDG and the Serpukhov COMPAS group.
10. Publicity for the PDG's SLAC-SPIRES databases was increased. Demonstrations of these databases were given at LBL, CERN and SIN, the latter two via a satellite network connection.
11. Physicist members of the group and Steering Committee continued their involvement in research. Barnett worked in supersymmetry, new particle production at the SSC, Higgs bosons, and QCD. Trippe began working on the D0 detector for the Fermilab  $p\bar{p}$  collider. Yost has continued his work with the SLAC high resolution photoproduction bubble chamber experiment on charmed particle production and decay, and inclusive reactions. He has begun work on a Fermilab neutrino experiment. Gidal worked on the study of  $e^+e^-$  interactions at PEP using the Mark II detector, on the Mark II upgrade for SLC operation, and on the search for right-handed currents via measurement of the  $\xi$  parameter in  $\mu^+$  decay at TRIUMF. Tripp worked on the search for right-handed currents in  $\mu^+$  decay and on double beta decay.

#### Research Staff

Betty Armstrong, R. Michael Barnett, Barbara Levine, Alan Rittenberg, Thomas G. Trippe, Gary S. Wagman, Charles G. Wohl, George P. Yost.

#### Steering Committee

Robert N. Cahn, George Gidal, Robert D. Tripp, Thomas G. Trippe.

#### Publications and Reports

(Publications and Reports of R.N. Cahn, G. Gidal and R. Tripp are not listed here but are listed with the groups and projects with which they spend most of their time.)

Review of Particle Properties. C.G. Wohl, R.N. Cahn, A. Rittenberg, T.G. Trippe, G.P. Yost, F.C. Porter, M. Aguilar-Benitez, J.J. Hernandez, L. Montanet, R.E. Hendrick, R.L. Crawford, M. Roos, N.A. Törnqvist, G. Höhler, T. Shimada, M.J. Losty, G.P. Gopal, Ch. Walck, R.E. Shrock, R. Frosch, L.D. Roper, W.P. Trower, and B. Armstrong. *Rev. Mod. Phys.* 356, no. 2, pt. II (April 1984).

Current Experiments in Elementary Particle Physics. C.G. Wohl, F.E. Armstrong, A. Rittenberg, T.G. Trippe, G.P. Yost, Y. Oyanagi, D.C. Dodder, S.N. Grudtsin, Yu.G. Ryabov, R. Frosch, A. Olin, F. Lehar, A.A. Vorobiev, and B.P. Barkov. LBL-91 Revised, January 1985.

Major Detectors in Elementary Particle Physics. G. Gidal, B. Armstrong, and A. Rittenberg. LBL-91 Supplement Revised, Spring 1985.

User's Guide to High Energy Physics Computer-Searchable Databases on the SLAC-SPIRES System. A. Rittenberg, F.E. Armstrong, B. Levine, T.G. Trippe, C.G. Wohl, G.P. Yost, M.R. Whalley, L. Addis. LBL-19173, to be published, Spring 1985.

Proposal for the Systematic Naming of Mesons and Baryons. F.C. Porter, J.J. Hernandez, L. Montanet, M. Roos, N.A. Törnqvist, R.M. Barnett, R.N. Cahn, G. Gidal, A. Rittenberg, T.G. Trippe, C.G. Wohl, G.P. Yost, M. Aguilar-Benitez, and G.J. Feldman. Proceedings of the 1984 Meeting of the Division of Particles and Fields of the APS, Santa Fe, NM, 31 Oct.-3 Nov. 1984 (LBL-18834).

Application of a Softly Broken Supersymmetric Model to the Properties of the Scalar Neutrino. R.M. Barnett, H.E. Haber and K.S. Lackner. *Phys. Rev. D* 29, 1990 (1984).

Implications of a Light Higgs Scalar. R.M. Barnett, G. Senjanovic, D. Wyler and L. Wolfenstein. *Phys. Lett.* 136B, 191 (1984).

Production of Scalar Leptons in W and Z Boson Decay. R.M. Barnett, H.E. Haber and K.S. Lackner. *Phys. Rev. D* 29, 1381 (1984).

Supersymmetry at the Superconducting Super Collider. R.M. Barnett. Proceedings of the Workshop on  $p\bar{p}$  Options for the Super Collider, Univ. of Chicago, Feb. 13-17, 1984 (NSF-ITP-84-31).

Tracking Down Higgs Scalars with Enhanced Couplings. R.M. Barnett, G. Senjanovic and D. Wyler. *Phys. Rev. D* 30, 1529 (1984).



Detection of Supersymmetric Particles in W Boson Decay. R.M. Barnett and H.E. Haber. Phys. Rev. D (to be published).

Simulating Supersymmetry at the SSC. R.M. Barnett and H.E. Haber. Proceedings of the 1984 Summer Study on Design and Utilization of the Superconducting Super Collider. Snowmass, Colorado, June 23–July 13, 1984 (LBL-18301).

Searching for Supersymmetry at the SSC. S. Dawson, A. Savoy-Navarro, G. Alverson, R.M. Barnett, E. Fernandez, J. Freeman, L. Gladney, H. Haber, S. Lynn, F. Paige and R. Wagner. Proceedings of the 1984 Summer Study on Design and Utilization of the Superconducting Super Collider. Snowmass, Colorado, June 23–July 13, 1984 (LBL-18479).

Implications of a Systematic Study of the CERN Monojets for Supersymmetry. R.M. Barnett, H.E. Haber, G.L. Kane. SLAC-PUB-3551 (January 1985), submitted to Phys. Rev. Letters.

Inclusive Photoproduction of Neutral Strange Particles at 20 GeV. K. Abe, T.C. Bacon, J. Ballam, L. Berny, A.V. Bevan, H.H. Bingham, J.E. Brau, K. Braune, D. Brick, W.M. Bugg, J. Butler, W. Cameron, J.T. Carroll, C.V. Cautis, J.S. Chima, H.O. Cohn, D.C. Colley, G.T. Condo, S. Dado, R. Diamond, P.J. Dornan, R. Erickson, T. Fieguth, R.C. Field, L. Fortney, B. Franek, N. Fujiwara, R. Gearhart, T. Glanzman, J.J. Goldberg, G.P. Gopal, A.T. Goshaw, E.S. Hafen, V. Hagopian, G. Hall, E.R. Hancock, T. Handler, H.J. Hargis, E.L. Hart, P. Haridas, K. Hasegawa, T. Hayashino, D.Q. Huang, R.I. Hulsizer, S. Isaacson, M. Jobes, G.E. Kalmus, D.P. Kelsey, J. Kent, T. Kitagaki, J. Lannutti, A. Levy, P.W. Lucas, M. MacDermott, W.A. Mann, T. Maruyama, R. Merenyi, R. Milburn, C. Milstene, K.C. Moffeit, J.J. Murray, A. Napier, S. Noguchi, F. Ochiai, S. O'Neale, A.P.T. Palounek, I.A. Pless, M. Rabin, P. Rankin, W.J. Robertson, A.H. Rogers, E. Ronat, H. Rudnicka, T. Sato, J. Schneps, S.J. Sewell, J. Shank, A.M. Shapiro, C.K. Sinclair, R. Sugahara, A. Suzuki, K. Takahashi, K. Tamai, S. Tanaka, S. Tether, H.B. Wald, W.D. Walker, M. Widgoff, C.G. Wilkins, S. Wolbers, C.A. Woods, Y. Wu, A. Yamaguchi, R.K. Yamamoto, S. Yamashita, G. Yekutieli, Y. Yoshimura, G.P. Yost, and H. Yuta. Phys. Rev. D29, 1877 (1984).

Maximum Likelihood Approach to Lifetime Estimation in the Presence of Large Experimental Errors. G.P. Yost. Nucl. Instr. and Meth. 224, 489 (1984).

Charm Photoproduction Cross Section at 20 GeV. K. Abe, T.C. Bacon, J. Ballam, A.V. Bevan, H.H. Bingham, J.E. Brau, K. Braune, D. Brick, W.M. Bugg, J.M. Butler, W. Cameron, J.T. Carroll, J.S. Chima, H.O. Cohn, D.C. Colley, G.T. Condo, S. Dado, R. Diamond, P.J. Dornan, R. Erickson, R.C. Field, B. Franek, N. Fujiwara, K. Furuno, R. Gearhart, D. Gershonni, T. Glanzman, I.M. Godfrey, J.J. Goldberger, G.P. Gopal, A.T. Goshaw, V. Hago-

pian, G. Hall, E.R. Hancock, T. Handler, H.J. Hargis, E.L. Hart, M.J. Harwin, K. Hasegawa, T. Hayashino, I. Hideta, R.I. Hulsizer, S. Isaacson, M. Jobes, G.E. Kalmus, D.P. Kelsey, J. Kent, T. Kitagaki, J. Lannutti, A. Levy, P.W. Lucas, W.A. Mann, R. Merenyi, R. Milburn, C. Milstene, K.C. Moffeit, J.J. Murray, A. Napier, S. Noguchi, F. Ochiai, Y. Ohtani, S. O'Neale, A.P.T. Palounek, I.A. Pless, P. Rankin, W.J. Robertson, A.H. Rogers, E. Ronat, H. Rudnicka, H. Sagawa, T. Sato, J. Schneps, S.J. Sewell, J. Shank, A.M. Shapiro, R. Sugahara, A. Suzuki, K. Takahashi, K. Tamai, S. Tanaka, S. Tether, D.A. Waide, W.D. Walker, M. Widgoff, C.G. Wilkins, S. Wolbers, C.A. Woods, A. Yamaguchi, R.K. Yamamoto, S. Yamashita, G. Yekutieli, Y. Yoshimura, G.P. Yost and H. Yuta. Phys. Rev. D30, 1 (1984).

Charm Photoproduction at 20 GeV Including Preliminary Lifetime Results with Improved Optical Resolution. K. Abe, R. Armenteros, T.C. Bacon, J. Ballam, H.H. Bingham, J.E. Brau, K. Braune, D. Brick, W.M. Bugg, J.M. Butler, W. Cameron, H.O. Cohn, D.C. Colley, G.T. Condo, P. Dingus, R. Erickson, R.C. Field, B. Franek, R. Gearhart, T. Glanzman, I.M. Godfrey, J.J. Goldberg, G. Hall, E.R. Hancock, H.J. Hargis, E.L. Hart, M.J. Harwin, K. Hasegawa, M. Jobes, T. Kafka, G.E. Kalmus, D.P. Kelsey, T. Kitagaki, W.A. Mann, R. Merenyi, R. Milburn, K.C. Moffeit, J.J. Murray, A. Napier, V.R. O'Dell, P. Rankin, H. Sagawa, J. Schneps, S.J. Sewell, J. Shank, A.M. Shapiro, J. Shimony, K. Tamai, S. Tanaka, D.A. Waide, M. Widgoff, S. Wolbers, C.A. Woods, A. Yamaguchi, G.P. Yost, H. Yuta. Presented at the 22nd International Conference on High Energy Physics, Leipzig (1984).

Search for a Threshold Enhancement in the  $\gamma p \rightarrow$  Charmed Baryon + Charmed Meson Cross Section. K. Abe, T.C. Bacon, H.H. Bingham, J.E. Brau, K. Braune, D. Brick, W.M. Bugg, J.M. Butler, W. Cameron, H.O. Cohn, D.C. Colley, S. Dado, P. Dingus, R. Erickson, R.C. Field, B. Franek, R. Gearhart, T. Glanzman, I.M. Godfrey, G. Hall, E.R. Hancock, H.J. Hargis, E.L. Hart, M.J. Harwin, K. Hasegawa, R.I. Hulsizer, M. Jobes, T. Kafka, G.E. Kalmus, D.P. Kelsey, T. Kitagaki, A. Levy, R. Merenyi, J.J. Murray, V. O'Dell, I.A. Pless, P. Rankin, E. Ronat, H. Sagawa, S.J. Sewell, J. Shank, J. Shimony, K. Tamai, S. Tanaka, D.A. Waide, M. Widgoff, S. Wolbers, C.A. Woods, A. Yamaguchi, R.K. Yamamoto, G.P. Yost, and H. Yuta. Phys. Rev. D30, 3 (1984).

Lectures on Probability and Statistics. G.P. Yost. LBL-16993 (Sept. 1984).

The Review-of-Particle-Properties System. T.G. Trippe. Computer Phys. Comm. 33, 229 (1984).

Compilation of Data on Elementary Particles. T.G. Trippe. Proceedings of the Ninth Intl. CODATA Conf., Jerusalem, June 24–28, 1984 (LBL-18338).

# High Energy Astrophysics and Interdisciplinary Experiments

## Supernovae Detection

The most extreme conditions of energy and density that are currently attained in our universe are probably in the explosions of stars called "supernovae." We have developed a system capable of recording the images of several thousand galaxies on a three-night cycle, with real time analysis that will enable us to detect new supernovae. Supernovae play a fundamental role in many areas of astrophysics. They are the progenitors of black holes, neutron stars, and pulsars; they are probably responsible for nucleosynthesis of all elements heavier than carbon; stars, planets, and interstellar grains are made on supernova shockwaves; cosmic-rays are accelerated on the shockwaves either at the explosion itself, in interstellar space, or in the enormous electric fields at the pulsar. The remnants of SN explosions are strong sources of radio, optical, and x- and gamma-ray radiation.

The most interesting and least understood period of the supernova explosion is the first few days. There have been very few supernovae reported in this period, and there has never been a spectrum obtained this early. Calculations indicate substantial differences in the pre-maximum light curve, depending on the details of the explosion; yet this section of the light curve is where there are practically no data. Our search should detect one supernova every week or so at 10 to 40 percent of maximum light before the peak. For supernova explosions in the nearby Virgo cluster of galaxies, we should see supernovae at a few percent of maximum light. Our search should alert a number of observatories, including Space Telescope (launch date late 1986) to observe the explosion.

We will use an RCA charge-coupled imaging device (CCD) with a 30 inch automated optical telescope and repeatedly scan about 7500 galaxies, cycling through this sample every three days. The image of the galaxy will be compared to the standard (no supernova present) image of the galaxy, and checked for a brightness increase in any one image element. We are using a dedicated PDP 11/44 mini-computer for controlling the CCD and telescope and calculating the brightness differences. When a supernova is discovered, it will be studied in detail with existing ground-based and orbiting satellites to take optical, uv, and gamma-ray spectra.

During the calendar year 1984, the group finished tests of the CCD camera on U.C.'s Leuschner 30-inch

optical telescope. The performance of the CCD, electronics, and optics were good, and no major changes are anticipated in the hardware. We observed regularly during 1984 and started acquiring reference galaxy images to compare with newly acquired galaxy images. We should detect our first supernova in the fall of 1985.

### Research Staff

M.S. Burns, F. Crawford, G. Gibson, J. Kare, R. Muller, C. Pennypacker, R. Smits, R. Williams.

## Nemesis Search

The same hardware used for the supernova search is being used for an automated search for "Nemesis," the hypothesized companion star of the sun. Our search will initially search red stars from the Dearborn Catalog of stars. We expect a 3 second parallax (peak-to-peak) from Nemesis, due to its closeness to the sun, but very low proper motion. With the present CCD camera, we can detect the parallax from Nemesis in about a month.

We are presently planning a photographic search of the southern sky to find Nemesis. We would use an existing Schmidt Telescope and an automated plate measuring machine assembled by Luyten at Minnesota. A modest amount of nights observing should cover the sky to Nemesis' expected ~13th magnitude.

### Research Staff

L. Alvarez, M.S. Burns, F. Crawford, G. Gibson, J. Kare, R. Muller, C. Pennypacker, R. Smits, R. Williams.

### Publications

Automated Supernovae Search. J. Kare, C. Pennypacker, R. Muller, M.S. Burns, F. Crawford, and R. Williams, submitted to *Reviews of Sci. Inst.*

Evidence for a Solar Companion Star, R. Muller, LBL-18271 (August 1984), to be published in the proceedings of IAU Symposium 112 Conference "The Search for Extraterrestrial Intelligence," Boston Mass., June 18-21, 1984.

Terrestrial catastrophism: Nemesis or galaxy, R. Muller, M. Davis, and P. Hut, *Nature* 313, 503 (7 February 1985).

Reply to Weissman, P. Hut, M. Davis, R. Muller, and W. Alvarez, Nature 1985.

Tidal Gravitational Forces: the Infall of "New" Comets and Comet Showers, R. Muller and D.E. Morris, LBL-18942 (January 1985), submitted to Icarus.

Evidence for Nemesis: a Solar Companion Star, R. Muller, presented at the Conference on the Galaxy and the Solar System, to be published.

## Pulsar Observations

We have pursued observations of pulsars and other rapidly varying astrophysical objects. Pulsars are generally believed to consist of a solar mass of matter at nuclear density, and an understanding of their properties is important for both supernova studies and nuclear physics.

We discovered the first extra-galactic optical pulsar in the Large Magellanic, and only the second example of a strong optical pulsar. We have continued studying the pulsar's spectrum, polarization, and rotational slow-down characteristics. All of the foregoing are only the second ever measured for any optical pulsar and will constrain or lead to new models of pulsar emission.

### Research Staff

M.S. Burns, C. Pennypacker.

### Publications

Discovery of Optical Pulsations in the Large Magellanic Cloud Remnant 0540-69.3, J. Middleditch and C. Pennypacker, Nature, V 312.

Optical Spectrum of CMC Pulsar, J. Middleditch, C. Pennypacker, and M. Burns, in preparation.

## The Cyclotron

We have been developing a small (19 cm radius) cyclotron for direct detection for natural radioisotopes such as  $^{14}\text{C}$  and  $^{10}\text{Be}$ . When operational, the entire system should be approximately desk-sized, comparable to the size of apparatus presently used for decay-dating. We accelerate the ions of interest to an energy of only 40 keV, with typically 100 turns and 400 eV energy increase per turn. Because this energy is low, there are no dangers from induced radioactivity. The cyclotron is operated in a high

harmonic, typically 11th to 31st. Background ions such as  $^{13}\text{CH}$  are suppressed by the requirement that during acceleration they stay in phase for the 100 or so turns required to reach the final energy. Low energy scattered ions are suppressed by the use of a specially designed ion detector that incorporates a grazing incidence aluminum oxide conversion dynode, with secondary electrons independently multiplied in different pores of a microchannel plate. In preliminary tests of the system we have shown that background count rates are lower than 1 count per twenty minutes even for nearby ions (such as  $^{13}\text{CH}$ ) which differ in mass from the ion of interest by one part in 1800. In these tests an internal cesium sputter ion source was used, and the maximum beam current obtained was a few picoamperes; this was sufficient to demonstrate that the suppression of background ions was better than  $2 \times 10^{-11}$ , close to that required for natural  $^{14}\text{C}$ , and we hope to report preliminary results with this new system.

### Research Staff

K. Bertsche, P. Friedman, D. Morris, R. Muller.

### Publication

A 40 keV Cyclotron for Radioisotope Dating, R. Muller, J.J. Welch, K.J. Bertsche, P.G. Friedman, D.E. Morris, and P.P. Tans, Nuclear Instruments and Methods in Physics Research B5, 230-232 (1984).

## Cosmic Background Radiation/Primordial Blackbody Radiation

### Angular Distribution/Anisotropy

Experimental observation of the angular anisotropy of the cosmic background radiation is continuing. In April 1982, our liquid-helium-cooled balloon-borne radiometer completed observations of the CBR anisotropy at 3 mm wavelength in the northern sky. The first order, or dipole, anisotropy measured previously at lower frequencies by our group and others is clearly evident in our data; higher order (particularly quadrupole) anisotropies that had been reported in lower frequency observations by other groups were not seen at 3 mm. Our results, published in Phys. Rev. Lett. 50, 8 (November 1983), show no significant higher order anisotropy.



The radiometer was taken to Brazil in November 1983 and flown to make measurements of the southern sky. The equipment, including the onboard data recorder, was unfortunately lost when the flight termination equipment failed. Data were recovered from telemetry and analyzed.

Preliminary results have been reported. The southern hemisphere results are in good agreement with the northern data. A map covering the 85% sky that has been absent, was derived from the data.

In January 1985, we were informed that the gondola had been found and the equipment and data tape were recovered. The tape and some of the equipment were returned to LBL. The tape is still mostly readable. The equipment is in poor shape as a result of exposure and the actions taken during the recovery from the jungle. Additional data analysis is now underway. We have also begun construction of a new and improved system and gondola.

Work continues on experiments to measure the CBR anisotropy from the Cosmic Background Explorer (COBE) Satellite. The COBE project received its official start from NASA in October 1983; development of hardware and data analysis techniques is proceeding at LBL and other locations. Orders for procurement of major subsystems have been placed. The various flight components began arriving in the fall of 1984 and are being tested now. We are also doing studies and feasibility tests for ground-based medium- and small-angular-scale anisotropy experiments.

## Polarization

We have made 9 mm measurements of the polarization of the CBR and begun measurements at 30 mm. At 9 mm and 30 mm we see no linear polarization greater than  $10^{-4}$ . The circular polarization is less than 1%. We are continuing our studies of the CBR polarization at 30 and 9 mm and expect to begin measuring at 3 mm. At 3 and 9 mm the system noise seems to be the limiting factor, so continued observation will improve the measurement and sky survey.

## Spectrum

The group made measurements of the low-frequency spectrum of the CBR on July 4 and 5, 1982, September 6, 7, and 8, 1983 and August 24 and 25, 1984 from the White Mountain High Altitude Research Station in California. The experiment is a collaboration of groups led by Giorgio Sironi

(Milano, Italy), Reno Mandolesi (Bologna, Italy), Bruce Partridge (Haverford College, Pennsylvania), and George Smoot (Astrophysics Group, LBL).

The spectrum was measured at five wavelengths (12, 6.3, 0.9, and 0.3 cm) in the Rayleigh-Jeans region, where, according to many theories, any distortion will be most readily observed. The three short-wavelength radiometers were built at LBL; the other two were provided by the Italian groups. A sixth radiometer, used to measure the atmospheric emission at 3.2 cm, was built by the Haverford group.

Previous measurements in this wavelength region were made more than 12 years ago by several groups using different techniques. This experiment has used new technology not available at that time, including wavelength-scaled, low-sidelobe corrugated antennas. This experiment suffered from fewer systematic errors because it used a single layer liquid-helium-cooled calibrator for all five radiometers, and the calibration was referred to the front end of each radiometer.

As shown in Figure 27, no evidence for a distortion was seen. The temperature of the CBR was found to be consistent with a  $2.73 \pm 0.03$  K blackbody spectrum.

The observed limits on distortions correspond to limits on the parameters:  $\mu$  (chemical potential) and  $y$  (Comptonization factor) of about  $10^{-2}$ . These in turn place limits on the energy release at various

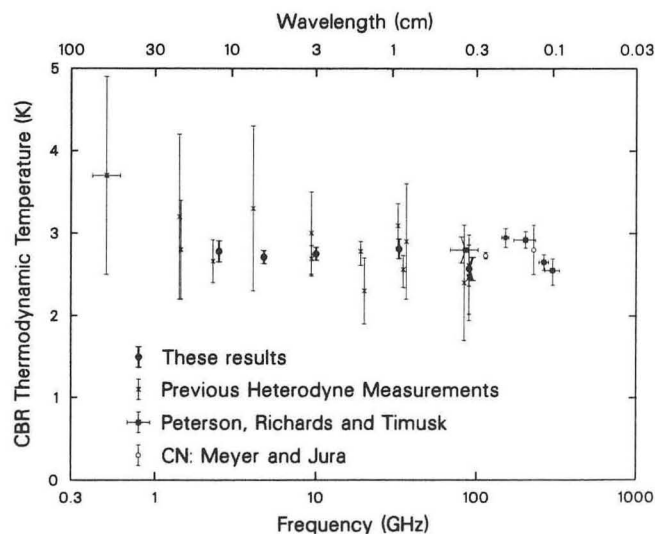

XBL 852-1362

Fig. 27. Previous and present measurements of the thermodynamic temperature of the CBR. All the low frequency data are represented; above 90 GHz only the most recent ones have been plotted.

times in the history of the universe. For example, for redshifts between  $10^3$  and  $10^6$  (times between  $10^5$  and  $10^2$  years after the Big Bang) the energy released is typically limited to less than 1% of the energy in the cosmic background radiation.

We have built a new radiometer that can be continuously tuned in the region 2–15 cm, and will provide better spectral coverage. The group plans to repeat the measurements with improved versions of the same radiometers during the summer of 1985. We have continued collaboration with the Milano group and expect to make measurements at 12 and 50 cm in June 1985 from L'Aquila, Italy.

#### Research Staff

G. De Amici, H. Dougherty, G. Epstein, S. Friedman, J. Gibson, S. Levin, P. Lubin, G. Smoot, T. Villela, C. Witebsky. Students: J. Costales, M. Griffith, B. Grossan, L. Kelley.

#### Publications

Comments and Summary on the Cosmic Background Radiation, G.F. Smoot, Early Evolution of the Universe and Its Present Structure, G.O. Abell and G. Chincarini, eds. 153–158, 1983.

Measurements of the Cosmic Background Radiation Temperature at 3.3 and 9.1 mm, G. De Amici, G. Smoot, C. Witebsky, and S.D. Friedman, Physical Review D 29, 2673, LBL-16180, 1984.

Measurement of the Cosmic Background Radiation Temperature at 6.3 cm, N. Mandolesi, P. Calzolari, and G. Morigi, Physical Review D 29, 2680, 1984.

Measurement of the Cosmic Background Radiation at 12 cm, G. Sironi, P. Inzani, and A. Ferrari, Physical Review D 29, 2686, 1984.

Large Scale Anisotropy in the Cosmic Background Radiation at 3 mm, G. Smoot, T. Villela, G. Epstein, and P. Lubin, Bulletin of the American Astronomical Society, 1984.

A Measurement of the Cosmic Background Radiation Temperature at 3.0 cm, S. Friedman, G. Smoot, G. De Amici, and C. Witebsky, Physical Review D 29, 2677, LBL-16182, 1984.

Automated Measurement of the Temperature of the Atmosphere at 3.2 cm, R.B. Partridge, J. Cannon, R. Foster, C. Johnson, E. Rubinstein, A. Rudolph, L. Danese, and G. De Zotti, Physical Review D 29, 1984.

Observations of the Large Scale Anisotropy in the Cosmic Background Radiation at 3 mm, P.M. Lubin and T. Villela, LBL-18759, 1984.

#### Theses

Measurement of the Large Scale Anisotropy of the Cosmic Background Radiation at 3 mm, G.L. Epstein (Ph.D. Thesis), December 1983, LBL-17118.

A Measurement of the Intensity of the Cosmic Background Radiation at 3.0 cm, S.D. Friedman (Ph.D. Thesis), January 1984, LBL-17279.

Simultaneous Measurements of Atmospheric Emission at 10, 33 and 90 GHz, J.B. Costales (A.B. Thesis), November 1984, LBL-18744.

## Detector Research and Development

### R&D Using the TPC Concept

We have initiated two programs which extend the use of the TPC concept: the first is the development of ultra high pressure TPC's motivated by future proton decay experiments, and the second is the development of tracking imaging Cerenkov counters motivated by the possibility to make a much better measurement of the muon neutrino mass.

The main effort is the testing of a tracking imaging Cerenkov counter in collaboration with New York University and BNL. A prototype counter with three TPC stations inside a 15 atmosphere hydrogen

counter has been built and will be tested at BNL during the Spring cycle. The counter uses the TPC to determine the track directions without interfering with the Cerenkov light. The Cerenkov light is detected with an image intensifier after chromatic correction with an axicon.

In the high pressure work we now have proportional counters operating at the highest pressure anywhere in the world (410 atmospheres). We are investigating the properties of these counters as a function of gas composition and sense wire diameter. The main work during FY 1985 will be further parametric studies of these counters.

Research Staff

L. Baksay (University of Dallas), J. Christenson (New York University), T. Edberg, P. Nemethy (New York University), P. Oddone, J. Sciulli (New York University).

## Scintillating Glass R&D

Developmental work on cerium based scintillating glass has continued. One glass has already been identified as a candidate for the core glass of a scintillating fiber. This glass (designation SC20) has a scintillation efficiency of 8 photons per KeV of deposited energy. Its light output is 6 times greater than that for glasses already in use in HEP detectors. This corresponds to an effective track hit density of between 12 and 25 hits/mm for a singly charged minimum ionizing track. Additional work is being pursued with S.E.S. Consultants in Scotland (this is a collaborative effort between LBL, Notre Dame University and S.E.S. Consultants). The work is aimed at increasing the light output and refractive index of SC20.

Scintillating fibers using SC20 have been fabricated by Collimated Holes Inc. of Campbell, CA.

Samples of heavy glasses (density 4.0g/cc) have been obtained and we are presently investigating their properties. These glasses also use cerium as the scintillating dopant.

We will continue R&D on glass fiber development using the best glass candidate that emerges from our current R&D effort. Optimization of the fiber drawing process and fiber coating techniques will be investigated. Further work on the fiber readout system will continue, using state-of-the-art image intensifiers and CCD readout. Fiber winding techniques will be developed and may lay the ground-work for construction techniques that might be applicable to a scintillating fiber tracking chamber for the SSC.

In addition, R&D on heavy (densities of up to 8g/cc) cerium based scintillating glasses will continue with the hope of developing a glass suitable for electromagnetic calorimetry (and possibly hadronic) that has properties similar to BGO but at one-tenth the cost.

Research Staff

Alan Bross

Publication

Properties of New Scintillation Glasses and Scintillating Fibers, A. Bross, submitted to Nuclear Instruments and Methods.

## Feasibility Studies of a High Resolution Sampling Radial Drift Chamber

The Radial Drift Chamber (RDC) is a novel high resolution vertex detector intended for use with  $e^+e^-$  colliding beam experiments. It consists of three cylindrical shells and two cylindrical, axial wire arrays. The innermost shell is the beam pipe, followed by (moving out in radius) an instrumented layer of wires, a central cathode, an outer layer of wires and an outer pressure wall. With the central cathode held at negative high voltage, ionization formed in the inner half of the chamber will drift to the inner set of wires, and the ionization formed outside the cathode will drift to the outer set of wires.

The reconstruction of tracks with the RDC is based on the concept that every point in the sensitive volume is mapped by the electric field to a corresponding position on the surface of an anode wire. This position on the anode wire can be defined by an angular coordinate  $\alpha$  (Figure 28). An electron cluster from a charged particle will arrive from its point of origin within the sensitive volume at the anode surface at a particular time  $t$  and angle  $\alpha$ . Therefore, knowledge of the electric field configuration and drift velocity, combined with a measurement of  $\alpha(t)$  will permit the reconstruction of the cluster origin. To measure  $\alpha$ , we use a pair of pickup wires placed near the anode. The asymmetry in the induced signals observed on the pickup wires is used to determine  $\alpha$ , and hence track coordinates.

Perhaps the most significant feature of the RDC is the unprecedented capability to exploit efficiently all track ionization (except  $\delta$  rays) for the determination of the particle trajectory. In comparison, conventional 'transverse' drift chambers detect only the first electron of a track segment to arrive at a sense wire. The remainder of the track segment is ignored, although at the moment of creation, each ionization electron within the track segment contains statistically equivalent information. In contrast, the RDC can utilize essentially all of the track information.

We have examined some of these aspects of operation with a planar test chamber and a point source of

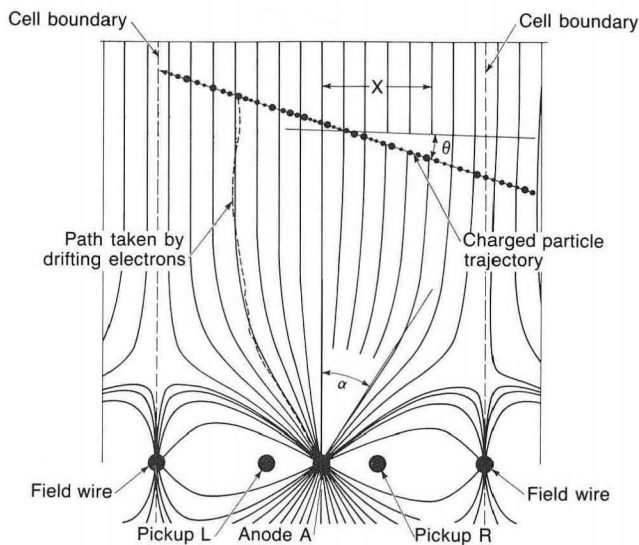

XBL 854-11065

Fig. 28. View of one cell and associated wire triplet, consisting of a pair of pickup wires and one sense wire. Field wires at the cell boundaries are employed to reduce cell-to-cell cross talk, enhance gain, and optimize the electric field configuration. As shown, the pickup wires are at a neutral potential. A cluster of electrons from a charged particle will drift to the anode wire and form an avalanche centered around some azimuthal angle,  $\alpha$ . The maximum angle,  $\alpha_{\max}$ , corresponding to field lines originating near the cell boundary, is determined by the relative potential on the anode and field wires.

thermal electrons which could be positioned accurately at the edge of the drift volume. Figure 29 shows three scans with the electron source located at  $300\mu\text{m}$  intervals, with varying numbers of electrons injected into the drift volume. From these results potential tracking accuracies of  $8\mu\text{m}$  seem possible at atmospheric pressure, with further improvements at modest overpressures.

#### Research Staff

J. Huth, D. Nygren.

#### Publication

Feasibility Tests of a High Resolution Sampling Radial Drift Chamber, J. Huth and D. Nygren, submitted to Nuclear Instruments and Methods, LBL-19462 (May 1985).

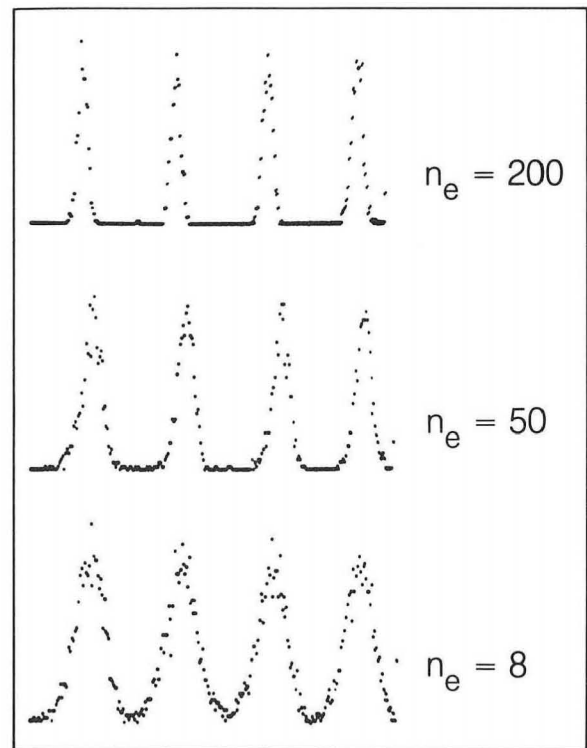

XBL 854-8853

Fig. 29. Results of several scans of the electron source ( $300\mu\text{m}$  intervals) with varying numbers of electrons per discharge. Each peak in the figure corresponds to values of  $(L - R)/A$  taken with the gun in one location. The top scan is with 200 electrons, the middle is with 50 electrons, and the lower scan is with 8 electrons per discharge. The loss of resolution with fewer electrons is evident.

## Gas-Filled and Solid State Detectors

Continuing development work was done on the properties of noble gas mixtures with large concentrations of quenching gas (Self Quenched Streamers) and on investigating the properties of noncrystalline solid state detectors. While the primary application of these detectors is for high energy and nuclear physics, they also find application in Medical Imaging and in x-ray diffractometry.

### Self Quenched Streamers

The avalanche gain, two pulse resolution and position accuracy were measured in various noble gas mixtures with hydrocarbon and carbon dioxide



quenching components. When the quenching gas concentration per unit volume was raised by increasing the gas pressure the two pulse resolution narrowed at 10 Bar to less than 200 nanoseconds for pulses approximately 2mm apart which is much shorter than the corresponding 1 bar situation. Track position accuracy was measured by using 8 KeV photons from the copper K line in a diffraction spectrometer, and found to be less than 80 microns using simple leading edge pulse timing and delay line readout. Improvements in the delay line band pass, and the readout electronics are underway to bring the position accuracy to the 10 micron level.

### Gas Sampling Calorimetry

Sections of a prototype  $40 \times 40 \times 40$  cm drift collection calorimeter using hydrogen reduced resistive lead glass have been assembled at U. of Pisa. The sampling and energy resolution will be studied at CERN and at SLAC.

### Lead Glass Tubing Matrices for Ring Imaging Cerenkov Counters

Lead glass tubing matrices made of tubes with diameter 1–2 mm and made resistive by hydrogen reduction have been studied for use as amplifying and shielding devices in RICH detectors (Figure 30). These lead glass matrices were made for a Positron Camera detector and the wall thickness is larger than necessary for this application. Nevertheless gas amplification gains of approximately 10 and shielding factors for U.V. feedback greater than 95% were achieved.

### Non Crystalline Solid State Detectors

A program to investigate the use of materials capable of being made in large areas such as amorphous silicon and semiconducting plastics for potential use as position sensitive particle detectors was started. Amorphous silicon layers 5–10 microns thick were made and their signal response from alpha particles was measured (Figure 31). In these initial measurements signals of 10 KeV energy deposition were clearly seen. Measurements on non-crystalline switching semiconductors such as TCNQ were also started to investigate their use as memory devices for solving x, y ambiguities in crossed grid array detectors.

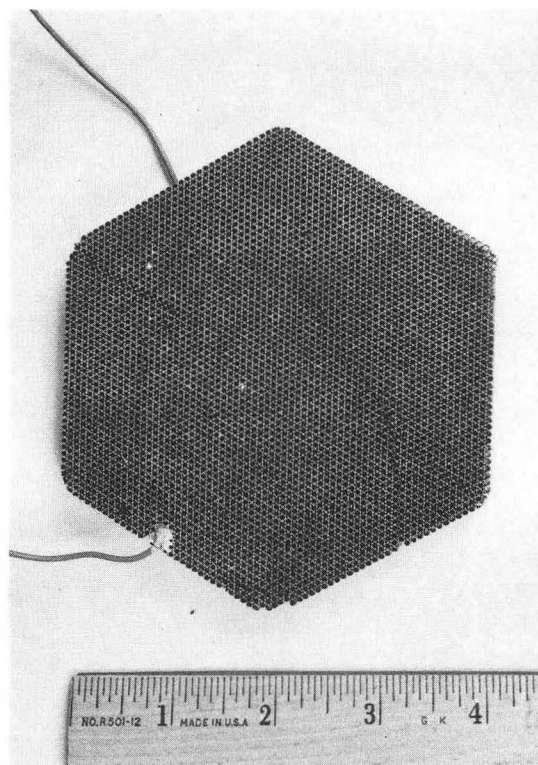

CBB 853-2519

Fig. 30. Lead glass tube matrix. The array is 1 cm thick and the I.D. of the tubes is 1 mm. The blackness of the glass is due to the semiconducting layer of lead produced by the Hydrogen Reduction process.

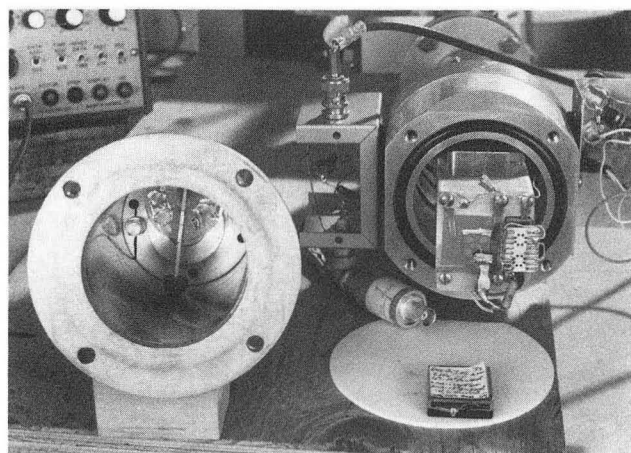

CBB 853-2521

Fig. 31. Amorphous silicon detector mounted in vacuum chamber assembly. The layer is 5 microns thick. A  $^{241}\text{Am}$  source emits 5-MeV alpha particles which produce signals in the detector.

## Research Staff

S. Abachi, G. Barasch, S. Carlsson, J.B. Carroll, I. Fujida, K. Heiskanen, S.N. Kaplan, J. Morel, T. Mulera, V. Perez-Mendez, G. Schnurmacher, S. Trentalange.

## Publications

### a. Radiation Detectors and Applications

Investigation of Dead Times and Dead Zones in Wire Chambers Operated in the Self-Quenching Streamer Mode, K. Lingel, T. Mulera, V. Perez-Mendez, G. Schwartz, LBL-15968 (1983). IEEE Trans. Nucl. Sci. NS-31 (1984) 89-93.

Drift Collection Calorimetry Using a Combined Radiator and Field Shaping Structure of Lead Glass Tubing, T. Mulera, V. Perez-Mendez, H. Hirayama, W.R. Nelson, R. Bellazini, A. del Guerra, M. Massai, G. Spandre, LBL-15967 (1983), and IEEE Trans. Nucl. Sci. NS-31 (1984) 64-68.

A Lead Glass Tubing Drift Calorimeter, T. Mulera, V. Perez-Mendez, H. Hirayama, W. Nelson, R. Bellazini, A. del Guerra, M. Massai, LBL-177556 (May 1984). To be published in LBL Heavy Ion Detector Workshop proceedings.

Large Area Non-Crystalline Semiconductor Particle Detectors, V. Perez-Mendez, T. Mulera, T. Razazan, J. Morel and G. Schnurmacher, LBL-17744 (April 1984). Published in LBL Heavy Ion Detector Workshop proceedings (May 1984).

Reduction of Dead Times and Dead Zones in the Self-Quenching Streamer Mode at High Pressures and High Quencher Concentrations, R.D. Lehmer, T.A. Mulera, V. Perez-Mendez, G. Schnurmacher, LBL-17751 (1984) and IEEE Trans. Nucl. Sci. NS-32 (1985) to be published.

Electron Transmission and Avalanche Gain in Narrow Lead Glass Tubing, I. Fujida, T.A. Mulera, V. Perez-Mendez, A. del Guerra,

V. Ashford, S. Williams, LBL-17752 (1984) and IEEE Trans. Nucl. Sci. NS-32 (1985) to be published.

Monte Carlo Studies for the Design of a Lead Glass Drift Calorimeter, H. Hirayama, W.R. Nelson, A. del Guerra, T. Mulera, V. Perez-Mendez, SLAC Preprint SLAC-PUB-3038 (1983), LBL Preprint, LBL-15966 and Nucl. Instr. and Methods 220, 327 (1984).

A Novel Neutrino Detection System, G.C. Phillips, E.A. Umland, G.S. Mutchler, J.B. Roberts, M. Duong-Van, J.A. Buchanan, J.B. Donahue, J.C. Allred, B.W. Noel, T.A. Mulera, B. Aas, B.W. Mayes, Nucl. Instr. and Methods 221, 334 (1984).

### b. Detector Applications and Medical Imaging

Curved Anode Wire Chambers for X-Ray Diffraction Applications, V. Perez-Mendez, P. Wiedenbeck, C.N. Wagner and E. Woelfel, LBL-16615 to be published Nucl. Instr. and Methods.

Position Sensitive X-Ray Detectors for a Bragg Crystal Spectrometer, B. Sleaford, A.J. Lieber, B. West, (General Atomic Technology) V. Perez-Mendez, to be published Nucl. Instr. and Methods.

Ultra Sound Imaging of Microcalcification Clusters, V. Perez-Mendez, P. Wiedenbeck, P. Davis, C.J. Tzeng, LBL-15939. To be published IEEE Trans. on Medical Imaging.

Detection of Myocardial Infarction in Dogs by Contrast Enhanced Sequential CT Scans, D.A. Feinberg, R. Palmer, V. Perez-Mendez and E. Carlsson. To be published in Acta Radiologica.

Some Aspects of the Construction of HISPET: A High Spatial Resolution Positron Emission Tomograph, R. Bellazini, A. del Guerra, M.M. Massai, W.R. Nelson, V. Perez-Mendez and G. Schwartz, IEEE Trans. Nucl. Sci. NS-31 (1984) 664-649.

Gated Cardiac Scanning Using Limited Angle Image Reconstruction Technique and Information in the Neighboring Phases, K.C. Tam, B. MacDonald and V. Perez-Mendez, LBL-16967, IEEE Trans. Nucl. Sci. NS-31 (1984) 562-565.

## Computation and Communication

The Physics Division maintains computer systems for off-line data analysis, for program development, and for general computation. Smaller systems are used for detector development and testing. A high-speed microwave link between LBL and SLAC is used for data transfer, interactive terminal communication, telephones and TV conferencing.

During 1984, a new VAX 11/780 processor was added to the Physics Computing system. A network of computers called a VAX cluster was established

with the three VAX systems and two shared disks. The configuration is shown in Figure 32. The shared disks are accessible from all computers so that work can proceed in parallel on more than one processor. The cluster provides off-line computing for the TPC data analysis and for other general computation.

The Physics Division computer system was a test site for new hardware and software products that have been announced by Digital Equipment Corporation. Two new VAX processors, each



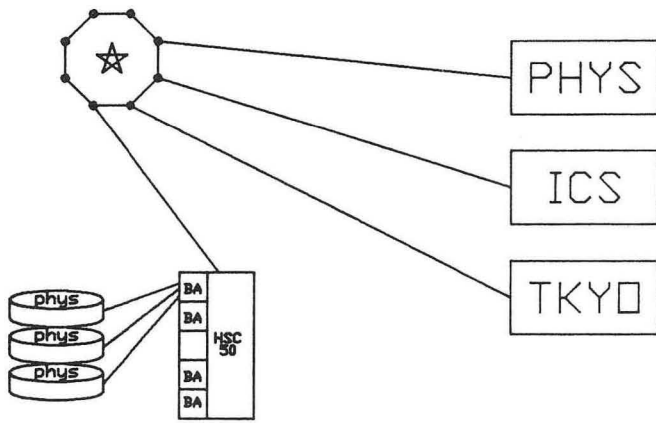

VAX CLUSTER

XBL 8512-4919

Fig. 32. Schematic of cluster.

approximately 50% faster than the VAX 11/780, were tested through the year. A new version of the VAX/VMS operating system and the program library management tools were also extensively tested.

The VAX cluster is linked to other computers at LBL and at other sites by DECNET. The DECNET links are used to move large data files and program libraries as well as for electronic mail. The current network configuration is shown schematically in Figure 33.

Three systems have been installed for detector testing and for the development of new devices. These utilize VAX 11/730 computers with CAMAC interfaces to connect detector electronics. During the year these systems were used for the testing of calorimeter modules for the Mark II, elements of the CDF calorimeter and a prototype tracking Cerenkov detector. One system is used to develop and test

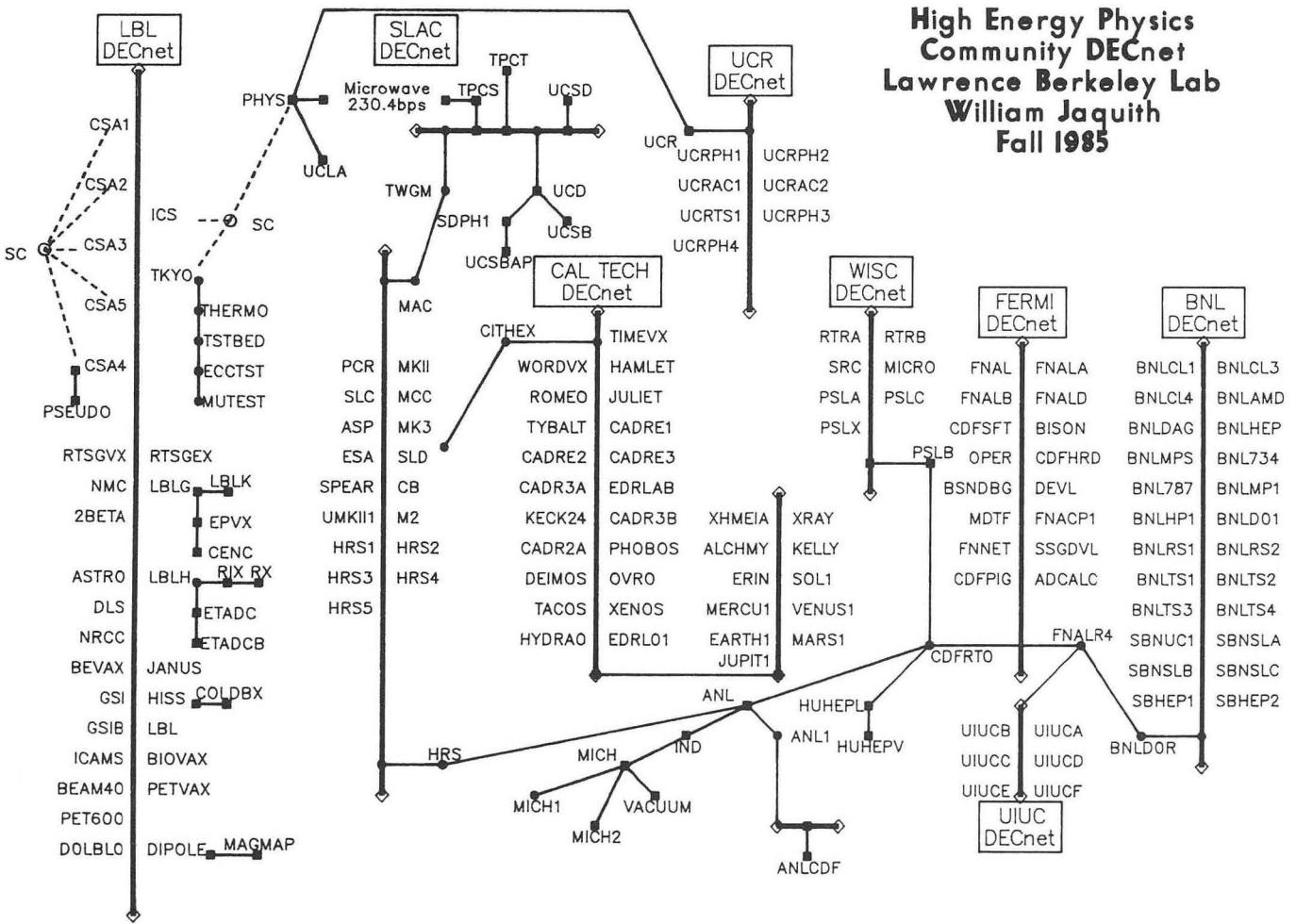

Fig. 33. Network map.

XBL 861-93

FASTBUS modules for use in CDF and other experiments.

The VAX 11/750 system has been returned from TRIUMF where it was used for the muon decay experiment. It is now used by that group for off-line data analysis. The computer is also used to support detector development for the  $D\bar{0}$  experiment. A microVAX computer has been installed and linked to the VAX 11/750 to support program development and testing for the  $D\bar{0}$  data acquisition system.

The microwave communication system supports TV conferencing with three studios at SLAC and three at LBL. Physicists from LBL with research activities at SLAC use these facilities frequently for meetings and for presentations. Additional microwave channels were added in 1984 to provide direct access to computers at SLAC and for telephone communication.

Research Staff

S.C. Loken, E. Whipple

## Instrument Science and Engineering

Continual design and development of advanced instruments, detectors and systems is necessary to best fulfill the requirements of new experiments. Similarly, there is a program of evaluation of commercially available devices and instrumentation. As part of operating the equipment pool we maintain inventory records of all equipment usage, procure new pool equipment and provide consultation on any aspect of instrumentation. Ongoing development, maintenance and other electronics services are provided to the Physics Division.

### Multiwire Proportional Chambers

New chambers and associated electronics are constantly under development. There is continual improvement of system performance within the economic constraints of each experiment.

### MARK II Drift Chamber

Prototypes are completed and we are in final production stages for the electronics of the new End-Cap Calorimeter System. Installation recently began and final check out is expected in late FY 1985. Operation of this large facility will require ongoing repair, maintenance and general electronics support.

### PEP-4 Time Projection Chamber

The TPC Facilities Operation Group does repair, maintenance and general support for the TPC electronics system on a continuing basis. The PEP-4

TPC is a fully operating system. Major changes completed for FY 1985 were:

- Addition of a gated grid to shield sense wires
- Improved linearity of field cage
- Increased magnetic field (superconducting magnet)
- Improved power distribution
- Installation of dehumidifier

Currently in progress and planned for completion in late FY 1985 are improvements in the areas of:

- Fire protection system
- Alarm/interlock system for cryogenics
- Trigger system
- Documentation of recent upgrades

### CDF End Cap Hadron Calorimeter

Development and fabrication of the electronics for these large detector arrays was completed in FY 1984. Installation and checkout are occurring and will extend into FY 1986. Currently under development is a large-scale high voltage distribution system.

### Technical Support and Equipment Pool Facility

Services are provided on a continuing basis in connection with all electronic instrumentation used in Physics Division Programs (whether on or off site). These services include:

- Repair and maintenance of electronic equipment and systems

- Maintaining inventory records
- Arranging temporary loans among research groups
- Procurement of new equipment
- Providing operating manuals
- Consulting on all aspects of instruments and detectors

The base of the equipment pool is enhanced by coordinating it with those serving other LBL Divisions.

## Microcomputer Systems

Several microcomputer systems are used in the check out of various electronic systems and experiments. Single modules as well as entire experimental systems are checked out in this manner. Program/software is developed and procedures implemented as required for new systems.

## Automated Test Facility

Currently under development is an automated test facility utilizing a personal computer for general test and diagnostics of NIM and CAMAC instruments. FASTBUS capability will be included in FY 1986.

## PEP-4 TPC Vertex Detector

Activities in FY 1985:

- Computer simulation of signal processing circuitry
- Investigation of 25MHz CCD storage techniques
- Prototype chamber studies
- Testing of front-end electronics
- Evaluation of fast analog to digital converter systems
- Software development for data handling

## TOPAZ/KEK TPC Sector Development

A prototype sector is currently being tested. Initial tests are quite successful. The field correction at boundaries makes a significant improvement; gain variations and position distortion are virtually eliminated. Further investigations of this chamber are planned through FY 1985.

## CERN Time Projection Chamber

The collaboration of LBL and ALEPH continues in the design of the test pulsing system and the electronics for the gated grid of the CERN TPC. In addition, a small TPC sector is being constructed to confirm design aspects of the ALEPH sector.

## CDF FASTBUS

The first Scanner/Processor was completed and delivered to Fermi Lab for testing at the CDF. More of these complex FASTBUS modules will be built in FY 1985. Evaluation continues on the time to digital converter that is being developed by LeCroy Research Systems.

## Computer Aided Drafting (CAD)

The CAD system recently purchased by the Physics Division is operational. The Physics Division benefits from 2.5 years of software development and experience of the Department of Instrument Science and Engineering with their CAD machines. Training of Physics Division drafting personnel is underway.

## $^{100}\text{Mo}$ Double Beta Decay

Studies in FY 1985 require the fabrication of 24 lithium drifted silicon detectors of large cross section. The detectors (three inches in diameter by 1.5 mm thick) will be fabricated in LBL's Silicon Lab. The requirements of front-end electronics and signal shaping amplifier are currently under investigation. A prototype amplifier system will be developed in late FY 1985.

## Ten Meter Telescope

Design, development and most prototyping of electronics has been accomplished. There is an operating model of the telescope. Much of the mechanical structure is ready or out for fabrication bid. Particular emphasis is being given to the complex interactions of the multiple nested servo control system.

### Research Staff

G.A. Constantian, T.Y. Fujita, G. Gabor, F.S. Goulding, H.G. Jackson, R.C. Jared, F.A. Kirsten, E.J.

Lampo, D.A. Landis, K.L. Lee, P.N. Luke, T.K. McGathen, N.W. Madden, J.E. Millaud, C. Nunnally, S.R. Olson, P. Salz, J.T. Walton

## Publications

Gold-Mask Technique for Fabricating Segmented-Electrode Germanium Detectors, P.N. Luke, IEEE Trans. Nucl. Sci. NS-31, No. 1, 312 (1984).

Semiconductor Detectors and Double Beta Decay, F.S. Goulding, D.A. Landis, P.N. Luke, N.W. Madden, D.F. Malone, R.H. Pehl, and A.R. Smith, IEEE Trans. Nucl. Sci. NS-31, No. 1, 285 (1984). LBL-16682.

A Position-Sensitive Germanium Detector for Gamma-Ray Astronomy, L.S. Varnell, J.C. Ling, W.A. Mahoney, A.S. Jacobson, R.H. Pehl, F.S. Goulding, D.A. Landis, P.N. Luke and N.W. Madden, IEEE Trans. Nucl. Sci. NS-31, No. 1, 300 (1984).

A 50 Microns Granularity Monolithic Ge Target, S.F. Amendolia, F. Bedeschi, E. Bertolucci, D. Bettoni, L. Bosisio, U. Bottigli, C. Bradaschia, M. Dell'Orso, F. Fidecaro, L. Foa', E. Focardi, P. Giannetti, M.A. Giorgi, P.S. Marrocchesi, A. Menzione, G. Raso,

L. Ristori, A. Scribano, A. Stefanini, R. Tenchini, G. Tonelli, G. Triggiani, E.E. Haller, W.L. Hansen, and P.N. Luke, IEEE Trans. Nucl. Sci. NS-31, No. 2, 945 (1984).

Use of Semiconductor Detectors with Synchrotron Radiation, A.C. Thompson, F.S. Goulding, and J.T. Walton, Nucl. Instr. and Methods 222, 230 (1984). LBL-16652

Si(Li) X-Ray Detectors with Amorphous Silicon Passivation, J.T. Walton, R.H. Pehl, Y.K. Wong, and C.P. Cork, IEEE Trans. Nucl. Sci. NS-31, No. 1, 331 (1984). LBL-15908

Silicon Detectors: New Challenges, J.T. Walton, Nucl. Instr. and Methods 226, 1 (1984). LBL-16914

Observation of Signals and Signal Processing from a Silicon Drift Chamber, E. Gatti, P. Rehak, and J.T. Walton, Nucl. Instr. and Methods 226, 129 (1984).

A Standard Digital Data Busing System for Use With NIM Modules, F.A. Kirsten, IEEE Trans. Nucl. Sci. NS-31, No. 1, 175 (1984).

Germanium Detectors with a Built-In Transverse Drift Field, P.N. Luke, N.W. Madden, and F.S. Goulding, IEEE Nuclear Science Symposium, October, 1984.

# **THEORETICAL PHYSICS**

## THEORETICAL PHYSICS STAFF

Alvarez, Orlando  
Bardakci, Korkut  
Binetruy, Pierre  
Cahn, Robert  
Chanowitz, Michael  
Chew, Geoffrey  
Dawson, Sally  
Fidelman, Susan  
Gaillard, Mary K.  
Halpern, Martin

Hinchliffe, Ian  
Jackson, J. David  
Mandelstam, Stanley  
Moura, Betty  
Neumann, Luanne  
Stapp, Henry  
Suzuki, Mahiko  
Windey, Paul  
Zumino, Bruno

## GRADUATE STUDENT RESEARCH ASSISTANTS

Bern, Zvi  
Chan, Hue-Sun  
Cheyette, Oren  
Hwang, Dae-Sung  
Ingermanson, Randall

Issler, Dieter  
Mahajan, Shobhit  
Mañes, Juan  
Smith, Adlai  
Visser, Matt

## ASSOCIATED RESEARCH STAFF

Barnett, Michael  
Claudson, Mark  
Kounnas, Costas  
Marcus, Neil

Sagnotti, Augusto  
Siegel, Warren  
Zwiebach, Barton

## VISITING RESEARCH STAFF

Machet, Bruno  
Maltman, Kim

Natale, Adriano  
Thierry-Mieg, Jean

## OTHER GRADUATE STUDENTS

Carlson, Joseph  
Kao, Yeong-Chuan

Yamron, Jonathan



# THEORETICAL PHYSICS RESEARCH

## Particle Physics

Research in the Theoretical Particle Physics group ranges from highly theoretical work, with little immediate connection to experiment, to work closely related to current experiments and to the construction of new experimental facilities. Most of this research falls into at least one of five somewhat arbitrary categories: (1) Electroweak Interactions, (2) Strong Interaction Phenomenology, (3) Nonperturbative Dynamics, (4) Supersymmetry and Particle Physics, and (5) Cosmology and Particle Physics.

A notable effort is being devoted to theoretical studies in support of the SSC project (Superconducting Super Collider). Group members organized a three week workshop ("Workshop on Electroweak Symmetry Breaking," June 4–22, 1984), supported by the DOE and NSF, to explore the physics of electroweak symmetry breaking at SSC energies. This issue presently provides the clearest scientific motivation for the SSC, and the workshop was intended to help sharpen the requirements for accelerator and detector design. The workshop was scheduled just before the DPF workshop on the SSC at Snowmass, with sufficient overlap in participants that the results could be efficiently communicated to the Snowmass meeting. The proceedings of the LBL theoretical workshop (LBL-18571) will be included in the Snowmass publication.

A second SSC inspired conference organized by group members, "New Phenomena at the SPS Collider: Implications for SSC and Beyond," was held in Berkeley January 18–19, 1985. This conference was attended by nearly two hundred theoretical, experimental, and accelerator physicists. In addition, as the publications list illustrates, group members have made numerous contributions to other SSC related workshops and conferences.

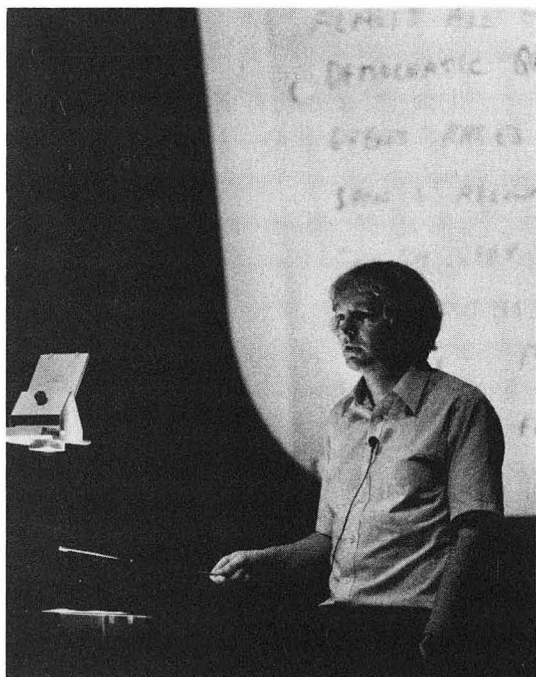

XBB 851-9905

Fig. 34. Ian Hinchliffe in a presentation at Fermilab.

## Electroweak Interactions

The theory of electroweak interactions has been remarkably successful, with one problem remaining: the still unknown mechanism that breaks the electroweak gauge symmetry and gives the W and Z bosons their masses. One possibility, which motivates construction of the SSC, is that this mechanism is due to new strong interaction physics in the TeV energy range, an example being the Higgs mechanism with the Higgs boson mass approaching 1 TeV. A surprising new mechanism has been found (analogous to the Weizsacker-Williams two photon process) to be the dominant Higgs boson production mechanism for Higgs masses above 500 GeV (see papers by Cahn and Dawson). Such ultraheavy Higgs bosons would interact strongly with one another and could give rise to a rich spectrum of strongly bound states (Cahn and Suzuki).

Symmetry breaking by new strong interactions may also be realized by new strong gauge interactions. In this case there may or may not be a recognizable Higgs boson, but the longitudinally polarized W and Z bosons are certain to interact strongly with one another. Provided these strong interactions have

rather general symmetry properties, it is possible to estimate characteristic production rates for multi W and Z events at the SSC (Chanowitz and Gaillard), which imply conservative minimum requirements for SSC energy and luminosity. These studies, and indeed all theoretical studies of new phenomena at the SSC, make essential use of the thorough and comprehensive survey of SSC physics (Hinchliffe and collaborators), which provides the best available estimate of the "known" phenomena as well as exploratory estimates of much of the possible new physics.

In studies of weak interactions at lower energies, work is being pursued to understand production and decay properties of the F mesons, presently observed at PEP, CESR, and PETRA (Suzuki).

## Strong Interaction Phenomenology

Phenomenological studies have been made both of high energy strong interaction cross sections and of the properties of low mass hadrons. Extrapolations constrained by analyticity and unitarity have been made of the pp total and elastic cross sections to SSC energies (papers by Cahn et al.), of interest in themselves and for what they imply about the general physics environment at SSC energies. The hadron spectrum, with emphasis on states containing gluonic constituents, is studied, particularly with respect to what can be learned from two photon collisions at the PEP energy range and from a new, high luminosity  $J/\Psi$  "factory" (Chanowitz). The connection is established between nonrelativistic and perturbative, relativistic treatments of heavy quarkonium radiative decays (Jackson and Rosner).

## Nonperturbative Dynamics

There is a considerable effort to develop methods of analyzing theories in the strong-coupling domain, which cannot be analyzed even qualitatively with ordinary perturbation theory. This includes an effort of long standing to understand the large distance structure of QCD (Quantum Chromodynamics), revived interest in quantized strings which offer hope for a finite, unified theory of all forces, application of powerful topological methods to the analysis of Yang Mills and gravitational field theories, and a non-field-theoretic, S-matrix based approach to particle interactions.

The study of  $SU(N)$  gauge theories as  $N$  becomes very large has been used to develop approximations to QCD (for which  $N=3$ ). This approach has led to a bosonic model of QCD, the Skyrme model, in which

fermions appear as topological solitons: the model has been shown to have the same symmetry properties as the static quark model to leading order in large  $N$ , though the two models do not correspond in the next order (Bardakci).

Motivated by possible application of string theories to the formulation of unified theories which include gravity, a covariant formulation of string quantization has been devised (Siegel). Supersymmetric string theories based on the groups  $E^8 \times E^8$  and  $D^{16}$  are shown to complete the class of finite theories (Thierry-Mieg) found first by Green and Schwartz.

Ward identity anomalies play a unique role in field theory. In some contexts they are a disease to be avoided while in others they yield important physical insights. Gravitational anomalies are particularly intractable, but an elegant and compact treatment is now presented using powerful methods from algebraic topology (Alvarez, Singer, and Zumino). Similar methods have been applied to several examples of charge quantization in Yang Mills and gravitational theories (Alvarez). Apparent discrepancies in calculations of gravitational anomalies have been understood as the result of different choices of currents (Bardeen and Zumino).

The topological S-matrix approach is being pursued vigorously as an alternative to field theories of strong and weak interactions (Chew, Finkelstein, Stapp). The masses of the W and Z bosons are explained as due to "hexons," bosons which are predicted to exist in the TeV mass range.

## Supersymmetry

Supersymmetry is very attractive mathematically and physically. It may be the key to electroweak symmetry breaking and to the unification of gravity with the other forces. The search for evidence of supersymmetry in present experiments or at future facilities like the SSC is being actively pursued (Dawson, Hinchliffe).

An intriguing feature of supersymmetric theories is that they are more convergent than ordinary field theories. Explicit two loop calculations have been done to determine the divergences of extended supersymmetric Yang Mills theories in different numbers of dimensions (Marcus and Sagnotti). The results are not consistent with a conjectured extended superfield formalism and suggest that four dimensional supergravity theories diverge at three loop order.

Supersymmetric theories also have unique dynamical properties. While there are very few examples of quantum mechanical systems for which the ground

state is solved exactly, a large class of supersymmetric quantum mechanical systems has been found with exactly solvable ground states (Claudson and Halpern).

Supersymmetric quantum theory has also been used to give an intuitive derivation of the Atiyah-Singer index theorem, which relates the number of zero modes of the Dirac field to topological properties of the background gauge field (Mañes and Zumino). The proof is now being made mathematically rigorous.

## Cosmology and Particle Physics

Cosmology offers a unique although very indirect probe of the highest energies contemplated in particle physics. Cosmological models and particle physics theories mutually constrain one another. A study of the one loop finite temperature corrections in  $N=1$  supergravity shows that acceptable cosmological evolution requires large breaking of supersymmetry, of order  $10^{10}$  GeV (Binetruy and Gaillard), which then fails to explain the mass scale of electroweak interactions. In another approach, supersymmetry breaking of the order of the electroweak mass scale is achieved by choosing a potential with a very small slope near the origin (Binetruy and Mahajan).

### Publications

Topological Quantization and Cosmology, O. Alvarez, LBL-18658 November 1984.

Gravitational Anomalies and the Family's Index Theorem, O. Alvarez, I. Singer, and B. Zumino, LBL-17672 April 1984.

Fermion Determinants, Chiral Symmetry, and the Wess-Zumino Anomaly, O. Alvarez, Nucl. Phys. B238, 61 (1984), LBL-16355.

Valons in Mesons, F. Amiri, LBL-18221 August 1984.

The Skyrme Model, the Strong Coupling Theory and the Static Quark Model, K. Bardakci, Nucl. Phys. B243, 197 (1984), LBL-16827.

A Path Dependent Hamiltonian in the Large  $N$  Limit, K. Bardakci, Nucl. Phys. B238, 621 (1984), LBL-16215.

Simulating Supersymmetry at the SSC, M. Barnett and H. Haber, a contribution to the Proceedings of the 1984 DPF Summer Study on the Design and Utilization of the SSC, June 23–July 13, 1984, Snowmass, Colorado, LBL-18301.

Stochastic Regularization of Scalar Electrodynamics, Z. Bern, LBL-18377 August 1984.

Models for Inflation with a Low Supersymmetry-Breaking Scale, P. Binetruy and S. Mahajan, LBL-18566 November 1984.

Temperature Corrections in Supersymmetrically Effective Potentials and Inflation, P. Binetruy and M.K. Gaillard, LBL-18072 July 1984.

The Approach of  $p\bar{p}$  and  $p\bar{p}$  Elastic Scattering to "Asymptopia", R. Cahn and M. Block, talk presented at the Santa Fe Meeting of the Division of the APS, Santa Fe, New Mexico, Oct. 31–Nov. 3, 1984, LBL-18796.

Production of Heavy Higgs Bosons: Comparisons of Exact and Approximate Results, R.N. Cahn, LBL-18736 November 1984.

Comment on "Effects of Relative Energy Contributions in a Two-Interaction Transition," R.N. Cahn and J.D. Jackson, LBL-18322 August 1984.

The Approach of  $p\bar{p}$  and  $pp$  Elastic Scattering to "Asymptopia," R.N. Cahn and M. Block, Phys. Lett. 149B, 245 (1984), LBL-18131 July 1984.

High Energy  $p\bar{p}$  and  $pp$  Forward Elastic Scattering and Total Cross Sections, R.N. Cahn and M. Block, to be published in Rev. Mod. Phys., LBL-17522 March 1984.

Review of Particle Properties. Particle Data Group, R.N. Cahn et al., Rev. Mod. Phys. 56 (1984) No. 2 Part 2.

Theoretical Perspective on Elastic and Total Cross Sections at the SSC, R.N. Cahn, Proceedings of the SSC Workshop at the University of Chicago, Feb. 13–17, 1984, LBL-17432 March 1984.

Production of Very Massive Higgs Bosons, R.N. Cahn and S. Dawson, Phys. Lett. 136B, 196 (1984), LBL-16976.

The Higgs-Higgs Bound State, R.N. Cahn and M. Suzuki, Phys. Lett. 134B, 115 (1984), LBL-16743.

Bootstrap Physics: A Conversation with Geoffrey Chew, F. Capra, LBL-18372 August 1984.

Properties of Vibrating Skyrmions, J. Carlson, UCB-PTH-84/26a October 1984.

Approaching the Large  $N$  Limit: A Renormalization Group Approach to Large  $N$  Field Theories, J. Carlson, Nucl. Phys. B248, 536 (1984), UCB-PTH-84/3 April 1984.

Resonances in Photon-Photon Scattering, M. Chanowitz, to be published in the Proceedings of the 6th International Workshop on Photon-Photon Collisions, Lake Tahoe, California, Sept. 10–13, 1984, LBL-18701.

$J/\psi$  Physics at BEPC, M. Chanowitz, to be published in the Proceedings of the First Workshop on Colliding Beam Physics, Beijing, China, June 12–23, 1984, LBL-17930.

- Multiple Production of W and Z as a Signal of New Strong Interactions, M. Chanowitz and M.K. Gaillard, Phys. Lett. 142, 85 (1984), LBL-17496.
- GeV Partons and TeV Hexons from A Topological Viewpoint, G.F. Chew, D. Issler, and B. Nicolescu, Proceedings of the 19th Rencontre de Moriond, 1984, ed. Tran Thanh Van, LBL-18050 April 1984.
- Parity Asymmetry from "Diquarks," G.F. Chew and V. Poenaru, Phys. Rev. D30, 1579 (1984), LBL-15310.
- Production of Single W Bosons in  $e^+e^-$  Collisions, O. Cheyette, Phys. Lett. 137B, 431 (1984), LBL-17083.
- Nicolai Maps and Fermion Sectors, M. Claudson and M. Halpern, LBL-18884 November 1984.
- Nicolai Maps on Manifolds, M. Claudson and M. Halpern, LBL-18558 September 1984.
- Supersymmetric Ground State Wave Functions, M. Claudson and M. Halpern, LBL-18484 April 1984.
- Nicolai Maps for QCD<sub>4</sub>, M. Claudson and M. Halpern, LBL-18355 September 1984.
- Cosmological Baryon Generation at Low Temperatures, M. Claudson, L. Hall, and I. Hinchliffe, Nucl. Phys. B241, 309 (1984), LBL-16796.
- Low-energy Signals of Composite Models: Compositeness Study Group at the SSC Theoretical Workshop, S. Dawson et al., presented at the Workshop Summary of the SSC Theoretical Workshop, Berkeley, California, June 4–22, 1984 and at the DPF 1984 Summer Study for Design and Utilization of the SSC, Snowmass, Colorado, June 23–July 13, 1984, Preprint USC 84/038.
- Searching for Supersymmetry at the SSC, S. Dawson et al., a contribution to the Proceedings of the 1984 DPF Summer Study on the Design and Utilization of the SSC, June 23–July 13, 1984, Snowmass, Colorado, LBL-18479.
- Luminosities for Collisions of Intermediate Bosons and Other Partons, S. Dawson, a contribution to the Proceedings of the 1984 DPF Summer Study on the Design and Utilization of the SSC, June 23–July 13, 1984, Snowmass, Colorado, LBL-18294 August 1984.
- Capabilities of  $e^+e^-$  Collisions for Producing Very Heavy Higgs Bosons, S. Dawson and J. Rosner, Phys. Lett. 148B, 497 (1984), LBL-17995 July 1984.
- The Effective W Approximation, S. Dawson, LBL-17497 March 1984.
- Monopole Catalysis: An Overview, S. Dawson, in "Monopole '83," ed. J. Stone, Plenum Press (1984), LBL-16846.
- Is Supersymmetry Found? J. Ellis and M. Sher, LBL-18130 July 1984.
- Topics in Statistical Mechanics, V. Elser, Ph.D. Thesis, LBL-17840 May 1984.
- The Equilibrium Shape of Crystal Edges, V. Elser, LBL-17558 March 1984.
- Topological Theory of Strong and Electroweak Interactions, J. Finkelstein, LBL-18534 October 1984.
- On the Scaling of the Average Multiplicity in Hadron-Hadron Collisions, J. Finkelstein, LBL-18095 July 1984.
- Introduction to the Workshop: Electroweak Symmetry Breaking at the TeV Scale, M.K. Gaillard, a contribution to the Proceedings of the Theoretical Workshop on Electroweak Symmetry Breaking, June 4–22, 1984, Berkeley, California, LBL-18591.
- Strongly Interacting W's and Z's, M.K. Gaillard, a contribution to the Proceedings of the Theoretical Workshop on Electroweak Symmetry Breaking, June 4–22, 1984, Berkeley, California, LBL-18590.
- Physics at the Superconducting Supercollider, M.K. Gaillard with T. Appelquist and J.D. Jackson, Am. Scientist 72, 151–5 (Mar.–Apr. 1984), LBL-18243.
- Electroweak Interactions at the SSC: Introductory Remarks Multi W and Z Production, M.K. Gaillard, presented at the Workshop on pp Options for the Super Collider, University of Chicago, Feb. 13–17, 1984, LBL-17688.
- A Variational Principle for Bound States in Quantum Field Theory, M. Halpern and J. Greensite, UCB-PTH-84/33.
- Microcanonical Master Fields, M. Halpern, LBL-18576 October 1984.
- Link Formulation of Lattice Spin Systems, M. Halpern and G. Batrouni, Phys. Rev. D30, 1775 (1984).
- String, Corner and Plaquette Formulation of Finite Lattice Gauge Theory, M. Halpern and G. Batrouni, Phys. Rev. D30, 1782 (1984).
- Non-perturbative Breakdown of Scale Invariance in  $\phi_{2+n}^{4n+2}$ , M. Halpern, Phys. Lett. 137B, 382 (1984), LBL-16838.
- Overview of the Physics Issues at the SSC, I. Hinchliffe, a contribution to the Proceedings of the DPF Summer Study on the Design and Utilization of the SSC, June 23–July 13, 1984, Snowmass, Colorado, LBL-18742.
- Overview of the LBL Workshop, I. Hinchliffe, presented at the Theoretical Workshop on Electroweak Symmetry Breaking, June 4–22, 1984, Berkeley, California, LBL-18592.



- Collision Rates and New Physics, I. Hinchliffe, invited talk presented at the 4th U.S. School on Accelerator Physics, Fermilab, Batavia, Illinois, August 14–25, 1984, LBL-18572.
- Physics Issues at the SSC, I. Hinchliffe, LBL-18511.
- Higgs Bosons at the SSC: Supplement to EHLQ, I. Hinchliffe et al., in the Proceedings of the 1984 DPF Summer Study on the Design and Utilization of the SSC, Snowmass, Colorado, June 23–July 13, 1984, LBL-18390.
- Supercollider Physics, I. Hinchliffe, invited talk given at the 4th International Workshop on pp Interactions, Berne, Switzerland, March 5–8, 1984, LBL-17719.
- Supercollider Physics, I. Hinchliffe et al., *Rev. Mod. Phys.* 56, 579 (1984), LBL-16875.
- Another Look at the Gauged Wess-Zumino Effective Action, R. Ingermanson, LBL-17817 April 1984.
- Binding Effects and a Sum Rule in Q anti-Q Radiative Decays, J.D. Jackson and J. Rosner, EFI 84-41-Chicago and CERN TH.3992/84, November 1984.
- Muon Catalysis of Fusion: A Commentary on “Catalysis of Nuclear Reactions by  $\mu$  Mesons” (by L. Alvarez et al.), J.D. Jackson, LBL-18266 August 1984.
- Annual Review of Nuclear and Particle Science, Vol. 34, J.D. Jackson, Editor, H.E. Gove and R.F. Schwitters, Asso. Eds., Annual Reviews, Inc., Palo Alto (1984).
- Radiatively-Induced Topological Mass Terms in 2+1 Dimensional Gauge Theories, Y.-C. Kao and M. Suzuki, LBL-18816 November 1984.
- High Temperature Behavior of the Fermion Number Breaking Condensate around a Monopole, Y.-C. Kao, *Phys. Lett.* 143B, 147 (1984).
- Radiatively-Induced Topological Mass Terms in 2+1 Dimensional Gauge Theories, Y.-C. Kao with M. Suzuki, LBL-18816 December 1984.
- Lepton Number Violation in Softly Broken Supersymmetry: II., I.-H. Lee, UCB-PTH-84/15.
- Local Four Quark Operator in  $K^0\bar{K}^0$  Mixing: the Vacuum Saturation Estimate as an Upper Bound for the Matrix Element, B. Machet, LBL-17728 April 1984.
- $M_3M_{10}$  Quark Mass Difference and the Scalar Form Factor of  $K_{\mu 3}^0$  Reaction, B. Machet, *Z. Phys.* C21, 223 (1984), LBL-16048.
- QCD Sum Rule and I=0 Final States in D+ and F+ Mesons Semileptonic Decays, B. Machet, *Z. Phys.* C23, 357 (1984), LBL-15746.
- $G_A/G_V$  in the Quark Model, K. Maltman, LBL-18729 November 1984.
- On the Possibility of Deeply Bound Di-Baryon Resonances, K. Maltman, LBL-17652 April 1984.
- Quark Exchange Effects in the Three Nucleon System, K. Maltman, LBL-17529 April 1984.
- Composite Vector Meson and String Models, S. Mandelstam, talk presented at Chew Jubilee, Berkeley, California, Sept. 29, 1984, UCB-PTH-84/27.
- Differential Geometric Construction of the Gauged Wess-Zumino Action, J. Mañes, LBL-17318 January 1984.
- Massive Neutrinos and Cosmology, A. Natale, *Phys. Lett.* 141B, 323 (1984), LBL-17264.
- Fermion Masses and the Extended Technicolor State, A. Natale, *Z. Phys.* C21, 273 (1984), LBL-15768.
- Nonlinear Sigma Models and Integration Methods, E. Ntagwirumugara, LBL-18634 November 1984.
- Ultraviolet Divergencies and Supersymmetric Theories, A. Sagnotti, lecture presented at the International School of Physics “Enrico Fermi,” Course XCII, Varenna, Italy, June 1984, LBL-18406 September 1984.
- Notes on Harmonic Superspace, W. Siegel, UCB-PTH-84/25 September 1984.
- Some Extended Supersymmetric Two-dimensional Scalar Multiplets, W. Siegel, UCB-PTH-84/23d August 1984.
- Chiral Actions for N=2 Supersymmetric Tensor Multiplets, W. Siegel, UCB-PTH-84/22 July 1984.
- Covariantly Second-Quantized String III, W. Siegel, *Phys. Lett.* 149B, 162 (1984), UCB-PTH-84/21 July 1984.
- Covariantly Second-Quantized String II, W. Siegel, *Phys. Lett.* 149B, 157 (1984), UCB-PTH-84/18 June 1984.
- Covariantly Second-Quantized String, W. Siegel, *Phys. Lett.* 142B, 276 (1984), UCB-PTH-84/11.
- Energy Momentum Tensors, Supercurrents, (Super)Traces and Quantum Equivalence, W. Siegel et al., *Nucl. Phys.* B247, 157 (1984).
- Manifest Lorentz Invariance Sometimes Requires Nonlinearity, W. Siegel, *Nucl. Phys.* B238, 307 (1984), UCB-PTH-83/22.
- Unusual Representations of Local Groups, W. Siegel, *Phys. Lett.* 134B, 318 (1984), UCB-PTH-83/15.
- Light-Cone Analysis of Covariant Superstrings, W. Siegel, *Nucl. Phys.* B236, 311 (1984), UCB-PTH-83/12.
- Light Cone Formulation of N=2 Yang Mills, A. Smith, LBL-18668 November 1984.

Time and Quantum Process, H. Stapp, talk presented at the Conference "Physics and the Ultimate Significance of Time," Center for Process Studies, Claremont, California, March 16, 1984, LBL-17576 March 1984.

Low-energy Signals of Composite Models: Compositeness Study Group at the SSC Theoretical Workshop, M. Suzuki et al., presented at Workshop summary of SSC Theoretical Workshop, Berkeley, California, June 4–22, 1984 and at the DPF 1984 Summer Study for Design and Utilization of SSC, Snowmass, Colorado, June 23–July 13, 1984, USC 84/038 September 1984.

Nonstandard Higgs Bosons, M. Suzuki et al., SSC Theoretical Workshop subgroup report, LBL, Berkeley, June 1984, to be published in the Proceedings of the 1984 DPF Summer Study Conference, Snowmass, Colorado, June 23–July 13, 1984.

Hadronic Invariant Mass in Semi-leptonic Top Decay: A Simple Way to Detect Top Particle Decay?, M. Suzuki, LBL-18770 November 1984.

F Meson Production Rate in Bottom Meson Decays, M. Suzuki, LBL-18769 November 1984.

The  $\xi$  (2220) Puzzle, M. Suzuki et al., Phys. Lett. 145B, 135 (1984), LBL-17922.

Theoretical Upper Bound on  $F \rightarrow \phi\pi$  Decay Rate by Current Algebras, M. Suzuki, Phys. Lett. 142B, 305 (1984), LBL-17631 April 1984.

Anomalous Z Decays and g-2 of Electron, M. Suzuki, Phys. Lett. 143B, 237 (1984), LBL-17630 April 1984.

$B \rightarrow F + X$  Decay and Pseudoscalar Decay Constants of Explicitly Flavored Heavy Mesons, M. Suzuki, Phys. Lett. 142B, 207 (1984), LBL-17629.

Explicit R Parity Breaking in Supersymmetric Models, M. Suzuki and L. Hall, Nucl. Phys. B231, 419 (1984), LBL-16150.

Weak Spectral Functions and their Application to the Decay of the W-Boson, K. Svozil, Lettere al Nuovo Cimento 39, 294 (1984), LBL-15745.

Remarks Concerning the  $E_8 \times E_8$  and  $D_{16}$  String Theories, J. Thierry-Mieg, LBL-18464.

Mass Matrices and Mass Sum Rules in N=1 Supergravity with Noncanonical Kinetic Energies, M. Visser, LBL-18350 September 1984.

Aspects of Supersymmetry Breaking, M. Visser, Ph.D. Thesis, LBL-18189 August 1984.

The Topological Degree for Supersymmetric Chiral Models, M. Visser, LBL-17691.

Some Generalizations of the O'RaiFeartaigh Model, M. Visser, LBL-17690.

Supersymmetry and the Index Theorem, B. Zumino, lecture given at Shelter Island II Conference, Shelter Island, New York, June 1–2, 1983, LBL-17972 June 1984.

Consistent and Covariant Anomalies in Gauge and Gravitational Theories, B. Zumino and W. Bardeen, Nucl. Phys. B244, 421 (1984), LBL-17639.

Curling Up Two Spatial Dimensions with  $SU(1,1)/U(1)$ , B. Zwiebach and M. Gell-Mann, Phys. Lett. 147B, 111 (1984), UCB-PTH-84/20.

Spacetime Compactification Due to Scalars, B. Zwiebach and M. Gell-Mann, Phys. Lett. 141B, 333 (1984), UCB-PTH-84/4.

Searching for All N=4 Supergravities with Global  $SO(4)$ , B. Zwiebach and S. Gates, Nucl. Phys. B238, 99 (1984).

Additional Vacua for Four-Dimensional Supergravities, B. Zwiebach, Phys. Lett. 135B, 393 (1984), UCB-PTH-83/24.

Magnetovacs in Gauged N=4 Supergravity, B. Zwiebach and D. Freedman, Nucl. Phys. B237, 573 (1984), UCB-PTH-83/20.

## 1984 Workshop on Electroweak Symmetry Breaking

The Workshop on Electroweak Symmetry Breaking was held at LBL from June 4 until June 22, 1984. The purpose of the meeting was to investigate the theoretical problems surrounding the mechanism for the breaking of electroweak symmetry and the generation of the W and Z boson masses. Emphasis was placed on extracting predictions which could be tested definitively at the SSC.

The workshop was organized by Tom Appelquist (Yale University), Mary K. Gaillard (UCB and LBL) and Ian Hinchliffe (LBL). It was attended by 41 theorists of whom 4 were from Europe, 1 from India, 32 from universities and national laboratories in the United States and 4 from LBL.

The workshop began with a series of invited talks the purpose of which was to acquaint the participants with the current problems and recent progress. A talk by Mary K. Gaillard served as an introduction to the workshop and outlined its goals. John Ellis (CERN) then reported on the status of future European plans and upon a workshop held at Lausanne, Switzerland in April 1984. Jay Marx (LBL) outlined the conclusions of the SSC reference design study hosted by LBL in the spring of 1984. The "Physics at the SSC" working group's activities, which extended over a six month period, were reviewed by Stu Loken (LBL). Robert Cahn (LBL) outlined the



conclusions of the DPF meeting on the  $\bar{p}p$  option for the SSC held in Chicago in Feb. 1984. Dave Jackson (LBL, UCB) reviewed the ICFA meeting held in Japan in May 1984. Finally, Chris Quigg (FNAL) reported on some conclusions from a detailed study undertaken by him and his collaborators.

A few specialized seminars were held during the workshop, but for most of the time participants were engaged in working groups, each of which attacked a specific problem.

Our present understanding of the mechanism of electroweak symmetry breaking is rather limited. The simplest mechanism for generating a mass for the W and Z bosons involves the prediction of the existence of a single spin zero particle (the Higgs boson) whose mass is undetermined by the model. This model is unstable to radiative corrections which tend to increase the mass of the W and Z by 16 orders of magnitude. One working group, led by K. Lane (Ohio State) examined the various ideas for experiments to search for this single scalar particle. In particular they concentrated on the mass range between 100 GeV and twice the mass of the W boson. In this mass region the Higgs decays dominantly into a pair of top quarks, and there is a very large background. The production in association with a W boson was found to be a promising signal. This work provided a stimulus to one of the groups at the DPF summer study held at Snowmass immediately following the LBL workshop.

One other working group led by P. Langacker (U. Penn.) considered the ramifications of minimal extensions to the simplest model in which there are more elementary scalar particles.

In the simplest model the mass of the Higgs scalar cannot become arbitrarily large, or the theory ceases to be sensible. Below this critical value is a region where the Higgs is very heavy, has a very short lifetime and interacts strongly with W and Z bosons.

This case was investigated by a group lead by Mary K. Gaillard (LBL, UCB) who were able to clarify some of the proposed tests for this possibility.

A more drastic modification of the simple model is provided by models based on supersymmetry. These models which predict many new particles avoid the problems of radiative corrections which are so acute in the simplest model. A group led by John Ellis (CERN) surveyed these supersymmetric models and examined the signals they suggest for experiments at the SSC.

More speculative is the suggestion that quarks and leptons may not be elementary particles but are rather built from some more fundamental constituents. Theoretical work in this area has only recently begun; the hope is that one will be able to explain the spectrum of quarks and leptons. Work on signals for such composite structures at the SSC was carried out by the group headed by I. Bars (USC).

Finally, a group led by L. Hall (Harvard), J. Rosner (U. Chicago) and R. Jaffe (MIT) considered the implication for the SSC of the recently reported strange event seen at the  $S\bar{p}pS$  collider at CERN.

Following the conclusion of the workshop a number of the participants attended the DPF summer study on the design and utilization of the SSC. Their input was important to experimental groups considering the practicalities of experiments at the SSC.

#### Local organizers

Mary K. Gaillard, Ian Hinchliffe

#### Publication

Proceedings of the Workshop on Electroweak Symmetry Breaking, LBL-18571/UC-34D/CONF 8406190, 1984.

# **MATHEMATICS**



## MATHEMATICS DEPARTMENT

Ben-Artzi, Matania  
Berger, Marsha  
Buttke, Thomas  
Chang, Chien-Cheng  
Chorin, Alexandre  
Colella, Phillip  
Concus, Paul  
Fogelson, Aaron  
Greengard, Claude  
Grunbaum, F. Alberto  
Hald, Ole

Heatlie, Valerie  
Kostlan, Eric  
Krasny, Robert  
Meurant, Gerard  
Miranda, Mario  
Puckett, Elbridge  
Reach, Michael  
Roberts, Stephen  
Saltzman, Jeffrey  
Sethian, James  
Whitaker, Nathaniel

# Mathematics

Research in mathematics is described below under the standard DOE classifications of applied analysis, computational mathematics, and numerical methods for partial differential equations.

## Applied Analysis

### Capillarity Phenomena

The work in capillarity phenomena is concerned with questions of the existence, stability, and qualitative behavior of solutions of the governing nonlinear partial differential equations.

Work continued on extending results obtained from the previously developed subsidiary variational problem. This subsidiary problem achieves an important simplification by reducing the question of existence of a capillary free surface in a cylinder to a lower dimensional one of whether curves having certain properties can be found in a section of the cylinder. An alternative geometric configuration to the previously studied cylinder with trapezoidal cross-section has been developed as a possible configuration for a planned physical experiment in space. This new geometry, for which the cross-section is non-convex, may overcome the practical contact-angle restriction angle inherent in the trapezoidal configuration. These mathematical results continue to interact with the design in progress of a NASA Spacelab experiment for testing the striking theoretical predictions for the behavior of capillary surfaces.

### Inverse Problems

#### Reconstruction of the Density of the Earth from Oscillation Data

This work uses the frequencies of the fundamentals and overtones of the earth's free oscillation to determine the velocity of the waves and the density in the upper mantle.

Work has continued on the mathematical theory for reconstructing discontinuous density and velocity profiles from eigenvalues. We have shown that if the potential of a Sturm-Liouville problem with one interior discontinuity is known over half an interval and one boundary condition is given, then the potential and the other boundary conditions are uniquely determined by the eigenvalues. Applied to the Earth, this theory shows that if the density is given in the lower mantle and if the velocity of the shear waves is given throughout the mantle and in the crust, then

the density is uniquely determined by the eigenfrequencies of the torsional modes with a fixed angular order. These results were extended to problems with two discontinuities.

#### Image Reconstruction from Projections

This work is directed toward developing optimal numerical schemes and understanding the mathematical constraints on different forms of tomography, with special emphasis on the effects of limiting the number or range of the directions defining the projections. The goal is a quantitative prediction of the quality of a reconstructed image as a function of the projection data.

Research has centered on the relation between the amount of data and picture quality for a variety of image reconstruction problems. Of special significance is the discovery of unexpected connections between this work and recent developments in nonlinear differential equations as exemplified by the Korteweg-deVries equation. An efficient way to compute numerically the singular functions of the finite Laplace transform has been found, which should be of substantial importance in numerical inversion of the transform.

### Lattice Models

A full scale mathematical and computational investigation of lattice models, such as the Ising model, the XY model, and the Heisenberg model, is underway at LBL. Such models are of fundamental importance in quantum field theory, phase transitions, and as models of turbulence. We have produced a fast method for evaluating thermodynamic quantities on a finite lattice, as well as an effective method of approximating thermodynamic quantities, and we have made explicit the relation between lattice models and the rescaling method in fluid mechanics.

The main achievement this year is the development of a fast solver for finite lattices, which reduces dramatically the amount of labor required to evaluate partition functions. Previous to this work, such calculations could be expected to use extremely large amounts of computer time, if they could be carried out at all. The labor required to perform various standard manipulations in statistical mechanics, such

as multiplying and diagonalizing transfer matrices, now has been profoundly decreased. We are in the process of applying our techniques to the analysis of the roughening transition, which is important in quantum field theory. Such work serves also as a testing ground for methods for studying the nature of phase boundaries in solidification processes.

## Computational Mathematics

### Elliptic Partial Differential Equations

This work is directed toward the development of efficient numerical methods for solving the large sparse algebraic systems arising from discretization of elliptic partial differential equations.

Work continued on developing block preconditioning techniques for the conjugate gradient method based on incomplete block Cholesky factorization. The highly successful preconditionings developed previously, which are based on generating selected elements of the inverse of tridiagonal matrices, were extended by developing analogous relationships for pentadiagonal matrix inverses. These are being investigated initially for preconditioning of problems in two space dimensions. A variant of our earlier preconditionings that utilizes features of vector/parallel computer architectures has been formulated and tested. Work has begun on extending our preconditionings to three space dimensions.

### Stochastic Ordinary Differential Equations

This work involves the development and thorough investigation of methods for solving stochastic differential equations. Such equations arise, for example, in physics, biology, control theory, and in the context of vortex methods.

The effort in the area of stochastic differential equations has two main components: first, the development of accurate integration methods, and second, the application of these methods to physical problems. Of particular interest are stochastic models of boundary layer separation. This year, we have developed higher-order accurate methods for solving these equations. To our knowledge our effort is the first systematic application of randomized numerical analysis to stochastic differential equations.

## Numerical Methods for Partial Differential Equations

### Vortex Dynamics and Turbulence

Vortex methods for low Mach number, viscous and inviscid, laminar and turbulent, reacting and inert flows have been developed at the Mathematics Department at LBL and are by now well known and established. Our efforts are directed toward (i) pursuing new applications, (ii) providing convergence proofs and error bounds, and (iii) providing technical support and advice to users in physics and engineering.

There have been a number of important accomplishments in vortex methods this year: the development of vortex methods for the study of liquid helium, the completion of a detailed study of the vortex method over a wide range of Reynolds numbers, and the development of a new theoretical analysis of the random walk part of the vortex algorithm.

For liquid  $\text{HE}_4$ , we have found numerical evidence showing that phonon scattering by vortex lines decreases the rate of vortex stretching. This results in a simplified vortex method, in which only local self-induction interactions are summed, allowing a complete numerical study of self-sustaining quantized turbulence, including its critical properties.

We have performed detailed calculations to study flow over a backward-facing step for a wide range of Reynolds numbers. The results show the transition from viscous to turbulent flow, and are in excellent agreement with experimental data. In particular, computed reattachment lengths, eddy size and tear-off frequency, average velocity profiles, and correlation statistics accurately reproduce experimental measurements. Detailed checks of the robustness of the method were made. We are providing programs and advice to a number of users, at universities, national laboratories, and industrial firms.

Rigorous error estimates for vortex filament methods and random walk simulations of vortex diffusion have been derived, and their validity checked through extensive parameter studies. We have also found that vortex core spreading, advocated in the literature as an alternative to random walk diffusion simulations, fails to converge to the right equation. We considered a system of diffusion equations

modeling free convection near a wall and proved convergence for a vorticity creation grid free random walk method. We have proved that all vortex methods with Hölder continuous initial data converge to the solution of Euler's equations. Infinite order methods have been found and convergence proved for fourth order Runge-Kutta time discretizations.

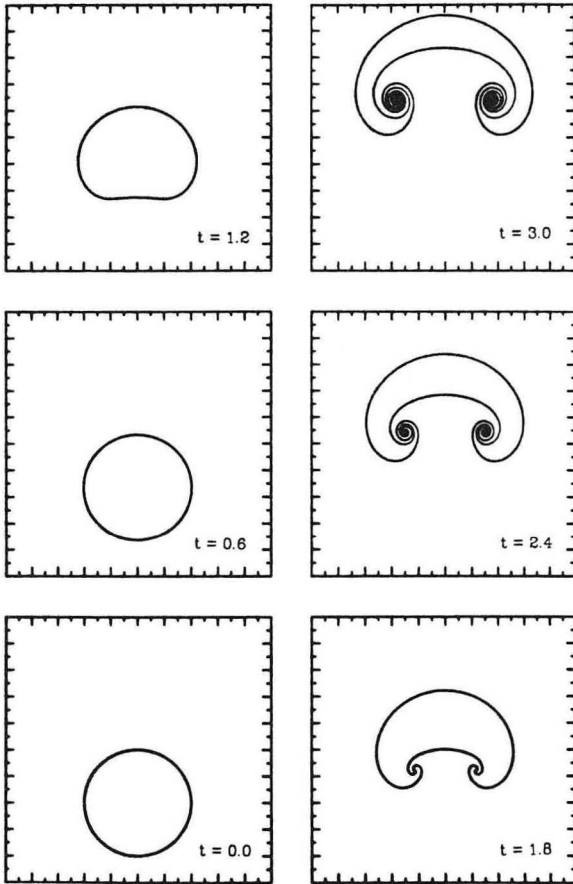

XBL 8512-4920

Fig. 35. Vortex method numerical simulation of the motion of a two-dimensional line thermal under the influence of gravity. Line thermals are cylindrical regions of light, less dense fluid, rising buoyantly through heavier, more dense fluid — for example, bent-over plumes issuing from smokestacks in a cross wind. The depicted curves represent the interface between lighter and heavier fluid. Individual frames give the interface location at successive times  $t = 0.0$  to  $3.0$ .

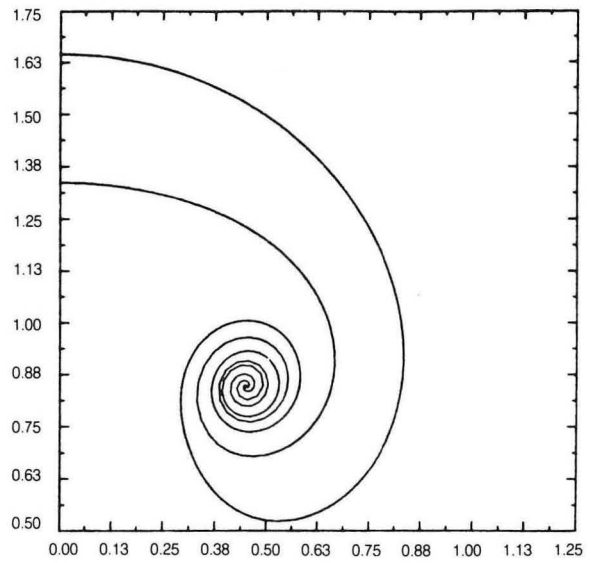

XBB 8512-4921

Fig. 36. Line thermal interface position detail at  $t = 3.0$ .

## High Resolution Methods for Hyperbolic Equations

Research in high resolution methods for hyperbolic equations concerns the development of accurate and robust numerical methods for problems whose solutions have discontinuities, through the incorporation of analytical solution elements into the numerical algorithms.

A new hybrid implicit/explicit algorithm for hyperbolic systems in one space dimension was developed. This method is more efficient and robust than a previous method, but yields equally accurate results for explicit characteristics and in the limit of steady state. We have extended the Enquist-Osher flux function for scalar equations to the case of systems; this is an essential part of the development of implicit upwind methods. We have coupled a local adaptive mesh refinement (AMR) algorithm for time dependent problems in shock hydrodynamics in two dimensions to the second order Godunov methods. In these techniques, the finite difference grid is refined locally in space and time to achieve increased accuracy, with the regions of refinement changing as the solution changes. The ideas have been extended to Lagrangian hydrodynamics in two dimensions.



We have continued the numerical study of self similar shock reflection in two dimensions. Numerical calculations are in excellent agreement with physical experiments in cases for which non-ideal effects are negligible. In addition, we have verified the correctness of the Von Neumann criterion for transition from regular to Mach reflection for the strong shock case to within a few percent in parameter space.

A second-order high-resolution scheme for compressible duct flows was developed using an analytic solution of the generalized Riemann problem. Analytic resolution of singularities makes possible calculation of the flux without losing second order accuracy. Thus adaptive meshes can be used in conjunction with this scheme. The detailed mathematical treatment of this case has been completed; in particular, special attention has been given to a coupled Eulerian-Lagrangian computation for multiphase flow. A numerical application has shown excellent agreement with experimental data.

A computer software module for gas dynamics in one dimension embodying our methods has been developed for general distribution.

## Fronts and Interfaces

What began as two separate studies of front propagation — flame propagation and oil/water fronts in porous media — has become an extensive study of front stability and structure. Many of these fronts undergo a finite amplitude instability, not predicted by linearized theory, and a propensity to loss of smoothness and fractal structure. Some specific examples under investigation are flames, oil/water interfaces in porous media, solidification fronts in supercooled environments, phase boundaries in lattice models, and vortical flow/potential flow separatrixes in ideal fluids.

A detailed study of finite amplitude instability in solidification fronts has shown that instability does exist, and that the Gibbs-Thomson relation at the solid/liquid interface does not provide an appropriate description of the physics of solidification. We have continued studying vortex sheet evolution. The point vortex method was used to study the formation of a singularity in the vortex sheet model at finite time. The vortex blob method was used to study the sheet's evolution beyond the critical time. We have studied the motion of a curve propagating along its normal vector field with speed a function of curvature as an idealized model of crystal growth and flame propagation. We have shown a remarkable

analogy between this problem and hyperbolic conservation laws: In the limit as the curvature term vanishes, cusps form, and an entropy condition can be formulated to extend a weak solution beyond breakdown. We provide strong numerical evidence to show that this is indeed the correct weak solution.

The modified random choice method developed earlier has been used to study the effects of small amounts of capillary pressure on waterflooding of a petroleum reservoir. The method is sufficiently free of unwanted numerical dissipation that spontaneous fingering can be followed successfully in the unstable regime.

We have continued our development of front tracking methods for hyperbolic conservation laws. The coupling to conservative finite difference schemes away from the front is done in a way that preserves the discrete conservation form across the front, does not restrict the time step any more than is required for stability for the interior algorithm away from the tracked front, and does not require any changes in the logical structure of the finite difference grid near the front.

## Reacting Flows

### Combustion

The research in combustion is concerned with the accurate calculation of fluid flows in the presence of large energy sources due to chemical reactions. This work utilizes vortex and high resolution methods coupled with new numerical techniques specifically designed to handle the exothermic reactions.

The central goal of this work is the development of a realistic model of turbulent combustion in a moving piston in both two and three dimensions. Our approach has been to start with the vortex method as a fundamental tool for studying turbulent flow, and to build in physical effects.

We began this year with an extensive investigation of the competing effects of viscosity, exothermicity, and boundary conditions on flame propagation in turbulent flow in open channels, using the combined techniques of vortex blobs, vortex sheets, and flame propagation algorithms developed at LBL, and a new model for low Mach number combustion in closed vessels. This investigation provided major new insights into the understanding of flame propagation rates, corner effects, and the persistence of pockets of unburnt fuel. We performed lengthy studies of flow over a backward-facing step, where large amounts of experimental data are available, to provide a solid

justification for the claim that vortex methods can accurately be used in viscous and turbulent regimes, and to indicate how numerical parameters should be chosen in combustion studies.

### Transport Modeling

Research on transport modeling centers on the study of two biological phenomena: platelet adhesion/aggregation during blood clotting and calcium diffusion within the presynaptic terminal of a nerve cell.

Substantial improvements were made in a numerical method constructed to study a mathematical model of platelet adhesion and aggregation. In the model, blood is represented as an incompressible viscous fluid containing discrete platelets, which can secrete a clot-potentiating chemical. The numerical scheme includes a finite-difference method to solve the fluid-dynamics equations, a particle method to solve the chemical advection-diffusion equation, sparse non-linear optimization techniques to calculate interplatelet forces, and a linked-list data structure to keep track of the development of the growing aggregates. A new numerical treatment of the fluid-dynamic equations is under development using fast Fourier transforms for the velocity-pressure component and is readily extendible to three-dimensional calculations.

A three-dimensional model was developed for the diffusion of calcium within the presynaptic terminal of a nerve cell. The model includes calcium influx through an array of discrete channels in the cell's surface membrane, active extrusion of calcium by a surface pump, and rapid cytoplasmic binding of calcium within the cell. The equations of the model were solved analytically and numerical calculations based on this solution show substantial agreement with experimental measurements, unlike existing one-dimensional calculations.

### Publications

N. Albright, *Test problem for the two-dimensional Buckley-Leverett Equation*, LBL-17113, 1984.

C. Anderson and C. Greengard, *On vortex methods*, LBL-16376, 1984.

M. Ben-Artzi and A. Birman, *Application of the GRP method to compressible flows with material interfaces*, LBL-18994, 1984.

M. Ben-Artzi and J. Falcovitz, *A second-order Godunov-type scheme for compressible fluid dynamics*, J. Comput. Phys. 55, 1984, pp. 1-32.

A.J. Chorin, *Curvature, Stefan problems, and unstable solidification*, J. Comput. Phys., 1985, in press.

A.J. Chorin, *Solution of lattice models by successive linkage*, LBL-18536, 1984.

P. Colella, *Multidimensional upwind methods for hyperbolic conservation laws*, LBL-17023, 1984.

P. Colella, *A direct Eulerian MUSCL scheme for gas dynamics*, SIAM J. Sci. Stat. Comput., 1985, in press.

P. Colella and H.M. Glaz, *Numerical computation of complex shock reflections in gases*, Lecture Notes in Phys., 218, Springer-Verlag, Berlin, 1984, pp. 154-158.

P. Colella, P. Concus, and J. Sethian, *Some numerical methods for discontinuous flows in porous media*, Frontiers in Applied Mathematics, I — The Mathematics of Reservoir simulation, R.E. Ewing, ed., SIAM, Philadelphia, 1983, pp. 161-186.

P. Colella, A. Majda, and V. Roytburd, *Theoretical and numerical structure for reacting shock waves*, LBL-18363, 1984.

P. Colella and P.R. Woodward, *The piecewise-parabolic method (PPM) for gas-dynamic simulations*, J. Comput. Phys., 54, 1984, pp. 174-201.

P. Concus and R. Finn, *On the extremals of a subsidiary capillary problem*, J. Reine Angew. Math., 1985, in press.

P. Concus, G.H. Golub, and G. Meurant, *Block preconditioning for the conjugate gradient method*, SIAM J. Sci. Stat. Comput., 6, 1985, pp. 220-252.

P. Concus and M. Miranda, *MACSYMA and minimal surfaces*, LBL-18228, 1984.

P. Concus and V. Pereyra, *Calculating axisymmetric menisci*, Acta Cient. Venezolana, 34, 1983, pp.89-100.

P. Concus, E. Kostlan, and J.A. Sethian, *Capillary pressure and the modified random choice method for porous flow*, Computing Methods in Applied Sciences and Engineering, R. Glowinski and J.-L. Lions, eds., North Holland, Amsterdam, 1984, pp. 659-672.

P.A. Cox and J.A. Sethian, *Gamete motion, search, and the evolution of anisogamy, oogamy, and chemotaxis*, Amer. Natur., 125, 1985, in press.

P.A. Cox and J.A. Sethian, *Search, encounter rates and the evolution of anisogamy*, Proc. Nat. Acad. Sci. U.S.A., 81, 1984, pp. 6078-6079.

P. Deift, T. Nanda, and C. Tomei, *Toda flows on band matrices*, LBL-15777, 1984.

A.L. Fogelson and R.S. Zucker, *Presynaptic calcium diffusion from an array of single channels: implications for transmitter release and synaptic facilitation*, LBL-19038, 1985.

- B.A. Fryxell, P.R. Woodward, P. Colella, and K.-H. Winkler, *An implicit-explicit hybrid method for Lagrangian hydrodynamics*, UCRL-90727, 1984.
- A.F. Ghoniem and J.A. Sethian, *Dynamics of turbulent structures in recirculating flow*, 23rd Aerospace Sciences Meeting, Reno, 1985.
- H.M. Glaz, P. Colella, I.I. Glass, and R.L. Deschambault, *A numerical study of oblique-shock-wave reflections with experimental comparisons*, LBL-18156, 1984.
- C.A. Greengard, *Three-dimensional vortex methods*, Ph.D. thesis, LBL-18217, 1984.
- G. Groh, *An iterative method for solving a class of integral equations in potential aerodynamics*, LBL-18345, 1984.
- F.A. Grunbaum, *Orthogonal polynomials and second order differential equations*, IMA J. Appl. Math., 1984.
- F.A. Grunbaum, *Some mathematical problems suggested by limited angle tomography*, SIAM-AMS Proceedings, Vol. 14, 1984.
- F.A. Grunbaum, *A remark on the radar ambiguity function*, IEEE Trans. Inform. Theory, IT-30, 1984, pp. 126–127.
- F.A. Grunbaum, *The Bloch equations and two nonlinear extensions of the Fourier transform*, Proceedings, Third Annual Meeting, Society of Magnetic Resonance in Medicine, New York, 1984, pp. 281–282.
- F.A. Grunbaum, *Band and time limiting, recursion relations and some nonlinear evolution equations*, Special Functions: Group Theoretical Aspects and Applications, R.A. Askey et al. (eds.), D. Reidel Publishing Co., 1984, pp. 271–296.
- F.A. Grunbaum, *Recursion relations and a class of isospectral manifolds for Schroedinger's equation*, Advances in Nonlinear Waves, Vol. 1, E. Debnath, ed., Pitman Publishing House, 1984, pp. 226–229.
- F.A. Grunbaum, *The limited angle problem in reconstruction from projections*, Proc. of the NATO-Advanced Research Workshop on Inverse Methods in Electromagnetic Imaging, Germany, 1984, pp. 277–298.
- O.H. Hald, *Discontinuous inverse eigenvalue problems*, Comm. Pure Appl. Math. 37, 1984, pp. 539–577.
- O.H. Hald, *Convergence of a random method with creation of vorticity*, PAM-52, LBL-18888, 1984.
- A. Majda and J.A. Sethian, *The derivation and numerical solution of the equations of zero Mach number combustion*, SIAM J. Appl. Math., 1984, in press.
- G. Meurant, *Numerical experiments for the preconditioned conjugate gradient method on the CRAY X-MP/2*, LBL-18023, 1984.
- M. Miranda, *Lectures on generalized solutions to the minimal surface equation*, LBL-18022, 1984.
- M. Miranda and S. Roberts, *Lagrange multipliers and geometric measure theory*, LBL-15692, 1983.
- R.K. Perline, *Some aspects of the theory of time and band limited operators associated with Lamé's equation*, Ph.D. thesis, LBL-17570, 1984.
- M. Reach, *Recursion relations for solutions to the Schrödinger equation*, LBL-18637, 1984.
- J.S. Saltzman and P. Colella, *A second order corner-coupled transport method for Lagrangian hydrodynamics*, Los Alamos National Laboratory Report LA-CP-84-230, 1984.
- J.A. Sethian, *Curvature and the evolution of fronts*, Comm. Math. Phys., 1985, in press.
- J.A. Sethian, *Numerical simulation of flame propagation in a closed vessel*, Proc. Fifth Internat. Conf. Numer. Meth. Fluid Mech., Friedr. Vieweg and Sohn, Braunschweig/Wiesbaden, 1984.
- J.A. Sethian, *Vortex methods and turbulent combustion*, LBL-17668, 1984.
- J.A. Sethian, *Turbulent combustion in open and closed vessels*, J. Comput. Phys. 54, 1984, pp. 425–456.
- C. Willis, *Inverse problems for torsional modes*, Geophys. J. Roy. Astr. Soc., 78, 1984, pp. 847–853.
- P.R. Woodward and P. Colella, *The numerical simulation of two-dimensional fluid flow with strong shocks*, J. Comput. Phys., 54, 1984, pp. 115–173.
- R.S. Zucker and A.L. Fogelson, *The relationship between total calcium current and neurosecretion: application of a three-dimensional diffusion model with discrete calcium channels*, LBL-19039, 1985.

# APPENDIX

# APPENDIX

## Research Progress Meetings

### January 1984 – June 1985

| DATE          | SPEAKER  | SUBJECT   |
|---------------|--|---|
| <b>(1984)</b> |  |   |
| January 5     | Chris Quigg, Fermilab                            | Supercollider Physics   |
| January 12    | Sally Dawson, LBL                                | Experimental Tests of Supersymmetry   |
| January 19    | M. Koshiha, U. of Tokyo                          | Results from the Kamioka Nucleon Decay Experiment   |
| January 26    | Robert Cousins, UCLA                             | Prospects for Searches for $K \rightarrow \mu e$ and Other Rare K Decays                      |
| February 2    | Jim Siegrist, LBL                                | Electrons and Jets with the UA2 at the CERN $S\bar{p}pS$                                      |
| February 9    | Peter Bosted, American University/SLAC           | Measurements of the A-Dependence of Deep Inelastic Electron Scattering from Nuclei            |
| February 14   | Dave Nygren and Victor Perez-Mendez, LBL         | Status Report on the Chinese $e^+e^-$ Project and highlights from the San Antonio APS Meeting |
| February 16   | Rich Muller, LBL                                 | Periodic Mass Extinctions by Comet Showers  |
| February 23   | James Cronin, Enrico Fermi Institute             | A New Measurement of the $\pi^0$ Lifetime   |
| March 1       | Kevin Black, Yale                                | The Search for Direct CP Violations at Brookhaven: Present Status                             |
| March 6       | Bob Cahn, Mary K. Gaillard, and Bill Wenzel, LBL | Review of Chicago SSC Workshop  |
| March 8       | Persis Drell, LBL                                | Parity Violation in Atomic Thallium   |
| March 15      | T. Kamae, U. of Tokyo                            | Evidence for the $F^*$ Meson from the PEP-4/TPC Experiment                                    |
| March 20      | Steven Ellis, U. of Washington, Seattle          | Testing QCD in $e^+e^-$ Physics   |
| March 22      | G. Goldhaber, R. Madaras, and I. Hinchliffe, LBL | Report from the Moriond and Bern Conferences  |

| DATE     | SPEAKER   | SUBJECT  |
|----------|---|--|
| March 29 | Volker Eckardt,<br>Max-Planck-Institute         | Some Preliminary Results from<br>the EMC Vertex Spectrometer   |
| April 5  | Maury Tigner, Cornell                           | SSC Reference Designs: A<br>Critical Assessment  |
| April 10 | Norbert Wermes, SLAC                            | New Results on Radiative<br>Decays from the Mark III<br>Detector   |
| April 17 | Aurore Navarro, Saclay                          | New Results From UA-1  |
| April 19 | Robert Lanou, Brown U.                          | Neutrino and Antineutrino<br>Scattering Off Electrons  |
| April 26 | Jerry Nelson, LBL                               | Status of the Ten-Meter-<br>Telescope Project  |
| May 3    | David Attwood, LBL                              | Opportunities and Challenges<br>for Coherent Soft X-Ray<br>Experimentation (X-Ray Optics<br>Center, ALS) |
| May 9    | Willis Sakumoto,<br>Northwestern U.             | Hadronic Charm Production at<br>Fermilab   |
| May 10   | Duncan Carlsmith, U. of<br>Chicago              | A New Measurement of the<br>$K^*0$   |
| May 15   | Michael Moe, UC-Irvine                          | Double- $\beta$ -Decay Experiment<br>with a TPC  |
| May 22   | Alexander Pines, UCB/LBL                        | NMR with Regular and Irregular<br>Radiation  |
| May 24   | Steve Schnetzer, Virginia<br>Polytech Institute | The AMY Project at TRISTON   |
| June 7   | George Gollin, Princeton                        | $\eta_{00}/\eta_{+-}$ at Fermilab  |
| June 14  | Thomas Appelquist, Yale                         | Physics in More Than Four<br>Dimensions  |
| June 21  | Juliet Lee-Franzini, CUSB                       | Structures Above the $\bar{B}B$<br>Threshold and The Search for<br>$B^* \rightarrow B$ Transition        |
| June 28  | Arthur Poskanzer, LBL                           | Collective Flow of Nuclear<br>Matter   |
| July 5   | Richard Dubois, SLAC                            | B Lifetime Results From Delco  |
| July 17  | Stephen Maxfield, U. of<br>Maryland             | Measurement of Real and<br>Virtual Photon Structure<br>Functions at Pluto                                |
| July 19  | Jorg Pyrlík, DESY                               | Search for Photinos and<br>Scalar Leptons with TASSO at<br>PETRA   |



| DATE         | SPEAKER   | SUBJECT   |
|--------------|---|---|
| July 24      | Hermann Grunder and Ian Hinchliffe, LBL               | Snowmass Meeting Review—Part I: Who's Who In The Zoo. Physics Developments at the SSC |
| July 26      | Christoph Leeman and Gerry Abrams, LBL                | Snowmass Meeting Review—Part II: Magnets and Accelerator Detectors                    |
| July 31      | Hans-Jurgen Hilke, CERN                               | DELPHI Status Report  |
| August 9     | Rafe Schindler, Caltech                               | Mark III Results on D Decays  |
| August 14    | Wim de Boer, CELLO Collaboration—Max-Planck-Institute | Search for New Phenomena in $e^+e^-$ Interactions                                     |
| August 21    | Jim Prentice, U. of Toronto                           | New Results on F and F* from the Argus Experiment                                     |
| August 28    | Brian Foster, Imperial College                        | b Lifetime Measurement Using TASSO Vertex Detector                                    |
| August 30    | S. Protopopescu, BNL                                  | Study of $K\bar{K}\pi$ System Produced by $\pi^-$ and $\bar{P}$                       |
| September 6  | M. Chanowitz and H. Steiner, LBL                      | Reports from the Beijing and Leipzig Conferences                                      |
| September 13 | Fred Goulding, LBL                                    | The LBL-UCSB Double- $\beta$ -Decay Detector System—First Results                     |
| September 20 | Brian Lynn, Oxford                                    | Electroweak Radiative Corrections at the SLC and LEP                                  |
| September 27 | Ling-Lie Chau, BNL                                    | Quark-Mixing Phenomenology: Heavy Quark Decays and CP Violations                      |
| October 4    | C.E. Taylor and W.A. Wenzel, LBL                      | Progress of SSC Magnet R&D  |
| October 11   | Koichiro Nishikawa, U. of Chicago                     | Measurement of $\epsilon'/\epsilon$ in $K^0$ System                                   |
| October 16   | Maury Tigner, SSC                                     | SSC—Where are we now?   |
| October 23   | Lynn Stevenson, LBL                                   | The HERA Workshop at Genoa  |
| November 1   | Michael Chanowitz, LBL                                | Resonances in photon-photon scattering  |
| November 6   | Elliott Bloom, SLAC                                   | Recent Results from the Crystal Ball  |
| November 8   | Michael Panter, CERN                                  | The High Density Projection Chamber for the Delphi Experiment at LEP                  |

| DATE          | SPEAKER                                   | SUBJECT   |
|---------------|---|---|
| November 15   | Ian Hinchliffe, LBL                       | SSC Physics: Is There Life After EHLQ?  |
| November 20   | Willy Langeveld, SLAC                     | Resonance Formation In Two-Photon Collisions  |
| November 29   | Pavel Rehak, Brookhaven                   | Performance of a Silicon Drift Chamber  |
| December 18   | Larry Gladney, SLAC                       | $D\bar{0}$ and $D^+$ Lifetime Measurements from the Mark II   |
| December 20   | Gunter Wolf, DESY/SLAC                    | Physics at HERA   |
| <b>(1985)</b> |   |   |
| January 15    | J. William Gary, LBL                      | Tests of Models for Parton Fragmentation in $e^+e^-$ Annihilations                                      |
| January 24    | Geoffrey Chew, LBL                        | Prediction of a Fourth Charged Lepton and 8 "Horizontal" Neutral Scalar Bosons with Masses $\sim 1$ TeV |
| January 31    | Don Morris, LBL                           | A Practical Detector for Relic Axions from the Early Universe   |
| February 7    | Riley Newman, UC-Irvine                   | Particle Physics with a Torsion Balance   |
| February 14   | Michael Barnett, LBL                      | The UA1 Monojets and Supersymmetry: A Comprehensive Study   |
| February 19   | Christoph Grab, U. of Zurich              | Search for the Decay $\mu^+ \rightarrow e^+e^+e^-$  |
| February 21   | Miklos Gyulassy, LBL                      | The Minibang with Nuclear Colliders   |
| February 26   | Keith Olive, Fermilab                     | Supersymmetry and Cosmology   |
| March 14      | Fred Gilman, SLAC                         | The Higgs Boson at the SSC, CP Violation, and All That  |
| March 21      | W.S. Gilbert, LBL, and J.M. Peterson, URA | Magnet Designs for SSC  |
| March 26      | Bernard Sadoulet, UCB/CERN                | Prospects for Gas Scintillation Techniques in High Energy Physics                                       |
| March 28      | Tom Elioff, URA/CDG, and W.A. Wenzel, LBL | Site Search for SSC   |
| April 2       | Frank Wilczek, UC-Santa Barbara           | Going After Axions  |

| DATE     | SPEAKER                                   | SUBJECT   |
|----------|---|---|
| April 4  | Michael Barnett and Gerson Goldhaber, LBL | Report on the Moriond Conferences   |
| April 11 | Gary Feldman, SLAC                        | Searching for Z Decays at PEP   |
| April 16 | Stu Loken, LBL                            | How to tell Which Ones are the Muons....at the SSC  |
| April 18 | Marjorie Shapiro                          | What do we Know About Quark Confinement? Results from the TPC Detector  |
| April 25 | John LoSecco, Caltech                     | Latest Results on Proton Decay  |
| May 2    | Jackson Laslett, LBL                      | Stochasticity in Orbit Dynamics   |
| May 3    | Marcel Banner, CEN-Saclay                 | Latest UA2 Results  |
| May 9    | Alan Bross, LBL                           | Progress in Detector Research and Development—The Crystal Cave or “Are We Having Fun Yet?”  |
| May 16   | Eric Wicklund, U. of Wisconsin            | Inclusive Electron Production from Heavy Quark Decay and Inclusive $\pi^0$ Production—Results from Tasso Liquid Argon Calorimeter |
| June 20  | Tom Gottschalk, Caltech                   | Issues in Event Simulation for High Energy Hadron Colliders   |

10/8

19 40924  
18-80 3830  
18-85

This report was done with support from the Department of Energy. Any conclusions or opinions expressed in this report represent solely those of the author(s) and not necessarily those of The Regents of the University of California, the Lawrence Berkeley Laboratory or the Department of Energy.

Reference to a company or product name does not imply approval or recommendation of the product by the University of California or the U.S. Department of Energy to the exclusion of others that may be suitable.

LAWRENCE BERKELEY LABORATORY  
TECHNICAL INFORMATION DEPARTMENT  
UNIVERSITY OF CALIFORNIA  
BERKELEY, CALIFORNIA 94720