

Visibility Laboratory
University of California
Scripps Institution of Oceanography
San Diego 52, California

A GENERAL THEORY OF PERTURBED LIGHT FIELDS,
WITH APPLICATIONS TO FORWARD SCATTERING EFFECTS
IN BEAM TRANSMITTANCE MEASUREMENTS

R. W. Preisendorfer

1 May 1958
Index Number NS 714-100

Bureau of Ships
Contract NObs-72092

SIO REFERENCE 58-37

Approved:

Seibert Q. Duntley
Seibert Q. Duntley, Director
Visibility Laboratory

Approved for Distribution:

Roger Revelle
Roger Revelle, Director
Scripps Institution of Oceanogra

A General Theory of Perturbed Light Fields, With Applications to
Forward Scattering Effects in Beam Transmittance Measurements*

Rudolph W. Preisendorfer

Scripps Institution of Oceanography, University of California

La Jolla, California

ABSTRACT

The problem of the measurement of the optical properties of a given medium is complicated by the fact that the act of measurement perturbs the distribution of radiant flux in the immediate vicinity of the measuring process. Consequently, the numbers derived from a measurement process do not faithfully reflect the inherent optical properties of the medium under study, but rather contain along with the information sought both the effects of the presence of the measuring apparatus and its characteristic response to radiant flux. The present note contains a general formulation of the equation of transfer for perturbed radiance field in an arbitrary optical medium. The resultant theory is applied to the problem of the measurement of the volume attenuation function α (or, equivalently, beam transmittance) in natural waters and the atmosphere.

In particular, the theory leads to several new measuring techniques for α which take into account the perturbation effect on the light field of the standard measuring apparatus used for the determination of α . In addition, the theory provides a means of estimating the relatively elusive forward

*Contribution from the Scripps Institution of Oceanography, New Series No. _____. This paper represents results of research which has been supported by the Bureau of Ships, U. S. Navy.

scattering value, σ_0 , of the volume scattering function σ . Finally, two criteria are given for estimating the order of magnitude of the forward scattering effects encountered in beam transmittance measurements.

INTRODUCTION

It is a cardinal axiom of experimental physics that the act of observing a given phenomenon necessarily disturbs the phenomenon under observation. It follows that the "true" nature of the observed is irreversibly obscured by some such disturbance generated by the observer. This axiom holds in particular in the field of experimental radiative transfer. An important illustration of this is afforded by the experimental procedures followed in the determination of the volume attenuation function α . By way of introduction to the present approach, the classical procedures for finding α will be briefly outlined. The general theory of a perturbed light field is then formulated and applied to the case of the determination of α , which results in the perturbed light field counterparts to the classical procedures. The theory yields five distinct approaches to the problem of the determination of α each of which may be transformed into an experimental procedure.

The classical procedures for determining α assume that the light field is unperturbed as the probing for the relevant information goes on. By ignoring the perturbations the investigator is rewarded with analytical formulations of ohm-law simplicity. The price for this is paid by having the resulting prediction curve pass unconcernedly through an array of non-conformist data points. The two main techniques now in use may be classified as the bright-target and dark-target techniques.

Figure 1 depicts the essential geometrical elements of each technique. In the bright-target technique, T is a self-luminous target viewed by a Gershun tube (radiance meter) G at a distance r. It is assumed that the target is angularly small -- in fact, of zero solid angular subtense -- when viewed at each point of the path P between T and G. In addition, the effect of the ambient light field is removed by either a direct shielding of P from its surrounds or by taking the difference of the G-readings found by turning T on and then off. The assumption is made that this on-off procedure does not perturb the ambient light field. Finally, G is assumed to be an ideal collector: any flux entering G and not on P is not recorded. All these assumptions combine to reduce the general equation of transfer:

$$dN/dr = -\alpha N + N_* \quad (1)$$

to the particularly simple form

$$dN/dr = -\alpha N$$

for the radiance along P. Thus if N_o and N_r are the inherent and apparent radiances of T along P, then the operation,

$$-\frac{1}{r} \ln \frac{N_r}{N_o} = \alpha \quad (2)$$

on the measurable quantities r, N_r , N_o is taken to yield the required value of α .

The dark-target approach, on the other hand, assigns zero inherent radiance to T. The same assumptions adopted above remain in force. In addition, P is chosen so that N_* is constant along P. The solution of (1) leads to the following operation,

$$-\frac{1}{r} \ln \frac{N_g - N_r}{N_g} = \alpha$$

(3)

on the measurable quantities $N_q = N_*/\alpha$, N_r , and r , and is taken to yield the required value of α .

GENERAL REPRESENTATION OF A PERTURBED LIGHT FIELD

In actuality, the placing of a target T of inherent radiance N_c in the light field perturbs the light field. Further, the target being a material object occupies a finite volume of space so that it fills a finite subregion $\Xi_t(r')$ of direction space Ξ as viewed at each distance r' on P. From this vantage point, the presence of T causes a perturbation extending over a subset $\Xi_p(r')$ of Ξ . Finally, the Gershun tube, being a material object of finite dimensions, will also contribute its share to the perturbation and, in addition, will record flux entering G which is not strict on P; the collection of such directions which carry acceptable flux will be denoted in general by $\Xi_g(r')$.

With these observations in mind, the general equation of transfer is transformed to the following exact form for the new context:

$$\begin{aligned} \frac{dN'(r', \underline{\xi})}{dr'} = & -\alpha(r') N'(r', \underline{\xi}) + N'(r', \underline{\xi}) \int_{\Xi_g(r')} \sigma(r'; \underline{\xi}; \underline{\xi}') d\Omega(\underline{\xi}') \\ & + \int_{\Xi_p(r')} N(r', \underline{\xi}') \sigma(r'; \underline{\xi}'; \underline{\xi}) d\Omega(\underline{\xi}') \\ & + \int_{\Xi_p(r')} N'(r', \underline{\xi}') \sigma(r'; \underline{\xi}'; \underline{\xi}) d\Omega(\underline{\xi}'). \end{aligned}$$

Here, and in the sequel, the symbols N' , N denote the perturbed and unperturbed radiance functions respectively. The equation may be rewritten more compactly as

$$\begin{aligned} \frac{dN'(r', \underline{\xi})}{dr'} = & -\alpha'(r') N'(r', \underline{\xi}) \\ & + \int_{\Xi_p(r')} [N'(r', \underline{\xi}') - N(r', \underline{\xi}')] \sigma(r'; \underline{\xi}'; \underline{\xi}) d\Omega(\underline{\xi}') \\ & + N_*(r', \underline{\xi}), \end{aligned} \tag{4}$$

where

$$\alpha'(r') = \alpha(r') - \int_{\Xi_g(r')} \sigma(r'; \underline{\xi}; \underline{\xi}') d\Omega(\underline{\xi}'),$$

and

$$N_*(r', \underline{\xi}) = \int_{\Xi_p} N(r', \underline{\xi}') \sigma(r'; \underline{\xi}'; \underline{\xi}) d\Omega(\underline{\xi}').$$

This is the general equation of transfer for a perturbed light field.

Its domain of applicability is quite wide. The notion of Gershun tube is here intended to cover all types of radiance detectors, including such organi

detectors as human eyes. Since all material radiance detectors occupy finite regions in space, they always give rise to a perturbed α , namely the α' of (4). In view of this fact one can raise the question: is it meaningful to talk about a "true α " in practical contexts? Any operational procedure designed to determine the α of a medium must necessarily be made through the intermediation of a physical recording apparatus. It is, therefore, meaningless to talk or think only about the α' for that instrument, or collection of α' values relative to a given collection of radiance detectors. The "true α " is therefore a constitutive rather than an operational definition, a useful fiction about which one may conveniently cluster for reference the operational obtainable α' values.

The problem of the determination of α is intimately connected with the determination of the forward scattering values $\sigma_0(r') = \sigma(r'; \frac{1}{2}; \frac{1}{2})$ of the volume scattering function σ . Here again the physical limitations of the relevant instruments, in this case the nephelometers, prevent an exact determination of $\sigma_0(r')$. Even if the instrument could, by some clever ruse, be forced to look directly down the path to the primary source, what principle will allow the separation of the so-called forward scattered flux from the unscattered, transmitted flux? This raises the question: is such an attempted separation meaningful in practice? The answer, clearly, is that it is not. But yet, even with strict experimental justification absent, there appears to be some unavoidable compulsion to conceptually decompose the forward flux. The motivation for such a procedure is apparently an esthetic requirement: one in which the gap in the experimental definition of the σ function be closed by the inclusion of the values $\sigma_0(r')$

The desirability of obtaining α and σ stems from the fact that they are important constitutive constructs which help bring order and completeness into the classification and theoretical study of turbid media. It is with this in mind that the hunt for α and σ_0 is carried out in the sequel.

From the preceding observations, it is seen that even on a phenomenological (or macroscopic) level, the study of light is beset by limitations on the exact experimental determinations of the three basic notions: N , α and σ . The seeming indeterminacy of N may be side-stepped in principle by defining N operationally as the apparent limit of a sequence $\{N_n\}$ of radiance functions given by a sequence of radiance meters which approaches a limit the ideal ($\Omega_g = 0$) radiance meter. The values of α and σ_0 however, are more elusive; their operational definitions are subject, in the sense explained above, to a more fundamental difficulty. Some ways in which this difficulty can be overcome on a practical level are considered below.

LINEARIZED REPRESENTATION OF SLIGHTLY PERTURBED LIGHT FIELDS

As an illustration of the use of the general representation of a perturbed light field, we reconsider the problem of experimentally determining the volume attenuation function α . The discussions which follow apply to arbitrary optical media, e.g., natural hydrosols or aerosols. The equipment used in the classical procedures have been designed so as to minimize, within reasonable limits, the induced perturbations. As a result, relatively small (but yet detectable) perturbations are encountered. A useful feature of these slight perturbations is that they may be represented by certain linearization conditions imposed on the general structure of (4). We assemble the three conditions for a linearly perturbed light field below:

(i) The functions $\sigma(r'; \xi; \cdot)$ and $\sigma(r'; \cdot; \xi)$ are constant over $\Xi_3(r')$ and $\Xi_t(r')$, respectively, for each r' , $0 \leq r' \leq r$. Both have the fixed value $\sigma_0 \equiv \sigma(r'; \xi; \xi)$.

(ii) $N'(r', \cdot)$ and $N(r', \cdot)$ are constant functions over $\Xi_p(r')$ for each r' , $0 \leq r' \leq r$, the fixed values will be denoted by $N'(r')$ and $N(r')$ respectively.

(iii) $\Xi_p(r') = \Xi_t(r')$ for each r' , $0 \leq r' \leq r$.

Under these assumptions the general equation (4) is transformed into the following relatively simple structure:

$$\frac{dN'(r')}{dr'} = [-\alpha + \sigma_0(\Omega_3(r') + \Omega_t(r'))] N'(r') - N(r') \sigma_0 \Omega_t(r') + N_*(r')$$

where $\Omega_3(r') = \int_{\Xi_3(r')} d\Omega(\xi)$, $\Omega_t(r') = \int_{\Xi_t(r')} d\Omega(\xi)$,

the general solution of which is readily obtained:

$$N'(r) = T_r' N'(0) + (T_r')^{-1} \int_0^r [N_*(r') - \sigma_0 \Omega_t(r') N(r')] T_r' dr', \quad (6)$$

$$T_r' = \exp \left\{ -\alpha r' + \sigma_0 \left[\int_0^{r'} \Omega_3(r'') dr'' + \int_0^{r'} \Omega_t(r'') dr'' \right] \right\}. \quad (7)$$

The resulting formulations point the way to several novel measuring techniques for α . While the formulations are admittedly approximate in the sense made clear above, they take due cognizance of the major features of a perturbed

light field and the non-ideal character of real Gershun tubes. In this way an essential advance beyond the classical procedures seems possible. Despite the simplified character of the linear theory, its resultant formulations lie just on this side of practical utility. That is to say, within the present experimental framework, the slightest relaxation of the linearizing condition pushes the resultant theory beyond the borderline of reasonable tractability. However, this observation must be qualified when it comes to using more general approximations based on (4) as a theoretical tool.

APPLICATIONS

Bright-Target Technique

For the case of the bright-target technique, (6) takes a particularly simple form which is based on the following considerations: (i) The realization of the bright-target technique in practice is in the form of a so-called α -meter (a beam-transmittance meter) which consists essentially in the optical system depicted in Figure 2. The most important feature for the present discussion is the condition $\Omega_j(r') = \Omega_t(r')$ which this optical system imposes on the two solid angles defined in the general theory. This follows from the effective placement of the source at the focal point of lens A so that the source is essentially imaged on lens B. Thus the solid angle $\Omega_j(r')$ (or $\Omega_t(r')$) is necessarily the solid angle subtended by the farthest lens from the point r' . (ii) The path P between A and B has been designed so as to be shielded from the surrounding natural light field. From this, it follows that $N_*(r') = N(r') = 0$ on P. With these observations, (6) reduces to

$$N'(r) = T_r' N'(0),$$

so that

$$N'(r)/N'(0) = T_r' = \exp \left\{ -\alpha r + 2\pi\sigma_0 \phi(r) \right\} \quad (8)$$

where

$$\phi(r) = 2 \left[\frac{r}{2} - (a^2 + r^2)^{\frac{1}{2}} + (a^2 + (\frac{r}{2})^2)^{\frac{1}{2}} \right],$$

and where a is the common radius of lenses A and B. For ratios $a/r < 1/10$ (8) may be usefully represented by the approximation

$$T_r' = \exp \left\{ -\alpha r + 2\pi\sigma_0 \frac{a^2}{r} \right\} \quad (9)$$

Either (8) or (9) show that the perturbation of the light field leads in this case to an apparently reduced value of α as measured by the instrument, e.g., from (9):

$$\alpha' = \alpha - 2\pi\sigma_0 \left(\frac{a}{r} \right)^2.$$

An apparent reduction of α will also be found in the dark-target case. In fact, the general equation for the perturbed light field shows that this apparent decrease in α is a universal manifestation traceable directly to the simple fact that for all material Gershun tubes, and all material targets, $\Omega_g(r)$ and $\Omega_t(r)$ are greater than zero.

Dark-Target Technique

In this case the path is chosen so that N_* and N are constant over its extent. In fact, we set $N_g = N_*/\alpha = N$, and $N'(0) = 0$. $\Omega_t(r)$ and Ω_g' are no longer rigidly coupled as in the bright-target case, but now assume the forms:

$$\Omega_t(r') = 2\pi \left(1 - \frac{r'}{(a^2 + r'^2)^{\frac{1}{2}}} \right),$$

$$\Omega_g(r') = 2\pi \left(1 - \frac{(r - r')}{(b^2 + (r - r')^2)^{\frac{1}{2}}} \right),$$

governed by obvious geometrical requirements. Here a , and b are the radii of the target, and photosensitive collecting disk in the Gershun tube, respectively.

Under these conditions, (7) becomes

$$T_r' = \exp \left\{ -\alpha r' + 2\pi\sigma_0 \phi(r, r') \right\}, \quad (10)$$

where

$$\phi(r, r') = 2(r - r') + b - (b^2 + (r - r')^2)^{\frac{1}{2}} - (a^2 + r'^2)^{\frac{1}{2}} + (a^2 + r'^2)^{\frac{1}{2}}, \quad (11)$$

and (6) becomes

$$N'(r) = N_g (T_r')^{-1} \int_0^r [\alpha - \sigma_0 \Omega_t(r')] T_r' dr'. \quad (12)$$

The chore of carrying out the integration of (12) can be considerably reduced, and the utility of (12) considerably enhanced, if the following approximate representation of $\phi(r, r')$ is adopted:

$$\phi(r, r') = b - \frac{a^2}{2r}, \quad (13)$$

which follows from setting

$$2r' - r = -(b^2 + (r - r')^2)^{\frac{1}{2}} + (a^2 + r'^2)^{\frac{1}{2}},$$

$$(a^2 + r'^2)^{\frac{1}{2}} = r \left[1 + \frac{1}{2} \left(\frac{a}{r} \right)^2 \right]^{\frac{1}{2}}.$$

The justification for this may be illustrated by considering a numerical example in which the quantities have magnitudes which are typical for dark-target experiments. Thus let $a/r = b/l = 1/30$, where $l = 0.30$ meters is the length of the Gershun tube, and $r = 10.70$ meters. The graphs of Figure 3 show a plot of $2r' - r$ and the graph it is to approximate.

By means of (13), the form for $N'(r)$ becomes:

$$N'(r) = N_0 \exp \left[2\pi\sigma_0 \left(b - \frac{a^2}{2r} \right) \right] \left[(1 - e^{-\alpha r}) - \sigma_0 \int_0^r e^{-\alpha(r-r')} \Omega_+(r') dr' \right],$$

(14)

which is still a formidable analytical haystack from which one must extract α and σ_0 . Some ways in which this may be done will now be considered.

An Outline of Possible Experimental Procedures

If σ_0 is known and α is sought:

Experiment 1. Single use of an α -meter.

Experiment 2. Single dark-target experiment.

If both α and σ_0 are sought:

Experiment 3. Two α -meters used simultaneously.

Experiment 4. Two dark-target experiments conducted simultaneously.

Experiment 5. Simultaneous α -meter and dark-target experiments.

We consider each experiment in turn, but outline only the principle analytical steps required in each case.

Experiment 1. The procedure is straightforward: Knowledge of $N'(r)/N'(0)$ and σ_0 allows an immediate estimate of α from (8), or (9). Foreknowledge of σ_0 may be obtained by using the σ -recovery method.¹

Experiment 2. Equation (14) may be written as

$$N'(r) = F(\alpha, a, b, r; \sigma_0)$$

The function F has α as main argument, with $a, b, r,$ and σ_0 as parameters fixed by during a given experiment. It is therefore possible to plot the values $F(\alpha, a, b, r, \sigma_0)$ (Figure 4 (a)) from which the α may in principle be found.

Experiment 3. Suppose two α -meters, each of having a distinct ϕ -function (equation (8)), simultaneously measure beam transmittance in a given medium. Then, if $\phi_1, \phi_2; r_1, r_2;$ and T'_{r_1}, T'_{r_2} , represent the appropriate quantities of each instrument, the two equations for α and σ_0

$$T'_{r_i} = \exp\{-\alpha r_i + 2\pi\sigma_0 \phi_i\}, \quad i=1,2,$$

have the solutions

$$\sigma_0 = (r_2 \ln T'_{r_1} - r_1 \ln T'_{r_2}) / 2\pi (r_2 \phi_1 - r_1 \phi_2),$$

$$\alpha = (\phi_2 \ln T'_{r_1} - \phi_1 \ln T'_{r_2}) / (r_2 \phi_1 - r_1 \phi_2).$$

¹ Preisendorfer, R. W., A New Method for the Determination of the Volume Scatter Function, Visibility Laboratory report, Index Number NS 714-100, Contract N0bs-50274, Scripps Institution of Oceanography, (March, 1956).

Experiment 4. Equation (14) is the basis for this experiment. The general idea is to obtain two readings of $N'(t)$ from two distinct geometrical arrangements, and then solve two simultaneous equations for α and σ_0 . No simple closed expressions for α and σ_0 may be obtained as in Experiment 3. Recourse to numerical solutions is the only way out. The numerical procedure will be considerably simplified if each geometrical arrangement is so made that $b - (a^2/2r) = 0$. This may be done in the following way. Let l and b be the effective length and radius of the Gershun tube. Then the radius a of the dark-target is given by $a = rbk/l$, where $k \geq 1$ (i.e., k insures the fulfillment of the condition that the target must at least fill the field of the Gershun tube). Then the condition $b - (a^2/2r) = 0$ requires that the range of the target be $r = 2l^2/bk^2$.

In illustration, let $b/l = 1/30$, $l = 0.30$ meters. Choose two k -values, $k_1 = \sqrt{2}$, $k_2 = 2$. These numbers now fix a and r for each choice of k :

$$r_1 = 2l^2/bk_1^2 = 9.00 \text{ meters}$$

$$a_1 = r_1 b k_1 / l = 0.423 \text{ meters}$$

$$r_2 = 4.50 \text{ meters}$$

$$a_2 = 0.300 \text{ meters.}$$

Now returning to (14) in which $b - (a^2/2r) = 0$, we have for two such experimental arrangements:

$$C(r_1) = (N_g - N'(r_1))/N_g = e^{-\alpha r_1} + \sigma_0 I(\alpha, a_1, r_1)$$

$$C(r_2) = (N_g - N'(r_2))/N_g = e^{-\alpha r_2} + \sigma_0 I(\alpha, a_2, r_2),$$

where $I(\alpha, a_i, r_i) = \int_0^{r_i} e^{-\alpha(r_i - r')} \Omega_t(r') dr'$. This set of equations may be rearranged to read:

$$A(\alpha) \equiv \frac{C(r_2) - e^{-\alpha r_2}}{C(r_1) - e^{-\alpha r_1}} = \frac{I(\alpha, a_2, r_2)}{I(\alpha, a_1, r_1)} \equiv B(\alpha).$$

Each side represents a computable function of α (the a_i and r_i being known and fixed during the experiment). Hence both A and B can be graphed over a certain domain of α values. If the curves are graphed over the same set of axes (Figure 4 (b)) the point of intersection of the graphs defines the required α . (The graph of Figure 4 merely represents the idea of this solution procedure; it need not represent an actual set of A and B graphs).

Experiment 5. Equations (8) and (14) are the basis for this experiment. Equation (8) is solved for σ_0 and the resultant expression for σ_0 is substituted in (14). After this is done, the remaining procedure is in principle covered by the analytical steps outlined for experiment 2.

Order of Magnitude Estimates

A given bright-or-dark-target set up can be given a quick preliminary analysis by means of equations which approximate (8) and (14). The appropriate equation for (8) is given by (9). Turning to (14), we see that a lower bound on the σ_0 -effect may be obtained by setting $\Omega_t(r') = \Omega_t(r)$ so that (14) reduces to

$$N'(t) = N_0 \exp \left[2\pi\sigma_0 \left(b - \frac{a^2}{2r} \right) \right] (1 - e^{-\alpha t}) \left[1 - \frac{\pi\sigma_0}{\alpha} \left(\frac{a}{r} \right)^2 \right]. \quad (16)$$

Thus if (16) predicts a measurable deviation from the unperturbed radiance $N_0(1 - e^{-\alpha t})$, the actual σ_0 -effect produces an even greater deviation (an illustration is given below). Unfortunately, a correspondingly good upper bound is not found in such a simple way, so that no general bracketing expression

can be simply given for $N'(r)$ in the dark-target case. Each problem is best handled separately using (14).

From the preceding analyses it is evident that the α -meter technique appears to be the more simple to handle analytically. From (9) one can estimate the percent difference between α and α' :

$$\Delta = 100 \times \frac{\alpha' - \alpha}{\alpha} = -100 \times \frac{2\pi\sigma_0}{\alpha} \left(\frac{a}{r}\right)^2, \quad (17)$$

the minus sign denoting that α is always less than α' .

To gain a rough idea of the order of magnitude of the forward scattering effect in a typical hydrosol and aerosol, we choose for the hydrosol: $\sigma_0 = 1.4$ meter steradian, $\alpha = 0.402/\text{meter}$ *; and for the aerosol, $\sigma_0 = 9 \times 10^{-4}/\text{meter-steradian}$, $\alpha = 32 \times 10^{-5}/\text{meter}$ ** . The corresponding values of Δ for a set of α -meters (characterized by their a/r ratios) are given below.

a/r	- Δ (in percent)	
	Aerosol	Hydrosol
1/200	0.044	0.075
1/100	0.176	0.300
1/50	0.704	1.20
1/25	2.82	4.80
1/12.5	11.3	19.2

*The α and σ_0 are associated with a wavelength of 478 m μ ; α and σ_0 are based on measurements taken by J. E. Tyler in Lake Pend Oreille, and are representative of moderately clear lake and near-shore ocean water. Depending on the medium, the ratio σ_0/α may range over an order of magnitude. σ_0 was estimated using the method of reference 1.

**Based on Waldram's data for industrial haze, as recorded in Middleton, W.E.K. Vision Through the Atmosphere, (Univ. of Toronto Press, 1952), p. 48. σ_0/α of clear air is on the order of a seventh of that for industrial haze. The associated wavelength is 570 m μ . σ_0 was estimated by extrapolation.

We conclude with an example of the use of (16) for the case of the present hydrosol. Using the set-up suggested in Experiment 4, and observing that the path lengths were chosen so that $b - (a^2/2r) = 0$, we have:

$$N'(r_1) = N_0 e^0 (1 - e^{-\alpha r_1}) (1 - 0.040) = (0.96) N_0 (1 - e^{-\alpha r_1}), \quad r_1 = 4.$$

$$N'(r_2) = N_0 e^0 (1 - e^{-\alpha r_2}) (1 - 0.080) = (0.92) N_0 (1 - e^{-\alpha r_2}), \quad r_2 = 4.$$

It appears that a definitely measurable perturbation of the light field would be induced in the present case. Thus, some radical procedure, such as that outlined in Experiment 4, should be followed in order to obtain an accurate estimate of α .

SUMMARY

The general equation of transfer for an arbitrarily perturbed light field is formulated (equation (4)). From this is deduced the linearized equation of transfer (5) which is applicable to the study of slightly perturbed light fields such as those induced during the measurement of the volume scattering function or (beam transmittance) by means of the bright-or-dark-target techniques. The general solution (equations (6), (7)) of the linearized equation leads to analytical expressions which may be used to estimate the true value of α when either the bright target approach (equation (8)) or the dark target approach (equation (14)) is used. The general solution of the linearized equation yields in particular five possible experimental procedures leading to an estimate of α . Finally, two methods are given (equations (16), (17)) for estimating the order of magnitude of the forward scattering effects encountered in beam transmittance measurements.

CAPTIONS

Figure 1. Illustrating the geometry of a perturbed light field. T is a generalized target, G represents a Gershun tube (radiance meter). Both T and G induce a perturbation of the radiance distribution about a point F on the path P. In the general case, T need not be on the axis of G. The subregions of direction-space \cong about p which are occupied by the target, the Gershun tube, and the perturbation, are indicated as shown.

Figure 2. The optical system of a typical α -meter (beam transmittance meter), in particular, one in which $\Omega_1(t') = \Omega_2(t')$.

Figure 3. Illustrating an approximation which simplifies the analytical formulation of the dark-target technique in typical applications.

Figure 4. Illustrating two numerical procedures for determining α .

(a): Experiment 2; (b) Experiment 4; For details, see text.

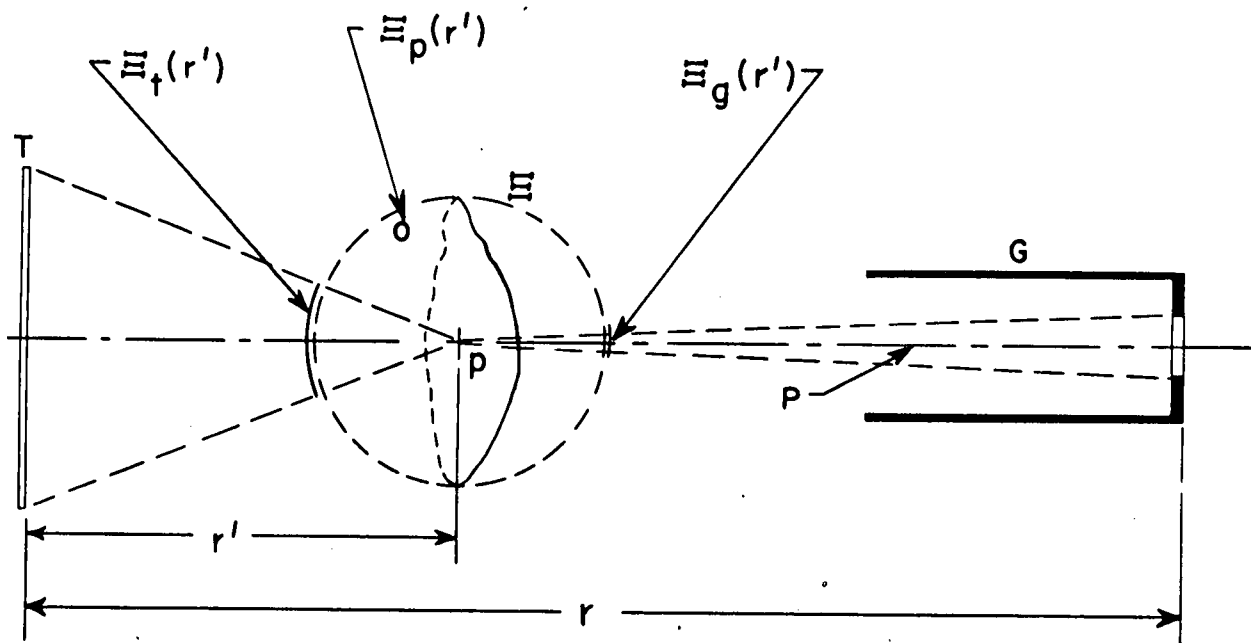

Figure 1

Rudolph W. Preisendorfer

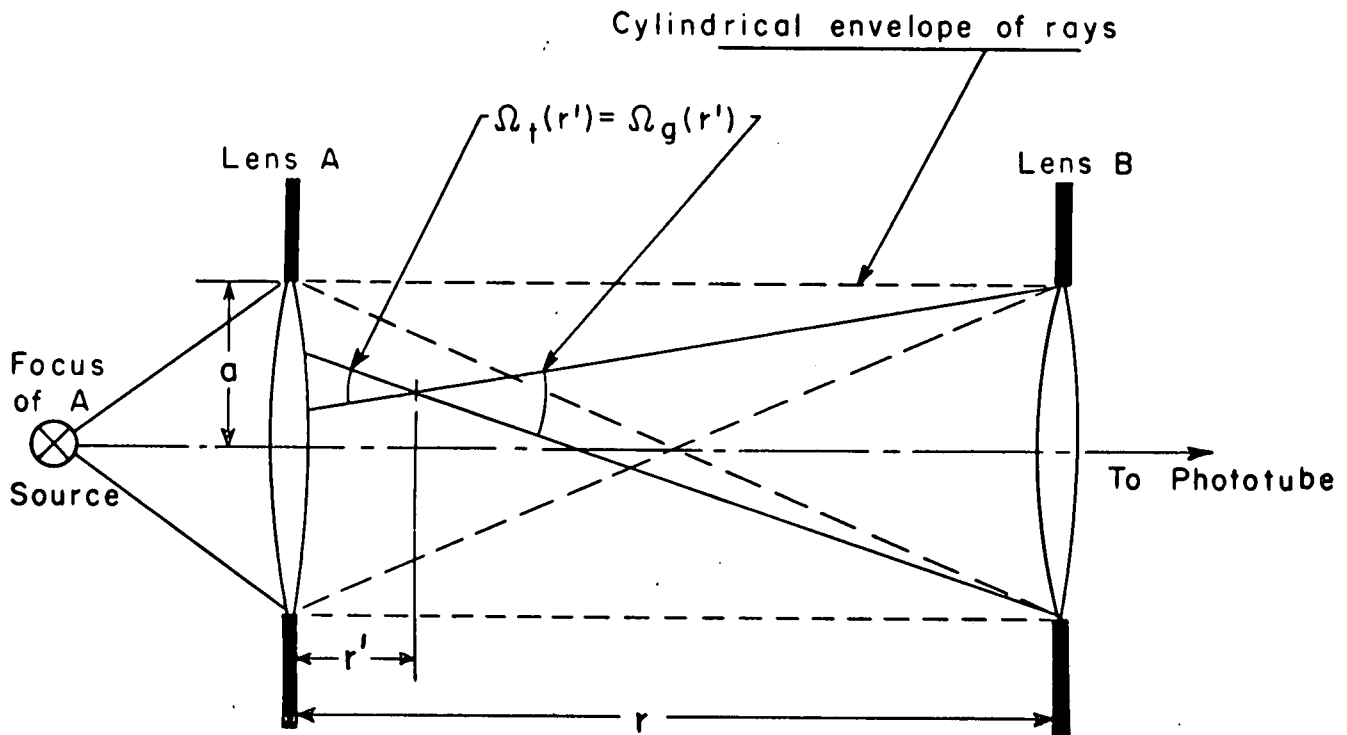

Figure 2

Rudolph W. Preisendorfer

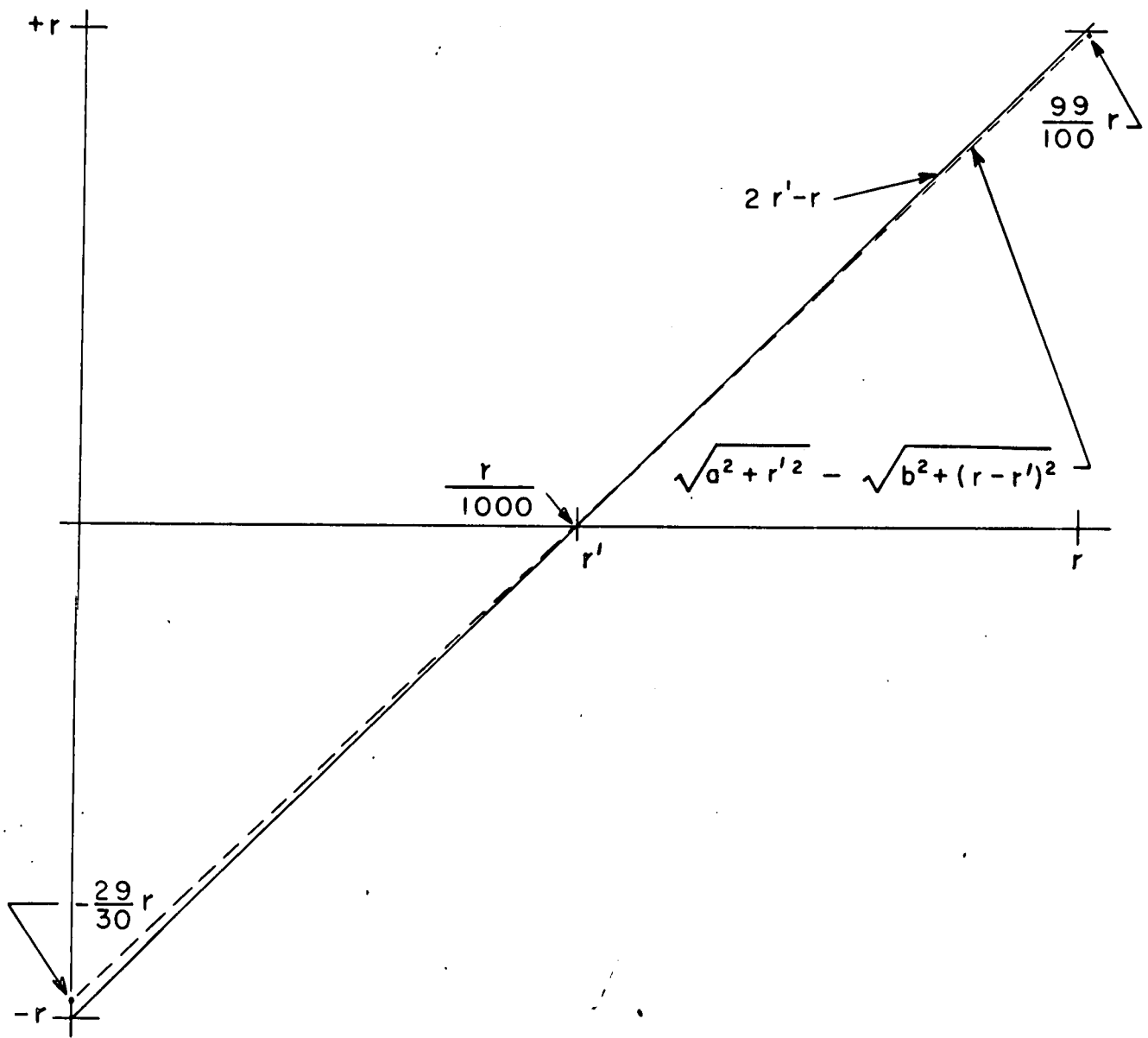

Figure 3

Rudolph W. Preisendorfer

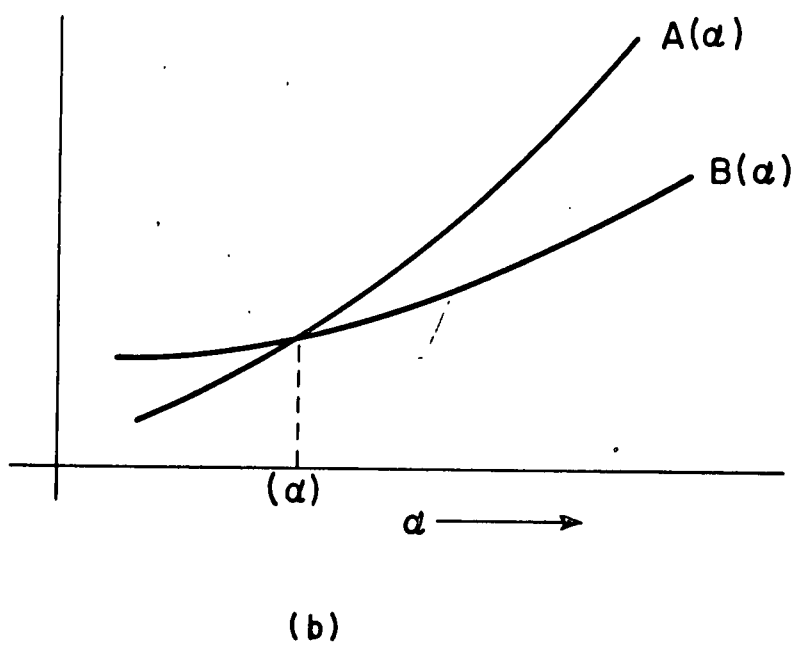
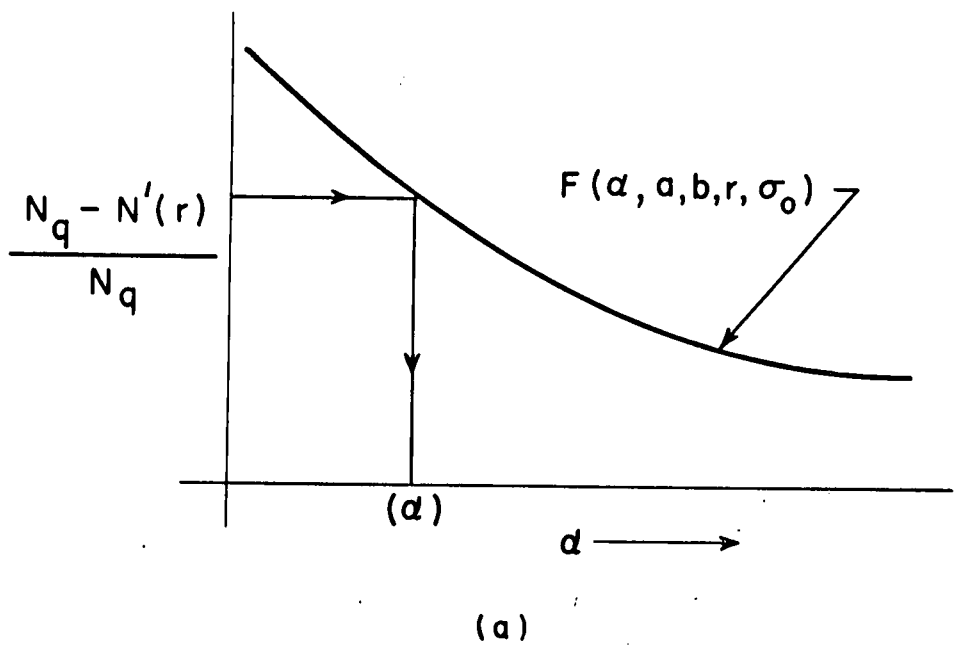
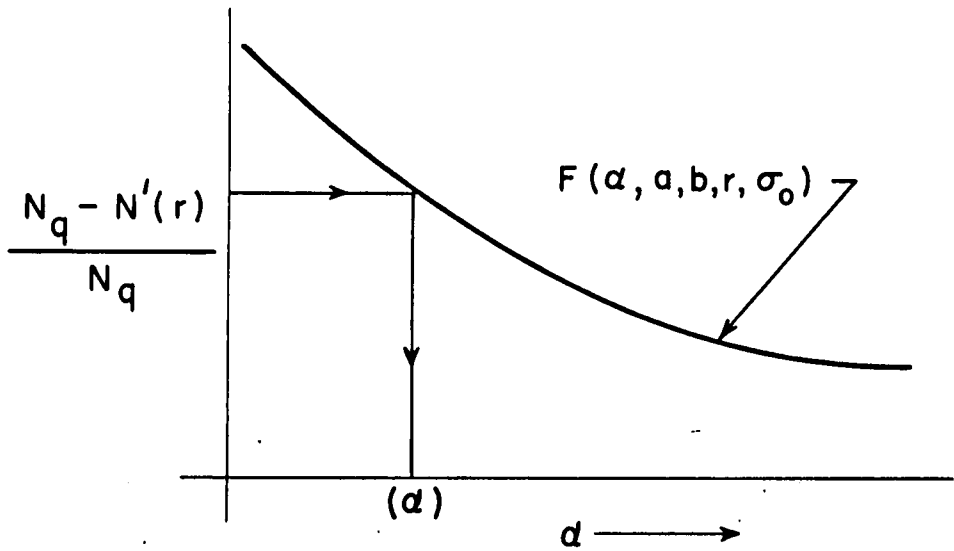
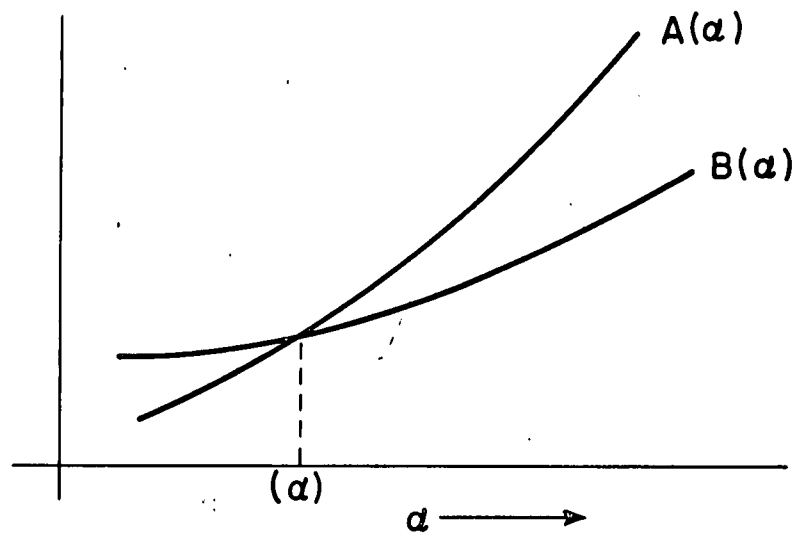

Figure 4

Rudolph W. Preisendorfer



(a)



(b)

Figure 4

Rudolph W. Preisendorfer