

# Lawrence Berkeley National Laboratory

## Lawrence Berkeley National Laboratory

### **Title**

ELECTRICAL PROPERTIES OF ORGANIC SOLIDS. I. KINETICS AND MECHANISM OF CONDUCTIVITY OF METAL-FREE PHTHALOCYANINE

### **Permalink**

<https://escholarship.org/uc/item/9sz86631>

### **Authors**

Tollin, Gordon  
Kearns, David R.  
Calvin, Melvin.

### **Publication Date**

1959-07-29

UNIVERSITY OF  
CALIFORNIA

*Ernest O. Lawrence*

*Radiation  
Laboratory*

TWO-WEEK LOAN COPY

*This is a Library Circulating Copy  
which may be borrowed for two weeks.  
For a personal retention copy, call  
Tech. Info. Division, Ext. 5545*

BERKELEY, CALIFORNIA

UNIVERSITY OF CALIFORNIA  
Lawrence Radiation Laboratory  
Berkeley, California  
Contract No. W-7405-eng-48

ELECTRICAL PROPERTIES OF ORGANIC SOLIDS.  
I. KINETICS AND MECHANISM OF CONDUCTIVITY OF  
METAL-FREE PHTHALOCYANINE

Gordon Tollin, David R. Kearns, and Melvin Calvin

July 29, 1959

ELECTRICAL PROPERTIES OF ORGANIC SOLIDS.  
I. KINETICS AND MECHANISM OF CONDUCTIVITY OF  
METAL-FREE PHTHALOCYANINE

Gordon Tollin, David R. Kearns, and Melvin Calvin

University of California  
Lawrence Radiation Laboratory and Department of Chemistry  
Berkeley, California

July 29, 1959

Abstract

Techniques involving the use of high-intensity short-duration light pulses have been applied to the study of the kinetics of photoconductivity in films of metal-free phthalocyanine. These experiments, in conjunction with measurements of steady-state photoconductivity, are consistent with the following scheme. The principal route for the formation of charge carriers is via the first excited singlet state, although the lowest triplet state can, to some extent, contribute to charge-carrier production. The mobility of the carriers is low and is concentration-dependent, being lower at higher carrier concentration. The decay of the photocurrent is the result of a diffusion-limited bimolecular recombination, with a capture radius of approximately one molecular diameter. The experiments indicate that carriers produced thermally in the dark do not interact with light-produced carriers.

ELECTRICAL PROPERTIES OF ORGANIC SOLIDS.  
I. KINETICS AND MECHANISM OF CONDUCTIVITY OF  
METAL-FREE PHTHALOCYANINE \*†

Gordon Tollin, § David R. Kearns, and Melvin Calvin

University of California  
Lawrence Radiation Laboratory and Department of Chemistry  
Berkeley, California

July 29, 1959

Introduction

Previous work from this laboratory<sup>1</sup> has suggested that the mechanism of quantum conversion in photosynthesis involves processes that are characteristic of ordered arrays of pigment molecules. For this reason, it has seemed important to investigate in detail the electronic properties of these systems. Furthermore, investigations of this nature are of great interest in their own right.

The general properties of organic semiconductors have recently been reviewed by Garrett.<sup>2</sup> It is apparent from this article that, in spite of the large volume of information that has been accumulated, little is known either theoretically or experimentally about the fundamental processes of charge-carrier formation and migration in these systems. Almost all the work in this field has been concerned with steady-state conductivity properties and very little attention has been paid to kinetics, although Nelson<sup>3</sup> has conducted a series of experiments on the kinetics of photoconductivity in solid cationic dyes such as basic fuchsin, rhodamine B, and crystal violet. However, these ionic systems in many ways are different from the nonionic dyes.

For these reasons we felt that an investigation of the kinetics of photoconductivity in nonionic dye molecules would be of interest. Metal-free phthalocyanine was chosen for the study reported here because (a) its properties appear to be typical of this class of substances, (b) a great

---

\* The work described in this paper was sponsored by the United States Atomic Energy Commission.

† A substantial part of the work presented in this paper is the subject of: David R. Kearns, Electric and Magnetic Properties of Organic Molecular Crystals, Ph.D. dissertation, University of California, Berkeley, California, 1959.

§ Present address: Department of Chemistry, University of Arizona, Tucson, Arizona.

<sup>1</sup> G. Tollin, P. B. Sogo, and M. Calvin, *Ann. N. Y. Acad. Sci.* 74, 310 (1958).

<sup>2</sup> C. G. B. Garrett, in *Semiconductors*, ed. by N. B. Hannay, (Rheinhold, New York, 1959), Chap. 15. This article should be referred to for a more complete bibliography.

<sup>3</sup> R. C. Nelson, *J. Chem. Phys.* 22, 885, 890, 892 (1954).

many electrical measurements have been performed on it,<sup>4, 5</sup> and (c) its structure corresponds to the porphyrins, of which class chlorophyll is a member. With this in mind, techniques have been developed which permit the study of the kinetics of photoconductivity in solid organic dye materials.

### Materials and Methods

The material used in the experiments was prepared from crude metal-free phthalocyanine (DuPont) by vacuum sublimation in a muffle furnace. This yielded crystalline material in the form of needles 0.1 to 1 cm in length. The cell used for most of the conductivity measurements is diagrammed in Fig. 1. Additional measurements were also carried out with a sandwich-type cell. The samples were applied to the electrodes by another vacuum sublimation of the crystalline material. Various ambient atmospheres (air, O<sub>2</sub>, natural gas) were used in the sublimations, but the results appeared to be independent of the gas used. Subsequent to the sublimation of the sample, the entire cell was coated with a clear acrylic resin. This coating served merely a protective function and produced no changes in any of the measured properties of the phthalocyanine. For the conductivity measurements, the sample cell was mounted on one end of a copper rod, the temperature of which could be varied. For most of the measurements, field strengths of the order of 10<sup>4</sup>v/cm were used. X-ray diffraction indicated that the sublimed films of phthalocyanine were essentially amorphous. However, the films could be made microcrystalline by annealing the entire cell at 270°C for several days under reduced natural gas pressure. The crystals formed in this manner were about 1 micron in diameter and 10μ long.

Figure 2 shows a block diagram of the apparatus used in these studies. For kinetic studies, the samples were illuminated by a General Electric FT-230 flashtube operated at 1500 with a load capacitance of 2μf. This produced a light pulse with a 1-μsec rise time which decayed to about 10% of its peak intensity in about 5μsec. A standard triggering system was used. The calculated output of this lamp is thus ~10<sup>24</sup> quanta per second per cm<sup>2</sup>, of which 10% may impringe on the sample.

Photocurrent generated in the sample by the light pulse was passed through a known resistance with values ranging from 1000 ohms to 1 megohm, depending upon the experiment. The voltage developed across this resistance was fed through a cathode follower and dc amplified (gain=2000) into the various recording devices. In this manner, it was possible to measure the decay curve of the photocurrent from about 10μsec after flashing to about 100 sec. The photosignal itself was used to trigger the oscilloscope sweep and thus it was also possible to observe the rise time of the photocurrent.

<sup>4</sup>D.D. Eley, G. D. Parfitt, M. J. Perry and D.H. Taysum, Trans. Faraday Soc., 49, 79 (1953).

<sup>5</sup>D.D. Eley and G. D. Parfitt, Trans. Faraday Soc. 51, 1529 (1955).

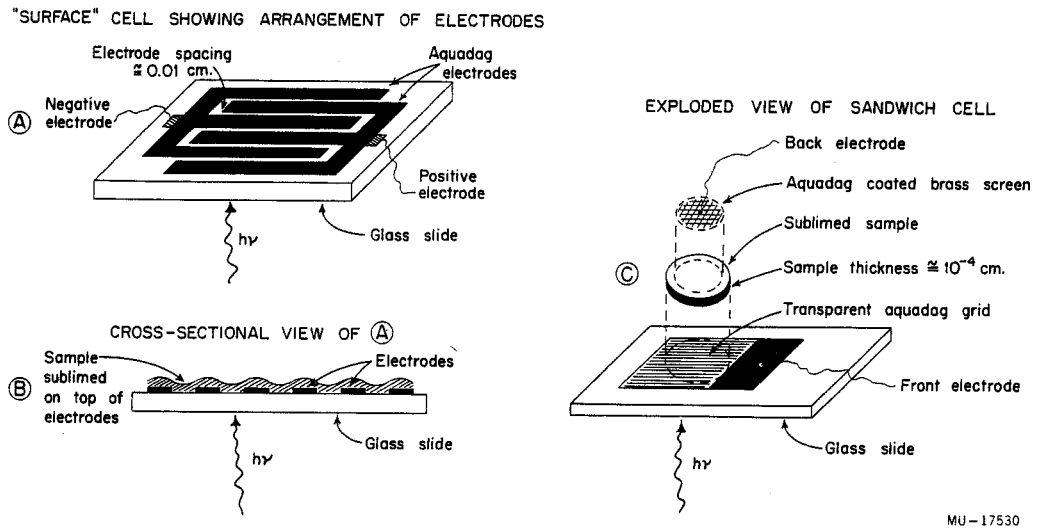
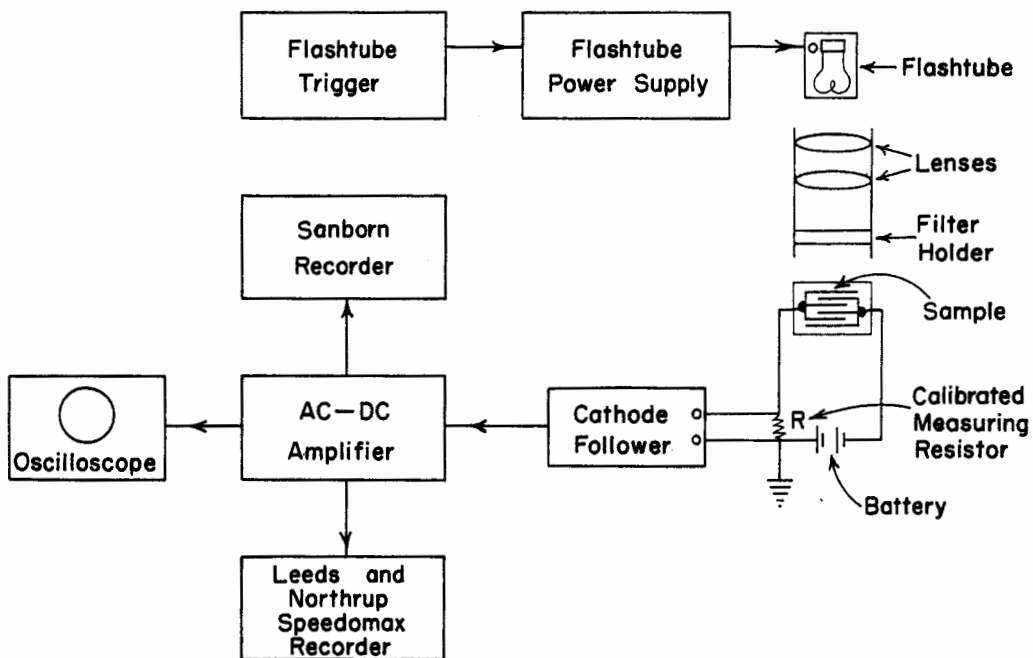

Fig. 1. Diagram of sample cells.



MU-17524

Fig. 2. Block diagram of conductivity apparatus.



For the measurement of action spectra and steady-state photoconductivity, a Hanovia 800-watt xenon arc lamp or a 500-watt tungsten filament projection lamp and a Bausch and Lomb 500-mm grating monochromator were used in place of the flashtube. The impinging visible intensity from these lamps about  $10^{17}$  to  $10^{19}$  quanta per second per  $\text{cm}^2$ .

## Results and Discussion

### 1. Kinetics of Photocurrent Decay

Typical photocurrent decay-curve data are shown in Fig. 3. These were obtained with unannealed metal-free phthalocyanine in the "surface" cell shown in Fig. 1. Unless otherwise stated, all the following results apply to samples of this type. The rise time of the photocurrent in the flash experiments is never less than  $\sim 1 \mu\text{sec}$  even if a neutral filter of 1% transmission is placed between flash light and sample. This indicates that the rise time of the photocurrent is limited by the rise time of the circuitry.

In Fig. 4, log photocurrent  $\left(\frac{i}{e}\right)$  is plotted vs log time (t) for data obtained at  $23^\circ\text{C}$  and at  $-35^\circ\text{C}$ . From these curves it is apparent that the current decay from several hundred microseconds to several seconds obeys the relation

$$I = \frac{i}{e} = c t^y, \quad (1)$$

where  $e$  = electronic charge and  $y = -1/2$  at  $23^\circ\text{C}$  and  $-0.43$  at  $-35^\circ\text{C}$ . This was the general result for all the samples studied under all conditions, with  $y$  varying between  $-0.6$  and  $-0.4$ .

The curves in Fig. 4 also show a break at longer times (greater than 1 sec at  $23^\circ\text{C}$  and greater than 15 sec at  $-35^\circ\text{C}$ ) with  $y$  approaching  $-1$ . If one replots the long-time data, it is possible to show that the curves follow a bimolecular law,

$$1/I = K t + \text{constant}. \quad (2)$$

Such plots are shown in Fig. 5 for both  $23^\circ\text{C}$  and  $-35^\circ\text{C}$ . Thus, at low carrier concentrations the current decay is strictly bimolecular, and at higher carrier concentrations the current decay is slower than bimolecular.

At the shortest times (10 to 100  $\mu\text{sec}$ ), the current decays even more slowly than at the longer times ( $>100 \mu\text{sec}$ ).

The decay law at low current is precisely what one would expect for a process involving the recombination of oppositely charged carriers. The slower decay at the higher currents may be accounted for simply by assuming a concentration-dependent charge-carrier mobility, analagous to what is observed for ion mobilities in solutions of high ionic strength.<sup>6</sup>

<sup>6</sup>W. J. Moore, Physical Chemistry (Prentice-Hall, New York, 1950) p. 451.

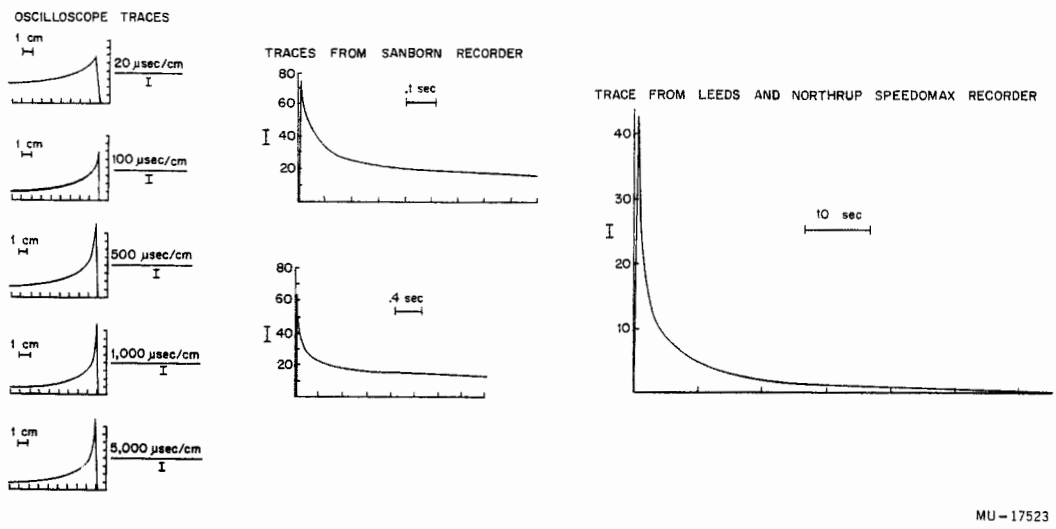

Fig. 3. Typical photoconductivity decay data for metal-free phthalocyanine at room temperature.

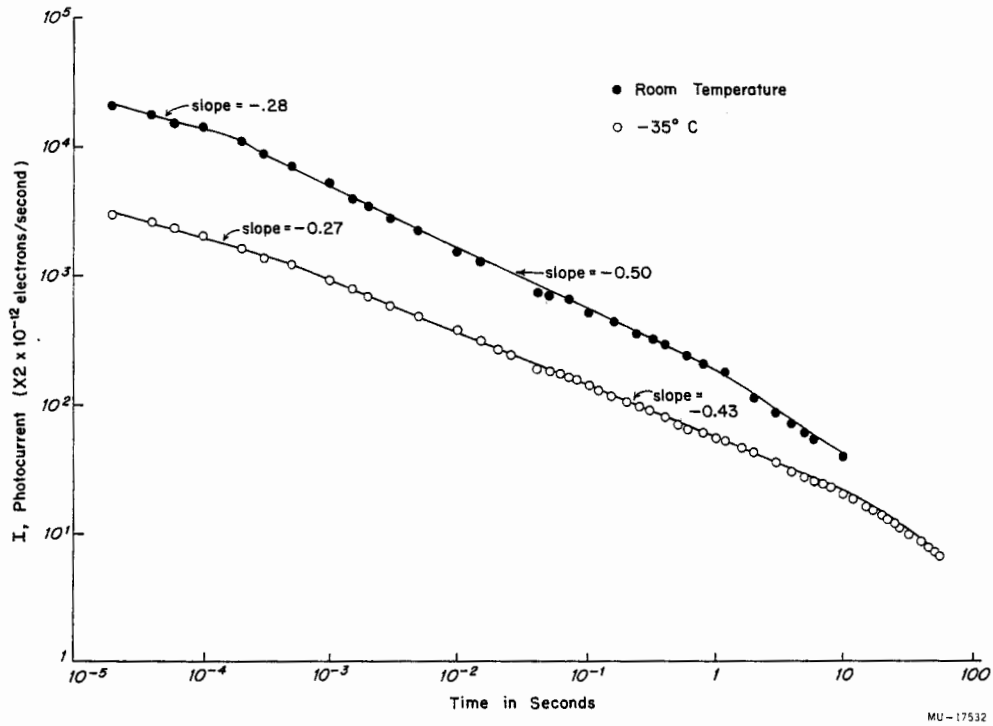

Fig. 4. Log photocurrent versus log time for a metal-free phthalocyanine sample at room temperature and at -35°C.

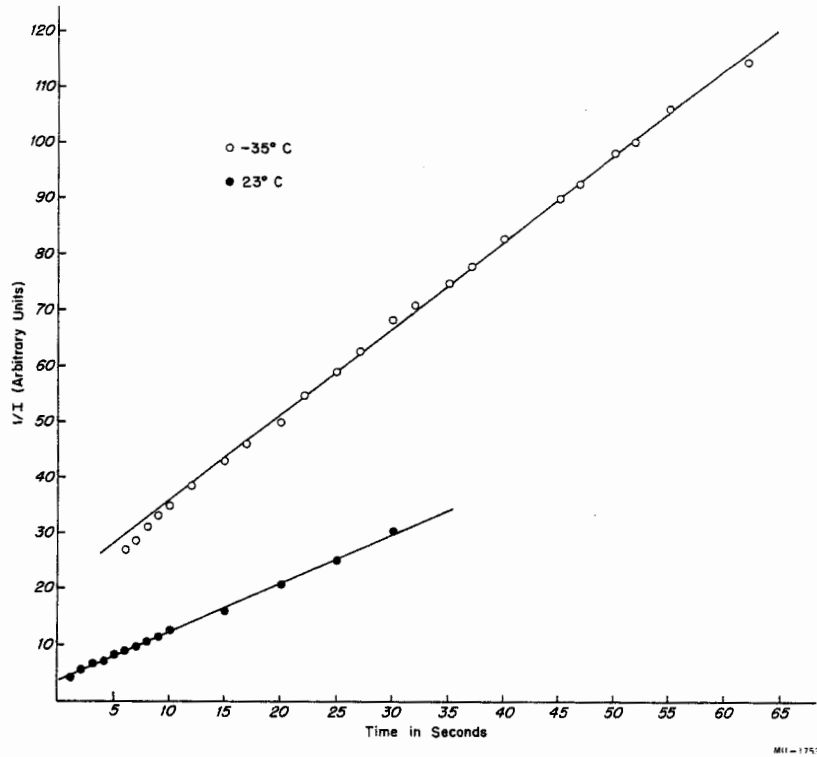

Fig. 5.  $1/I$  versus  $t$  for metal-free phthalocyanine at room temperature and  $-35^{\circ}\text{C}$ .

If one makes the above assumptions, it is possible to obtain an equation which adequately expresses the time dependence of the photocurrent at all except the very earliest times (less than 100  $\mu$ sec). An empirical relation between current,  $I$ , and carrier concentration,  $n$ , which will lead to a satisfactory description of the experimental results is

$$I = \frac{\mu_0}{(n + c)^{1-1/x}} \cdot nAE, \quad (3)$$

where  $n$  = total carrier concentration =  $n_+ + n_-$ ,

$E$  = field strength,

$A$  = cross-sectional area of conducting material,

$$\bar{\mu} = \frac{\mu_0}{(n + c)^{1-1/x}} = \text{apparent average carrier mobility at a particular value of } n,$$

and  $c$  and  $x$  are constants for a given sample and temperature,  $c$  representing a critical concentration of carriers below which the mobility is concentration-independent.

Assuming a bimolecular rate law,

$$dn/dt = -K n^2, \quad (4)$$

where  $K$  = rate constant (in units of  $\text{cm}^3/\text{sec carrier}$ ), one can derive the following equations.

At  $n \ll c$ :

$$I = \frac{\mu_0}{(c)^{1-1/x}} \cdot nAE. \quad (5)$$

Substituting eq. (5) in (4) yields

$$\frac{dI}{dt} = -\frac{Kc^{1-1/x}}{\mu_0 AE} \cdot I^2, \quad (6)$$

or, upon integration,

$$1/I = \frac{Kc^{1-1/x}}{\mu_0 AE} \cdot t + \text{constant}. \quad (7)$$

For  $n \gg c$ :

$$I = \mu_0 n^{1/x} AE, \quad (8)$$

and, upon substitution in eq. (4) and integration, one obtains

$$I = \frac{\mu_0 AE}{K^{1/x}} \cdot t^{-1/x} + \text{constant}. \quad (9)$$

Thus, at low carrier concentrations, I should decay according to Eq. (7) and at high carrier concentrations according to Eq. (9), in agreement with experiment.

It is also possible to write equations for the steady-state photoconductivity. At the steady state, eq. (4) becomes

$$\frac{dn}{dt} = 0 = -Kn^2 + L, \quad (10)$$

where  $L$  = rate of photoproduction of charge carriers;  $L$  is proportional to light intensity, and the proportionality factor involves the quantum yield.

At high light intensity eq. (8) applies, and one obtains, upon substitution in (10),

$$I_{\text{steady-state}} \text{ (high light)} = \frac{\mu_0 AE}{K^{1/2x}} \cdot L^{1/2x}. \quad (11)$$

At low light intensities, eq. (5) applies and, upon substitution into (10), one obtains

$$I_{\text{steady-state}} \text{ (low light)} = \frac{\mu_0 AE}{c^{1-x} K^{1/2}} \cdot L^{1/2}. \quad (12)$$

From the room-temperature curve of Fig. 4, it is apparent that  $x = 2$  under these conditions. Thus, for this sample, the steady-state photocurrent should vary as the fourth root of the light intensity at very high light intensities, if the mechanism proposed above is correct. That this is approximately the case is demonstrated by Fig. 6. These data were obtained by focusing the unfiltered light from the 800-watt xenon arc lamp through a water bath onto the sample. Equation (12) predicts that at low light intensities the steady-state photocurrent should vary as the square root of the light intensity. That this is approximately so is also shown in Fig. 6.

It has been observed, in cells in which only surface conductivity is measured, that at very low light intensities the steady-state photocurrent has a roughly linear relationship to the light intensity.<sup>7</sup> Even at the lowest light intensities obtainable, this behavior is not observed in the samples described herein. This observation is similar to the results found with sandwich-type cells in which bulk properties are being measured.<sup>7</sup> This suggests that measurements reported here relate predominantly to bulk properties, which is plausible in view of the geometry of the "surface" cells used. (see Fig. 1).

The fact that photocurrent may be observed for several minutes after flash illumination suggests a low mobility and that carrier recombination may

<sup>7</sup>D. M. J. Compton, W. G. Schneider, and T. C. Waddington, J. Chem. Phys. 27, 160 (1957).

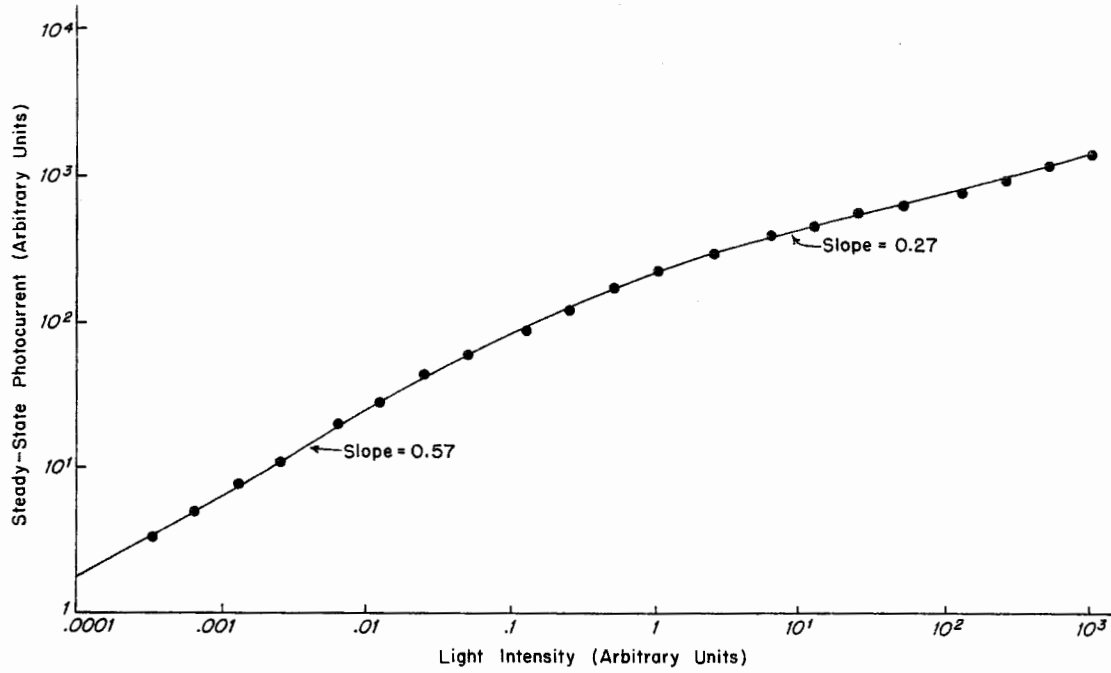

MU-17525

Fig. 6. Intensity dependence of metal-free phthalocyanine steady-state photoconductivity.

be diffusion-limited. The mathematics of diffusion-limited reactions has been treated by Waite.<sup>8</sup> For a bimolecular diffusion-limited process, Waite derives, for the rate law at low reactant concentrations, the expression

$$dn/dt = 4\pi r_0 D n^2 = -Kn^2, \quad (13)$$

where  $r_0$  = separation of reactants within which reaction is rapid, but outside of which there is essentially no interaction = capture radius,

$D$  = average diffusivity (in units of  $\text{cm}^2/\text{sec-carrier}$ ),  
 $K$  = bimolecular rate constant as previously defined in Eq. (4),  
 $n$  = concentration of holes = concentration of electrons.

Therefore

$$K = 4\pi r_0 D. \quad (14)$$

From the Einstein equation,<sup>9</sup>

$$D = \frac{\mu kT}{e} \quad (15)$$

where, for this case,

$$\mu = \frac{\mu_0}{c \frac{1-1/x}{x}}, \quad (16)$$

the following equation is obtained:

$$K = 4\pi r_0 \frac{\mu_0}{c \frac{1-1/x}{x}} \cdot \frac{kT}{e}. \quad (17)$$

From Eq. (7), the slope of a plot of  $1/I$  vs  $t$  at low  $I$  is equal to

$$\frac{Kc \frac{1-1/x}{x}}{\mu_0 AE} = B. \quad (18)$$

Upon substitution of Eq. (17) into (18) one obtains

$$\frac{4\pi r_0}{AE} \cdot \frac{kT}{e} = B, \quad (19)$$

<sup>8</sup>T. R. Waite, Phys. Rev. 107, 463 (1957).

<sup>9</sup>N. F. Mott and R. W. Gurney, Electronic Processes in Ionic Crystals (Clarendon Press, Oxford, 1950).



or, rearranging,

$$r_0 = \frac{BAE}{4\pi} \cdot \frac{e}{kT} \quad (20)$$

This equation permits the calculation of  $r_0$  from experimental data. For metal-free phthalocyanine at room temperature,  $r_0$  is approximately 25 Å (about one molecular diameter), and increases to about 200 Å at  $-35^\circ\text{C}$ . At temperatures up to  $50^\circ\text{C}$ ,  $r_0$  remained at about the room-temperature value, within experimental error.

The fact that one can obtain reasonable values for  $r_0$  suggests that the assumption that recombination is diffusion-limited is moderately accurate. The observed increase in  $r_0$  at low temperatures may be due to a decrease in thermal scattering.

## 2. Results with Sandwich Cells and Annealed Samples.

Room temperature photoconductivity decay curves were also measured for sandwich-type cells of metal-free phthalocyanine. These gave essentially the same kinetics as did the "surface" cells. In general, the sandwich cells were more difficult to prepare and had only about 1/100 as good a signal-to-noise ratio as the "surface" cells.

A common method used to indicate the sign of the majority charge carrier in a sandwich cell is to measure the magnitude of the photocurrent as a function of the polarity of the illuminated electrode. When this was done for a sandwich cell of metal-free phthalocyanine, higher currents (about double) were obtained when the illuminated electrode was positive than when it was negative. This indicates that holes are the more mobile carriers, in agreement with investigations of other organic compounds.<sup>7, 10, 11</sup>

Microcrystalline (annealed) "surface" cells exhibit the same photocurrent kinetic behavior as do the unannealed samples. However, the annealed samples exhibit a smaller concentration dependence of carrier mobility. It is to be expected that more ordered samples would contain fewer scattering centers and therefore possess higher carrier mobilities. This is consistent with the fact that higher photocurrents were obtained with annealed samples than with unannealed samples, under identical conditions. Thus, it would appear that larger carrier-mobility concentration dependences are associated with lower carrier mobilities. It is planned to investigate the microcrystalline samples in more detail in the future.

## 3. Temperature Dependence of Current Decay

A change in temperature over the range from  $60^\circ\text{C}$  to  $-35^\circ\text{C}$  does not affect the kinetics of the major portion of the decay curve (20  $\mu\text{sec}$

---

10

H. P. Kallman and M. Silver, Symposium on Fluorescence and Semiconductors, Garmisch-Partenkirchen, Fall 1956.

11

D. C. Northrup and O. Simpson, Proc. Roy. Soc. (London) 244A, 377 (1958).

to 100 sec), within experimental error. In particular, the photocurrent decay remains bimolecular at low currents, indicating that there are no trapping centers with depths greater than about 0.05 ev.

A decrease in temperature was found to cause a slight decrease in the  $1/x$  value. For example,  $1/x = 0.50$  at  $23^\circ\text{C}$  and  $1/x = 0.43$  at  $-35^\circ\text{C}$ , as shown in Fig. 4. Inasmuch as one would expect a decrease in mobility at lower temperatures, these results again indicate that there is an inverse relationship between mobility and concentration dependence of mobility. This is further demonstrated by the fact that the concentration dependence portion of the decay curve extends to longer times at the lower temperature (see Fig. 4).

#### 4. Temperature Dependence of Steady-State Photocurrent and Dark Current

The steady-state photocurrent as a function of temperature obeyed the equation<sup>12</sup>

$$I_{\text{steady-state}} = c e^{-\Delta E/kT}, \quad (21)$$

where  $\Delta E \approx 0.2$  ev, in agreement with other reported values.

The temperature dependence of the dark current was more difficult to measure, but was found to obey the relation<sup>13</sup>

$$I_{\text{dark}} = c e^{-\Delta E/2kT}, \quad (22)$$

where  $\Delta E \approx 1-2$  ev, in approximate agreement with reported values.

#### 5. Voltage Dependence of Steady-State Photocurrent and Dark Current

Both steady-state photoconductivity and dark conductivity obeyed the relationship

$$I \propto V^{3/2} \quad (23)$$

where  $V$  = applied voltage.

The kinetics of flash photoconductivity decay were independent of the applied field.

---

<sup>12</sup>

J. Kommandeur, G. J. Korinek, and W.G. Schneider, Can. J. Chem. 35, 998 (1957).

<sup>13</sup>

N. F. Mott and R. W. Gurney, op. cit., pp. 156 et seq.

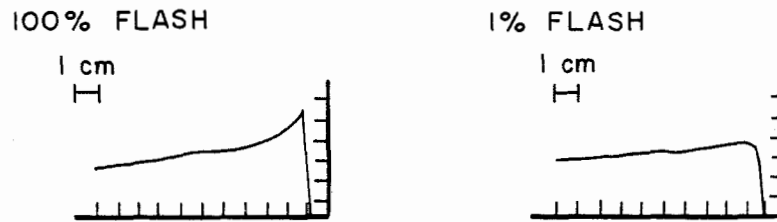

MU-17734

Fig. 7. Intensity dependence of initial photoconductivity decay for a typical metal-free phthalocyanine sample. The flash intensity was varied with neutral density filters sweep times are 20  $\mu$ sec/cm.

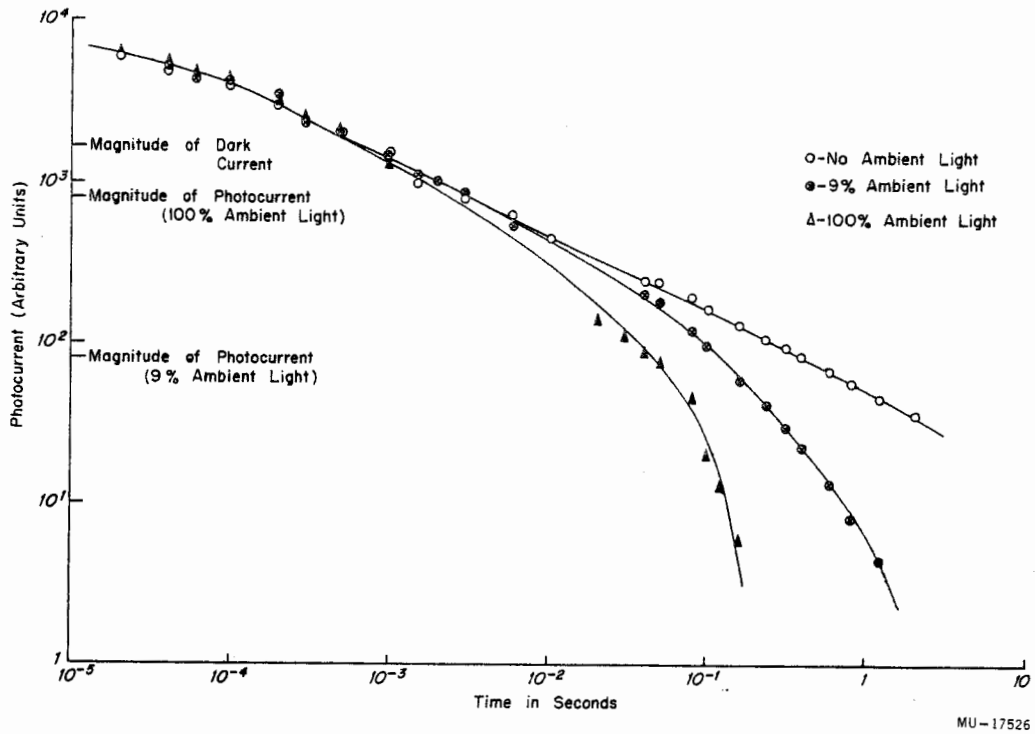

Fig. 9. Log photocurrent versus log time of a metal-free phthalocyanine sample with varying amounts of ambient light.

for a series of seven different samples. These results and the ambient-light experiments suggest that the dark current is somehow different from the photocurrent. It is not possible to explain this difference at present.

#### D. Conclusions

The fact that the rise time of flash-induced photoconductivity is limited by the circuitry (about  $1\mu\text{sec}$ ) indicates that the electronically excited state which gives rise to charge carriers has a lifetime of less than  $1\mu\text{sec}$ . This immediately suggests the first excited singlet state, inasmuch as one would expect the lowest triplet state to have a much longer lifetime (of the order of  $10^{-4}$  sec or greater).<sup>14</sup>

The first  $10\mu\text{sec}$  of the photocurrent decay are complicated by the decay of the light pulse itself, and therefore no attempt will be made to discuss this region in any detail.

It was noted above that the photocurrent from  $20\mu\text{sec}$  to several hundred  $\mu\text{sec}$  after flashing decayed significantly more slowly than would be predicted by the proposed mechanism, and that this effect became even more pronounced and lasted for a longer time at lower flash intensities. This suggests that there exists a long-lived high-energy intermediate (of the order of  $10^{-4}$  sec) which contributes to carrier production, but to a smaller extent than does the excited singlet state. One possibility for such an intermediate is the lowest triplet state. Such an hypothesis would be consistent with the low-intensity flash behavior of the current decay, inasmuch as the triplet lifetime would be longer under low-intensity illumination because of a decreased probability of self-quenching.

The next question that arises is the detailed mechanism for the conversion of nonconducting excited electronic states into charge carriers. It is possible to gain some insight into this problem by a consideration of the results reported in the following paper.

---

<sup>14</sup>

G. Porter and M. R. Wright, Disc. Faraday Soc. (in press).