

UC Davis

UC Davis Previously Published Works

Title

Creation of a milk oligosaccharide database, MilkOligoDB, reveals common structural motifs and extensive diversity across mammals.

Permalink

<https://escholarship.org/uc/item/9t80t35r>

Journal

Scientific reports, 13(1)

ISSN

2045-2322

Authors

Durham, Sierra D

Wei, Zhe

Lemay, Danielle G

et al.

Publication Date

2023-06-01

DOI

10.1038/s41598-023-36866-y

Copyright Information

This work is made available under the terms of a Creative Commons Attribution License, available at <https://creativecommons.org/licenses/by/4.0/>

Peer reviewed



OPEN

Creation of a milk oligosaccharide database, MilkOligoDB, reveals common structural motifs and extensive diversity across mammals

Sierra D. Durham¹, Zhe Wei¹, Danielle G. Lemay², Matthew C. Lange³ & Daniela Barile^{1,4}✉

The carbohydrate fraction of most mammalian milks contains a variety of oligosaccharides that encompass a range of structures and monosaccharide compositions. Human milk oligosaccharides have received considerable attention due to their biological roles in neonatal gut microbiota, immunomodulation, and brain development. However, a major challenge in understanding the biology of milk oligosaccharides across other mammals is that reports span more than 5 decades of publications with varying data reporting methods. In the present study, publications on milk oligosaccharide profiles were identified and harmonized into a standardized format to create a comprehensive, machine-readable database of milk oligosaccharides across mammalian species. The resulting database, MilkOligoDB, includes 3193 entries for 783 unique oligosaccharide structures from the milk of 77 different species harvested from 113 publications. Cross-species and cross-publication comparisons of milk oligosaccharide profiles reveal common structural motifs within mammalian orders. Of the species studied, only chimpanzees, bonobos, and Asian elephants share the specific combination of fucosylation, sialylation, and core structures that are characteristic of human milk oligosaccharides. However, agriculturally important species do produce diverse oligosaccharides that may be valuable for human supplementation. Overall, MilkOligoDB facilitates cross-species and cross-publication comparisons of milk oligosaccharide profiles and the generation of new data-driven hypotheses for future research.

Mammals are characterized as homeothermic vertebrates with mammary glands. Beings within the class *Mammalia* can be divided into placental mammals, marsupials and monotremes, based on how their young are gestated and born. Placental mammals belong to the clade *Eutheria* and are characterized by fetuses which remain in the uterus of the mother and are nourished by the placenta until a comparatively late stage of neonatal development. In contrast, marsupial offspring undergo a brief uterine gestation followed by a period of further development in the mother's pouch, where they begin nursing. Diverging even farther, the young of monotremes are laid in eggs and then undergo further development in their mother's pouch after hatching. While all types of mammalian mothers produce milk to nourish their young after birth, the composition of this milk varies between species^{1,2}.

In addition to protein and lipids, carbohydrates are one of the main components of mammalian milk, with oligosaccharides often featuring as the third or fourth most abundant milk component, depending on the species and lactation time point. Milk oligosaccharides are composed of three to twenty monosaccharides. Constituent monosaccharides may include D-glucose (Glc), D-galactose (Gal), N-acetyl-D-glucosamine (GlcNAc), N-acetyl-D-galactosamine (GalNAc), L-fucose (Fuc), N-acetylneuramic acid (Neu5Ac), or N-glycolylneuraminic acid (Neu5Gc). Milk oligosaccharides feature either a lactose or, less commonly, a lactosamine unit at the reducing end, and their structures may be extended through the addition of Gal, GlcNAc or GalNAc monomers. Most

¹Department of Food Science and Technology, University of California, Davis, One Shields Ave., Davis, CA 95616, USA. ²Agricultural Research Service, U.S. Department of Agriculture, Western Human Nutrition Research Center, 430 West Health Sciences Dr., Davis, CA 95616, USA. ³International Center for Food Ontology Operability Data and Semantics, 216 F Street Ste. 139, Davis, CA 95616, USA. ⁴Foods for Health Institute, University of California, Davis, One Shields Ave., Davis, CA 95616, USA. ✉email: dbarile@ucdavis.edu

milk oligosaccharides composed of four or more monosaccharides are divided into two basic categories based on their core structures as either type I or type II (Supplementary Tables 1 and 3). Type I cores feature the structure of lacto-*N*-tetraose (LNT, Gal(β 1-3)GlcNAc(β 1-3)Gal(β 1-4)Glc), while type II cores feature lacto-*N*-neotetraose (LNnT, Gal(β 1-4)GlcNAc(β 1-3)Gal(β 1-4)Glc). Complex milk oligosaccharides with high degrees of polymerization may feature further branching through the linkage of additional α 1,3-, α 1,4-, or α 1,6-linked Gal, GlcNAc, or GalNAc; however, most of these larger structures can still be categorized as having either a type I or type II core³. Both type I and type II core structures may also be decorated with α 1,2- or α 1,3-linked fucose and/or α 2,3- or α 2,6-linked Neu5Ac or Neu5Gc. Neu5Ac and Neu5Gc are two forms of sialic acid, and oligosaccharides containing either of these monosaccharides are classified as acidic, while those without any sialic acid are categorized as neutral.

Milk oligosaccharides are of particular interest because, although they are assembled at considerable energetic cost to the mother, they are largely undigested by the neonate. Human milk oligosaccharides have been demonstrated to have prebiotic activity, selectively promoting the growth of beneficial bacteria in the infant gut⁴⁻⁹. These probiotics then occupy space on the intestinal epithelium, consume human milk oligosaccharides and produce short chain fatty acids, which lower the pH of the gut, making it difficult for pathogens to colonize the infant gut. In addition, the structural homology of milk oligosaccharides to cell surface glycans of the intestinal epithelium allows them to act as receptor decoys to which pathogens may bind in place of host epithelial cells, resulting in the flushing of pathogens from the gut¹⁰. Human milk oligosaccharides also have anti-inflammatory and immunomodulatory activities and have been shown to decrease gut permeability associated with obesity¹¹⁻¹⁵. In addition, the sialic acid found in milk oligosaccharides has been linked to neonatal brain development and learning¹⁶⁻¹⁸.

The functions of milk oligosaccharides demonstrated to date are dependent upon their structural motifs. As such, oligosaccharides that share monosaccharide compositions may have distinctly different activities depending on their unique isomer structures and glycosidic linkages. Despite the benefits of human milk oligosaccharides, no equally diverse source of bioactive carbohydrates is currently available outside of human milk. Some infant formulas are beginning to be supplemented with prebiotic oligosaccharides, but in most cases the added compounds are not equivalent to those in human breast milk. Despite their demonstrated prebiotic activity, homooligomers like galactooligosaccharides (GOS) and fructooligosaccharides (FOS) lack the structural complexity and compositional diversity of human milk oligosaccharides¹⁹. The human milk oligosaccharides commercially produced in quantities sufficient for supplementation to infant formula are relatively small, simple structures as more complex human milk oligosaccharide structures have proven to be difficult and expensive to produce through enzymatic synthesis or in genetically modified microbes²⁰.

However, many oligosaccharide structures have been identified in the milk or colostrum of non-human mammals with varying degrees of similarity to human milk oligosaccharides. Some non-human mammalian milks are potential sources of oligosaccharides for commercial isolation for supplementation in human infant formulas and functional foods while others represent possible biomedical models for developing a further understanding of the roles of human milk oligosaccharides. The biological significance of variations in milk oligosaccharide profiles among mammalian species is not yet fully understood.

The main challenge in building further understanding of milk oligosaccharides from the existing literature lies in the scattering of the relevant data across decades of publications in dozens of academic books and journals. Although a few carbohydrate databases exist with summaries of large portion of the available carbohydrate literature²¹⁻²⁴, they feature predominantly plant-, bacterial-, archaeal-, and fungal-derived oligo- and polysaccharides, and protein- or lipid-bound glycans. In addition, these databases are often limited to data originating from a specific type of analysis due to their limited capacity to address structures with different degrees of compositional data available. Complete, targeted searches of mammal-derived glycans like milk oligosaccharides are not easily accessible with these existing resources. Outside of the currently available carbohydrate databases, any cross-publication analysis is hindered by the vast inconsistencies in how milk oligosaccharides have been historically reported, ranging from figures depicting oligosaccharide structures to tables of monosaccharide constituents to full linkage descriptions in the text. These disparate data reporting methods make it prohibitively difficult to make direct comparisons between oligosaccharide profiles reported using different descriptive methods.

The present study overcomes these challenges through the creation of a new database, MilkOligoDB, which reconciles all existing milk oligosaccharide profiles through the use of a standardized form of representing milk oligosaccharide structures regardless of the degree of structural data available. This database facilitates the comparison of oligosaccharides between individual species and across groups of species. In addition, the database holds the potential to contribute to answering questions about the biological significance of specific oligosaccharide structural variations across mammalian milks. When combined with other biological and chemical knowledge bases, together with queries and visualizations, it will also serve as a generator of hypotheses which can be investigated in future milk oligosaccharide studies.

Methods

Literature selection. To enable comparisons between milk oligosaccharide profiles of different species, a database, MilkOligoDB, was constructed (Supplementary Tables 1, 2, and 3; <https://github.com/Barile-Lab/MilkOligoDB>), containing compilations of the existing published milk oligosaccharide profiles for each species discussed herein. For non-human species any studies reporting milk oligosaccharide structures published in a peer reviewed journal or book between January 1970 and July 2022 were considered for inclusion in the database. Publications were excluded from consideration if they had not undergone peer review, were not full articles (i.e. abstract-only publications), did not report original results (i.e. reviews, meta-analyses, secondary analyses of existing published milk oligosaccharides data), did not describe the method through which oligo-

saccharide analysis was conducted, did not adequately describe the species from which milk was obtained, or were published prior to January 1970 or after July 2022. Due to the high volume of publications on human milk oligosaccharides, a few well-established reviews written by leaders in the field within the most recent decade, and any other study meeting the above criteria that reported 30 or more human milk oligosaccharide structures were used to compile a comprehensive list of human milk oligosaccharides. The number of subjects, milk sample collection method, lactation time point at milk collection, and pooling of milk samples were not used as selection criteria. In cases where the milk oligosaccharides of a species were reported in numerous publications meeting the specified criteria, such as with cow milk, papers were selected so as to build an oligosaccharide profile covering the full scope of identified milk oligosaccharides for the species with minimal redundancy. 113 publications covering the milk oligosaccharide profiles of 77 species were included in the database. MilkOligoDB (<https://github.com/Barile-Lab/MilkOligoDB>, Supplementary Table 2) also includes information about the metadata for each article, with 3193 entries describing the genus and species, donor, sample, and analysis information, and identifying information for the corresponding publication for each milk oligosaccharide entry.

Database construction. Oligosaccharide isomers were distinguished in the database based on the compositional information available in the corresponding literature, with varying degrees of identification based on the analytical technique applied in the study. When available, the sequence of monosaccharides, branching, and monosaccharide linkages were specified in the isomer designation. While this strategy allows for the greatest extent of comparison between milk oligosaccharide profiles presented in different studies, there are likely some remaining isomer redundancies. In total, entries for 783 oligosaccharide isomers were included in MilkOligoDB (Supplementary Table 1).

All oligosaccharides are represented by a unique six-part alphanumeric code, comprising five integers separated by underscores, which represent the numbers of hexose, *N*-acetylhexosamine, fucose, *N*-acetylneuraminic acid, and *N*-glycolylneuraminic acid monomers ($\{\text{Hex}\}_{\{\text{HexNAc}\}_{\{\text{Fuc}\}_{\{\text{Neu5Ac}\}_{\{\text{Neu5Gc}\}}$) followed by one or more letters designating the isomer. For example, 4_2_1_1_0c is composed of 4 hexoses, 2 *N*-acetylhexosamines, 1 fucose, 1 *N*-acetylneuraminic acid, and no *N*-glycolylneuraminic acid, and has been assigned to the specific oligosaccharide Neu5Ac(α 2-3)Gal(β 1-3)GlcNAc(β 1-3)[Gal(β 1-4)[Fuc(α 1-3)]GlcNAc(β 1-6)]Gal(β 1-4)Glc. For publications in which oligosaccharide linkage information was not available, the occurrence of multiple isomers with the same monosaccharide composition (differentiated in the original analysis by retention time, fragmentation pattern, etc.) is noted through the assignment of multiple alphanumeric codes corresponding to the same structural composition. For example, 1_1_0_1_0c and 1_1_0_1_0d, which both correspond to oligosaccharides with a structure of Hex + HexNAc + Neu5Ac, indicate two different isomers of 1_1_0_1_0 with unknown linkages. The full list of oligosaccharide isomers and their respective alphanumeric codes is provided in Supplementary Table 1. Summary statistics for the total number of milk oligosaccharides with specific structural features for each species and their overlap with human milk oligosaccharides are presented in Supplementary Table 3.

Database queries, visualization, and analysis. The database was queried to compare oligosaccharide profiles for a variety of groups of species, and the ensuing data was transformed into concept maps using CmapTools²⁵ to visualize the results.

The resulting concept maps can be read from left to right by following the arrows connecting the species names, linking phrases, and oligosaccharides, as exemplified in Fig. 1. Oligosaccharides color-coded as black, with arrows connecting them to multiple species have been reported in the milk of each species to which they share a connecting arrow. Oligosaccharides that are unique to the milk of a single species in a given concept map are color-coded to match that species and bear only a single connecting arrow.

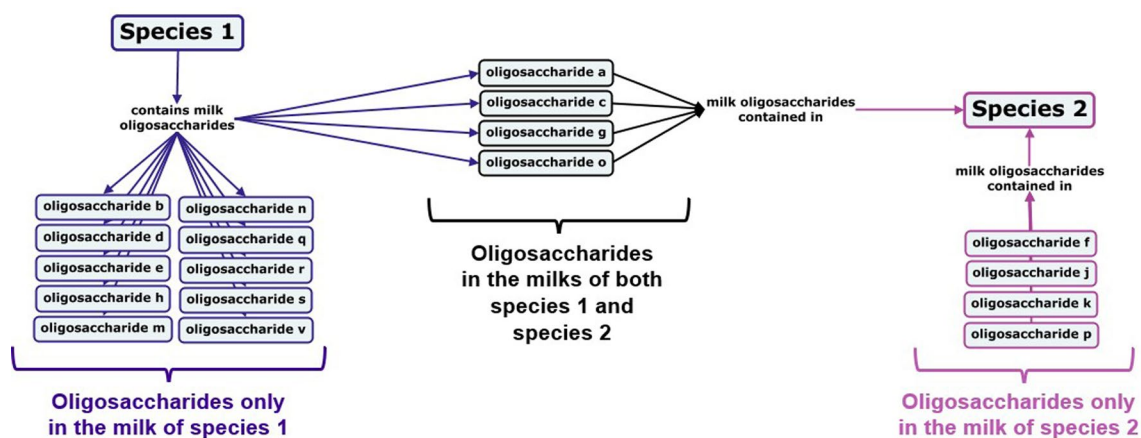

Figure 1. Sample concept map depicting the shared and unique oligosaccharides for two species.

Results

Milk oligosaccharides of placental mammals. *Humans.* Human milk oligosaccharides are by far the most studied set of milk oligosaccharides of any mammalian species. They feature five constituent monosaccharides: Glc, Gal, Fuc, GlcNAc and Neu5Ac, with twelve possible linkages²⁰. To date, more than 300 HMO structures have been identified through the use of various analytical techniques, of which 224 unique human milk oligosaccharide structures have been fully elucidated^{20,26–30}. Variation in human milk oligosaccharide profiles and concentrations due to the secretor and Lewis status of the lactating person is well documented^{31–39}. The secretor gene codes for α 1-2-fucosyltransferase, FUT2, and the Lewis gene codes for the α 1-3/4-fucosyltransferase, FUT3. Individuals who are secretors express the FUT2 gene and produce milk containing an abundance of α 1-2-linked fucose moieties such as 2'-fucosyllactose (2'-FL, Fuc(α 1-2)Gal(β 1-4)Glc) and lacto-*N*-fucopentaose I (LNFP I, Fuc(α 1-2)Gal(β 1-3)GlcNAc(β 1-3)Gal(β 1-4)Glc), while non-secretor mothers produce little to no α 1-2-linked fucose-containing human milk oligosaccharides. Individuals who are Lewis positive express the FUT3 gene and produce milk containing oligosaccharides with α 1-3- and α 1-4-linked fucoses⁴⁰, including 3-fucosyllactose (3-FL, Fuc(α 1-3)Gal(β 1-4)Glc) and lacto-*N*-fucopentaose II (LNFP II, Gal(β 1-3)[Fuc(α 1-4)]GlcNAc(β 1-3)Gal(β 1-4)Glc). The milk of Lewis negative mothers does not contain α 1-4-linked fucose moieties but may have human milk oligosaccharides with α 1-3-linked fucose units due to the activity of a secretor- and Lewis-independent fucosyltransferase³³. Secretor status is known to vary between regional, racial, or ethnic groups, as shown in Fig. 2, which contributes to variations in human milk oligosaccharide profiles between cohorts around the world^{31,33,37,38,41–54}.

In addition, human milk oligosaccharide concentrations have been shown to vary over the course of lactation, with typical oligosaccharide concentrations in human colostrum as high as 20 g/L but falling to as low as 5 g/L in mature milk^{35,36,38,55,56}. The concentration of lactose in human milk is comparatively steady across lactation, at around 60 g/L⁵⁷, resulting in an approximately 1 to 3 ratio of oligosaccharides to lactose in human colostrum and around a 1 to 12 ratio in mature milk. The oligosaccharide profile of human milk is unique in that it does not contain the Neu5Gc form of sialic acid and contains almost no structures with α 1-3-linked galactose. Both Neu5Gc and α 1-3-linked galactose may be recognized as allergens by humans^{58,59}. For most lactating individuals, neutral fucosylated milk oligosaccharides predominate. In addition, the majority of human milk oligosaccharides contain type I core structures. Of the 224 human milk oligosaccharides with full linkage information available, 59.8% have type I cores while only 29.5% have type II cores. (Supplementary Table 3) Although type I oligosaccharides are present in the milk of some other mammals, type II cores prevail in the milk oligosaccharides of most non-human mammals. This combination of structural features—high levels of fucosylation, essentially no Neu5Gc, and mostly type I cores—is uniquely characteristic of human milk oligosaccharides, and rarely found all together in the milks of other mammals. These structural differences, both between donors and between species, are of particular interest because of the strong ties between structure and bioactivities for milk oligosaccharides.

Non-human primates. As the closest relatives to humans, data on milk oligosaccharides of non-human primates can aid the understanding of human milk oligosaccharides and their roles. The milk oligosaccharides of a number of non-human primates have been investigated, including those of apes (*Pongidae* and *Hylobatidae*), old world monkeys (*Cercopithecidae*), new world monkeys (*Cebidae*, *Callitrichidae*, and *Atelidae*), and strepsirrhine primates. Of the primate groups, the great apes, including chimpanzees, bonobos, gorillas, and orangutans, are the closest phylogenetic relatives to humans. Chimpanzee and bonobo milks have oligosaccharide profiles that are about 50% fucosylated with both type I and II cores and a 1 to 4 or 1 to 5 ratio of oligosaccharides to lactose, making them the closest in terms of free carbohydrate composition to human milk. Unlike human milk,



Figure 2. Distribution of secretor status in lactating humans around the world based on the abundance of α 1-2-linked fucose in breast milk, where the black sections of the pie charts represent the percent of secretors in the population and the light grey represents the percentage of non-secretors.

however, chimpanzee and bonobo milk oligosaccharides contain Neu5Gc and have more type II than type I core structures (Fig. 3)^{60–62}. 2'-FL has been shown to decrease in concentration in bonobo milk over the course of lactation while 3-FL increases in concentration, a trend also observed in human milk^{44,62}. In contrast, only α 1-2-linked fucose has been identified in gorilla milk, which also contains oligosaccharides with Neu5Gc monomers and both type I and type II core structures^{60,61}. Orangutans have milk with a substantially higher ratio of oligosaccharides to lactose (1 to 0.8) than the other great apes, and their milk oligosaccharide profile contains structures with Neu5Gc and predominantly type II cores (Fig. 3)^{61,62}.

The only lesser ape for which milk oligosaccharides have been analyzed is the siamang. Although siamang milk's 1 to 3 ratio of oligosaccharides to lactose is similar to those of the great apes, siamang milk oligosaccharides are the most sialylated (46% of structures contain Neu5Ac or Neu5Gc) of any primate, with only trace amounts of fucosylation^{60,61}.

Three species of old world monkeys, hamadryas baboon, toque macaque and rhesus macaque, all have milk oligosaccharides with α 1-3-linked fucose moieties, but no α 1-2-linked fucose-containing oligosaccharides have been identified⁶³. Type I core and Neu5Gc-containing oligosaccharides have both been identified in milk of the rhesus macaque, but not in toque macaque or hamadryas baboon milk (Fig. 4)^{60,63}.

Milk oligosaccharides from three of the five families of new world monkeys have been profiled, including samples of mantled howler, brown capuchin, Bolivian squirrel monkey, golden lion tamarin, and common marmoset milk. With the exception of the common marmoset, for which 21% of identified structures are fucosylated, the milk of new world monkeys appears to contain little to no fucosylated or type I core oligosaccharides (Fig. 5)^{60,63,64}.

Strepsirrhine primates split off from the lineage of other monkeys and apes an estimated 76–87 million years ago. Milk oligosaccharides from four species in this suborder have been analyzed to date, including the greater galago, aye-aye, mongoose lemur, and Coquerel's sifaka. The milks of these species have similar ratios of lactose and free oligosaccharides as humans and great apes, but type I core structures have only been identified in aye-aye milk (Fig. 6)⁶⁵.

Overall, primate milk oligosaccharide profiles are more diverse than those of bovine, caprine, or porcine milks and contain similar types of structures as human milk oligosaccharides, but in different proportions (Figs. 3, 4, 5 and 6, Supplementary Table 3)⁶². With an average degree of polymerization (DP) of 4–6, milk oligosaccharide structures of non-human primates tend to be smaller than human milk oligosaccharides (average DP of 7–9)⁶⁰. Current research shows only minimal evidence of correlation between milk oligosaccharide profiles of non-human primates and their phylogenetic relations or social structures^{60,65}.

Terrestrial carnivores. The species within the order *Carnivora* can be divided into two suborders, *Feloidea* and *Canoidea*. A handful of species within *Feloidea* have been the subject of milk oligosaccharide investigations. Primarily small neutral oligosaccharides have been identified in the milk of cheetahs, spotted hyenas, and clouded leopards^{66–68}, but larger structures, including a variety of fucosylated oligosaccharides have been identified in the milk of house cats and African lions (Fig. 7)^{67,69,70}. Only two acidic oligosaccharides have been identified in *Feloidea* milk, with 6'-SL identified in the milk of house cats and α 2-3-Neu5Gc-lactose found in all profiled *Feloidea* milks except cheetah (Fig. 7)^{66,67,69,70}. Lions, leopards, and cheetahs all have a milk oligosaccharide to lactose ratio of 1 to 1 or 1 to 2, although lion milk has considerably less lactose (about 27 g/kg) compared to cheetah milk (40.2 g/kg)^{67,68,71}.

Substantially more investigations into the milk oligosaccharide profiles of species within the *Canoidea* suborder of *Carnivora* have been conducted. The milk oligosaccharide profiles of several species of bears have been studied, including those of the American black bear, Japanese black bear, Ezo brown bear, grizzly bear, polar bear, and giant panda. Both American and Japanese black bear milk contains large α 1-2- and α 1-3-linked fucosylated oligosaccharides, although only type II core structures were identified in Japanese black bear milk, while both type I and type II core milk oligosaccharides have been identified for the American black bear^{62,68,72}. Among the brown bears, milk of the Ezo brown bear is dominated by trisaccharides, especially 2'-FL, while grizzly bear milk contains more DP 4 and 5 fucosylated oligosaccharides with both type I and type II core structures (Fig. 8, Supplementary Table 3)^{62,73}. Although the total carbohydrate concentration of polar bear milk remains relatively constant, the oligosaccharide profile varies over the course of lactation, with a high 3'-SL concentration in colostrum but an abundance of isoglobotriose in mid to late lactation milk^{74,75}. In contrast, the carbohydrate fraction of giant panda milk increases over the course of lactation, with isoglobotriose (Gal(α 1-3)Gal(β 1-4)Glc) as the main oligosaccharide throughout^{76,77}. Lactose concentrations in bear milk are low at around 1–4 g/kg, which makes them a notable exception to the typically high lactose concentrations in the milk of placental mammals. This low lactose content serves to protect the hibernating mother during lactation both because lipid content is a more efficient method of energy transfer from mother to nursing offspring and because lower lactose concentrations lead to less osmolytic pressure on the milk, lessening the risk of maternal dehydration^{68,76,78}.

Like the larger members of *Canoidea*, milk oligosaccharides are dominated by α 1,3-linked galactose-containing cores and Neu5Gc-containing structures are absent from raccoon, striped skunk, mink, dog, and white-nosed coati milk (Fig. 9, Supplementary Table 3)^{62,69,79–84}. No acidic oligosaccharides have been reported in mink or white-nosed coati milk, and no type I core structures or α 1-3-linked fucose-containing oligosaccharides have been found in the milk of any of the smaller terrestrial carnivores. Unlike most other *Canoidea*, the oligosaccharides identified in raccoon milk include very large structures (DP 13–18) in addition to the smaller neutral fucosylated oligosaccharides (Fig. 9)⁷⁹.

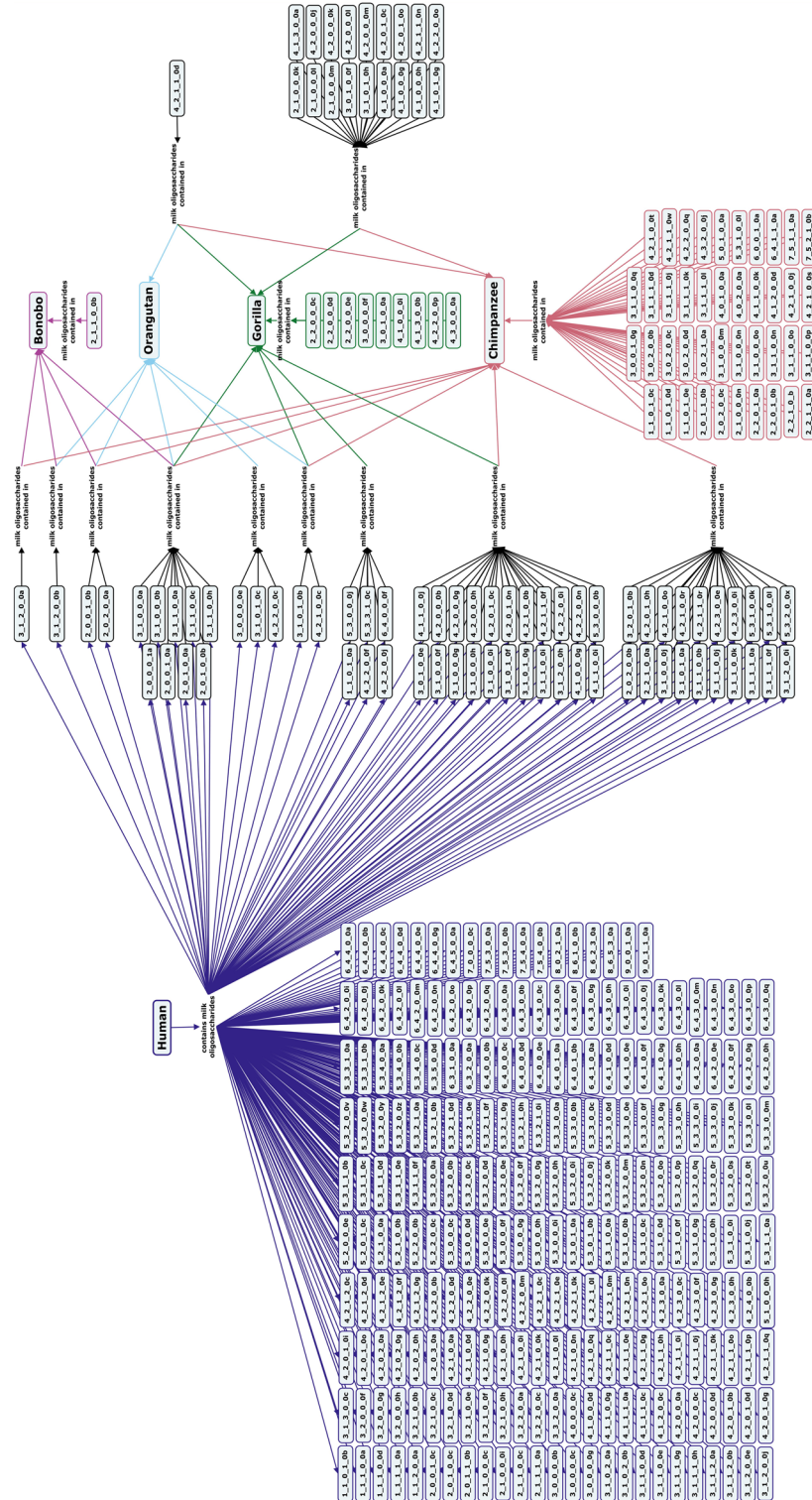

Figure 3. Concept map comparing the milk oligosaccharide profiles of four great ape species, bonobos, orangutans, gorillas, and chimpanzees, with human milk oligosaccharides. Oligosaccharides are designated as the number of {hexose}_{[N-acetylhexosamine]}_{[fucose]}_{[N-acetylneuraminic acid]}_{[N-glycolylneuraminic acid]} monomers contained in the structure, followed by a letter, to designate the isomer. The full list of oligosaccharide isomer names and their respective alphanumeric codes is provided in MilkOligoDB (Supplementary Table 1). A searchable version of Fig. 3 is available at this link (<https://cmmapcloud.ihmc.us/viewer/cmapp/1Z3CVQ5PP-1XWQCHC-QZZ>).

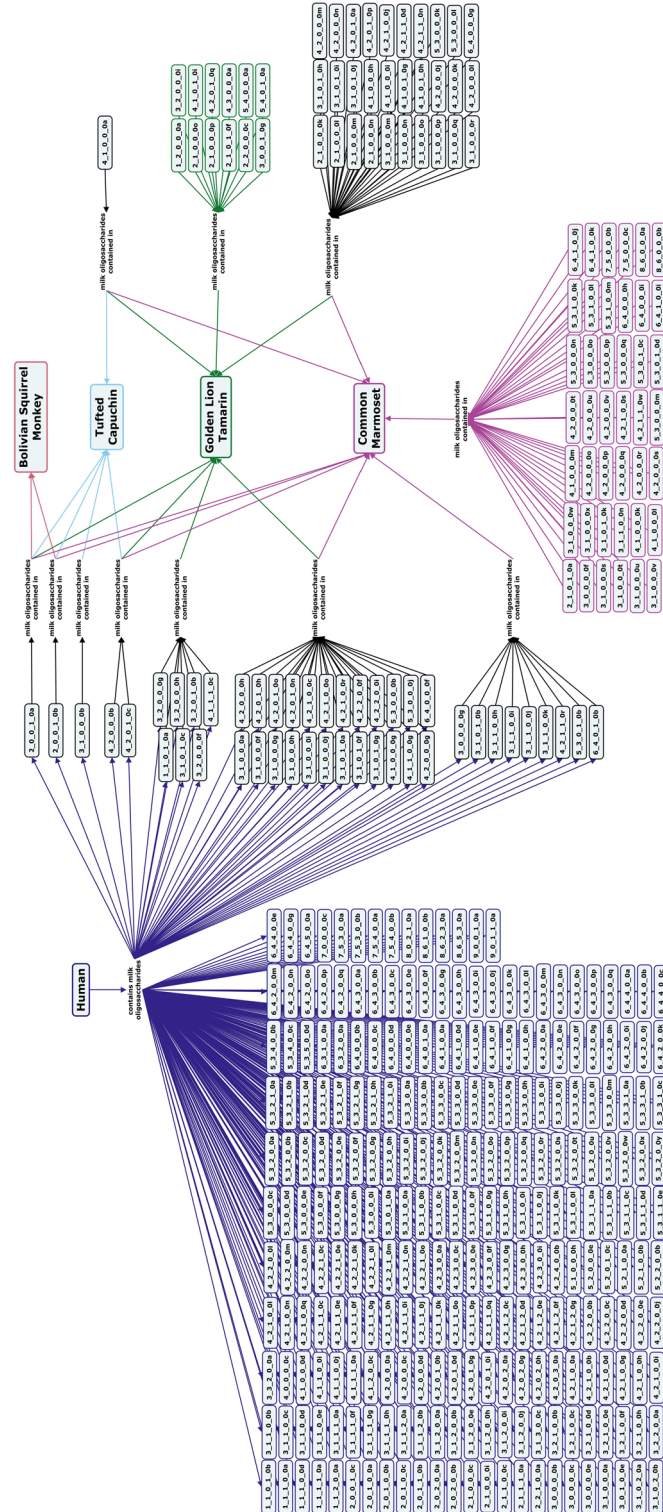

Figure 5. Concept map comparing the milk oligosaccharide profiles of four new world monkey species, Bolivian squirrel monkey, tufted capuchin, golden lion tamarin, and common marmoset, with human milk oligosaccharides. Oligosaccharides are designated as the number of {hexose}_{N-acetylhexosamine}_{fucose}_{N-glycolylneuraminic acid} monomers contained in the structure, followed by a letter, to designate the isomer. The full list of oligosaccharide isomer names and their respective alphanumeric codes is provided in MilkOligoDB (Supplementary Table 1). A searchable version of Fig. 5 is available at this link (<https://cmapsclooud.ihmc.us/viewer/cmap/1Z3D34NZJ-1XCD8QZ-14DC>).

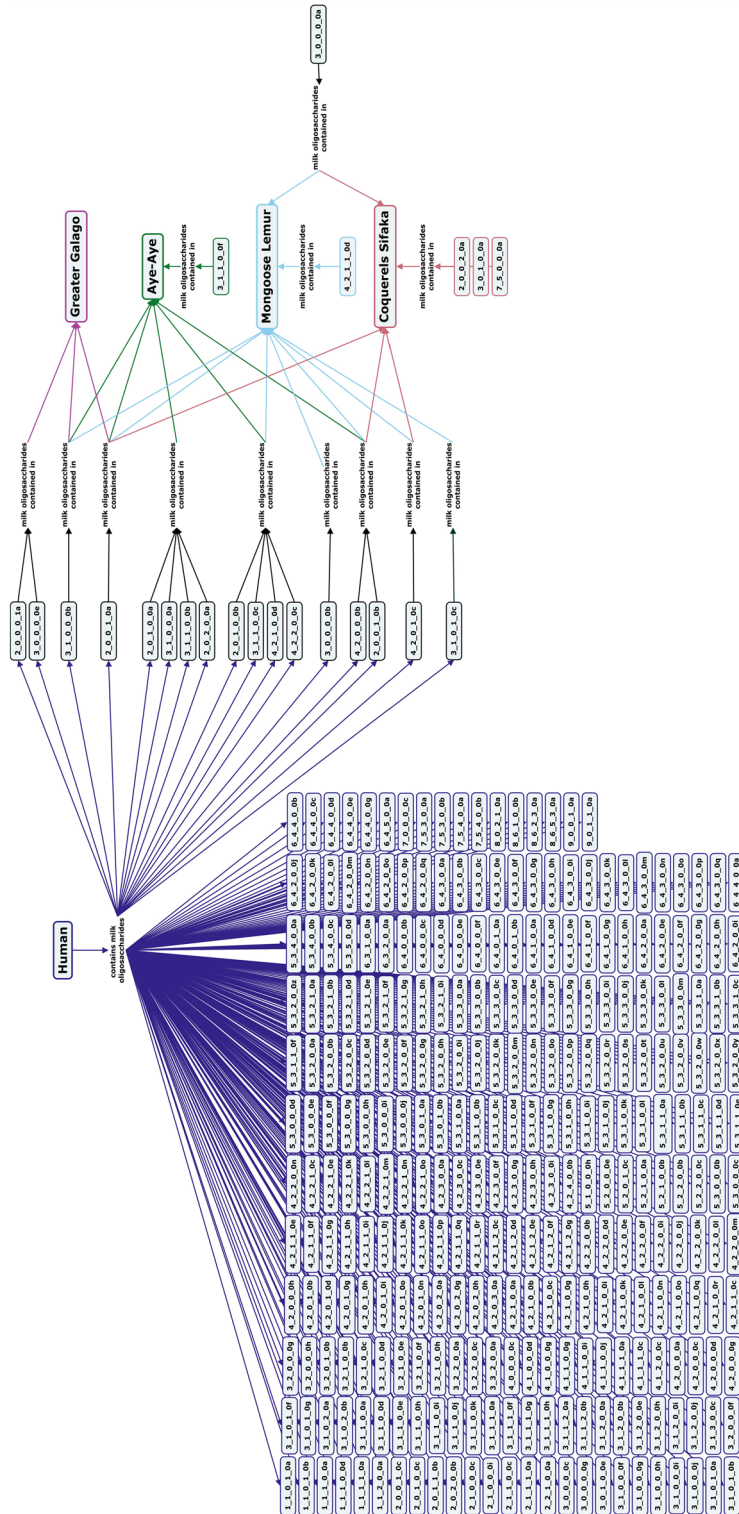

Figure 6. Concept map comparing the milk oligosaccharide profiles of four Strepsirrhine primate species greater galago, aye-aye, mongoose lemur, and coquerels sifaka, with human milk oligosaccharides. Oligosaccharides are designated as the number of {hexose}_{N-acetylhexosamine}_{fucose}_{N-acetylneuraminic acid}_{N-glycolylneuraminic acid} monomers contained in the structure, followed by a letter, to designate the isomer. The full list of oligosaccharide isomer names and their respective alphanumeric codes is provided in MilkOligoDB (Supplementary Table 1). A searchable version of Fig. 6 is available at this link (<https://cmapscloud.ihmc.us/viewer/cmap/1Z3D5M8XM-10RDDWQ-18Z5>).

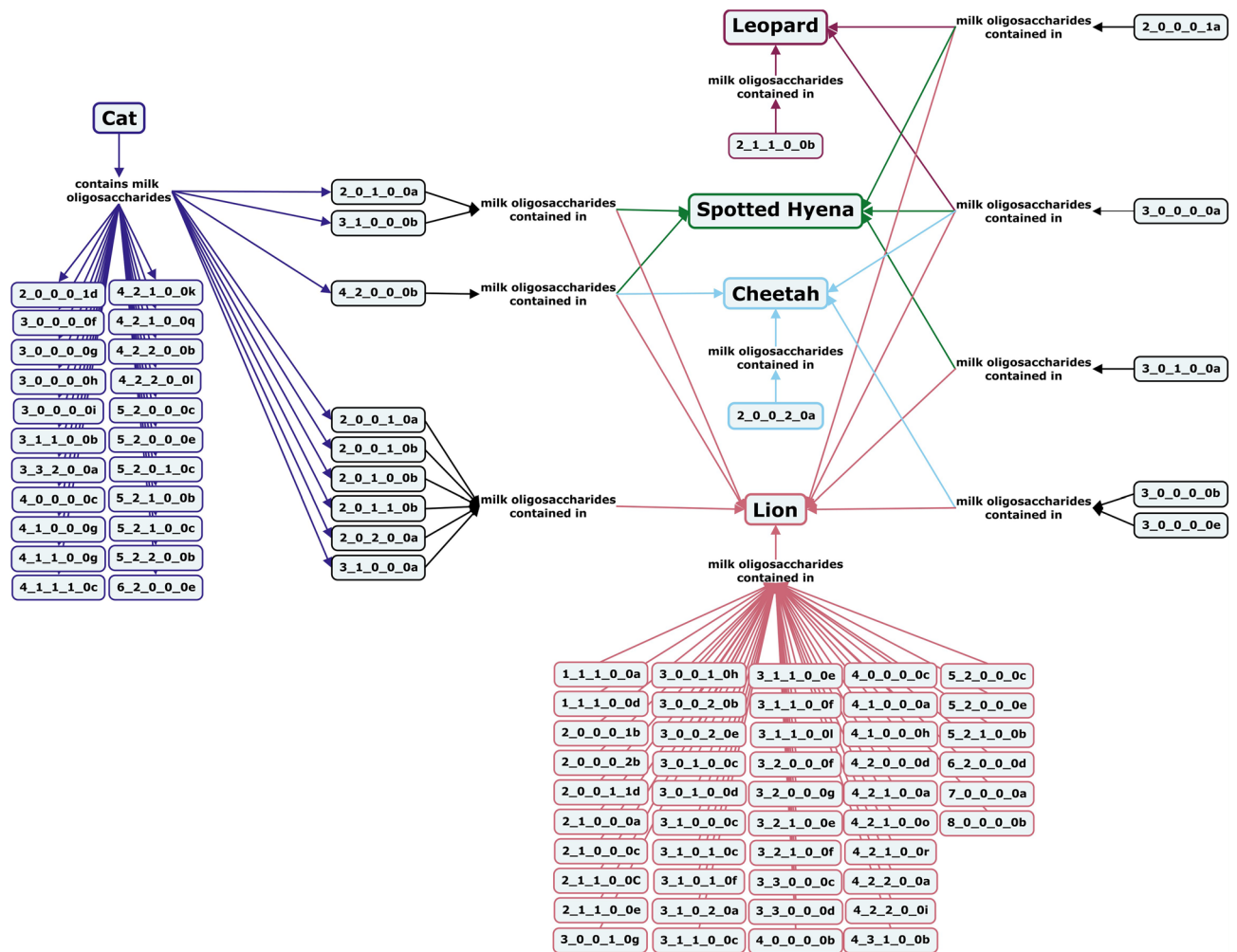

Figure 7. Concept map comparing the milk oligosaccharide profiles of four *Feloidae* species, domestic cats, spotted hyenas, cheetahs, and lions. Oligosaccharides are designated as the number of {hexose}_{N-acetylhexosamine}_{fucose}_{N-acetylneuraminic acid}_{N-glycolylneuraminic acid} monomers contained in the structure, followed by a letter, to designate the isomer. The full list of oligosaccharide isomer names and their respective alphanumeric codes is provided in MilkOligoDB (Supplementary Table 1). A searchable version of Fig. 7 is available at this link (<https://cmapscloud.ihmc.us/viewer/cmapi/1Z3D5PZXD-2CXHC33-1BLH>).

Even-toed ungulates. Milks from many species within the *Artiodactyla* order have been analyzed for their oligosaccharide content. These species include ruminants such as cows, goats, sheep, buffalo, antelope, and deer, as well as non-ruminants like pigs.

Milk and dairy products from cows, goats and sheep are commonly consumed across much of the world. Milk oligosaccharides are present in concentrations of around 1.57 g/L in cow colostrum but fall to between 200 and 300 mg/L in mature cow and goat milk or 2–3 mg/L in mature sheep milk^{85–91}. Milk oligosaccharides in these species are much less concentrated than lactose, which is expressed at levels of 49 g/L for cows, 43 g/L for goats, and 48 g/L for sheep⁷⁸. The oligosaccharide profiles for all three species are dominated by acidic structures, with 43% of cow, 46% of goat, and 61% of sheep oligosaccharide structures contain Neu5Ac or Neu5Gc. However, while cow milk features predominantly Neu5Ac-containing oligosaccharide, goat and sheep milk oligosaccharides are largely Neu5Gc-containing compounds (Fig. 10, Supplementary Table 3)^{85–88,91–97}. Neutral fucosylated oligosaccharides and type I core structures have been observed in cow and goat milk, but at lower abundances—especially for cow milk—than in the milk of humans and other primates^{97–103}. In contrast, most neutral sheep milk oligosaccharides are small, non-fucosylated compounds with no type I core structures reported^{86,97,104}. The oligosaccharide profiles of cows and goats have been shown to vary over the course of lactation^{93,105,106} and between animals of different breeds or parities^{87,107–109}, in addition to seasonal variation of cow milk oligosaccharides^{90,92}. As in humans, genotype may influence the oligosaccharide profiles in goats and cows with changes in goat milk oligosaccharide profiles observed based on the α_{s1} -casein production gene *CSN1S1*¹¹⁰, and two recent genome-wide association studies strongly correlating changes in milk oligosaccharide expression to several genes in cows^{111,112}.

Yak milk is consumed as a food source in regions of China, India, Mongolia, Nepal, and Tibet. Yak milk contains similar levels of lactose and oligosaccharides as dairy cattle^{78,113}. Several neutral oligosaccharides have

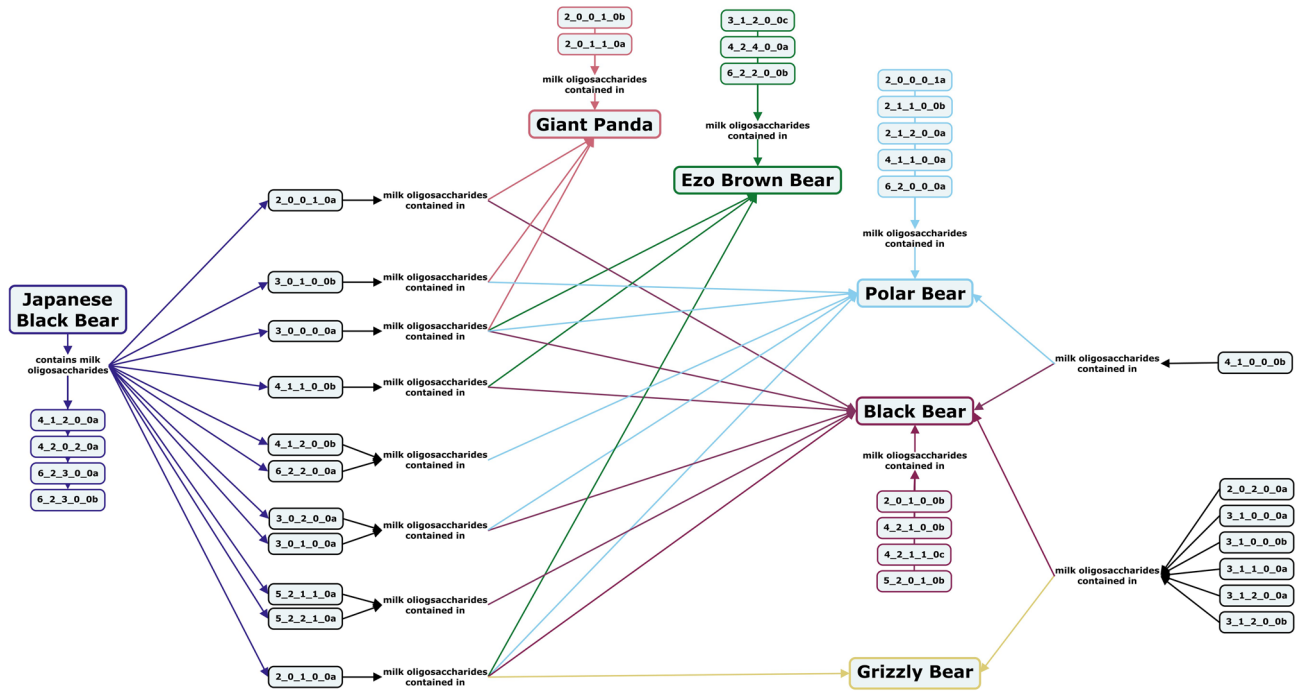

Figure 8. Concept map comparing the milk oligosaccharide profiles of five bear species, including Japanese black bears, giant pandas, ezo brown bears, polar bears, black bears, and grizzly bears. Oligosaccharides are designated as the number of {hexose}_{N-acetylhexosamine}_{fucose}_{N-acetylneuraminic acid}_{N-glycolylneuraminic acid} monomers contained in the structure, followed by a letter, to designate the isomer. The full list of oligosaccharide isomer names and their respective alphanumeric codes is provided in MilkOligoDB (Supplementary Table 1). A searchable version of Fig. 8 is available at this link (<https://cmapscloud.ihmc.us/viewer/cmap/1Z3D5X4SB-1MFV5M8-1CGP>).

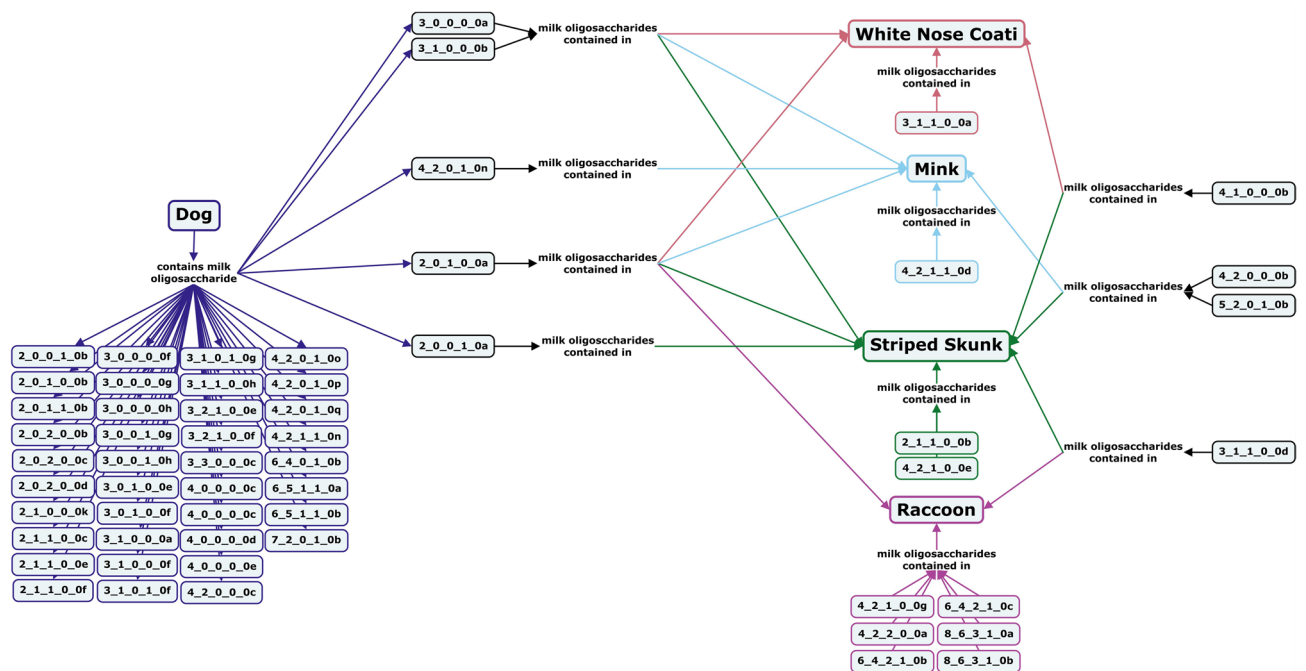

Figure 9. Concept map comparing the milk oligosaccharide profiles of five small *Canioidea* carnivore species, dogs, white nose coatis, minks, striped skunks, and raccoons. Oligosaccharides are designated as the number of {hexose}_{N-acetylhexosamine}_{fucose}_{N-acetylneuraminic acid}_{N-glycolylneuraminic acid} monomers contained in the structure, followed by a letter, to designate the isomer. The full list of oligosaccharide isomer names and their respective alphanumeric codes is provided in MilkOligoDB (Supplementary Table 1). A searchable version of Fig. 9 is available at this link (<https://cmapscloud.ihmc.us/viewer/cmap/1Z3D5ZXC0-16VKCMC-1DBG>).

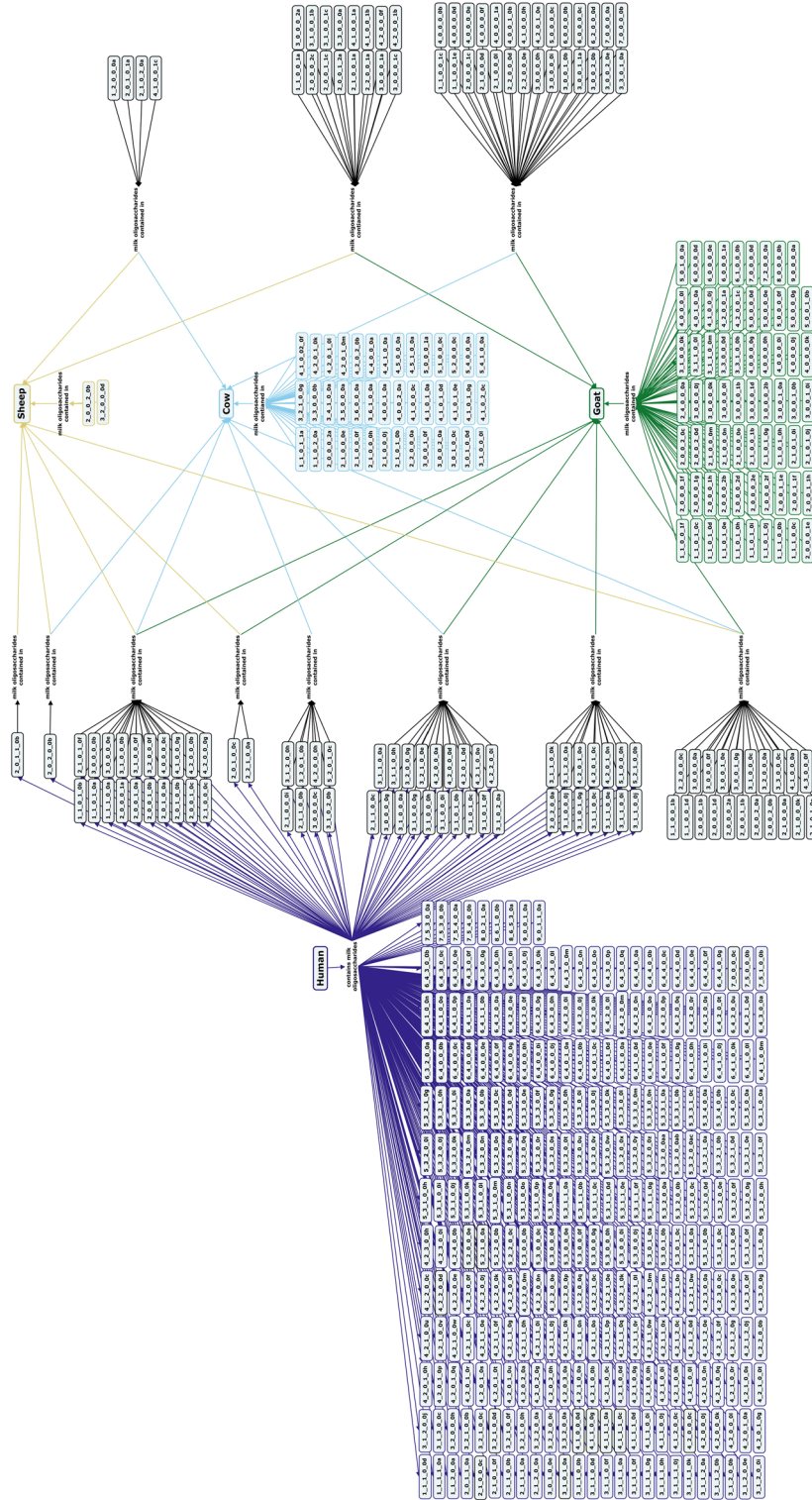

Figure 10. Concept map comparing the milk oligosaccharide profiles of commonly milked Western domesticated mammals including cows, sheep, and goats with human milk oligosaccharides. Oligosaccharides are designated as the number of {hexose}_{N-acetylhexosamine}_{fucose}_{N-acetylneuraminic acid}_{N-glycolylneuraminic acid} monomers contained in the structure, followed by a letter, to designate the isomer. The full list of oligosaccharide isomer names and their respective alphanumeric codes is provided in MilkOligoDB (Supplementary Table 1). A searchable version of Fig. 10 is available at this link (<https://cmepscloud.ihmc.us/viewer/cmep/1Z3D65W4C-BF1DY1-1K7P>).

been identified in yak milk, including both an α 1,3- and an α 1,2-fucosylated structure (Fig. 11)^{113–115}. The yak milk oligosaccharide profile also includes 3'-SL and 6'-SL, with substantially more 3'-SL than 6'-SL, similar to the milk of commercial dairy cows¹¹³.

The oligosaccharide content of buffalo milk has been investigated in several different studies, although not all studies specify what type of buffalo the milk was collected from. The carbohydrate composition of buffalo milk varies significantly between species, with a 1 to 5 ratio of milk oligosaccharides to lactose in water buffalo¹¹⁶ but a lactose concentration 500 times higher than the oligosaccharide concentration in African buffalo milk¹¹⁷. Overall, it appears that most buffalo varieties likely have predominantly small neutral and acidic oligosaccharide structures, and oligosaccharide profiles that vary over the course of lactation^{86,116,118,119}.

Camel milk is frequently consumed in Eastern Europe, north-eastern Africa, and parts of Asia. The majority of camels are dromedary, but Bactrian camels may also be milked as a food source. Compared to other commercially milked mammals, very little research has been done on the oligosaccharide content of camel milk. Dromedary camel milk has low levels of fucose- and Neu5Gc-containing oligosaccharides (14% fucosylated and 12% Neu5Gc-containing structures) and no type I cores^{97,120}. In both species, acidic oligosaccharides are more abundant than neutral oligosaccharides, but in Bactrian camel milk, fucosylated oligosaccharides outnumber Neu5Gc-containing structures 12 to 7 (Fig. 11) and acidic oligosaccharides decrease in abundance over the course of lactation^{120–122}.

Although milk from okapi as well as a number of antelope and deer species has been analyzed, the individual milk oligosaccharides of most non-domesticated species within the *Artiodactyla* order have not been profiled. Oligosaccharides were characterized in Addax milk and found to contain similar concentrations of Neu5Ac and Neu5Gc, with more α 2-3-linked than α 2-6-linked sialic acid¹²³. Seven small neutral oligosaccharides, including 5 fucosylated structures, have been identified in giraffe milk, with only one type II core structure reported^{62,116}. Four neutral and acidic oligosaccharides have been identified in reindeer milk too, which was found to be unique in both its lack of Neu5Gc- and α 2-6-linked Neu5Ac-containing oligosaccharides and the predominance of phosphorylated oligosaccharides over α 2-3-linked Neu5Ac-containing structures¹²⁴. The milk of antelope species contains about 40–50 g/kg lactose, while deer milk has lower lactose concentrations of around 26–28 g/kg⁷⁸. Many deer and antelope milk samples were collected after hunting-related deaths of the animals, but the effects of post-mortem milk sampling on oligosaccharide concentrations is unknown.

The milk oligosaccharide profiles of several porcine breeds have been analyzed, and while minimal variation has been reported between breeds, differences have been observed between pigs of different parities, as with cows and goats¹²⁵. Porcine milk contains very low levels of NeuGc-containing oligosaccharides (less than 2% of structures), making it more similar to human milk than other domesticated large mammals^{97,126,127}. Unlike human milk oligosaccharides however, porcine milk oligosaccharides are primarily acidic, with 3'-SL as the most abundant oligosaccharides, and only 16% of pig milk oligosaccharide abundance is composed of fucosylated structures^{126,128,129}.

Odd-toed ungulates. Within the order *Perissodactyla*, only black rhinoceros, donkey and horse milks have been analyzed for their oligosaccharide profiles. Black rhinoceros milk oligosaccharides are predominantly small, neutral fucosylated structures with both α 1-2- and α 1-3-linked fucose moieties (Fig. 12)⁶². Donkey milk oligosaccharides are primarily small, with 76.2% of identified structures being acidic, of which, 69.2% containing Neu5Ac and 7% containing Neu5Gc structures^{130–132}. In horses, the typical milk oligosaccharide concentration in colostrum is 0.217–4.63 g/L but falls to 0.0798 g/L in mature milk, with variation in oligosaccharide profiles between breeds and over the course of lactation^{133,134}. The majority of horse milk oligosaccharides are small neutral or acidic structures, with lower levels of Neu5Gc-containing compounds (3.5%) and lactose than cows or goats^{97,131–137}.

Other terrestrial placental mammals. From the order *Proboscidea*, both Asian and African elephants have undergone milk oligosaccharide analysis. The concentration of milk oligosaccharide changes over the course of lactation in both species, decreasing from 53.7 to around 20 g/L from early to middle lactation in Asian elephants and increasing from 8 to 21.5 g/kg from mid to late lactation in African elephants^{138–141}. Isoglobotriose was found to be the most abundant oligosaccharide in the milk of both species, although a range of fucosylated and Neu5Ac-sialylated oligosaccharides, as well as structures with type I and II cores, have also been reported in Asian elephant milk^{138,139,141}. African elephant milk contains about 5 times more lactose than oligosaccharides, while Asian elephant milk only contains about twice as much lactose as oligosaccharides^{138,140}.

In the order *Pilosa*, milk oligosaccharides have only been analyzed for one species, the giant anteater. Giant anteater milk has a 3.4 to 1 ratio of lactose to oligosaccharides. No fucosylated or α 2-3-linked Neu5Ac-containing oligosaccharides have been reported in giant anteater milk, but α 2-6-sialylated structures were detected¹⁴².

The only species from the order *Chiroptera* for which milk oligosaccharides have been profiled is the island flying fox, a bat whose milk was found to lack type I core, fucosylated and Neu5Ac-containing oligosaccharides, but which does feature milk oligosaccharides with Neu5Gc and α 1-3-linked galactose, making the oligosaccharide profile of island flying fox milk very dissimilar to that of human milk¹⁴³.

Aquatic placental mammals. The order *Cetacea* is divided into marine mammals with and without teeth. Of the toothed cetaceans, milk of a beluga whale and bottlenose dolphins have been analyzed. 3'-SL was the only free carbohydrate identified with certainty in beluga milk; however, because the milk sample was collected at one year postpartum, lactose and additional oligosaccharides may be present in earlier lactation milk¹⁴⁴. Reports on the oligosaccharide profile of bottlenose dolphin milk vary, with some studies reporting no milk oligosaccharides¹⁴⁵, and others reporting up to 9 g/L of oligosaccharides¹⁴⁶. In most baleen whales, lactose has been reported as the

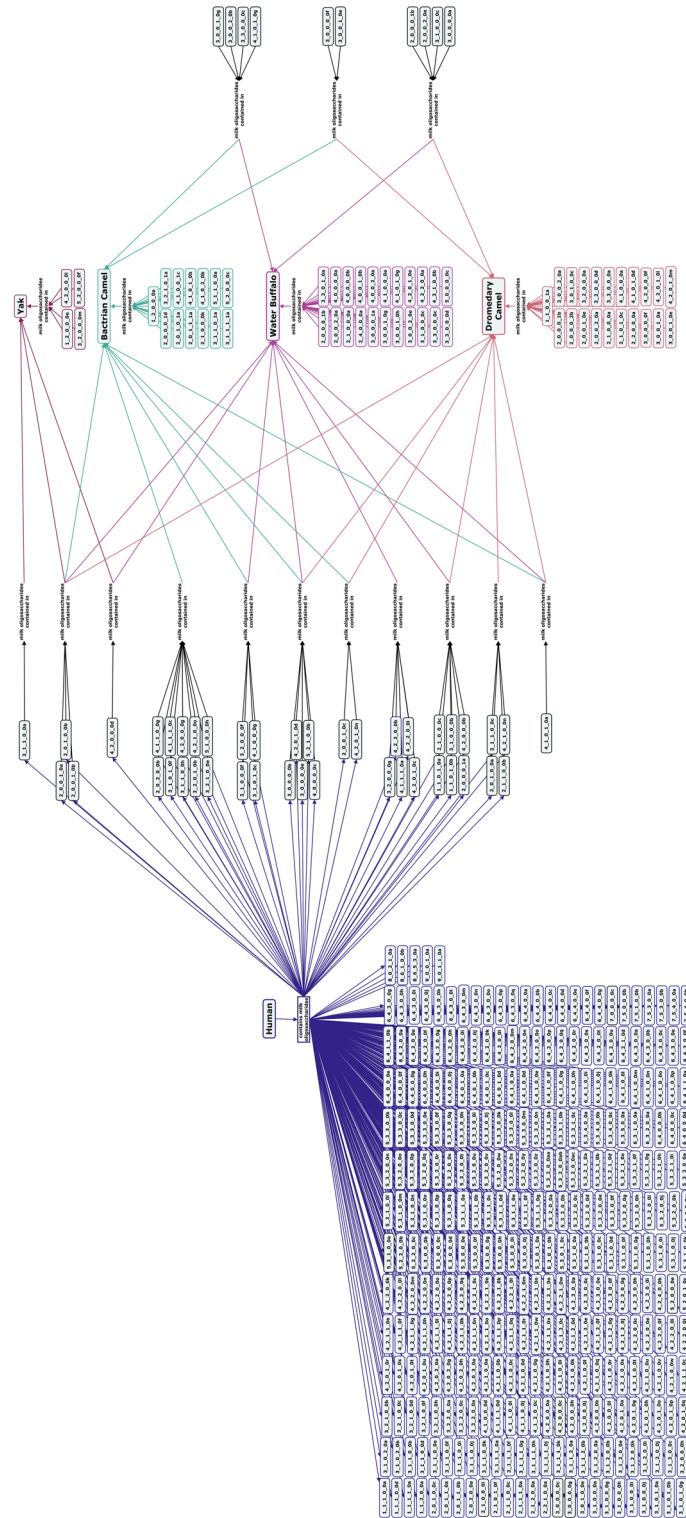

Figure 11. Concept map comparing the milk oligosaccharide profiles of other domesticated mammals milked for human consumption including dromedary and Bactrian camels, water buffalo, and yaks with human milk oligosaccharides. Oligosaccharides are designated as the number of {hexose}_{N-acetylhexosamine}_{fucose}_{N-acetylneuraminic acid}_{N-glycolylneuraminic acid} monomers contained in the structure, followed by a letter, to designate the isomer. The full list of oligosaccharide isomer names and their respective alphanumeric codes is provided in MilkOligoDB (Supplementary Table 1). A searchable version of Fig. 11 is available at this link (<https://cmapscloud.ihmc.us/viewer/cmap/1Z3D6JK9T-285NY30-1RMMK>).

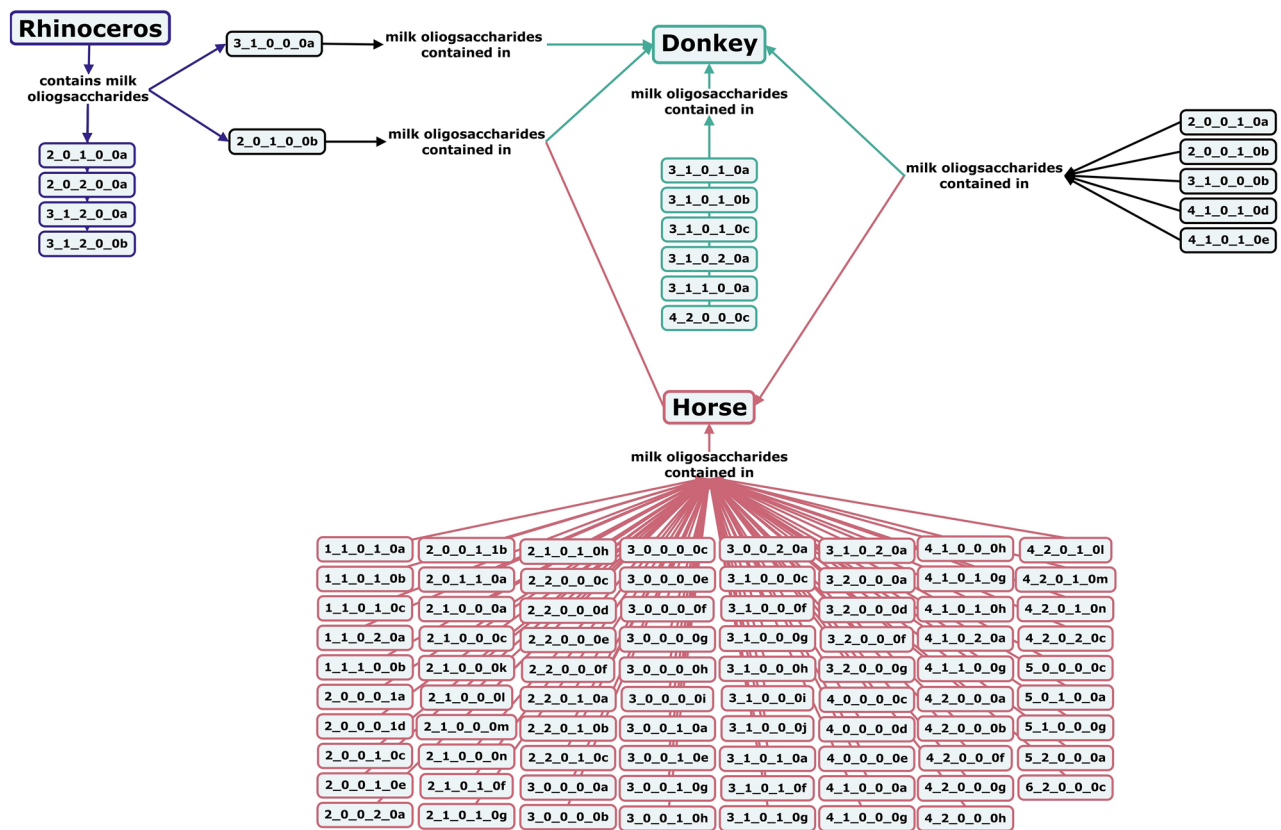

Figure 12. Concept map comparing the milk oligosaccharide profiles of three *Perissodactyla* species, black rhinoceroses, horses, and donkeys. Oligosaccharides are designated as the number of {hexose}_ {N-acetylhexosamine}_ {fucose}_ {N-acetylneuraminic acid}_ {N-glycolylneuraminic acid} monomers contained in the structure, followed by a letter, to designate the isomer. The full list of oligosaccharide isomer names and their respective alphanumeric codes is provided in MilkOligoDB (Supplementary Table 1). A searchable version of Fig. 12 is available at this link (<https://cmapscloud.ihmc.us/viewer/cmap/1Z3D6SR3X-28601XM-1TLS>).

most abundant free carbohydrate. Only Neu5Ac-containing oligosaccharides were detected in Bryde's whale and Sei whale milk¹⁴⁷, whereas fucosylated, non-fucosylated neutral, and Neu5Ac-containing oligosaccharides were detected in Minke whale milk¹⁴⁴. All baleen whale milk analyzed in these studies was collected in late lactation, and it is unknown if milk collection post-mortem impacted some oligosaccharide profiles^{144,147}.

Within the order *Pinnipedia*, no milk oligosaccharides or lactose have been detected in species within the *Otariidae* family, but a number of oligosaccharides have been identified in the milk of *Phocidae* family seals^{148,149}. In crabeater seal milk, sialylated and fucosylated oligosaccharides, including 2'-FL have been detected^{150,151}. In bearded seal, hooded seal, and arctic harbor seal milk, only type II core structures, α 1-2-linked fucosylation, and α 2-6-linked Neu5Ac sialylation of oligosaccharides were detected (Fig. 13)^{149,152–154}. Milk composition in Weddell seals has been shown to vary over the course of lactation, especially around 2 weeks postpartum when the mothers stop fasting and the total carbohydrate concentration of their milk drops. In early lactation, the carbohydrate fraction of Weddell seal milk is around 90% free oligosaccharides, which is substantially higher than that of terrestrial carnivores. Similar to bears, the low lactose concentration in pinniped milk is likely the result of evolutionary pressure toward rapid nutrient transfer from mother to offspring to more quickly prepare the pup for cold ocean temperatures and increase the size of offspring to hinder predators, a feat more easily achieved through high milk fat rather than lactose content.

The only species for which milk oligosaccharides have been analyzed in the order *Sirenia* is the Florida manatee, whose milk contains little to no lactose and low concentrations of oligosaccharides, consistent with the milk compositions of other aquatic mammals. The 3 milk oligosaccharides that have been identified in Florida manatee milk are neutral structures containing N-acetylglucosamine or fucose residues^{62,145}.

Milk oligosaccharides of marsupials. Unlike most placental mammals, the milk of many marsupials contains little to no lactose, because they lack intestinal brush border lactase, making lactose largely indigestible as a nutrient. In addition, marsupial milk does not contain oligosaccharides with Neu5Gc or type II core structures¹⁵⁵. Koalas, wombats, and common brushtail possums all have predominantly linear oligosaccharide structures, including acidic milk oligosaccharides, although no α 2,6-linked Neu5Ac has been reported in Wombat milk^{156–158}. Koalas are one of the only marsupials investigated to date that have milk containing fucosylated oligosaccharides, with 2 out of 10 reported structures containing fucose (Fig. 14)¹⁵⁷. Interestingly, based on cur-

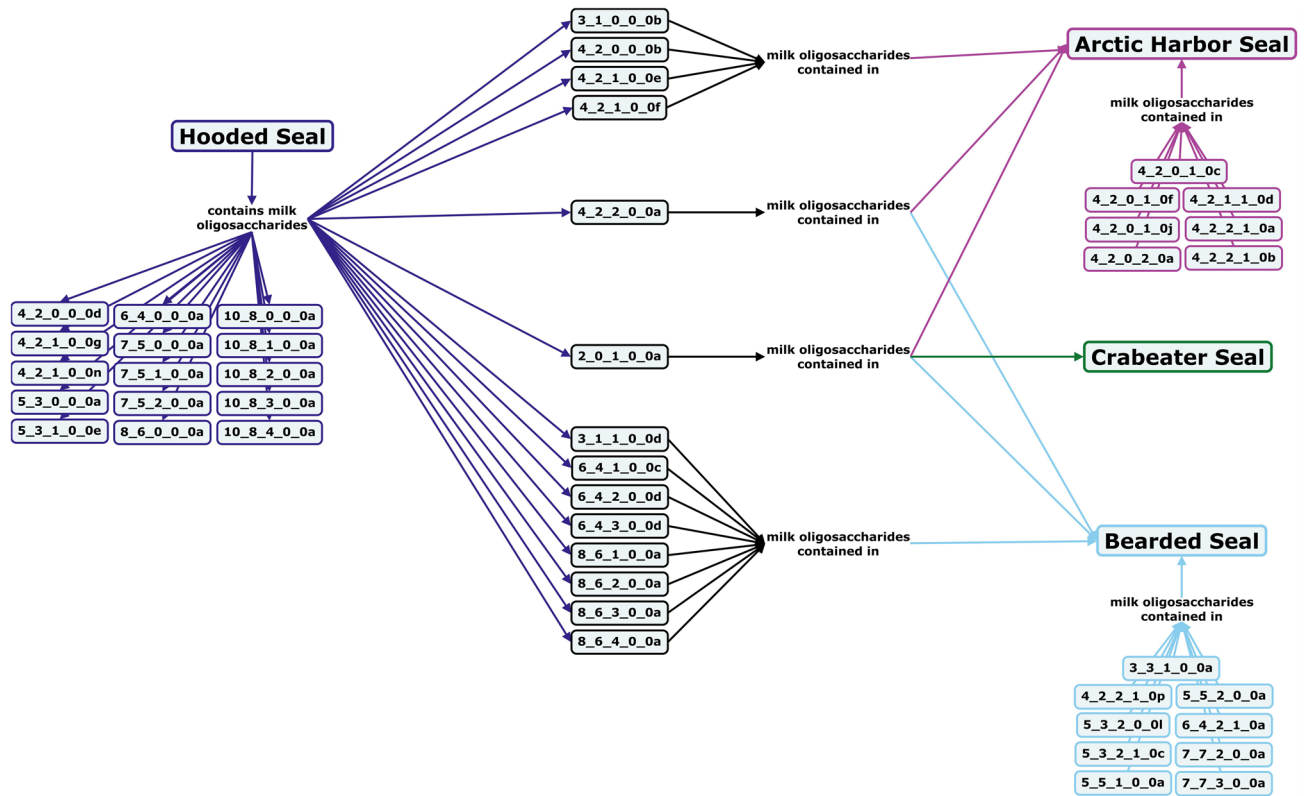

Figure 13. Concept map comparing the milk oligosaccharide profiles of four pinniped species, including hooded seals, arctic harbor seals, crabeater seals, and bearded seals. Oligosaccharides are designated as the number of {hexose}_{N-acetylhexosamine}_{fucose}_{N-acetylneuraminic acid}_{N-glycolylneuraminic acid} monomers contained in the structure, followed by a letter, to designate the isomer. The full list of oligosaccharide isomer names and their respective alphanumeric codes is provided in MilkOligoDB (Supplementary Table 1). A searchable version of Fig. 13 is available at this link (<https://cmapscloud.ihmc.us/viewer/cmapi/1Z3D6XJ3N-1P0YBBX-1VDJ>).

rently available research, Goodfellow's tree kangaroo milk does not share common oligosaccharide structures with any other marsupial species, and lacks the α 1,3-linked galactosyl moiety that is commonly featured in the milk oligosaccharides of other marsupial species⁶². Among other macropods, small and medium neutral non-fucosylated oligosaccharides have been routinely identified, and acidic oligosaccharides in a range of sizes have been reported in red kangaroo and tammar wallaby milk^{159–165}. With the exception of the carnivorous tiger quoll and eastern quoll, marsupial oligosaccharides differ from those of most other mammals in that they are primarily small and unbranched structures. (Fig. 14)^{166,167}. The carbohydrate content of tammar wallaby, eastern quoll, and common brushtail possum have all been shown to change over the course of lactation, with tammar wallaby milk showing a distinct shift in composition between milk for pouch-bound offspring and more independent, plant-eating joeys that have begun to develop a more ruminant-like digestive system^{168–171}. Many marsupial milk oligosaccharide samples were subjected to long-term freezer storage (25–35 years) prior to analysis, but the impact of such storage on milk oligosaccharide profiles is unknown.

Milk oligosaccharides of monotremes. Monotremes diverged evolutionarily from the ancestors of eutherians and marsupials an estimated 200 million years ago. Although monotremes don't have nipples, they still secrete milk to nourish their young¹⁷². Both platypus and echidna milks have levels of sialic acid similar to those of marsupials, but nearly all monotreme milk sialic acid is diacetylated Neu4,5Ac₂^{173,174}. Platypus milk features oligosaccharides with α 1,2- and α 1,3-linked fucosylation as well as type II core structures, with primarily di- and tri-fucosylated compounds (Fig. 15)^{173,175–177}. In contrast, echidna milk oligosaccharides are primarily small, simple, mono-fucosylated or mono-sialylated structures (Fig. 15)^{176,178,179}.

Discussion

Inter-species milk oligosaccharide comparisons. The unique oligosaccharide profiles of different species are likely the result of evolutionary pressures adapting milk compositions to the needs of both the mother and the neonate^{180–182}. Species in which the mothers fast during all or part of lactation appear to produce milk in which oligosaccharides are more concentrated than other carbohydrates including lactose. This pattern has been observed in bears^{72–75,183}, *Phocidae* seals^{148,149}, and baleen whales^{144,147}. In these species, oligosaccharides are likely the main free carbohydrates in milk because energy is transferred from mother to offspring mainly in

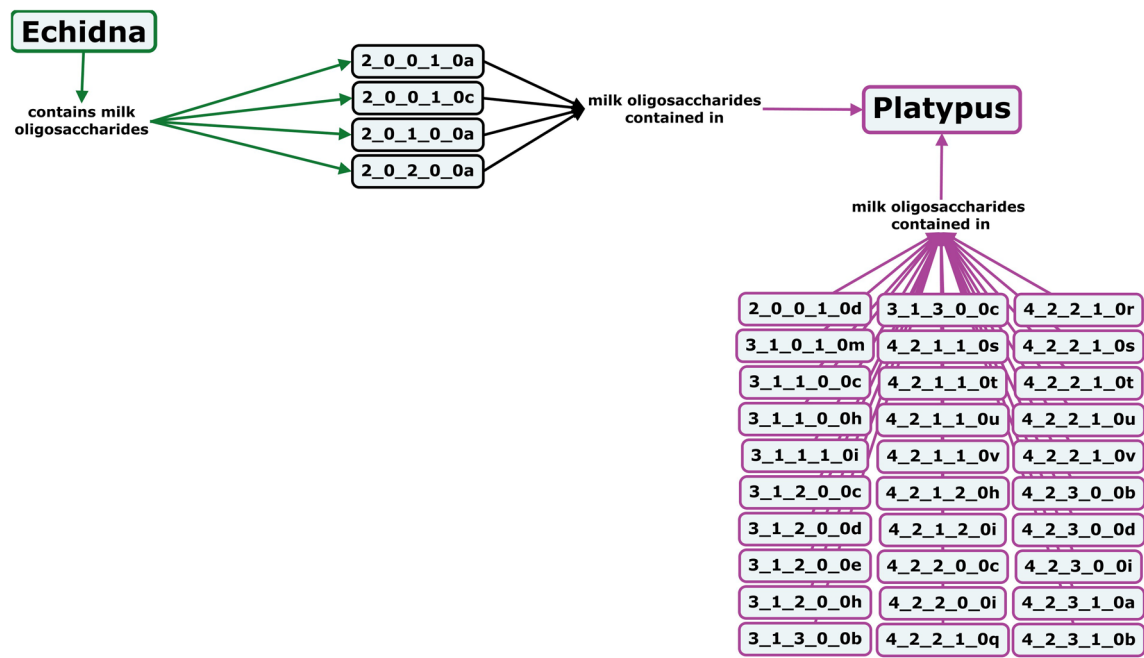

Figure 15. Concept map comparing the milk oligosaccharide profiles of two monotreme species, echidna and platypus. Oligosaccharides are designated as the number of {hexose}_{N-acetylhexosamine}_{fucose}_{N-acetylneuraminic acid}_{N-glycolylneuraminic acid} monomers contained in the structure, followed by a letter, to designate the isomer. The full list of oligosaccharide isomer names and their respective alphanumeric codes is provided in MilkOligoDB (Supplementary Table 1). A searchable version of Fig. 15 is available at this link (<https://cmapscloud.ihmc.us/viewer/cmap/1Z4BNCMSS-1RS1P2Q-13B>).

the form of lipids, not carbohydrates. In some cases, this may be due to the need for rapid offspring growth to increase mobility and avoid predations or the need to increase in neonatal body fat to ensure survival under conditions of extreme cold. In other cases, the lack of mono- and disaccharides in the mother's milk may instead be the result of evolutionary pressures selecting for the preservation for the mother who, with limited energy stores, must transfer nutrients to her offspring in the manner that results in the least energy and water loss.

In placental mammal species with less-developed neonates at birth, including bears^{72,73,76,77,183}, dogs⁸⁰, minks⁸³, raccoons⁷⁹, skunks⁸², and primates^{60,61,65} including humans^{4,28,48,56,184} the milk oligosaccharide profiles feature more fucosylated structures than those of species with more precocial offspring. Because the neonates of these species have less-developed immune systems at birth, they are likely more dependent on prebiotic and immunomodulatory compounds, including fucosylated oligosaccharides, delivered by their mother's milk.

Species with long lactation periods, like elephants and primates including humans, which are phylogenetically distant but developmentally similar in terms of nervous and immune system maturation, show similar trends in oligosaccharide composition over lactation¹⁴¹. This may be related to the long, slow growth and extended lactation periods in these species. Although dolphin and toothed whale milk oligosaccharide profiles have not been monitored over the course of lactation, it is possible that similar trends would be observed in these species, given their similarly prolonged lactations.

While some milk oligosaccharides are produced by multiple species, the diversity of oligosaccharides (783 unique isomers in this report) and the many isomers that are unique to a clade or single species is reminiscent of the repertoires of antigen binding molecules in vertebrates. In vertebrates, the adaptive immune system creates antibodies which bind and remove pathogens and these antibodies are highly diverse within and between species due to genetic and structural variation¹⁸⁵. Milk oligosaccharides have an antibody-like function in that they, too, are able to bind and remove pathogens from the gut. It is likely that the evolutionary pressure of pathogen exposures of different species generated the compositional and structural diversity of milk oligosaccharides.

Sources of milk oligosaccharide variation within species. In addition to the variation in oligosaccharide profiles that occurs between species, intra-species variations have also been observed. These differences in reported oligosaccharide profiles or concentrations may be due to a number of natural causes. Variation in oligosaccharide profiles between different breeds has been observed in cows^{107,109,186}, goats⁸⁷, pigs^{125,187}, horses¹³³, and dogs⁸⁰. Even within a breed, differences in oligosaccharide abundances have been observed in cows¹⁰⁷, pigs¹²⁵, goats⁸⁷, and humans³¹ based on parity and, in humans, based on whether a birth is full- or preterm^{48,55,188,189}. Genotypes have also been shown to influence oligosaccharide profiles, specifically those associated with α _{s1}-casein production in goats¹¹⁰ and secretor and Lewis status in humans^{31,35,39,47,55,190}. In humans, variations in oligosaccharide profiles have also been associated with the presence of immune diseases, including HIV⁴⁵ and celiac disease¹⁹¹. The mother's diet may also impact the oligosaccharide profile, with a distinct shift observed in Weddell seal milk when mothers stop fasting¹⁴⁸ and changes observed in the milk of cows fed different diets¹⁹².

Oligosaccharide profiles are known to vary over the course of lactation too as the needs of the neonate change and they shift away from consuming mother's milk as their sole food source. Variation in milk oligosaccharides over the course of lactation has been well documented in cows^{93,95,105}, pigs^{125,126,129,187}, and humans^{34–36,44,52,193–197}. Variation in milk oligosaccharide profiles or concentrations of some milk oligosaccharides at multiple lactation points have also been noted in elephants¹⁴¹, bonobos⁶¹, dogs⁸⁰, polar bears⁷⁴, and tamar wallabies¹⁶⁹. This variation in milk carbohydrate profile of tamar wallaby milk is especially notable because this species can co-express milk of different compositions from different teats simultaneously if nursing both a latched, pouch-bound joey and mobile joey at the same time. With such widespread variation in milk oligosaccharide profiles over the course of lactation, it is exceedingly important that future studies report the lactation time point from which milk is being analyzed. Without this crucial information, studies on the milk oligosaccharides of the same species may seem to present conflicting data, when in fact they may simply be from disparate lactation time points.

Approximating human milk oligosaccharides: structural and compositional features. Despite the wide sources of variation, several mammalian species produce milk oligosaccharide profiles with characteristics quite similar to human milk oligosaccharides. Marsupials, monotremes, pigs, new world monkeys, *Phocidae* seals, Asian elephants, and terrestrial carnivores express milk with very low levels of Neu5Gc-containing oligosaccharides. Monotreme, elephant, raccoon, skunk, giraffe, chimpanzee, bonobo, and common marmoset milks contain relatively high numbers of fucosylated oligosaccharides. The milks of giraffes, elephants, and most primates have more type I than type II core structures. Other species like lions, cows, horses, and goats may have a greater number of oligosaccharide structures in common with human milk, but these results are skewed by the greater total number of oligosaccharides identified in these species, and it is important to also consider the structural features of the oligosaccharides in these species that are not shared with humans. To most closely mirror human milk oligosaccharides, a milk oligosaccharide profile should have little to no Neu5Gc-containing oligosaccharides, while presenting high levels of a diverse array of fucosylated oligosaccharides and substantially more type I than type II core oligosaccharides (Fig. 16). Based on the currently available research, Asian elephant, chimpanzee, and bonobo milks have the best balance of all three of these features. Summary statistics for oligosaccharide structures and compositions for each species can be found in Supplementary Table 3.

Despite their promising similarities to humans in terms of milk oligosaccharide content, not all of the species listed above are reasonable sources for milk oligosaccharide isolation. Successful milk oligosaccharide isolation at the pilot scale has been demonstrated for both cow and goat milk, and similar techniques could be applied to harness the oligosaccharide available in the milk or dairy streams originating from other commercially milked mammals^{86,198–203}. Though not at the same scale as cows, the milk or dairy side streams from producing butter and cheese from horses, Bactrian camels and goat breeds with relatively high concentrations of fucosylated oligosaccharides and low abundances of Neu5Gc-containing oligosaccharides (Figs. 10 and 11), could be used to create supplements for human infant nutrition or for use as a food ingredient in other products for human consumption. In addition, other camelid species like llamas and alpacas, which have the potential to be commercially milked, pose further possibilities for species whose milk oligosaccharide profiles warrant investigation

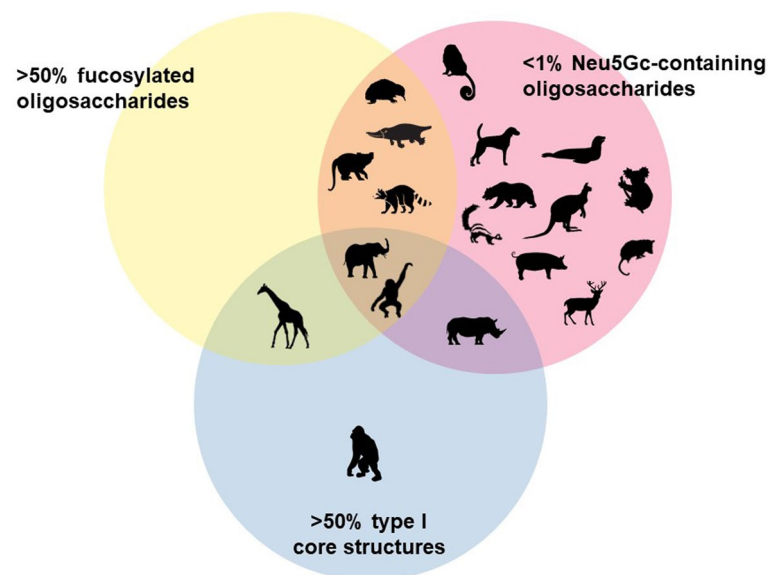

Figure 16. Venn diagram illustrating the overlap between non-human mammals to human milk oligosaccharides, based on the level of fucosylation, abundance of Neu5Gc containing oligosaccharides and the predominance of type I core structures, with comparisons based on the number of oligosaccharide structures identified with the specified characteristics.

for these purposes. More studies of the milk of these species detailing their full milk oligosaccharide profiles and oligosaccharide concentrations are still needed.

Database advantages, limitations and future perspectives. The comparisons drawn in this study are inherently limited by the depth and scope of the published studies reviewed herein. In many cases, the published results are only an indication of what the overall profile of the milk oligosaccharides for a given species may look like. A number of studies have been limited by small sample size availability, occasionally with as little as one individual chosen to represent an entire breed or species. Such sweeping assumptions come with the known risk that milk oligosaccharide profiles vary, sometimes widely, between individuals within a group. Factors such as parity, season, location, genotype, captivity status, and days in milk may have inherent influences on milk oligosaccharide profiles. Additional variation in reported results between studies may be due to the application of a wide range of milk collection methods, sample storage conditions and analytical techniques. The work reviewed here spans more than 5 decades, over which time methodology, instrumentation, and commercially available standards for milk oligosaccharide analysis have improved greatly. As the database grows tertiary analysis with additional data collected may yield new insights about the impact of these variables on milk oligosaccharide profiles.

Additionally, because the concentrations of individual oligosaccharides were not reported in most of the reviewed literature, no comparisons of the abundance of particular oligosaccharide classes or structures was made during this analysis. All descriptions of milk oligosaccharide profiles have “more” or “less” of a specific category of oligosaccharides are based on the number of reported structures of that type. As such, the analysis of any milks potentially containing a large number of very low abundant compounds with a given structural feature, or a high concentration of a single oligosaccharide may be skewed by this analysis. Cross-species studies profiling the abundances of a wide range of oligosaccharides are needed to draw more complete milk oligosaccharide comparisons. A study of this nature was undertaken by Albrecht et al. nearly a decade ago⁹¹, for a limited number of domesticated species, but further investigation is needed, particularly comparing the abundances of oligosaccharides across the species milked for human consumption that have been identified through MilkOligoDB as potential sources of oligosaccharides paralleling those found in human milk.

Further, because milk oligosaccharide entries in the database contain varying levels of detail on the corresponding structures and glycosidic linkages, there may be some inherent redundancies within the compiled oligosaccharide profiles for some species. In particular, this may arise when comparing data from NMR, enzymatic, or standard-based chromatographic isomer identifications that contain complete structural information with less detailed identifications made by mass spectral or chromatographic techniques. Similarly, it is possible that oligosaccharides identified through less detailed techniques for which complete glycosidic linkage data is not available, may appear to be shared between species without actually representing the same oligosaccharide isomer with that composition. For example, an oligosaccharide known to be composed of 3 hexoses may be identified in the milk of both cows and humans, but without further structural detail, we cannot confirm whether these two oligosaccharides share the same isomeric structure. All available structural information was included in each oligosaccharide database entry to make comparisons as accurate as possible, but such comparisons are ultimately limited by the level of structural data available in the original publications.

Despite these limitations, this database and the concept maps derived from it facilitate a cumulative analysis of all existing published milk oligosaccharide profile data that has not been previously undertaken at this magnitude. Reconciling the oligosaccharide data from existing publications into a common format allows for cross-species and cross-publication comparisons that would otherwise be hindered by the unstandardized multitude of textual, tabular, and visual formats in which oligosaccharide profiles are reported. In addition, the concept map format reveals areas that have been comparatively underinvestigated or in which there are substantial gaps or inconsistencies in the existing literature. At its heart, this platform is not only a way to compile data, but also an avenue to generate new data-driven hypotheses for future research. It is not difficult to imagine this data, and its collection going forward, in combination with databases of mammalian offspring gut microbiomes, promoting our understanding of the precise molecular mechanisms by which mammalian milk drives the establishment and maintenance of beneficial gut microbiota, immunomodulation, and brain development. In addition to adding more data, next steps for the MilkOligoDB include development of and linkage to standardized, unambiguous identifiers for all terms, development of a graphical interface that allows users to make and see comparisons across animal milks, research methods, and other experimental details, as well as development of an application programming interface (API), that enables users to query data remotely so that they can include it in their own biological databases of interest.

Conclusions

All mammals produce milk from mammary glands to suckle their young; however, the OS content of their milk can differ greatly. Although it is unlikely that the milk oligosaccharides of all mammalian species will be profiled in the near future, targeted investigations of the milk oligosaccharides of particular mammals could advance the field on several fronts. Minimal to no research has been done on the milk oligosaccharides of species from nearly half of the 19 orders within the class *Mammalia*. Profiling milk oligosaccharides from species in these relatively untouched orders, including *Dermoptera*, *Insectivora*, and *Lagomorpha* would provide improved understanding of how and why milk oligosaccharides developed from an evolutionary perspective. Further investigation into domestic species that are more commonly milked in non-western countries, such as yaks, camels, water buffalo, llamas, and alpacas would aid in the identification of potential dairy streams from which oligosaccharides could be isolated for supplementation in infant formulas and other nutraceutical products. Additional investigation into the influence of the impact of milk collection conditions, including the impact of oxytocin administration

to induce milk let-down, collection of milk post-mortem, long-term storage, and milk oligosaccharide profiles from captive animals versus those in their natural habitats would also provide further context for the interpretation of existing milk oligosaccharide data.

Continued development of the MilkOligoDB and its technical ecosystem of interfaces and update mechanisms will enable new questions to be asked and answered about milk composition across all of mammalia.

Data availability

All data analyzed in this study are present in the Supplementary Materials and available online at <https://github.com/Barile-Lab/MilkOligoDB>.

Received: 10 February 2023; Accepted: 13 June 2023

Published online: 26 June 2023

References

- Skibił, A. L., Downing, L. M., Orr, T. J. & Hood, W. R. The evolution of the nutrient composition of mammalian milks. *J. Anim. Ecol.* **82**, 1254–1264 (2013).
- Urashima, T., Saito, T., Nakamura, T. & Messer, M. Oligosaccharides of milk and colostrum in non-human mammals. *Glycoconj. J.* **18**, 357–371 (2001).
- Kellman, B. P. *et al.* Elucidating Human Milk Oligosaccharide biosynthetic genes through network-based multi-omics integration. *Nat. Commun.* **13**, 2455 (2022).
- Bai, Y. *et al.* Fucosylated human milk oligosaccharides and N-glycans in the milk of chinese mothers regulate the gut microbiome of their breast-fed infants during different lactation stages. *mSystems* <https://doi.org/10.1128/mSystems.00206-18> (2018).
- Pacheco, A. R., Barile, D., Underwood, M. A. & Mills, D. A. The impact of the milk glyco-biome on the neonate gut microbiota. *Annu. Rev. Anim. Biosci.* **3**, 419–445 (2015).
- Underwood, M. A. *et al.* Human milk oligosaccharides in premature infants: Absorption, excretion, and influence on the intestinal microbiota. *Pediatr. Res.* **78**, 670–677 (2015).
- Yu, Z.-T., Chen, C. & Newburg, D. S. Utilization of major fucosylated and sialylated human milk oligosaccharides by isolated human gut microbes. *Glycobiology* **23**, 1281–1292 (2013).
- Marcobal, A. *et al.* Consumption of human milk oligosaccharides by gut-related microbes. *J. Agric. Food Chem.* **58**, 5334–5340 (2010).
- Ward, R. E., Niñonuevo, M., Mills, D. A., Lebrilla, C. B. & German, J. B. *In vitro* fermentability of human milk oligosaccharides by several strains of bifidobacteria. *Mol. Nutr. Food Res.* **51**, 1398–1405 (2007).
- Hickey, R. M. The role of oligosaccharides from human milk and other sources in prevention of pathogen adhesion. *Int. Dairy J.* **22**, 141–146 (2012).
- Boudry, G. *et al.* Bovine milk oligosaccharides decrease gut permeability and improve inflammation and microbial dysbiosis in diet-induced obese mice. *J. Dairy Sci.* **100**, 2471–2481 (2017).
- Bode, L. *et al.* Inhibition of monocyte, lymphocyte, and neutrophil adhesion to endothelial cells by human milk oligosaccharides. *Thromb. Haemost.* **92**, 1402–1410 (2004).
- Daddaoua, A. *et al.* Goat milk oligosaccharides are anti-inflammatory in rats with hapten-induced colitis. *J. Nutr.* **136**, 672–676 (2006).
- Lara-Villoslada, F. *et al.* Oligosaccharides isolated from goat milk reduce intestinal inflammation in a rat model of dextran sodium sulfate-induced colitis. *Clin. Nutr.* **25**, 477–488 (2006).
- Li, M. *et al.* Human milk oligosaccharides shorten rotavirus-induced diarrhea and modulate piglet mucosal immunity and colonic microbiota. *ISME J.* **8**, 1609–1620 (2014).
- Sakai, F. *et al.* Effects of feeding sialyllactose and galactosylated N-acetylneuraminic acid on swimming learning ability and brain lipid composition in adult rats. *J. Appl. Glycosci.* **53**, 249–254 (2006).
- Scholtz, S. A., Gottipati, B. S., Gajewski, B. J. & Carlson, S. E. Dietary sialic acid and cholesterol influence cortical composition in developing rats. *J. Nutr.* **143**, 132–135 (2013).
- Wang, B. *et al.* Dietary sialic acid supplementation improves learning and memory in piglets. *Am. J. Clin. Nutr.* **85**, 561–569 (2007).
- Fanaro, S. *et al.* Galacto-oligosaccharides and long-chain fructo-oligosaccharides as prebiotics in infant formulas: A review: GOS and FOS in infant formulas. *Acta Paediatr.* **94**, 22–26 (2005).
- Chen, X. Human milk oligosaccharides (HMOS). In *Advances in Carbohydrate Chemistry and Biochemistry*. vol. 72 113–190 (Elsevier, 2015).
- Toukach, P. V. & Egorova, K. S. Carbohydrate structure database merged from bacterial, archaeal, plant and fungal parts. *Nucleic Acids Res.* **44**, D1229–D1236 (2016).
- Tiemeyer, M. *et al.* GlyTouCan: An accessible glycan structure repository. *Glycobiology* **27**, 915–919 (2017).
- Campbell, M. P., Royle, L., Radcliffe, C. M., Dwek, R. A. & Rudd, P. M. GlycoBase and autoGU: Tools for HPLC-based glycan analysis. *Bioinformatics* **24**, 1214–1216 (2008).
- Aloci, D. *et al.* Glyconnect: Glycoproteomics goes visual, interactive, and analytical. *J. Proteome Res.* **18**, 664–677 (2019).
- Canas, A. J. *et al.* CmapTools: A knowledge modeling and sharing environment. In *Concept Maps Theory Methodology Technology* (Editorial Universidad Publica de Navarra, 2004).
- Wu, S., Grimm, R., German, J. B. & Lebrilla, C. B. Annotation and structural analysis of sialylated human milk oligosaccharides. *J. Proteome Res.* **10**, 856–868 (2011).
- Kobata, A. Structures and application of oligosaccharides in human milk. *Proc. Jpn. Acad. Ser. B* **86**, 731–747 (2010).
- Ninonuevo, M. R. *et al.* A strategy for annotating the human milk glycome. *J. Agric. Food Chem.* **54**, 7471–7480 (2006).
- Wu, S., Tao, N., German, J. B., Grimm, R. & Lebrilla, C. B. Development of an annotated library of neutral human milk oligosaccharides. *J. Proteome Res.* **9**, 4138–4151 (2010).
- Urashima, T., Hirabayashi, J., Sato, S. & Kobata, A. Human milk oligosaccharides as essential tools for basic and application studies on galectins. *Trends Glycosci. Glycotechnol.* **30**, SE51–SE65 (2018).
- Azad, M. B. *et al.* Human milk oligosaccharide concentrations are associated with multiple fixed and modifiable maternal characteristics, environmental factors, and feeding practices. *J. Nutr.* **148**, 1733–1742 (2018).
- Cabrera-Rubio, R. *et al.* Association of maternal secretor status and human milk oligosaccharides with milk microbiota: An observational pilot study. *J. Pediatr. Gastroenterol. Nutr.* **68**, 256–263 (2019).
- van Leeuwen, S. S. *et al.* Regional variations in human milk oligosaccharides in Vietnam suggest FucTx activity besides FucT2 and FucT3. *Sci. Rep.* **8**, 16790 (2018).

34. Sprenger, N., Lee, L. Y., De Castro, C. A., Steenhout, P. & Thakkar, S. K. Longitudinal change of selected human milk oligosaccharides and association to infants' growth, an observatory, single center, longitudinal cohort study. *PLoS ONE* **12**, e0171814 (2017).
35. Thurl, S. *et al.* Variation of human milk oligosaccharides in relation to milk groups and lactational periods. *Br. J. Nutr.* **104**, 1261–1271 (2010).
36. Chaturvedi, P. *et al.* Fucosylated human milk oligosaccharides vary between individuals and over the course of lactation. *Glycobiology* **11**, 365–372 (2001).
37. Xu, G. *et al.* Absolute quantitation of human milk oligosaccharides reveals phenotypic variations during lactation. *J. Nutr.* **147**, 117–124 (2017).
38. Erney, R. M. *et al.* Variability of human milk neutral oligosaccharides in a diverse population. *J. Pediatr. Gastroenterol. Nutr.* **30**, 181–192 (2000).
39. Thurl, S., Henker, J., Siegel, M., Tovar, K. & Sawatzki, G. Detection of four human milk groups with respect to Lewis blood group dependent oligosaccharides. *Glycoconj J* **14**, 795–799 (1997).
40. Bode, L. The functional biology of human milk oligosaccharides. *Early Hum. Dev.* **91**, 619–622 (2015).
41. Tonon, K. M., de Moraes, M. B., Abrão, A. C. F. V., Miranda, A. & Moraes, T. B. Maternal and infant factors associated with human milk oligosaccharides concentrations according to secretor and Lewis phenotypes. *Nutrients* **11**, 1358 (2019).
42. Samuel, T. M. *et al.* Impact of maternal characteristics on human milk oligosaccharide composition over the first 4 months of lactation in a cohort of healthy European mothers. *Sci. Rep.* **9**, 11767 (2019).
43. McGuire, M. K. *et al.* What's normal? Oligosaccharide concentrations and profiles in milk produced by healthy women vary geographically. *Am. J. Clin. Nutr.* **105**, 1086–1100 (2017).
44. Austin, S. *et al.* Temporal change of the content of 10 oligosaccharides in the milk of Chinese urban mothers. *Nutrients* **8**, 346 (2016).
45. Bode, L. *et al.* Human milk oligosaccharide concentration and risk of postnatal transmission of HIV through breastfeeding. *Am. J. Clin. Nutr.* **96**, 831–839 (2012).
46. Moubareck, C. A., Lootah, M., Tahlak, M. & Venema, K. Profiles of human milk oligosaccharides and their relations to the milk microbiota of breastfeeding mothers in Dubai. *Nutrients* **12**, 1727 (2020).
47. Dessi, A. *et al.* Metabolomics of breast milk: The importance of phenotypes. *Metabolites* **8**, 79 (2018).
48. De Leoz, M. L. A. *et al.* Lacto-N-tetraose, fucosylation, and secretor status are highly variable in human milk oligosaccharides from women delivering preterm. *J. Proteome Res.* **11**, 4662–4672 (2012).
49. Musumeci, M., Simpori, J., D'Agata, A., Sotgiu, S. & Musumeci, S. Oligosaccharides in colostrum of Italian and Burkinabe women. *J. Pediatr. Gastroenterol. Nutr.* **43**, 372–378 (2006).
50. Chaturvedi, P., Warren, C., Ruiz-Palacios, G., Pickering, L. & Newburg, D. Milk oligosaccharide profiles by reversed-phase HPLC of their perbenzoylated derivatives. *Anal Biochem* **251**, 89–97 (1997).
51. Praticò, G. *et al.* Exploring human breast milk composition by NMR-based metabolomics. *Nat. Prod. Res.* **28**, 95–101 (2014).
52. Ferreira, A. L. *et al.* Human milk oligosaccharide profile variation throughout postpartum in healthy women in a Brazilian cohort. *Nutrients* **12**, 790 (2020).
53. McJarow, P. *et al.* Human milk oligosaccharide, phospholipid, and ganglioside concentrations in breast milk from United Arab Emirates mothers: Results from the MISC Cohort. *Nutrients* **11**, 2400 (2019).
54. Vinjamuri, A. *et al.* Human milk oligosaccharide compositions illustrate global variations in early nutrition. *J. Nutr.* **152**, 1239–1253 (2022).
55. Gabrielli, O. *et al.* Preterm milk oligosaccharides during the first month of lactation. *Pediatrics* **128**, e1520–e1531 (2011).
56. Hong, Q. *et al.* Label-free absolute quantitation of oligosaccharides using multiple reaction monitoring. *Anal. Chem.* **86**, 2640–2647 (2014).
57. Fischer Fumeaux, C. J. *et al.* Longitudinal analysis of macronutrient composition in preterm and term human milk: A prospective cohort study. *Nutrients* **11**, 1525 (2019).
58. Wilson, J. M., Schuyler, A. J., Schroeder, N. & Platts-Mills, T. A. E. Galactose- α -1,3-galactose: Atypical food allergen or model IgE hypersensitivity? *Curr. Allergy Asthma Rep.* **17**, 8 (2017).
59. Nguyen, D. H., Tangvoranuntakul, P. & Varki, A. Effects of natural human antibodies against a nonhuman sialic acid that metabolically incorporates into activated and malignant immune cells. *J. Immunol.* **175**, 228–236 (2005).
60. Tao, N. *et al.* Evolutionary glycomics: Characterization of milk oligosaccharides in primates. *J. Proteome Res.* **10**, 1548–1557 (2011).
61. Urashima, T. *et al.* Chemical characterization of oligosaccharides in chimpanzee, bonobo, gorilla, orangutan, and siamang milk or colostrum. *Glycobiology* **19**, 499–508 (2009).
62. Warren, C. D. *et al.* Comparison of oligosaccharides in milk specimens from humans and twelve other species. In *Bioactive Components of Human Milk* (ed. Newburg, D. S.) 325–332 (Plenum Publishers, 2001).
63. Goto, K. *et al.* Chemical characterization of oligosaccharides in the milk of six species of New and Old World monkeys. *Glycoconj. J.* **27**, 703–715 (2010).
64. Urashima, T. *et al.* Chemical characterisation of six oligosaccharides in a sample of colostrum of the brown capuchin, *Cebus apella* (Cebidae: Primates). *Comp. Biochem. Physiol. C* **124**, 295–300 (1999).
65. Taufik, E. *et al.* Structural characterization of neutral and acidic oligosaccharides in the milks of strepsirrhine primates: Greater galago, aye-aye, Coquerel's sifaka and mongoose lemur. *Glycoconj. J.* **29**, 119–134 (2012).
66. Uemura, Y. *et al.* Chemical characterization of milk oligosaccharides of a spotted hyena (*Crocuta crocuta*). *Comp. Biochem. Physiol. B.* **152**, 158–161 (2009).
67. Senda, A. *et al.* Chemical characterization of milk oligosaccharides of an African lion (*Panthera leo*) and a clouded leopard (*Neofelis nebulosa*). *Anim. Sci. J.* **81**, 687–693 (2010).
68. Urashima, T. *et al.* Chemical structures of oligosaccharides in milks of the American black bear (*Ursus americanus americanus*) and cheetah (*Acinonyx jubatus*). *Glycoconj. J.* **37**, 57–76 (2020).
69. Wrigglesworth, D. J. *et al.* High-throughput glycomics analyses reveal unique oligosaccharide profiles of canine and feline milk samples. *PLoS ONE* **15**, e0243323 (2020).
70. Remoroza, C. A. *et al.* Increasing the coverage of a mass spectral library of milk oligosaccharides using a hybrid-search-based bootstrapping method and milks from a wide variety of mammals. *Anal. Chem.* **92**, 10316–10326 (2020).
71. Osthoff, G., Hugo, A. & de Wit, M. The composition of cheetah (*Acinonyx jubatus*) milk. *Comp. Biochem. Physiol. B.* **145**, 265–269 (2006).
72. Urashima, T. *et al.* Chemical characterization of milk oligosaccharides of the Japanese black bear, *Ursus thibetanus japonicus*. *Biochim. Biophys. Acta* **1472**, 290–306 (1999).
73. Urashima, T. *et al.* Chemical characterization of milk oligosaccharides of the brown bear, *Ursus arctos yesoensis*. *Biochim. Biophys. Acta* **1334**, 247–255 (1997).
74. Urashima, T. *et al.* Differences in oligosaccharide pattern of a sample of polar bear colostrum and mid-lactation milk. *Comp. Biochem. Physiol. B Biochem. Mol. Biol.* **136**, 887–896 (2003).
75. Urashima, T. *et al.* Chemical characterization of milk oligosaccharides of the polar bear, *Ursus maritimus*. *Biochim. Biophys. Acta* **1475**, 395–408 (2000).

76. Zhang, Z. *et al.* Analysis of the breast milk of giant pandas (*Ailuropoda melanoleuca*) and the preparation of substitutes. *J. Vet. Med. Sci.* **78**, 747–754 (2016).
77. Nakamura, T. *et al.* Composition and oligosaccharides of a milk sample of the giant panda, *Ailuropoda melanoleuca*. *Comp. Biochem. Physiol. B.* **135**, 439–448 (2003).
78. Rezaei, R., Wu, Z., Hou, Y., Bazer, F. W. & Wu, G. Amino acids and mammary gland development: Nutritional implications for milk production and neonatal growth. *J. Anim. Sci. Biotechnol.* **7**, 20 (2016).
79. Urashima, T., Yamaguchi, E., Ohshima, T., Fukuda, K. & Saito, T. Chemical structures of oligosaccharides in milk of the raccoon (*Procyon lotor*). *Glycoconj. J.* **35**, 275–286 (2018).
80. Rostami, S. M. *et al.* Milk oligosaccharides over time of lactation from different dog breeds. *PLoS ONE* **9**, e99824 (2014).
81. Bubb, W. A. *et al.* Occurrence of an unusual lactose sulfate in dog milk. *Carbohydr. Res.* **318**, 123–128 (1999).
82. Taufik, E. *et al.* Neutral and acidic milk oligosaccharides of the striped skunk (Mephitidae: *Mephitis mephitis*). *Anim. Sci. J.* **84**, 569–578 (2013).
83. Urashima, T. *et al.* Characterization of oligosaccharides in milk of a mink. *Mustela Vis. Comp. Biochem. Physiol. A* **142**, 461–471 (2005).
84. Urashima, T. *et al.* Chemical characterisation of the oligosaccharides in a sample of milk of a white-nosed coati, *Nasua narica* (Procyonidae: Carnivora). *Comp. Biochem. Physiol. A* **123**, 187–193 (1999).
85. Martín-Ortiz, A. *et al.* Characterization of goat colostrum oligosaccharides by nano-liquid chromatography on chip quadrupole time-of-flight mass spectrometry and hydrophilic interaction liquid chromatography-quadrupole mass spectrometry. *J. Chromatogr. A* **1428**, 143–153 (2016).
86. Lee, H., Cuthbertson, D. J., Otter, D. E. & Barile, D. Rapid screening of bovine milk oligosaccharides in a whey permeate product and domestic animal milks by accurate mass database and tandem mass spectral library. *J. Agric. Food Chem.* **64**, 6364–6374 (2016).
87. Claps, S. *et al.* Sialyloligosaccharides content in colostrum and milk of two goat breeds. *Small Ruminant Res.* **121**, 116–119 (2014).
88. Hernández-Ledesma, B., Ramos, M. & Gómez-Ruiz, J. Á. Bioactive components of ovine and caprine cheese whey. *Small Ruminant Res.* **101**, 196–204 (2011).
89. Fong, B., Ma, K. & McJarrow, P. Quantification of bovine milk oligosaccharides using liquid chromatography-selected reaction monitoring-mass spectrometry. *J. Agric. Food Chem.* **59**, 9788–9795 (2011).
90. McJarrow, P. & van Amelsfort-Schoonbeek, J. Bovine sialyl oligosaccharides: Seasonal variations in their concentrations in milk, and a comparison of the colostrums of Jersey and Friesian cows. *Int. Dairy J.* **14**, 571–579 (2004).
91. Nakamura, T., Urashima, T., Nakagawa, M. & Saito, T. Sialyllactose occurs as free lactones in ovine colostrum. *Biochim. Biophys. Acta* **1381**, 286–292 (1998).
92. Liu, Z., Moate, P., Cocks, B. & Rochfort, S. Simple liquid chromatography-mass spectrometry method for quantification of major free oligosaccharides in bovine milk. *J. Agric. Food Chem.* **62**, 11568–11574 (2014).
93. Barile, D. *et al.* Neutral and acidic oligosaccharides in Holstein-Friesian colostrum during the first 3 days of lactation measured by high performance liquid chromatography on a microfluidic chip and time-of-flight mass spectrometry. *J. Dairy Sci.* **93**, 3940–3949 (2010).
94. Tao, N. *et al.* Bovine milk glycome. *J. Dairy Sci.* **91**, 3768–3778 (2008).
95. Nakamura, T. *et al.* Concentrations of sialyloligosaccharides in bovine colostrum and milk during the prepartum and early lactation. *J. Dairy Sci.* **86**, 1315–1320 (2003).
96. Urashima, T., Murata, S. & Nakamura, T. Structural determination of monosialyl trisaccharides obtained from caprine colostrum. *Comp. Biochem. Physiol. B* **116**, 431–435 (1997).
97. Albrecht, S. *et al.* A comparative study of free oligosaccharides in the milk of domestic animals. *Br. J. Nutr.* **111**, 1313–1328 (2014).
98. Dong, X., Zhou, S. & Mechref, Y. LC-MS/MS analysis of permethylated free oligosaccharides and N-glycans derived from human, bovine, and goat milk samples: Liquid phase separations. *Electrophoresis* **37**, 1532–1548 (2016).
99. Mehra, R. *et al.* Novel high-molecular weight fucosylated milk oligosaccharides identified in dairy streams. *PLoS ONE* **9**, e96040 (2014).
100. Aldredge, D. L. *et al.* Annotation and structural elucidation of bovine milk oligosaccharides and determination of novel fucosylated structures. *Glycobiology* **23**, 664–676 (2013).
101. Urashima, T., Bubb, W. A., Messer, M., Tsuji, Y. & Taneda, Y. Studies of the neutral trisaccharides of goat (*Capra hircus*) colostrum and of the one- and two-dimensional ¹H and ¹³C NMR spectra of 6'-N-acetylglucosaminylactose. *Carbohydr. Res.* **262**, 173–184 (1994).
102. Chaturvedi, P. & Sharma, C. B. Purification, by high-performance liquid chromatography, and characterization, by high-field ¹H NMR spectroscopy, of two fucose-containing pentasaccharides of goat's milk. *Carbohydr. Res.* **203**, 91–101 (1990).
103. Chaturvedi, P. & Sharma, C. B. Goat milk oligosaccharides: Purification and characterization by HPLC and high-field ¹H-NMR spectroscopy. *Biochim. Biophys. Acta* **967**, 115–121 (1988).
104. Urashima, T., Saito, T., Nishimura, J. & Ariga, H. New galactosyllactose containing α -glycosidic linkage isolated from ovine (*Booroola dorset*) colostrum. *Biochim. Biophys. Acta* **992**, 375–378 (1989).
105. Tao, N., DePeters, E. J., German, J. B., Grimm, R. & Lebrilla, C. B. Variations in bovine milk oligosaccharides during early and middle lactation stages analyzed by high-performance liquid chromatography-chip/mass spectrometry. *J. Dairy Sci.* **92**, 2991–3001 (2009).
106. Martín-Ortiz, A. *et al.* Changes in caprine milk oligosaccharides at different lactation stages analyzed by high performance liquid chromatography coupled to mass spectrometry. *J. Agric. Food Chem.* **65**, 3523–3531 (2017).
107. Robinson, R. C. *et al.* Profiling of aminoxyTMT-labeled bovine milk oligosaccharides reveals substantial variation in oligosaccharide abundance between dairy cattle breeds. *Sci. Rep.* **9**, 5465 (2019).
108. Sischo, W. M., Short, D. M., Geissler, M., Bunyatratchata, A. & Barile, D. Comparative composition, diversity, and abundance of oligosaccharides in early lactation milk from commercial dairy and beef cows. *J. Dairy Sci.* **100**, 3883–3892 (2017).
109. Sundekilde, U. K. *et al.* Natural variability in bovine milk oligosaccharides from Danish Jersey and Holstein-Friesian breeds. *J. Agric. Food Chem.* **60**, 6188–6196 (2012).
110. Meyrand, M. *et al.* Comparison of milk oligosaccharides between goats with and without the genetic ability to synthesize α -1-casein. *Small Ruminant Res.* **113**, 411–420 (2013).
111. Liu, Z. *et al.* Fine-mapping sequence mutations with a major effect on oligosaccharide content in bovine milk. *Sci. Rep.* **9**, 2137 (2019).
112. Poulsen, N. A., Robinson, R. C., Barile, D., Larsen, L. B. & Buitenhuis, B. A genome-wide association study reveals specific transferases as candidate loci for bovine milk oligosaccharides synthesis. *BMC Genom.* **20**, 404 (2019).
113. Wang, Y. *et al.* Comparative major oligosaccharides and lactose between Chinese human and animal milk. *Int. Dairy J.* <https://doi.org/10.1016/j.idairyj.2020.104727> (2020).
114. Singh, M., Kumar, A., Srivastava, G., Deepak, D. & Singh, M. P. V. Isolation, structure elucidation and DFT study on two novel oligosaccharides from yak milk. *J. Mol. Struct.* **1117**, 69–78 (2016).

115. Singh, A. K., Ranjan, A. K., Srivastava, G. & Deepak, D. Structure elucidation of two novel yak milk oligosaccharides and their DFT studies. *J. Mol. Struct.* **1108**, 87–91 (2016).
116. Mineguchi, Y. *et al.* Chemical characterization of the milk oligosaccharides of some Artiodactyla species including giraffe (*Giraffa camelopardalis*), sitatunga (*Tragelaphus spekii*), deer (*Cervus nippon yesoensis*) and water buffalo (*Bubalus bubalis*). *Glycoconj. J.* **35**, 561–574 (2018).
117. Osthoff, G., Hugo, A., de Wit, M. & Mai Nguyen, T. P. The chemical composition of milk from free-ranging African Buffalo (*Syncerus caffer*). *S. Afr. J. Wildl. Res.* **39**, 97–102 (2009).
118. Saksena, R. *et al.* A novel pentasaccharide from immunostimulant oligosaccharide fraction of buffalo milk. *Biochim. Biophys. Acta* **1428**, 433–445 (1999).
119. Aparna, H. S. & Salimath, P. V. Disialyl lactose from buffalo colostrum: Isolation and characterization. *Carbohydr. Res.* **268**, 313–318 (1995).
120. Alhaj, O. A. *et al.* Chemical characterisation of oligosaccharides in commercially pasteurised dromedary camel (*Camelus dromedarius*) milk. *Int. Dairy J.* **28**, 70–75 (2013).
121. Fukuda, K. *et al.* Chemical characterization of the oligosaccharides in Bactrian camel (*Camelus bactrianus*) milk and colostrum. *J. Dairy Sci.* **93**, 5572–5587 (2010).
122. Shi, Y., Han, B., Zhang, L. & Zhou, P. Comprehensive identification and absolute quantification of milk oligosaccharides in different species. *J. Agric. Food Chem.* **69**, 15585–15597 (2021).
123. Ganzorig, K. *et al.* Identification of sialyl oligosaccharides including an oligosaccharide nucleotide in colostrum of an addax (*Addax nasomaculatus*) (Subfamily Antelopinae). *Anim. Sci. J.* **89**, 167–175 (2018).
124. Taufik, E. *et al.* Chemical characterisation of saccharides in the milk of a reindeer (*Rangifer tarandus tarandus*). *Int. Dairy J.* **34**, 104–108 (2014).
125. Wei, J. *et al.* Characterization of porcine milk oligosaccharides over lactation between primiparous and multiparous female pigs. *Sci. Rep.* **8**, 4688 (2018).
126. Mudd, A. T. *et al.* Porcine milk oligosaccharides and sialic acid concentrations vary throughout lactation. *Front. Nutr.* **3**, 39 (2016).
127. Salcedo, J., Frese, S. A., Mills, D. A. & Barile, D. Characterization of porcine milk oligosaccharides during early lactation and their relation to the fecal microbiome. *J. Dairy Sci.* **99**, 7733–7743 (2016).
128. DiFilippo, E. *et al.* Milk oligosaccharide variation in sow milk and milk oligosaccharide fermentation in piglet intestine. *J. Agric. Food Chem.* **64**, 2087–2093 (2016).
129. Tao, N., Ochonicky, K. L., German, J. B., Donovan, S. M. & Lebrilla, C. B. Structural determination and daily variations of porcine milk oligosaccharides. *J. Agric. Food Chem.* **58**, 4653–4659 (2010).
130. Licitra, R. *et al.* Profile and content of sialylated oligosaccharides in donkey milk at early lactation. *LWT* **115**, 108437 (2019).
131. Orlandi, M., Curadi, M. C., Monti, L. & Cattaneo, T. M. P. Sialylated oligosaccharides in mare and ass milk: Preliminary results. *Prog. Nutr.* **18**, 283–287 (2016).
132. Monti, L., Cattaneo, T. M. P., Orlandi, M. & Curadi, M. C. Capillary electrophoresis of sialylated oligosaccharides in milk from different species. *J. Chromatogr. A* **1409**, 288–291 (2015).
133. DiFilippo, E. *et al.* Comparison of milk oligosaccharides pattern in colostrum of different horse breeds. *J. Agric. Food Chem.* **63**, 4805–4814 (2015).
134. Karav, S., Salcedo, J., Frese, S. A. & Barile, D. Thoroughbred mare's milk exhibits a unique and diverse free oligosaccharide profile. *FEBS Open Bio* **8**, 1219–1229 (2018).
135. Nakamura, T. *et al.* Occurrence of an unusual phosphorylated *N*-acetylglucosamine in horse colostrum. *Biochim. Biophys. Acta* **1525**, 13–18 (2001).
136. Urashima, T., Saito, T. & Kimura, T. Chemical structures of three neutral oligosaccharides obtained from horse (thoroughbred) colostrum. *Comp. Biochem. Physiol. B* **100**, 177–183 (1991).
137. Urashima, T., Sakamoto, T. & Ariga, H. Structure determination of three neutral oligosaccharides obtained from horse colostrum. *Carbohydr. Res.* **194**, 280–287 (1989).
138. Uemura, Y. *et al.* Structural determination of the oligosaccharides in the milk of an Asian elephant (*Elephas maximus*). *Comp. Biochem. Physiol. A* **145**, 468–478 (2006).
139. Osthoff, G., de Wit, M., Hugo, A. & Kamara, B. I. Milk composition of three free-ranging African elephant (*Loxodonta africana africana*) cows during mid lactation. *Comp. Biochem. Physiol. B* **148**, 1–5 (2007).
140. Osthoff, G., De Waal, H. O., Hugo, A., de Wit, M. & Botes, P. Milk composition of a free-ranging African elephant (*Loxodonta africana*) cow during early lactation. *Comp. Biochem. Physiol. A* **141**, 223–229 (2005).
141. Kunz, C., Rudloff, S., Schad, W. & Braun, D. Lactose-derived oligosaccharides in the milk of elephants: Comparison with human milk. *Br. J. Nutr.* **82**, 391–399 (1999).
142. Urashima, T. *et al.* Structural determination of the oligosaccharides in the milk of a giant anteater (*Myrmecophaga tridactyla*). *Anim. Sci. J.* **79**, 699–709 (2008).
143. Senda, A. *et al.* Chemical characterization of milk oligosaccharides of the island flying fox (*Pteropus hypomelanus*) (Chiroptera: Pteropodidae). *Anim. Sci. J.* **82**, 782–786 (2011).
144. Urashima, T. *et al.* Chemical characterization of the oligosaccharides in beluga (*Delphinapterus leucas*) and Minke whale (*Balaenoptera acutorostrata*) milk. *Comp. Biochem. Physiol. B* **132**, 611–624 (2002).
145. Fervaiz, S. & Brew, K. Composition of the milks of the bottlenose dolphin (*Tursiops truncatus*) and the Florida manatee (*Trichechus manatus latirostris*). *Comp. Biochem. Physiol. A* **84**, 357–360 (1986).
146. Uemura, Y. *et al.* Occurrence of a unique sialyl tetrasaccharide in colostrum of a bottlenose dolphin (*Tursiops truncatus*). *Biochim. Biophys. Acta* **1725**, 290–297 (2005).
147. Urashima, T. *et al.* Chemical characterization of the oligosaccharides in Bryde's whale (*Balaenoptera edeni*) and Sei whale (*Balaenoptera borealis lesson*) milk. *Comp. Biochem. Physiol. B* **146**, 153–159 (2007).
148. Eisert, R., Ofteidal, O. T. & Barrell, G. K. Milk composition in the weddell seal *Leptonychotes weddellii*: Evidence for a functional role of milk carbohydrates in pinnipeds. *Physio. Biochem. Zool.* **86**, 159–175 (2013).
149. Urashima, T. *et al.* Chemical characterisation of the oligosaccharides in hooded seal (*Cystophora cristata*) and Australian fur seal (*Arctocephalus pusillus doriferus*) milk. *Comp. Biochem. Physiol. B* **128**, 307–323 (2001).
150. Urashima, T., Hiramatsu, Y., Murata, S., Nakamura, T. & Messer, M. Identification of 2'-fucosyllactose in milk of the crabeater seal (*Lobodon carcinophagus*). *Comp. Biochem. Physiol. B Biochem. Mol. Biol.* **116**, 311–314 (1997).
151. Messer, M., Crisp, E. A. & Newgrain, K. Studies on the carbohydrate content of milk of the crabeater seal (*Lobodon carcinophagus*). *Comp. Biochem. Physiol. B* **90**, 367–370 (1988).
152. Urashima, T. *et al.* Characterization of oligosaccharides in milk of bearded seal (*Erignathus barbatus*). *Comp. Biochem. Physiol. B* **138**, 1–18 (2004).
153. Urashima, T. *et al.* Chemical characterization of the oligosaccharides in milk of high Arctic harbour seal (*Phoca vitulina vitulina*). *Comp. Biochem. Physiol. A* **135**, 549–563 (2003).
154. Kinoshita, M. *et al.* Structural characterization of multibranched oligosaccharides from seal milk by a combination of off-line high-performance liquid chromatography-matrix-assisted laser desorption/ionization-time-of-flight mass spectrometry and sequential exoglycosidase digestion. *Anal. Biochem.* **388**, 242–253 (2009).

155. Sturman, J. A., Lin, Y. Y., Higuchi, T. & Fellman, J. H. N-acetylneuramin lactose sulfate: A newly identified nutrient in milk. *Pediatr. Res.* **19**, 216–219 (1985).
156. Hirayama, K. *et al.* Chemical characterization of milk oligosaccharides of the common wombat (*Vombatus ursinus*). *Anim. Sci. J.* **87**, 1167–1177 (2016).
157. Urashima, T. *et al.* Chemical characterization of milk oligosaccharides of the koala (*Phascolarctos cinereus*). *Glycoconj. J.* **30**, 801–811 (2013).
158. Urashima, T. *et al.* Chemical characterization of milk oligosaccharides of the common brushtail possum (*Trichosurus vulpecula*). *Glycoconj. J.* **31**, 387–399 (2014).
159. Anraku, T., Fukuda, K., Saito, T., Messer, M. & Urashima, T. Chemical characterization of acidic oligosaccharides in milk of the red kangaroo (*Macropus rufus*). *Glycoconj. J.* **29**, 147–156 (2012).
160. Urashima, T. *et al.* Chemical characterization of sialyl oligosaccharides isolated from tammar wallaby (*Macropus eugenii*) milk. *Biochim. Biophys. Acta* **1200**, 64–72 (1994).
161. Bradbury, J. H., Collins, J. G., Jenkins, G. A., Trifonoff, E. & Messer, M. ¹³C-NMR study of the structures of two branched oligosaccharides from marsupial milk. *Carbohydr. Res.* **122**, 327–331 (1983).
162. Messer, M., Trifonoff, E., Collins, J. G. & Bradbury, J. H. Structure of a branched tetrasaccharide from marsupial milk. *Carbohydr. Res.* **102**, 316–320 (1982).
163. Collins, J. G., Bradbury, J. H., Trifonoff, E. & Messer, M. Structures of four new oligosaccharides from marsupial milk, determined mainly by ¹³C NMR spectroscopy. *Carbohydr. Res.* **92**, 136–140 (1981).
164. Messer, M. & Trifonoff, E. Structure of a marsupial milk trisaccharide. *Carbohydr. Res.* **83**, 327–334 (1980).
165. Messer, M. & Mossop, G. S. Milk carbohydrates of marsupials I: Partial separation and characterization of neutral milk oligosaccharides of the eastern grey kangaroo. *Aust. J. Biol. Sci.* **30**, 379–388 (1977).
166. Urashima, T. *et al.* Chemical characterization of milk oligosaccharides of the tiger quoll (*Dasyurus maculatus*), a marsupial. *Glycoconj. J.* **33**, 797–807 (2016).
167. Urashima, T. *et al.* Chemical characterization of milk oligosaccharides of the eastern quoll (*Dasyurus viverrinus*). *Glycoconj. J.* **32**, 361–370 (2015).
168. Messer, M., Fitzgerald, P. A., Merchant, J. C. & Green, B. Changes in milk carbohydrates during lactation in the eastern quoll, *Dasyurus viverrinus* (marsupialia). *Comp. Biochem. Physiol. B.* **88**, 1083–1086 (1987).
169. Messer, M. & Green, B. Milk carbohydrates of marsupials II: Quantitative and qualitative changes in milk carbohydrates during lactation in the tammar wallaby (*Macropus eugenii*). *Aust. J. Biol. Sci.* **32**, 519–531 (1979).
170. Cowan, P. E. Changes in milk composition during lactation in the common brushtail possum, *Trichosurus vulpecula* (Marsupialia: Phalangeridae). *Reprod. Fertil. Dev.* **1**, 325–335 (1989).
171. Crisp, E. A., Cowan, P. E. & Messer, M. Changes in milk carbohydrates during lactation in the common brushtail possum, *Trichosurus vulpecula* (Marsupialia: Phalangeridae). *Reprod. Fertil. Dev.* **1**, 309–314 (1989).
172. Bininda-Emonds, O. R. P. *et al.* The delayed rise of present-day mammals. *Nature* **446**, 507–512 (2007).
173. Urashima, T. *et al.* 4-O-Acetyl-sialic acid (Neu4,5Ac2) in acidic milk oligosaccharides of the platypus (*Ornithorhynchus anatinus*) and its evolutionary significance. *Glycobiol.* **25**, 683–697 (2015).
174. Messer, M. & Kerry, K. R. Milk carbohydrates of the echidna and the platypus. *Science* **180**, 201–203 (1973).
175. Amano, J., Messer, M. & Kobata, A. Structures of the oligosaccharides isolated from milk of the platypus. *Glycoconj. J.* **2**, 121–135 (1985).
176. Jenkins, G. A., Bradbury, J. H., Messer, M. & Trifonoff, E. Determination of the structures of fucosyl-lactose and difucosyl-lactose from the milk of monotremes, using ¹³C NMR spectroscopy. *Carbohydr. Res.* **126**, 157–161 (1984).
177. Messer, M., Gadiel, P., Ralston, G. & Griffiths, M. Carbohydrates of the milk of the platypus. *Aust. J. Bio. Sci.* **36**, 129 (1983).
178. Kamerling, J. P., Dorland, L., vanHalbeek, H. & Vliegert-Hart, J. F. G. Structural studies of 4-O-acetyl-a-N-acetylneuraminyl-(2->3)-lactose, the main oligosaccharide in echidna milk. *Carbohydr. Res.* **100**, 331–340 (1982).
179. Messer, M. Identification of N-acetyl-4-O-acetylneuraminyl-lactose in echidna milk. *Biochem. J.* **139**, 415–420 (1974).
180. Urashima, T., Fukuda, K. & Messer, M. Evolution of milk oligosaccharides and lactose: A hypothesis. *Animal* **6**, 369–374 (2012).
181. Varki, A. & Altheide, T. K. Comparing the human and chimpanzee genomes: Searching for needles in a haystack. *Genome Res.* **15**, 1746–1758 (2005).
182. Messer, M. & Urashima, T. Evolution of milk oligosaccharides and lactose. *Trends Glycosci. Glycotechnol.* **14**, 153–176 (2002).
183. Urashima, T. *et al.* Chemical characterization of sialyl oligosaccharides in milk of the Japanese black bear, *Ursus thibetanus japonicus*. *Comp. Biochem. Physiol. B.* **139**, 587–595 (2004).
184. Amano, J., Osanai, M., Orita, T., Sugahara, D. & Osumi, K. Structural determination by negative-ion MALDI-QIT-TOF MSn after pyrene derivatization of variously fucosylated oligosaccharides with branched decaose cores from human milk. *Glycobiology* **19**, 601–614 (2009).
185. de los Rios, M., Criscitiello, M. F. & Smider, V. V. Structural and genetic diversity in antibody repertoires from diverse species. *Curr. Opin. Struct. Biol.* **33**, 27–41 (2015).
186. Sunds, A. V. *et al.* Comparison of bovine milk oligosaccharides in native North European cattle breeds. *Int. Dairy J.* **114**, 104917 (2021).
187. Cheng, L. *et al.* Annotation of porcine milk oligosaccharides throughout lactation by hydrophilic interaction chromatography coupled with quadrupole time of flight tandem mass spectrometry. *Electrophoresis* **37**, 1525–1531 (2016).
188. Spevacek, A. R. *et al.* Infant maturity at birth reveals minor differences in the maternal milk metabolome in the first month of lactation. *J. Nutr.* **145**, 1698–1708 (2015).
189. Nakhla, T., Fu, D., Zopf, D., Brodsky, N. L. & Hurt, H. Neutral oligosaccharide content of preterm human milk. *Br. J. Nutr.* **82**, 361–367 (1999).
190. Totten, S. M. *et al.* Comprehensive profiles of human milk oligosaccharides yield highly sensitive and specific markers for determining secretor status in lactating mothers. *J. Proteome Res.* **11**, 6124–6133 (2012).
191. Olivares, M. *et al.* Human milk composition differs in healthy mothers and mothers with Celiac disease. *Eur. J. Nutr.* **54**, 119–128 (2015).
192. Durham, S. D. *et al.* Dietary fiber to starch ratio affects bovine milk oligosaccharide profiles. *Curr. Dev. Nutr.* <https://doi.org/10.1093/cdn/nzac033> (2022).
193. Asakuma, S. *et al.* Sialyl oligosaccharides of human colostrum: Changes in concentration during the first three days of lactation. *Biosci. Biotechnol. Biochem.* **71**, 1447–1451 (2007).
194. Coppa, G. V. *et al.* Oligosaccharides in human milk during different phases of lactation. *Acta Paediatr. Suppl.* **88**, 89–94 (1999).
195. Sumiyoshi, W. *et al.* Sialyl oligosaccharides in the milk of Japanese women: Changes in concentration during the course of lactation. *J. Appl. Glycosci.* **50**, 461–467 (2003).
196. Asakuma, S. *et al.* Variation of major neutral oligosaccharides levels in human colostrum. *Eur. J. Clin. Nutr.* **62**, 488–494 (2008).
197. Plows, J. F. *et al.* Longitudinal changes in human milk oligosaccharides (HMOs) over the course of 24 months of lactation. *J. Nutr.* **151**, 876–882 (2021).
198. de Moura Bell, J. *et al.* An integrated bioprocess to recover bovine milk oligosaccharides from colostrum whey permeate. *J. Food Eng.* **216**, 27–35 (2018).
199. Aquino, L. *et al.* Purification of caprine oligosaccharides at pilot-scale. *J. Food Eng.* **214**, 226–235 (2017).

200. Cohen, J. L., Barile, D., Liu, Y. & de Moura-Bell, J. Role of pH in the recovery of bovine milk oligosaccharides from colostrum whey permeate by nanofiltration. *Int. Dairy J.* **66**, 68–75 (2017).
201. Thum, C., Cookson, A., McNabb, W. C., Roy, N. C. & Otter, D. Composition and enrichment of caprine milk oligosaccharides from New Zealand Saanen goat cheese whey. *J. Food Compos. Anal.* **42**, 30–37 (2015).
202. Barile, D. *et al.* Permeate from cheese whey ultrafiltration is a source of milk oligosaccharides. *Int. Dairy J.* **19**, 524–530 (2009).
203. Martinez-Ferez, A. *et al.* Goats' milk as a natural source of lactose-derived oligosaccharides: Isolation by membrane technology. *Int. Dairy J.* **16**, 173–181 (2006).

Acknowledgements

The authors would like to thank Etienne Laborie, Anne-Laure Pacaud, Emeline Colet, and Chloe Duchenne for their contributions to preliminary versions of the milk oligosaccharide database. This research was supported by United States Department of Agriculture (USDA) Agricultural Research Service grant 2032-51530-026-00D. The USDA is an equal opportunity provider and employer. This work was also supported by the USDA Hatch projects #CA-D-FST-2187-H and CA-D-FST-2744-H.

Author contributions

S.D.D. and D.G.L. wrote the main manuscript text. S.D.D. and Z.W. prepared the figures and constructed the database. S.D.D., D.G.L., and M.C.L. performed data analyses. D.G.L., D.B. and M.C.L. contributed to editing the manuscript. S.D.D., D.G.L., M.C.L., and D.B. conceived of and supervised the project. All authors reviewed the manuscript.

Competing interests

The authors declare no competing interests.

Additional information

Supplementary Information The online version contains supplementary material available at <https://doi.org/10.1038/s41598-023-36866-y>.

Correspondence and requests for materials should be addressed to D.B.

Reprints and permissions information is available at www.nature.com/reprints.

Publisher's note Springer Nature remains neutral with regard to jurisdictional claims in published maps and institutional affiliations.



Open Access This article is licensed under a Creative Commons Attribution 4.0 International License, which permits use, sharing, adaptation, distribution and reproduction in any medium or format, as long as you give appropriate credit to the original author(s) and the source, provide a link to the Creative Commons licence, and indicate if changes were made. The images or other third party material in this article are included in the article's Creative Commons licence, unless indicated otherwise in a credit line to the material. If material is not included in the article's Creative Commons licence and your intended use is not permitted by statutory regulation or exceeds the permitted use, you will need to obtain permission directly from the copyright holder. To view a copy of this licence, visit <http://creativecommons.org/licenses/by/4.0/>.

© The Author(s) 2023