

Lawrence Berkeley National Laboratory

Recent Work

Title

HADRONIC WEAK PROCESSES AND THE MASS OF THE RIGHT-HANDED BOSON

Permalink

<https://escholarship.org/uc/item/9tn2z258>

Author

Forcrand, P.L. de

Publication Date

1982-07-01



Lawrence Berkeley Laboratory

UNIVERSITY OF CALIFORNIA

Physics, Computer Science &
Mathematics Division

RECEIVED
LAWRENCE
BERKELEY LABORATORY

OCT 4 1982

LIBRARY AND
DOCUMENTS SECTION

HADRONIC WEAK PROCESSES AND THE MASS OF THE
RIGHT-HANDED BOSON

Philippe Louis de Forcrand
(Ph.D. thesis)

July 1982



LBL-14692
e.2

DISCLAIMER

This document was prepared as an account of work sponsored by the United States Government. While this document is believed to contain correct information, neither the United States Government nor any agency thereof, nor the Regents of the University of California, nor any of their employees, makes any warranty, express or implied, or assumes any legal responsibility for the accuracy, completeness, or usefulness of any information, apparatus, product, or process disclosed, or represents that its use would not infringe privately owned rights. Reference herein to any specific commercial product, process, or service by its trade name, trademark, manufacturer, or otherwise, does not necessarily constitute or imply its endorsement, recommendation, or favoring by the United States Government or any agency thereof, or the Regents of the University of California. The views and opinions of authors expressed herein do not necessarily state or reflect those of the United States Government or any agency thereof or the Regents of the University of California.

July 1982

LBL-14692

HADRONIC WEAK PROCESSES AND THE MASS
OF THE RIGHT-HANDED BOSON*

Philippe Louis de Forcrand
Lawrence Berkeley Laboratory, University of California
Berkeley, CA 94720

Abstract

Various ways of obtaining a lower bound on the mass of the second charged weak boson required in a left-right symmetric gauge theory are investigated. They are all based on hadronic processes, in an effort to get more model-independent answers. From the $K_L - K_S$ mass difference, the limit obtained is $M(W_2) \gtrsim 370$ GeV, if one neglects a possible top quark influence. From non-leptonic hyperon decays, one can only derive a bound on the angle ζ which mixes the couplings of the primarily left- and right-handed W-bosons : $|\tan\zeta| \lesssim 1-2$ %. From hadronic K-decays, one obtains a limit $M(W_2) \gtrsim 280$ GeV, roughly similar to that found by Bég et al. from leptonic charged current data, but not restricted by assumptions about neutrino masses.

* This work was supported by the Director, Office of Energy Research, Office of High Energy and Nuclear Physics, Division of High Energy Physics of the U.S. Department of Energy under Contract DE-AC03-76SF00098.

Acknowledgements.

I would like to thank Doctor Robert N. Cahn for extensive guidance and encouragement, and my advisor Professor J. David Jackson for his teaching and his meticulous care over this thesis. I am also very grateful to Professor Mahiko Suzuki for much instruction, and to Professor Mary K. Gaillard for Helpful advice and discussions. Finally I would like to thank collectively everyone in the LBL theory group for providing a competitive but congenial atmosphere during my stay in Berkeley.

Table of Contents.

	page
Introduction	1
Chapter I	5
A.	5
B.	7
C.	10
D.	12
Appendix	14
Chapter II	15
A.	17
B.	21
C.	24
Appendix	28
Chapter III	30
A.	31
B.	36
C.	45
Appendix A	53
Appendix B	56
Appendix C	58
Chapter IV	62
A.	62

B.	Hadronic K decays.	68
Conclusion		75
References		78
Tables		82
Figure captions		84
Figures		86

Introduction

The Glashow-Weinberg-Salam (W-S) model of weak and electromagnetic interactions, based on the gauge group $SU(2)_{\text{left-isospin}} \times U(1)_{\text{hypercharge}}$, still stands uncontradicted by any experimental result, almost twenty years after it was first proposed¹. It has become the standard model for weak interactions up to present-day energies, and remains almost unchallenged, so much so that its validity can plausibly be assumed up to energies of $O(10^{16})$ GeV. At that energy-scale, the gauge groups $SU(3)_{\text{color}}$, $SU(2)_L$, $U(1)_Y$ can all be incorporated into a bigger group, provided the coupling constants g_2 and g_1 of $SU(2)$ and $U(1)$ satisfy²

$$g_1^2 / (g_1^2 + g_2^2) \equiv \sin^2 \theta = 3/8 .$$

This prediction, when extrapolated down to available energies, yields $\sin^2 \theta \approx .21$ ³, which successfully determines one of the arbitrary parameters of the W-S model, thus enhancing its credibility up to energies of the order of the unification mass $M_x \sim O(10^{16})$ GeV).

Such spectacular success of the standard model of weak and electromagnetic interactions, associated with the grand unified model based on the gauge group $SU(5)$, should guide us to look at possible variations on $SU(2) \times U(1)$ and $SU(5)$, which might help solve some of the remaining problems, among them :

- i) The hierarchy problem : The boson masses, in any grand unified theory, are clustered around the unification mass M_x , except for the weak gauge bosons W and Z , and the Higgs which gives rise to all their masses, which lie around 100 GeV. The fine tuning of the constants in

the Higgs potential necessary to generate a ratio of masses $\sim 10^{14}$ is unnatural. Together with the fact that no Higgs particle has yet been observed, it throws some doubt on the simplest Higgs mechanism used in the W-S model and in SU(5).

ii) CP violation : Several mechanisms have been proposed to explain the observed CP violation in weak interactions ; although it appears naturally with three quark generations by requiring the most general Cabibbo-like mixing matrix, other possibilities may give just as satisfactory an explanation, based on the same argument of generality.

iii) Massive neutrinos : It seems plausible that at least ν_e is massive⁴; it is also quite possible that several generations of massive neutrinos are mixed like quarks, with a Cabibbo-like matrix, and oscillations may result in a ν beam like in a K^0 beam. The standard models, SU(2) x U(1) and SU(5), do not allow for massive neutrinos, and must then be modified.

iv) Finally, the perspective of a "big desert" extending from $\sim 10^2$ to $\sim 10^{16}$ GeV, where the standard picture predicts that nothing different from what we already observe will happen, is rather uninteresting, and encourages alternative model-building. One drastically different image is provided by technicolor theories, which may bear some relevance to the hierarchy problem. Another is provided by the left-right symmetric model of weak interactions.

This model, based on the gauge group $SU(2)_L \times SU(2)_R \times U(1)_{B-L}$, is the major surviving low-energy rival of the standard model. The reason for its survival is that it reduces to the standard model if the energy-scale where parity is spontaneously broken is moved up to infinity : thus experiments confirming the standard model can only push that energy-scale up, but never rule the model out. It is appealing for several - mostly

aesthetic - reasons, besides avoiding the boredom of the big desert :

- i) It assigns left- and right-handed fermions to symmetric doublets, rather than the arbitrary - and for a long time uncertain - standard assignment of the right-handed fermions to singlets.
- ii) It restores parity at moderate energies, thus satisfying the general principle that symmetry should increase with energy.
- iii) It provides a less arbitrary definition of the hypercharge quantum number associated with the group $U(1)$, since the new hypercharge is now $(B - L)$, ie. defined in terms of other already used quantum numbers.
- iv) It lends itself to unification with the strong interaction into an $SO(10)$ gauge group, in the same way that $SU(5)$ appears in the standard picture. In $SO(10)$, all the fermions of one generation belong to the same representation $\underline{16}$, which is less arbitrary than the $\underline{10}$ and $\bar{5}$ which are required in $SU(5)$.
- v) It provides an explanation for CP violation at the Higgs level.
- vi) Like $SO(10)$, it naturally incorporates left- and right-handed neutrinos, and thus massive neutrinos. Furthermore it fits nicely with the favored explanation that ν_L is light (much lighter than its charged leptonic partner) because ν_R is very heavy ($M(\nu_R) \sim M(W_R)$).

The left-right symmetric model can also accommodate some strange and as yet unobserved phenomena like neutron oscillations or neutrinoless double β -decay. In short, the left-right symmetric model is richer than the standard model. Finally, it may receive a decisive experimental boost in the next few years, if for instance one would find that

$$M(W)/M(Z) \neq \cos Q_W .$$

We want to investigate here the implications of existing data in

non-leptonic weak processes for $SU(2)_L \times SU(2)_R \times U(1)_{B-L}$ models, and especially the information they provide about the right-handed W-boson of this model.

This thesis is organized as follows. Chapter I describes the left-right symmetric model, and the specific features of the version used later on in the gauge boson and Higgs sectors. Chapter II reviews other approaches to the same problem of determining the mass $M(W_R)$, and motivates our own approach of studying hadronic weak processes. Chapter III concentrates on the $K_L - K_S$ mass difference, and Chapter IV on other processes which are described with the help of current-algebra. The various bounds obtained in Chapters III and IV are summarized in the Conclusion.

Chapter I.

The left-right symmetric model.

Characterized by the gauge group $SU(2)_L \times SU(2)_R \times U(1)_{B-L}$, the left-right symmetric model needs an extra set of gauge bosons, compared to the standard model based on $SU(2)_L \times U(1)_Y$ alone. It also requires a more complex Higgs structure to give masses to the usual fermions (to which is added a right-handed ν) and to the bosons. A quick comparison chart with the standard model can be found in the Appendix on p.14.

Here we will give a somewhat more detailed description of the masses acquired by the gauge bosons, the fermions and the Higgses ; some of these results will be used in Chapter III. The left-right symmetric model has been studied extensively ⁵ ; this chapter is based essentially on previous work by G. Senjanovic ⁶.

A. Particle assignment in multiplets.

i) The left- and right-handed fermions are assigned to isospin doublets, according to :

$$\begin{pmatrix} \nu_e \\ e^- \end{pmatrix}_L \quad \begin{pmatrix} \nu_\mu \\ \mu^- \end{pmatrix}_L \quad \dots \quad \begin{pmatrix} u^0 \\ d^0 \end{pmatrix}_L \quad \begin{pmatrix} c^0 \\ s^0 \end{pmatrix}_L \quad \dots ; \quad \begin{pmatrix} \nu_e \\ e^- \end{pmatrix}_R \quad \dots \quad \begin{pmatrix} u^0 \\ d^0 \end{pmatrix}_R \quad \dots$$

$$(\frac{1}{2}, 0, -1) (\frac{1}{2}, 0, -1) \quad (\frac{1}{2}, 0, \frac{1}{3}) (\frac{1}{2}, 0, \frac{1}{3}) \quad (0, \frac{1}{2}, -1) \quad (0, \frac{1}{2}, \frac{1}{3})$$

where (T_L , T_R , B-L) are the three quantum numbers of each multiplet under the three gauge groups. The electric charge operator is :

$$Q = T_{3L} + T_{3R} + (B-L)/2 \quad (1.1)$$

ii) There are three sets of gauge bosons, one for each group :

$$W_L^+, W_{3L}^- ; W_R^+, W_{3R}^- ; B$$

They combine into physical states written as :

$$W_1^+, Z_1^- ; W_2^+, Z_2^- ; \gamma$$

iii) Higgs bosons are needed to give masses to the fermions : $(\bar{\psi}_L \phi \psi_R)$ must be a singlet, which implies a Higgs multiplet $(\frac{1}{2}, \frac{1}{2}^*, 0)$. One might think of giving this multiplet a composite structure, like $(\phi_L \phi_R^*)$; but then the requirements of left-right symmetry force ϕ_L and ϕ_R into having the same vacuum expectation values, which in turn prevents building meaningful quark mass matrices. Therefore one needs a Higgs multiplet of the form :

$$\phi = \begin{pmatrix} \phi_1^0 & \phi_1^+ \\ \phi_2^- & \phi_2^0 \end{pmatrix} \quad \text{where } I_{3L} \text{ and } I_{3R} \text{ are } \begin{pmatrix} (+\frac{1}{2}, -\frac{1}{2}) & (+\frac{1}{2}, +\frac{1}{2}) \\ (-\frac{1}{2}, -\frac{1}{2}) & (-\frac{1}{2}, +\frac{1}{2}) \end{pmatrix}, \text{ and}$$

where the ϕ 's are complex scalar fields.

Since $(B-L)\phi = 0$, this multiplet cannot break the U(1) group, and more Higgses are needed to that effect. Various assignments are possible, which have no effect on our calculation of Chapter III, where we only deal with those Higgs particles which couple to fermions. We take here the simplest structure for the additional Higgs multiplets :

$$X_L = \begin{pmatrix} X_L^+ \\ X_L^0 \end{pmatrix} ; \quad X_R = \begin{pmatrix} X_R^+ \\ X_R^0 \end{pmatrix}$$

$(\frac{1}{2}, 0, 1)$ $(0, \frac{1}{2}, 1)$

Another currently favored choice ⁷ is : $(T_L \cdot T_R \cdot B-L) = (1, 0, 2)$ and

(0,1,2). Such Higgses can be made of fermion pairs $(\frac{1}{2}, 0, 1) \times (\frac{1}{2}, 0, 1)$, which leaves open the possibility of dynamical symmetry breaking ; and they can contribute a heavy Majorana mass to ν_R (see Ch. II).

The vacuum expectation values of the Higgs fields chosen here are :

$$\langle \phi \rangle = \begin{pmatrix} k & 0 \\ 0 & k' \end{pmatrix} ; \quad \langle \chi_L \rangle = \begin{pmatrix} 0 \\ v' \end{pmatrix} ; \quad \langle \chi_R \rangle = \begin{pmatrix} 0 \\ v \end{pmatrix} \quad \text{all complex} \quad (1.2)$$

Under a left-right parity transformation, all the fermion and boson fields transform into their symmetric partners ; the Higgs fields obey :

$$\phi \leftrightarrow \phi^\dagger ; \quad \chi_L \leftrightarrow \chi_R .$$

Since the coupling constants associated with $SU(2)_L$ and $SU(2)_R$ are equal, physics would not change, except that $v \neq v'$, which breaks the symmetry.

It is a remarkable fact, shown by Senjanovic ⁶, that a symmetric Higgs potential can have an absolute minimum for $\langle \chi_L \rangle \neq \langle \chi_R \rangle$ for some range of the coefficients in the potential (The same property has also been verified for the alternate choice of symmetry-breaking Higgses).

Indeed Senjanovic showed that one can have $\langle \chi_L \rangle = 0$, $\langle \chi_R \rangle = v$, which we are going to retain for simplicity in the gauge boson mass matrices (see Ch. III, Appendix A, to check that $v' \neq 0$ does not affect our result).

B. Gauge boson masses and weak currents.

From the relevant part of the Lagrangian which contains the covariant derivatives of the Higgs fields :

$$\mathcal{L} = (D_\mu \chi_L)^\dagger (D^\mu \chi_L) + (D_\mu \chi_R)^\dagger (D^\mu \chi_R) + \text{Tr} (D_\mu \phi)^\dagger (D^\mu \phi) \quad (1.3),$$

from the definition of these covariant derivatives :

$$\begin{aligned}
D_\mu \chi_L &= \partial_\mu \chi_L - \frac{i}{2} g \vec{\tau} \cdot \vec{W}_L \chi_L \\
D_\mu \chi_R &= \partial_\mu \chi_R - \frac{i}{2} g \vec{\tau} \cdot \vec{W}_R \chi_R \\
D_\mu \phi &= \partial_\mu \phi - \frac{i}{2} g (\vec{\tau} \cdot \vec{W}_L \phi - \phi \vec{\tau} \cdot \vec{W}_R)
\end{aligned}
\quad \text{where } \vec{\tau} = \vec{\sigma} \quad (1.4)$$

and from the vacuum expectation values :

$$\langle \chi_L \rangle = 0 ; \langle \chi_R \rangle = \begin{pmatrix} 0 \\ v \end{pmatrix} ; \langle \phi \rangle = \begin{pmatrix} k & 0 \\ 0 & k' \end{pmatrix} \quad (1.5)$$

one can derive the following mass matrices (The gauge boson mass matrices in Ref. 6 are all in error by a factor 2) :

i) for the charged W's :

$$M_W^2 = \begin{pmatrix} W_L & \\ & W_R \end{pmatrix} \begin{pmatrix} \frac{1}{2} g^2 (k^2 + k'^2) & -g^2 k k' \\ -g^2 k k' & \frac{1}{2} g^2 (k^2 + k'^2 + v^2) \end{pmatrix} \quad (1.6)$$

which can be diagonalized according to :

$$\begin{pmatrix} W_1 \\ W_2 \end{pmatrix} = \begin{pmatrix} \cos \zeta & \sin \zeta \\ -\sin \zeta & \cos \zeta \end{pmatrix} \begin{pmatrix} W_L \\ W_R \end{pmatrix} \quad (1.7a)$$

$$\text{where } \tan 2\zeta = -4 \frac{k k'}{v^2} \quad (1.7b)$$

The phenomenological requirements that ζ be small (see Ch. IV,A and Ref.16)

and that $M(W_2) \gg M(W_1)$ imply that

$$v \gg k, k'$$

In that approximation,

$$\begin{aligned}
M^2(W_1) &\sim \frac{1}{2} g^2 (k^2 + k'^2) \\
M^2(W_2) &\sim \frac{1}{2} g^2 v^2
\end{aligned} \quad (1.8)$$

One can see that $\frac{M^2(W_1)}{M^2(W_2)} \sim O(\tan\zeta)$, unless k and k' are not of the same order of magnitude. In fact we are interested in checking whether values of $M(W_2)$ much lower than $M(W_1)/\sqrt{\tan\zeta}$ are plausible, and so we have to assume, for example, $k' \ll k$. In Chapter III we will take $k' = 0$, and eventually see how our result changes for $k' \neq 0$.

The charged weak currents carried by W_1 and W_2 are :

$$J_1 = J_L \cos\zeta + J_R \sin\zeta \quad ; \quad J_2 = -J_L \sin\zeta + J_R \cos\zeta \quad , \quad (1.9)$$

with $J_L^{\mu+} = \bar{\nu}_{eL} \gamma^\mu e_L + \bar{\nu}_{\mu L} \gamma^\mu \mu_L + \dots + \bar{U}^{\circ}_L \gamma^\mu D^{\circ}_L$

where U° and D° are column vectors made of u - and d -type quark weak eigenstates.

ii) for the neutral Z's :

The same part of the Lagrangian (1.3) containing the Higgs covariant derivatives also yields the following mass matrix :

$$M_Z^2 = \begin{matrix} W_{3L} \\ W_{3R} \\ B \end{matrix} \begin{pmatrix} \frac{1}{2} g^2 (k^2 + k'^2) & -\frac{1}{2} g^2 (k^2 + k'^2) & 0 \\ -\frac{1}{2} g^2 (k^2 + k'^2) & \frac{1}{2} g^2 (k^2 + k'^2 + v^2) & -\frac{1}{2} g g' v^2 \\ 0 & -\frac{1}{2} g g' v^2 & \frac{1}{2} g'^2 v^2 \end{pmatrix} \quad (1.10)$$

If we define the analog of the Weinberg angle, θ , by :

$$\sin^2 \theta \equiv \frac{g'^2}{(g^2 + 2g'^2)} \quad , \quad (1.11)$$

then the following combination is massless and corresponds to the photon :

$$A_\mu = (W_{3L} + W_{3R})_\mu \sin\theta + B_\mu \sqrt{\cos 2\theta} \quad (1.12)$$

The mass matrix for the other two particles can be written in a basis where it is almost diagonal :

$$\begin{aligned}
Z_1 &= (W_{3L} \cos\theta - W_{3R} \sin\theta \tan\theta - B \tan\theta \sqrt{\cos 2\theta}), \\
Z_2 &= (W_{3R} \frac{\sqrt{\cos 2\theta}}{\cos\theta} - B \tan\theta),
\end{aligned}
\quad M^2 = \begin{pmatrix} \frac{a}{\cos^2\theta} & -a \frac{\sqrt{\cos 2\theta}}{\cos^2\theta} \\ -a \frac{\sqrt{\cos 2\theta}}{\cos^2\theta} & a \frac{\cos 2\theta}{\cos^2\theta} + b \end{pmatrix} \quad (1.13)$$

where

$$a \equiv \frac{1}{2} g^2 (k^2 + k'^2) \quad ; \quad b \equiv \frac{1}{2} (g^2 + g'^2) v^2$$

For $v \gg k, k'$, the above matrix is approximately diagonal, and one recognizes the lighter boson mass :

$$M(Z_1) \sim \frac{\sqrt{a}}{\cos\theta} \sim \frac{M(W_1)}{\cos\theta} \quad (1.14)$$

$$\text{whereas } M(Z_2) \sim b \sim M(W_2) \frac{\cos\theta}{\sqrt{\cos 2\theta}}$$

The neutral weak currents are, in the same approximation :

$$\begin{aligned}
J_\mu(Z_1) &\sim \frac{g}{\cos\theta} \bar{\psi} \gamma_\mu (T_3 L - Q \sin^2\theta) \psi \\
J_\mu(Z_2) &\sim g \frac{\cos\theta}{\sqrt{\cos 2\theta}} \bar{\psi} \gamma_\mu [T_3 (R + L \tan^2\theta) - Q \tan^2\theta] \psi
\end{aligned} \quad (1.15)$$

where R, L are the helicity projectors $\frac{1}{2} (1 \pm \gamma_5)$.

The usual relations for the mass and the current of the lighter neutral boson thus reappear in the limit where the mass of the heavier one (ie. v) increases to infinity.

C. Fermion masses.

Fermion masses stem from the vacuum expectation value of ϕ in (1.5). The other Higgs particles do not contribute, since they are singlets of $SU(2)_L$ or $SU(2)_R$.

The relevant part of the Lagrangian, containing the Yukawa terms, can

be written in the most general form compatible with hermiticity and left-right symmetry :

$$\mathcal{L}_Y = \overline{(\psi^{\circ}_L)_i} (A_{ij}\phi + B_{ij}\tilde{\phi}) (\psi^{\circ}_R)_j + \overline{(\psi^{\circ}_R)_j} (A_{ij}^*\phi^+ + B_{ij}^*\tilde{\phi}^+) (\psi^{\circ}_L)_i \quad (1.16)$$

$$\text{where } \tilde{\phi} \equiv \sigma_2 \phi^* \sigma_2 = \begin{pmatrix} \phi_2^{\circ*} & -\phi_2^+ \\ -\phi_1^- & \phi_1^{\circ*} \end{pmatrix} \quad (1.17)$$

and $(\psi^{\circ})_i$ is a fermion isospin doublet, i being the generation index. The superscript \circ indicates that we are dealing with weak eigenstates, and therefore we want to generate the Cabibbo angle by having off-diagonal terms relating different generations : this is why the Yukawa couplings A and B must be matrices (2×2 for two quark generations).

One then obtains the following mass matrices for the U- and D-type quarks :

$$m_U = (kA + k'^*B) ; \quad m_D = (k'A + k^*B) \quad (1.18)$$

Under left-right symmetry : $\psi_L \leftrightarrow \psi_R ; \phi \leftrightarrow \phi^+$. Then the invariance of the Lagrangian (1.16) implies that A and B be hermitian. We will take them, as well as $\langle \phi \rangle$, to be real ; a more general approach would only be useful to study CP violation. Then m_U and m_D are real symmetric ; they can be diagonalized by rotations R_U and R_D :

$$R_{U,D}^{-1} m_{U,D} R_{U,D} \equiv \Delta_{U,D} \quad (1.19)$$

The physical fields (mass eigenstates) form multiplets U and D obtained from the weak eigenstates multiplets U° and D° by the above rotations $R_{U,D}$. This follows from consideration of the Lagrangian (1.16) :

$$\mathcal{L}_Y = \overline{U^{\circ}_L} m_U U^{\circ}_R + \overline{U^{\circ}_R} m_U^+ U^{\circ}_L + U \leftrightarrow D$$

$$\text{or } \mathcal{L}_Y = \overline{(R_U^{-1} U^\circ)_L} (R_U^{-1} m_U R_U) (R_U^{-1} U^\circ)_R + \text{h.c.} + U \leftrightarrow D$$

$$\text{ie. } U = R_U^{-1} U^\circ ; D = R_D^{-1} D^\circ \quad (1.20)$$

The Cabibbo angle then appears in the charged weak currents as the difference between the angles of R_D and R_U :

$$J_{L\mu}^+ = \frac{g}{\sqrt{2}} \left[\overline{\nu_{eL}} \gamma_\mu e_L + \dots + \overline{U_L} \gamma_\mu (R_U^{-1} R_D) D_L \right] \quad (1.21)$$

and similarly for the right-handed current. So the left and right Cabibbo angles are the same : the Cabibbo matrix is $R = R_U^{-1} R_D$, and there are no flavor-changing neutral currents.

D. Higgs bosons.

The representations filled by Higgses are $(\frac{1}{2}, \frac{1}{2}^*, 0)$, $(\frac{1}{2}, 0, 1)$ and $(0, \frac{1}{2}, 1)$, which correspond to :

$$4 + 2 + 2 = 8 \text{ real neutral fields ;}$$

$$2 \times (2 + 1 + 1) = 8 \text{ charged fields.}$$

Several of these become longitudinal degrees of freedom of massive gauge bosons :

$$2 \times 2 \text{ for the charged } W_1 \text{ and } W_2 ;$$

$$2 \times 1 \text{ for the neutral } Z_1 \text{ and } Z_2 .$$

We are left with the following physical Higgses :

$$6 \text{ neutral , } 4 \text{ charged.}$$

The mass spectrum of these particles has been studied by Senjanovic⁶ : all are heavy, with a mass $O(M(W_R))$, except for one neutral Higgs with a mass $O(M(W_L))$. The mass matrices for charged and neutral Higgses will be needed in Chapter III, and are displayed in Ch.III, Appendix A, p.53.

The Yukawa couplings of ϕ are given by \mathcal{L}_Y (1.16). It is worthwhile to write down the couplings explicitly, since they will also be used in Chapter III :

$$\begin{aligned}
 \text{for } \phi_1^\pm &: \phi_1^+ \left[\overline{U}_L (R^{-1}A) D_R + \overline{U}_R (-R^{-1}B) D_L \right] + \phi_1^- \left[\overline{D}_L (-BR) U_R + \overline{D}_R (AR) U_L \right] \\
 \text{for } \phi_2^\pm &: \text{same, } \phi_1^\pm \leftrightarrow \phi_2^\pm, A \leftrightarrow -B \\
 \text{for } \phi_1^\circ &: \phi_1^\circ \left[\overline{U}_L (R^{-1}AR) U_R + \overline{D}_R (B) D_L \right] + \phi_1^{\circ*} \left[\overline{U}_R (R^{-1}AR) U_L + \overline{D}_L (B) D_R \right] \\
 \text{for } \phi_2^\circ &: \text{same, } \phi_1^\circ \leftrightarrow \phi_2^{\circ*}, A \leftrightarrow +B.
 \end{aligned} \tag{1.22}$$

In these formulae, we have assumed that all the Cabibbo rotation was contained in the U-quark sector : $D^\circ = D$; $U^\circ = RU$. This simplification does not change the results of Chapter III, as shown in Ch. III, Appendix B, p.56.

Appendix

Comparison between the standard model and our model.

Gauge group	$SU(2)_L \times U(1)_Y$	$SU(2)_L \times SU(2)_R \times U(1)_{B-L}$
Coupling constants	$g \quad g'$	$g \quad g \quad g'$
Electric charge	$Q = T_3 + \frac{Y}{2}$	$Q = T_{3L} + T_{3R} + \frac{1}{2} (B-L)$
Weinberg angle	$\sin^2 \theta_W = \frac{g'^2}{(g^2 + g'^2)}$	$\sin^2 \theta = \frac{g'^2}{(g^2 + 2g'^2)}$
Fermions	L-H doublets ; R-H singlets	L-H doublets ; R-H doublets
Gauge bosons	4	7
	$W^\pm ; Z^0 ; \gamma$	$W_{1,2}^\pm ; Z_{1,2}^0 ; \gamma$
masses	$m(\gamma) = 0$	$m(\gamma) = 0$
	$m(W) \approx 80.5 \text{ GeV}$	$m(W_1) < 80.5 \text{ GeV}$
	$m(Z) = m(W) / \cos \theta_W \approx 92 \text{ GeV}$	$m(Z_1) \approx m(W_1) / \cos \theta$
		$m(W_2) > 80.5 \text{ GeV}$
		$m(Z_2) \approx m(W_2) \cos \theta / \sqrt{\cos 2\theta}$
Higgs content	$\phi = (\frac{1}{2}, 1)$	$\phi = (\frac{1}{2}, \frac{1}{2}^*, 0)$
		$\chi_L = (\frac{1}{2}, 0, 1) ; \chi_R = (0, \frac{1}{2}, 1)$
		$\langle \chi_L \rangle = 0 ; \langle \chi_R \rangle = v$, which breaks the symmetry.
Physical Higgses	1 neutral	6 neutral , 4 charged
masses	free ($\approx 0(300 \text{ GeV})$)	1 neutral $0(m(W_1))$
		9 others $0(m(W_2))$

Chapter II.

Choosing a probe for the right-handed sector.

Our aim, like that of many others before⁸, is to check the structure of the weak current, and to see whether it deviates from the (V-A) form predicted by the standard model.

For charged current processes, if we now have two gauge bosons W_1 and W_2 with couplings given by (1.7), the effective interaction Hamiltonian is :

$$H_I^{\text{eff}} = \frac{g^2}{2M(W_1)^2} \left(J_L J_L^\dagger (\cos^2 \zeta + \beta \sin^2 \zeta) + J_R J_R^\dagger (\sin^2 \zeta + \beta \cos^2 \zeta) + (J_L J_R^\dagger + J_R J_L^\dagger) \sin \zeta \cos \zeta (1-\beta) \right) \quad (2.1)$$

where $\beta \equiv M(W_1)^2/M(W_2)^2$ and ζ are both expected to be small. Keeping only the leading corrections in (2.1) yields :

$$H_I^{\text{eff}} \approx \frac{g^2}{2M(W_1)^2} \left(J_L J_L^\dagger + \beta J_R J_R^\dagger + \zeta (J_L J_R^\dagger + J_R J_L^\dagger) \right) \quad (2.2)$$

Since we are primarily interested here in measuring β , independently of ζ if possible, we should look for purely right-handed processes.

For neutral currents, the parametrization of H_I^{eff} is more model-dependent. Keeping the results of (I.B), we get in the leading order :

$$H_I^{\text{eff}} \approx \frac{g^2}{M(W_1)^2} \left(\bar{\psi} \gamma_\mu (T_3 L - Q \sin^2 \theta) \psi \right)^2 \quad (2.3)$$

as in the standard model. Obtaining a more accurate expression requires going back to the simplified mass matrix (1.13). Its eigenvalues are

$M(Z_1)^2$, $M(Z_2)^2$, and its eigenvectors $\begin{pmatrix} \cos\alpha \\ \sin\alpha \end{pmatrix}$ and $\begin{pmatrix} -\sin\alpha \\ \cos\alpha \end{pmatrix}$ respectively.

Then :

$$H_I^{\text{eff}} = \left(\frac{\cos^2\alpha}{M(Z_1)^2} + \frac{\sin^2\alpha}{M(Z_2)^2} \right) A^2 + \left(\frac{\sin^2\alpha}{M(Z_1)^2} + \frac{\cos^2\alpha}{M(Z_2)^2} \right) B^2 \quad (2.4)$$

where A and B are the currents corresponding to the fields defined in (1.13).

It is easy to show that the quantities in brackets in (2.4) are $M(Z_1)^{-2} \cdot M(Z_2)^{-2}$ times the diagonal coefficients of the matrix (1.13).

Then we obtain, after eliminating the hypercharge $\frac{Y}{2} = Q - T_{3L} - T_{3R}$:

$$A = \frac{g}{\cos\theta} (T_{3L} - Q\sin^2\theta) ; \quad B = g \frac{\cos\theta}{\sqrt{\cos 2\theta}} \left(T_{3R} + \tan^2\theta (T_{3L} - Q) \right)$$

$$H_I^{\text{eff}} = \frac{g^2}{a} \left[(T_{3L} - Q\sin^2\theta)^2 \left(1 + \frac{a}{b} \frac{\cos 2\theta}{\cos^2\theta} \right) + \left(T_{3R} + \tan^2\theta (T_{3L} - Q) \right)^2 \frac{a}{b} \frac{\cos^2\theta}{\cos 2\theta} \right] \quad (2.5)$$

where $a = \frac{1}{2} g^2 (k^2 + k'^2)$ and $b = \frac{1}{2} (g^2 + g'^2) v^2$ can be expressed in terms of $M(W_1)^2$, β and ζ , with the help of (1.6) and (1.7) :

$$a = M(W_1)^2 \cos^2\zeta \left(1 + \frac{\tan^2\zeta}{\beta} \right) ; \quad \frac{a}{b} = \frac{\beta + \tan^2\zeta}{1 + \beta \tan^2\zeta} \quad (2.6)$$

Obviously the analysis of neutral current data is rather complicated ; it involves four parameters simultaneously : $M(W_1)$, β , ζ , and θ , the equivalent of the Weinberg angle (see Ch.I, Appendix). This extra parameter has been erroneously fixed to an "accepted" value in some of the previous analyses of weak current processes in the context of the left-right symmetric model, which we are now going to review. We will look at results already obtained from neutral current data (part A), and then from charged current data (part B) ; this will motivate our own approach (part C).

A. Neutral current processes.

The neutral current data can all be fitted within 1.5σ with only the two parameters of the W-S model, $M(W)$ and θ_W (ie. with $\beta = \zeta = 0$ in our model) ; the results, including renormalization effects, are ⁹ :

$$\sin^2 \theta_W = .233 \pm .009$$

$$M(W) = 80.5 \pm 1.5 \text{ GeV}$$

(Some uncertainty remains as to the agreement with atomic parity violation data).

Additional constraints can be introduced from the limit on the proton lifetime ($\tau_p \gtrsim 2 \times 10^{30}$ years¹⁰), with the use of grand unified theories. The standard $SU(2)_L \times U(1)$ gauge group can be "unified" with the $SU(3)$ gauge group of strong interactions. At some very high energy, all these groups are embedded in a larger group (at least $SU(5)$) ; leptons and quarks are mixed in the multiplet assignment of the unifying group ; and all the gauge bosons are, too (weak-electromagnetic bosons, gluons, and others relating leptons to quarks). This unification occurs at the energy where the three running coupling constants of the three gauge groups all become equal. At that energy the normalization of the group generators fixes the value of $\sin^2 \theta_W$, which gets renormalized at lower energies. This scheme, first devised by Georgi and Glashow², explains the quantization of electric charge (since quarks and leptons are mixed in the same multiplets, their charges are related), and relates θ_W to the measurable value of α_{strong} at low energy. The success of the model stems from the value obtained for $\sin^2 \theta_W$ ($\sin^2 \theta_W \approx .21$ for $\alpha_s \approx 0.1$ ³), and from the high value of the unification mass ($M_X \sim 10^{15}$ GeV for the

above set of values), compatible with the known limit on the proton lifetime (since $\tau_P^{-1} \sim \alpha_{\text{GUM}} M_P^5 / M_X^4$).

The same unification procedure can be carried out for $SU(2)_L \times SU(2)_R \times U(1)_{B-L} \times SU(3)_{\text{color}}$. The unifying group must be at least $SO(10)$, to accomodate the increased number of generators. The fundamental representation of that group is a 16, which suits the following particle assignment :

$$\left(\begin{array}{cccc} \bar{d}_i & \nu_e & e^+ & u_j \\ d_i & \bar{\nu}_e & e^- & \bar{u}_j \end{array} \right)_L \quad i, j \text{ color indices.}$$

The value of $\sin^2 \theta(\text{GUM})$ is derived as for $SU(5)$:

$$\begin{aligned} \text{for the } \underline{16} \text{ representation, } \quad \text{Tr } T_{3R}^2 &= \text{Tr } T_{3L}^2 = 2 \\ \text{Tr } ((B-L)/2)^2 &= 4/3 \end{aligned}$$

But the generators I_{3L} , I_{3R} and I_{B-L} associated with T_{3L} , T_{3R} and $(B-L)/2$ must be normalized identically, and the same coupling constant g_{GUM} must appear in each term of the Lagrangian :

$$g_{\text{GUM}} I_{3L} = g T_{3L} \quad ; \quad g_{\text{GUM}} I_{B-L} = g' (B-L)/2$$

Then $\text{Tr } I_{3L}^2 = \text{tr } I_{B-L}^2 \implies g^2 \cdot 2 = g'^2 \cdot 4/3$

$$\text{And } \sin^2 \theta \equiv \frac{g'^2}{(g^2 + 2g'^2)} = \frac{3}{8}$$

just as for $SU(5)$ or for any group, provided the isospin and electric charge assignments of the elementary left-handed fermions remain the usual ones.

The renormalized value of $\sin^2 \theta$ at low energy differs from the $SU(5)$ value, however. The pattern of symmetry breaking, if one assumes that

left-right parity is the last symmetry to be broken when going down in energy from M_X to $M(W_1)$, must be :

$$\begin{aligned} \text{SO}(10) &\xrightarrow{M_X} \text{SU}(2)_L \times \text{SU}(2)_R \times \text{SU}(4) \xrightarrow{M_C} \text{SU}(2)_L \times \text{SU}(2)_R \times \text{U}(1)_{B-L} \times \text{SU}(3)_c \\ &\xrightarrow{M(W_2)} \text{SU}(2)_L \times \text{U}(1)_Y \times \text{SU}(3)_c \xrightarrow{M(W_1)} \text{U}(1)_{EM} \times \text{SU}(3)_c \end{aligned}$$

The evolutions of the coupling constants are derived from the usual expression for the β -function in an $\text{SU}(N)$ group with f fermion generations :

$$\beta(g) = -\frac{g^3}{16\pi^2} \left(\frac{11}{3} N - \frac{2}{3} f \right)$$

A typical pattern of running coupling constants is shown in Fig. 2.1.

In particular one obtains :

$$\sin^2 \theta(M(W_1)) = \frac{3}{8} - \frac{11}{3} \frac{\alpha_{EM}(M(W_1))}{\pi} \left(\frac{5}{8} \text{Log} \frac{M_c}{M(W_1)} - \frac{3}{8} \text{Log} \frac{M_c}{M(W_2)} \right) \quad (2.7)$$

Obviously, a lower value for $M(W_2)$ implies a higher value for $\sin^2 \theta(M(W_1))$. This fact has led some to conclude¹¹ that $M(W_2)$ had to be at least 10^9 GeV, since $\sin^2 \theta_W(M(W)) \approx .23$. However this latter value for the Weinberg angle is obtained only in the standard model, which itself implies $M(W_2) = M_X$. The limit of 10^9 GeV is therefore merely evidence of the consistency of the standard picture. A correct analysis requires a fit to the low-energy data first with the four parameters $M(W_1)$, $M(W_2)$, ζ and $\sin^2 \theta(M(W_1))$, and then a determination of which values of these parameters are still compatible with a grand unified model based on $\text{SO}(10)$.

The low-energy data have been analyzed by many¹², but the most interesting results come from Rizzo and Senjanovic¹³. They use as an

input the numbers of Kim et al. ¹⁴ extracted from :

- the SLAC asymmetry experiment (and the atomic parity violation experiments) ;
- neutrino-hadron scattering experiments ;
- $\nu_{\mu} - e$ scattering results ;

They choose the more fashionable Higgs assignment (see Ch.I,A,iii), and allow the vacuum expectation values of the left- and right-handed Higgses to be both non-zero. The ranges of values which then satisfy all the data within 1.5σ is :

$$M(W_2) \gtrsim 150 \text{ GeV, ie. } \beta \lesssim .24$$

$$.23 \lesssim \sin^2 \theta \lesssim .28$$

$$|\tan 2\zeta| \lesssim .1$$

The value of $M(W_1)$ is fixed by the overall strength of the interaction (the value of G_F) when the other three parameters have been determined ; for the range of parameters indicated above, one finds :

$$70 \text{ GeV} \lesssim M(W_1) \lesssim 78 \text{ GeV}$$

The same authors applied these results to the grand unified model based on $SO(10)$ just described, even taking into account the effect of Higgses in the β -function (They bring $M(W_2)$ down, for a given value of $\sin^2 \theta_W$) ¹⁵. Their result is therefore rather model-dependent but can be summarized as follows :

If $M(W_2) \gtrsim 1 \text{ TeV}$, the presence of the right-handed sector does not appreciably modify the fit of $\sin^2 \theta$ to the low energy data. One must have $\sin^2 \theta = .23$ as in the standard model. Then, as pointed out in previous analyses ¹¹, it is difficult to accomodate an intermediate mass

scale between $M(W)$ and M_X , unless it is almost as high as M_X , and does not seriously affect the consistent standard picture of grand unification.

Hence :

$$M(W_2) \gtrsim 1 \text{ TeV} + \text{GUTS} \implies M(W_2) \gtrsim 10^9 \text{ GeV} \quad (2.8)$$

Otherwise $M(W_2)$ must be very low, so that $\sin^2 \theta$ be increased to $\approx .27$.

Such values are still compatible with grand unification, simply pushing M_X to $\sim 10^{17}$ GeV, and making proton-decay very hard to observe.

In conclusion, according to Ref. 15 :

$$\begin{aligned} \text{either } M(W_2) \sim 150\text{--}250 \text{ GeV} \text{ and } \sin^2 \theta &= .27 \\ \text{or } M(W_2) \sim 10^9 \text{ GeV} \text{ and } \sin^2 \theta &= .23 \end{aligned} \quad (2.9)$$

This analysis, of course, depends for a good part on details of the model, like the parametrization of the neutral sector, the Higgs structure and the number of Higgs multiplets, things which might be less crucial if one studies charged-current processes.

B. Charged current processes.

The limit $M(W_R) \gtrsim 200\text{--}300$ GeV is still widely quoted in the literature. It was obtained by Bég et al.¹⁶ from charged current data, with the implicit assumption that neutrinos are massless or at least extremely light. The effective Hamiltonian they use is exactly (2.1), and they obtain the limits :

$$\begin{aligned} M(W_2)/M(W_1) &\gtrsim 2.76, \text{ ie. } M(W_2) \gtrsim 220 \text{ GeV} \\ |\tan \zeta| &\lesssim .06 \end{aligned}$$

Among the various processes analyzed, the most stringent constraints come from the longitudinal e^- polarization in pure Gamow-Teller β -decay, and

from the ρ parameter in μ decay. All the processes considered in that paper are semi-leptonic : a neutrino is produced in each case, which will in general be left-handed if the gauge boson exchanged is W_1 , and right-handed if it is W_2 .

One of the attractive features of the left-right symmetric model, though, is to allow for a massive neutrino, and furthermore to explain in a natural way why the usual - left-handed - neutrino is so much lighter than its charged leptonic partner. This mechanism, first suggested by Gell-Mann et al.¹⁷, involves giving both a Majorana and a Dirac mass to the neutrino (see Appendix for details on Majorana spinors), so that the mass matrix for the two helicity components of a given species of neutrino becomes :

$$\begin{pmatrix} \nu_L \\ \nu_R \end{pmatrix} \begin{pmatrix} m & d \\ d & M \end{pmatrix} \quad (2.10a)$$

where d is the usual Dirac mass term ($d \sim m_e$ in any grand-unified picture), and m and M are the Majorana mass terms for both neutrino components. Grand unification does not constrain them to any particular value, since the neutrino is the only particle to enjoy the possibility of a Majorana mass. But we expect, from naturalness, that they are of the same order of magnitude as the vacuum expectation values of the Higgses which give rise to them. Furthermore m has to be very small, such that indeed $m(\nu_1) \ll m_e$, ν_1 being the usual mostly-left-handed neutrino.

Several schemes have been proposed, where $m = 0$, and $M \sim O(M_X)$ ¹⁸, or $O(\alpha M_X)$ ¹⁹, yielding extremely small masses $m(\nu_1)$ as shown below. The left-right symmetric model fits the phenomenology in a very elegant

manner ²⁰ : the different values of m and M reflect the breaking of parity.

One should expect, given the Higgs structure $\Delta_L(1,0,2)$ and $\Delta_R(0,1,2)$ (see p.6-7):

$$m \sim O(\langle \Delta_L^0 \rangle) \quad \text{and} \quad m = 0 \quad \text{for} \quad \langle \Delta_L^0 \rangle = 0$$

$$M \sim O(\langle \Delta_R^0 \rangle) \sim O(M(W_R))$$

Taking $\langle \Delta_L^0 \rangle = 0$ - which is still compatible with a left-right symmetric Higgs potential - the eigenvalues of the mass matrix become :

$$m_1 \approx m_e^2 / M(W_2) \quad \text{and} \quad m_2 \approx M(W_2).$$

Then $m_1 \sim O(1 \text{ eV})$, in the expected range (see Ref. 15 for details), instead of the minuscule masses of order 10^{-8} eV obtained when $M \sim M_X$ in (2.10a).

The eigenvectors are :

$$\begin{pmatrix} \nu_1 \\ \nu_2 \end{pmatrix} = \begin{pmatrix} \cos\delta & \sin\delta \\ -\sin\delta & \cos\delta \end{pmatrix} \begin{pmatrix} \nu_L \\ \nu_R \end{pmatrix} \quad (2.10b)$$

with $\delta \sim m_e / M(W_2) \lesssim O(10^{-3})$.

In conclusion, it is likely that :

- i) The predominantly right-handed neutrino is so heavy that it cannot be produced at present-day energies, and certainly not in any of the low-energy processes analyzed in Bég et al. ¹⁶
- ii) The usual predominantly left-handed neutrino does have right-handed couplings, although by a minute amount.

These conclusions modify of course the previous studies of charged-current data. The low-energy effective Hamiltonian (2.1) now becomes, for semi-leptonic processes, when the pieces requiring production of ν_R are deleted:

$$H_I^{\text{eff}} \approx \frac{g^2}{2M(W_1)^2} \left(J_L J_L^+ \cos \delta (\cos^2 \zeta + \beta \sin^2 \zeta) - J_R J_R^+ \sin \delta (\sin^2 \zeta + \beta \cos^2 \zeta) \right. \\ \left. + (J_R J_L^+ \cos \delta - J_L J_R^+ \sin \delta) \sin \zeta \cos \zeta (1-\beta) \right) \quad (2.11)$$

and for a purely leptonic process :

$$H_I^{\text{eff}} \approx \frac{g^2}{2M(W_1)^2} \left(J_L J_L^+ \cos^2 \delta (\cos^2 \zeta + \beta \sin^2 \zeta) + J_R J_R^+ \sin^2 \delta (\sin^2 \zeta + \beta \cos^2 \zeta) \right. \\ \left. - (J_R J_L^+ + J_L J_R^+) \sin \delta \cos \delta \sin \zeta \cos \zeta (1-\beta) \right) \quad (2.12)$$

Obviously, all deviations from a (V-A)(V-A) structure are multiplied by δ and become inobservable, except for a semi-leptonic process where the right-handed current is all hadronic. However the two processes selected in Ref. 16 both involve the observation of a right-handed leptonic current : then the smallness of δ obscures any effect of a potentially very light right-handed boson.

Therefore, in order to eliminate the effects of δ , a charged-current analysis should only rely on purely hadronic processes, or semi-leptonic processes where the presence of a right-handed current should be looked for in the hadronic sector. That kind of hadronic polarization experiment seems extremely difficult to carry out, given the mass discrepancy between the usual hadrons and leptons (see however Ref.21 on polarized ¹⁹Ne β -decay). In any case, one would only get a limit on the next smallest parameter after δ , namely ζ .

C. The correct probes.

We will focus on the analysis of purely hadronic charged processes, because they are less model-dependent (and because they have not been

studied yet), namely :

- the $K_L - K_S$ mass difference, in Chapter III ;
- hadronic hyperon decays and K decays, in Chapter IV.

Of course the presence of strong interactions decreases the accuracy of theoretical calculations, but at least the $K^0 - \bar{K}^0$ system has proved to be an outstanding test for weak - and super- or milli-weak - interactions in the past ²².

However there are at least two other phenomena worth attention :

i) Neutrinoless double β -decay ($\beta\beta$)⁰ :

Majorana neutrinos are self-conjugate and can therefore be exchanged internally in a double β -decay event, leaving no neutrino in the final state (see Fig. 2.2) :

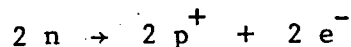

The amplitude for such a process includes a factor $\frac{M}{(p^2 - M^2)}$, for the neutrino propagator of mass M with helicity flip, which after Fourier transform gives rise to a Yukawa potential and a factor $M \exp(-\lambda M)$ *. Such a factor goes to 0 for both $M \rightarrow 0$ and $M \rightarrow \infty$; but, given the upper bound on the mass of the usual neutrino ν_e , the expression

$$\frac{M \exp(-\lambda M)}{M(W_L)^4} \quad \text{for } M \lesssim 60 \text{ eV} \quad \text{is two orders of magnitude smaller than}$$

$$\frac{M \exp(-\lambda M)}{M(W_R)^4} \quad \text{for } M \sim M(W_R) \sim 300 \text{ GeV.}$$

Double β -decay is thus a good place to look for not too heavy Majorana neutrinos ²³. The analysis has been carried out in more detail for the specific model we are considering ¹⁵. For the same mass $M \sim 300 \text{ GeV}$, the rate for double β -decay should be less than an order of magnitude below

* λ is the characteristic range of the nucleon-nucleon interaction ($\lambda^{-1} \sim 50 \text{ GeV}$)

the present experimental limit, and such decays should be observable in the next generation of experiments. That prediction, however, relies heavily on the "naturalness" of the model : all the coupling constants, in the Yukawa couplings and the Higgs potential, should be of the same order of magnitude, so that one can relate $M(W_2)$ and $M(\nu_R)$ through the Higgs vacuum expectation values. It is difficult to decide at which point the ratio $M(W_2)/M(\nu_R)$ becomes unnatural ; nonetheless the observation of double β -decay, whatever the rate, would be a very strong argument in favor of the left-right symmetric model.

ii) Variation of the Fermi constant :

For purely leptonic processes (eg. μ decay), the $J_L J_L^+$ part of H_I^{eff} (2.1) is the only one to contribute (We take $\delta = 0$ for simplicity).

One can thus identify :

$$\frac{G_F}{\sqrt{2}} \equiv \frac{g^2}{8M(W_1)^2} (\cos^2 \zeta + \beta \sin^2 \zeta)$$

Now for semi-leptonic processes (π , K decays, β -decay), the hadronic current can be right-handed as well, so that the decay rates will be the ones that one would obtain not with the above value of $G_F/\sqrt{2}$, but rather with :

$$\begin{aligned} \frac{G_F'}{\sqrt{2}} &\equiv \frac{g^2}{8M(W_1)^2} \{(\cos^2 \zeta + \beta \sin^2 \zeta) + \sin \zeta \cos \zeta (1-\beta)\} \\ &\approx \frac{G_F}{\sqrt{2}} (1 + \zeta) \end{aligned}$$

Measurements on the lepton polarization will not be affected, since they depend on the structure of the leptonic current, which remains purely left-handed.

This apparent variation of G_F should make it possible to set limits on ζ , almost independently of β . Indeed it has been argued¹³ that the factor $(1 + \zeta)^2$ should take care of a discrepancy of $3 \pm 1\%$ between the value of $f_\pi \approx 93$ MeV measured from $\pi_{\ell 2}$ decay, and the theoretical value obtained from the Goldberger-Treiman relation by evaluating the πNN hadronic coupling²⁴.

Appendix

Majorana neutrinos.

A general fermion mass term in the Lagrangian should be a Lorentz scalar made of two fermion spinors. These spinors are associated with the following representations on the $SU(2) \times SU(2)$ decomposition of the Lorentz group Lie algebra :

$$\begin{aligned} \nu_L & : (\frac{1}{2}, 0) & ; & \nu_R & : (0, \frac{1}{2}) \\ \overline{\nu}_L & : (0, \frac{1}{2}) & ; & \overline{\nu}_R & : (\frac{1}{2}, 0) \end{aligned}$$

A scalar can then be made by combining two identical representations :

$$(\frac{1}{2}, 0) \times (\frac{1}{2}, 0) = \underline{(0, 0)} + (1, 0) \text{ (same for } (0, \frac{1}{2}))$$

There are two ways of pairing the representations :

- making a Dirac mass term

$$(\overline{\nu}_R \nu_L + \overline{\nu}_L \nu_R)$$

- making Majorana mass terms

$$(\overline{\nu}_L^c \nu_L + \overline{\nu}_L \nu_L^c) \text{ and } (\overline{\nu}_R^c \nu_R + \overline{\nu}_R \nu_R^c)$$

where $\nu^c \equiv i\gamma_2 \nu^*$

Note that $\nu_L^c \equiv (\nu_L)^c = i\gamma_2 \left(\frac{1 - \gamma_5}{2} \nu \right)^* = \frac{1 + \gamma_5}{2} \nu^c = (\nu^c)_R$

Then $\overline{\nu}_L^c : (\frac{1}{2}, 0)$, like ν_L .

Such Majorana terms would have a net non-zero electric charge if the

fermion were charged : this is why the neutrino is the only particle which may have a Majorana mass. Still a Majorana term violates lepton number conservation : that has just recently become "acceptable", with the advent of grand unified theories where neither baryon nor lepton number is conserved.

One can define proper self-conjugate Majorana fields :

$$\chi \equiv \nu_L + \nu_L^c ; \quad \omega \equiv \nu_R + \nu_R^c$$

The mass terms are then reexpressed :

$$m_{\text{Dirac}} \propto \frac{1}{2} (\bar{\chi}\omega + \bar{\omega}\chi)$$

$$m_{\text{Majorana}} \propto \bar{\chi}\chi \quad \text{and} \quad \bar{\omega}\omega$$

Under the $SU(2)_L \times SU(2)_R \times U(1)_{B-L}$ group, the mass terms have quantum numbers :

$(\frac{1}{2}, \frac{1}{2}, 0)$ for the Dirac term ;

$(1, 0, -2)$ and $(0, 1, -2)$ for the Majorana terms.

These representations can be combined with ϕ , Δ_L and Δ_R respectively to yield singlet mass terms organized into the following mass matrix :

$$\begin{array}{c} \chi \\ \omega \end{array} \begin{pmatrix} Y_{\Delta_L} \langle \Delta_L \rangle & \frac{1}{2} Y_{\phi} \langle \phi_1 \rangle \\ \frac{1}{2} Y_{\phi} \langle \phi_1 \rangle & Y_{\Delta_R} \langle \Delta_R \rangle \end{pmatrix}$$

where Y_i are the respective Yukawa couplings, and $\langle \phi \rangle = \begin{pmatrix} \langle \phi_1 \rangle & 0 \\ 0 & \langle \phi_2 \rangle \end{pmatrix}$.

Chapter III.

The $K_L - K_S$ mass difference.

The mass difference between K_L and K_S is due to a $\Delta S = 2$ interaction between the otherwise degenerate states K^0 and \bar{K}^0 . Since we are not concerned here with CP violation, we can write K_L and K_S as eigenstates of CP :

$$K_S = \frac{K^0 + \bar{K}^0}{\sqrt{2}} \quad \text{and} \quad \text{CP} |K_S\rangle = + |K_S\rangle$$

The effective Hamiltonian between K^0 and \bar{K}^0 states takes the matrix form :

$$\begin{matrix} K^0 \\ \bar{K}^0 \end{matrix} \begin{pmatrix} m & M \\ M & m \end{pmatrix}$$

The mass eigenvalues are $(m \pm M)$ (M is real if CP is conserved), and the mass difference is :

$$M(K_L) - M(K_S) \equiv \Delta m_{LS} = 2M = 2 \langle \bar{K}^0 | H_I^{\text{eff}} | K^0 \rangle \quad (3.1)$$

Now the $K^0 - \bar{K}^0$ interaction is a $\Delta S = 2$, second order weak process between two quark-antiquark pairs, complicated by strong interaction effects in the initial and final states (We will not consider the once attractive alternatives provided by milliweak or $\Delta S = 2$ superweak interactions²²). We can calculate the weak amplitude for $s\bar{d} - \bar{s}d$ scattering, and then estimate the effect of strong interactions.

There is of course a theoretical uncertainty in that estimation, which is very difficult to evaluate. However, a fairly simple method of including strong effects, first adopted by M. K. Gaillard and B. W. Lee²⁵, has proved very successful. Indeed these authors, using the standard

W-S model for the weak interactions, predicted a charmed quark mass $m_c \sim 1.5$ GeV just a few months before the discovery of the J/ψ ²⁶. One might argue that this result is merely a lucky cancellation between a weak amplitude obtained from the wrong electroweak model, and a poor estimate of strong interaction effects. Nonetheless the predictions of the W-S model in all other circumstances (up to - perhaps - atomic parity violation experiments) come extremely close to the actual measurements ; and strong interaction effects were evaluated, in this case, along a different approach using the MIT bag model²⁷, with similar results. Therefore we think, rather conservatively, that the way Gaillard and Lee took strong effects into account should mimic the actual strong interactions within, say, a factor of three.

Our approach is then the following : we review Gaillard and Lee's way of calculating Δm_{LS} (part A) ; then we calculate the free $\bar{s}d - \bar{s}d$ amplitude in our model (part B), which depends on a number of mass parameters ; finally (part C), we relate that weak scattering amplitude to the $K_L - K_S$ mass difference along the lines of part A, and deduce restrictions on our parameters from the requirement :

$$1/3 \lesssim \Delta m_{LS} \text{ th.} / \Delta m_{LS} \text{ exp.} \lesssim 3 \quad (3.2)$$

In appendices A, B, C, we see whether the various simplifications that we made in our calculation of the weak amplitude seriously affect the final result.

A. How to calculate Δm_{LS} .

Given a specific model for weak interactions, one can calculate, with the help of Feynman diagrams, the scattering amplitude $A(\bar{s}_1 \bar{d}_1 \rightarrow \bar{s}_2 \bar{d}_2)$

for zero external momenta. In the standard model, with left-handed charged weak currents only, A will be a sum of terms - one for each diagram - of the form :

$$B \bar{\psi}^a(q_i) O(1-\gamma_5) \delta_{ab} \psi^b(q_j) \cdot \bar{\psi}^c(q_k) O'(1-\gamma_5) \delta_{cd} \psi^d(q_l) \quad (3.3)$$

where

- $q_{i,j,k,l}$ are the quarks $s_{1,2}$, $d_{1,2}$ arranged in the order required by the Feynman diagram considered, and the ψ 's the corresponding spinors ;
- O, O' are γ -matrix operators ;
- B is a scalar function of the masses of the particles exchanged ;
- a, b, c, d are color indices, and the δ_{ij} 's just express that the weak bosons exchanged are color singlets.

In our model, with right-handed currents also, $(1-\gamma_5)$ will be $(1\pm\gamma_5)$.

From $A(s_1 \bar{d}_1 \rightarrow \bar{s}_2 d_2)$, one can then extract, in principle, an effective Hamiltonian density \mathcal{H}^{eff} , ie. an operator defined by :

$$\bar{\psi}_{s_1}^a(x) \psi_{d_1}^b(x) (-\mathcal{H}^{\text{eff}}(x)) \bar{\psi}_{s_2}^c(x) \psi_{d_2}^d(x) \equiv A \quad (3.4)$$

\mathcal{H}^{eff} will thus contain 2 s- and 2 d-field operators, which can be contracted with the 4 spinors in 4 different ways, each amounting to a different Fierz rearrangement of \mathcal{H}^{eff} . Then the γ -matrix structure of \mathcal{H}^{eff} will be different from that of A, \mathcal{H}^{eff} containing spurious terms which will cancel out after a Fierz transformation. Specifically, for the standard model, A will be, up to a factor B mentioned above :

$$\begin{aligned} & \bar{\psi}^a(s_1) \gamma^\alpha \frac{1-\gamma_5}{2} \delta_{ab} \psi^b(d_2) \cdot \bar{\psi}^c(s_2) \gamma_\alpha \frac{1-\gamma_5}{2} \delta_{cd} \psi^d(d_1) \\ & + \bar{\psi}^a(s_1) \gamma^\alpha \frac{1-\gamma_5}{2} \delta_{ad} \psi^d(d_1) \cdot \bar{\psi}^c(s_2) \gamma_\alpha \frac{1-\gamma_5}{2} \delta_{bc} \psi^b(d_2) \end{aligned} \quad (3.5)$$

which can only be obtained from the following \mathcal{A}^{eff} :

$$\begin{aligned}
 -\frac{3}{8} \sum_{ijkl} & \left(\bar{\theta}^i(s) \gamma^\alpha \frac{1-\gamma_5}{2} \delta_{ij} \theta^j(d) \cdot \bar{\theta}^k(s) \gamma_\alpha \frac{1-\gamma_5}{2} \delta_{kl} \theta^l(d) \right. \\
 & \left. + \bar{\theta}^i(s) \gamma^\alpha \frac{1-\gamma_5}{2} \delta_{il} \theta^j(d) \cdot \bar{\theta}^k(s) \gamma_\alpha \frac{1-\gamma_5}{2} \delta_{kj} \theta^l(d) \right) \quad (3.6)
 \end{aligned}$$

where the θ 's are field operators (the ψ 's being spinors).

In this case \mathcal{A}^{eff} does not look too different from A : only the color operator structure changes, because the γ -matrix operator $(V-A) \times (V-A)$ has the property of being Fierz invariant. However, terms in $(V-A) \times (V+A)$ which arise in our model generate scalar and pseudo-scalar operator products whose appearance we want to postpone, using a notational trick devised later.

This distinction between θ 's and ψ 's, between \mathcal{A}^{eff} (operator) and A (amplitude obtained after performing all possible Wick contractions), is important, and has sometimes been misunderstood in the literature.

The next step toward calculating Δm_{LS} is to sandwich \mathcal{A}^{eff} between the actual meson states K^0 , \bar{K}^0 , and to recover an effective scalar amplitude. This approach would be perfect if we knew the effect of strong interactions, ie. the wave-functions of the strongly bound quark and antiquark which make up each meson. Two ways around that problem have been tried :

i) Approximate the meson states as pairs of free quarks, and require that they all interact at the same point by inserting vacuum projection operators $|0\rangle\langle 0|$ in all possible ways in the effective amplitude

$M = \langle \bar{K}^0 | \mathcal{A}^{\text{eff}} | K^0 \rangle$. This is the original approach of Ref.25.

ii) Approximate the quark wave-functions as best one can, using the

MIT bag model, and calculate directly the effective amplitude. This was carried out²⁷ as a check of the Gaillard and Lee calculation ; the result was :

$$M_{\text{bag}} / M_{\text{GL}} \approx .4 \quad (3.7)$$

which should make us rather cautious when setting limits on the theoretical uncertainty of the calculation.

Here again the issue about the legitimacy of approach i) is extremely confused. It has been argued, even by the authors of Ref. 27, that approach i) would be improved if one would consider not only a vacuum intermediate state, but also single π^0 intermediate states, with the understanding that an exact result would be obtained if one could sum over all possible intermediate states. Calculations involving single-pion projectors have been carried out²⁸, and yield roughly :

$$M_{1\pi} / M_{\text{GL}} \approx -1 ,$$

which discredits M_{GL} as a good approximation to the sum of a converging series. This argument, although widely accepted, is wrong : if one could sum over a complete set of intermediate states, one would recover the free quark amplitude A , since in approach i) the meson states are approximated by free $q\bar{q}$ pairs. It must be stressed again that the reason for the vacuum insertion is to mimic strong interactions by forcing free $q\bar{q}$ pairs to interact in a point-like fashion, and that the value of $M_{1\pi} / M_{\text{GL}}$ has nothing to do with the validity of the vacuum insertion method.

Another "refinement" has been to consider the renormalization of the weak operators responsible for the $K^0 - \bar{K}^0$ amplitude caused by

strong interactions ²⁹, while still keeping the same vacuum insertion method. The final result changes by an order of magnitude, but the justification of inserting vacuum projectors is lost, and the overall approach seems rather less reliable than the original one.

In any case, approach ii) is probably the most accurate, in view of the calculational successes of the bag model. Nevertheless, for simplicity, we will here follow approach i), but will allow for a theoretical uncertainty of a factor 3.

The last step toward calculating the mass difference has already been explained in (3.2) :

$$\Delta m_{LS} = 2M \quad (3.8)$$

We now want to perform all the steps outlined here, using the left-right symmetric model of weak interactions described in Chapter I. We will avoid exhibiting the actual \mathcal{A}^{eff} defined by (3.4) by using the following trick : we write instead a pseudo- \mathcal{A}^{eff} (which also satisfies (3.4)) obtained from the amplitude A by replacing the spinors ψ by field operators θ , and only allowing those "natural" Wick contractions which reproduce A. These contractions are indicated, when necessary, by an arrow above each field operator, pointing to the spinor with which the operator should be contracted. Thus we write, for instance, (3.6) as :

$$\begin{aligned} & - \left(\overleftarrow{\theta}^i(s) \gamma^\alpha \frac{1-\gamma_5}{2} \delta_{ij} \overrightarrow{\theta}^j(d) \cdot \overrightarrow{\theta}^k(s) \gamma_\alpha \frac{1-\gamma_5}{2} \delta_{kl} \overleftarrow{\theta}^l(d) \right. \\ & \left. + \overleftarrow{\theta}^i(s) \gamma^\alpha \frac{1-\gamma_5}{2} \delta_{ij} \overleftarrow{\theta}^j(d) \cdot \overrightarrow{\theta}^k(s) \gamma_\alpha \frac{1-\gamma_5}{2} \delta_{kl} \overrightarrow{\theta}^l(d) \right) \end{aligned} \quad (3.9)$$

B. The $\bar{s}d - \bar{s}d$ scattering amplitude in the left-right symmetric model.

We can sort the many possible diagrams describing $\bar{s}d \rightarrow \bar{s}d$ according to the helicities of the incoming and outgoing particles. Each particle can be left- or right-handed, so there are $2^4 = 16$ possibilities in principle. Half of these helicity combinations will not contribute to the scattering amplitude, for the following reason :

Each diagram, describing a second order weak process, will contain a loop with two boson and two fermion propagators. The Feynman amplitude will be obtained by integrating over the 4-momentum k circulating around the loop. If the fermion propagator does not involve any helicity-flip (say the fermion remains left-handed), it will take the form :

$$\frac{1 - \gamma_5}{2} \frac{k + m}{k^2 - m^2} \frac{1 - \gamma_5}{2} = \frac{k}{k^2 - m^2} \frac{1 - \gamma_5}{2} \quad (3.10a)$$

And if there is a helicity-flip :

$$\frac{m}{k^2 - m^2} \frac{1 \pm \gamma_5}{2} \quad (3.10b)$$

A helicity-flip fermion propagator contributes an odd power of k to a Feynman integral otherwise symmetric in $k \leftrightarrow -k$ *. Therefore non-vanishing diagrams must involve 0 or 2 helicity-flips ; the 8 helicity combinations thus left to consider are depicted in Fig. 3.1.

In the standard model the bosons which can be exchanged are W^\pm , Z^0 , and ϕ^0 . But neither Z^0 nor ϕ^0 can change quark flavors ; so Gaillard

* This $k \leftrightarrow -k$ symmetry is a consequence of our setting the external momenta to 0. Actually the scale of the external momenta is determined by the kaon mass, and that of the loop momentum by the boson masses ; hence when setting the external momenta to 0, we neglect terms which are down by a power of $M(K^0)/M(W)$. This procedure is justified here because we sum over all the external quark helicities.

and Lee only had to calculate the two similar diagrams of Fig. 3.2, with exchange of a W^+W^- pair. In our model the set of physical bosons is enlarged to : W_1 , W_2 , Z_1^0 , Z_2^0 , 4 charged Higgses (2 of which couple to fermions) , 6 neutral Higgses (4 of which couple to fermions). The Z's cannot change flavor, but the neutral Higgses can * ; so the neutral boson pairs which can be exchanged are :

$$W^+ - W^-$$

$$W^\pm - \text{charged Higgs} , \text{ or } Z^0 - \text{neutral Higgs}$$

$$2 \text{ charged Higgses} , \text{ or } 2 \text{ neutral Higgses.}$$

The set of diagrams to calculate can be narrowed down because of our specific purpose to test whether relatively large values for :

$$\beta \equiv \frac{M(W_1)^2}{M(W_2)^2} \sim \frac{k^2 + k'^2}{v^2} \quad (\text{see (1.8)})$$

are possible, ie. $\beta \sim 0(10^{-1})$. For such values, the phenomenological successes of the standard model (corresponding to $\beta = \zeta = 0$ here) imply:

$$\beta > \tan 2\zeta = - \frac{4kk'}{v^2}$$

where ζ is the mixing angle between W_L and W_R . Therefore it is sufficient to set :

$$\zeta = 0 , \text{ ie. } kk' = 0 , \text{ say } k' = 0$$

to obtain an upper limit on β . The amplitudes corresponding to mixed W

* Although in our simplified calculation the neutral Higgses do not couple to D-quarks (see next page), these particles should in general permit the decay $K^0 \rightarrow \mu^+ \mu^-$, although at a minute rate given the small magnitude of the Yukawa couplings (see (3.23)).

couplings would be of the same order as the ones that we are going to calculate, except for an extra factor $\tan^2 \zeta$, $\tan^4 \zeta$, or at best $\frac{\tan^2 \zeta}{\beta}$, $\frac{\tan^4 \zeta}{\beta^2}$, which in all cases is small compared to β . These amplitudes would not affect our limit on β (the mixing factor $\tan \zeta$ always comes in even powers because the only helicity combinations that contribute are left-left- or right-right-handed by pairs, as explained above).

For the particular case $k' = 0$, the physical Higgses are simple linear combinations of ϕ 's and χ 's. The mass matrices for the charged Higgses, and for the real and imaginary parts of the neutral Higgs fields, are reproduced in Appendix A, p.53. The only states coupling to fermions are :

$$\text{- two charged Higgses } \phi^\pm = \frac{1}{\sqrt{v^2+k^2}} (v\phi_1^\pm - k\chi_R^\pm) \quad (3.11)$$

with mass $O(M(W_2))$ and fermion couplings (see (1.22), with $B_{12} = 0$) :

$$\sqrt{1-\beta} \left[\phi^+ \overline{U}_L (R^{-1}A) D_R + \phi^- \overline{D}_R (AR) U_L \right] \quad (3.12)$$

- two neutral Higgses $\phi_2^{\circ r,i}$, with masses $O(M(W_2))$ and couplings :

$$\phi_2^{\circ} \overline{D}_L (A) D_R + \phi_2^{\circ*} \overline{D}_R (A) D_L \quad (3.13)$$

- one neutral Higgs with a light mass $O(M(W_1))$ and one with a mass $O(M(W_2))$, which only couple to U-quarks and are of no interest here.

This reduced set of physical Higgses makes it appealing to work in unitary gauge (no ghosts), where the gauge boson propagator is ³⁰ :

$$\Delta_{\mu\nu}(k) = -i \frac{g_{\mu\nu} - k_\mu k_\nu / M^2}{k^2 - M^2} \quad (3.14)$$

Power counting shows that logarithmically divergent diagrams may be present.

Indeed such diagrams are shown in Fig.3.3. They all are of the "mixed" (L-R) type . Diagrams where the initial and final quarks are all left- or right-handed (L-L or R-R) are convergent, although naive power counting would lead to the opposite result. The reason is precisely due to the GIM mechanism * :

- In the L-R diagrams, the u or c quarks propagating must flip helicity ; as seen earlier, the corresponding sandwiched propagator is then

$\frac{m_{u,c}}{k^2 - m_{u,c}^2}$, and the amplitude contains a factor :

$$\frac{m_q m_{q'}}{(k^2 - m_q^2)(k^2 - m_{q'}^2)} \propto k^{-4}$$

- In the L-L or R-R diagrams, the propagator is $\frac{k}{k^2 - m_{u,c}^2}$, and the couplings are such (thanks to GIM) that the amplitude contains a factor :

$$\cos^2 \theta_C \sin^2 \theta_C \left(\frac{k}{k^2 - m_u^2} - \frac{k}{k^2 - m_c^2} \right)^2 = \cos^2 \theta_C \sin^2 \theta_C \frac{k^2 (m_c - m_u)^2}{(k^2 - m_u^2)(k^2 - m_c^2)} \propto k^{-6}$$

which makes the integral convergent.

The same features recur in the calculation of all the Feynman amplitudes of Fig.3.3. As an example, let us derive in some detail the amplitude for W_1 - W_2 exchange. Since we assume $\zeta = 0$, there are only four helicity combinations for which such an exchange is possible. The corresponding diagrams are the first four in Fig.3.3. For each of these, the Feynman amplitude can be written :

* In this calculation, we only consider two quark generations. The possible consequences of the existence of heavier quark generations are examined in Appendix C, p.58.

$$\begin{aligned}
& \left(\frac{g}{\sqrt{2}} \right)^4 \cos^2 \theta_C \sin^2 \theta_C (i)^8 \int \frac{d^4 k}{(2\pi)^4} \left[\bar{\psi}(d) \gamma_\mu \gamma_\alpha \frac{1-\gamma_5}{2} \psi(s) \right] \cdot \left[\bar{\psi}(d) \gamma_\beta \gamma_\nu \frac{1+\gamma_5}{2} \psi(s) \right] \\
& \cdot \left(\frac{m_c}{k^2 - m_c^2} - \frac{m_u}{k^2 - m_u^2} \right)^2 \frac{g^{\mu\nu} - \frac{k^\mu k^\nu}{M(W_1)^2}}{k^2 - M(W_1)^2} \frac{g^{\alpha\beta} - \frac{k^\alpha k^\beta}{M(W_2)^2}}{k^2 - M(W_2)^2} \quad (3.15)
\end{aligned}$$

Or, after summing the four diagrams, separating the various terms and symmetrizing in 4-space :

$$\begin{aligned}
& g^4 \cos^2 \theta_C \sin^2 \theta_C \int \frac{d^4 k}{(2\pi)^4} \left(\frac{m_c}{k^2 - m_c^2} - \frac{m_u}{k^2 - m_u^2} \right)^2 \frac{1}{k^2 - M(W_1)^2} \frac{1}{k^2 - M(W_2)^2} \\
& \left\{ \frac{k^4}{M(W_1)^2 M(W_2)^2} \bar{\psi}(d) \frac{1-\gamma_5}{2} \psi(s) \cdot \bar{\psi}(d) \frac{1+\gamma_5}{2} \psi(s) + \left(1 - \frac{k^2}{4} \left(\frac{1}{M(W_1)^2} + \frac{1}{M(W_2)^2} \right) \right) \right. \\
& \left. \bar{\psi}(d) \gamma^\beta \gamma^\alpha \frac{1-\gamma_5}{2} \psi(s) \cdot \bar{\psi}(d) \gamma_\alpha \gamma_\beta \frac{1+\gamma_5}{2} \psi(s) \right\} \quad (3.16)
\end{aligned}$$

In (3.16), the first term is logarithmically divergent and the second term convergent. Both terms are calculated by dimensional regularization, in n-dimensional space :

$$\begin{aligned}
& \lim_{n \rightarrow 4} \int \frac{d^n k}{(2\pi)^n} \left(\frac{m_c}{k^2 - m_c^2} - \frac{m_u}{k^2 - m_u^2} \right)^2 \frac{1}{k^2 - M(W_1)^2} \frac{1}{k^2 - M(W_2)^2} \frac{k^4}{M(W_1)^2 M(W_2)^2} = \\
& \frac{i}{16\pi^2} \frac{(m_c - m_u)^2}{M(W_1)^2 M(W_2)^2} \Gamma(2 - \frac{n}{2}) \quad (3.17a)
\end{aligned}$$

$$\begin{aligned}
& \lim_{n \rightarrow 4} \int \frac{d^n k}{(2\pi)^n} \left(\frac{m_c}{k^2 - m_c^2} - \frac{m_u}{k^2 - m_u^2} \right)^2 \frac{1}{k^2 - M(W_1)^2} \frac{1}{k^2 - M(W_2)^2} \cdot \\
& \left(1 - \frac{k^2}{4} \left(\frac{1}{M(W_1)^2} + \frac{1}{M(W_2)^2} \right) \right) = \frac{i}{16\pi^2} \frac{-m_c^2}{M(W_1)^2 M(W_2)^2} \left(\left[\text{Log} \left(\frac{M(W_1)^2}{m_c^2} \right) - 1 \right] + \frac{1}{8} \right) \quad (3.17b)
\end{aligned}$$

In (3.17a) there is no finite piece to the integral in addition to the divergent piece proportional to $(n - 4)^{-1}$. This feature reappears in all the diagrams we have to evaluate : the pole terms, after cancellation among all the divergent diagrams, do not contribute to the finite amplitude. In (3.17b) we set m_u to zero, and we kept separate the contributions coming from the $g^{\mu\nu}$ part of the W-propagators (like in Feynman gauge) and from the $\frac{k^\mu k^\nu}{M(W)^2}$ part, which is specific to the unitary gauge and should account for the ghost terms otherwise present, in Feynman gauge for instance. One can see that the ghost contribution is very small (final factor $\frac{1}{8}$ in (3.17b)). In fact we approximate (3.17b) to :

$$-\frac{i}{16\pi^2} \frac{(m_c - m_u)^2}{M(W_1)^4} \beta \text{Log} \left[\frac{M(W_1)^2}{m_c^2} \right]$$

where $\beta \equiv \frac{M(W_1)^2}{M(W_2)^2}$. The amplitude (3.16) can be further simplified

with the use of the identity :

$$\left(\gamma^\beta \gamma^\alpha \frac{1-\gamma_5}{2} \right)_{ij} \left(\gamma_\alpha \gamma_\beta \frac{1+\gamma_5}{2} \right)_{kl} = 4 \left(\frac{1-\gamma_5}{2} \right)_{ij} \left(\frac{1+\gamma_5}{2} \right)_{kl} + \left(\sigma^{\alpha\beta} \frac{1-\gamma_5}{2} \right)_{ij} \left(\sigma_{\alpha\beta} \frac{1+\gamma_5}{2} \right)_{kl} \quad (3.18)$$

In fact the last term in (3.18) is identically zero, as can be verified using :

$$\sigma^{\alpha\beta} \gamma_5 = -\frac{1}{2} \epsilon^{\alpha\beta\gamma\delta} \sigma_{\gamma\delta} \quad (3.19)$$

Finally, the gauge boson W_1 mass, the U-fermion masses and the Higgs couplings can all be related in the following fashion.

$m_U = (kA + k'B)$ (see (1.18)). So:

$$(m_c - m_u)^2 \cos^2 \theta_C \sin^2 \theta_C = (kA_{12} + k'B_{12})^2 \quad (3.20)$$

In our case where $kk' = 0$ (no mixing), this last expression is equal to $(k^2 + k'^2)(A_{12}^2 + B_{12}^2)$, with $M(W_1)^2 = \frac{1}{2} g^2 (k^2 + k'^2)$. Hence :

$$(m_c - m_u)^2 \cos^2 \theta_C \sin^2 \theta_C = 2 \frac{M(W_1)^2}{g^2} (A_{12}^2 + B_{12}^2) \quad (3.21)$$

If we further choose $k' = 0$, the requirement that the D-quark mass matrix be diagonal imposes :

$$B_{12} = 0 \quad (3.22)$$

These relations allow us to eliminate m_u , m_c , θ_C from all amplitudes, and to compare them easily. Incidentally, the Yukawa couplings are very small, as shown by :

$$(A_{12}^2 + B_{12}^2) = 4 \cos^2 \theta_C \sin^2 \theta_C (m_c - m_u)^2 \frac{G_F}{\sqrt{2}} \sim 0(10^{-6}) \quad (3.23)$$

whereas :

$$g^2 = \frac{G_F}{\sqrt{2}} \cdot 8 M(W_1)^2 \sim \frac{1}{2} \quad (3.24)$$

Using (3.21), (3.16) can be cast in the final form :

$$\frac{4g^2 A_{12}^2}{16\pi^2} \left[-\frac{1}{n-4} \frac{\beta}{M(W_1)^2} - \frac{2\beta}{M(W_1)^2} \text{Log} \left(\frac{M(W_1)^2}{m_c^2} \right) \right] \bar{\psi}(d) \frac{1-\gamma_5}{2} \psi(s) \cdot \bar{\psi}(d) \frac{1+\gamma_5}{2} \psi(s) \quad (3.25)$$

The central coefficient in (3.25) has been written underneath the corresponding diagrams of Fig.3.3. The same treatment can be repeated on all the other diagrams ; the results are also written under each group of diagrams, after removal of the same overall factor :

$$\frac{4g^2 A_{12}^2}{16\pi^2} A_{LR} \quad , \quad \text{where}$$

$$A_{LR} \equiv \bar{\psi}(d) \frac{1-\gamma_5}{2} \psi(s) \cdot \bar{\psi}(d) \frac{1+\gamma_5}{2} \psi(s) \quad (3.26)$$

One can check the cancellation of the divergences in Fig.3.3.

To obtain the indicated results concerning the last set of diagrams (Z° and ϕ° exchange), one must treat the Z° 's and ϕ° 's couplings carefully.

They always appear in the same combination :

$$F \equiv \sum_{Z_1, Z_2} \frac{(g(ZD_{L L}) - g(ZD_{R R}))^2}{M(Z)^2} \quad (3.27)$$

where $g(ZD_{L L})$ and $g(ZD_{R R})$ are the couplings of a Z° boson to left- and right-handed D-type quarks (these couplings are independent of the quark generation since the Z's do not change flavor). The sum is over the two neutral bosons, because the amplitudes for diagrams where Z_1° or Z_2° is exchanged are otherwise identical.

To evaluate (3.27) exactly, we should first rewrite the Z° mass matrix (1.13) in a different basis :

$$\frac{1}{\sqrt{2}} (W_L^3 - W_R^3) \quad \begin{pmatrix} 2a + \frac{b \cos 2\theta}{2 \cos^2 \theta} & -\frac{b \sqrt{\cos 2\theta}}{2 \cos^2 \theta} \\ -\frac{b \sqrt{\cos 2\theta}}{2 \cos^2 \theta} & \frac{b}{2 \cos^2 \theta} \end{pmatrix} \quad (3.28)$$

$$\frac{1}{\sqrt{2}} ((W_L^3 + W_R^3) \sqrt{\cos 2\theta} - 2B \sin \theta)$$

If the eigenvectors are $\begin{pmatrix} \cos \phi \\ \sin \phi \end{pmatrix}$ and $\begin{pmatrix} -\sin \phi \\ \cos \phi \end{pmatrix}$ in this basis, then the

factor we want to evaluate is :

$$F = \frac{g^2}{2} \left(\frac{\cos^2 \phi}{M(Z_1)^2} + \frac{\sin^2 \phi}{M(Z_2)^2} \right) \quad (3.29)$$

where $M(Z_1)^2$ and $M(Z_2)^2$ are the eigenvalues of the same matrix (3.28).

It is a straightforward matter to verify that, for any symmetric matrix

$$\begin{pmatrix} \alpha & \beta \\ \beta & \gamma \end{pmatrix} \text{ with eigenvalues } \lambda, \lambda' \text{ and eigenvectors } \begin{pmatrix} \cos \phi \\ \sin \phi \end{pmatrix} \text{ and } \begin{pmatrix} -\sin \phi \\ \cos \phi \end{pmatrix}$$

respectively, the following is true :

$$\frac{\cos^2 \phi}{\lambda} + \frac{\sin^2 \phi}{\lambda'} = \frac{\gamma}{\alpha\gamma - \beta^2} \quad (3.30)$$

The ambiguity which arises when we want to use this formula here, namely which of the two diagonal elements to take, is solved if we remember that the heavier Z_2 is the one with the more left-right symmetric couplings.

$$\text{Then } F = \frac{g^2}{2} \cdot \frac{b}{2\cos^2 \theta} \cdot \frac{\cos^2 \theta}{a b} = \frac{g^2}{4a} \quad (3.31)$$

so that finally :

$$\sum_{Z_1, Z_2} \frac{(g(ZD_{LL}) - g(ZD_{RR}))^2}{M(Z)^2} = \frac{g^2}{4M(W_1)^2} \quad (3.32)$$

The finite amplitude $A(\bar{s}d \rightarrow \bar{s}d)$ can be obtained by summing all divergent and convergent diagrams. Besides the divergent diagrams all listed in Fig.3.3, only one pair of convergent diagrams must be taken into account as well : the original diagram evaluated by Gaillard and Lee (Fig.3.2a) and its "symmetric" partner. Some diagrams involving ϕ^\pm and W^\pm exchange, which might otherwise give a sizeable amplitude, vanish because of the peculiar Higgs couplings (see Fig.3.4a for an example).

The other non-divergent diagrams can safely be neglected in this calculation where we are only interested in the leading effects in $\beta \equiv \frac{M(W_1)^2}{M(W_2)^2}$; they are of three types (illustrated in Fig.3.4b,c,d) :

- diagrams involving the exchange of two W_2 's : the amplitude would be proportional to β^2 ;
- diagrams involving two Higgs exchange : compared to the same diagram with a W_1 and ϕ exchange, the amplitude is typically down by a factor, at

$$\text{best : } \frac{A_{12}^2}{M(\phi)^2} \cdot \frac{M(W_1)^2}{g^2 \sin^2 \theta_C} \lesssim 10^{-4}$$

where the numerical evaluation uses (3.21).

- higher order diagrams, involving the exchange of more Higgses, weak bosons or photons, which are suppressed by powers of the respective coupling constants.

In the end, the $\bar{s}d - \bar{s}d$ amplitude can be written :

$$\begin{aligned} 16\pi^2 A(\bar{s}d \rightarrow \bar{s}d) = & - \frac{g^2 A_{12}^2}{M(W_1)^2} A_{LL} \\ & + 4g^2 A_{12}^2 A_{LR} \left(- \frac{2\beta}{M(W_1)^2} \text{Log} \left[\frac{M(W_1)^2}{m_c^2} \right] \right. \\ & + \frac{1}{2} \frac{(1-\beta)}{M(\phi^+)^2 - M(W_1)^2} \text{Log} \left[\frac{M(\phi^+)^2}{M(W_1)^2} \right] \\ & - \frac{1}{2} \frac{1}{M(\phi^\circ)^2 \cos^2 \theta - M(W_1)^2} \text{Log} \left[\frac{M(\phi^\circ)^2 \cos^2 \theta}{M(W_1)^2} \right] \\ & \left. - \frac{1}{2} \frac{\cos 2\theta}{\cos^2 \theta} \frac{1}{M(\phi^\circ)^2 - M(W_2)^2 \cos^2 \theta / \cos 2\theta} \text{Log} \left[\frac{M(\phi^\circ)^2 \cos 2\theta}{M(W_2)^2 \cos^2 \theta} \right] \right) \end{aligned} \quad (3.33)$$

where

- the 5 successive terms come respectively from the exchange of :

$$W_1 - W_1, W_1 - W_2, W_2 - \phi, Z_1 - \phi^\circ, Z_2 - \phi^\circ;$$

- the 2 neutral Higgses have been given the same mass $M(\phi^\circ)$ for simplicity (they should both have a mass of order $M(W_2)$, whereas the other lighter neutral Higgs does not couple to D-quarks : see p.38 and App.A, p.53);

- all the integrals have been approximated using :

$$m_u \ll m_c \ll M(W_1) < M(W_2) \quad \text{and} \quad M(\phi) > M(W_1) \quad \text{for all } \phi\text{'s} \quad (3.34)$$

- A_{LR} is given by (3.26), or, for colored quarks :

$$A_{LR} = \bar{\psi}^a(s) \delta_{ab} \frac{1-\gamma_5}{2} \psi^b(d) \cdot \bar{\psi}^c(s) \delta_{cd} \frac{1+\gamma_5}{2} \psi^d(d) \quad (3.34a)$$

$$\text{and } A_{LL} = \bar{\psi}^a(s) \delta_{ab} \gamma^\alpha \frac{1-\gamma_5}{2} \psi^b(d) \cdot \bar{\psi}^c(s) \delta_{cd} \gamma_\alpha \frac{1-\gamma_5}{2} \psi^d(d) \quad (3.34b)$$

In these expressions, a,b,c,d are color indices, and $\delta_{ab} \delta_{cd}$ stems from the fact that all the bosons exchanged are color-singlets.

C. Calculating Δm_{LS} .

From the amplitude (3.33), we can in principle write the effective Hamiltonian, after (3.4) ; let us define effective operators O_{LL} and O_{LR} :

$$\bar{\psi}_s^a(x) \psi_d^b(x) O_{LL}(x) \bar{\psi}_s^c(x) \psi_d^d(x) \equiv A_{LL}(x) \quad (3.35)$$

$$\bar{\psi}_s^a(x) \psi_d^b(x) O_{LR}(x) \bar{\psi}_s^c(x) \psi_d^d(x) \equiv A_{LR}(x)$$

Using the trick described in section A, (3.9), and remembering that we always sum diagrams by pairs symmetric under interchange of the two d-quarks, we can write :

$$O_{LL} = \frac{1}{2} \left[\bar{\theta}^i(s) \gamma^\alpha \frac{1-\gamma_5}{2} \theta^i(d) \cdot \bar{\theta}^j(s) \gamma_\alpha \frac{1-\gamma_5}{2} \theta^j(d) + \bar{\theta}^i(s) \gamma^\alpha \frac{1-\gamma_5}{2} \theta^i(d) \cdot \bar{\theta}^j(s) \gamma_\alpha \frac{1-\gamma_5}{2} \theta^j(d) \right] \quad (3.36a)$$

$$O_{LR} = \frac{1}{2} \left[\bar{\theta}^i(s) \frac{1-\gamma_5}{2} \theta^i(d) \cdot \bar{\theta}^j(s) \frac{1+\gamma_5}{2} \theta^j(d) + \bar{\theta}^i(s) \frac{1-\gamma_5}{2} \theta^i(d) \cdot \bar{\theta}^j(s) \frac{1+\gamma_5}{2} \theta^j(d) \right] \quad (3.36b)$$

Now we want to evaluate $\langle \bar{K}^0 | O_{LL} | K^0 \rangle$ and $\langle \bar{K}^0 | O_{LR} | K^0 \rangle$ where the

mesons are approximated to free quarks, but still with the right color singlet structure. Namely :

$$\langle \bar{K}^0 | O_{L_R} | K^0 \rangle = \langle \frac{1}{\sqrt{3}} \bar{\psi}^a(s) \psi^a(d) | O_{L_R} | \frac{1}{\sqrt{3}} \bar{\psi}^b(s) \psi^b(d) \rangle \quad (3.37)$$

Let us first apply this equation to O_{LL} . Contracting the field operators with the spinors in the first term of (3.36a) is straightforward : the two operators on the right annihilate K^0 , the two on the left create \bar{K}^0 . So the vacuum projector can only be inserted in the middle, yielding an effective amplitude written * :

$$\frac{1}{2} \langle \bar{K}^0 | \gamma^\alpha \frac{1-\gamma_5}{2} | 0 \rangle \langle 0 | \gamma_\alpha \frac{1-\gamma_5}{2} | K^0 \rangle$$

For the second term of (3.36a), a Fierz transformation must be performed, both on the color-operators and on the γ -matrix operators :

$$\delta_{ad} \delta_{cb} = \frac{1}{3} \delta_{ab} \delta_{cd} + \frac{1}{2} \lambda^i_{ab} \lambda^i_{cd} \quad (3.38a)$$

$$(\gamma^\alpha \frac{1-\gamma_5}{2})_{il} (\gamma_\alpha \frac{1-\gamma_5}{2})_{kj} = (\gamma^\alpha \frac{1-\gamma_5}{2})_{ij} (\gamma_\alpha \frac{1-\gamma_5}{2})_{kl}, \text{ invariant (3.38b)}$$

So we get, summing both terms of (3.36a) :

$$\langle \bar{K}^0 | O_{LL} | K^0 \rangle = \frac{2}{3} \langle \bar{K}^0 | \gamma^\alpha \frac{1-\gamma_5}{2} | 0 \rangle \langle 0 | \gamma_\alpha \frac{1-\gamma_5}{2} | K^0 \rangle \quad (3.39)$$

In each factor, only the axial vector part will contribute, because K^0 is a pseudoscalar. Now by definition of f_K :

* Through the rest of this section, we will not write the field operators explicitly. Thus $\langle 0 | \Gamma | K^0 \rangle$ for instance stands for $\langle 0 | \bar{\theta}_s^i(x) \Gamma \theta_d^i(x) | K^0 \rangle$, where Γ is any γ -matrix operator. It should be clear that such a scalar product implies an integration over 3-space.

$$\langle 0 | A_\alpha | K^0 \rangle \equiv i f_K q_\alpha \quad (3.40)$$

q_α being the momentum carries by the kaon. Therefore here :

$$\langle \bar{K}^0 | O_{LL} | K^0 \rangle = \frac{2}{3} \cdot \frac{1}{4} \cdot \frac{f_K^2 m_K^2}{2 m_K} \quad (3.41)$$

where $2m_K$ is the normalization factor of $|K^0\rangle$, which must be taken into account when we perform a 3-space integration (see footnote p.46).

We can proceed by applying (3.37) to O_{LR} defined in (3.36b). The Fierz identities required for the second term in (3.36b) are (3.38a) for the color-operator, and :

$$\begin{aligned} \left(\frac{1-\gamma_5}{2}\right)_{ij} \left(\frac{1+\gamma_5}{2}\right)_{kl} &= \frac{1}{8} (\gamma^\alpha)_{ij} (\gamma_\alpha)_{kl} - \frac{1}{8} (\gamma^\alpha \gamma_5)_{ij} (\gamma_\alpha \gamma_5)_{kl} + \frac{1}{8} (\gamma^\alpha \gamma_5)_{ij} (\gamma_\alpha)_{kl} \\ &\quad - \frac{1}{8} (\gamma^\alpha)_{ij} (\gamma_\alpha \gamma_5)_{kl} - \frac{1}{16} (\sigma^{\alpha\beta})_{ij} (\sigma_{\alpha\beta} \gamma_5)_{kl} \end{aligned} \quad (3.42)$$

Only the second operator in this decomposition can annihilate a K^0 and create a \bar{K}^0 . So in the end the two terms in (3.36b) yield :

$$\begin{aligned} \langle \bar{K}^0 | O_{LR} | K^0 \rangle &= \frac{1}{2} \langle \bar{K}^0 | \frac{1-\gamma_5}{2} | 0 \rangle \langle 0 | \frac{1+\gamma_5}{2} | K^0 \rangle \\ &\quad - \frac{1}{48} \langle \bar{K}^0 | \gamma^\alpha \gamma_5 | 0 \rangle \langle 0 | \gamma_\alpha \gamma_5 | K^0 \rangle \end{aligned} \quad (3.43)$$

The scalar operators do not contribute to (3.43). The pseudoscalar terms can be evaluated through the divergence equation :

$$(m_s + m_d) \langle 0 | \gamma_5 | K^0 \rangle = -i \partial_\mu \langle 0 | \gamma^\mu \gamma_5 | K^0 \rangle \quad (3.44)$$

Hence :

$$\langle \bar{K}^0 | O_{LR} | K^0 \rangle = - \left(\left(\frac{m_K}{m_s + m_d} \right)^2 + \frac{1}{6} \right) \cdot \frac{1}{8} \cdot \frac{f_K^2 m_K^2}{2 m_K} \quad (3.45)$$

The quark masses used in the divergence equation (3.44) should be current masses, but their exact values are quite controversial (see later discussion). In any case, the LR amplitude is enhanced with respect to the LL amplitude. There is an illuminating physical explanation for this enhancement (for which I am indebted to Mary K. Gaillard) : the quark and antiquark inside, say, \bar{K}^0 must have the same helicity in order to form a pseudoscalar (eg. $s_L \bar{d}_L$, that is $s_L \overline{(d_R)}$) ; in L-L diagrams, one of them is forced into the wrong helicity, with a resulting suppression $O(m_q/m_K)$. The situation is similar to that which enhances $\pi_{\mu 2}$ over $\pi_{e 2}$ decays.

We can now write the $K_L - K_S$ mass difference, using equations (3.8, 3.33, 3.41 and 3.45) :

$$\frac{\Delta m_{LS}}{m_K} = \frac{g^2}{16\pi^2} \frac{A_{12}^2}{M(W_1)^2} \frac{f_K^2}{6} \left\{ 1 - 3 \left(\left[\frac{m_K}{m_s + m_d} \right]^2 + \frac{1}{6} \right) \cdot \left(2\beta \text{Log} \left[\frac{M(W_1)^2}{m_c^2} \right] \right. \right. \\ \left. \left. - \frac{1-\beta}{2} \left[\frac{M(\phi^+)^2}{M(W_1)^2} - 1 \right]^{-1} \text{Log} \left[\frac{M(\phi^+)^2}{M(W_1)^2} \right] + \frac{1}{2} \left[\frac{M(\phi^0)^2 \cos^2 \theta}{M(W_1)^2} - 1 \right]^{-1} \text{Log} \left[\frac{M(\phi^0)^2 \cos^2 \theta}{M(W_1)^2} \right] \right. \\ \left. \left. + \frac{\beta}{2} \frac{\cos 2\theta}{\cos^2 \theta} \left[\frac{M(\phi^0)^2}{M(W_2)^2} - \frac{\cos^2 2\theta}{\cos 2\theta} \right]^{-1} \text{Log} \left[\frac{M(\phi^0)^2 \cos 2\theta}{M(W_2)^2 \cos^2 \theta} \right] \right) \right\} \quad (3.46)$$

where the constant factor $\frac{g^2}{16\pi^2} \frac{A_{12}^2}{M(W_1)^2} \frac{f_K^2}{6}$ can be rewritten, with (3.21) and (3.24) :

$$\frac{G_F^2}{6\pi^2} m_c^2 \cos^2 \theta_C \sin^2 \theta_C f_K^2 = \frac{\Delta m_{LS}}{m_K} \Big|_{\text{G.L.}} \quad (3.47)$$

This is Gaillard and Lee's result (Ref.25, formula (2.8) with a factor $\frac{2}{3}$ for 3-color quarks). With $m_c \sim 1.5$ GeV, and $f_K \approx 1.3 f_\pi$, its value is

about 5.10^{-15} , whereas the measured value is $\approx 7.10^{-15}$. All the correction terms come from left-right diagrams. It is reassuring to see that the standard result is recovered for $\beta \rightarrow 0$ (ie. $M(W_2) \rightarrow \infty$, and $M(\phi^+, \phi^0) \sim O(M(W_2)) \rightarrow \infty$ too), even if the Higgs masses go to infinity independently. The magnitude of the Higgs terms depends critically on their mass, which should be "of the same order of magnitude" as that of W_2 . Even though the effects of the neutral Higgses and of the charged Higgs tend to cancel, actual cancellation would only occur with a finely tuned Higgs potential, and in reality the net effects can be very sizeable, as we see below. The last term in (3.46) has been kept so far because it was the leading term in the amplitude for its class of diagrams ($Z_2 - \phi^0$ exchange), but it can now be safely neglected relative to

$$2\beta \text{Log} \left(\frac{M(W_1)^2}{m_c^2} \right) \sim 16\beta. \text{ Numerically, for } M(W_1) \sim 80 \text{ GeV and}$$

$m_c \sim 1.5 \text{ GeV}$, the expression (3.46) reads :

$$\left. \frac{\Delta m_{LS}}{m_K} \right|_{\text{th.}} \approx 5.10^{-15} \left[1 - 48a \left[\beta - \frac{1}{32} (\rho^+ - \rho^0) \right] \right] \quad (3.48)$$

where

$$a \equiv \left(\frac{m_K}{m_s + m_d} \right)^2 + \frac{1}{6} \quad (3.49)$$

$$\rho^+ \equiv \left(\frac{M(\phi^+)^2}{M(W_1)^2} - 1 \right)^{-1} \text{Log} \left(\frac{M(\phi^+)^2}{M(W_1)^2} \right); \quad \rho^0 \equiv \left(\frac{M(\phi^0)^2 \cos^2 \theta}{M(W_1)^2} \right)^{-1} \text{Log} \left(\frac{M(\phi^0)^2 \cos^2 \theta}{M(W_1)^2} \right) \quad (3.50)$$

Given the uncertainty factor of three (3.2), we now want to extract limits on β from :

$$0.23 \lesssim 1 - 48a \left[\beta - \frac{1}{32} (\rho^+ - \rho^0) \right] \lesssim 2.1 \quad (3.51)$$

(the upper bound is irrelevant here). The result is :

$$\beta \lesssim \frac{1.6 \times 10^{-2}}{\underline{a}} + \frac{1}{32} (\rho^+ - \rho^0) \quad (3.52)$$

A recent analysis along these lines ³¹, neglecting entirely the Higgs sector, and taking a set of low current quark masses ($m_s = 150$ MeV, $m_d = 7$ MeV, and hence $\underline{a} \approx 10$), has quoted the limit $M(W_2) \gtrsim 1.6$ TeV which, taken at face value in the context of grand unification, implies $M(W_2) \gtrsim 10^9$ GeV (see (2.8)).

Taking into account the Higgs sector leads us to more conservative claims. Fig.3.5 shows the variation of ρ^+ (respectively ρ^0) with $M(\phi^+)$ (resp. $M(\phi^0)$). If the charged Higgs comes close in mass to W_1 , but not the neutral Higgses to Z_1 , the effect of the Higgs sector on (3.52) is maximum. In any case,

$$|\rho^+ - \rho^0| \lesssim 1 \quad (3.53)$$

(In the eventuality that the Higgses become lighter than W_1 , various terms neglected in the calculation of the $K^0 - \bar{K}^0$ amplitude become important, and (3.33) is no longer valid. That situation, which is disfavored experimentally, would also require some twisting of the Higgs potential).

The enhancement factor \underline{a} (3.49) depends crucially on the numbers used for m_s and m_d . The ratios of current-quark masses are rather well established : $m_u : m_d : m_s = 1 : 1.8 \pm 0.2 : \sim 40_{-8}^{+15}$, depending on the author ³². The overall scale is much more uncertain. Leutwyler ³³ obtained an equation based on $SU(6)_W$ symmetry :

$$\frac{1}{2} (m_u + m_d) \approx 5.4 \text{ MeV} \quad (3.54)$$

so that $m_u \approx 4 \text{ MeV}$, $m_d \approx 7 \text{ MeV}$, $m_s \approx 150 \text{ MeV}$, as adopted in Ref.31. But other authors³⁴ have argued that these values should be multiplied by 2 or 3. Then \underline{a} (3.49) varies from ~ 10 to ~ 1 .

The reader can take three different attitudes, depending on his confidence in the Higgs mass spectrum predicted by our model, and his opinion about current-quark masses.

i) The most conservative limit on β is obtained by saturating the upper bound for $(\rho^+ - \rho^0)$ and the lower bound for \underline{a} . One finds $M(W_2) \gtrsim 370 \text{ GeV}$ only. Even with $\underline{a} = 10$, $M(W_2) \gtrsim 440 \text{ GeV}$, far from 1.6 TeV.

ii) Another approach is to decide that the Higgses have a minimum mass greater than 80 GeV, say $\sim 300 \text{ GeV}$. Then $|\rho^+ - \rho^0| \lesssim 0.2$. The bound becomes $M(W_2) \gtrsim 530 \text{ GeV}$ for $\underline{a} = 1$, and $M(W_2) \gtrsim 900 \text{ GeV}$ for $\underline{a} = 10$.

iii) Since after all the Higgses are supposed to be about as massive as W_2 , one may assume, somewhat adventurously, that the unbalance $|\rho^+ - \rho^0|$ will never exceed that obtained when one Higgs has the same mass as W_2 , and the other ones are infinitely heavy. Then

$$|\rho^+ - \rho^0| \lesssim - \frac{\beta \text{Log} \beta}{1-\beta} \quad (3.55)$$

The limit on β then varies with \underline{a} according to Fig.3.6, yielding $M(W_2) \gtrsim 590 \text{ GeV}$ for $\underline{a} = 1$, and $M(W_2) \gtrsim 1.8 \text{ TeV}$ for $\underline{a} = 10$.

We prefer to take attitude i) and conclude

$$M(W_2) \gtrsim 370 \text{ GeV} \quad (3.56)$$

which might be compatible with the constraints of grand unification (see discussion pp.20-21 and Ref.15). There may still exist a mass

"window" below 400 GeV where one could find a right-handed boson, but its presence there would very much restrict the parameters of the Higgs sector as well as those of a grand unified theory.

Our conservative limit is essentially model-independent, in a 2-quark-generation world. A different model would yield a slightly modified coefficient in front of $(\rho^+ - \rho^0)$ in (3.52), but we feel that we have been conservative enough, by saturating $|\rho^+ - \rho^0|$ to 1, to allow for a slightly greater influence of the Higgs sector in another model. The presence of more quark generations, however, may alter our result, as discussed in Appendix C, p.58.

Appendix A

Higgs mass matrices.

The Higgs mass matrices are taken from Ref.6 , where they are derived from the following general scalar potential :

$$\begin{aligned}
V = & -\mu_1^2 \text{Tr}(\phi^+\phi) + \lambda_1 (\text{Tr}(\phi^+\phi))^2 + \lambda_2 \text{Tr}(\phi^+\phi\phi^+\phi) + \frac{1}{2} \lambda_3 (\text{Tr}(\phi^+\tilde{\nu}\phi) + \text{Tr}(\tilde{\nu}^+\phi)) ^2 \\
& + \frac{1}{2} \lambda_4 (\text{Tr}(\phi^+\tilde{\nu}\phi) - \text{Tr}(\tilde{\nu}^+\phi))^2 + \lambda_5 \text{Tr}(\phi^+\tilde{\nu}\phi\tilde{\nu}^+\phi) + \frac{1}{2} \lambda_6 (\text{Tr}(\phi^+\tilde{\nu}\phi\tilde{\nu}^+\phi) + \text{h.c.}) \\
& - \mu_2^2 (X_L^+ X_L + X_R^+ X_R) + \rho_1 ((X_L^+ X_L)^2 + (X_R^+ X_R)^2) + \rho_2 X_L^+ X_L X_R^+ X_R \\
& + \alpha_1 \text{Tr}(\phi^+\phi) (X_L^+ X_L + X_R^+ X_R) + \alpha_2 (X_L^+ \phi\phi^+ X_L + X_R^+ \phi^+\phi X_R) \\
& + \alpha'_2 (X_L^+ \tilde{\nu}\tilde{\nu}^+ X_L + X_R^+ \tilde{\nu}^+\tilde{\nu} X_R) \tag{3.A.1}
\end{aligned}$$

where $\tilde{\nu}$ is defined by (1.17). If we relax the arbitrary requirements made in Ref.6 that the minimum of V occurs for $\langle X_L^0 \rangle = v' = 0$ and $k' = 0$, and only maintain $k' = 0$, new terms appear in the mass matrices at the elements marked * below (zero if $v' = 0$). The zero-mass eigenstates of these matrices become longitudinal degrees of freedom of massive gauge bosons. The matrices are the following.

i) Charged Higgs sector :

$$\begin{array}{l}
\phi_2^+ \\
X_L^+ \\
\phi_1^+ \\
X_R^+
\end{array}
\begin{pmatrix}
* & * & 0 & 0 \\
* & (\rho_2 - 2\rho_1)v^2 + \Delta\alpha k^2 & 0 & 0 \\
0 & 0 & \Delta\alpha v^2 & \Delta\alpha kv \\
0 & 0 & \Delta\alpha kv & \Delta\alpha k^2
\end{pmatrix} \tag{3.A.2}$$

where $\Delta\alpha \equiv \alpha_2 - \alpha'_2$. The only massive eigenstate with fermion couplings

is :

$$\phi^\pm = \frac{v\phi_1^\pm + k\chi_R^\pm}{v^2 + k^2} ; \quad M^2 = \Delta\alpha (k^2 + v^2) \sim O(M(W_2)^2)$$

ii). Neutral Higgs sector :

$$\begin{array}{l} \phi_{2\ r}^\circ \\ \chi_{L\ r}^\circ \\ \phi_{1\ r}^\circ \\ \chi_{R\ r}^\circ \end{array} \begin{pmatrix} A' & * & 0 & 0 \\ * & B & 0 & 0 \\ 0 & 0 & 4k^2(\lambda_1 + \lambda_2) & 2kv(\alpha_1 + \alpha'_2) \\ 0 & 0 & 2kv(\alpha_1 + \alpha'_2) & 4\rho_1 v^2 \end{pmatrix} \quad (3.A.3)$$

$$\begin{array}{l} \phi_{2\ i}^\circ \\ \chi_{L\ i}^\circ \\ \phi_{1\ i}^\circ \\ \chi_{R\ i}^\circ \end{array} \begin{pmatrix} A & * & 0 & 0 \\ * & B & 0 & 0 \\ 0 & 0 & * & * \\ 0 & 0 & * & * \end{pmatrix} \quad (3.A.4)$$

A, A' and B are complicated expressions of the Higgs potential parameters ; but all contain a v^2 piece. The physical neutral Higgses are thus :

- (a) Two heavy neutral Higgses $\phi_{2\ r}^\circ$ and $\phi_{2\ i}^\circ$ with masses $O(M(W_2))$;
- (b) One light neutral Higgs with mass $O(M(W_1))$, and one with mass $O(M(W_2))$, both linear combinations of $\phi_{1\ r}^\circ$ and $\chi_{R\ r}^\circ$, which only couple to U-type quarks ;
- (c) Two heavy Higgses $\chi_{L\ i, r}^\circ$ which do not couple to quarks.

If we relax the condition $v' = 0$ (see Ch.I,A), but keep $v' \ll v$ to maintain a sensible pattern of symmetry breaking, the new terms which appear in (3.A.2, 3 and 4) at places marked by * are small compared to v^2 , so they will not affect the mass spectrum of the Higgses signifi-

cantly. Moreover, there still will not be any mixing between ϕ_1 and ϕ_2 , neither in the charged nor in the neutral sector : the mass matrices will remain block-diagonal, because there is no term in the Higgs potential (3.A.1), despite its appearance and its generality, to mix ϕ_1 with ϕ_2 . Thus the couplings of the physical Higgses to fermions will only be changed by $O(v'/v)$ or less, and our result (3.56) will not be greatly affected.

Appendix B

Cabibbo angle in full generality.

We have seen (cf. (1.21)) that the Cabibbo matrix appears as :

$$R = R_U^{-1} R_D \quad (3.B.1)$$

where R_U and R_D are the rotations needed to diagonalize the U- and D-quark mass matrices respectively. However we carried out our computation with the simplifying assumption :

$$R = R_U^{-1} ; R_D = 1 \quad (3.B.2)$$

In order to show that the above assumption does not restrict the generality of our result, let us introduce an overall rotation S on both the U- and D-type fields :

$$D^\circ = SD ; U^\circ = SRU \quad (3.B.3)$$

The various elements of our calculation are changed in the following fashion :

i) gauge boson couplings :

The Z's couple to fermions diagonally : $\bar{D}^\circ D^\circ = \bar{D}D$, unchanged ;

The W's couple to fermions according to : $\bar{D}^\circ U^\circ = \bar{D}RU$, unchanged.

ii) fermion masses and Higgs couplings :

The new Higgs couplings are, after (1.22) :

$$\begin{aligned} \text{for } \phi_1^\pm : \phi_1^\pm & \left[\bar{U}_L (R^{-1} (SAS)) D_R + \bar{U}_R (-R^{-1} (S^{-1}BS)) D_L \right] \\ & + \phi_1^\mp \left[\bar{D}_L (-S^{-1}BS) U_R + \bar{D}_R ((S^{-1}AS) U_L) \right] \end{aligned}$$

for ϕ_2^\pm : same, $\phi_1^\pm \leftrightarrow \phi_2^\pm$, $A \leftrightarrow -B$,

(3.B.4)

$$\text{for } \phi_1^\circ: \phi_1^\circ \left\{ \overline{U}_L (R^{-1} (S^{-1} A S) R) U_R + \overline{D}_R (S^{-1} B S) D_L \right\} \\ + \phi_1^{\circ*} \left\{ \overline{U}_R (R^{-1} (S^{-1} A S) R) U_L + \overline{D}_L (S^{-1} B S) D_R \right\}$$

for ϕ_2° : same, $\phi_1^\circ \leftrightarrow \phi_2^{\circ*}$, $A \leftrightarrow +B$.

Therefore the new rotation S amounts, not surprisingly, to a rotation of the coupling matrices A and B :

$$A \rightarrow A' \equiv S^{-1} A S \quad ; \quad B \rightarrow B' \equiv S^{-1} B S \quad (3.B.5)$$

iii) relationship between gauge boson mass and Higgs couplings :

Once A and B have been replaced by A' and B', the following relations are still preserved :

$$\Delta_D = \begin{pmatrix} m_d & 0 \\ 0 & m_s \end{pmatrix} = (k B' + k' A') \quad ; \quad \text{ie. } k B_{12} + k' A'_{12} = 0$$

Then, for $kk' = 0$, we still have :

$$(k^2 + k'^2) (A'_{12}{}^2 + B'_{12}{}^2) = (k A'_{12} + k' B'_{12})^2 \quad ; \quad M(W_1)^2 = \frac{1}{2} g^2 (k^2 + k'^2)$$

And the crucial equation (3.21) remains the same :

$$(m_c - m_u)^2 \cos^2 \theta_C \sin^2 \theta_C = \frac{2M(W_1)^2}{g^2} (A'_{12}{}^2 + B'_{12}{}^2) \quad (3.B.6)$$

iv) diagrams to consider :

They are unchanged, since the spinors in the scattering amplitude are physical states (unaffected) and not weak eigenstates (rotated).

In the end, a redefinition of A and B (3.B.5) is the only consequence of the introduction of S. Our final result, which does not depend on A or B, is unaffected.

Appendix C

More quark generations.

The factors arising in the Feynman integral from the U-type quark propagators and their couplings can be cast in a general matrix form, valid for any number of generations :

- for L-L (or R-R) diagrams :

$$\frac{k^2}{4} \left[R \left(\frac{1}{k^2 - m_i^2} \right) R^{-1} \right]_{12}^2 \quad (3.C.1)$$

- for L-R diagrams :

$$\left[R \left(\frac{m_i}{k^2 - m_i^2} \right) R^{-1} \right]_{12}^2 \quad (3.C.2)$$

where R is the generalized (real orthogonal : no CP violation here)

Cabibbo matrix, and $\left(\frac{1(m_i)}{k^2 - m_i^2} \right)$ stands for the diagonal matrix :

$$\begin{pmatrix} \frac{1(m_u)}{k^2 - m_u^2} & & & \\ & \frac{1(m_c)}{k^2 - m_c^2} & & \\ & & \dots & \\ & & & \dots \end{pmatrix}$$

The difference between (3.C.1) and (3.C.2) comes from the fermion helicity-flip (see (3.10 a and b)). For one given heavy quark with mass $m_H \ll M(W_1)$, the amplitude is proportional to :

$$m_H^2 \quad \text{for } A_{LL}$$

$$m_H^2 \text{ Log } \frac{M(W_1)^2}{m_H^2} \quad \text{for } A_{LR}$$

Hence if A_{LL} is corrected by a factor $(1 + \alpha_H)$ to allow for the presence of m_H , A_{LR} will be corrected by a factor

$$1 + \alpha_H \left(\frac{\text{Log}(M(W_1)^2/m_H^2)}{\text{Log}(M(W_1)^2/m_c^2)} \right)$$

Our limit (3.56) was essentially obtained by stating :

$$A_{LL} + A_{LR}(\beta) > 0, \text{ or } 1 + \frac{A_{LR}(\beta)}{A_{LL}} > 0 \quad (3.C.3)$$

where A_{LR} is proportional to β . Equation (3.C.3) now becomes (for α_H small)

$$1 + \left(1 + \alpha_H \frac{\text{Log}(m_c^2/m_H^2)}{\text{Log}(M(W_1)^2/m_c^2)} \right) \frac{A_{LR}(\beta)}{A_{LL}} > 0 \quad (3.C.4)$$

which yields a new limit β_H instead of β , such that :

$$\beta_H \lesssim \beta \left(1 + \alpha_H \frac{\text{Log}(m_H^2/m_c^2)}{\text{Log}(M(W_1)^2/m_c^2)} \right) \quad (3.C.5)$$

β is pushed up, and the lower bound on $M(W_2)$ is pushed down (α_H is positive if one just "adds" a new quark generation, whatever the mixing angles, because the couplings are all squared in our box diagrams).

The problem is to evaluate α_H . Many calculations have been performed of A_{LL} in the standard model with three quark generations³⁵. They all express the basic fact :

$$\alpha_H \sim 0 \left(\frac{m_t^2 \sin^2 \phi}{m_c^2 \sin^2 \theta_C} \right) \quad (3.C.6)$$

where ϕ (actually some function of θ_2 and θ_3 in the Kobayashi-Maskawa matrix) represents the mixing between the third generation and the first two. Since m_t can be anywhere from ~ 20 GeV (the present experimental

limit) to ~ 80 GeV (the W-mass : our calculation has assumed throughout that $m_q \ll M(W_1)$, and it would need a more detailed treatment for heavier quarks), it is crucial to obtain limits on θ_2 and θ_3 . One knows that $\sin^2 \theta_3 \lesssim 0.06$ from separate measurements of $\cos^2 \theta_C$ and $\sin^2 \theta_C$. But most published limits on θ_2 are useless, since they are based on the assumption that the Gaillard-Lee calculation of Δm_{LS} should not be upset by the presence of a top-quark, which is precisely the hypothesis that we want to check. The only independent limit, obtained from top-quark contributions to $K_L \rightarrow \mu^+ \mu^-$, does not significantly restrict θ_2 ³⁶. So we can only assume reasonably that $\phi \lesssim \theta_C$ (the wider the mass gap between two generations, the smaller the mixing) ; α_H can still be much greater than unity, and push down our limit on $M(W_2)$ considerably.

As an extreme case, let us imagine that $m_t \sim O(M(W_1))$, and $\alpha_H \gg 1$. Then the $K_L - K_S$ mass difference comes mostly from the top-quark contribution. We can repeat our calculation of III,B and C, simply replacing the charmed quark (now negligible) by the top quark. $\text{Log}(M(W_1)^2/m_t^2)$ is now ~ 1 , so (3.51) becomes :

$$1 - 3a(2\beta - \frac{1}{2}(\rho^+ - \rho^0)) \sim 0 \quad (3.C.7)$$

$$\text{or } \beta \sim \frac{1}{3a} + \frac{1}{4}(\rho^+ - \rho^0) \quad (3.C.8)$$

$(\rho^+ - \rho^0)$ is more likely to take values far from zero, since $M(W_2)$ is now closer to $M(W_1)$. Therefore :

$$\frac{1}{3a} - \frac{1}{4} < \beta < \frac{1}{3a} + \frac{1}{4} \quad (3.C.9)$$

Whether we believe in low or high current-quark masses does not make much difference at this point. For $a = 1$, we obtain :

$$\beta \lesssim \frac{1}{3} + \frac{1}{4}$$

$$\text{or } M(W_2) \gtrsim 105 \text{ GeV} \quad (3.C.10)$$

The presence of Higgses and/or W_2 just above 100 GeV is now *required* to cancel the huge A_{LL} amplitude generated by heavy t-quark exchange.

Our limit (3.56) is therefore quite sensitive to the presence of heavy quarks if they are sizeably coupled to s and d. The prevailing opinion, however, is that α_H should be 0.1 or less.^{31,35} One may generate more self-confidence in that opinion by checking MIT bag results³⁷ developed for any combination of operators between K^0 and \bar{K}^0 . They reproduce our results for A_{LR} within a factor 2, but the bag model itself is built around 2 quark generations only... We conclude that our limit (3.56) for $M(W_2)$ is valid for two generations, but that we need more data to confirm its validity in a 3-generation world. It might be pushed down slightly, or in the worst case to ~ 105 GeV.

Chapter IV.

Other processes investigated.

Although the $K^0 - \bar{K}^0$ system considered in Chapter III is a "clean" system which can be described in detail as far as weak interactions go, the large uncertainty (a factor ~ 3) in strong interaction effects limits its attractiveness. Here we study other processes whose mechanism cannot be described in complete detail, but which can be analyzed in terms of current algebra and soft pion theorems whose accuracy is believed to be $\sim 10\%$ (yielding potentially better limits overall than $K^0 - \bar{K}^0$). We will look at non-leptonic hyperon decays (part A) and K decays $K_{2\pi}$ and $K_{3\pi}$ (part B).

A. Non-leptonic hyperon decays.

Apart from $\Sigma^0 \rightarrow \Lambda \gamma$, which is electromagnetic, non-leptonic hyperon decays are all first-order weak processes, with emission of a pion. They are listed in Table 1, with their main characteristics. The spin and parity of the initial and final states are :

$$1/2^+ \rightarrow 1/2^+ 0^-$$

The decay can thus proceed via an S-wave, which will be parity-violating (PV), or a parity-conserving (PC) P-wave. We can parametrize the amplitude as :

$$\mathcal{M} = \bar{\psi}_{fin}(q) (A + B\gamma_5) \psi_{init}(p) \quad (4.1)$$

or, making a non-relativistic approximation, with $S = A$, $P = \frac{|\vec{q}|}{E_{fin} + m_{fin}}$ B :

$$\mathcal{M} \propto \chi_{fin}^+ (S - P \vec{\sigma} \cdot \hat{q}) \chi_{init} \quad (4.2)$$

where \hat{q} is a unit vector in the direction of the momentum \vec{q} of the final baryon. This expression makes clear the appellation of S and P for the S- and P-amplitudes.

S and P can be determined from experiment in the following way :

i) For a polarized initial hyperon with density matrix $\chi\chi^\dagger = \frac{1}{2}(1 + \vec{\sigma}\cdot\vec{\Pi})$, it is straightforward to calculate the differential decay ratio in the direction \hat{q} :

$$|\mathcal{M}|^2 \propto 1 - \frac{2 \operatorname{Re}(S^*P)}{|S|^2 + |P|^2} \vec{\Pi}\cdot\hat{q} \quad (4.3)$$

ii) The phases of S and P are determined independently. If we safely neglect minute CP violation effects, the Hamiltonian is T-invariant ; then the l -wave amplitude $a_l \equiv \text{out} \langle B\pi | H | Y \rangle_{\text{in}}$ satisfies :

$$a_l = \text{out} \langle B\pi | T^{-1} H T | Y \rangle_{\text{in}} = \text{out} \langle Y | H | B\pi \rangle_{\text{in}} \quad (4.4)$$

where spins and momenta have been reversed. But we are in a frame where Y is at rest, and a_l does not depend on spins ; so :

$$a_l^* = \text{in} \langle B\pi | H | Y \rangle_{\text{out}}$$

Now $|Y\rangle_{\text{out}} = |Y\rangle_{\text{in}}$; and $|B\pi\rangle_{\text{in}} \equiv e^{2i\delta_l} |B\pi\rangle_{\text{out}}$ defines δ_l , the phase-shift due to final state interactions. Hence :

$$a_l^* = e^{-2i\delta_l} a_l \quad (4.5)$$

The phases of S and P are $\delta_{\frac{1}{2}}^-$ and $\delta_{\frac{1}{2}}^+$, phase-shifts which can be measured from low-energy $B\pi$ scattering in principle.

iii) If needed, additional information on the relative magnitude and phase of S and P can be obtained by measuring the polarization of the

final baryon (for instance by measuring the differential cross-section in a subsequent scattering experiment).

S and P can also, in principle, be fitted to the data for all the decays of Table 1 with only two parameters D and F, if one assumes SU(3) symmetry and octet dominance. The weak Hamiltonian, which consists of the symmetrized product of two octet-currents, can be decomposed into SU(3) representations according to :

$$(\underline{8} \times \underline{8})_S = \underline{1} + \underline{8}_S + \underline{27}$$

Under the assumption of octet dominance, the 27 part of this decomposition is suppressed, and the weak Hamiltonian transforms like an octet. Applying a soft pion theorem to any of the hyperon decays that we are considering yields :

$$\lim_{q_\mu \rightarrow 0} \langle B\pi(q) | H^{\text{PC}} | Y \rangle = \frac{\alpha}{f_\pi} \langle B | H^{\text{PV}} | Y \rangle + \text{pole terms containing a factor} \\ \langle B_1 | H^{\text{PC}} | B_2 \rangle$$

where H^{PC} and H^{PV} are the parity-conserving and parity-violating parts of the Hamiltonian H, which mediate P- and S-wave decays respectively, and α is a function of the isospins of π , B and Y. Now, by SU(3) symmetry and CP invariance :

$$\langle B | H^{\text{PV}} | Y \rangle = \langle B_1 | H^{\text{PV}} | B_2 \rangle = 0 ,$$

so that only the smooth first term (equal-time commutator term) will contribute for S-wave, and only the pole terms for P-wave decays.

Furthermore, since H is an SU(3) octet, the non-zero elements $\langle B | H^{\text{PC}} | Y \rangle$ and $\langle B_1 | H^{\text{PC}} | B_2 \rangle$ are the projections on an SU(3) singlet of $(8 \times 8 \times 8)$.

and thus can all be expressed as functions of only two independent parameters, because :

$$\underline{8} \times \underline{8} = \underline{1} + \underline{8}_s + \underline{8}_a + \underline{10} + \overline{10} + \underline{27} .$$

These parameters are called D (coupling strength of the symmetric octet) and F (for the antisymmetric octet). Given D and F, the data of Table 1 should be equally well fitted for all hyperon decays, and for S- and P-waves. Actually the fit can be made very good for S, but remains rather poor for P : the P-wave predictions are too small by a fairly consistent factor of ~ 2 (see Table 1 and Ref.38). The disagreement with experimental data can be expressed by :

$$\rho \equiv (B/A)_{\text{exp.}} / (B/A)_{\text{th.}} \sim 2 \quad (4.6)$$

Let us now change the Hamiltonian from its expression in the standard model, $\frac{G_F}{\sqrt{2}} J_L J_L^+$, to what it would be in a left-right symmetric model, namely (2.1). The coefficients in front of parity-violating and conserving terms are :

$$\text{- S-wave (PV) : } -(VA + AV) (1-\beta) \cos 2\zeta \quad (4.7a)$$

$$\text{- P-wave (PC) : } (VV + AA) (1+\beta) + (VV - AA) (1-\beta) \sin \zeta \cos \zeta \quad (4.7b)$$

where β and ζ , defined in (2.1) and (1.7b), are the squared mass ratio and the mixing angle of the two charged weak bosons. If we first assume $\zeta = 0$, then the ratio ρ (4.6) is modified according to :

$$\frac{\rho_{\text{LR}}}{\rho_{\text{WS}}} = \frac{1 + \beta}{1 - \beta} \quad (4.8)$$

A correction by a factor 2 would then be achieved for $\beta = 1/3$, ie.

$$M(W_2) \sim 140 \text{ GeV} \quad (4.9)$$

This prediction however loses its validity when one considers the general case $\zeta \neq 0$.

In that case, it has been argued³⁹ that the left-right (VV - AA) operator must be Fierz-transformed, which brings about a combination 2 (SS - PP), and that the amplitude obtained from a PP operator is much larger than the one obtained from the usual AA operator. The reasoning is quite similar to that in Chapter III,C : even though the mathematical justification for performing a Fierz-transformation on the left-right operator is rather complicated, the enhancement of the L-R amplitude which results is very natural.

The decay $Y \rightarrow B\pi$ can be described by the quark diagrams of Fig.4.1a and 4.1b. The weak interaction is point-like however, so that diagram 4.1b is suppressed with respect to 4.1a by a factor proportional to the overlapping of the wave-functions of the two weakly interacting quarks inside the hyperon. For this reason, we will only consider the spectator-quark diagram of Fig. 4.1a. The quark and antiquark which make up the pion in that case are produced at both ends of the W-propagator, and will have the same helicity (eg. $q_L \bar{q}_L = q_L \overline{(q_R)}$) only in the presence of a L-R mixing operator ; but the pion is a pseudoscalar, and outgoing quarks $q_L \overline{(q_L)}$, produced by the usual L-L operator, could never make a pion if they were massless. Therefore the regular L-L amplitude is suppressed by a factor $O(m_q/m_\pi)$ with respect to the L-R term. More precisely :

$$\frac{\langle B\pi | O_{LR} | Y \rangle}{\langle B\pi | O_{LL} | Y \rangle} \approx \frac{-2 \langle B | j^5 | Y \rangle \langle \pi | j^5 | 0 \rangle}{\langle B | j_\mu^5 | Y \rangle \langle \pi | j^{\mu 5} | 0 \rangle}$$

$$\langle \pi | j^5 | 0 \rangle \approx \frac{1}{2m_q} \partial_\mu \langle \pi | j^{\mu 5} | 0 \rangle$$

$$\text{and } \langle B | j^5 | Y \rangle \approx \frac{1}{m_s + m_q} \partial^\mu \langle B | j_{\mu}^5 | Y \rangle$$

where m_q represents a light quark mass (m_u, m_d) $\ll m_s$. Hence :

$$\frac{\langle B\pi | O_{LR} | Y \rangle}{\langle B\pi | O_{LL} | Y \rangle} \sim \frac{-m_\pi^2}{m_q(m_s + m_q)} \quad (4.10)$$

The quark masses to be used are again ambiguous, but Ref.39 claims that the above ratio is about 20. Then :

$$\frac{\rho_{LR}}{\rho_{WS}} \sim \left(\frac{1 + \beta}{1 - \beta} - 20 \sin\zeta \cos\zeta \right) \frac{1}{\cos 2\zeta} \quad (4.11)$$

One can see that a very small (< 0) mixing angle ζ is sufficient to explain the discrepancy (4.6), for any value of β . In fact it makes more sense to consider this result as a limit on ζ , independent of β , which brings further a posteriori justification to our setting $\zeta = 0$ in Chapter III.

The analysis of Ref.39 is more refined in that it considers strong interaction effects ("penguin" diagrams) which bring a further enhancement by a factor ~ 6 to the mixing terms ; but it ignores altogether the possible influence of a second, mostly right-handed, gauge boson.

Incorporating such a color enhancement factor in (4.11), one finds :

$$\frac{\rho_{LR}}{\rho_{WS}} \sim \frac{1 + \beta}{1 - \beta} - 120\zeta \quad (4.12)$$

from which one concludes :

$$|\zeta| \lesssim 10^{-2} \quad (4.13)$$

This is the same result as in Ref. 39, but we have shown here that it is essentially independent of the mass $M(W_2)$.

Finally, it should also be mentioned that the validity of the soft-pion procedure in the case of P-waves, as used in (4.10), is rather unclear : in the hyperon rest-frame, the P-wave amplitude is proportional to the pion momentum, and therefore vanishes in the soft pion limit $q \rightarrow 0$. For that reason the disagreement between theory and experiment indicated in (4.6) is generally believed not to be a compelling reason to modify the standard structure of the weak hamiltonian ; thus (4.9) should not be taken too seriously.

B. Hadronic K decays.

The decays $K_{\pi 2}$ and $K_{\pi 3}$ have been successfully related to each other by the use of soft pion theorems, under the assumption that the weak currents had the usual (V-A) structure. We want to see here how these relations are affected when the Hamiltonian takes a more general form.

Any soft pion theorem states that :

$$\lim_{q_\mu \rightarrow 0} \langle B \pi^i(q) | H | A \rangle = \frac{-i\sqrt{2}}{f_\pi} \langle B | [Q_5^i, H] | A \rangle \quad (4.14)$$

where Q_5^i is the axial charge :

$$Q_5^i(t) = \int d^3x A_0^i(x,t) \quad (4.15)$$

A_0^i is the time-component of the axial current (and i is the isospin index of the soft pion under consideration). The theorem is valid for any - local - operator H , in our case where the external particles are all pseudoscalars.

Now if H is the usual current-current Hamiltonian, the right-handside of (4.14) can be simplified because :

$$[Q_5^i, H] = [Q^i, H] \quad (4.16)$$

This stems from the simple formal identity between any two operators labelled V and A :

$$[A, (V-A)] = [V, (V-A)] \quad (4.17a)$$

However :

$$[A, (V+A)] = - [V, (V+A)] \quad (4.17b)$$

Therefore, if $H = (V-A)^2 + \beta(V+A)^2$, which is the form of (2.1) with $\zeta = 0$ (no mixing) :

$$[Q_5^i, H] = [Q^i, (V-A)^2 - \beta(V+A)^2] \quad (4.18)$$

That sign change ruins the usual relations :

$$[Q_5^i, H^{PV}] = [Q^i, H^{PC}] \quad ; \quad [Q_5^i, H^{PC}] = [Q^i, H^{PV}] \quad (4.19)$$

since here $H^{PV} = (1-\beta)(-AV-VA)$; $H^{PC} = (1+\beta)(V^2+A^2)$. The new corresponding relations are :

$$[Q_5^i, H^{PV}] = \frac{1-\beta}{1+\beta} [Q^i, H^{PC}] \quad (4.20a)$$

$$[Q_5^i, H^{PC}] = \frac{1+\beta}{1-\beta} [Q^i, H^{PV}] \quad (4.20b)$$

Such extra factors appear in particular in the correspondence between $K_{\pi 2}$ and $K_{\pi 3}$ amplitudes. With the assumption of CP invariance, one can relate, for instance, the amplitude $a_L(p_+, p_-, p_0)$ for the decay $K_L \rightarrow \pi^+ \pi^- \pi^0$ to the $K_{\pi 2}$ amplitudes a_-, a_+, a_S describing the 2π decays of K^-, K^+, K_S by taking successively the zero-limit of p_+, p_- and p_0 :

$$a_L(0, p_-, p_0) = \frac{-i}{f_\pi \sqrt{2}} \frac{1 + \beta}{1 - \beta} a_-(p_-, p_0) \quad (4.21a)$$

$$a_L(p_+, 0, p_0) = \frac{+i}{f_\pi \sqrt{2}} \frac{1 + \beta}{1 - \beta} a_+(p_+, p_0) \quad (4.21b)$$

$$a_L(p_+, p_-, 0) = \frac{-i}{f_\pi \sqrt{2}} \frac{1 + \beta}{1 - \beta} a_S(p_+, p_-) \quad (4.21c)$$

(4.21) (a) and (b) are related through CP invariance ; so we have two independent equations.

For comparison with experimental data, a_L must be extrapolated into the unphysical region where only two of the pions are on shell, to the point where their momenta satisfy, as required by $K \rightarrow 2\pi$:

$$p_1 = \left(\hat{n} \left(\frac{m_K^2}{4} - \mu^2 \right)^{1/2}, \frac{m_K}{2} \right) ; \quad p_2 = \left(-\hat{n} \left(\frac{m_K^2}{4} - \mu^2 \right)^{1/2}, \frac{m_K}{2} \right) \quad (4.22)$$

where we work in the K rest-frame, and m_K , μ are the kaon and pion masses.

The K_{π_3} amplitude is often parametrized linearly in the form :

$$a(p_1, p_2, p_3) = A \left(1 + \frac{\sigma}{2\mu^2} \omega_3 \right) \quad (4.23a)$$

where $A = a(p_1=p_2=p_3)$, σ is called the slope parameter, and :

$$\omega_i = s_i - \frac{1}{3} \sum_j s_j \quad ; \quad s_j = (p_j - p(K))^2 \quad ; \quad s_0 = \frac{1}{3} \sum_j s_j \quad (4.23b)$$

The pion π_3 in (4.23a) is the "odd" pion, the anti-particle of which is not produced in the decay considered. The unphysical point of interest defined in (4.22) corresponds to $s_3 = m_K^2$, $s_1 = s_2 = \mu^2$; so :

$$\omega_3 = \frac{2}{3} (m_K^2 - \mu^2) \quad ; \quad \omega_1 = \omega_2 = -\frac{1}{3} (m_K^2 - \mu^2) .$$

Our two soft pion relations from (4.21) become :

$$A \left(1 + \frac{\sigma}{3\mu^2} (m_K^2 - \mu^2) \right) = \frac{-i}{f_\pi \sqrt{2}} \frac{1 + \beta}{1 - \beta} a_S(\pi^+ \pi^-) \quad (4.24a)$$

$$A \left(1 - \frac{\sigma}{6\mu^2} (m_K^2 - \mu^2) \right) = \frac{+i}{f_\pi \sqrt{2}} \frac{1 + \beta}{1 - \beta} a_+ (\pi^+ \pi^0) \quad (4.24b)$$

The $|\Delta I| = \frac{1}{2}$ rule requires $a_+ (\pi^+ \pi^0) = 0$, so that one should have :

$$\sigma \approx \frac{6\mu^2}{m_K^2 - \mu^2} \sim 0.5, \quad (4.25)$$

the experimental value being ~ 0.6 (see Table 2). This result is independent of β . A is also determined from (4.24) :

$$A = \frac{-i}{3\sqrt{2} f_\pi} \frac{1 + \beta}{1 - \beta} a_S (\pi^+ \pi^-) \quad (4.26)$$

Experimentally the left-handside is $(0.82 \pm 0.03) \cdot 10^{-6}$, and the equality is satisfied for :

$$f_\pi \frac{1 - \beta}{1 + \beta} \sim 85 \pm 5 \text{ MeV} \quad (4.27)$$

Formula (4.27) must be compared with the value obtained from the Goldberger-Treiman relation $f_\pi \approx 87 \text{ MeV}$, and that measured from $\pi \rightarrow \mu \nu$ decay $f_\pi \approx 93 \text{ MeV}$. In Chapter II,C, we already mentioned that f_π would be larger in a semi-leptonic process than in a hadronic process by a factor $\sim (1 + 2\zeta)$. Other attempts have been made to explain at least part of this apparent increase by neutrino mixing⁴⁰; so we would rather trust the lower value of f_π here. In any case our result (4.27) is consistent with $\beta = 0$. We can only conclude :

$$\frac{1 - \beta}{1 + \beta} \gtrsim \frac{80}{93}, \text{ allowing for } 1\sigma \text{ deviations in (4.27), or } \frac{75}{93} \text{ with } 2\sigma \text{ deviations,}$$

$$\text{or } M(W_2) \gtrsim 280 \text{ GeV for } 1\sigma \text{ deviations (240 GeV for } 2\sigma) \quad (4.28)$$

The same treatment as applied here to $K_L \rightarrow \pi^+ \pi^- \pi^0$ can be repeated on other $K_{\pi 3}$ amplitudes. All the results are consistent with $\beta = 0$, and

yield the same limit as (4.28).

Before this limit can be taken seriously however, it is necessary to check whether the soft-pion limit of the $K_{\pi 3}$ amplitude is a genuine $K_{\pi 2}$ amplitude : namely the two "hard" pions might form a mixture of $L = 0$ and of higher angular momentum states, accessible in a $K_{\pi 3}$ decay but not in $K \rightarrow 2\pi$.

The fact that the total angular momentum of the 3 pions must be zero, and that the total wave-function must be symmetric under the interchange of any 2 pions, together with CP invariance and the $|\Delta I| = \frac{1}{2}$ rule, restricts the angular momentum of a pion-pair to even values, but not exclusively to $L = 0$ (see Ref.41). True, centrifugal barrier effects will tend to suppress high-L states, but there may be a sizeable $L = 2$ fraction among the 3π final states. Such an admixture would ruin the $K_{\pi 3} - K_{\pi 2}$ relationship. Then the apparent success of such relations might be due to a lucky cancellation between $L = 2$ contamination and right-handed boson effects (with $M(W_2) < 280$ GeV) !

The wave-function describing a 2π $L = 2$ final state must be of the form :

$$\psi^{\mu\nu} = q^\mu q^\nu + \frac{q^2}{3p^2} p^\mu p^\nu - \frac{q^2}{3} g^{\mu\nu} \quad (4.29)$$

where $q = p_1 - p_2$ and $p = p_1 + p_2$, since it is a rank-2 tensor satisfying :

$$\psi^\mu_{\ \mu} = 0 \quad ; \quad p_\mu \psi^\mu_{\ \nu} = 0.$$

A corresponding rank-2 tensor can be built for the third pion from the

single vector p_3 :

$$T^{\mu\nu} = p_3^\mu p_3^\nu - g^{\mu\nu} \frac{p_3^2}{4} \quad (4.30)$$

So the amplitude for $K \rightarrow \pi_1(p_1) \pi_2(p_2) \pi_3(p_3)$ with $L(\pi_1\pi_2) = 2$ will be :

$$A \propto \psi^{\mu\nu} T_{\mu\nu} = (q \cdot p_3)^2 + \frac{q^2}{3} \left[\frac{(p \cdot p_3)^2}{p^2} - p_3^2 \right] \quad (4.31)$$

If we now express the right-hand side in terms of $s_{1,2,3,0}$ defined in (4.23b), (4.31) becomes :

$$A \propto 1 + \frac{1}{4} \frac{m_K^2 - 3\mu^2}{(5\mu^2 - m_K^2/3)(2\mu^2 - m_K^2/3)} \left[(s_3 - s_0)^2 + (s_1 - s_2)^2 \right] + \text{cubic terms} \quad (4.32)$$

If we finally symmetrize A properly and select π_3 as the "odd" pion, we get :

$$A(K \rightarrow 3\pi^0) \propto 1 + 2a (s_3 - s_0)^2 + \frac{2}{3}a (s_1 - s_2)^2 + \text{cubic terms} \quad (4.33a)$$

$$A(K \rightarrow \pi_1\pi_2\pi_3) \propto 1 + \frac{5}{2}a (s_3 - s_0)^2 + \frac{1}{2}a (s_1 - s_2)^2 + \text{cubic terms} \quad (4.33b)$$

$$\text{where } a \equiv \frac{1}{4} \frac{m_K^2 - 3\mu^2}{(5\mu^2 - m_K^2/3)(2\mu^2 - m_K^2/3)}$$

Equation (4.33b) does not contain any linear terms. The presence of an $L = 2$ final state shows up through a quadratic dependence in the amplitude (the data are not accurate enough to test higher order terms).

Equation (4.33a) should not contain any linear term anyway, because the three pions are identical, but the size of the quadratic coefficient will measure the admixture of $L = 2$ states.

The experimental data are usually fitted with three parameters σ, α, β :

$$A(K \rightarrow 3\pi) = A(s_1=s_2=s_3) \left(1 - \frac{\sigma}{2\lambda} \frac{(s_3-s_0)}{\mu^2} + \frac{\alpha}{2\lambda^2} \frac{(s_3-s_0)^2}{\mu^4} + \frac{\beta}{6\lambda^2} \frac{(s_1-s_2)^2}{\mu^4} + \dots \right) \quad (4.34)$$

$$\text{where } \lambda \equiv \frac{2}{3} \frac{m_K(m_K - 3\mu)}{\mu^2}$$

The minute differences in π and K masses for the various decays bring very significant differences in μ and λ , so we averaged m_K^2/μ^2 separately for each process. Comparison between the predictions for α and β if the final state is all $L = 2$ for the two pions and the measured values is difficult, since there are very few experimental results and they do not always overlap. Nonetheless it can be concluded from Table 2 that, if the $L = 2$ final states are the sole source of quadratic terms in the amplitude, they are not present above a level $\lesssim 1-2\%$.

This result gives us increased confidence in the validity of the $K_{\pi 3} - K_{\pi 2}$ relations, and in the limit derived through them (for zero-mixing angle ζ^*) :

$$M(W_2) \gtrsim 280 \text{ GeV.}$$

* Unfortunately the commutator $[Q_5^1, (Y+A)(Y-A)]$ cannot be reduced to an isospin commutator, and the effects of a L-R mixing term have not been determined yet.

Conclusion.

Our criterion in choosing ways to determine the mass-scale for parity-breaking was model-independence. All the processes investigated here depend essentially on the charged weak sector, which is rather rigidly determined by the choice of the gauge group $SU(2)_L \times SU(2)_R \times U(1)_{B-L}$. But we discarded leptonic processes on the presumption that right-handed neutrinos might well be too heavy to be produced at all at present-day energies. Hence we were left with hadronic processes, contaminated by poorly known strong interactions. Model-independence was thus achieved at the expense of accuracy.

We could in several cases take advantage of a - high, but numerically uncertain - enhancement factor of new mixed left-right terms over the usual W - S terms, which appears whenever the quark and antiquark which interact weakly are bound in a pseudoscalar meson. But even so, various effects contribute, which limit the accuracy of our results :

i) From the $K^0 - \bar{K}^0$ system, the limit (conservative in some sense - see p.51)

is

$$M(W_2) \gtrsim 370 \text{ GeV.}$$

But strong interaction effects are very difficult to evaluate. And model-dependence reappears in the Higgs contribution to the $K_L - K_S$ mass difference. Furthermore, the influence of the top quark may be very important, but has been neglected for want of data. In case the top quark indeed has sizeable couplings to the first two generations, the mass of W_2 may very well lie in the 100-300 GeV range.

ii) From hyperon and kaon decays, the limits obtained were :

$M(W_2) \gtrsim O(280 \text{ GeV})$, depending on the precise value of f_π and the allowance for theoretical uncertainty.

$$|\tan \zeta| \lesssim 1-2 \%$$

Besides other related approximations like SU(3) symmetry, the theory behind both processes relies on soft pion theorems, which should not be expected to be verified within a better accuracy than $\sim 10 \%$.

Thus in both cases i) and ii), it seems difficult to reach a better limit than :

$$M(W_2) \gtrsim O(300) \text{ GeV} ,$$

which already corresponds to a change in the usual W-S amplitude by less than 10 %.

When viewed in the context of a grand unified SO(10) model, these results are, unfortunately, not quite sufficient to rule out a low mass for W_2 . The grand unified left-right symmetric model has many more parameters than the standard SU(5) model, and is therefore much more adaptable to phenomenological requirements. For that reason, the accumulation of more low-energy data and the improvement on the accuracy of the neutral-current data will not likely be able to rule out the left-right symmetric model, although they might give the standard model a less firmly established status. It seems however that the presence of a fairly light (less than $\sim 500 \text{ GeV}$) W_2 would place so many constraints on the parameters of our model that several pieces of indirect evidence should be accumulated very soon in such a case, to help us differentiate

between $SO(10)$ and $SU(5)$:

- i) No proton decay should be observed in the next generation of experiments, because the grand unification mass in $SO(10)$ is too high.
- ii) Neutrinoless double- β decay should be observable soon, provided that the right-handed neutrino has itself a mass of order 300 GeV.
- iii) The mass spectrum of the usual W and Z should be shifted down, with $M(W) < 80.5$ GeV and $M(Z) < 92$ GeV .

These experimental results will soon decide the fate of the left-right symmetric model.

References.

- [1] S. Glashow, Nucl. Phys. 22, 579 (1961)
 S. Weinberg, Phys. Rev. Letters 19, 1264 (1967)
 A. Salam, in Elementary Particle Theory, ed. N. Svartholm (Almquist and Forlag, Stockholm, 1968).
- [2] H. Georgi and S. Glashow, Phys. Rev. Letters 32, 438 (1974)
- [3] H. Georgi, H. R. Quinn and S. Weinberg, Phys. Rev. Letters 33, 451 (1974)
- [4] V. Lubimov et al., Phys. Lett. 94B, 266 (1980)
- [5] J. C. Pati and A. Salam, Phys. Rev. D10, 275 (1974)
 R.N. Mohapatra and J. C. Pati, Phys. Rev. D11, 566, 2558 (1974)
 G. Senjanovic and R. N. Mohapatra, Phys. Rev. D12, 1502 (1975)
 For a review see G. Senjanovic, Proceedings of the Telemark Neutrino Mass Mini-Conference and Workshop, 1980, eds. V. Barger and D. Cline, Univ. of Michigan report #186, p.121.
- [6] G. Senjanovic, Nucl. Phys. B153, 334 (1979)
- [7] R. N. mohapatra and G. Senjanovic, Phys. Rev. Lett. 44, 912 (1980)
- [8] See for example J. D. Bjorken, Proceedings of Summer Institute on Particle Physics, 1976, ed. M. C. Zipf, SLAC report # 198, or H. Quinn, *ibid.*, 1978, SLAC report # 215.
- [9] P. Q. Hung and J. J. Sakurai, Ann. Rev. Nucl. Part. Sci. 31, 375 (1981) for $\sin^2 \theta_W$. The value of $M(W)$ is less well established ; see eg. W.J. Marciano, Phys. Rev. D20, 274 (1979)
- [10] Review of Particle Properties, Particle Data Group, Rev. Mod. Phys. Vol. 52, No. 2, Part II (1980)

- [11] Q. Shafi, M. Sondermann and Ch. Wetterich, Phys. Lett. 92B, 304 (1980)
- [12] See for example I. Liede, J. Maalampi and M. Roos, Nucl. Phys. B146, 157 (1978) ; G. Ecker, Univ. of Vienna preprint UWThPh-79-30 (1979) ; I. Liede and M. Roos, Nucl. Phys. B167, 397 (1980)
- [13] T. Rizzo and G. Senjanovic, Phys. Rev. D24, 704 (1981)
- [14] J. E. Kim, P. Langacker, M. Levine and H. H. Williams, Rev. Mod. Phys. 53, 211 (1981)
- [15] T. Rizzo and G. Senjanovic, Phys. Rev. D25, 235 (1982)
- [16] M. A. B. Bégin, R. V. Budny, R. N. Mohapatra and A. Sirlin, Phys. Rev. Lett. 38, 1252 (1977)
- [17] M. Gell-Mann, P. Ramond and R. Slansky, unpublished
- [18] E. Witten, Harvard Preprint HUTP-80/A031 (1980)
- [19] E. Witten, Phys. Lett. 91B, 81 (1980)
- [20] See Ref. 7. Also Q. Shafi and Ch. Wetterich, Phys. Lett. 81B, 346 (1979). For a review of the various patterns of neutrino masses and oscillations, see eg. Dan-di Wu, SLAC preprint SLAC-PUB-2570 (1980)
- [21] B. Holstein and S. Treiman, Phys. Rev. D16, 2369 (1977)
- [22] See K. Kleinknecht, Ann. Rev. Nucl. Sci. 26, 1 (1976) and references therein
- [23] H. Primakoff and S. P. Rosen, Phys. Rev. 184, 1925 (1969)
A. Halprin, P. Minkowski, H. Primakoff and S. P. Rosen, Phys. Rev. D13, 2567 (1976)
- [24] H. F. Jones and M. D. Scadron, Phys. Rev. D11, 174 (1975)
- [25] M. K. Gaillard and B. W. Lee, Phys. Rev. D10, 897 (1974)
- [26] J. J. Aubert et al., Phys. Rev. Lett. 33, 1404 (1974)
J. E. Augustin et al., Phys. Rev. Lett. 33, 1406 (1974)
G. S. Abrams et al., Phys. Rev. Lett. 33, 1453 (1974)

- [27] R. E. Shrock and S. B. Treiman, Phys. Rev. D19, 2148 (1979)
- [28] K. Kang and J. E. Kim, Phys. Rev. D14, 1903 (1977). See also Ref. 27 and 37.
- [29] D. V. Nanopoulos and G. G. Ross, Phys. Lett. 56B, 279 (1975), and discussion in M. K. Gaillard, B. W. Lee and R. E. Shrock, Phys. Rev. D13, 2674 (1976)
- [30] K. Fujikawa, B. W. Lee and A. I. Sanda, Phys. Rev. D6, 2923 (1972)
- [31] G. Beall, M. Bander and A. Soni, UCLA preprint UCLA/81/TEP/29 (1981). For an early attempt in a slightly different model, see F. A. Wilczek, A. Zee, R. L. Kingsley and S. B. Treiman, Phys. Rev. D12, 2768 (1975)
- [32] P. Langacker and H. Pagels, Phys. Rev. D19, 2070 (1979)
P. Langacker, Phys. Rev. D20, 2983 (1979)
- [33] H. Leutwyler, Nucl. Phys. B76, 413 (1974)
- [34] C. Becchi, S. Narison, E. de Rafael and F. J. Yndurain, Z. Phys. C. Particles and Fields, 8, 335 (1981) ; S. Narison and E. de Rafael, Phys. Lett. 103B, 57 (1981). For a review see E. de Rafael, Marseille preprint CPT-81/P-1344 (1981).
- [35] See for example R. E. Shrock and L.-L. Wang, Phys. Rev. Lett. 41, 1692 (1978), and R. E. Shrock, S. B. Treiman and L.-L. Wang, Phys. Rev. Lett. 42, 1589 (1979).
- [36] R. E. Shrock and M. B. Voloshin, Phys. Lett. 87B, 375 (1979)
- [37] B. McWilliams and O. Shanker, Phys. Rev. D22, 2853 (1980)
- [38] R. E. Marshak, Riazzudin and C. P. Ryan, in Theory of weak interactions in particle physics, Wiley-Interscience Monographs and texts in Physics and Astronomy, vol. 24, New York, 1969, p.592. Also Y. Hara, Y. Nambu and J. Schechter, Phys. Rev. Lett. 16, 380 (1966),

- and L. S. Brown and C. M. Sommerfield, Phys. Rev. Lett. 16, 751 (1966).
- [39] I. I. Bigi and J.-M. Frère, Phys. Lett. 110B, 255 (1982)
- [40] R. Decker and L. P. Singh, Dortmund preprint DO-TH 80/22 (1980)
- [41] E. D. Commins, Weak interactions, McGraw-Hill, 1973, p. 281
- [42] M. K. Gaillard, Acta Phys. Slov. 24, 132 (1974)

Table 1 : Non-leptonic hyperon decays (after Ref. 10 and 38).

Hyperon	lifetime 10^{-10} sec.	decays (B.R.)	$A/A_{th.}$	$B/B_{th.}$	ρ (4.6)
Σ^+	0.80	$n \pi^+$ (48.4%)	0.06/0	19.05/6.5	--
		$p \pi^0$ (51.6%)	1.48/1.3	-12.04/6.3	1.7
Σ^-	1.48	$n \pi^-$	1.93/1.9	-0.65/+0.05	--
Λ^0	2.62	$p \pi^-$ (64.2%)	1.48/1.55	10.17/4.7	2.2
		$n \pi^0$ (35.8%)	-1.08/-1.1	-7.28/-3.3	2.2
Ξ^0	2.96	$\Lambda^0 \pi^0$	1.53/1.6	-5.90/-2.5	2.4
Ξ^-	1.65	$\Lambda^0 \pi^-$	2.04/2.25	-6.73/-2.5	2.1

Table 2 : $K_{\pi 3}$ decays (after Ref. 10 and 42).

Decay	$\frac{m_K^2}{\mu^2} \Big _{\text{av.}}$	σ ($\sigma_{\text{exp.}}$)	λ	a/μ^4	α ($\alpha_{\text{exp.}}$) all L=2	β ($\beta_{\text{exp.}}$) all L=2
+ - 0	13.0	0.50 (.58-.66)	1.46	-2.41	-10.3 (-0.05- -0.30)	-30.8
+ 0 0	13.1	0.49 (.50-.55)	1.49	-2.66	-29.5 (-0.38- -0.41)	-17.7
0 0 0	13.6	0	1.69	-4.80	-55 $((\alpha+\beta)_{\text{exp.}} = -0.02- +0.26)$	-55
+ + -	12.5	0.26 (.21-.22)	1.27	-1.58	-12.7 (-0.03- +0.08) $((\alpha+\beta)_{\text{exp.}} = -0.02- +0.06)$	-7.6

Figure captions.

- 2.1. Typical evolution of the running coupling constants in an SU(5) or SO(10) grand unification scheme. The low-energy values of α_{EM} , α_2 and, with a large uncertainty, of α_3 , are determined by experiment. Their energy-dependence is fixed by the choice of a gauge group and of corresponding particle representations, according to renormalization theory. One sees how the unification mass m_X changes between an SU(5) and an SO(10) grand unifying group.
- 3.1. The eight helicity combinations contributing to $\bar{s}d \rightarrow \bar{s}d$.
- 3.2. The two diagrams to consider in the standard model.
- 3.3. The Feynman amplitudes for the logarithmically divergent diagrams. They have been evaluated in unitary gauge, by dimensional regularization. The expression under each set of diagrams represents the corresponding amplitude, up to a factor $g_{12}^2 g_{LR}^2 / 4\pi^2$ (see p.41). One can see how the divergences cancel.
- 3.4. Examples of vanishing or negligible diagrams.
- 3.5. Variation of the normalized Higgs contribution ρ^+ or ρ^0 to the $K_L - K_S$ mass difference as a function of the Higgs mass. See Eq. (3.50).
- 3.6. Variation of the lower bound on $M(W_2)$ as a function of the enhancement factor \underline{a} (3.49), under the following assumptions :
- i) maximum Higgs contribution ($M(\phi^+) \sim M(W_1)$; $M(\phi^0) \sim \infty$) ;

- ii) $M(\phi^+) \sim 300 \text{ GeV}$; $M(\phi^0) \sim \infty$;
- iii) $M(\phi^+) \sim M(W_2)$; $M(\phi^0) \sim \infty$;
- iv) no Higgs at all ($M(\phi^+, \phi^0) \sim \infty$).

4.1. The two quark diagrams which mediate the hyperon decay $Y \rightarrow B\pi$.

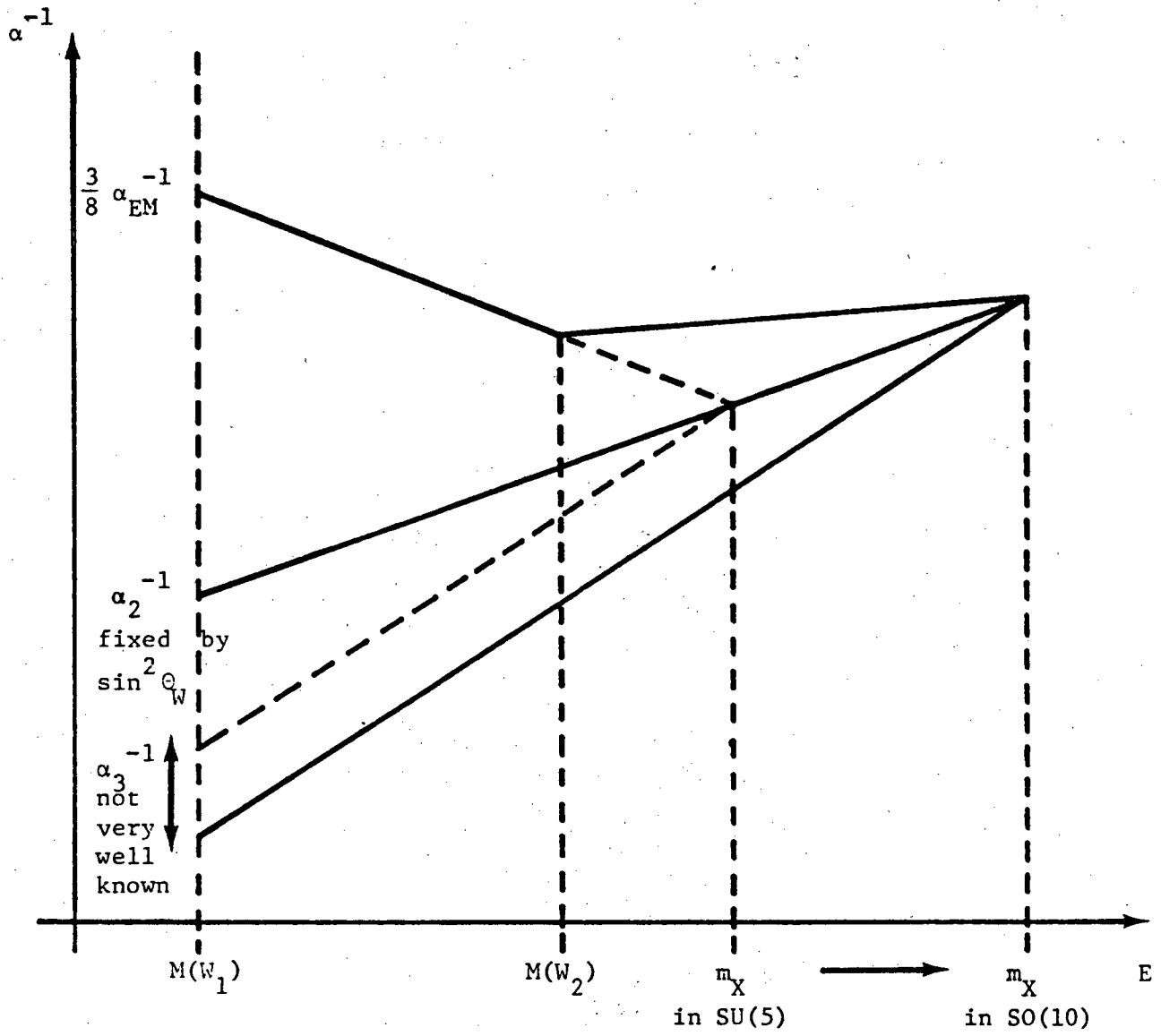

Figure 2.1

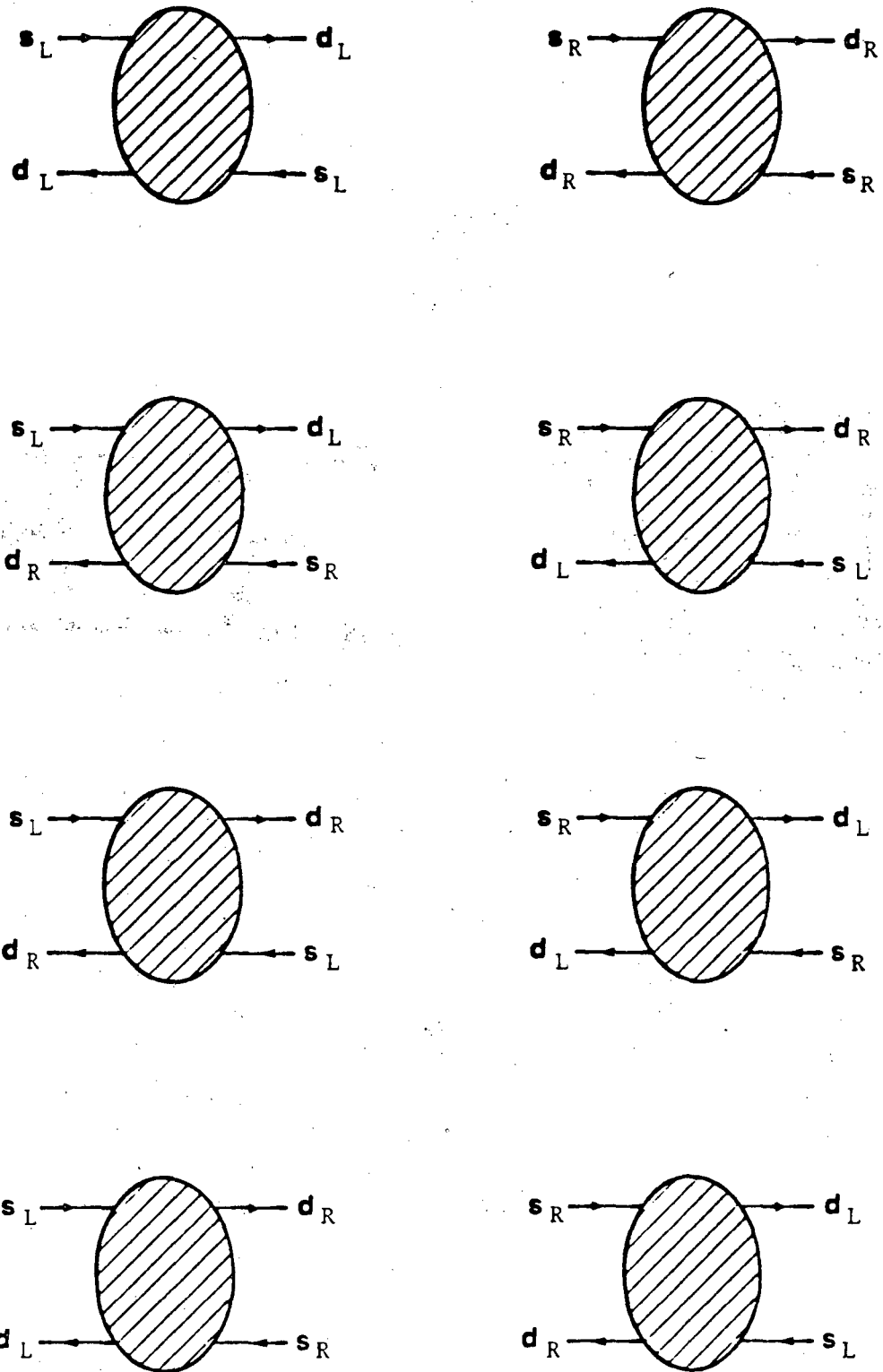
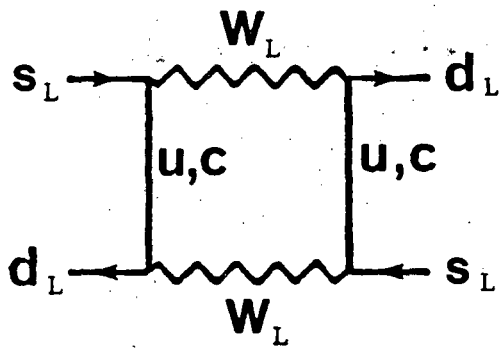
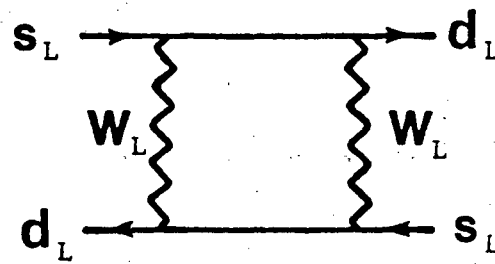

Figure 3.1



(a)



(b)

Figure 3.2

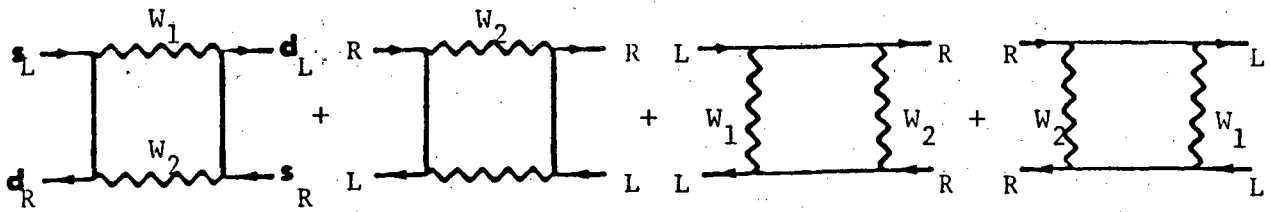

$$\implies -\frac{1}{n-4} \frac{\beta}{M(W_1)^2} - \frac{2\beta}{M(W_1)^2} \text{Log} \left(\frac{M(W_1)^2}{m_c^2} \right)$$

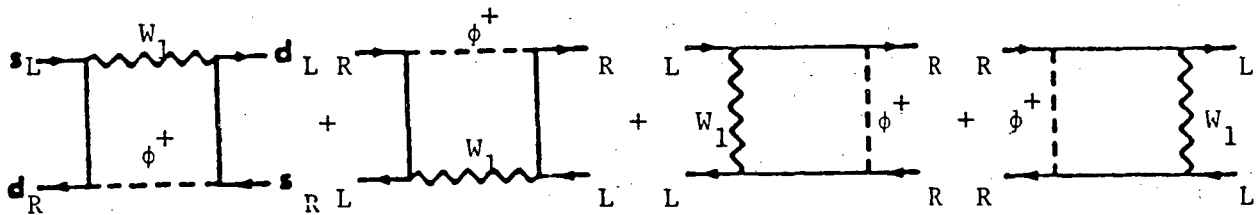

$$\implies (1-\beta) \left[-\frac{1}{n-4} \frac{1}{M(W_1)^2} + \frac{1}{2} \left(M(\phi^+)^2 - M(W_1)^2 \right)^{-1} \text{Log} \left(\frac{M(\phi^+)^2}{M(W_1)^2} \right) \right]$$

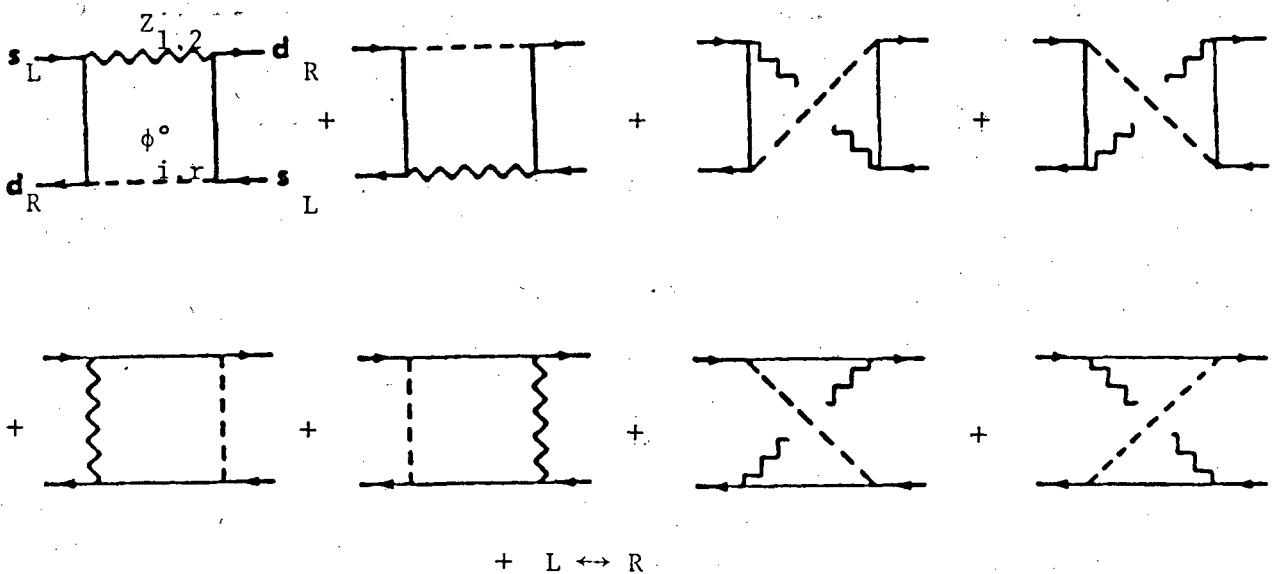

$$\implies \frac{1}{n-4} \frac{1}{M(W_1)^2} - \frac{1}{2} \left(M(\phi^0)^2 \cos^2 \theta - M(W_1)^2 \right)^{-1} \text{Log} \left(\frac{M(\phi^0)^2 \cos^2 \theta}{M(W_1)^2} \right)$$

$$- \frac{1}{2} \frac{\cos 2\theta}{\cos^2 \theta} \left(M(\phi^0)^2 - M(W_2)^2 \frac{\cos^2 \theta}{\cos 2\theta} \right)^{-1} \text{Log} \left(\frac{M(\phi^0)^2 \cos 2\theta}{M(W_2)^2 \cos^2 \theta} \right)$$

Figure 3.3

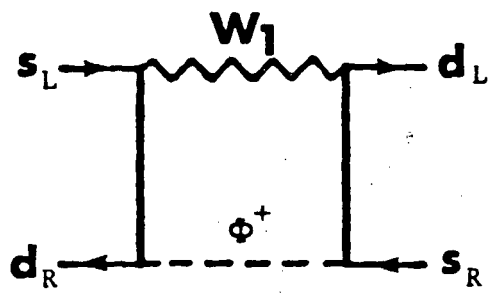

(a)

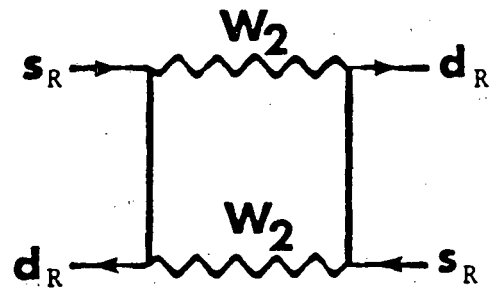

(b)

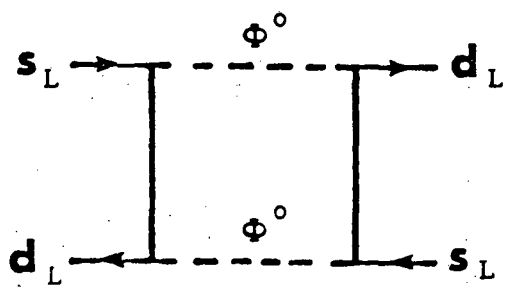

(c)

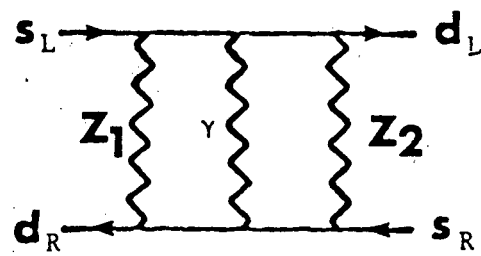

(d)

Figure 3.4

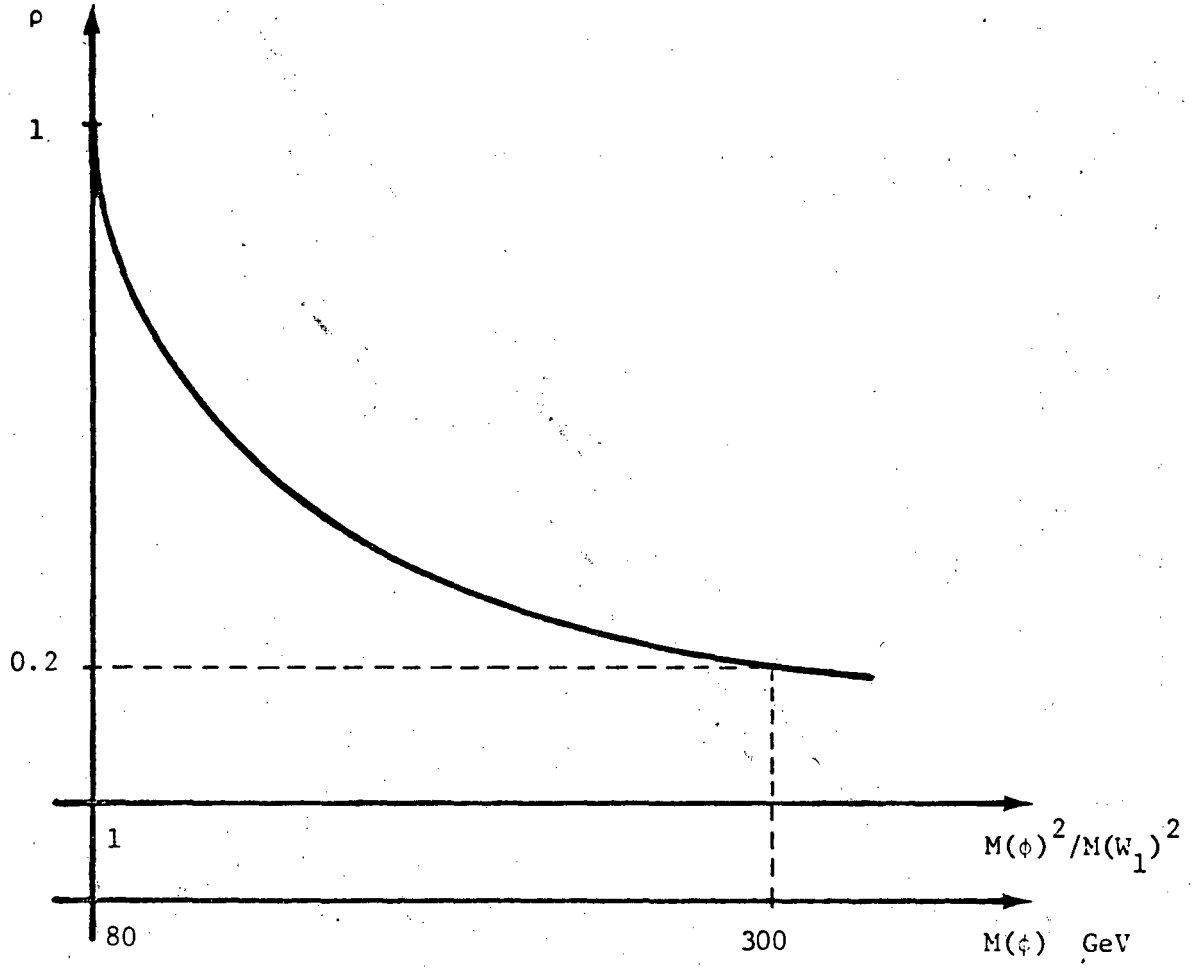

Figure 3.5

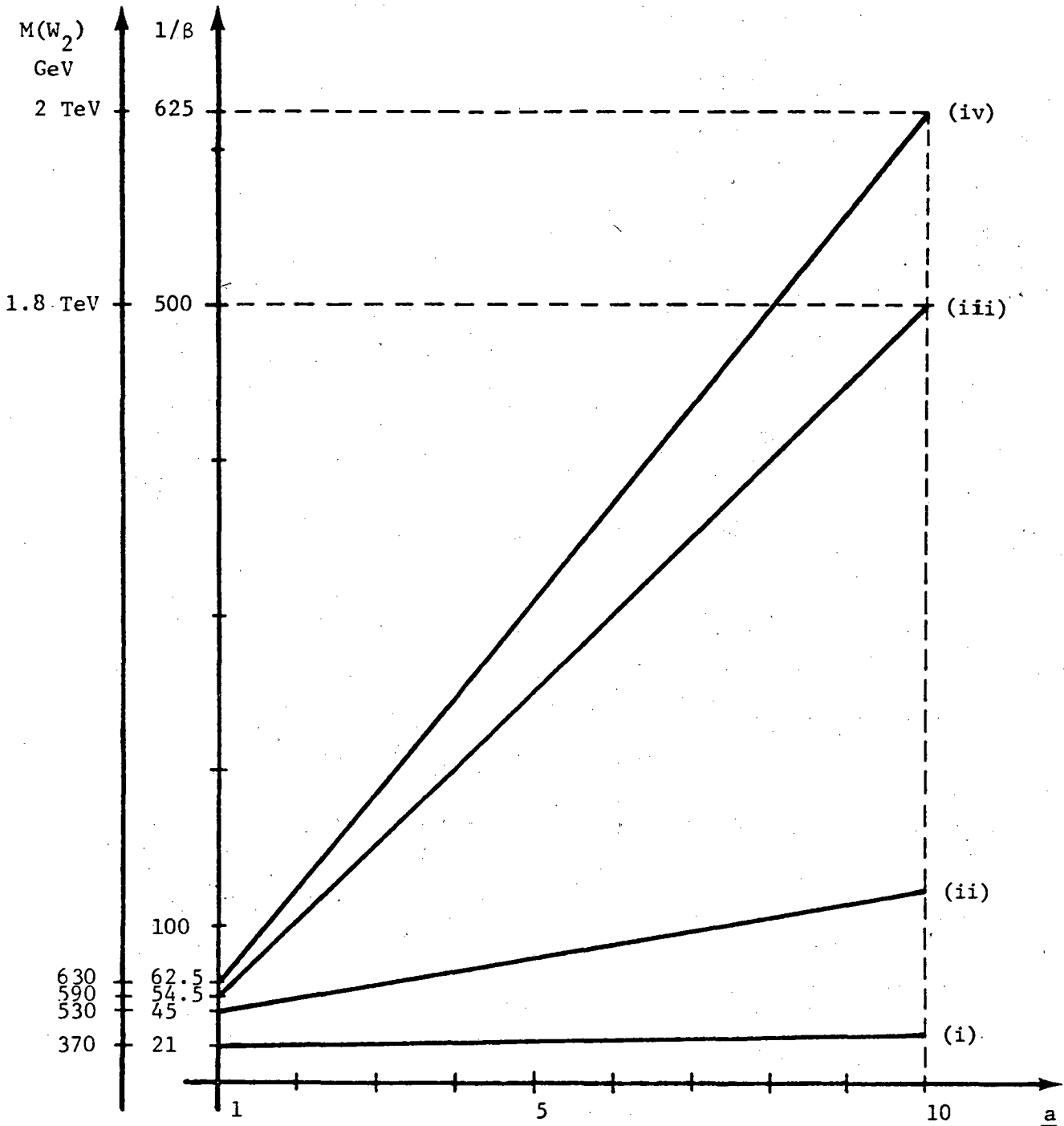

Figure 3.6

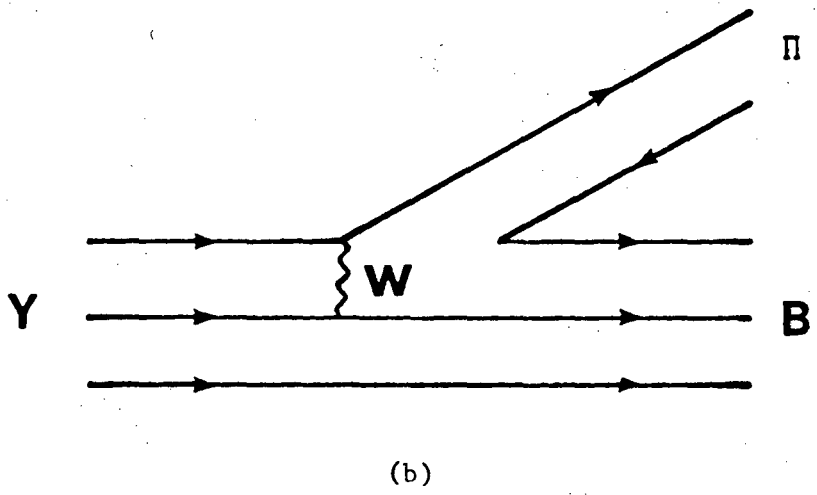
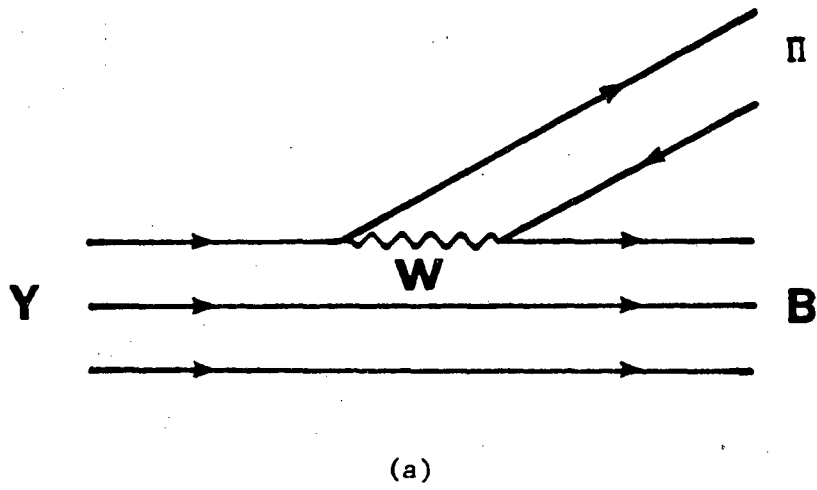

Figure 4.1

This report was done with support from the Department of Energy. Any conclusions or opinions expressed in this report represent solely those of the author(s) and not necessarily those of The Regents of the University of California, the Lawrence Berkeley Laboratory or the Department of Energy.

Reference to a company or product name does not imply approval or recommendation of the product by the University of California or the U.S. Department of Energy to the exclusion of others that may be suitable.

TECHNICAL INFORMATION DEPARTMENT
LAWRENCE BERKELEY LABORATORY
UNIVERSITY OF CALIFORNIA
BERKELEY, CALIFORNIA 94720