

Lawrence Berkeley National Laboratory

Lawrence Berkeley National Laboratory

Title

ENERGY SAVINGS WITH SOLID-STATE BALLASTED HIGH-PRESSURE SODIUM LAMPS

Permalink

<https://escholarship.org/uc/item/9x8470gg>

Author

Verderber, R.R.

Publication Date

1981-04-01

c.2

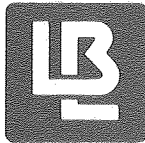

Lawrence Berkeley Laboratory

UNIVERSITY OF CALIFORNIA

RECEIVED

ENERGY & ENVIRONMENT DIVISION

JUN 17 1981

DOCUMENT

Invited paper presented at the annual Edison Electric
Institute Conference, Philadelphia, PA,
May 1-2, 1981

ENERGY SAVINGS WITH SOLID-STATE BALLASTED
HIGH-PRESSURE SODIUM LAMPS

R.R. Verderber and Oliver Morse

April 1981

TWO-WEEK LOAN COPY

*This is a Library Circulating Copy
which may be borrowed for two weeks.
For a personal retention copy, call
Tech. Info. Division, Ext. 6782*

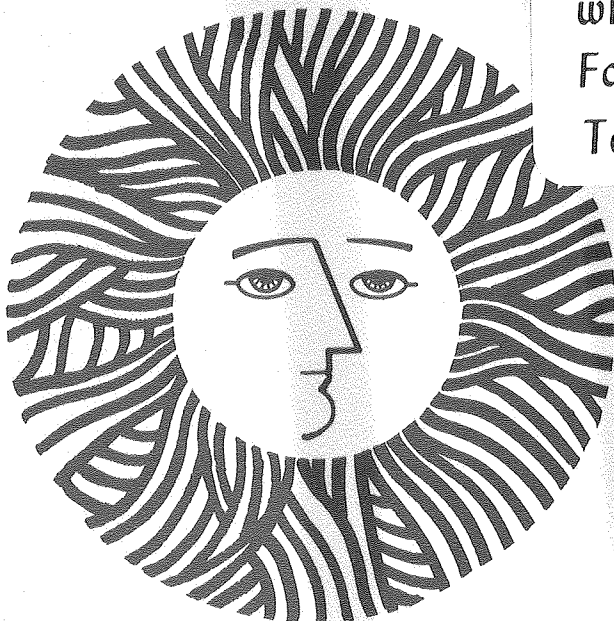

LBL-12595
c.2

DISCLAIMER

This document was prepared as an account of work sponsored by the United States Government. While this document is believed to contain correct information, neither the United States Government nor any agency thereof, nor the Regents of the University of California, nor any of their employees, makes any warranty, express or implied, or assumes any legal responsibility for the accuracy, completeness, or usefulness of any information, apparatus, product, or process disclosed, or represents that its use would not infringe privately owned rights. Reference herein to any specific commercial product, process, or service by its trade name, trademark, manufacturer, or otherwise, does not necessarily constitute or imply its endorsement, recommendation, or favoring by the United States Government or any agency thereof, or the Regents of the University of California. The views and opinions of authors expressed herein do not necessarily state or reflect those of the United States Government or any agency thereof or the Regents of the University of California.

LBL-12595
EEB-L-81-03
L-45

ENERGY SAVINGS WITH SOLID-STATE
BALLASTED HIGH-PRESSURE SODIUM LAMPS

R. R. Verderber and Oliver Morse

Lighting Systems Research
Lawrence Berkeley Laboratory
University of California
Berkeley, California 94720

April 1981

This paper was invited for presentation at the annual Edison Electric Institute Conference, May 1 and 2, 1981, Philadelphia, Pennsylvania.

This work was supported by the Assistant Secretary for Conservation and Solar Energy, Office of Building and Community Systems, Consumer Products Division of the U.S. Department of Energy under Contract No. W-7405-ENG-48.

ABSTRACT

This paper discusses the performance of three types of solid-state ballasts used to operate high-pressure sodium lamps. Each type of solid-state ballast has been designed to operate an HPS lamp of a different wattage (150, 200, and 400 watts). The performance of these ballasts compared to standard core-coil ballasts operating the same HPS lamps shows that system efficiency improves as much as 17%. The solid-state ballasted HPS system also demonstrates excellent regulation with respect to input voltage and output power. These new ballasts can dim the HPS lamps and reduce flicker from more than 60% to less than 3%.

Refitting street lighting with these new HPS systems provides an attractive return on initial capital investment.

1 INTRODUCTION

The use of high-intensity discharge (HID) lamps has continually increased since their introduction in the 1950s. The selection of the type of HID lamp--mercury (M), metal halide (MH), or high-pressure sodium (HPS)--for a particular application is now based primarily upon cost, system efficiency, and color rendition. Thus, mercury vapor lamps (17 to 46 lumens per watt), which were once widely used, are selected less frequently today in favor of either the metal halide system (54 to 92 lumens per watt) or the high-pressure sodium system (59 to 106 lumens per watt). In fact, the metal halide and the HPS systems are so cost-effective that operational mercury vapor systems are being retrofitted with these more efficient HID lamps.

This report presents some recent performance data on HPS lighting systems that are operated more efficiently at high frequency with solid-state ballasts. Several factors, other than improvement of intrinsic efficiency, will be introduced that affect the actual energy consumption of the installed HID lighting system. The factors that will be considered in the analysis of energy savings include voltage regulation, dimming, lumen depreciation, and the trapezoid traverse. A specific analysis of the cost-effectiveness of these new systems will be presented for street lighting.

2 EXPERIMENTAL

2.1 Instrumentation

The test circuit used throughout this study for measuring the per-

formance of the HPS systems is shown in Figure 2.1. The instruments measure the input RMS voltage, RMS current, and power to the ballast; the high-frequency RMS voltage, RMS current, and power input to the lamp. A Tektronic photometer with probe measures the light flux from the HPS lamp in the integrating sphere. The light measurement is proportional to the total light flux from the HPS lamp. Thus, what is measured is not the absolute light flux, but rather the changes that occur when the same HPS lamp is operated with different ballasts. From the above data the power factor and efficiencies can be determined.

The same circuit was used to obtain the trapezoid traverse data (lamp power vs. lamp voltage). The lamp voltage was increased by positioning an aluminum foil about the lamp to heat the alumina jacket around the gas discharge. The external heating causes the Na and Hg vapor pressure to increase, requiring a higher operating voltage to sustain the gas discharge. This simulates the aging process in HPS lamps.

2.2 Test Schedule

The solid-state HPS ballasts tested in this study were delivered to Lawrence Berkeley Laboratory (LBL) under a Department of Energy subcontract. Each subcontractor had been asked to deliver five ballasts to operate HPS lamps of a particular size. The three lamp sizes were 150 watt/55 volt, 200 watt, and 400 watt. The delivery and testing of the ballasts completed the first phase of the HID solid-state ballast program.

The ballasts were preliminary models that were to be tested and assessed by LBL staff to identify problem areas and provide a basis for

establishing realistic performance targets for future solid-state HID ballast designs.

3 RESULTS

3.1 Ballast Input, Light Output

Table 3.1 lists measurements for three HPS lamp systems operated with standard commercial core-coil ballasts and solid-state ballasts. The same HPS lamp was used for both the core-coil and the solid-state ballast for each wattage size. The solid-state ballast data listed is the average of the five ballasts tested. As stated previously (Section 2.1), the light measurements are relative. However, in order to provide readers with a means to relate this data to existing systems we arbitrarily selected, as a standard, the measured light output of the core-coil ballasted HPS lamps as being equivalent to the lamp manufacturer's specified mean light output.

3.2 Voltage, Light Regulation

Tables 3.2, 3.3, and 3.4 list the measured variations in light output for an input voltage to the ballast of $\pm 10\%$ around the design voltage. The tables show that light variations for core-coil ballasts can be as high as 30% or as low as 6%. The solid-state ballast circuit designs can achieve light regulations of $\pm 0.5\%$ for the $\pm 10\%$ input voltage variation.

3.3 Lamp Flicker

The time variation of the light intensity for the HPS lamps operated with core-coil ballasts (60Hz) and solid-state ballasts (25

kHz) was measured. The results are shown in Figures 3.1a and 3.1b for 400-watt lamps. The percent flicker was measured for these traces and found to be 69.5% and 1.5% for the 60Hz and the high-frequency operation, respectively. These results were the same for the lower wattage lamps (150 and 200 watts).

HPS lamps that produce flicker on the order of 60% or more create a stroboscopic effect¹ that could present a safety hazard for industrial applications. For less visually critical uses of HPS lamps the greater percent flicker could be a source of discomfort.

3.4 Power Trapezoid Traverse

As they operate through time, HPS lamps require a continually increasing operating voltage to maintain the discharge. The higher voltages are needed because of the continually increasing Hg and Na pressure.² It is possible to experimentally measure the power/voltage operating points by externally heating the alumina jacket that encloses the gas discharge. Figures 3.2, 3.3, and 3.4 show the power/voltage operating points for the three wattages. Each lamp has been operated with a standard core-coil and a solid-state ballast. The trapezoid constructed for the 150-watt and 400-watt HPS lamps enclose operating points set by the American National Standards Institute (ANSI). There is no ANSI standard trapezoid for the 200-watt lamp, but a reasonable one was constructed.

The shaded portion under the curves for the core-coil ballasts represents the excess power that is applied throughout the lamp's life due to the ballast's load regulation limitations. At any operating vol-

tage, the minimum power level is selected between the manufacturer's specified initial starting voltage and the high-voltage side of the trapezoid.

If one assumes that the rate of voltage increase is constant throughout the lamp's life, the shaded area is proportional to the excess energy. The manufacturer's rated lamp life for these HPS lamps is 24,000 hours. In the above figures the minimum lamp power is 134 watts, 200 watts, and 380 watts. The total input power to the system is obtained by dividing lamp power by ballast efficiency. Table 3.5 lists these values for the core-coil ballast, showing a total minimum input power of 170 watts, 263 watts, and 452 watts for the 150-watt, 200-watt, and 400-watt HPS lamp, respectively. The shaded areas under the three curves in Figures 3.2, 3.3, and 3.4 are 8%, 10%, and 6%, respectively, of the minimum energy consumed by these systems. This excess energy used over the 24,000 hour lamp life is 326.4, 631.2, and 650.9 kWh for the 150-watt, 200-watt, and 400-watt HPS lamp, respectively.

The operating power/voltage points for the solid-state ballasted systems are virtually at the same power; hence, these systems supply a constant power to the lamp throughout its life.

3.5 Component and System Efficiency

From the data listed in Table 3.1, the component (ballast and lamp) efficiencies as well as the system efficiencies can be calculated. These efficiencies are listed in Table 3.5, in which we have assumed the manufacturers' specified mean light outputs for the lamps.

Table 3.6 shows the relative efficiencies for the core-coil and

solid-state ballasts operating the same lamp. The results show that the solid-state ballast is more efficient, and the efficacy of the lamp is increased by operating it at high frequency. The results are in qualitative agreement with previous results for high-frequency operation of HPS lamps.³

While the results of these initial ballast designs show improved ballast and lamp efficiencies, we anticipate solid-state ballast efficiencies of 90% to 95% and increased lamp efficacies of 7%. These advanced designed systems should result in improved system efficiencies of 19% to 25% relative to existing HPS systems.

4. ENERGY ANALYSIS

4.1 Procedure

By considering an application for HPS lamps, we will use the performance data collected in this study to determine the optimum return on an energy-conserving strategy. A street-lighting application will be considered. This use is appropriate at this time since there have been many programs in which mercury vapor lamps have been retrofitted with HPS lamps. We will assess the economics of a mercury vapor system, a standard HPS system, and a solid-state ballasted HPS system. We will provide the basis on which an end user can arrive at the most cost-effective lighting system for a retrofit or new construction (renovation, replacement).

For our examples we will consider replacing a 400-watt mercury vapor lamp with a 200-watt HPS lamp since they have the same light output. Table 4.1 lists all the system characteristics needed for the

analysis. All of the cited parameters not measured in this study were obtained from the ballast and lamp manufacturers' catalogs. The excess illumination refers to the power/voltage traverse of the HPS lamps. In converting the input power to the mercury vapor lamp, the ballast was assumed to be 76% efficient. Thus, $400 \div 0.76 = 526$ for the input power of the mercury system.

4.2 Street Lighting

4.2.1 Retrofit

A familiar decision for many communities is whether to replace an operating mercury vapor street-lighting system with a more energy-efficient HPS system. Street lights will operate for an average of 12 hours a day, a total of 4380 hours annually. Table 4.2 lists the average power for the three lighting systems (mercury, standard HPS, and high-frequency HPS). This table gives the total average power based on the initial input power, the excess power supplied by the core-ballasted HPS lamp (see Figure 3.3), and the ability of the solid-state ballast to dim the HPS to provide a constant lumen level. Since HPS lamps have a lamp lumen depreciation of 20%, the dimming capability will reduce the average maximum power by 10% throughout the lamp's life.

Table 4.3 lists the initial and annual costs of the lighting system components: lamps, ballasts, and fixtures. The annual costs are calculated using equation 4.1. A discount rate of 15% is used and y is the life of the component. For an annual use of 4380 hours an expected lamp life is 6 years; fixture and ballast life is 12 years.

Table 4.3 shows annual energy cost as determined from the

calculated annual energy consumption of each system. The total annual costs (initial plus operating) are presented for each system. Two costs are given for the high-frequency HPS system based on initial ballast prices of \$75 and of \$100.

Using the appropriate initial costs for lamps and ballasts (from Table 4.1) and an operating life of 6 years and 12 years, respectively, we have determined the uniform annual cost (UAC) for a retrofit based upon an annual use of 4380 hours. (See equation 4.1.)

$$UAC = \text{Initial Cost} \left\{ \frac{1 - (1+i)^{-y}}{i} \right\} \quad (4.1)$$

where i is the discount rate (15%) and y is the number of years.

Table 4.4 lists the time it takes to repay the initial investment for refitting a mercury system with HPS lamps (payback period). We have considered the payback for a standard 60Hz HPS system and a high-frequency system. We assume the HPS lamp can use the same fixture as the mercury vapor lamp that it is replacing. The energy savings is with respect to a 400-watt mercury vapor system. The table also shows the payback time for purchasing a solid-state HPS ballast in place of the core ballast.

4.2.2. New Construction, Renovation

For new installations or renovations where one can choose between a mercury vapor and an HPS system, the decision is based upon a different set of conditions. Since the lighting investment decision has been made, one is concerned with the relative costs of possible systems. Table 4.5 lists the differences in cost between a mercury vapor system

and two HPS systems. The bottom line of this table gives the payback time. Note that neither the labor nor the fixture cost is included since they would also be incurred on the purchase of a mercury system. As with previous tables, we determine the costs of the high-frequency HPS system for solid-state prices of both \$75 and \$100.

4.2.3. Discussion

Tables 4.4. and 4.5 show that investing in an HPS system in place of a mercury vapor system is a sound decision at \$.05 or \$0.10 per kWh. As expected, for new construction and renovation the payback period is shorter. The choice between a \$50 core-coil ballasted and a \$75 solid-state ballasted HPS system is not definitive. For a retrofit, a generally acceptable payback period (2 years) prevails at energy rates above \$0.05 per kWh.

The last two columns in Table 4.4 compare the payback periods for a retrofit of a core-coil HPS ballast and a solid-state HPS ballast. At a solid-state ballast cost of \$100 the payback period is more favorable: 2.56 and 1.25 years at \$.05 and \$0.10 per kWh, respectively, than is the payback period of an HPS core ballast (2.88 and 1.44 years). Thus, at prices of \$100 or less, the most cost-effective decision would be to use a solid-state ballast to operate the HPS lamps.

Another metric for determining the cost-effectiveness of investing an energy-efficient lighting system is the return on investment (ROI). We consider this an important parameter since if the ROI is suitably high it means more capital will be available for other future corporate investments. Table 4.6 lists the ROIs for various HPS systems compared

to a mercury vapor system. The data in this table have been calculated from the data presented in Table 4.3. In general one finds, for new construction and renovation, that there is a high return on investment (ROI) for the HPS systems. At a cost of \$75 per ballast the solid-state HPS ballast provides about the equivalent ROI as does a core-coil ballast priced at \$50.

One must also recall that the solid-state ballast offers additional features which further improve its cost-effectiveness, that are not considered in this analysis. These include dimming in response to natural ambient illumination, excellent voltage regulation, and better quality illumination (no flicker).

If the above features are considered, solid-state ballasted HPS systems appear yet more attractive. For applications involving visual tasks the above features should be considered since they will assure that the HPS systems provide specified illumination levels throughout a lamp's life and are not a source of visual discomfort to users.

While at the present time we have not accumulated the necessary data, the operation of the HPS lamps at lower power levels should extend the life of the lamps and dissipate less heat. For indoor applications the lessened dissipation of heat should greatly reduce the air conditioning load.

5 CONCLUSIONS

HPS lighting systems in which lamps are operated at high frequencies with solid-state ballasts are more efficient (17%) than the same HPS lamps operated by core-coil ballasts. The HPS lamps operated at

high frequency are 4% more efficient. The solid-state ballasts can be designed to reach an efficiency of 86% in converting the 60Hz input power to the high-frequency power of the lamp.

The solid-state ballast provides a constant power to the lamp over wide ranges of lamp impedences, which results in a constant light flux output of the HPS lamp throughout its life. The ballast designs also include voltage regulation circuits that can limit changes in the light lamp's output to $\pm 0.5\%$ for a change in input voltage of $\pm 10\%$.

The high-frequency operation of the lamps also reduces the percent flicker from 60% to 1.5%.

Where HPS lighting systems can be employed they are a sound investment compared to the less efficient mercury vapor systems. For new street-lighting applications and for retrofit situations, the solid-state HPS ballast is a rational selection at a cost of over \$100 per ballast.

Acknowledgements

The support of this effort by the Assistant Secretary for Conservation and Renewable Energy, Office of Building and Community Systems, Consumer Products Division of the U.S. Department of Energy under Contract No. W-7405-ENG-48 is appreciated.

The efforts of the three subcontractors that supplied the solid-state ballasts, Jefferson Electric, Datapower, Inc., and Luminoptics Corp., is also recognized.

References

1. J.P Frier and A.J. Henderson, "Stroboscopic Effect of HID Lamps," Journal of the Illuminating Engineering Society 2, p. 83-86, Oct 1973.
2. J. Waymouth, Electric Discharge Lamps, The MIT Press, Cambridge, MA, p. 204, 2nd Ed., 1978.

3. J. H. Campbell, "HID Lamps on High Frequency Power," Journal of the Illuminating Engineering Society 60, p. 713, Dec 1965.

TABLE 3.1

PERFORMANCE OF HIGH-PRESSURE SODIUM SYSTEMS

	150-WATT/55V LAMPS		200-WATT/100V LAMPS		400-WATT/100V LAMPS	
	<u>CORE- COIL</u>	<u>SOLID- STATE</u>	<u>CORE- COIL</u>	<u>SOLID- STATE</u>	<u>CORE- COIL</u>	<u>SOLID- STATE</u>
<u>INPUT</u>						
VOLTAGE	120	120	277	277	240	277
POWER (WATTS)	189	183	279	231	445	450
POWER FACTOR	0.48	0.94	1.00	0.96	0.96	0.77
<u>OUTPUT</u>						
VOLTAGE	55	52	116	94	104	93
POWER (WATTS)	149	152	212	198	375	384
POWER FACTOR	0.82	0.96	0.82	0.96	0.82	0.97
<u>LAMP OUTPUT</u>						
FLUX (LUMENS)	15,000*	15,900	22,000*	21,400	45,000*	48,000

* ASSUMED LIGHT OUTPUT = MANUFACTURER'S RATED MEAN

TABLE 3.2

VOLTAGE, LIGHT REGULATION WITH 150-WATT LAMP

	CORE-COIL			SOLID-STATE		
	<u>132 V</u>	<u>120 V</u>	<u>108 V</u>	<u>132 V</u>	<u>120 V</u>	<u>108 V</u>
INPUT POWER (WATTS)	239	189	149	186	183	173
OUTPUT POWER (WATTS)	188	149	116	149	152	144
LIGHT FLUX (LUMENS)	19,800	15,000	10,600	15,500	15,900	14,800
RELATIVE FLUX	+ 32 %	0	- 29%	- 2.5%	0	- 6.9%

TABLE 3.3

VOLTAGE, LIGHT REGULATION WITH 200-WATT LAMP

	CORE-COIL			SOLID-STATE		
	<u>305 V</u>	<u>277 V</u>	<u>249 V</u>	<u>305 V</u>	<u>277 V</u>	<u>249 V</u>
INPUT POWER (WATTS)	294	279	264	233	231	230
OUTPUT POWER (WATTS)	223	212	200	199	198	197
LIGHT FLUX (LUMENS)	23,200	22,000	20,300	21,500	21,400	21,300
RELATIVE FLUX	+ 5.5%	0	- 7.7 %	+ 0.5%	0	- 0.5%

TABLE 3.4

VOLTAGE, LIGHT REGULATION WITH 400-WATT LAMP

	CORE-COIL			SOLID-STATE		
	<u>264 V</u>	<u>240 V</u>	<u>216 V</u>	<u>305 V</u>	<u>277 V</u>	<u>249 V</u>
INPUT POWER (WATTS)	478	445	405	457	450	435
OUTPUT POWER (WATTS)	401	375	337	373	384	386
LIGHT FLUX (LUMENS)	49,300	45,000	40,000	48,300	48,000	47,000
RELATIVE FLUX	+ 10%	0	- 11%	+0.6%	0	- 2.1%

TABLE 3.5
 COMPONENT AND SYSTEM EFFICIENCY

	<u>150-WATT LAMP</u>		<u>200-WATT LAMP</u>		<u>400-WATT LAMP</u>	
	<u>CORE- COIL</u>	<u>SOLID- STATE</u>	<u>CORE- COIL</u>	<u>SOLID- STATE</u>	<u>CORE- COIL</u>	<u>SOLID- STATE</u>
BALLAST	0.79	0.83	0.76	0.86	0.84	0.85
LAMP (LUMENS/WATT)	101	105	104	108	120	125
SYSTEM (LUMENS/WATT)	79	87	79	93	101	107

TABLE 3.6

RELATIVE EFFICIENCY INCREASES OF HIGH-FREQUENCY SYSTEMS

	<u>150-WATT LAMP</u>	<u>200-WATT LAMP</u>	<u>400-WATT LAMP</u>
BALLAST	1.05	1.13	1.01
LAMP	1.04	1.04	1.04
SYSTEM	1.10	1.17	1.06

TABLE 4.1

PERFORMANCE OF EQUIVALENT MERCURY AND HPS LIGHTING SYSTEMS

PARAMETER	MERCURY	HPS	HPS
		CORE-COIL BALLAST	SOLID-STATE BALLAST
LAMP POWER (WATTS)	400	200	200
LIGHT FLUX (LUMENS)	19,000	22,000	21,400
INPUT POWER (WATTS)	526	279	231
LAMP LIFE (HOURS)	24,000	24,000	24,000
LIGHT CHANGE ($\pm 10\%$ VOLTS)	$\pm 6\%$	+5.5% ; -7.7%	$\pm 0.5\%$
EXCESS ILLUMINATION (%)	0	10	0
FLICKER (%)	24	69	1
LAMP COST (\$)	16.00	58.00	58.00
BALLAST COST (\$)	35.00	50.00	75.00 ; 100.00
DIMMING RANGE	0%	0%	100 - 75%
LAMP LUMEN DEPRECIATION	20%	20%	20%

TABLE 4.2

AVERAGE POWER FOR MERCURY AND HPS SYSTEMS

	<u>MERCURY</u>	<u>LAMP SYSTEM</u>	
		<u>HPS</u>	<u>HIGH-FREQUENCY HPS</u>
INPUT POWER (WATTS) (INITIAL)	526	279	231
POWER INCREASE (WATTS) (POWER, VOLT TRAVERSE)	0	28(10%)	0
AVERAGE DIMMING FOR LUMEN DEPRECIATION (WATTS)	0	0	-23(10%)
TOTAL AVERAGE POWER (WATTS)	526	307	218
ANNUAL ENERGY CONSUMPTION (kWh)	2304	1345	955

TABLE 4.3

ANNUAL COMPONENT AND ENERGY COSTS

	MERCURY	HPS	HIGH-FREQUENCY_HPS	
<u>LAMP_COST_(\$)</u>				
INITIAL	16.00	58.00	58.00	
ANNUAL	4.24	15.37	15.37	
<u>LABOR_COST_(\$)</u>				
INITIAL	30.00	30.00	30.00	
ANNUAL	7.95	7.95	7.95	
<u>BALLAST_COST_(\$)</u>				
INITIAL	35.00	50.00	75.00	100.00
ANNUAL	6.48	9.25	13.88	18.50
<u>FIXTURE_COST_(\$)</u>				
INITIAL	50.00	50.00	50.00	
ANNUAL	9.25	9.25	9.25	
<u>ANNUAL_ENERGY_COST_(\$)</u>				
@ \$0.05 PER kWh	115.20	67.25	47.75	47.75
@ \$0.10 PER kWh	230.40	134.50	95.50	95.50
<u>TOTAL_ANNUAL_COST_(\$)</u>				
@ \$0.05 PER kWh	143.12	109.07	94.20	98.82
@ \$0.10 PER kWh	258.32	176.32	141.95	160.45

TABLE 4.4

RETROFIT COSTS OF HPS SYSTEMS

	HPS	HIGH-FREQUENCY HPS			
LAMP COST (\$)	58	58		(0)*	
LABOR COST (\$)	30	30		(0)*	
BALLAST COST (\$)	50	75	100	(25)	(50)
ANNUAL ENERGY SAVINGS (kWh)	959	1349	1349	(390)	(390)
ANNUAL SAVING (\$)					
@ \$0.05 PER kWh	47.95	67.45	67.45	(19.50)	(19.50)
@ \$0.10 PER kWh	95.90	134.90	134.90	(39.00)	(39.00)
PAY-BACK TIME (YEARS)					
@ \$0.05 PER kWh	2.88	2.42	2.79	(1.28)	(2.56)
@ \$0.10 PER kWh	1.44	1.21	1.39	(0.64)	(1.28)
ROI (%)					
@ \$0.05 PER kWh	35	41	36	78	39
@ \$0.10 PER kWh	69	83	72	156	78

* THIS COLUMN SHOWS THE DIFFERENCES BETWEEN A CORE AND A SOLID-STATE BALLASTED HPS SYSTEM.

TABLE 4.5

RELATIVE COSTS OF HID SYSTEMS FOR NEW CONSTRUCTION

	HPS	HIGH-FREQUENCY HPS	
	BALLAST COST \$50	BALLAST COST \$75	BALLAST COST \$100
LAMP COST (\$)	42	42	42
LABOR COST (\$)	0	0	0
BALLAST COST (\$)	15	40	65
ANNUAL ENERGY SAVINGS (kWh)	959	1349	1349
ANNUAL ENERGY COST			
(\$)			
@ \$0.05 PER kWh	47.95	67.45	67.45
@ \$0.10 PER kWh	95.90	134.90	134.90
PAY-BACK TIME (YEARS)			
@ \$0.05 PER kWh	1.19	1.22	1.59
@ \$0.10 PER kWh	0.59	0.61	0.79

TABLE 4.6

RETURN ON INVESTMENT FOR NEW CONSTRUCTION

<u>INVESTMENT</u>	<u>HPS</u>	<u>HIGH-FREQUENCY HPS</u>			
LAMPS (\$)	42	42	42	(0)*	(0)*
BALLAST (\$)	15	40	65	(25)	(50)
<u>TOTAL</u>	57	82	107	(25)	(50)
<u>ANNUAL ENERGY COST</u>					
@ \$0.05 PER kWh	47.95	67.45	67.45	(19.50)	(19.50)
@ \$0.10 PER kWh	95.90	134.90	134.90	(39.00)	(39.00)
<u>R.O.I. (PERCENT)</u>					
@ \$0.05 PER kWh	84	82	63	(78)	(39)
@ \$0.10 PER kWh	168	165	126	(156)	(78)

* FIGURES IN PARENTHESIS ARE RELATIVE TO THE STANDARD CORE-COIL BALLASTED HPS SYSTEM.

SYSTEM FOR MEASURING HPS
BALLAST PERFORMANCE

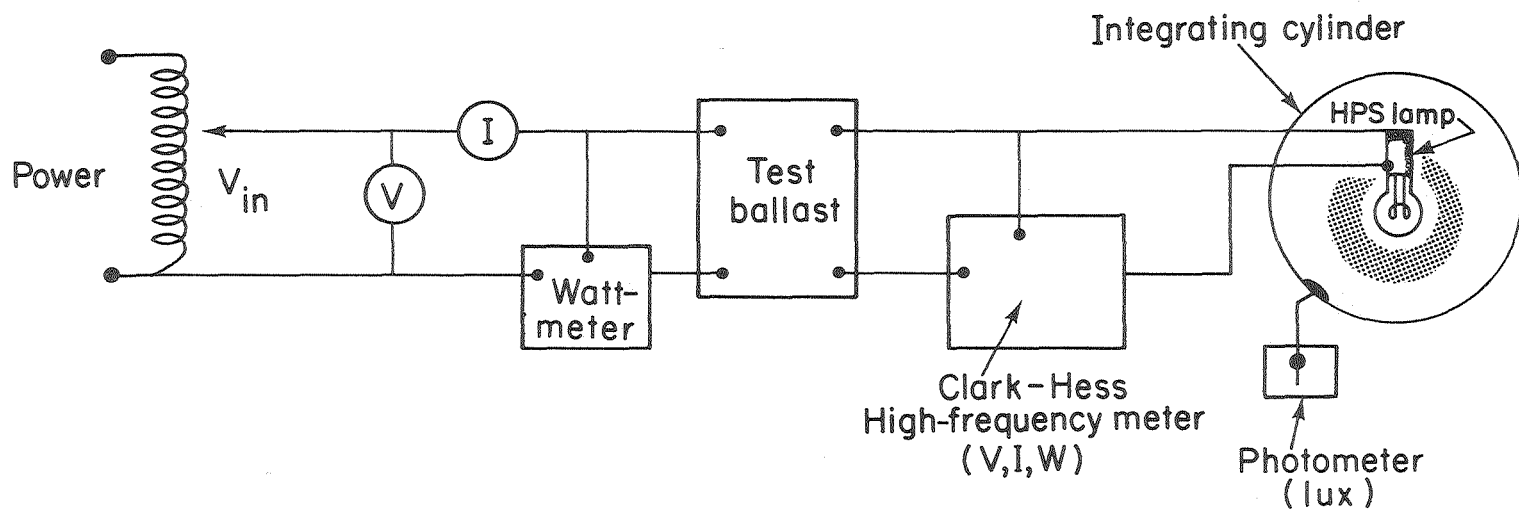

XBL 813-562

FIGURE 2.1

OSCILLOSCOPE TRACE OF LAMP INTENSITY

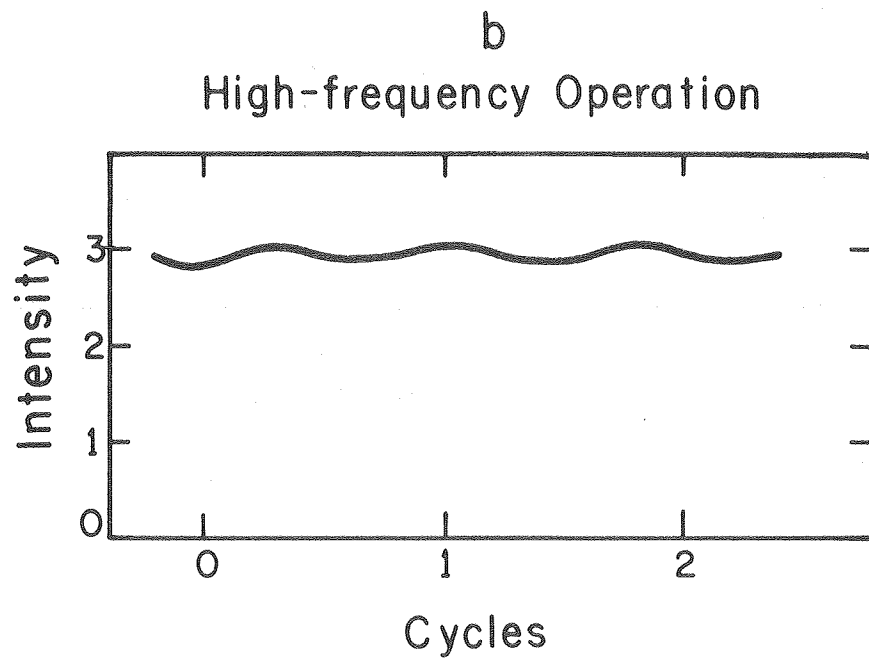
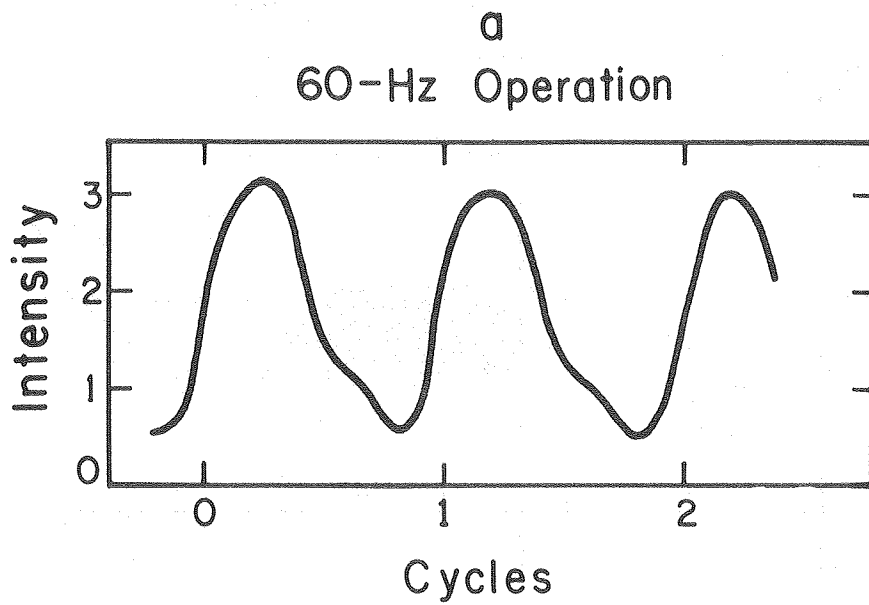

XBL 813-561

FIGURE 3.1

POWER TRAPEZOID TRAVERSE 150-watt lamp

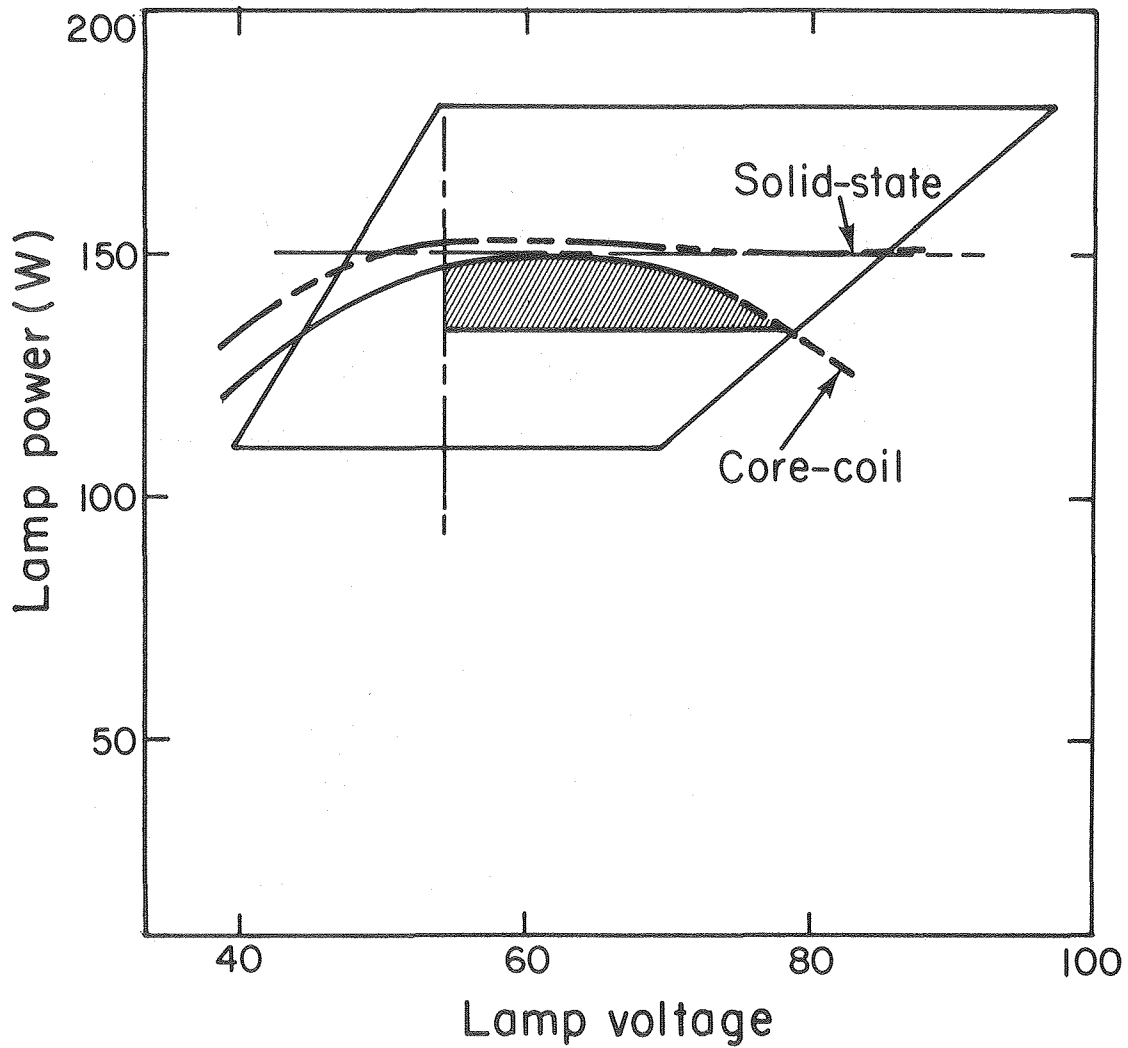

XBL813-560

FIGURE 3.2

POWER TRAPEZOID TRAVERSE 200-watt lamp

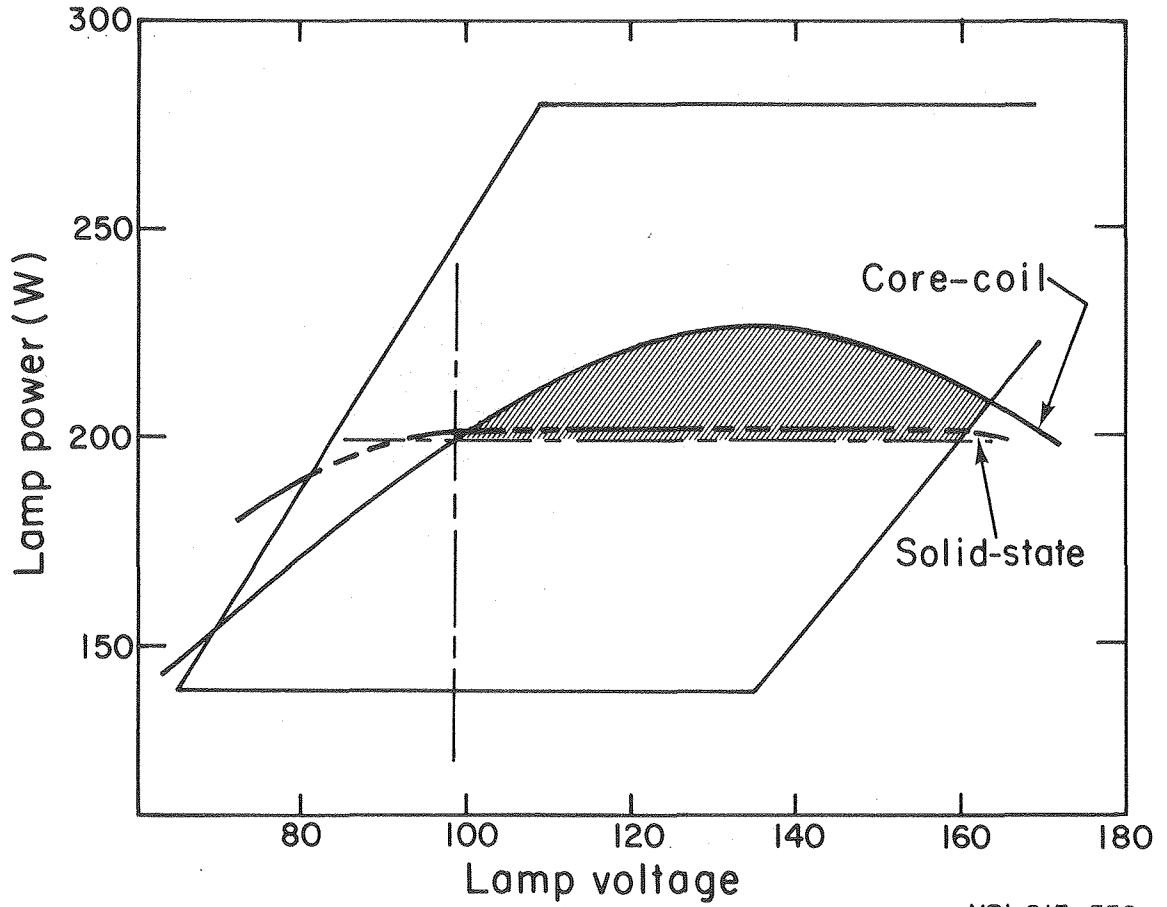

XBL813-558

FIGURE 3.3

POWER TRAPEZOID TRAVERSE 400-watt lamp

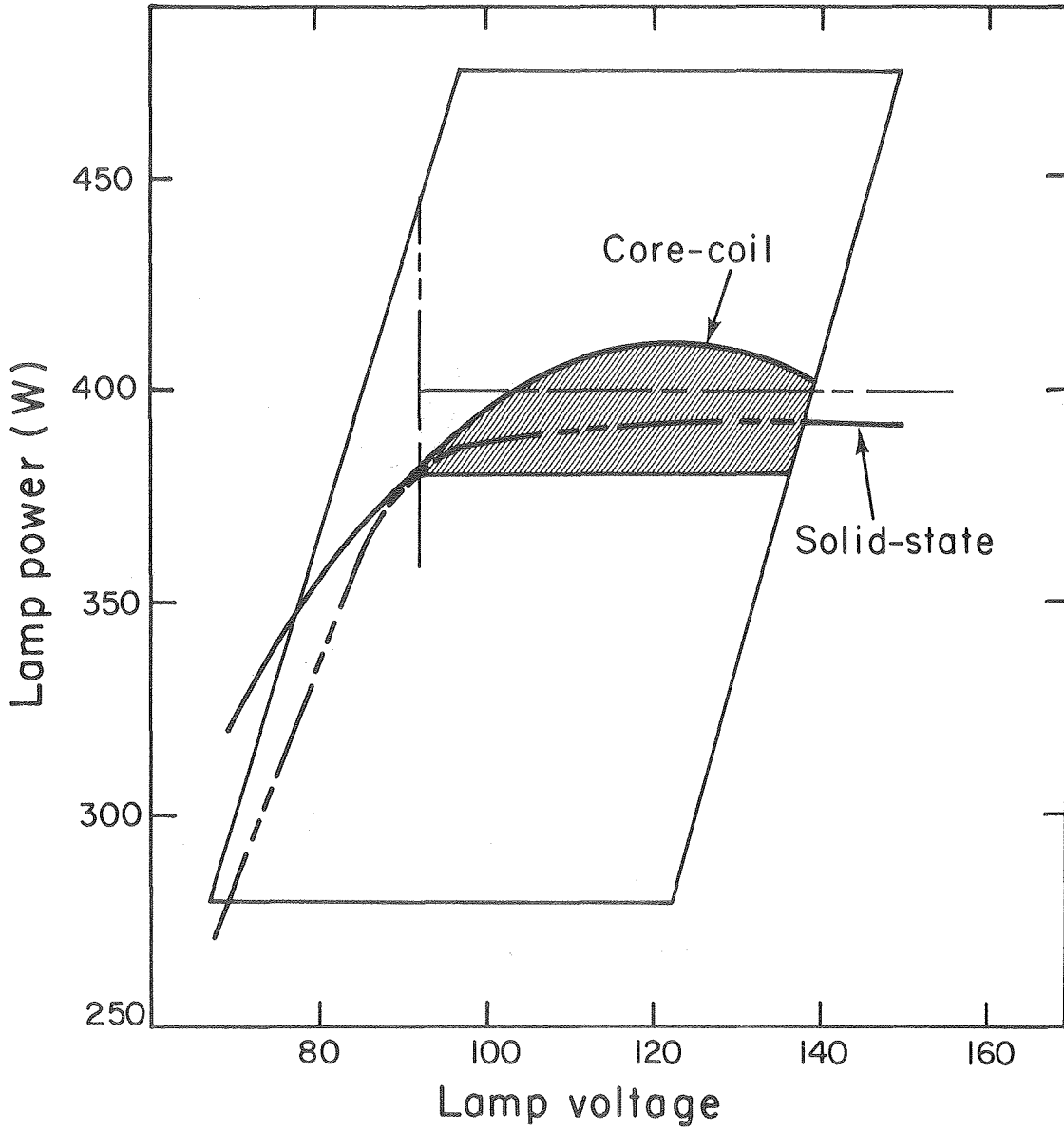

XBL 813-559

FIGURE 3.4