

Lawrence Berkeley National Laboratory

Lawrence Berkeley National Laboratory

Title

THE DOUBLET III NEUTRAL BEAM SOURCE CRYOPANEL SYSTEM

Permalink

<https://escholarship.org/uc/item/2456m07n>

Author

Tanabe, J.

Publication Date

1979-03-01

Presented at the Particle Accelerator
Conference, San Francisco, California,
March 12-14, 1979

LBL-8900 C 2

THE DOUBLET III NEUTRAL BEAM SOURCE CRYOPANEL SYSTEM

RECEIVED
LAWRENCE
BERKELEY LABORATORY

Jack Tanabe, Robert Yamamoto and Peter V. Arend

MAR 23 1979

March 1979

LIBRARY AND
DOCUMENTS SECTION

Prepared for the U. S. Department of Energy
under Contract W-7405-ENG-48

TWO-WEEK LOAN COPY

*This is a Library Circulating Copy
which may be borrowed for two weeks.
For a personal retention copy, call
Tech. Info. Division, Ext. 6782*

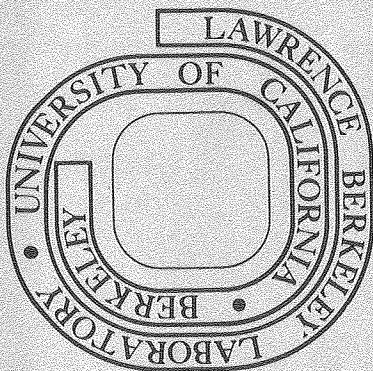

LBL-8900C-2

LEGAL NOTICE

This report was prepared as an account of work sponsored by the United States Government. Neither the United States nor the Department of Energy, nor any of their employees, nor any of their contractors, subcontractors, or their employees, makes any warranty, express or implied, or assumes any legal liability or responsibility for the accuracy, completeness or usefulness of any information, apparatus, product or process disclosed, or represents that its use would not infringe privately owned rights.

THE DOUBLET III NEUTRAL BEAM SOURCE CRYOPANEL SYSTEM

Jack Tanabe, Robert Yamamoto*, & Peter Vander Arend**

Summary

A cryogenic pumping system is designed to provide 1.4×10^6 l/sec. of hydrogen pumping speed for the Doublet III neutral beam ion source. The cryopump is made up of two elements; a cylindrical unit which uses a "Santeler" type of liquid nitrogen shield and a flat chevron shielded disk. Liquid helium and liquid nitrogen are circulated by forced flow. The liquid helium is circulated at 0.6 atm absolute pressure for cryopump operation at 3.8°K.

Introduction

The design of the neutral beam ion source for the Doublet III Tokamak was undertaken by LBL in collaboration with General Atomic in the Spring of 1977. Its minimum specifications were to provide a half second pulse of 80 amp neutral beam at 80 KeV equivalent H^+ energy.¹ Vacuum requirements were specified to provide minimum beam losses due to reionization. This was accomplished by design of large liquid helium cooled, liquid nitrogen shielded cryopump arrays, located and baffled in such a manner that the neutral beam source is differentially pumped. The differential pumping isolates the source from the Tokamak as well as minimizing beam reionization.² Construction of the cryopanel is 90% complete. This paper reports on the design and fabrication of the cryopanel and its refrigerant distribution system.

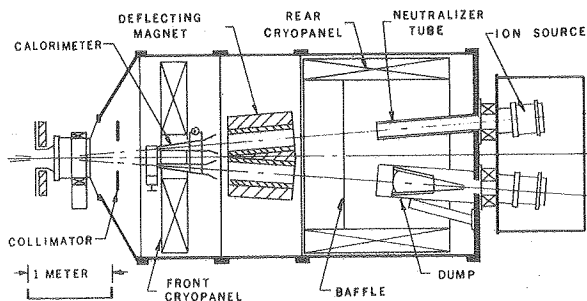

Figure 1: Doublet III Neutral Beam Source

Design Objectives and Constraints

The peak hydrogen gas load for the ion source system is ~92 torr-liters/sec. Approximately 65% of the gas load is directly from the source, 30% is from the beam dump, and 5% is from the deflecting magnet and the collimator. The distribution of the cryopump array and the baffles provide a pressure distribution which ranges from 1×10^{-4} torr. at the neutralizer exit to 9×10^{-6} torr. at the source isolation valve at the entrance to the Tokamak. The anticipated pressure distribution represents a 3% beam loss.

Beam diagnostics, water and power feeds and magnetic shield supports required numerous penetrations thru the rear cylindrical cryopanel. A disk shape for the front cryopanel provided pressure gradient due to baffling as well as supplying pumping capability on two sides.

* University of California, Lawrence Berkeley Laboratory, 1 Cyclotron Road, Berkeley, CA 94720.
 ** Cryogenic Consultants, Inc., 1128 N. Graham St., Allentown, PA 18103.

Operational constraints included the requirement for reasonably fast warmup for frequent reconditioning of the pump. Also, the pump must be capable of withstanding overpressure in case of an up to air accident.

Flow System

A forced flow liquid helium and liquid nitrogen flow system was selected.

Large flow cross-sections and generous fluid inventory are required for a free convective flow system. The thermal inertia of a system with a large fluid inventory makes thermal cycling of such a system clumsy. Over-pressure protection requires a heavier structure due to the large flow cross-sections and a generously sized relief valve for the fluid inventory.

A forced flow system, on the other hand, is a tubular system. The inherent mechanical flexibility of the tube can be taken advantage of to solve problems associated with thermal expansion and mechanical fit up. The design has no bellows in the flow circuit and thus is not pressure limited by bellows design.

Flow pressure drops are computed using the Martinelli-Nelson two phase flow correlations. Operating temperatures due to the saturation properties of the fluids are not excessive. A Baker diagram approach is used to assess flow stability.

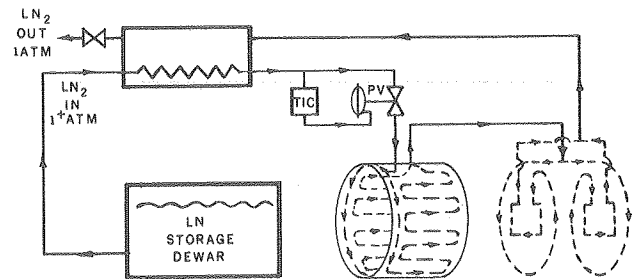

Figure 2: Liquid Nitrogen Flow System

Helium and nitrogen flow is similar. A heat exchanger is added to the circuit to super cool the incoming fluid. The helium circuit includes a remote dewar to provide sufficient volume for continuous operation in case of refrigeration failure. Down-stream flow occurs thru the flat cryopanel so that lowest temperature (and thus lowest hydrogen vapor pressure) occurs in the area where differential pumping will create the best isolation of the source from the Tokamak.

Basic Parameters

	Front Cryopanel	Rear Cryopanel
Helium Mass Flow Rate	3 g/sec.	3 g/sec.
Liquid Nitrogen Mass Flow Rate	60 g/sec.	60 g/sec.
Pressure Drop thru Helium Circuit	.20 psi @ 3.8°K	.35 psi @ 3.8°K
Pressure Drop thru Liquid Nitrogen Circuit	2.95 psi @ 77°K	4.30 psi @ 77°K
Saturated Helium Temp. Change	.010°K	.017°K
Net Capture Probability	0.22	0.19
Hydrogen Pump Speed	5.8×10^5 l/sec.	7.8×10^5 l/sec.
Helium Heat Load	11 Watts	12 Watts

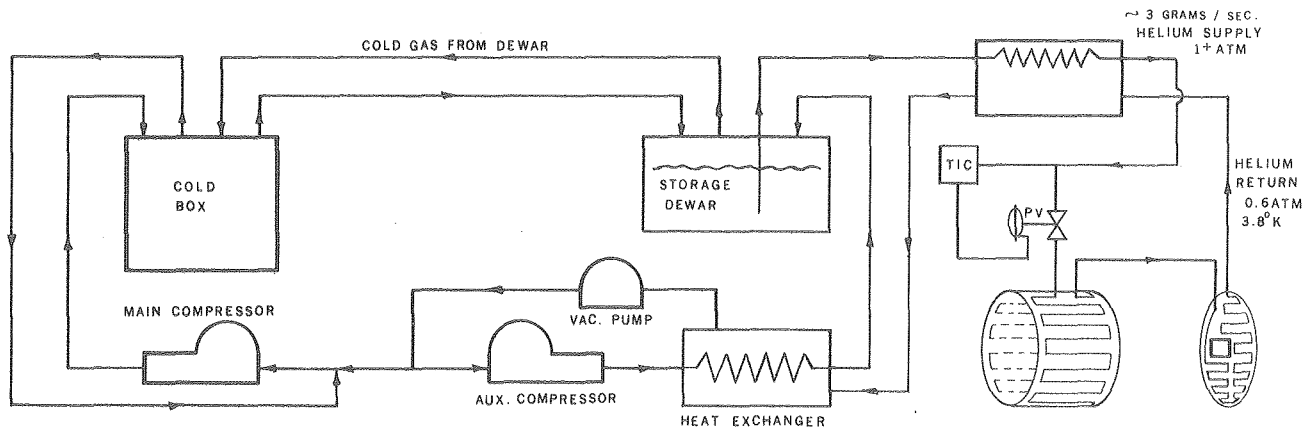

Figure 3: Liquid Helium Flow System

Cryopanel Design

Rear Cryopanel

The rear, cylindrical, cryopanel uses a modified "Santeler" type of liquid nitrogen cooled shield geometry. The LN shield is made from extruded aluminum shapes welded into a cylinder. These extrusions are serrated so as to minimize room temperature reflection to the helium cooled surface. The helium cooled surfaces are copper sheets brazed onto stainless steel tubes. The pumping speed for this geometry was computed using an existing Monte Carlo program.³

Flow paths are tubular and spaced in such a manner that there is ample opportunity for penetrations for beam diagnostic ports and mechanical support for internal components.

Front Cryopanel

The LN cooled chevron disks are aluminum weldments. Liquid nitrogen flows around the outer rings and along the internal frames. The helium cooled copper panels are brazed to stainless steel tubes which carry the liquid helium.

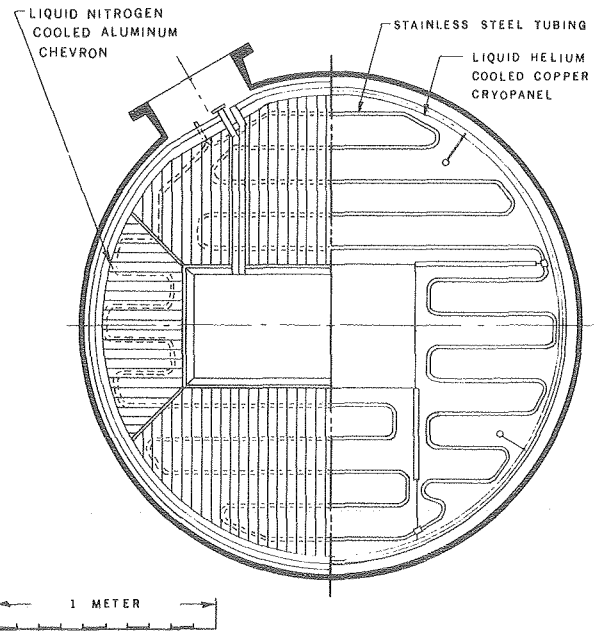

Figure 4: Front Cryopanel

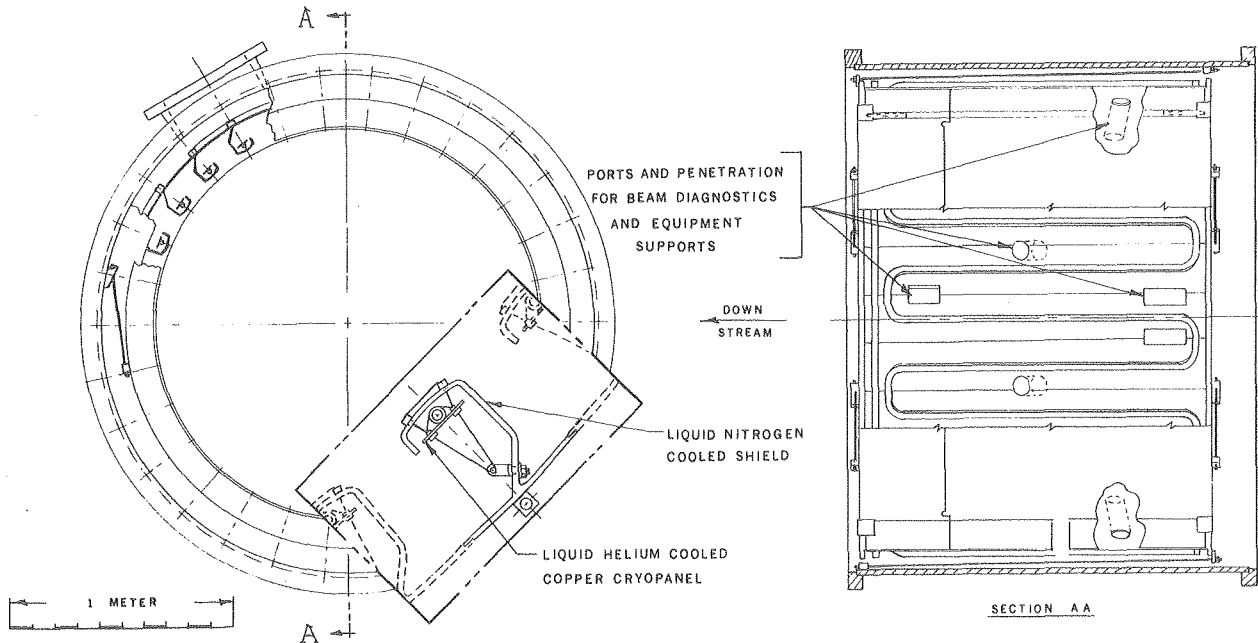

Figure 5: Rear Cryopanel

Conclusions

The cryopanel and flow system design satisfy the scientific specifications for performance. In addition, the forced flow scheme resulted in a design which fits the geometric and operational constraints with a geometry which is simple and easily fabricated.

Acknowledgements

Mike Holland and Tony Colleraine of GA reminded us of the scientific and operational requirements of the device. Klaus Halbach of LBL, Jim Kamperschroer of GA and Alan Cole of TRW provided scientific guidance. Jack Gunn of LBL provided the administrative leadership. We thank all these people for their guidance, and their encouragement. We especially thank Frank Marzorini, Mel Marter and Jim Miller of LBL who designed the hardware.

References

- ¹ Colleraine, A.P. et al., A Parametric Study of the Doublet III Neutral Beam Injection System, presented at the 10th Symposium on Fusion Technology (10th SFT), Sept. 4-9, 1978, Padua, Italy, G.A. Internal Report #GA-A15114.
- ² Kamperschroer, J.H., Colleraine, A.P., and Stewart, L.D., Measured and Predicted Beam Attenuation in Neutral Beam Drift Ducts for Tokamaks, presented at the 10th SFT, Sept. 4-9, 1978, Padua, Italy, G.A. Internal Report #GA-A15085.
- ³ Tanabe, J.T., Bevatron Cryopump System, Monte Carlo Program, LBL Engineering Note #M4338.
- ⁴ Holland, M.M. et al., Doublet III Neutral Beam Injection System Overview and Status Report, presented at the 10th SFT, Sept. 4-9, 1978, Padua, Italy, G.A. Internal Report #GA-A15119.

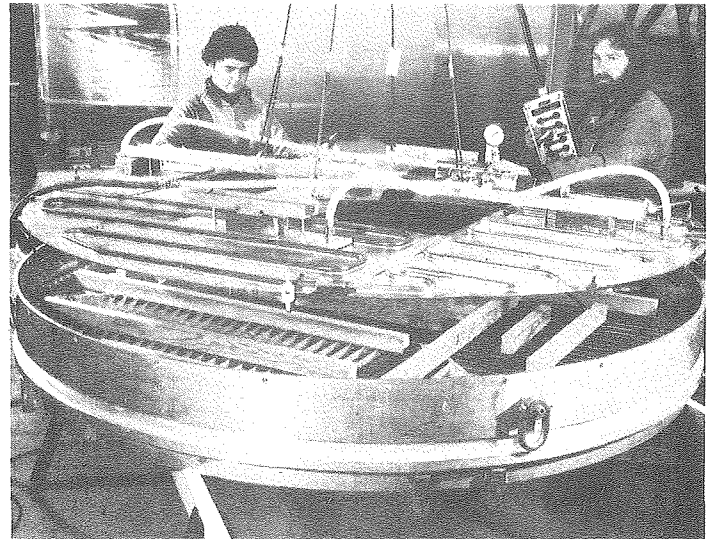

Figure 7: Front Cryopanel Helium Panel Installation

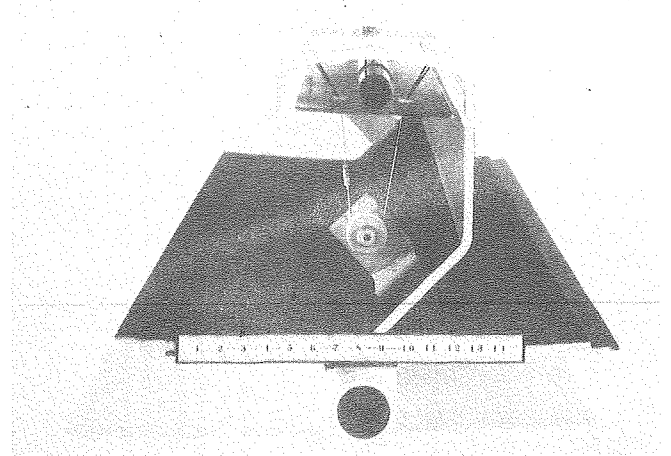

Figure 8: Rear Cryopanel Santeler Geometry

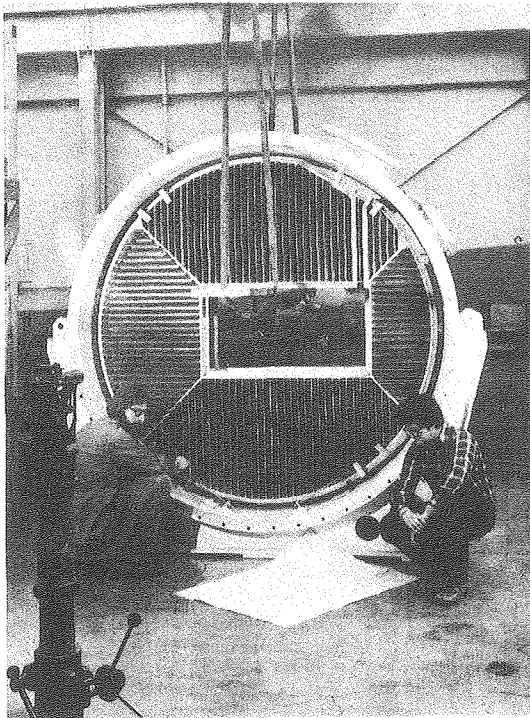

Figure 6: Front Cryopanel Vacuum Tank Installation

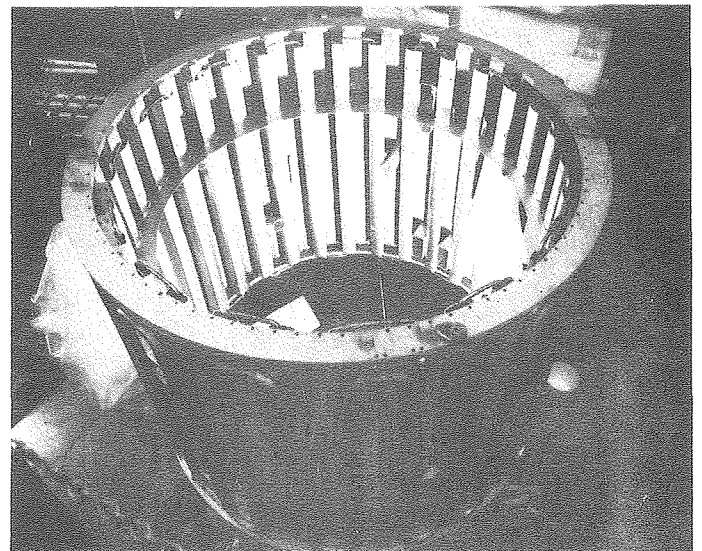

Figure 9: Rear Cryopanel

This report was done with support from the Department of Energy. Any conclusions or opinions expressed in this report represent solely those of the author(s) and not necessarily those of The Regents of the University of California, the Lawrence Berkeley Laboratory or the Department of Energy.

Reference to a company or product name does not imply approval or recommendation of the product by the University of California or the U.S. Department of Energy to the exclusion of others that may be suitable.

TECHNICAL INFORMATION DEPARTMENT
LAWRENCE BERKELEY LABORATORY
UNIVERSITY OF CALIFORNIA
BERKELEY, CALIFORNIA 94720