

UC Berkeley

Indoor Environmental Quality (IEQ)

Title

Natural Ventilation for Energy Savings in California Commercial Buildings

Permalink

<https://escholarship.org/uc/item/4cd386s7>

Authors

Linden, Paul
Banks, David
Daish, Nick
[et al.](#)

Publication Date

2016-06-01

Energy Research and Development Division
FINAL PROJECT REPORT

**NATURAL VENTILATION FOR
ENERGY SAVINGS IN CALIFORNIA
COMMERCIAL BUILDINGS**

Prepared for: California Energy Commission
Prepared by: University of California, San Diego



UC San Diego

JUNE 2016
CEC-500-2016-039

PREPARED BY:

Primary Authors:

Paul Linden Kyle Adams
Nick Daish Sam Brunswick
David Banks Ed Arens

Guilherme Spencer Dutton Fiona Gillan
Carrilho da Graça Robert Gerard Mackenzie Hill
Marc Fountain Phil Haves Tom Lawton
Greg Gross Michael Hovanec Geza Szakats
Anoop Honnekeri Paul Switenki Hui Zhang
Margaret Pigman Yongchao Zhai
Ronnie Thomas Bill Fisk

University of California, San Diego
9500 Gilman Drive
La Jolla, CA 92093
Phone: 858-534-2230
<http://www.ucsd.edu>

Contract Number: 500-10-025

Prepared for:

California Energy Commission

Bradley Meister, PhD, PE
Contract Manager

Virginia Lew
Office Manager
Energy Efficiency Research Office

Laurie ten Hope
Deputy Director
ENERGY RESEARCH AND DEVELOPMENT DIVISION

Robert P. Oglesby
Executive Director

DISCLAIMER

This report was prepared as the result of work sponsored by the California Energy Commission. It does not necessarily represent the views of the Energy Commission, its employees or the State of California. The Energy Commission, the State of California, its employees, contractors and subcontractors make no warranty, express or implied, and assume no legal liability for the information in this report; nor does any party represent that the uses of this information will not infringe upon privately owned rights. This report has not been approved or disapproved by the California Energy Commission nor has the California Energy Commission passed upon the accuracy or adequacy of the information in this report.

ACKNOWLEDGEMENTS

The research team would like to acknowledge the sponsors of this project—the California Energy Commission and its Public Interest Energy Research Program — and in particular, Bradley Meister for his management and support through the course of this project.

Also, we would like to gratefully acknowledge the input from the Technical Advisory Groups during the project (affiliations are those at the time of participation in the project).

Project 1:

Melissa Burton (BMT Fluid Mechanics)
Santosh Philip (Loisos + Ubbelohde)
Thomas Piette (California Department of General Services)
Bob Ramirez (Itron)
Erik Ring (LPA)
Phil Williams (Webcor Builders)

Project 2:

Kazukiyo Kumagai (California Department of Public Health)
Daniel Nall (Flack + Kurtz)
Bud Offermann (Indoor Environmental Engineering)
Gwelen Paliaga (Taylor Engineering)
Abhijeet Pande (Heschong Mahone Group)
Peter Rumsey (Integral Group)

Project 3:

Bert Blocken (Technische Universiteit Eindhoven)
Panagiota Karava (Purdue University)
Les Norford (MIT)

The research team also gratefully acknowledges the participation of the Project Advisory Committee:

Jerine Ahmed (Southern California Edison)
Martha Brook (California Energy Commission)
Kathleen Cruise (US General Services Administration)
Deborah Gold (Cal/OSHA)
Teresa Kaneko (California Department of General Services)
Robert Marcial (Pacific Gas and Electric)
Gwelen Paliaga (Taylor Engineering).

The researchers are grateful to the occupants of the case study building (Loisos + Ubbelohde Architecture and Energy, Alameda, California) who patiently answered the surveys for one year. The researchers are grateful for Matt Crandall (DPR Construction) and Ed Clark (ZGF Architects LLP), who arranged two study buildings (DPR office in Phoenix, Arizona, and

University of Washington- Molecular Biology Laboratory in Seattle, Washington) in which they conducted CBE general satisfaction surveys.

PREFACE

The California Energy Commission Energy Research and Development Division supports public interest energy research and development that will help improve the quality of life in California by bringing environmentally safe, affordable, and reliable energy services and products to the marketplace.

The Energy Research and Development Division conducts public interest research, development, and demonstration (RD&D) projects to benefit California.

The Energy Research and Development Division strives to conduct the most promising public interest energy research by partnering with RD&D entities, including individuals, businesses, utilities, and public or private research institutions.

Energy Research and Development Division funding efforts are focused on the following RD&D program areas:

- Buildings End-Use Energy Efficiency
- Energy Innovations Small Grants
- Energy-Related Environmental Research
- Energy Systems Integration
- Environmentally Preferred Advanced Generation
- Industrial/Agricultural/Water End-Use Energy Efficiency
- Renewable Energy Technologies
- Transportation

Natural Ventilation For Energy Savings In California Commercial Buildings is the final report for the Natural Ventilation for Energy Savings in California Commercial Buildings project (contract number 500-10-025) conducted by University of California, San Diego. The information from this project contributes to Energy Research and Development Division's Buildings End-Use Energy Efficiency Program.

When the source of a table, figure or photo is not otherwise credited, it is the work of the author of the report.

For more information about the Energy Research and Development Division, please visit the Energy Commission's website at www.energy.ca.gov/research/ or contact the Energy Commission at 916-327-1551.

ABSTRACT

Researchers investigated both benefits and barriers to retrofitting California commercial buildings with natural or mixed-mode ventilation for cooling. They analyzed building location, acoustics, acceptability by occupants, and safety and regulatory issues such as smoke control and projected energy use. They also greatly extended the capabilities for modeling and design of naturally ventilated and mixed-mode buildings in California.

The research indicates that retrofitting natural or mixed-mode ventilation into California buildings will provide both significant energy savings and improved occupant indoor environmental satisfaction. Sick building syndrome may also be reduced, but caution is needed where exposure to excessive particulate matter or ozone may increase the risk of long-term health problems. Windows should be closed during hours of high temperature and air pollution. Where these are persistent conditions, mixed-mode or contaminant removal can be beneficial. Ingress of outdoor noise should also be considered, although surveys indicate enhanced occupant satisfaction in naturally ventilated buildings even with higher levels of noise.

The simplest and most cost-effective retrofit for older buildings is often to install operable windows. To address the technical issues involving ventilation with windows, the research team focused on wind-driven ventilation. Stack-driven ventilation is also likely to be present, and usually improves the cooling potential. The range of acceptable indoor temperatures can be greatly extended through the use of occupant-controlled fans.

The research comprised three major projects. Project 1 assessed the potential and barriers to using natural ventilation, including fire and smoke control and acoustics. Project 2 examined induced air movement, occupant satisfaction over the range of expected conditions and the issues of outdoor pollutants. Project 3 produced new computer tools for predicting the performance of naturally ventilated buildings based on extensive wind tunnel testing, integrated those tools into the energy simulation tool EnergyPlus, and provided training in their use.

Keywords: natural ventilation, mixed-mode ventilation, hybrid ventilation, retrofit, commercial buildings, EnergyPlus, energy simulation, building energy, energy efficiency, energy savings, thermal comfort, indoor air quality, computational fluid dynamics, CFD

Please use the following citation for this report:

Linden, Paul; Ed Arens; Nick Daish. (UC San Diego). 2015. *Natural Ventilation for Energy Savings in California Commercial Buildings*. California Energy Commission.
Publication Number: CEC-500-2016-039.

TABLE OF CONTENTS

Acknowledgements	i
PREFACE	iii
ABSTRACT	iv
TABLE OF CONTENTS.....	v
LIST OF FIGURES.....	xii
LIST OF TABLES	xxiii
EXECUTIVE SUMMARY	1
Introduction	1
Research Purpose	1
Project Results.....	2
Project Benefits	5
CHAPTER 1: Research Summary.....	6
1.1 Project 1: - Barriers and Technical Potential.....	6
1.1.1 Introduction and Background for Project 1.....	6
1.1.2 Methods for Project 1.....	7
1.1.3 Results for Project 1.....	8
1.1.4 Conclusions for Project 1.....	10
1.2 Project 2 – Indoor Environmental Quality.....	11
1.2.1 Project 2a – Thermal Comfort in Offices with Elevated Air Movement	12
1.2.2 Project 2b – Ozone and Particle Exposures in Naturally Ventilated Offices	14
1.3 Project 3 – Model Development.....	16
1.3.1 Introduction and Background for Project 3.....	16
1.3.2 Methods for Project 3.....	17
1.3.3 Results for Project 3.....	17
1.3.4 Conclusions for Project 3.....	20
CHAPTER 2: Barriers and Technical Potential	22
2.1 Knowledge Review	22

2.1.1	Introduction	23
2.1.2	Literature Review.....	23
2.1.3	Interviews/Natural Ventilation by Region	32
2.1.4	Code Requirements/Design Standards	34
2.1.5	Available Tools.....	38
2.1.6	Leading Research	45
2.1.7	Barriers.....	48
2.1.8	Summary	52
2.2	Characterization of Existing Buildings in California for Natural Ventilation Suitability 52	
2.2.1	Introduction and Background	52
2.2.2	Methods.....	53
2.2.3	Results.....	54
2.2.4	Conclusions.....	74
2.3	Modeling With EnergyPlus to Assess Building Energy Consumption and Demand Reduction Potential.....	74
2.3.1	Introduction	74
2.3.2	Development of Baseline Building Models	74
2.3.3	Development of Retrofit Building Models	82
2.3.4	Natural Ventilation Modeling.....	84
2.3.5	Estimating Statewide Energy Savings from Building Models.....	86
2.3.6	Energy Consumption Results.....	86
2.3.7	Energy Consumption Discussion	93
2.3.8	Construction Cost Estimation	93
2.3.9	Cost Benefit Analysis.....	96
2.3.10	Cost Benefit Discussion.....	100
2.3.11	Recommendations.....	100
2.3.12	Appendix: Detailed Weighting Method	100
2.4	Implementation and Barriers to Implementation.....	107

2.4.1	Introduction and Background	107
2.4.2	Methods	109
2.4.3	Results	116
2.4.4	Conclusions	147
CHAPTER 3: Thermal Comfort in Offices With Elevated Air Movement.....		157
3.1	Introduction	157
3.2	Literature review	158
3.2.1	Comfort in Naturally Ventilated Buildings.....	158
3.2.2	Adaptive Action in Office Buildings	159
3.2.3	Air Quality	160
3.3	Description of NV Test Building.....	160
3.4	Physical Measurements and Occupant Satisfaction Survey	162
3.4.1	Outdoor Data Monitoring.....	162
3.4.2	Indoor Environment Monitoring.....	162
3.4.3	Occupant Survey	163
3.5	Results.....	163
3.5.1	Outdoor and Indoor Air Temperature Analysis	163
3.5.2	Wind analysis	166
3.5.3	Clothing	167
3.5.4	Windows	168
3.5.5	Fans	172
3.5.6	Interactions Between Windows and Fans.....	174
3.5.7	Heaters.....	174
3.5.8	CO2 Measurement and Perceived Air Quality	178
3.5.9	Thermal Sensation and Comfort.....	180
3.5.10	Background Surveys in Other Offices with Operable Windows and Ceiling Fans 192	
3.6	Conclusion and Future Work.....	202
Chapter 3 Appendix: Right Now Survey.....		204

CHAPTER 4: Ozone and Particle Exposures in Naturally Ventilated Offices	206
4.1 Background.....	206
4.2 Methods.....	207
4.2.1 Basic Approach.....	207
4.2.2 Field Study Methods.....	208
4.2.3 Data Analysis Methods.....	209
4.2.4 Calculation of Effects of Retrofits in California’s Offices.....	211
4.2.5 Calculation Methods for Sick Building Syndrome Symptoms.....	212
4.3 Results.....	213
4.3.1 Reference Model for Conventional Offices.....	213
4.3.2 Results of Case Studies in Naturally Ventilated Offices.....	214
4.3.3 Results of Exposure and Health Risk Calculations.....	216
4.3.4 Changes in Sick Building Syndrome Symptoms.....	220
4.3.5 Analysis of Mitigation Options.....	220
4.4 Discussion.....	221
4.5 Conclusions.....	223
CHAPTER 5: Model Development	224
5.1 Introduction.....	224
5.1 Wind Tunnel Tests.....	228
5.1.1 Introduction and Background.....	228
5.1.2 Methods.....	228
5.1.3 Results.....	232
5.1.4 Conclusions.....	263
5.2 CFD simulations and Algorithm Development.....	263
5.2.1 Cross-Ventilation.....	264
5.2.2 Single-Sided Ventilation with 1 Aperture (SS1).....	292
5.2.3 Single-Sided Ventilation With 2 or More Apertures.....	300
5.2.4 Corner Ventilation Model.....	321

5.2.5	Comparison of Ventilation Regimes for 2 Openings	330
5.2.6	Conclusions.....	335
5.3	EnergyPlus Implementation and EnergyPlus Training.....	336
5.3.1	EnergyPlus Implementation.....	336
5.3.2	EnergyPlus Training.....	340
5.4	Conclusions for Project 3.....	345
GLOSSARY		348
REFERENCES		352
APPENDIX A: Barriers to Implementation: Acoustics		1
A.1	Scope	A-1
A.2	Legacy Criteria	A-2
A.3	Revised Criteria for External Noise Break-In.....	A-4
A.3.1	Hypothesis	A-4
A.3.2	Research.....	A-4
A.3.3	Summary of Research.....	A-11
A.3.4	Further Considerations	A-11
A.4	Measurements	A-13
A.4.1	Aims.....	A-13
A.4.2	Buildings and Measurements.....	A-13
A.4.3	Results.....	A-15
A.4.4	Post Occupancy Survey Results.....	A-17
A.5	Noise Environments and Feasibility of Natural Ventilation	A-18
A.5.1	Natural Ventilation.....	A-18
A.5.2	Methodology for Feasibility Assessment.....	A-19
A.5.3	Types of Natural Ventilation Openings.....	A-20
A.5.4	Comparison for Feasibility Assessment.....	A-22
A.6	Other Acoustic Issues	A-23
A.7	Noise Control Products for Natural Ventilation Openings	A-24

A.7.1	Products.....	A-24
A.7.2	Acoustic Performance.....	A-28
A.7.3	Airflow Performance	A-29
A.8	Conclusions.....	A-30
A.9	Directions for Further Work.....	A-32
A.11	Acoustic Terminology	A-33
A.12	Measurements.....	A-36
Appendix A References		A-41
APPENDIX B: Barriers to Implementation: Fire		B-1
B.1	Project Summary	B-1
B.1.1	Tasks	B-2
B.1.2	Deliverables.....	B-2
B.2	Background Studies.....	B-2
B.3	Code Review	B-3
B.3.1	Approach.....	B-3
B.3.2	Barriers to Natural Ventilation in New Buildings.....	B-4
B.3.3	Barriers to Natural Ventilation in Existing Buildings.....	B-6
B.4	Case Studies	B-6
B.4.1	Model Assumptions.....	B-6
B.4.2	Software Overview	B-13
B.4.3	Occupant Egress.....	B-20
B.4.4	Smoke Control System	B-22
B.4.5	Sensors and Slice Files	B-23
B.4.6	Wind Effects.....	B-25
B.5	Atria Results.....	B-27
B.5.1	15m.....	B-27
B.5.2	30m.....	B-27
B.6	High Rise Results.....	B-29

B.7 Conclusions	B-32
B.7.1 Code Modifications – New Buildings	B-32
B.7.2 Code Modifications – Retrofit of Existing Buildings.....	B-32
B.7.3 Modeled Case Studies	B-33
Appendix B References.....	B-34
APPENDIX C: Natural Ventilation Design Guidelines	C-1
C.1 Introduction	C-1
C.1.1 Fundamentals	C-1
C.1.2 Mixed Mode Systems	C-7
C.1.3 California Specificity.....	C-9
C.2 Site Considerations and Planning.....	C-9
C.2.1 Climate.....	C-9
C.2.2 Wind.....	C-12
C.2.3 Local Topography and Microclimates	C-12
C.2.4 Odors and Pollutants.....	C-13
C.2.5 Building Massing	C-14
C.2.6 Building Orientation.....	C-15
C.2.7 Climate Change	C-15
C.3 Envelope and Loads	C-16
C.3.1 Building Envelope.....	C-16
C.3.2 Internal Heat Gains.....	C-17
C.3.3 Openings	C-18
C.4 Analysis and Available Tools.....	C-18
C.4.1 Analysis	C-19
C.4.2 Feasibility Assessment Tools.....	C-20
C.4.3 Design & Analysis Tools	C-22
C.4.4 Whole Building Energy Simulation Tools	C-25
C.5 Barriers to Implementation.....	C-27

C.5.1	Climate.....	C-27
C.5.2	Cost.....	C-28
C.5.3	Industry Inefficiencies, Low Fees, Silos and Design Risk	C-28
C.5.4	Aesthetics and Solar Gains	C-29
C.5.5	Comfort Expectations	C-29
C.5.6	Codes, Standards and Authorities Having Jurisdiction.....	C-30
C.5.7	Building Function.....	C-33
C.5.8	Complicated Analysis.....	C-33
C.5.9	Maintenance, Controls, and Operation.....	C-34
C.5.10	Product Availability.....	C-34
C.6	Selecting NV Strategies and Opening Locations.....	C-34
C.6.1	Selecting the Appropriate NV Strategy	C-35
C.6.2	Comparison of Airflow Rates For Different NV Strategies.....	C-37
C.6.3	Urban Versus Suburban Wind Environment.....	C-39
C.6.4	Size and Position of Ventilation Openings.....	C-39
C.7	Other Resources	C-42
C.7.1	CIBSE Application Manuals	C-42
C.7.2	BSRIA Documents.....	C-42
C.7.3	Leading Research	C-43
Appendix C references.....		C-46

LIST OF FIGURES

Figure 2.1: Wind Direction and Strength in Sacramento.....	55
Figure 2.2: Wind Direction and Strength in Sacramento During Warmer Times of Day	56
Figure 2.3: Extended Periods of Calm Winds in Sacramento	57
Figure 2.4: Building A, From Wind Tunnel Test Series 1	58
Figure 2.5: Plan (top) View of Central Bay Showing Window Locations.	58

Figure 2.6: Ventilation Rate vs. Wind Direction. Windows are Open as Indicated in the Legend	59
Figure 2.7: Ventilation Rate for Building A, from Wind Tunnel Test Series 1	61
Figure 2.8: Ventilation Rate for Building A, From Wind Tunnel Test Series 1	62
Figure 2.9: Image of Sacramento from GIS Database, Building Heights are Shown in Feet.....	63
Figure 2.10: Sacramento Transect in Google Earth (Partial)	65
Figure 2.11: Annual Energy Use by Building Type.....	67
Figure 2.12: Cumulative Percentage Plots Showing Lighting and Equipment Power Densities for California Office Buildings.....	68
Figure 2.13: Cumulative Frequency Distribution of Floor Plate Depths for California Office Buildings (N = 628).....	69
Figure 2.14: Map of the California Building Climate Zones	70
Figure 2.15: Estimated Annual Electricity Use by Title 24 Climate Zone for California Buildings	71
Figure 2.16: Estimated Annual Electricity Use of California Office Buildings by Climate Zone .	71
Figure 2.17: Annual Energy Use by Vintage	72
Figure 2.18: Percentage of Buildings With and Without Mechanical Cooling and Ventilation ...	73
Figure 2.19: Percentage of Windows Listed as Operable vs. Fixed by Building Type.....	73
Figure 2.20: Statewide Electricity Use of California Commercial Buildings by Building Type....	75
Figure 2.21: Small, Medium, and Large Office Building Models.....	78
Figure 2.22: Zone Configuration and Dimensions of the Small, Medium, and Large Office Energy Models.....	78
Figure 2.23: Energy End-Use Breakdown for Large Offices	81
Figure 2.24: Energy End-Use Breakdown for Medium Offices	81
Figure 2.25: Energy End Use Breakdown for Small Offices.....	82
Figure 2.26: Modulation of the Window Opening Area Based on Indoor-Outdoor Temperature Difference	85
Figure 2.27: Schematic Elevation of the Office Building Model With Window Geometry and Wind Pressure Nodes.....	86
Figure 2.28: Breakdowns of HVAC EUIs by Scenario for the Large Office	87
Figure 2.29: Breakdowns of HVAC EUIs by Scenario for the Medium Office.....	87

Figure 2.30: Breakdowns of HVAC EUIs by Scenario for the Small Office	88
Figure 2.31: Breakdowns by Scenario of the State-Wide Site HVAC Energy Consumption (Left) and Carbon Emissions (Right) for the Large, Medium and Small Offices.....	88
Figure 2.32: Breakdowns of HVAC EUIs by Climate Zone and Scenario.....	89
Figure 2.33: Breakdowns of Whole Building EUIs by Scenario for the Large Office	90
Figure 2.34: Breakdowns of Whole Building EUIs by Scenario for the Medium Office	90
Figure 2.35: Breakdowns of Whole Building EUIs by Scenario for the Small Office	91
Figure 2.36: State-Wide Electricity Costs by Climate Zone and Scenario for the Large, Medium and Small Offices	91
Figure 2.37: State-Wide Electricity Costs Savings by Climate Zone and Scenario for the Large, Medium and Small Offices	92
Figure 2.38: State-Wide Energy Cost Savings by Scenario for the Large, Medium and Small Offices (Left) and for all Applicable Building Types (Right).....	92
Figure 2.39: State-Wide Return on Investment by Vintage for the Large, Medium and Small Offices for Scenario B2.....	97
Figure 2.40: State-Wide Return on Investment by Vintage for the Large, Medium and Small Offices for Scenario NV1.....	98
Figure 2.41: State-Wide Return on Investment by Vintage for the Large, Medium and Small Offices for Scenario NV2.....	99
Figure 2.42: State-Wide Return on Investment by Climate Zone and Scenario for the Large, Medium and Small Offices	99
Figure 2.43: CEUS to U.S. DOE Building Mapping.....	101
Figure 2.44: Estimated Electricity Use by Title-Twenty Four Climate Zone and Office Size.....	102
Figure 2.45: 15m, 30m, and 45m Tall Mall/Atrium Models	110
Figure 2.46: High-Rise Model.....	110
Figure 2.47: Method for Estimating Increased Health Cases Due to Ozone and PM2.5 Exposure	112
Figure 2.48: Soot Density (Visibility) in 15 m Tall, Naturally Ventilated Atrium/Mall, t = 400s	119
Figure 2.49: Soot Density (Visibility) in 30 m Tall, Naturally Ventilated Atrium/Mall, t = 400s	119
Figure 2.50: Soot Density (visibility) in High-Rise Model, t = 400s.....	120
Figure 2.51: Soot Density (Visibility) in High-Rise Model with 28.3 mph Wind, t = 1200s.....	121

Figure 2.52: Soot Density (Visibility) in High-Rise Model Fire Floor	121
Figure 2.53: Velocity Profile on Leeward Side of High-Rise Model With 28.3mph Wind	122
Figure 2.54: Articulation Index Versus Communication Distance	127
Figure 2.55: Volume Flow Rate/Overall Cross Section Area Verses Pressure Drop	134
Figure 2.56: Building EUI Associated With Cooling Demand (Upper) and Heating Demand (Lower)	135
Figure 2.57: Variation of Building Carbon Emissions With Average Temperature	136
Figure 2.58: Future Projections of Potential for NV in San Francisco.....	137
Figure 2.59: Future Projections of Temperature in San Francisco.....	138
Figure 2.60: General Building Satisfaction for Naturally Ventilated Buildings, Mixed-Mode Buildings and CBE Database.....	141
Figure 2.61: Thermal Comfort for Naturally Ventilated Buildings, Mixed-Mode Buildings and CBE Database.....	141
Figure 2.62: Air quality for Naturally Ventilated Buildings, Mixed-Mode Buildings and CBE Database	142
Figure 2.63: Acoustic Quality for Naturally Ventilated Buildings, Mixed-Mode Buildings and CBE Database.....	142
Figure 2.64: Average Scale Score by Category for Naturally Ventilated Buildings, Mixed-Mode Buildings and CBE Database	143
Figure 2.65: Map of Natural Ventilation and its Connections.....	144
Figure 2.66: Natural Ventilation: Implemented Versus Used: Qualitative Analysis.....	151
Figure 3.1: ASHRAE Standard 55, Elevated Air Movement for Thermal Comfort.....	159
Figure 3.2: Photos and Drawings of Case Study Building.....	161
Figure 3.3: Window Opening Percentages	163
Figure 3.4: Seasonal Temperature Distributions.....	164
Figure 3.5: Annual Temperature Patterns	165
Figure 3.6: Indoor-Outdoor Temperature Comparison.....	166
Figure 3.7: Hourly Wind Speed.....	167
Figure 3.8: Annual Wind Rose	167
Figure 3.9: Monthly Clothing Patterns.....	168

Figure 3.10: Window Positions and Labeling	169
Figure 3.11: Window Opening by Month.....	169
Figure 3.12: Window Daily Adjustment Patterns.....	170
Figure 3.13: Window Opening Frequency.....	170
Figure 3.14: Indoor Temperature When Windows are Adjusted.....	171
Figure 3.15: Windows Open vs. Indoor and Outdoor Temperature	172
Figure 3.16: Fan Position and Labeling.....	172
Figure 3.17: Fan Use by Month	173
Figure 3.18: Fan Daily Adjustment Patterns	173
Figure 3.19: Fan Usage Frequency by Season	173
Figure 3.20: Number of Fans On.....	173
Figure 3.21: Fans on vs. Indoor and Outdoor Temperature	174
Figure 3.22 Combinations of Windows and Fans vs. Temperature.....	174
Figure 3.23: Heater Positions and Labeling.....	175
Figure 3.24: Heater Use by Month	175
Figure 3.25: Heater Daily Adjustment Patterns.....	175
Figure 3.26: Heater Usage Frequency.....	176
Figure 3.27: Temperature When Adjusted	176
Figure 3.28: Number of Heaters on	176
Figure 3.29: Temperature and Number of Heaters on.....	177
Figure 3.30: Window, Fan, Heater Usage Durations	178
Figure 3.31: Monthly CO ₂ Concentrations.....	179
Figure 3.32: PAQ vs. Air Movement Satisfaction.....	180
Figure 3.33: Thermal Sensation vs. Indoor Temperature	181
Figure 3.34: Percentage of Occupants Satisfied	182
Figure 3.35: Thermal Sensation and Thermal Acceptability	184
Figure 3.36: Thermal Sensation and Percent of People Dissatisfied	185
Figure 3.37: Adaptive Comfort Overlay	186

Figure 3.38: Thermal Satisfaction in ASHRAE 55 Adaptive Zones	186
Figure 3.39: Thermal Acceptability and Binned Temperatures.....	187
Figure 3.40: Satisfaction and the Adaptive Comfort Zone	188
Figure 3.41: ASHRAE 55 Adaptive Comfort Chart.....	189
Figure 3.42: Thermal Sensitivities	191
Figure 3.43: Sensitivity-Based Adaptive Chart.....	192
Figure 3.44: Sensitivity-Based vs. ASHRAE Adaptive Comfort Zones.....	192
Figure 3.45: DPR Net Zero Building, Phoenix	193
Figure 3.46: Temperature Satisfaction Percentile Ranking, DPR	194
Figure 3.47: Satisfaction with Temperature, DPR.....	194
Figure 3.48: Satisfaction Temperature Control, DPR	194
Figure 3.49: Reasons for Dissatisfaction with Fans, DPR	195
Figure 3.50: Reasons for Dissatisfaction with Acoustics, DPR	196
Figure 3.51: University of Washington Building and Natural Ventilation Strategies.....	197
Figure 3.52: Temperature Satisfaction Percentile Ranking, UW	198
Figure 3.53: Reasons for Temperature Dissatisfaction, UW.....	199
Figure 3.54: Satisfaction With Temperature, UW	199
Figure 3.55: Satisfaction Temperature Control, UW	199
Figure 3.56: Access to Environmental Controls, UW	200
Figure 3.57: Reasons for Dissatisfaction with Ceiling Fans, UW.....	201
Figure 3.58: Reasons for Dissatisfaction With Acoustics, UW	202
Figure 4.2: Total CA Cases of Health Outcomes Related to Changes In PM 2.5 Exposure	216
Figure 4.3: Total CA Cases of Health Outcomes RelatedtTo Changes In Ozone Exposure	216
Figure 4.4: Total CA Costs of Health Outcomes Related to Changes in PM 2.5 Exposure.....	217
Figure 4.5: Total CA Costs of Health Outcomes Related to Changes in Ozone Exposure	217
Figure 4.6: Annual Costs per 10,000 Workers in Millions of U.S. Dollars for Each Title-24 Climate Zone Under Scenario A	219
Figure 4.7: Annual Costs per 10,000 Workers In Millions of U.S. Dollars for Each Title-24 Climate Zone Under Scenario B.....	219

Figure 4.8: Ozone-Related Incremental Costs By Strategy.....	221
Figure 4.9: PM2.5-Related Incremental Costs By Strategy	221
Figure 5.1: Sketch of Wind-Driven Natural Ventilation Problem.....	225
Figure 5.2: Three Flow Regimes for Wind-Driven Ventilation.....	226
Figure 5.3: CPP Closed Circuit Wind Tunnel 1.....	229
Figure 5.4: Fast Flame Ionization Detector Head	230
Figure 5.5: Hot-Film Orientation	231
Figure 5.6: Measurement Instrumentation Beneath Test Building	232
Figure 5.7: 2-Story Building Shape	234
Figure 5.8: 2-Story Corner Building Shape.....	234
Figure 5.9: 2-Story Fin Building Shape.....	235
Figure 5.10: 4-Story Bottom Window Level Building Shape	235
Figure 5.11: 4-Story Top Window Level Building Shape	236
Figure 5.12: Test Building Layout Pressure Tap Locations.....	237
Figure 5.13: Test Building Layout With Internal Pressure Tap Locations	238
Figure 5.14: Test Building Layout With Velocity Measurement, FFID Receptor, and Window Locations	239
Figure 5.15: 2-Story Building Shape With 2-Story Surrounding Model and 10in Road Width Turntable Layout.....	245
Figure 5.16: 2-Story Building Shape With 4-Story Surrounding Model and 10in Road Width Turntable Layout.....	246
Figure 5.17: 2-Story Building Shape With 2-Story Surrounding Model and 20in Road Width Turntable Layout.....	247
Figure 5.18: 2-Story Building Shape With 4-Story Surrounding Model and 20in Road Width Turntable Layout.....	248
Figure 5.19: 4-Story Top Window Level Building Shape With 2-Story Surrounding Model And 10in Road Width Turntable Layout.....	249
Figure 5.20: 4-Story Top Window Level Building Shape With 4-Story Surrounding Model and 10in Road Width Turntable Layout.....	250
Figure 5.21: 4-Story Top Window Level Building Shape With 2-Story Surrounding Model and 20in Road Width Turntable Layout.....	251

Figure 5.22: 4-Story Top Window Level Building Shape With 4-Story Surrounding Model and 20in Road Width Turntable Layout.....	252
Figure 5.23: 4-Story Bottom Window Level Building Shape With 2-Story Surrounding Model and 10in Road Width Turntable Layout.....	253
Figure 5.24: 4-Story Bottom Window Level Building Shape With 4-Story Surrounding Model and 10in Road Width Turntable Layout.....	254
Figure 5.25: 4-Story Bottom Window Level Building Shape With 2-Story Surrounding Model and 20in Road Width Turntable Layout.....	255
Figure 5.26: 4-Story Bottom Window Level Building Shape With 4-Story Surrounding Model and 20in Road Width Turntable Layout.....	256
Figure 5.27: 2-Story Corner Building Shape Turntable Layout	257
Figure 5.28: Alameda Test Building in Wind Tunnel – December 2011	259
Figure 5.29: Close-Up View of Alameda Test Building – December 2011	259
Figure 5.30: Close-Up View of W1, W2, and D2 on Alameda Test Building – December 2011..	260
Figure 5.31: Close-up View of W3, W4 on Alameda Test Building – December 2011	260
Figure 5.32: Building Shape A – December 2011	261
Figure 5.33: Building Shape B – December 2011.....	262
Figure 5.34: Building Shape C – December 2011	262
Figure 5.35: Top View of a Cross Ventilated Cavity With $A' < 0.5$	265
Figure 5.36: Schematic of the Development of a Jet From Airflow Through a Window	268
Figure 5.37: Comparison Between Measured Velocities in a LDCF and CV Flow	269
Figure 5.38: Time Evolution of the Flow Rate of a Jet Entering an Initially Stagnant Cavity	270
Figure 5.39: Location of Heat Sources in CFD Simulations	276
Figure 5.40: Comparison of CFD simulation of Diffuser Flow With Experimental Data	279
Table 5.12: Percentage Error in X-Velocity Profile Using Different Flow Metrics.....	280
Figure 5.41: Velocity and Temperature Increase at Mid-Room Height for Case 19	281
Figure 5.42: Correlation Results for Jet Velocity, Recirculation Velocity and Recirculation Flow Rate.....	282
Figure 5.43: Schematic Illustration Of Procedure to Model A 2-Aperture Room as A Combination Of 1-Aperture Rooms	285
Figure 5.44: Top View of Room With 2 Inlets and 2 Outlets.....	286

Figure 5.45: Comparison of Flow Parameters for 2-Inlet Room With Corresponding 1-Inlet Rooms	288
Figure 5.46: Schematic of Jet Resulting From Wind at Angle Φ to Façade.	290
Figure 5.47: Jet Velocity Correlation Applied to Non-Zero Wind Angles.....	291
Figure 5.48: Wind Angle Effects on Inlet Velocity.....	292
Figure 5.49: Single-Sided 1-Aperture Set-Up and Notation.....	294
Figure 5.50: Turbulent Shear Layer Exchange Interpretation for SS 1-Aperture Ventilation	295
Figure 5.51: Results of Numerical Simulation of Flow Past a Single Opening.....	296
Figure 5.52: Wind Tunnel Measurement Points for Analysis of Local Velocity U_L	298
Figure 5.53: Local Velocity $U_L/U(z_w)$ as Function of Wind Angle for Wind Tunnel Data Analyzed	299
Figure 5.54: Wind Tunnel Data, Averaged Over All Cases, Plotted With Curve to fit Data	300
Figure 5.55: Single-Sided 2-Aperture Set-Up and Notation.....	303
Figure 5.56: Building/Room Configurations Analyzed. S1:S8 Openings Shaded Red, S3:S6 Shaded Yellow	305
Figure 5.57: Example of Non-Dimensional Flow Rate and Mean and Fluctuating Parts of Pressure Difference for 2-Story Isolated Building.....	306
Figure 5.58: Comparison of Formula and Data for Optimal Coefficient Values.....	308
Figure 5.59: Mean Pressure Profile Along Façade, 2-Story Isolated Building, $\theta = 45^\circ$	310
Figure 5.60: Pressure Difference for 2-Story Isolated Building: (a) Mean and (b) Unsteady Parts	312
Figure 5.61: Linear Approximation to Unsteady Pressure Difference Curves.....	313
Figure 5.62: Example Comparison of Model and Data for Pressure Difference Coefficient.....	314
Figure 5.63: Comparison of Predicted Flow Rates with Experimental Data, Indicating Mean Error for each Scenario	316
Figure 5.64: Pressure Network for 2-Opening Single-Sided Room	317
Figure 5.65: Example of Façade Containing More Than 2 Openings, e.g. 4 Windows Open by Different Amounts.....	319
Figure 5.66: Observed Pressure Distribution Around 2-Story Isolated Building, Wind Angle 22.5°	322
Figure 5.67: Wind Quadrants and Numbers of Windward Openings in CR.....	323

Figure 5.68: Building and Room Geometry for CPP Wind Tunnel CR Tests	324
Figure 5.69: Corner Building Observations of (a) Pressure Difference and (b) Flow Rate	325
Figure 5.70: Comparison of Observed CR Flow Rate with Predictions of Formula (5.36) Using Observed Pressure Data.....	326
Figure 5.71: Comparison of Observed CR Flow Rate with Predictions of Formula (5.36) Using Pressure Coefficients Obtained From (5.46).....	327
Figure 5.72: Assessment of Assumed Value of $c_p(0) = 0.6$	328
Figure 5.73: Comparison of Façade-Averaged and Horizontally-Averaged CP	329
Figure 5.74: Range of Opening Positions Considered for Each Ventilation Regime.....	332
Figure 5.75: Presentation of Non-Dimensional Flow Rate as a Function of Opening Positions: Example Case of SS Configuration and Wind Direction $\varphi = 45^\circ$	332
Figure 5.76: Variation With Wind Direction (Left) and Average Over Wind Directions (Right)	334
Figure 5.77: Histogram of Wind-Averaged Flow Rates for Three Ventilation Regimes, Showing Proportion of Cases with (Wind-Averaged) Flow Rate in Ranges of Values.....	335
Figure 5.77: Definition of Façade Width, W_F	339
Figure A.1: Articulation Index vs. Communication Distance.....	A-16
Figure A.2: Volume Flow Rate/Overall Cross Section Area Versus Pressure Drop.....	A-31
Figure A.3: Frequency Distribution of Noise Measured at the Brower Center.....	A-38
Figure A.4: Frequency Distribution of Noise Measured at Loisos + Ubbelohde	A-40
Figure B.1: Design Fire T-Squared Fire Growth	B-9
Figure B.2: Mall/atria, General Plan View	B-10
Figure B.3: Mall/Atria, Computational Domains	B-10
Figure B.4: High Rise, Perspective View.....	B-11
Figure B.5: High Rise, Elevation View	B-12
Figure B.6: High Rise, Plan View	B-12
Figure B.7: Sensitivity Analysis of Temperature Readings.....	B-14
Figure B.8: High Rise Plan View, Floor Leakage	B-16
Figure B.9: High Rise Plan View, Roof Leakage	B-17
Figure B.10: High Rise Elevation View, Various Explicit Leakage Paths	B-17

Figure 10: High Rise Elevation View, Leakage Vectors.....	B-18
Figure B.11: Temperature and Visibility Sensitivity Study.....	B-19
Figure B.12: Comparison of Calculated and Modeled Flow Rates	B-19
Figure B.13: $t = 240s$, Start Time of Occupant Egress From Upper Floor	B-21
Figure B.14: Loss of Tenability at $T=784s$ on Floor Above Fire, High Rise	B-22
Figure B.15: Atrium Exhaust Openings	B-23
Figure B.16: Atrium Makeup Air Openings.....	B-23
Figure B.17: Location of Sensors	B-24
Figure B.18: Location of Wind Velocity Monitoring Points in Computational Domain.....	B-25
Figure B.20: Sensitivity of Velocity to Cell and Domain Sizes (Plan View of Horizontal Section)	B-27
Figure B.21: Visibility for 15m Atrium, $T = 400s$, Open (Upper) and Closed (Lower).....	B-28
Figure B.22: Visibility for 30m Atrium, $T = 400s$, Open (Upper) and Closed (Lower).....	B-29
Figure B.23: Visibility for High Rise, $T = 600s$, Open (Upper) and Closed (Lower).....	B-30
Figure B.24: $T=1200s$, 12.7m/S (28.4mph) Wind, Operable Windows	B-31
Figure B.25: Visibility, Operable Windows	B-31
Figure B.26: Velocity Profile, Leeward Side	B-32
Figure C.1: Wind-Driven Pressures on a Simple Volume	C-3
Figure C.2: Effect of Unequal Opening Sizes	C-4
Figure C.3: Effect of Fins on Wind-Driven Ventilation.....	C-4
Figure C.4: Single-Sided “Pulsing” Mode of Wind-Driven Ventilation.....	C-5
Figure C.5: Inland Revenue Building: Modes of Natural Ventilation	C-7
Figure C.6: Mixed Mode System: Natural Ventilation With Overhead HVAC.....	C-8
Figure C.7: Radiant Slab System	C-9
Figure C.8: US Climate Map.....	C-11
Figure C.9: Psychrometric Chart for Various Passive Conditioning Measures	C-11
Figure C.10: Wind Rose.....	C-12
Figure C.11: Computational Fluid Dynamics (CFD) Model of a Microclimate	C-13
Figure C.12: Impact of Solar Heat Gain Coefficient	C-17

Figure C.13: Modes of Heat Transfer	C-18
Figure C.14: Adaptive Comfort Chart.....	C-32
Figure C.15: Cross-Ventilation (CV).....	C-35
Figure C.16: Single-Sided Ventilation (SS)	C-36
Figure C.17: Displacement Ventilation (DV).....	C-36
Figure C.18: Comparisonb of Ventilation Strategies.....	C-38
Figure C.19: Urban Sheltering Effects	C-39
Figure C.20: Proposed Window Area Positions for SS and CV Systems	C-41

LIST OF TABLES

Table 2.1: Chief Characteristics of Buildings in Torcellini <i>et al.</i> (2006).....	27
Table 2.2: Feasibility Checklist from McConahey (2008).....	30
Table 2.3: Vintage Categories Used to Group Building Models, and Corresponding Title Twenty Four Year	76
Table 2.4: Sources for Building Model Inputs.....	77
Table 2.5: Form Characteristics of the Three Building Models.....	79
Table 2.6: HVAC System Types for the Three Building Models	80
Table 2.7: Cooling Load Reduction Measures.....	84
Table 2.8: Estimate Classification Matrix.....	94
Table 2.9: Consideration of Required Retrofits per Scenario	95
Table 2.10: Key Construction Activities per Retrofit Category	95
Table 2.11: Summary of the Costs per Unit Floor Area of the Different Retrofit Measures Simulated	97
Table 2.12: California Population, Proportional Population Breakdown by Forecasting Climate Zone and Title-Twenty Four Climate Zone.....	104
Table 2.13: Electricity Use (GWh) for California Offices, Broken Down by Building Type and Forecasting Climate Zone	105
Table 2.14: Estimated Floor Areas by Building Type, Vintage and Climate Zone (Thousand M ²)	106
Table 2.15: Case Study List	115

Table 2.16: Legacy Criteria.....	122
Table 2.17: Summary of Research.....	124
Table 2.18: Buildings and Measurements.....	126
Table 2.19: Summary of Measured Noise Levels.....	127
Table 2.20: Noise Issues and the David Brower Center.....	128
Table 2.21: Feasibility of Natural Ventilation (Based on Noise Only).....	129
Table 2.22: Other Acoustic Issues	130
Table 2.23: Acoustically Attenuated Ventilators	131
Table 2.24: Sound Reduction Data for Devices for External Air Transfer.....	133
Table 2.25: Title-24 Climate Zone Analysis Summary Data.....	139
Table 2.26: Principal Responsibilities and Interactions in the Design Team — Source: CIBSE AM10.....	152
Table 2.27: Priorities in the Design	153
Table 2.28: Barriers, Solutions and Arguments for Natural Ventilation	156
Table 3.1: Linear Regressions with PAQ.....	179
Table 4.1: Summary of Reported Ozone & PM2.5 IO Ratios in Offices.....	214
Table 4.2: Model Constants for Air-Conditioned Mechanical Ventilated Buildings.....	214
Table 4.3: Measured Weekday Period, Hourly IO PM2.5 Ratios	215
Table 4.4: Measured Weekday Period, Hourly IO Ozone Ratios.....	215
Table 4.5: Exposure Model Constants for Naturally Ventilated Offices	216
Table 4.6: Summary Results for Title-24 Climate Zones.....	218
Table 5.1: Test Building Dimensions – January 2013	233
Table 5.2: Velocity and Pressure Test Summary – January 2013.....	240
Table 5.3: Concentration Decay and Pressure Test Summary - Surrounding Model Pegs – January 2013.....	241
Table 5.4: Concentration Decay and Pressure Test Summary - Surrounding Model 2-Story – January 2013.....	242
Table 5.5: Concentration Decay and Pressure Test Summary - Surrounding Model 4-Story – January 2013.....	243
Table 5.6: Flow Visualization Video Summary – January 2013.....	244

Table 5.7: Test Building Dimensions – February 2012	258
Table 5.8: Test Building Dimensions – December 2011	261
Table 5.9: Concentration Decay and Pressure Test Summary – December 2011	263
Table 5.10: Definitions of Output Variables	274
Table 5.11: Test Cases Used to Develop Correlations	276
Table 5.13: Correlation Formulae in the Form $Y = aX + b$	283
Table 5.14: Sensitivity Test Results	284
Table 5.15: Cases and Results for the Side-by-Side Configuration	287
Table 5.16: Summary of Overall Scope of Single-Sided Tests.....	321
Table A.1: Legacy Criteria.....	A-3
Table A.2: References Relating to External Noise Break-in.....	A-8
Table A.3: International Studies.....	A-9
Table A.4: Office Privacy.....	A-10
Table A.5: Summary of Research	A-11
Table A.6: Buildings and Measurements.....	A-14
Table A.7: Summary of Measured Noise Levels.....	A-15
Table A.8: Noise Issues and the David Brower Center.....	A-18
Table A.9: Feasibility of Natural Ventilation (Based on Noise Only).....	A-23
Table A.10: Other Acoustic Issues	A-24
Table A.11: Acoustically-Attenuated Ventilators	A-25
Table A.12: Sound Reduction Data for Devices for External Air Transfer	A-29
Table A.13: Measurement Details	A-36
Table A.14: Measured Noise Levels at the Brower Center.....	A-37
Table A.15: Measured Noise Levels at Loisos + Ubbelohde	A-39
Table B.1: 2009 IBC and 2010 CBC Amendments for High Rise Smoke Control Requirements	B-5
Table B.2: NFPA 13 Sprinkler Spacing (NFPA, 2007a, Table 8.6.2.2.1(a))	B-7
Table B.3: Sprinkler Inputs for FDS.....	B-7
Table B.4: Design Fire Parameters	B-8

Table B.5: Cell Sizes Based on NUREG Study (USNRC & EPRI, 2007).....	B-13
Table B.6: Sprinkler Activation Times.....	B-14
Table B.7: Leakage Rates From CBC, Section 909.5.....	B-15
Table B.8: Egress Widths as per Section 1005.1.....	B-20
Table C.1: I-P and SI Units Compared	C-2
Table C.2: Natural Ventilation – Acceptable Room Depths.....	C-15

EXECUTIVE SUMMARY

Introduction

Retrofitting existing California commercial buildings with natural ventilation systems potentially provides energy savings along with improved occupant satisfaction. Energy savings from existing buildings, resulting in reduced greenhouse gas emissions, are needed to meet the targets of the California Global Warming Solutions Act of 2006, commonly known as AB-32. Until now there have neither been tools for rigorous assessment of the energy savings potential of natural ventilation, nor has there been collected knowledge of the issues concerning its implementation as a replacement or supplement to mechanical cooling systems.

Research Purpose

This research examined the potentials, benefits, and barriers to retrofitting non-residential buildings in California with natural ventilation. It also provided new tools and training to assist retrofitting natural ventilation within the existing building stock. In the mainly mild, dry California climate, replacing or supplementing mechanical cooling by natural ventilation is often suitable for both new construction and retrofit buildings. However, the implementation of natural ventilation faces significant barriers, such as concerns about providing consistently comfortable interior environments without admitting pollutants and noise.

Before this research, it was impossible for designers to assess the potential performance of different natural ventilation strategies for either new construction or retrofit of commercial buildings. Even simple questions such as how many operable windows would be needed for a given space, and what the optimal arrangement of these windows would be, could be addressed only in an improvised and untested manner. More complex questions, such as implementation and control of night flushing, the role of ceiling fans, and concerns about pollution, noise, and fire regulations were treated only within their separate disciplines.

In this research, a multidisciplinary team studied these issues and developed the knowledge and new tools that will allow owners, designers, and policy makers to make informed decisions on the pros and cons of using natural or mixed-mode ventilation in California commercial buildings. The results from the several projects provide design guidance for these questions, together with information on the expected benefits in terms of energy savings and reduced greenhouse gas emissions. The research also provided the first tools within a recognized building energy simulation program, EnergyPlus, to allow analysis of design alternatives.

The research was divided into three technical projects:

- Project 1. Barriers and technical potential
- Project 2. Indoor environmental quality
- Project 3. Model development

The results for each project are summarized below.

Project Results

Project 1

Project 1 assessed the potential for conversion to natural ventilation in California's existing stock of commercial buildings. Within the temperate coastal climate zone, many buildings are suitable for conversion to pure natural ventilation. Outside of the coastal zone, many other buildings are suitable for conversion to mixed-mode ventilation, which provide some form of additional cooling to use when natural ventilation alone is not adequate. Project 1 also investigated the barriers to implementing natural ventilation, including fire and smoke control, control of thermal comfort, acoustics, impact of outdoor air quality, and in the longer term, climate change.

The research team reviewed the existing knowledge and data concerning relevant buildings in California. They also identified information concerning design processes and tools, building codes and standards, and identified knowledge strength and gaps.

The key results are as follows:

- The application of natural and mixed-mode ventilation systems to new and existing commercial buildings has the potential to reduce energy costs.
- Natural ventilation is not commonly used in commercial buildings in the United States.
- Before natural ventilation will be commonly used in commercial buildings, barriers for designers, local authorities, owners, operators, and occupants must be overcome.
- Throughout the world, universities and research centers are conducting research on system feasibility, analysis tools, and barriers to natural ventilation.
- At present, multiple software tools are required to analyze the performance of a natural or mixed-mode ventilation system in terms of comfort, air quality, and energy consumption. A complete, integrated design tool is needed.
- The Commercial End-Use Survey database of existing commercial buildings in California provided information on building types, climates, and vintages, and suggests that 7 to 9 percent of California buildings contain neither mechanical ventilation nor cooling systems.
 - Warmer climate zones use more HVAC energy, and so the potential savings are larger, but the effective use of natural ventilation is more challenging in these climates.
 - The return on investment is usually higher in buildings which were originally fitted with operable windows. These tend to be older buildings.
- Existing codes provide little guidance to building designers or regulatory authorities on how to properly incorporate natural or mixed-mode ventilation into buildings.
- The interior acoustic design of office buildings is not regulated, and acoustic criteria are discretionary. Operable windows can lead to more interior noise. While ingress of

outdoor noise is a concern, occupants of naturally ventilated buildings remain satisfied at higher ambient noise levels than occupants of mechanically-ventilated buildings.

- Based on the Center for the Built Environment occupant satisfaction survey database, occupants of naturally ventilated and mixed-mode buildings are more satisfied with their thermal comfort than those in mechanically ventilated and conditioned buildings.
 - Climate change will have a small impact on overall energy use in California buildings; energy consumption for cooling will increase while that for heating will decrease.
 - Naturally ventilated buildings are more vulnerable to sustained heat waves but more resilient in the event of electrical outages. Mixed-mode systems designed for above-historical external temperatures offer a good combination of resilience and potential benefit in response to modeled climate change.

Project 2

In Project 2, researchers explored the range of comfort conditions and assessed the impacts of outdoor pollution on indoor air quality in a naturally ventilated building in Alameda, California. They studied adaptation to a wide range of indoor conditions during the year-long monitoring, particularly emphasizing air movement that included the use of ceiling and personal fans. They determined the relationship between interior and exterior pollutant conditions in buildings with operable windows by measuring particulate matter and ozone concentrations.

The key results are as follows:

- In the Alameda building studied in depth, people use windows and fans very effectively to achieve thermal comfort. Windows are open 2/3 of the time, and fans are turned on 1/5 of the time, during summer work hours. In summer, windows are opened at lower indoor air temperatures: around 73°F compared with 79°F in other seasons.
- The window opening/closing patterns are heavily driven by occupancy. In the warm season, people are likely to open their windows when they arrive and close them when they leave at the end of the day. Fans, on the other hand, are not routinely turned on when occupants arrive; the use of fans is more closely related to indoor temperature.
- The perceived air quality in this building is very good: it was rated unacceptable in less than 1 percent of votes. The most important predictor of perceived air quality is air movement satisfaction. Inadequate air movement leads to a perception of ‘stuffiness’ and poor air quality.
- The building occupants indicate thermal comfort over a broad range of temperatures, from 61-86°F, significantly beyond the ranges that the standard for thermal comfort of the American Society of Heating Refrigerating and Air Conditioning Engineers (ASHRAE Std-55) would predict.

- A “sensitivity-based” adaptive model was developed for this specific climate based on the idea that how much a change in indoor temperature affects comfort depends on the outdoor temperature range.
- The thermal comfort ranking of the mixed-mode buildings studied ranked very high at the 92nd percentile. 97 percent of occupants were satisfied with the operable windows, and 83 percent with the ceiling fans in their workspaces. These zero- and low-energy opportunities for adaptive control resulted in high thermal satisfaction even at an indoor temperature of 82°F.
- If offices in California substitute natural ventilation for mechanical ventilation and air conditioning, increased exposure to ozone and particulate matter may result in adverse health effects in small numbers of occupants. Conversely, incidences of ‘sick building syndrome’, in which occupants experience acute health and comfort effects that appear to be linked to time spent in a building, but no specific illness or cause can be identified, are expected to decline. This could result in significant employer cost savings.
- Strategies that restrict window use on high-pollution days, as well as particle filtration and ozone reduction measures inside the building, could reduce health effects and associated costs from exposure to outdoor air ozone and particulate.

Project 3

In Project 3 the research team developed energy simulation tools for a wide range of natural ventilation strategies in buildings. They conducted wind tunnel tests to determine wind pressure coefficients and associated building ventilation rates in a wide range of situations. Using results from these tests along with computational fluid dynamics, they developed new algorithms to model cross-ventilation (windows on opposite walls), single-sided ventilation (windows all on one side), and corner-office ventilation (windows on perpendicular walls), and implemented them as new modules in EnergyPlus, a commonly-used energy simulation tool developed by US Department of Energy. They also trained other practitioners in the use of the updated tool.

The key results include the following:

- Wind tunnel tests spanning the full range of ventilation flows resulted in the most extensive data set available for wind-driven ventilation, which provide invaluable information on façade pressure coefficients used to estimate airflows in simulation models.
- This work led to the development of new algorithms capable of predicting wind-driven ventilation in a wide range of conditions, including
 - The effects of window locations
 - The effect of cross, single-sided and corner ventilation
 - The magnitude and patterns of the internal flows produced
 - The effects of wind speeds and directions on ventilation rates

- The effects of surrounding buildings
- These new algorithms are simple enough to be implemented in EnergyPlus and were extensively tested against results in the existing literature and against the current wind tunnel and computational fluid dynamic results. They provide an improvement in both the capabilities and accuracy of natural ventilation calculations in a form that can be used in whole-building simulation codes.
- The new algorithms were successfully implemented in EnergyPlus, and the new version of EnergyPlus was introduced to the California engineering and design community through specifically designed training at three locations in February 2014.

Project Benefits

This work rigorously assessed the opportunities for natural ventilation. It provided information necessary for accurate simulation of thermal comfort, air quality, and energy performance of natural ventilation systems. The research focused on wind-driven ventilation because overall, retrofits to existing buildings offer the best efficiency opportunity, and one of the easiest and most cost-effective retrofits is to provide operable windows in a building. This will be done only if designers, owners, and regulatory officials are sure that the building will perform properly.

The detailed study of a naturally ventilated building used well-proven techniques for examining adaptive comfort. This project demonstrated the high level of satisfaction among occupants with operable windows, the effectiveness of occupant-controlled fans to mitigate temperature and air quality issues, and general satisfaction even with higher levels of ambient noise. The studies of sound ingress and smoke control provided guidance as to ways these issues can be analyzed, managed and potentially mitigated. The health impact study balanced issues of concern related to potential ingress of air pollution with reductions in sick building syndrome and absenteeism.

Finally, the work provided new tools and information to inform judgment about the potential for natural ventilation in commercial buildings throughout California. It will help determine the most favorable application of natural ventilation, whether total replacement of mechanical cooling or as mixed-mode, for any particular building type and location. The results will guide designs for specific buildings in terms of opening options. The new knowledge and tools will significantly increase the use of natural ventilation in commercial buildings in California, which will, in turn provide energy savings and reduce greenhouse gas emissions.

CHAPTER 1:

Research Summary

Retrofitting existing commercial buildings with natural ventilation systems could save large amounts of energy in California, while also improving satisfaction with the indoor environment. The most cost effective retrofit is often replacing a sealed façade with operable windows, and providing wind-driven ventilation. Until this research, the full potential in terms of indoor environmental performance and energy savings of this approach has not been well known, nor have there been tools available to accurately estimate the potential of implementing wind-driven ventilation in specific buildings.

The overall goal of this research was to facilitate wind-driven natural ventilation in existing commercial buildings in California. It assessed the potential for natural ventilation, developed simulation capabilities and trained design professionals in the use of these tools

Specific objectives were to assess the current commercial building stock in California as to suitability for retrofit to natural ventilation, and to examine the potential barriers such as external pollution, noise, and the hazards of fire and smoke. Wind-tunnel and computational fluid dynamic (CFD) studies of air flow around and through structures were conducted to provide the basis of algorithms for wind-driven natural ventilation. These were implemented in the US Department of Energy whole-building simulation program EnergyPlus. Finally, training in the use of these new capabilities in EnergyPlus was provided to help increase the penetration of natural ventilation in California commercial buildings.

The work was divided into three projects led by Principal Investigators (PIs) and coordinated by the PI of the overall research. As an aid for the reader, this chapter summarizes the research and presents the main findings of the three projects. For those interested in the details a full description of each project is given in chapters 2-5.

1.1 Project 1: - Barriers and Technical Potential

Project 1 was led by Arup and included contributions from LBNL and CPP Wind Engineering.

The goals of Project 1 were to assess the technical potential and implementation barriers for natural ventilation in California commercial buildings. The objectives included characterizing the potential for non-residential buildings in California to benefit from natural ventilation strategies, estimating the energy savings that could be realized individually and in aggregate throughout California, and providing performance based guidance notes for practitioners, owners, and authorities having jurisdiction, typically building code officials and fire officials.

1.1.1 Introduction and Background for Project 1

Project 1 addressed the technical potential of retrofitting commercial buildings in California with natural ventilation, as well as the barriers to it. The work consisted of four tasks:

- Task 1.1: review of the current relevant data and existing knowledge

- Task 1.2: characterization of the building stock in California
- Task 1.3: estimating building energy consumption and the demand reduction potential
- Task 1.4: assessing barriers to implementation.

This coordinated approach was intended to provide a view of the current use of natural ventilation in California, of its possibilities, and its limitations for retrofitting the existing building stock.

1.1.2 Methods for Project 1

To review the current data and knowledge on natural ventilation, the literature on research, design guidance and case studies was interrogated. In addition, design professionals from California, other regions of the United States, and from the UK and Australia were interviewed, asked about their design experience, the design tools they used, and whether they perceived any barriers to the implementation of natural ventilation. Building codes and design standards were studied, and the range of available tools assessed. The major relevant research institutions across the world were queried for their current work on this topic.

The existing commercial building stock in California was assessed as to suitability for natural ventilation using the following 3 step approach:

1. Identify key natural ventilation suitability factors to be catalogued.
2. Assess the relative importance of these factors.
3. Develop a methodology to characterize California's building stock with respect to:
 - a. The important natural ventilation suitability factors identified in step 2.
 - b. The potential energy savings in suitable buildings.

The suitability factors were split into two categories: building specific and site specific. Sacramento was selected as a demonstration city for the development of a methodology for the assessment of many of these factors. The effects of terrain and surroundings were examined in two parallel processes. Wind tunnel testing was used to determine the impact of the sheltering effect of neighboring buildings on the potential for wind-driven ventilation. The degree of sheltering in the real world was examined visually through aerial images, which allowed the team to see the spacing of buildings. Further, Graphical Information Systems (GIS) data was obtained regarding building zoning and use.

Use information was compared to building specific factors through the California Commercial End Use Survey (CEUS), a database that contains information on over 2,700 buildings in California, including detailed construction, mechanical system type, age, location, and energy use data. This allowed the team to break down California's existing building stock by building type (use), climate region, vintage (age), size, and energy consumption.

In order to assess the potential for energy savings, EnergyPlus was used to calculate the performance of three standard (small, medium and large) office buildings in the different California climate zones. A comparison was made between four cases:

1. Conventional air conditioned building
2. Conventional building retrofit with aggressive load reduction methods
3. Conventional building retrofit with natural ventilation 'package of measures'
4. Building with aggressive load reduction methods, with natural ventilation also added.

In order to assess the barriers to implementation, the relevant codes, standards and research papers were reviewed. Further, a high rise office building with an atrium was modeled to simulate and study the effects of fire, fire suppression system, occupant egress, smoke control system, wind effects, and to determine model reliability. Natural means of smoke control were examined.

Acoustic design standards were also reviewed to provide a basis for recommendations for code changes. Particular attention was paid to features such as exposed concrete surfaces that may impact the acoustic environment of naturally ventilated office buildings.

1.1.3 Results for Project 1

Natural ventilation is not commonly used in California commercial buildings, so conventional designers, and regulatory officials and owners lack experience with, and confidence in, this approach to space conditioning. However, both in the US and internationally, universities and research centers are conducting research related to natural ventilation, in terms of barriers to implementation, evaluation of software analysis tools, and overall feasibility. Ongoing research may provide new tools, information, and resources that can help overcome the specific barriers.

Evaluating the performance of a natural ventilation system in terms of thermal comfort, indoor air quality, and energy consumption currently requires the use of multiple design tools. This evaluation becomes even more complex for mixed mode systems, because the sequence of the two modes of operation must be coordinated in the simulation software to ensure adequate conditioning of the space, while maximizing use of natural ventilation. Continued software advancement by the private sector, university and government funded research centers is key to developing complete design and operational tools.

In characterizing the current building stock, climate is a key factor. A large portion of California has a temperate, dry climate that is ideal for natural ventilation. Other portions of the state have more extreme conditions, but still tend to have relatively low humidity levels. These areas often also have a substantial diurnal temperature swing between day and night. In these locations, a supplemental mechanical heating or cooling system may be required to condition the building when outside conditions are at their extremes. A night flush strategy that uses the building's thermal mass may also be an option for these climates.

Most California climate zones have a prevailing wind direction, particularly those along the coast. This direction will vary with the season and the time of day, with winter wind patterns and also nighttime winds shifting, sometimes by 180 degrees.

The “prevailing wind direction” actually represents a fairly broad range of wind directions. For example, in Sacramento, nominal SSW prevailing summer daytime winds come from directions between 180° and 230°. Wind pressures and the resulting ventilation rates can vary considerably over such a wide range of wind directions.

Sacramento’s prevailing winds shift between 140° and 200° at night, and between 300° and 340° during daytime in winter. When optimizing building shape and orientation to take advantage of such wind patterns, it is important to consider the overall ventilation strategy. The floor plate obviously cannot be narrowest for *all* wind directions. If night cooling is more critical than high airflow rates in the afternoon, the building can be shaped and oriented accordingly.

Another consideration that can be critical for natural ventilation design is extended periods of calm, when little wind driven ventilation will occur. Mild winds are actually fairly common, but they typically occur overnight and during the colder months. Calm is generally defined in meteorological records in the US as wind speeds of 2 knots or less. Extended calm conditions are relatively rare in the daytime.

The energy consumption calculated by EnergyPlus for baseline buildings and the three different retrofit options considered (aggressive load reduction, natural ventilation, aggressive load reduction plus natural ventilation) show that the introduction of natural ventilation along with ceiling fans, blinds, and Supply Air Temperature Reset (SATR), which constitutes the ‘package of measures’ noted in case 3 above, is only slightly less effective than the aggressive energy-use reduction measures chosen. The latter included reducing lighting and interior equipment power density by 30%, installing ceiling fans, external shading measures, venetian blinds, increased insulation, and SATR. (Table 2.6)

The savings obtained from combining the aggressive energy efficiency measures with natural ventilation show diminishing returns. Cooling energy reduction due to implementing natural ventilation in pre-2008 buildings is about 44%, although this includes saving from adding a SATR strategy. Adding natural ventilation to buildings that have undergone aggressive load reduction measures, including SATR, saves about 25% more in cooling energy. This reflects the fact that there is simply less cooling energy to reduce.

A cost-benefit analysis showed that, statewide, the Return on Investment (ROI) is much greater for late vintage buildings, because it is assumed that they already have fixed windows that comply with Title-24 2008, whereas the retrofit measures for the earlier vintages include upgrading the fixed windows to comply with Title-24 2008. Fixed window upgrades were one of the less cost-effective measures for retrofits.

The other measures, especially the implementation of the SATR control algorithm for the Large and Medium offices in the earlier vintages, are very cost effective. The increase of ROI with size for the late vintage buildings is a reflection of the lower ROI for the envelope measures

compared to the reduced lighting and equipment power density, which are independent of size. ROIs for large and medium office retrofits are better than the ROIs for small offices because the retrofit cost per unit area for a small office is higher.

Evaluating ROI's by California climate zone, the ROI's increase from CZ1 to CZ15, reflecting the increased opportunity for savings presented by the increase in cooling loads. CZ1 and CZ16 have significantly lower cooling loads than the other climate zones.

Natural ventilation may be quantitatively examined using computational methods to determine effectiveness during a fire. However, little guidance based on fire experience is available to building stakeholders and regulatory officials ('Authorities Having Jurisdiction' or AHJ's), and these authorities may not be persuaded by engineering studies.¹ Full-scale and case studies do show promise for the performance of open windows in fire emergencies, and a performance-based approach is permitted.

1.1.4 Conclusions for Project 1

The following conclusions were reached for Project 1:

- The application of natural and mixed mode ventilation systems to new and existing commercial buildings has the potential to reduce energy costs in California, but design and operational barriers must be overcome before it will be considered routine. Various barriers exist for designers, local authorities, owners, operators, and occupants.
- Evaluating how a natural ventilation system will perform in maintaining comfort conditions, indoor air quality, and energy efficiency, currently requires the use of multiple analytical design tools. The evaluation is even more complex for mixed-mode systems, which integrate conventional HVAC with natural ventilation. Better unified tools are needed to simplify the design process.
- The data contained in the Commercial End-Use Survey (CEUS) suggest that between 7 and 9 percent of California buildings do not contain mechanical ventilation or cooling systems at all.
- Energy savings which can be achieved by retrofitting office buildings with natural ventilation are roughly equivalent to the savings that can be achieved with a comprehensive set of energy saving measures, such as reducing the internal loads, changing set point temperatures and making significant upgrades to the façade, including the installation of external shading.
- Retrofitting with natural ventilation and applying the energy saving measures can achieve further reductions in energy use, but the benefit of the combination is less than the sum of the two sets of measures. This is because as the cooling requirements are decreased, natural ventilation provides smaller savings.

¹ AHJ's may include federal, state, or local building and fire authorities, insurance inspectors, or any other governing body that has a stake in the design and construction of buildings.

- The ROI depends on both the climate zone and the vintage of the building. Warmer climate zones use more HVAC energy and so the potential savings are larger, but the use of natural ventilation is more challenging in these climates.
- The ROI is better on older buildings if they are fitted with windows that can be restored to operability at low cost.
- Some technical issues associated with natural ventilation may be hard to overcome. For example, how can user behavior be managed? How can acoustics and air quality be controlled?
- Codes, standards and LEED® mainly focus on mechanical systems and on the importance of control. They are seen as important barriers to natural ventilation as they may bias designers towards implementing mechanical equipment. ASHRAE 62.1, from 2007 to 2010, allows natural ventilation, but clearly pushes designers toward implementation of mechanical systems. Many air quality and energy credits are easier to earn when using mechanical systems versus natural ventilation systems.
- Analysis of impact due to climate change suggests an increase in potential for building conditioning with natural ventilation throughout the year. Overall dry bulb temperature increases will increase building energy consumption for cooling and reduce it for heating. These offsetting trends work to keep the typical annual energy consumption of buildings approximately constant, implying only a small change in carbon emissions due to climate change.
- Electrical “brown-outs” due to increased peak demand will alter the vulnerability and resiliency of buildings that rely on natural ventilation for part or all of their cooling needs. These buildings may be more vulnerable in the face of sustained heat waves where passive nighttime flushing becomes less effective, but more resilient due to minimized solar gains and less dependence on electrically driven cooling and ventilation. Implementation of a mixed-mode system will likely offer the greatest resilience and potential benefit in response to modeled climate change.

1.2 Project 2 – Indoor Environmental Quality

Project 2 was led by UC Berkeley Center for the Built Environment and included work by LBNL. Its goal was to characterize occupant satisfaction and behavior in buildings where cooling is entirely by natural ventilation and ceiling fans, and to provide the scientific basis for architectural and engineering design guidelines, comfort standards, and natural ventilation predictive models.

The work comprised two parallel threads. The first, Project 2a, considered occupant satisfaction in naturally ventilated and fan assisted naturally ventilated buildings compared with that of conventional air conditioned buildings, and quantified cooling and comfort by natural ventilation. The second part, Project 2b, assessed the impact of natural ventilation on exposures to outdoor-air ozone and particles, and estimated the health risks and benefits of natural ventilation in offices relative to conventional practice.

1.2.1 Project 2a – Thermal Comfort in Offices with Elevated Air Movement

1.2.1.1 Introduction and Background for Project 2a

In naturally ventilated buildings, occupants have expressed equal satisfaction with thermal conditions as those in air conditioned buildings, but over a wider range of indoor temperatures. The causes are not fully understood, but include the cooling effect of the elevated air movement that results from open windows, climatically adapted clothing change resulting from knowledge that the interior temperature will be related to the exterior temperatures, physiological adaptation, and the psychological benefits of having available personal control of the environment. In many naturally ventilated buildings, operable windows are the most prominent source of air movement and personal cooling control, but it makes sense to supplement them with ceiling and desk fans, which can use very small amounts of electricity.

The questions addressed were:

- How do occupants interact with windows and fans? And how should behavior regarding window and fan operation be modeled?
- How do adaptive opportunities and actions affect comfort?
- How do occupants' perceptions about air quality, temperature, and air movement relate to measured environmental conditions?
- Under what conditions are occupants comfortable? How do these compare with the adaptive comfort standard ASHRAE 55?

1.2.1.2 Methods for Project 2a

Three buildings were tested for thermal comfort. One entirely naturally-ventilated building (the Alameda building) was studied intensively over time. Occupants were repeatedly surveyed over a course of a full year about their perceptions, satisfaction, and thermal preferences using a survey that obtains point-in-time responses to the environment. At the same time as the surveys, physical measurements were made of the environment and occupant behavior. The surveys were conducted 3 times/day for 2 weeks each month, or for 2 weeks every two months when the weather was mild. Hourly window opening and fan operation was monitored, and temperature, relative humidity, and CO₂ profiles within the interior zones were measured at 5 minute intervals. The resulting data addresses a variety of questions concerning behavior, adaptation, and comfort.

In addition to the Alameda building, two other office buildings with operable windows and ceiling fans were surveyed, the Biosciences Building at the University of Washington in Seattle, and the certified net-zero energy DPR Building in Phoenix, Arizona. Both are mixed-mode buildings. The CBE Occupant Satisfaction Survey was administered once in each building to obtain people's long-term experience of the indoor environmental quality (IEQ) and its effect on their work performance. The main IEQ categories are thermal comfort, indoor air movement, perceived air quality, lighting, acoustics, space, quality of furnishings, and upkeep. Occupants' window and fan usage are also examined.

1.2.1.3 Results for Project 2a

Alameda experiences a typical Bay Area climate, with mild winters and summers except for short periods of extreme high temperatures. The progression from hot to cold is not smooth; there are often large differences between one day and the next.

Outdoor air temperatures were generally cool. Typical winter temperatures were between 5 and 18°C (41-64°F) and summer between 15 and 26°C (59-79°F). There were hot periods from April to November, but even these were confined to daytime; the evening to mid-morning hours were consistently cool. In addition to this diurnal variation, there was also considerable variation between days in the same week. Indoors, by contrast, the temperature was usually warm over the course of the year, mostly at least 23°C (73°F). The cool periods were mostly during the mornings from November to April. Many mornings that started out cold turned into warm afternoons. As with the outdoor temperature, clusters of days varied considerably from one to the next.

The ceiling fans were turned on much less frequently than the windows are opened, but mostly over the same April to October time period. Within a given day, fans are more likely to be turned on in the morning or early afternoon and turned off in the late afternoon or evening when people are leaving. Since there is a wider distribution of hours when fans are frequently turned on than turned off, one may conclude that turning on a fan is temperature driven while turning it off is best explained by occupancy.

Overall satisfaction with the mixed-mode buildings is very high, 97 percent of occupants in the DPR building and 92 percent of the UW occupants were satisfied overall. Thermal comfort, air quality, and acoustics were all rated very highly in the DPR Building. The thermal comfort ranking for the University of Washington building is not as high, at the 70th percentile. The source of the dissatisfaction is very common in mechanically-cooled buildings: the building is being overcooled to between 20 and 22 degrees C (68-72°F) year-round.

A “sensitivity-based” adaptive comfort model was developed, which unlike the adaptive model in ASHRAE 55, is for a specific climate, based on the idea that how much a change in temperature affects comfort depends on the outdoor temperature range. The sensitivity-based model accounts for different types of climates when using climate-based regression coefficients.

1.2.1.4 Conclusions for Project 2a

In the Alameda building, people open windows and turn on fans to achieve thermal comfort and improve perceived air quality. The occupants express satisfaction with thermal conditions, even when they are well outside the temperature range expected in a mechanically conditioned building. This satisfaction appears to be partly due to the effect air movement has on reducing a sense of ‘stuffiness’ in warm conditions. The element of local control and connection to the outdoors may also improve satisfaction with the indoor environment.

The overall satisfaction ranking of the mixed mode buildings is also very high, including even such difficult topics as acoustics. These buildings provide opportunities for adaptive control with very low energy use, which result in high thermal satisfaction, even at indoor

temperatures as high as 28°C (82°F). In the mixed mode buildings studied, any discomfort expressed was primarily related to overcooling when using mechanical cooling.

1.2.2 Project 2b – Ozone and Particle Exposures in Naturally Ventilated Offices

1.2.2.1 *Introduction and Background for Project 2b*

Applying natural ventilation strategies in buildings is expected to change occupants' exposures to outdoor air contaminants compared to the exposures to these pollutants for occupants of air-conditioned buildings. Of particular importance are exposures to two outdoor pollutants: particulate matter (PM) and ozone, both of which can have significant health impacts. On the other hand, there is evidence that symptoms of sick building syndrome (SBS), which include headache and irritation of eye, nose, or throat, are reduced in naturally ventilated buildings.

1.2.2.2 *Methods for Project 2b*

Annual exposures to ozone and particles less than 2.5 micrometers in diameter (PM_{2.5}) for office workers in naturally ventilated offices were compared to the exposures of workers in conventional air-conditioned offices with sealed windows and particle filtration. Based on the differences in contaminant exposures, the differences in the numbers of cases of several health outcomes were predicted. The costs associated with each health outcome were estimated, in order to quantify the economic consequences of broader adoption of natural ventilation. In broad terms, particulate and ozone result in high-cost outcomes in a small number of cases, while sick building syndrome results in lower cost outcomes in a much larger number of cases. Because of uncertainties in several parameters, the resulting estimates of health effects and related costs also have substantial uncertainty, as well as variability based on local conditions.

Data were collected on indoor and outdoor concentrations of ozone and PM_{2.5}, ventilation rates, and window usage in four naturally ventilated California offices, which represent typical naturally ventilated offices in a range of sizes. Measured ozone and PM_{2.5} were assumed to be from outdoors and brought into the building via ventilation. The study buildings were either solely naturally ventilated, or could be operated in natural ventilation mode in the case of mixed-mode buildings.

1.2.2.3 *Results for Project 2b*

Window use significantly increased during the summer months; thus, natural ventilation increased ozone and PM_{2.5} exposure during the summer and reduced exposure during the winter, compared to mechanically ventilated buildings. Averaging changes in indoor concentrations over the whole year, including both winter and summer months and adjusting for time spent at work resulted in relatively small differences in annual average exposure-related concentrations between the two types of buildings. Actual exposures in particular buildings would depend on local levels of pollutants at given times of the year, but outdoor concentrations of ground level ozone tend to increase during warm weather.

If 10 percent of California's office stock were retrofitted to natural ventilation, and this resulted in 25 to 66 percent reduction in sick building syndrome symptoms in naturally ventilated offices, then over California's total population of 5 million office workers the model predicts that 22,000 to 56,000 fewer people would experience symptoms each week. Over the same

population of 500,000 workers in the retrofitted buildings, 14 to 23 premature deaths are projected. The costs due to increased exposure to pollutants appear high, but the projected number of affected workers is very small.

Health-related costs for naturally-ventilated buildings were negative in several of the climate zones, because in those climates the annual pollutant exposures were lower for occupants of naturally ventilated offices than for occupants of air-conditioned offices. Lower exposures for occupants in naturally ventilated offices in these cooler climates were partly a result of less opening of windows than in other climate zones, and the absence of mechanical ventilation when windows were closed.

Restricting window use on high-pollution days could mitigate a portion of the health costs due to increased contaminant exposure from natural ventilation. In climates with significant inter-seasonal temperature swings, such as Title-24 climate zone 12, costs related to PM_{2.5} exposures were lower for naturally ventilated buildings with the mitigation strategy than for the air-conditioned reference building.

1.2.2.4 Conclusions for Project 2b

Occupants might be exposed to increased levels of ozone and particulate matter if offices in California substitute natural ventilation for traditional mechanical ventilation and air conditioning. The level and timing of this exposure would depend largely on local and climatic factors. Increased exposure to ozone and particulate could increase mortality in a small number of workers. At the same time, occupants' sick building syndrome symptoms are projected to decrease in a much larger number of workers. The increased costs attributed to ozone and PM-related health effects may outweigh the reduced costs from sick building syndrome symptoms, but the costs are also not entirely borne by the same parties. The reduction of sick building syndrome symptoms could reduce health care and labor costs. Chronic health problems due to ozone and particulate would increase those costs, but in a much smaller number of employees.

There are a number of sources of uncertainty in the projections in this study. Data on indoor-to-outdoor concentration ratios of particles and ozone are sparse, particularly from naturally ventilated offices. Other large sources of uncertainty include occupants' actual use of windows, Concentration-Response (C-R) functions, and unit costs for health effects. The C-R functions are based on studies of the general population, including susceptible infants and elderly, but the office worker population does not include those more vulnerable types of individuals. Office workers are presumably less susceptible to ozone and particles than the C-R functions would indicate. Consequently, the estimates should be considered to be accurate within an order-of-magnitude.

Another limitation is the incomplete information on the costs of Sick Building Syndrome (SBS) symptoms and health effects of particles and ozone. The analysis only accounts for the projected health-care costs of SBS symptoms. If SBS symptoms significantly reduce work performance or increase absenteeism, significant cost savings could result from SBS reduction in naturally-ventilated buildings.

Mitigation strategies that restrict window use on high-pollution days could reduce adverse health effects from exposure to outdoor air ozone and particulate matter. Forecasts of daily average PM_{2.5} and ozone concentrations could be used to pre-emptively close windows to limit occupant exposures on high-pollution days. The health effects and costs from increased exposure to ozone and particulate matter in naturally ventilated buildings could be substantially reduced by keeping windows closed on the days with the highest levels of ozone and particulate matter, respectively.

Windows are often used for ventilation cooling during hot periods, which are likely to coincide with periods of elevated ozone levels associated with hot weather. If these conditions are expected frequently, a mixed-mode system may be more suitable than pure natural ventilation. Mechanical cooling would likely be needed to maintain comfort, and mechanical ventilation would be needed to prevent an increase in sick building syndrome symptoms.

In cooler areas less exposed to ozone and particulate matter, natural ventilation alone could suffice, and provide energy savings, health benefits and reduced labor costs. In hotter areas more exposed to particulate and ozone, a mixed mode system with closed windows during hot weather or high pollution events could provide similar benefits, at somewhat higher complexity and operating costs.

Other mitigation strategies could include installing particle filtration and ozone removal systems inside naturally ventilated buildings. For this strategy to be effective, the rate of airflow through the filters would need to be comparable to the rate of entry of outdoor air. Special materials, such as activated carbon mats that react with and remove ozone at a higher rate than conventional materials could also be installed in the building where ozone-carrying air would contact them, such as outdoor air ducts. (Cros *et al.* 2012). Further study is needed to determine the costs and performance of these mitigation options.

1.3 Project 3 – Model Development

1.3.1 Introduction and Background for Project 3

Project 3 was led by UC, San Diego with contributions from LBNL and CPP Wind Engineering.

The goal of Project 3 was to promote use of natural ventilation in California commercial buildings by developing and incorporating accurate air flow models into energy simulation tools to correctly model performance and energy consumption in naturally ventilated buildings.

A series of steps was set out to accomplish these goals. The first step, in Tasks 3.1 and 3.2, was to better understand the air flows that develop within buildings when various openings are made in the façade. This was achieved using wind tunnel tests and Computational Fluid Dynamics (CFD). The results of these tests and computations were analyzed to develop an understanding of the different ventilation regimes and how the air flow depends on the various parameters of the problem, including building geometry, opening location, wind speed and direction.

Based on this deeper understanding, the second step, in Task 3.3, was to develop and test new algorithms that relate the ventilation flow to these parameters, in order to establish a predictive

capability. These algorithms were then tested against information from the literature and from new results obtained from wind tunnel tests and CFD calculations. This testing established confidence in the new algorithms, along with awareness of their limitations, and estimates of the accuracy for different scenarios and flow conditions.

The third step was integration of these new algorithms into EnergyPlus in Task 3.4. Algorithms for cross-ventilation previously available in EnergyPlus were updated and new algorithms for single-sided ventilation were added, significantly upgrading the potential of EnergyPlus for natural ventilation calculations.

Finally, Task 3.5 introduced the new version of EnergyPlus to the simulation community through three 1-day training sessions held in San Francisco, Los Angeles and San Diego.

1.3.2 Methods for Project 3

Single and multi-story buildings were studied, both in isolation and surrounded by adjacent buildings. The following methods provided an understanding of the flows and ventilation rates as functions of the building geometry, the opening sizes and locations, and the wind speed and direction:

- Wind-tunnel studies to characterize the pressure distributions on building surfaces and to determine ventilation rates for wind-driven flow for a wide range of building shapes and orientations, opening geometries and distributions, and the effects of nearby buildings.
- CFD studies using Fluent, to determine the flow in cross ventilation.
- Using the results of the wind tunnel measurements to determine interior flow regimes and ventilation rates for single-sided, cross and corner-office ventilation.

The results of these investigations were then interpreted in terms of fluid dynamics and simplified to algorithms of sufficient accuracy and simplicity for implementation into whole-building energy simulation codes. Specifically, they developed algorithms to relate interior flow patterns to external wind conditions, and building and opening geometries.

These algorithms and the associated documentation were then passed onto the EnergyPlus team for implementation. Finally, training in the use of the new natural ventilation capabilities of EnergyPlus was provided to design professionals and practitioners in three 1-day training sessions.

1.3.3 Results for Project 3

1.3.3.1 Wind tunnel tests

Three measurement campaigns provided a very large data set over a wide range of building geometries, window sizes and locations, wind speeds and directions, and included the effects of sheltering by neighboring buildings. Cross ventilation, single-sided ventilation and corner ventilation were investigated.

The data consist of:

- Ventilation rates based on the concentration decay of a passive tracer gas.
- Pressure measurements around the façade of the building.
- Flow patterns from flow visualization.

The full details are provided in Chapter 5.

1.3.3.2 Cross Ventilation

Cross ventilation of a single space was modeled using Fluent for a range of room geometries, window sizes and locations, and wind speeds and directions. The results of these calculations were validated against previous work and used to develop correlations between the relevant parameters.

It was found that the flow consisted of strong jet-regions with recirculation regions with slower flow between the jets. The dimensionless strength of these flows was found to depend on the ratio of the opening size to the room cross-sectional area and on the ratio of the room depth to the inflow diameter. Specifically, it was found that

- Longer rooms have lower indoor velocities, while rooms with a larger inflow to room cross-sectional area have higher velocities for the same inflow rate.
- The maximum airflow rate in the recirculation region increases with the area of the room: wider rooms have larger recirculation flow rates, which is a useful feature to dilute the heat gains that may exist in these regions.
- Internal heat gains in the recirculation regions lead to large local temperature increase. In contrast, when heat is placed in front of the inflow jet region the temperature increase is approximately uniform in the whole flow volume.
- For the typical inflow velocity and internal sensible heat gain density that occurs in cross-ventilated buildings, buoyancy effects, outlet geometry and aperture shape factor do not have a significant impact on airflow velocities and internal temperature distribution.
- Rooms with multiple inflow openings can be modeled as a set of single inflow opening rooms in parallel. In these cases, interference of the adjacent recirculating flows leads to negligible change in indoor velocities.
- For isolated cross ventilated buildings, variations in wind direction change the inflow driving velocity in a way that compensates the decrease in static pressure that occurs for non-normal wind angles, making cross ventilation flows partially self-regulating.

As a result of this work algorithms for the ventilation rates were obtained and are described in detail in Chapter 5.

1.3.3.3 Single-Sided Ventilation

It was not possible to obtain convergent calculations for single sided ventilation and so the results of the wind tunnel tests were used to obtain the relevant algorithms. There is a

significant difference between the flow induced by a single opening when the flow has to be simultaneously in and out through that opening, and cases with two or more openings when the flow can be in through some openings and out through others.

1.3.3.4 Aperture Single-Sided Ventilation

Analysis showed that the ventilation scales with the local velocity at the aperture and an expression was obtained from an analysis of the wind tunnel data that covers the full range of wind angles.

1.3.3.5 or More Apertures

The ventilation in this case is driven by the pressure difference between the openings. This pressure difference consists of two parts: the steady pressure difference established by the mean streamlines around the building and the unsteady pressure differences caused by temporal fluctuations in the wind speed. The relative importance of these effects depends on the location of the apertures, with unsteady effects being more important on the lee side of the building as a result of vortex shedding from the corners of the building.

An extensive analysis provided an expression for the ventilation rates for 2 apertures that was within 20% of the wind tunnel data for all aperture configurations and wind directions, which is considered acceptable accuracy. Wind-angle dependence was treated by a piecewise-sinusoidal form.

The analysis was extended to take account of the variation of pressure, for both the steady and unsteady components, across the façade, since only average pressure coefficients are used in EnergyPlus. This was done by using a linear approximation to the pressure variation, equivalent to taking the first term in a Taylor expansion.

The formula derived for the ventilation rate can be used as a standalone result. However, it can also be re-interpreted in terms of an equivalent static pressure difference which, if applied, would result in the given flow rate. Thus, if the two openings are viewed as nodes in a pressure network, specification of the pressure difference would give the required flow rate for the room. EnergyPlus contains such a model, and therefore framing the flow rate correlation as a pressure difference will make the calculation of 2-opening single-sided ventilation essentially invisible to the user. This was achieved using a model for the wind profile and assigning a pressure coefficient to the opening.

For more than two openings an algorithm was developed that groups multiple openings into an equivalent pair, allowing the results from the 2-apertures cases to be applied directly.

1.3.3.6 Corner ventilation model

The fact that the openings are on different façades of the building is crucial to the understanding of CR ventilation: the sharp edges of the building result in distinct flow patterns on adjacent walls and hence quite different pressure distributions, which in turn lead to significant pressure differences between the two openings.

It is found that the corner case behaves either like a cross ventilation case, or a 2-aperture single sided case depending on the wind direction. In both these cases the ventilation flow rate can be

calculated in terms of the mean and unsteady pressure differences and an algorithm that switches between the two was developed that matches the wind tunnel data to within 25%.

1.3.4 Conclusions for Project 3

Room airflow patterns in cross-ventilation depend on the ratio between inflow and room cross-section area $A' = A_{in}/A_{RM}$. When $A' > 0.5$, the flow resembles a unidirectional piston flow without recirculation regions. We have focused on the more common and complex case of flow with recirculation regions, $A' < 0.5$. For this case, the results presented above confirm the possibility of characterizing the flow as a confined axisymmetric jet flow that drives the recirculation regions into a lid driven cavity flow.

The model correlation expressions predict the average indoor velocities in two distinct regions of the flow, the jet and recirculation regions, using a linear function of inflow velocity and two non-dimensional variables, namely A' and D' , the ratio of room depth to characteristic inflow diameter. Indoor velocities are proportional to $A'^{1/2}$ and inversely proportional to D' : longer rooms have lower indoor velocities, due to increased jet decay, while rooms with a larger inflow to room cross-sectional area have higher velocities for the same inflow rate. Maximum airflow rate in the recirculation region varies with $A_{RM}^{1/2}$: wider rooms have larger recirculation flow rates, which is a useful feature to dilute the heat gains that may exist in these regions. Internal heat gains in the recirculation regions lead to large local temperature increases. In contrast, when heat is placed in front of the inflow jet region the temperature increase is approximately uniform in the whole flow volume. For the typical inflow velocity and internal sensible heat gain density that occurs in cross-ventilated buildings, buoyancy effects, outlet geometry and aperture shape factor do not have a significant impact on airflow velocities and internal temperature distribution.

The results of this study also show that rooms with multiple inflow openings can be modeled as a set of single inflow opening rooms in parallel. In these cases, interference of the adjacent recirculating flows leads to negligible change in indoor velocities. For isolated cross-ventilated buildings, variations in wind direction change the inflow driving velocity in a way that compensates the decrease in static pressure that occurs for non-normal wind angles, making cross ventilation partially self-regulating.

For single sided ventilation in a space with a single aperture, the ventilation scales with the local velocity at the window and a correlation expression captures this behavior satisfactorily. A space with two apertures can offer a significant ventilation rate and we have made first steps to quantify this for use in naturally-ventilated rooms. The two aperture case was characterized and extended to $N > 2$ apertures. Algorithms were provided that predict the ventilation over a wide range of conditions: 2- and 4-story buildings and sheltering with low, widely-spaced blockage elements. The likely uncertainty is about 25%.

A corner office with one opening on each external façade can be satisfactorily predicted by the mean pressure difference between the two apertures and that this is adequately characterized by the pressure coefficient correlation of Swami & Chandra (1988), which is already available within EnergyPlus. Other than ensuring that the corner room is represented with two apertures

and placing a lower limit on the pressure difference, the corner case can be modeled with EnergyPlus with minimal modifications.

In summary, this work has led to the development of new algorithms capable of predicting wind-driven ventilation in a wide range of conditions, including

- The effects of opening locations and their impact on both the ventilation types (cross, single-sided and corner ventilation) and the magnitude and patterns of the internal flows produced;
- The effects of wind speeds and directions on ventilation rates;
- The effects of surrounding buildings.

These new algorithms are designed to be simple enough to be implemented in EnergyPlus and have been extensively tested against results in the existing literature and against the current wind tunnel and CFD results. They provide a significant improvement in both the capabilities and accuracy of natural ventilation calculations in a form that can be used in whole-building simulation codes.

The algorithms, except for corner ventilation, have been implemented in EnergyPlus and have undergone some testing. This work is continuing under DOE funding for further development of EnergyPlus.

CHAPTER 2: Barriers and Technical Potential

Natural and mixed mode ventilation systems have the potential to reduce US energy consumption, fossil fuel emissions and building owners' operational costs. However such systems are not typically applied to commercial buildings, for a wide variety of reasons. Many of these reasons are associated with perceived barriers to the implementation and efficacy of natural ventilation. In order to increase the penetration of natural ventilation in California building designers, contractors, owners, operators, occupants and related authorities must be able to identify and overcome these barriers.

Project 1 provides an assessment of the technical potential and barriers to implementation of natural ventilation in California commercial buildings, with the ultimate goal of reducing energy consumption. This is achieved by characterizing the potential for commercial buildings in California to benefit from natural ventilation strategies, estimating the energy savings that can be realized individually and in aggregate throughout California, and provide performance based guidance for practitioners, owners, and Authorities Having Jurisdiction (AHJ's). The stock of existing commercial buildings in California represents a large potential for energy savings through natural ventilation retrofit applications. The project includes the following technical tasks:

- Task 1.1 - Data Gathering and Knowledge Review
- Task 1.2 - Characterization
- Task 1.3- Building energy consumption & demand reduction potential, energy modeling with EnergyPlus.
- Task 1.4- Implementation and barriers for implementation

The methodology, results and conclusions for each of these tasks are described in the following sections.

2.1 Knowledge Review

Task 1.1 of the Natural Ventilation for Existing and New Commercial Buildings in California: Technical Potential and Barriers study provides a summary of information to address design processes and tools, building codes and standards, and leading research in order to identify knowledge strength and gaps, useful design tools related to natural ventilation and serves as a resource guide for building designers, owners and regulating bodies.

Natural ventilation research at US and international universities and research centers related to barriers to implementation, software analysis tools, both identification and evaluation of, and feasibility can offer new information, tools or resources that can help overcome or validate the specific barriers to natural ventilation implementation.

Private and government funded software development is critical to advancing natural ventilation design tools that will allow the evaluation of the performance of natural ventilation systems for thermal comfort conditions, indoor air quality requirements and energy consumption required for proper design. Currently available tools are not effective at analyzing thermal comfort conditions, indoor air quality requirements and energy consumption simultaneously.

2.1.1 Introduction

Natural ventilation is a low-energy strategy to provide fresh air and free cooling to a building. Properly designed natural ventilation strategies will incorporate strategically located façade openings and take advantage of stack effect and local wind patterns. Naturally ventilated buildings include openable façade elements that are actively configured, by the operator or through building automation systems, to optimize building energy and comfort performance. Natural ventilation can provide energy savings by reducing the use of mechanical ventilation when outside conditions are favorable, or in certain climates, eliminate the need for mechanical cooling all together. Designing natural ventilation systems involves a different approach than mechanically ventilated systems, including the application of different code sections, the use of different software analysis tools, and the introduction of requirements specific for non-mechanical ventilation systems that may limit or restrict the application. Natural ventilation systems are often combined with mechanical hybrid systems in order to provide supplemental cooling, heating, or ventilation when natural means are insufficient to maintain comfort and indoor air quality requirements. These combined systems types are referred to as mixed mode ventilation systems. The existing commercial building stock in California accounts for a large percentage of energy use and presents an opportunity to reduce energy consumption by introducing natural or mixed mode ventilation systems through retrofits of the existing buildings.

Task 1.1 provides a summary of current information to address design processes and available tools, building codes and standards, and leading research. Knowledge strengths and gaps are identified to serve as a resource guide for building designers, owners and regulating bodies.

2.1.2 Literature Review

As part of Task 1.1 a literature review of available publications was conducted in order to understand the current state of design processes and tools, barriers, and leading research associated with use of natural ventilation in commercial buildings. This section provides a summary of the most relevant publications that were reviewed during this task.

2.1.2.1 Perceived Barriers to Natural Ventilation Design of Office Buildings

Author: Søren Aggerholm

Date: July 1998

This report was produced as part of the Pan-European project NatVent™. NatVent™ aims to reduce energy consumption in buildings by:

- (a) *Providing solutions to barriers which prevent the uptake of natural ventilation and low-energy cooling in countries with moderate and cold climates, and*
- (b) *Encouraging and accelerating the use of natural ventilation and smart controls as the main design option in new-designs and major refurbishments of office-type buildings.*

A survey was conducted across seven European countries that have moderate and cold climates to address the barriers that prevent the use of natural ventilation in both new and retrofitted commercial office buildings. The countries included: Great Britain, Belgium, Denmark, The Netherlands, Sweden, Norway, and Switzerland. A wide range of professionals were interviewed, including: architects, consultant engineers, contractors, developers, owners and governmental decision makers. Interviews were separated into two distinct categories: *General view on natural ventilation in office buildings* and *Specific building project*. A total of 107 interviews were conducted. The following conclusions were drawn from the study:

- The interviews identify significant lack of knowledge and experience of specially designed natural ventilation in office buildings compared to the knowledge and experience of mechanical ventilation. In addition there is a lack of source and information to natural ventilation knowledge in standards, guidelines and building studies. There is also a desire for new design tools on natural ventilation, including also calculation rules and easy to use, simple and advanced computer programs.
- There is a need for good, standardized and generally acceptable natural ventilation system solutions and for more advanced solutions including heat recovery. In addition, there is a moderate need for new components regarding windows and vents with better air flow and draught performance, better controllability and better design.
- In the interviewees' perception, mechanical ventilation has several advantages compared to natural ventilation with regard to cooling effectiveness, draught minimization, ability to remove odors and pollutants, ability to prevent ingress of odors and pollutants, insulation against external noise and central controllability, especially if the mechanical ventilation systems are well designed. Nevertheless the interviewees do not expect a higher user satisfaction in mechanical ventilated offices. In fact they expect the highest user satisfaction in natural ventilated cellular offices where the highest individual controllability is also expected.
- Many interviewees expect higher installation, higher running and higher maintenance costs for mechanical ventilation in offices than for natural ventilation.
- Room temperatures in summer, indoor air quality and construction costs are the most important and critical design parameters. The architects, consultant engineers and owners have the biggest influence on the design of a building.
- Fee structures for design, liability of natural ventilation design in relation to lack of calculation rules, standards and guidelines causes problems for the use of natural ventilation in office buildings.

- Restrictions in the use of natural ventilation in office buildings placed by national building regulations, codes, norms and standards are relatively limited, but problems can be caused by fire division requirements in the national Building Regulations, and by guidelines about the need for mechanical ventilation in certain instants e.g. large offices, assembly rooms and canteens.
- On average the interviewees expect an increase in the future use of natural ventilation in office buildings. In general, the architects have the highest expectation of increasing use of natural ventilation.

This paper identified potential barriers to natural ventilation in the forms of limited available tools, restrictions in codes and standards, lack of knowledge and understanding as compared to mechanical ventilation systems, and others that will be further addressed in later parts of this section.

2.1.2.2 Natural Ventilation Review and Plan for Design and Analysis Tools

Authors: Steven J. Emmerich, W. Stuart Dols, James W. Axley

Date: August 2001

This report was prepared by the National Institute of Standards and Technology (NIST) in August of 2001 as a result of work sponsored by the California Energy Commission to, “review the application of natural ventilation in commercial buildings, the technology, its potential advantages and related issues that need to be addressed.” The report also looks at the application of natural ventilation for commercial buildings in California. Opportunities and issues related to climate suitability, ambient air quality, and relevant codes and standards were specifically addressed as they apply to California.

A new ventilation cooling metric that could be used for evaluating the potential for natural ventilation based on climate suitability was presented. This tool was used to evaluate the climates of ten cities in California – coastal and inland cities were evaluated. The study found that the majority of the coastal climates were well suited for natural ventilation, and that the hotter and more humid inland climates showed less potential. However, benefits from natural ventilation were still predicted for inland areas, especially if coupled with a hybrid mechanical system. This report was prepared as a result of work sponsored by the California Energy Commission.

In addition to the climate suitability tool described above, this paper also describes available tools for designing and analyzing natural ventilation systems themselves. The design and analysis tools examined were classified into two model types: macroscopic (single or multi-zone bulk air flow) or microscopic (computational fluid dynamics, CFD). After describing the benefits, limitations, and typical application of the two model classes, the paper presents the “pressure loop method” whereby a flow path through a building can be idealized as a network of points through the building from inlet to exhaust and back again. The pressure difference between the points can then be analyzed to help designers to refine natural ventilation systems.

A plan to implement the *Loop Equation Design Method* into an existing multi-zonal simulation tool was described.

Since this report was published in 2001, NIST has successfully developed the two tools that were proposed. First, the ventilative cooling metric was developed into the *Climate Suitability Tool* and is now accessible from their website, www.nist.gov. Secondly, the Loop Design and Analysis tool (LoopDA) has been integrated into CONTAM (an existing multi-zone CFD analysis tool). Details of these tools are described in more detail in Section 2.1.5.

NIST has published papers that provide updates to the future work outlined in this paper, including the following: Axley *et al.* (2002a, b); Emmerich & Crum (2005); Emmerich & Dols (2003); Emmerich *et al.* (2003).

2.1.2.3 Contrasting the Capabilities of Building Energy Performance Simulation Programs

Authors: Drury B. Crawley, Jon W. Hand, Michaël Kummert, Brent T. Griffith

Date: July 2005

The Contrasting the Capabilities of Building Energy Performance Simulation Programs report was produced in 2005 by the U.S. Department of Energy (DOE), the University of Strathclyde, and the University of Wisconsin. This report compares the features and capabilities of twenty of the major building energy simulation programs. Eighteen of these twenty programs are still listed on the DOE Building Energy Software Tools Directory described above.

The report includes matrices that list desired capabilities of each software and classify the level of development of the twenty programs into one of six categories. One of the matrices provided in the report classifies the ability of the twenty programs to handle infiltration, ventilation, room air and multi-zone airflow. Of the modeling capabilities evaluated, the following are directly related to modeling natural ventilation systems:

- Automatic Calculation of Wind Pressure Coefficients
- Natural Ventilation
- Hybrid Natural and Mechanical Ventilation
- Window Opening for Natural Ventilation Controllable
- Multi-zone Airflow (via Pressure Network Model)

It was interesting to note that only two programs, TAS and IES <VE>, both popularly used in Europe, were rated as having these capabilities available and in common use.

2.1.2.4 Lessons Learned from Case Studies of Six High-Performance Buildings

Authors: P. Torcellini, S. Pless, M. Deru, B. Griffith, N. Long, and R. Judkoff

Date: June 2006

This report was produced for the U. S. Department of Energy's Office of Building Technologies in June 2006 to identify lessons learned from studying six high-performance buildings and

ultimately to guide future research on commercial buildings to meet DOE’s goal of marketable zero energy buildings by 2025. Four of the six buildings were designed to use natural ventilation or mixed-mode ventilation. A brief description of the buildings is provided in Table 2.1.

Table 2.1: Chief Characteristics of Buildings in Torcellini et al. (2006)

Name	Abbreviated Name	Location	Type	Natural Ventilation Design?	Mechanical Cooling Used?
The Adam Joseph Lewis Center for Environmental Studies, Oberlin College	Oberlin	Oberlin, Ohio	Classroom & laboratory	Yes	Yes
The Visitor Center at Zion National Park	Zion	Springdale, Utah	Visitor center	Yes	No
The Cambria Department of Environmental Protection Office Building	Cambria	Edensburg, Pennsylvania	Office building	No	Yes
The Phillip Merrill Environmental Center, Chesapeake Bay Foundation	CBF	Annapolis, Maryland	Office building	Yes	Yes
The Thermal Test Facility, National Renewable Energy Laboratory	TTF	Golden, Colorado	Offices & laboratory	No	Yes
The BigHorn Home Improvement Center	BigHorn	Silverthorne, Colorado	Retail and warehouse	Yes	No

After evaluating these buildings, the National Renewable Energy Laboratory (NREL) recommended the following best practices for natural ventilation systems:

1. *Design natural ventilation to rely primarily on stack effect unless wind direction and speeds are reliable.*

This recommendation is based on the CBF building that was designed to take advantage of prevailing winds from one direction. In reality, the winds in this location frequently varied in direction and limited the functionality of the system. The natural ventilation systems designed for Oberlin and Bighorn were primarily stack driven and were seen to perform better than the CBF natural ventilation system.

2. *Separate natural ventilation supply and relief from the fenestration and use relief dampers for the passive ventilation.*

This recommendation also considers the negative impacts that the enlarged frames for operable windows and their associated screens have on daylighting. Therefore it is recommended that the natural ventilation supply and relief be separated from the façade. It

is further recommended that typical HVAC control dampers be used in-place of motorized windows or manual windows due to their improved ability to interface with the mechanical controls system and their observed increased robustness over motorized window actuators.

Also, there were complications with the interface between operable windows and the mechanical controls system in all buildings studied. Even with motorized windows, the actuators were prone to failure - limiting the natural ventilation system.

3. *Use automatic supply and relief controls that do not rely on occupant interaction.*

Occupants did not consistently operate manual windows in the buildings studied. Signage that illuminated "Open Windows" was used in the CBF building to inform occupants that conditions were appropriate to open the manually operated windows, but they were ineffective. The height of the windows, security concerns, and lack of interest from the occupants were speculated as potential causes for windows being left unopened.

4. *Minimize use of enclosed spaces.*

The placement of internal partitions or other obstructions may prohibit airflow and reduce the effectiveness of the natural ventilation system. This must be carefully considered.

5. *Do not use natural ventilation systems as a replacement for conventional economizers.*

Compared to a conventional economizer, natural ventilation has the potential to save fan energy. However, a study of the hybrid natural ventilation system at CBF which required the assistance of an exhaust fan, potentially used more energy than a conventional economizer might have used. This conclusion was drawn based on measured data that showed that the hybrid natural ventilation system was unable to provide ample cooling during the winter months, which caused a heat pump system to run to provide cooling. This occurred during times when outdoor air conditions were favorable for a conventional economizer to provide "free cooling". Other advantages of a conventional economizer over natural ventilation, such as distributed supply air to provide more uniform comfort and reduce drafts are also cited.

NREL was directly involved in the design process of three of the six buildings studied (BigHorn, TTF, and Zion).

2.1.2.5 CoolVent: A Multizone Airflow and Thermal Analysis Simulator for Natural Ventilation in Buildings

Authors: Maria-Alejandra Menchaca-B. and Leon Glicksman

Date: August 2008

CoolVent is currently under development as a simple natural ventilation tool to assist architects at the early design stages. CoolVent couples multi-zone airflow and thermal analysis to predict zone temperatures and airflow rates. To simplify user inputs, and to save the user time, it utilizes four pre-defined building types: single-sided ventilation, cross ventilation, central atrium ventilation, and side atrium ventilation. The user is then able to specify the following building parameters:

- Building type and orientation
- Occupancy heat loads and initial temperature
- Terrain information
- Weather conditions (TMY2 data for ten pre-defined cities only)
- Building Dimensions
- Glazing properties and opening dimensions
- Thermal mass description
- Window control strategies

Once set up, the simulation takes less than a minute to run. The simulation provides zone temperatures and airflows. These are presented to the user in three formats: visualization, data plots, or text file.

Menchaca-B. and Glicksman acknowledge the importance of adding the following features to the CoolVent program in future work:

- Air stratification within zones
- Closed plan configurations
- Internal radiative heat transfer
- Solar heat loads through roof openings
- Use of thermal mass for night cooling
- Differentiation in openings of different floors (e.g. entry doors)
- Energy consumption information for buildings modeled with natural ventilation; and a comparison against those without natural ventilation
- Usability tests of the software's interface to ensure adoption of the software by the design community

The CoolVent tool is not available for public use at this time.

2.1.2.6 Finding the Right Mix – Mixed Mode Ventilation

Author: Erin McConahey

Published: ASHRAE Journal, September 2008

A standard feasibility assessment for natural ventilation systems does not exist in the U.S. at this time. However, recommendations on procedures for assessing a building's potential have been proposed. In her article, *Mixed Mode Ventilation - Finding the Right Mix* published in the September 2008 ASHRAE Journal, Erin McConahey, proposes a "top ten" list of questions that must be affirmed before pursuing natural ventilation, provided below in Table 2.2.

Table 2.2: Feasibility Checklist from McConahey (2008)

Natural Ventilation Top 10 Feasibility Questions	
Data to Review	Question to be Asked (If Answer is Yes, Move to Next Question)
1. Building Envelope	Is the building envelope performance optimized to minimize solar gain into the building? Target a maximum total solar load of 4 W/ft ² of sun patch floor area in a cooling condition.
2. Internal Heat Loads	Is the total internal heat load minimized to less than 2 W/ft ² for naturally conditioned space or, within the cooling capacity of auxiliary systems?
3. Weather Normals: Mean Maximum/ Mean Minimum	In looking at the climate data monthly mean maximum and mean minimum, are there at least six months where the monthly maximum is less than 80°F but mean minimum is higher than 32°F?
4. Frequency of Occurrence Psychrometric Chart	In further looking at climate data, does the frequency of occurrence psychrometric chart for occupied hours have more than 30% of the time between 60°F to 80°F and less than 70% relative humidity?
5. Ambient Environment, Possible Locations of Openings	Is the surrounding environment suitable for direct intake of air from outside? (i.e., there are no security concerns, the ambient environment is sufficiently quiet, air quality meets Standard 62.1 standards, openings are not near street level, near highways, or industrial plants, or at elevation of a neighbor's discharge.)
Data to Review	Question to be Asked (If Answer is Yes, Move to Next Question)
6. Window Locations and Sizes, Accessibility	Can the equivalent of 4% to 5% of the floor area as window opening area be found with direct access to the window by everyone within 20 ft.?
7. Wind Rose, Feasible Flow Paths: Inlet to Outlet Under All Wind Conditions	Can one rely on wind-driven effects for cooling? Is there a direct low-pressure airflow path from a low-level opening to a high-level opening within the space, and will it be preserved once furniture/TI work is complete?
8. High Afternoon Temperatures	Does the climate have regular outside air temperatures over 80°F? If yes, review whether exposed thermal mass is possible.
9. Diurnal Range on Hot Days	Does the climate have a diurnal range that has nighttime temperatures below 65°F for at least 8 hours a night on the worst-case days? If yes, move to multi-zone modeling of thermal mass and

Natural Ventilation Top 10 Feasibility Questions	
	consider night purge.
10. Dew-Point Temperatures Throughout Year	Throughout the year, do you have consistent outside air dew points throughout the year of less than 64°F? If yes, move to multi-zone modeling and consider a radiant cooling system.

The Top 10 list identifies important questions that must be addressed early-on and provides rules of thumb to guide the designer. This list is not meant to be all inclusive, but rather a minimum starting point of key things to consider.

2.1.2.7 Assess and Implement Natural and Hybrid Ventilation Models in Whole- Building Energy Simulations

Authors: John Zhai, Moncef Krarti, Mary-Hall Johnson

Date: June 2010

This work addressed the current state of natural ventilation research, natural and hybrid ventilation models and simulation tools, and compared both laboratory and field data sets against simulation modeling results. Useful questions for the aims of this paper were posed and answered, including:

- Are any current models and tools good enough for modeling buildings with natural and hybrid ventilation designs? If not, what are major problems with these models? If yes, which models?
- Are there any most promising models that can be further improved and developed? How can these models be refined?
 - Atrium Ventilation
 - Horizontal Openings
 - Thermal Mass
- What are the primary challenges in modeling natural/hybrid ventilation buildings?
- Are current available experimental data sufficient for model validation and development? If not, what other key experiment results will be needed?

EnergyPlus was the primary tool investigated in this study. It was found to perform excellently for a building with a simple geometry and venting control scheme.

2.1.2.8 Building Energy Software Tools Directory

U.S. Department of Energy (DOE) – Energy Efficiency & Renewable Energy Website

Link to directory: http://apps1.eere.energy.gov/buildings/tools_directory/

Date: June 2011

The Building Energy Software Tools Directory provides an extensive list of available software tools for evaluating building systems and energy use. With new developments being made constantly, it can be challenging to keep current with the latest software and modeling programs. The Building Energy Software Tools Directory is a searchable website maintained by the U.S. DOE, on their Energy Efficiency & Renewable Energy website. This directory can be used to help building designers filter through available tools. In its state as this was written,

This directory provides information on 395 building software tools for evaluating energy efficiency, renewable energy, and sustainability in buildings. The energy tools listed in this directory include databases, spreadsheets, component and systems analyses, and whole-building energy performance simulation programs. A short description is provided for each tool along with other information including expertise required, users, audience, input, output, computer platforms, programming language, strengths, weaknesses, technical contact, and availability.

Contact details at the bottom of each tool's general description page provide the user the opportunity for further, more in-depth information if desired.

The way in which this website lists some software could potentially cause some confusion for new users. For example, IES Virtual Environment is not listed as a tool. Instead, the thermal design and energy simulation component of IES, Apache, is listed. If a user were to scan the alphabetical list of available tools looking for IES, they would not find it. However, the site is searchable and since IES is mentioned in the description of Apache, the information could eventually be attained by the user.

2.1.3 Interviews/Natural Ventilation by Region

Design professionals identified as having commercial natural ventilation design experience were interviewed in order to help determine what building types are typically being targeted for natural ventilation, the differences between natural and mechanically ventilated design processes and how the local codes treat natural ventilation differently from mechanical ventilation. In addition to their experience with natural ventilation systems in commercial buildings the design professionals interviewed were selected based on their location in order to provide a regional sampling from California, other locations within the United States, the United Kingdom and Australia.

Interviewees were asked about their natural and mixed mode ventilation design experience, how commonly natural ventilation was used in commercial buildings in their region, which design tools they used specifically for natural and mixed mode ventilation, how the local codes impact the design and if there were any consistent barriers or obstacles that limit or restrict implementing natural ventilation systems.

2.1.3.1 Application by Region

Mixed mode ventilation systems are more common than natural ventilation in commercial buildings as ventilation is also required during heating mode. It is more common to find mixed mode ventilation systems applied to commercial buildings in the United Kingdom and parts of Europe than in the United States. However, although mixed mode ventilation may be more common in the UK and Europe, it is still not widely used in commercial buildings. In the UK,

mixed mode ventilation is more prevalent due to a more favorable climate, higher energy costs and a cultural acceptance of higher indoor design temperatures, up to 28°Celsius / 82°Fahrenheit.

2.1.3.2 Design Tools

Additional and more complicated analysis is required for the design of natural or mixed mode ventilation systems than what would normally be required for a standard mechanically ventilated design. Additional modeling is required in order to properly size and locate window openings, account for stack and wind ventilation, determine energy savings, life cycle cost paybacks and unmet cooling hours. Currently there is not one software package that can provide all of the calculations required for a proper natural or mixed mode ventilation design, however combining the outputs of a few separate programs can provide the necessary design outputs. The relevant design tools are described further in Section 2.1.5, *Available Tools*.

2.1.3.3 Codes

In the United States, the International Mechanical Code and the Uniform Mechanical Code provide requirements for natural ventilation. In the United Kingdom, two application manuals, AM 10 Natural Ventilation for Non Domestic Buildings and AM 13 Mixed Mode Ventilation, provide recommendations for natural ventilation. In Australia, Part F4 of the Australian Building Code provides the requirements for natural ventilation. The Australian and American codes are similar, providing prescriptive requirements for façade openings, while the UK application manuals provide design recommendations, best practices and requirements of operating hours not to exceed specific temperatures. The natural ventilation requirements from these codes are described further in Section 2.1.4, *Code Requirements and Design Standards*.

2.1.3.4 Barriers and Obstacles

The interviewees have identified many factors that can prevent the application of natural or mixed mode ventilation including:

- Climate
- Cost
- Aesthetics / façade heat gain minimization
- Owner / occupant acceptance of a higher indoor temperatures
- Sound / Acoustics
- Maintenance / Controls
- Security
- Local Authorities
- Adjacency issues
- Air Quality

Of the design barriers identified, climate and cost were generally the easiest to address, as temperate climates will better support natural ventilation and the costs associated with additional hardware for operable windows and controls are real costs. Building aesthetics focused primarily on the architect and owner's buy off on the natural ventilation strategy. In order for natural ventilation to be applied, the internal heat gains need to be reduced and a big part of the internal gains occurs at the façade. Reducing the heat gains through the façade require that the glazing is reduced, or in the right areas, and that shading is provided and often the architect / owner has not incorporated these into the building aesthetics. The last major barrier identified across the regions was the reluctance of owners and occupants to accept higher indoor design temperatures associated with natural ventilation. To realize energy savings and maximize hours of natural ventilation design practices in the United Kingdom accept a higher range of acceptable interior design temperatures along with an acceptable percentage of hours outside of this range. Building owners in the United States may be unwilling to accept this higher range as it could result in hot service calls due to occupants not being used to the slightly higher space temperatures. These barriers to natural ventilation design are described further in Section 2.1.7, *Barriers*.

2.1.4 Code Requirements/Design Standards

Building codes establish the set of rules required to meet the minimum acceptable safety levels that building designers must comply with during design and construction. Building codes are provided to protect public health and safety in relation to building construction and operation, and are often considered law when adopted by the State, Local Municipality or other AHJ's. Building codes vary by region, City, State or Country and are influenced by many factors, including energy use, available resources, local climatic conditions, seismic activity, etc. Building codes are typically separated by discipline, and the portions related to natural ventilation typically fall under the mechanical code sections. The following is a summary of the codes sections relevant to natural ventilation across various regions including the United States, the United Kingdom and Australia.

1. International Mechanical Code (IMC) / Universal Mechanical Code (UMC) /

The IMC is the most popular mechanical code adopted and used in the United States. Chapter 4 of the IMC addresses ventilation and provides requirements for both natural and mechanical ventilation. Under natural ventilation, the minimum required area of operable window is based on building area being ventilated. The minimum operable area to the outdoors shall be 4 percent of the floor area being ventilated. Adjoining spaces without direct access to the outdoors must be provided with an unobstructed opening to an exterior space, sized at 8 percent of the floor area of the interior space, but not less than 25 square feet. Operable openings shall be readily accessible to building occupants whenever the space is occupied.

The UMC includes the same natural and mechanical ventilation requirements as the IMC but further requires that naturally ventilated spaces are located within twenty-five (25) feet (7.6 m) of operable wall or roof openings to the outdoors. The California Mechanical Code is based on the UMC.

2. California Building Energy Efficiency Standards for Nonresidential Buildings 2008, Title 24

The California Energy Efficiency Standards for Nonresidential Buildings were established to reduce energy consumption. The standards are adopted by the California Code of Regulations (CCR) and updated periodically to allow consideration and possible incorporation of new energy efficiency technologies and methods. The CCR is divided into 28 titles by subject, with Title 24 reserved for state regulations that govern the design and construction of buildings, including the Energy Efficiency Standards. These standards are commonly referred to as Title 24. Title 24 requires that naturally ventilated spaces shall be permanently open to and within 20 feet (6 m) of operable wall or roof openings to the outdoors, the openable area of which is not less than 5 percent of the conditioned floor area of the naturally ventilated space. Exceptions are included for high rise residential and hotel/motel occupancies.

Compliance with Title 24 energy efficiency standards is documented by using state approved software programs, Perform 2008 or EnergyPro, adding another step in the design process for buildings in California. These software program capabilities are discussed further in Section 2.1.5.3.

3. Chartered Institution of Building Services Engineers (CIBSE)

Applications Manual AM10 – Natural Ventilation for Non Domestic Buildings

The CIBSE Applications Manual AM10 – Natural Ventilation for Non Domestic Buildings is the main guidance used in the UK. The criteria for design is to not exceed 82°F (28°C) for more than 1% annual occupied hours, based on an ideal summer design temperature of 25±3°C (77±5°F). Unlike the IMC, there is no minimum openable window area requirement; rather the application manual provides design guidance and strategies to apply in order to meet the maximum overheating hours requirement. Compliance is documented through energy modeling software. Modeling software used in the UK, e.g. IES, can perform the calculation methodology described in AM10 to simulate the window openings, overheating, etc.

4. Chartered Institution of Building Services Engineers (CIBSE)

Applications Manual AM13 – Mixed Mode Ventilation

The CIBSE Applications Manual AM13 – Mixed Mode Ventilation provides guidance for combined natural and mechanical ventilation systems used in the UK. This application manual describes the advantage and disadvantages of mixed mode ventilation and provides recommendations on zoning and control strategies and provides recommendation on modeling techniques and thermal comfort issues.

5. Building Code of Australia – Part F4 Light and Ventilation

Part F4 Light and Ventilation of the Building Code of Australia provides the requirements for natural light and natural ventilation. The prescriptive requirements are similar to the IMC requirements for minimum openable area based on floor area being ventilated. The

total minimum opening or openable size shall not be less than 5% of the floor area of the room required to be ventilated. For ventilation borrowed from adjoining rooms, the window, opening, door or other device has a ventilating area of not less than 10% of the floor area of the room to be ventilated, measured not more than 3.6 m (11.8 ft.) above the floor and the adjoining room has a window, opening, door or other device with a ventilating area of not less than 10% of the combined floor areas of both rooms.

6. United States Green Building Council (USGBC) Leadership in Energy and Environmental Design (LEED) rating system

The LEED rating system is a green building certification system, developed by the USGBC. LEED provides building owners and operators with a framework for identifying and implementing practical and measurable green building design, construction, operations and maintenance solutions.

USGBC has developed multiple rating systems, specific to the type of building, e.g. new construction, existing buildings, retail, schools. For new construction or major renovation, the applicable rating system would be the LEED New Construction (NC).

The LEED rating systems are not a design guide and do not provide criteria for natural ventilation, however it does reference ASHRAE Standards and CIBSE Application Manuals that provide design criteria for natural ventilation. The LEED NC rating system contains prerequisites and credits in the Environmental Quality (EQ) section and credits under the Energy and Atmosphere (EA) section that could potentially be achieved by utilizing a natural or mixed mode ventilation strategy, including:

- EQ Prerequisite 1 – Minimum IAQ Compliance
- EQ Credit 1 – Outdoor Air Delivery Monitoring
- EQ Credit 2 – Increased Ventilation
- EQ Credit 6.2 – Thermal Comfort, Controllability of Systems
- EQ Credit 7.1 – Thermal Comfort, Design
- EA Credit 1- Optimize Energy Performance

The LEED for Existing Buildings (EB) rating system was created to certify the sustainability of ongoing operations of existing commercial and institutional buildings. The LEED EB rating system encourages owners and operators of existing buildings to implement sustainable practices and reduce the environmental impacts of their building operations, over the life of the building. Similar to the LEED NC rating system, there are credits that can be achieved through natural ventilation, including:

- EQ Credit 1.3 – Increased Ventilation

7. American Society for Heating Refrigeration and Air conditioning Engineers (ASHRAE) Standard 62.1 Ventilation for Acceptable Indoor Air Quality

Standard 62.1 specifies the minimum ventilation rates and indoor air quality that will be acceptable to human occupants and minimize the potential for adverse health effects but does not address thermal comfort. For naturally ventilated spaces, Standard 62.1 provides requirements for minimum openable areas and maximum distances from openable areas (25 ft.) similar to the UMC requirements. In addition to the UMC requirements, Standard 62.1 requires local user control / access to openable windows/roofs and specifies minimum separation distances between air intakes and potential contamination sources. The 2010 update of Standard 62.1 added new requirements, including a requirement that natural ventilation systems be combined with mechanical ventilation systems, with a few exceptions. Also added are limitations on floor areas that can be naturally ventilated based on the ceiling height and three ventilation configurations: single sided, double sided and corner openings.

8. American Society for Heating Refrigeration and Air conditioning Engineers

(ASHRAE) Standard 55 Thermal Environmental Conditions for Human Occupancy

Standard 55 identifies the factors of thermal comfort and the process for developing comfort criteria for a building space and the occupants of that space. Standard 55 considers combinations of different personal and environmental indoor space factors that will result in thermal environmental conditions that are acceptable to at least 80% of the occupants. Personal factors include clothing and activity level, and environmental factors include humidity, temperature, thermal radiation and air speed at steady state conditions. For naturally ventilated spaces, Standard 55 provides a broader range of acceptable indoor air temperatures based on monthly outdoor temperatures. This broader range of acceptable indoor temperatures is based on field experiments that demonstrate different thermal responses for naturally ventilated spaces than mechanically cooled spaces due to different thermal experiences, occupant perception, local control and accessibility. While Standard 55 assumes steady state conditions, it is very rare to encounter steady state conditions in real buildings. In naturally ventilated buildings occupants can better adapt to a higher temperature or larger range of acceptable temperatures by having access to operable window controls and by being able to react to the changing conditions.

9. General Services Administration (GSA)

The Facilities Standards for the Public Buildings Service (PBS) PBS-P100 document establishes design standards and criteria for new buildings, major and minor alterations, and work in historic structures for the Public Buildings Service of the General Services Administration.

This document applies to all new facilities or alterations of GSA owned, or lease construction with Government Option to Purchase buildings. The PBS-P100 Facilities Standards contains policy and technical criteria to be used in the programming, design, and documentation of GSA buildings. The Facilities Standards is a building standard: it is not a guideline, textbook, handbook, training manual or substitute for the technical competence expected of a design or construction professional. The Facilities Standards shall be used in

conjunction with the specific building program for each project, which delineates all project information, such as number and sizes of building spaces, and requirements for mechanical, electrical and other operating systems. It is imperative that each building be designed so that all components comprise an integrated solution, so that operation of the facility, energy usage and other criteria may be maximized.

While the PBS-P100 document does not specifically address natural ventilation, it does require that outdoor air ventilation rates of ASHRAE Standard 62 are the minimum acceptable in GSA buildings. In addition, the PBS-P100 includes 100-percent outdoor air ventilation systems (DOAVS) sized to meet both the ventilation and pressurization requirements of the building as part of the building baseline mechanical systems.

The PBS-P100 provisions are not intended to prohibit the use of alternative HVAC systems or ventilation methods that are not specifically prescribed, provided that the GSA has approved such alternatives and that the proposed alternative design is at least equivalent or superior to the prescribed requirements in this document with regard to quality, strength, effectiveness, fire resistance, durability, and safety.

2.1.5 Available Tools

Natural ventilation is a simple concept. Pressure differences between the outside and inside of a building, caused by wind and/or buoyancy effects, drive air through openings in the building façade. Although the concept is simple, designing a well performing natural ventilation system is a complex process that requires special tools.

Codes and Standards define minimum conditions that must be met to maintain comfortable and healthy indoor environments. In a traditional, mechanically ventilated and air-conditioned building, occupied spaces are decoupled from the uncontrolled exterior environment with a sealed façade. Engineers are then able to use mechanical HVAC systems to condition the interior spaces. As long as the HVAC systems are designed for the worst case, variations in the exterior environment do not affect the comfort and health of building occupants. Naturally ventilated buildings remove the controlled separation between outside and inside; adding a number of new variables to consider during design. The decreased level of control and the additional design variables make natural ventilation systems inherently more difficult to design.

Designers must consider many factors when proposing natural ventilation that are not as critical in sealed buildings. Architects and engineers need to consider how the location, shape, orientation, façade, programming, air intake and extract locations, airflow paths, and other aspects of the building will affect the performance of the natural ventilation system and select the appropriate design software and tools to complete the required analysis.

Currently, no one tool is able to provide all of the necessary information to properly evaluate a natural ventilation system from start to finish. Instead a selection of tools is used; each for a given purpose. The design community, comprised of researchers, software developers, equipment manufacturers, professional societies such as ASHRAE, and design professionals themselves have developed a number of tools to aid in the optimization of natural ventilation

systems. These tools vary greatly in complexity; from hand calculation methods to computer models that solve simultaneous differential equations and display the results in graphical form. The level of user skill and expertise required to use each tool increases with complexity. Furthermore, tools are case-specific based on the level of design completion. Selecting the correct tool can depend on many factors: How much detailed information is known about the variables; can general assumptions be used? How much time is available to complete the analysis? What are the key aspects that must be considered in the analysis so that the results maintain a necessary level of accuracy? Who is performing the analysis? The ultimate goal is to efficiently analyze the key aspects in enough detail to produce results that are sufficient to inform design decisions.

Tools used to design naturally ventilated buildings can be organized into the following categories based on the design aspect for which they are used:

- *Feasibility Assessment Tools* – Is the building a good candidate for natural ventilation?
- *Design & Analysis Tools* – How will the natural ventilation system perform from a ventilation and thermal comfort perspective?
- *Whole Building Energy Simulation Tools* – How much energy will the naturally ventilated building save over a mechanically ventilated building?

The following sections will describe tools available to help evaluate feasibility, performance, and energy savings of natural ventilation systems. Capabilities and weaknesses will be identified.

2.1.5.1 Feasibility Assessment Tools

Natural ventilation will not work for every commercial building. An evaluation must take place early on to assess natural ventilation feasibility. From the conceptual stage of design, factors such as the building form, orientation, location/climate, envelope, and anticipated internal loads must be evaluated to determine if natural ventilation can adequately maintain indoor thermal comfort and indoor air quality requirements.

2.1.5.2 Climate Suitability Tool

A plan to develop a tool that could determine the potential for natural ventilation systems by evaluating climate suitability was presented by NIST in their report, *Natural Ventilation Review and Plan for Design and Analysis Tools*, in 2001. The *Climate Suitability Tool*, released in May 2011 by NIST, evaluates whether a local climate is suitable for natural ventilation or a hybrid (mixed mode) system.²

Climate Suitability Tool is free, web-based software that uses a single-zone model of natural ventilation heat transfer in commercial buildings. The following information about the building is specified by the user: internal heat gains, area, minimum ventilation rates, limiting outdoor

² “New software tool helps evaluate natural cooling options for buildings,” http://www.nist.gov/el/building_environment/20110524_climate_tool.cfm

dew point temperature, ceiling height, cooling setpoint, heating setpoint and times for when night cooling calculations should be expected to operate. A standard weather file is then selected that describes the local climate. The tool can read weather files in the formats: TMY2, TMY3, and EPW. Links to libraries of these files for different geographical locations are provided, but any location can be used so long as the user can obtain a supported weather file. Once the appropriate weather file and building information has been specified by the user, the program uses an algorithm that analyses the hourly weather data and user specified set points to determine the percent of the time that natural ventilation is effective. The program also considers adaptive setpoints that vary in the acceptability based on ASHRAE Standard 55 Thermal Environmental Conditions for Human Occupancy.³

The *Climate Suitability Tool* presents results for both *direct cooling* and *night cooling* potential. *Direct cooling* is defined as, “the cooling of building interiors by replacing or diluting warm indoor air with cooler outdoor air when conditions are favorable”. *Night cooling* is defined as, “indirectly cooling building interiors by pre-cooling thermally massive components of the building fabric or a thermal storage system with cool nighttime outdoor air” (see footnote [4]). For the direct cooling analysis, the tool tells the user how much ventilation is required to sufficiently cool the space and the percentage of hours that natural ventilation can be effective. It also provided the percentage of hours that natural ventilation alone will result in a space that is potentially too cold, too hot, or too humid. For the night cooling analysis, the tool tells the user the average internal gain that may be offset from pre-charging the thermal mass the night before. It also tells the user the number of days that night cooling is required and how effective it is in meeting the cooling demands of the following day.

Key environmental design considerations not accounted for in the Climate Suitability Tool include solar gain at the façade and wind direction (building orientation is not specified in the inputs). A follow-up paper from NIST seems to suggest that solar gains can be accounted for by adding them to the internal loads input (Axley *et al.*, 2002b). This assumes that the solar load is distributed evenly across the floor plate, which seems potentially problematic for all cases. Also, the orientation of the building is not specified. As this tool is only intended to assess the potential of a particular climate, it is assumed that the tool is calculating the wind pressure coefficients for the optimum case where the building is oriented to take full advantage of available prevailing winds.

2.1.5.3 Design and Analysis Tools

Chapter 13, *Indoor Environmental Modeling*, of the 2013 ASHRAE Fundamentals Handbook presents two common indoor environmental modeling methods: CFD and multi-zone network airflow modeling. ASHRAE provides the mathematical background, practical modeling advice, model validation, and application examples for both methods. Both methods have strengths and weaknesses.

³ “NIST multizone modeling website – Climate Suitability Tool: Determining suitability of natural ventilation,” <http://www.bfrl.nist.gov/IAQanalysis/software/CSTdesc.htm>

2.1.5.4 Loop Design and Analysis (LoopDA)

LoopDA is a software tool developed by NIST that implements the Loop Equation Design Method of sizing openings in naturally ventilated buildings. This tool has been integrated into the multi-zone airflow model, CONTAM.

The Loop Equation Design Method consists of eight steps. The following describes how LoopDA guides users through the eight steps:⁴

1. LoopDA provides a SketchPad interface that enables you to draw a schematic representation of the global geometry and multi-zone topology of the building and to draw the natural ventilation flow loops through the relevant airflow paths of the building.
2. The SketchPad provides the ambient pressure node and keeps track of the pressure nodes associated with each of the airflow paths that you identify on the SketchPad. The direction of the loops establishes the intended direction of natural ventilation airflow for the purposes of design.
3. LoopDA provides for the establishment of design conditions by allowing full control in setting ambient conditions of temperature, wind speed and direction. It also enables the design temperatures of all airflow paths to be set and automatically calculates the air densities of each. The program also provides a means to input the wind pressure coefficient of all exterior openings.
4. LoopDA provides a means to define the first-order design criteria for each airflow path to be sized, however, it is up to you to select the design criteria and to ensure that continuity is not violated in the event that an opening serves multiple flow loops.
5. Once the geometry, design conditions and criteria are specified and the flow/pressure loops are established, LoopDA will form the forward loop equations for each loop by traversing the loop in the established direction and accounting for pressure changes due to the pressure/flow relationships of the various flow components, wind and stack effects.
6. LoopDA calculates the minimum feasible sizes of each unsized flow component in a loop by evaluating asymptotic limits of the loop equation for the design conditions.
7. LoopDA provides the ability to export loop information to a spreadsheet template (provided with the program) that displays all the data associated with a given loop, generates asymptotic plots and thus provides a means to view relationships between the flow components of a loop. This aids the application of design constraints, selection of component sizes and documentation of the steps in designing the natural ventilation airflow paths.

⁴ "NIST multizone modeling website – LoopDA: Natural ventilation opening sizing tool," <http://www.bfrl.nist.gov/IAQanalysis/software/LOOPDAdesc.htm>

8. Having sized the natural ventilation airflow, LoopDA can be used to analyze the building performance under varying conditions. LoopDA implements the established multi-zone building simulation capabilities of CONTAMW 2.0, and permits further analysis to investigate the effects of unintentional air infiltration, non-design weather conditions, and forced-flow elements to simulate hybrid ventilation systems.

LoopDA can account for both wind and stack effects to help designers to size flow components, evaluate the natural ventilation system performance under varying conditions, and evaluate hybrid ventilation systems. One complexity of this tool is the user required input of wind pressure coefficients for all of the exterior openings. These may be difficult to establish, especially early in design.

Once the natural ventilation system airflow strategy has been defined using LoopDA, CONTAM can be linked to the thermal analysis tool TRNSYS to complete coupled thermal and airflow analysis. This dynamic model can then be analyzed to evaluate annual energy savings due to the implementation of natural ventilation. This linking process is discussed further in the *Whole Building Energy Simulation Tools* section below.

2.1.5.5 COMFEN

The Commercial Fenestration (COMFEN) tool was developed by Lawrence Berkeley National Laboratory (LBNL) to help designers quickly assess different façade options. COMFEN allows users to compare up to four different façade types at once and to quantify their impacts on energy use, electric demand, and thermal and visual comfort. The program contains libraries of different geographic locations, glazing systems, and shading control schemes. The software uses the EnergyPlus simulation engine to perform calculations.⁵

The simulation calculates solar loads on the space as a result of the façade construction. This information helps designers minimize unwanted solar gain through the façade; a key design feature for successful natural ventilation systems (McConahey, 2008).

LBNL is currently developing a single zone natural ventilation simulation within COMFEN, again by harnessing the capabilities of EnergyPlus.

2.1.5.6 Whole Building Energy Simulation Tools

Whole building energy simulation software is used to estimate the total annual energy that a building will consume. These tools are used to help designers evaluate different options and consider the energy implications of each. For an energy simulation tool to account accurately for energy savings due to natural ventilation, it must be able to take the airflow information developed in the design and analysis tools and add to it controls sequences, thermal conditions of the spaces, and dynamic simulations that account for a typical year of weather conditions. Control sequences are further complicated for mixed mode systems. Not all of the commonly used energy simulation tools are able to incorporate this level of airflow information. The tools

⁵ "High performance building façade solutions – commercial fenestration (COMFEN) early schematic design tool," <http://lowenergyfacades.lbl.gov/tools.html#comfen>

EnergyPlus, IES < Virtual Environment >, and CONTAM interlinked with TRNSYS are some of the leading software that are being developed to accurately model the energy savings potential of complex natural ventilation and mixed mode systems.

One major gap in available tools for California is Title 24 approved software that can account for natural ventilation energy savings. Based on the 2008 Title 24 regulations, there are only two approved software packages that include all Alternative Calculation Methods approved by the California Energy Commission: Perform 2008 and EnergyPro 5.0 and 5.1. Neither of these software packages can model natural ventilation systems. This adds another level of additional analysis that designers of natural ventilation systems in California must address when considering natural ventilation.

This section will look at the following commonly used whole building energy simulation tools and how they account for natural ventilation: eQUEST, EnergyPlus, TRNSYS, IES <VE>, and Trane TRACE 700.

2.1.5.7 eQUEST®

eQUEST® is one of the most widely used whole building energy simulation tools. It uses the time-proven and well known simulation engine, DOE-2.2. Unfortunately, the natural ventilation systems are limited to single zone analysis; flows between zones (e.g. from perimeter to interior zones) are not analyzed. Another limitation of modeling natural ventilation in eQUEST® is the selection of mechanical systems that can be used to supplement zones with natural ventilation. Only single duct systems can be specified as the supplemental mechanical system and hybrid ventilation is not possible due to the natural ventilation controls strategy.

This software handles natural ventilation as an extension of the infiltration calculation. This can be done in two ways. The user can either specify the air changes per hour (ACH) or eQUEST can apply the Sherman-Grimsrud residential infiltration methodology to determine the ACH based on wind speed, temperature difference between inside and outside, and wind shielding from surrounding terrain. Natural ventilation is controlled by specifying a minimum room temperature schedule. This prevents natural ventilation from occurring when outdoor conditions are too cold. When conditions are favorable for cooling with natural ventilation, windows open. Once the natural ventilation can no longer provide cooling, the mechanical system turns on and the windows close. Additional levels of control can be added in the form of schedules that account for the probability of windows being open. For example, if a favorable temperature occurs in the middle of the night, but the windows are manual control only, and no one is there to open them, a schedule can prevent the windows from opening.

2.1.5.8 EnergyPlus

EnergyPlus is a next generation building energy simulation program that combines the most popular features and capabilities of BLAST and DOE-2.^{6,7} This simulation engine is capable of

⁶ The Building Loads Analysis and System Thermodynamics (BLAST) tool is a comprehensive set of programs for predicting energy consumption, performance, and cost in buildings. It was developed by the U.S. Army Construction Engineering Research Laboratory and the University of Illinois (Crawley *et al.*, 2005).

producing accurate, detailed simulations and has been extensively tested. Its input and output files easily facilitate third party interface development. The text format of the inputs is considered its major weakness. To remedy this, work is being done to develop a more user-friendly graphical interface.

EnergyPlus has the ability to model both single zone and multi-zone airflow networks. It uses a pressure model similar to CONTAM. Recently, it has also added the ability to model two nodes per zone for evaluating wind-driven cross ventilation and underfloor air distribution systems, as well as three nodes per zone for evaluating mechanical displacement ventilation systems. This development should help to better model the stratification that occurs within the spaces that use these systems. Mixed mode simulation is possible but is currently limited to constant-volume mechanical systems. Controls can be added to system components such as windows and the hybrid ventilation system. The detailed simulation software is powerful, but requires a significant amount of user input. Some examples of detailed capabilities that require special user attention are thermal comfort schedules, flow coefficients at openings, and hybrid ventilation control. These examples were presented by Michael J. Witte at the ASHRAE Energy Modeling Conference in April 2011.

2.1.5.9 TRaNsient SYstem Simulation Program (TRNSYS)

TRNSYS is an energy simulation program that uses a modular approach and is flexible to use. TRNSYS can be linked to CONTAM or COMIS to form a tool that can perform both thermal and air flow analysis. This link allows the two software packages to speak back and forth dynamically. For example, if a control sequence is set up in TRNSYS to open and close windows for specific conditions, this information will also feed into CONTAM to modify the airflow calculation for that particular time. Key strengths of TRNSYS include extensive documentation to help guide the user, its openness to interface with other software packages, including the CFD program FLUENT, and a user-friendly graphical interface that allows for drag-and-drop components to create input files and a plugin for Google SketchUp™. Weaknesses include the amount of detailed information about the building and system that the user is required to enter into the TRNSYS interface.

2.1.5.10 IES <VE>

The design and simulation tool IES is commonly used in the UK for conducting whole building energy performance evaluations and it is becoming more popular in the US. It has built-in functions for performing natural ventilation overheating calculations as required by UK building regulations for verifying system performance.

IES has two tools built into it for analyzing natural ventilation: MacroFlo (multi-zone bulk airflow model) and MicroFlo CFD. MacroFlo has the ability to model cross ventilation, single sided, and stack driven natural ventilation. It also has the ability to develop control strategies based on simple algebraic equations to determine when to operate the natural ventilation

⁷ "Building energy software tools directory," http://apps1.eere.energy.gov/buildings/tools_directory/

system (e.g. if the outside air temperature is greater than x, open the windows). MacroFlo can be run for a full annual simulation to complete an energy performance evaluation.

2.1.5.11 Trane TRACE™ 700

Trane TRACE™ 700 is commonly used to perform building energy simulations in the U.S. This software does not explicitly model natural ventilation.

2.1.6 Leading Research

A comprehensive literature review on the current state of natural ventilation research was conducted by Dr. John Zhai at the University of Colorado, at Boulder in 2009 (Zhai *et al.*, 2010). This study found that the following research centers are highly active in hybrid and natural ventilation research:

- Aalborg University, Hybrid Ventilation Center - Denmark
- De Montfort University, Institute of Energy and Sustainable Development – UK
- Fraunhofer Institute for Solar Energy Systems – Germany
- Harbin Inst. of Technology, Inst. of Indoor Env. Science and Engineering – China
- University of Nottingham, Institute of Building Technology, - UK
- Lawrence Berkeley National Laboratory – US
- Massachusetts Inst. of Technology, Building Technology Program - US
- National Institute of Standards and Technology - US
- National Renewable Energy Laboratory - US
- National University of Singapore, Department of Buildings – Singapore
- Osaka University - Japan
- Universite de La Rochelle, LEPTAB – France
- University of Athens – Greece
- University of Cambridge, BP Institute for Multiphase Flow – UK
- University of Hong Kong – Hong Kong

An early review of the work being done by U.S. research centers on natural and hybrid ventilation revealed a common theme – natural ventilation is a relatively new practice in this country and there are a number of barriers to its acceptance. Therefore, this section focuses on the work being done in the U.S. specifically to overcome these issues.

2.1.6.1 National Institute of Standards and Technology (NIST)

NIST has conducted numerous studies on natural ventilation feasibility, available tools, design processes, and modeling validation. A paper was published in 2001 that provided a detailed description of the pros and cons of natural and hybrid ventilation versus mechanical

ventilation, available tools and their limitations, a climate suitability assessment of natural ventilation in ten cities in California, and a plan to develop both a climate suitability tool and a natural ventilation system design and analysis tool (LoopDA) to be integrated with the existing multi-zone airflow modeling tool, CONTAM. Since this paper was published, multiple follow-up reports have identified progress made towards tool development and model validation. These papers are summarized in Section 2.1.2, *Literature Review*.

2.1.6.2 Lawrence Berkeley National Laboratory (LBNL)

Lawrence Berkeley National Laboratory is developing tools that will allow designers to accurately simulate building energy performance. Current tools being developed include: EnergyPlus, Modelica, Building Controls Virtual Test Bed, and GenOpt®.

Advancements in EnergyPlus include the development of graphical user interface tools that make EnergyPlus more user-friendly and aim to expand its adoption by the design community, the development and application of EnergyPlus to simulate natural ventilation, and the development of another tool, COMFEN, that uses the EnergyPlus calculation engine to simulate the performance of different façade constructions.

Modelica is a, “non-proprietary, object-oriented, equation-based language to conveniently model complex physical and control systems”. The Modelica *Buildings Library*, is being developed to allow designers to quickly and easily model building energy control systems. The library contains models that include multi-zone airflow and contaminant transport that could prove to be helpful for designers evaluating natural ventilation systems.⁸

The Building Controls Virtual Test Bed software links multiple simulation tools, such as EnergyPlus and Modelica for co-simulation. It also has the ability to tie simulation tools to Building Automation Systems to facilitate the development of new control algorithms and the verification of controls sequences within the BAS to improve the commissioning process.

GenOpt® is an optimization tool that aims to reduce the amount of time required to determine optimal design parameters. It is written in Java to remain platform independent. It can be linked to analysis tools such as EnergyPlus, Modelica, TRNSYS, and others to run optimization and parametric studies.

2.1.6.3 National Renewable Energy Laboratory (NREL)

The National Renewable Energy Laboratory is also continuing to develop the EnergyPlus simulation software. The primary focus is on evaluating building controls strategies and algorithms that can be modeled in the EnergyPlus framework.⁹

⁸ “Modelica library for building energy and control systems,” <https://simulationresearch.lbl.gov/modelica>

⁹ “NREL Buildings Research – Challenges in Commercial Buildings,” <http://www.nrel.gov/buildings/commercial.html>

Currently, NREL is leading the implementation of energy management system (EMS) style controls into the EnergyPlus core engine. This project will exercise new EnergyPlus modeling capabilities to analyze the controls and algorithms within and between the various technology option sets.

Additionally, NREL has worked on the natural ventilation controls and commissioning of several natural ventilation projects. A paper that describes three of these projects is presented in Section 2.1.2, *Literature Review*.

2.1.6.4 Center for the Built Environment (CBE)

The Building Envelope Systems research area at the Center for the Built Environment is currently working on a number of projects that address potential barriers to natural ventilation systems. Much of this work is geared toward better understanding impacts to occupant comfort caused by factors such as façade and perimeter zone performance, and occupant access to operable windows. Additional work is being done to develop design recommendations for mixed mode systems that use operable windows.¹⁰

2.1.6.5 Massachusetts Institute of Technology (MIT)

Understanding Thermal Stratification in Naturally- Ventilated Buildings

Maria Alejandra Menchaca Brandan is a doctoral student working with Professor Leon Glicksman on the CoolVent software described earlier, in Section 2.1.2. CoolVent has been in development over the last decade by the Building Technology Research Group at MIT. Brandan’s work focuses on understanding air thermal stratification in a naturally ventilated room. Her goals are to be able to predict the strength of air stratification in a room, the effect that this density gradient has on the temperature of the room’s occupied zone, and the air flow in and out of each zone.¹¹

Ventilation Shaft Modeling

Stephen Ray is a Ph.D. student in the Department of Mechanical Engineering at MIT who is also working with Professor Leon Glicksman. His research aims to deepen the understanding of natural ventilation so as to ultimately improve modeling in airflow network tools used in building energy modeling software for hybrid or mixed-mode ventilation systems. Ray is specifically addressing the potentially overly-simplified assumptions made by current tools when analyzing buoyancy-driven flows, for example uniform temperature distribution assumptions in vertical ventilation ducts vs. more realistic highly stratified distributions (see footnote [12]).

¹⁰ “Research on building envelope systems – Studying the implications of façade decisions on occupant and building performance,” http://www.cbe.berkeley.edu/research/research_envelope.htm

¹¹ “Building Technology Program – Building ventilation & diagnostics,” http://bt.mit.edu/?page_id=37

2.1.6.6 University of Colorado, Boulder (CU)

HVAC Control Algorithms for Mixed-Mode Buildings

Peter May-Ostendorp is looking at control strategies for mixed-mode buildings that minimize energy consumption without compromising indoor air quality or the thermal comfort of the occupants. His research seeks to develop a control algorithm for mixed mode buildings, which:

1. Minimizes site energy consumption by means of an optimal ventilation and HVAC strategy using both low-energy energy sources such as groundwater, ground, or cool night air as well as mechanical cooling
2. Potentially reduces investment costs by downsizing installed HVAC system capacities
3. Improves occupant acceptance and reduces sick building syndrome, for AC mode only, and heat stress and uncomfortable room temperatures for natural ventilation mode only

His work is being funded by the US Green Building Council.

2.1.7 Barriers

Natural and mixed mode ventilation systems are not the standard ventilation systems for commercial buildings for much of the United States, despite having provisions in the prevailing US codes and standards that allow for the use of natural ventilation strategies. Using properly designed, implemented and operated natural ventilation strategies in appropriate climates and building types can result in reduced energy usage.

By identifying the issues that can prevent or restrict the use of natural ventilation, building designers and owners will be better prepared to address and resolve these issues. Some barriers will be more behavior dependent, such as the acceptance of higher indoor air temperatures possible with naturally ventilated systems, and their resolution will require US building occupants to adapt their comfort zone. The following barriers can prevent or restrict the application of natural or mixed mode ventilation in commercial buildings and should be considered throughout the design phase for any new building or existing building retrofit:

1. Climate/Location

Building location will play a large role in deciding if natural ventilation is an appropriate design alternative. Natural and mixed mode ventilation systems are not suited for all climates, as a hot and humid climate will have a very short natural ventilation season. A temperate climate will have a longer window when natural ventilation is effective.

2. Cost

Mixed mode ventilation requires additional costs compared to mechanically ventilated systems. These costs include the hardware for the operable windows and additional controls points to communicate with the building automation systems. Even if these costs are included in the budget at the onset, operable windows are often a target of value engineering initiatives during later design phases.

Mixed mode systems are often seen as installing two systems, mechanical and natural, where one system, mechanical, would suffice, resulting in additional unnecessary costs. If the energy and life cycle analysis for the mixed mode system does not satisfy the owner's payback criteria, it will be difficult to justify the design. There are qualitative, psychological advantages to having natural ventilation systems, including high individual controllability and improved ventilation effectiveness. If these qualitative benefits are a priority to the building owner / occupants, they might outweigh the quantitative life cycle payback results.

Natural ventilation systems that replace mechanical systems entirely are less costly to install, and, of course, offer significant life cycle savings.

3. Aesthetics/Façade Heat Gain Minimization

Operable windows have a significant impact on the building aesthetics. Getting the architect and owner's agreement on the natural ventilation strategy for operable window locations and areas early in the design phase, possibly before the engineering team is involved, is a critical step. In order for natural ventilation to be applied effectively, the internal heat gains need to be reduced and a big part of the internal gains occur at the façade. Reducing the heat gains through the façade often requires that the glazing is reduced, or repositioned, and that shading is provided. Large amounts of glass are sometimes perceived to offer aesthetic benefits as well as increased daylighting opportunities, however solar loads must be minimized with shading devices and other strategies to ensure a properly functioning natural ventilation system.

4. Owner/Occupant Acceptance of Increased Indoor Temperatures

In the UK, where mixed mode systems are more common, the building codes include higher indoor design temperatures than are typically used in the United States. ASHRAE Standard 55 includes a broader range of acceptable indoor design temperatures for naturally ventilated spaces, based on expected activity and clothing levels, outdoor air temperatures and field observations. Convincing building occupants in the US to accept a higher range of interior design temperatures along with an acceptable percentage of hours outside of this range is a difficult task, as the majority of commercial applications provide a cooler environment that is now expected. Similarly, building owners and operators in the United States may be unwilling to accept this higher temperature range as it could result in hot service calls due to occupants not being used to the slightly higher space temperatures. In order for natural ventilation systems to be more commonly accepted, building occupants and owners will need more exposure to mixed mode systems that are properly designed and that are operating correctly.

5. Maintenance/Controls

Designers need to be aware of the control strategies and maintenance requirements for mixed mode and natural ventilation systems and how they differ from standard mechanical ventilation. If the controls system is not sophisticated enough or provided with sufficient capacity to operate a mixed mode system, or adequate service space and access are not

provided to properly maintain the operable façade systems functionality, the building will not operate according to the design intent.

6. Security/Occupancy Type

Building occupancy type may prohibit the use of operable windows. Occupancy types, such as recording studios, where exposure to outdoor ambient noise levels, such as traffic, through operable windows would be detrimental to the space functionality are not suited for natural ventilation systems. Similarly, for secure installations, such as banks or government facilities, operable windows can present a security risk to the facility operation. If the natural ventilation façade components will have a negative impact to the intended building operations and required security levels, then natural or mixed mode strategies are generally not recommended.

7. Local Authorities

Local AHJ's can require that the natural ventilation system meets the exact code requirements. Where the code may allow for an "engineered system" as an exception to the prescriptive requirements, AHJ's have not been open to performance results, such as CFD analysis, presented as evidence of a successful "engineered" design.

8. Adjacency Issues

In dense areas, neighboring building proximities can impact operable windows by requiring fire rated glass, due to building code requirements. Fire rated glass can add costs on top of the extra costs associated with operable windows, further impacting the mixed mode ventilation payback analysis. Automatic closure systems will be required to comply with independent product safety certification requirements of the US. Also, fire rated glass may not be available in as many size and configuration options, further limiting the aesthetics and operation and control of the openable façade elements.

9. High Rise Smoke Control

Operable windows can have a negative impact on the smoke control strategies in high rise buildings. Smoke control is based on maintaining pressure differences between building spaces and floors in order to control the movement of smoke in the event of a fire. Having multiple façade openings will complicate the smoke control design and controls scenario. Any breakdown in the controls system related to automatic closure of façade openings can negatively impact the smoke control system's ability to achieve the required pressure differentials to control smoke migration. Life safety issues are often prioritized above aesthetic and energy goals.

10. Availability of Products

The availability of natural ventilation intakes that are UL listed for fire/smoke control can be a potential barrier. Many of these products are imported into the U.S. and may not have the necessary testing required by or be familiar to the local authorities. Motors for imported mechanically controlled dampers are not always available in U.S. voltages.

11. Available Modeling Tools

Energy, comfort, and airflow need to be analyzed together as part of a natural ventilation design. Currently no one tool or modeling software can provide all three, especially for complex building geometries. The additional analysis effort required for natural ventilation and lack of confidence in validating the modeling system outputs is often a deterrent for designers and owners. For California specifically, any robust natural ventilation modeling tool that can address energy, comfort, and airflow will also require State approval for demonstrating compliance with Title 24 energy efficiency standards.

12. Education

Occupants may be resistive to systems that require active user adjustment, as they are not used to seeing these type of systems installed in commercial applications throughout the United States. Without the proper education or understanding on how the mixed mode systems work there is a risk of increased energy usage due to operator error at the occupant level. For example, if occupant controlled windows are left open during the peak cold conditions, excessive amounts of supplemental heating may be wasted.

Facilities and maintenance personnel that have worked with traditional commercial HVAC systems throughout their career may also resist these mixed mode systems, as they are still relatively new in the United States. Training for facilities personnel on mixed mode system operations and maintenance will be a requirement of any retrofit application.

13. Climate change

Climate change is the long-term change in the distribution of weather patterns over time. Passive strategies such as natural ventilation are designed for the local climate; i.e. they will operate successfully only within a range of specific climate conditions, such as temperatures, winds, etc. As climate change alters the ambient conditions, natural ventilation may become a less effective cooling strategy. Codes providing for operable window areas or determining acceptable indoor air temperatures will need to be reevaluated against the changing ambient conditions and existing naturally ventilated buildings may need to develop adaptation strategies.

14. Air quality

Mechanical ventilation has the ability to remove odors and pollutants, and not having operable windows can prevent the ingress of odors and pollutants from outside. Natural ventilation systems may have limited ability to filter the air and, therefore, may rely on good environmental air quality to maintain acceptable indoor air quality.

Occupational Safety & Health Association (OSHA) standards may prohibit the use of natural ventilation in certain areas, for example non-attainment areas where outdoor air quality may be insufficient for natural ventilation.

2.1.8 Summary

The application of natural and mixed mode ventilation systems to new and existing commercial buildings has the potential to reduce energy costs, however natural ventilation is not typically applied to commercial buildings in the United States. In order to shift the perception of naturally ventilated commercial buildings to a feasible and more common application, resulting in potential energy savings, designers, local authorities, building owners, operators and occupants must be willing to identify and overcome the design and operations barriers that have prevented a wider use of natural ventilation in commercial buildings.

Both in the US and internationally, universities and research centers are conducting natural ventilation research related to barriers to implementation, identification and evaluation of software analysis tools, and system feasibility. As barriers to implementation are raised, examining the published and ongoing research may provide new tools, information or resources that can help overcome or validate the specific barrier.

Evaluating the performance of a natural ventilation system against thermal comfort conditions, indoor air quality requirements and energy consumption currently requires the use of multiple design tools. This evaluation is further complicated for mixed mode systems as the control sequence between the two systems needs to be defined in the software to both ensure proper conditioning of the space and to maximize the use of the natural ventilation system to reduce energy consumption. Continued software advancement by the private sector, university and government funded research centers is key to developing a complete design tool.

2.2 Characterization of Existing Buildings in California for Natural Ventilation Suitability

2.2.1 Introduction and Background

The goals of Task 1.2 are to produce both qualitative and quantitative assessments of the existing building stock in California with respect to natural ventilation suitability in order to help estimate this potential reduction.

In Section 2.1.2, prior work by NIST on climate suitability for natural ventilation in California was identified (Emmerich *et al.*, 2001). From this work, the authors presented a new ventilation cooling metric that could be used for evaluating the potential for natural ventilation based on climate suitability. This tool was used to evaluate the climates of ten cities in California – coastal and inland cities were evaluated. The study found that the majority of the coastal climates were well suited for natural ventilation, and that the hotter and more humid inland climates showed less potential. However, benefits from natural ventilation were still predicted for inland areas, especially if coupled with a hybrid mechanical system (see Section 2.1.2, Publication #2).

Some questions that the team expected to be relevant to natural ventilation potential of existing California commercial buildings were:

- How many buildings are currently naturally ventilated in California?
- What types of buildings are best suited for natural ventilation?

- How many of these suitable building types are located in suitable climates for natural ventilation?
- What portion of the statewide building energy consumption do these suitable buildings make up?
- How do local site factors play a role in the feasibility of natural ventilation?

This project focused on wind driven natural ventilation, rather than buoyancy-driven ventilation, and this particular task is no exception. For many buildings, and for much of the time, the wind can drive more airflow through a building than buoyancy alone, but it does mean that certain ventilation strategies are not considered.

2.2.2 Methods

This assessment of the suitability of existing commercial building stock in California for natural ventilation was performed using the following 3-step approach:

1. Identify key natural ventilation suitability factors to be catalogued.
2. Assess relative importance of these factors.
3. Develop a methodology to characterize California's building stock with respect to
 - a. The important natural ventilation suitability factors identified in step 2.
 - b. The potential energy savings in suitable buildings.

The following initial list of potentially critical natural ventilation suitability factors was compiled. The suitability factors were split into two categories: Building Specific and Site Specific.

Site-specific factors focus on all characteristics outside of the building boundary. Factors such as climate, terrain, orientation, surroundings, and outdoor air quality need to be assessed for natural ventilation suitability.

Building-specific factors focus on all characteristics of a building from the façade inward. Factors such as building use, size, shape, construction (thermal mass), and glazing performance may all influence natural ventilation suitability.

This analysis is complicated by the fact that there is interplay between these factors. For example, a building may be well suited to cross ventilation and night cooling, but not well-oriented or situated to take advantage of night time winds.

It should be noted that barriers such as building codes, comfort requirements, or other requirements (e.g. programmatic) may prohibit natural ventilation as a means of providing ventilation and/or cooling even if the site and the building are well suited. Some of these barriers are examined in Task 1.4.

Sacramento was selected as a demonstration city for the development of a methodology for the assessment of many of these factors.

The effects of terrain and surroundings were examined in two parallel processes. Wind tunnel testing (see Task 3.1) was used to determine the impact of the sheltering of neighboring buildings on the potential for wind-driven ventilation. The degree of sheltering in the real world was examined visually through aerial images, which allowed us to see the spacing of buildings. However, this approach does not provide any information regarding the use. To obtain this information, Graphical Information Systems (GIS) data was obtained regarding building zoning.

Use information could also be compared to building specific factors through the California Commercial End Use Survey (CEUS), a database which contains information on over 2,700 buildings in California, including detailed construction, mechanical system type, age, location, and energy use data. This allowed the team to break down California's existing building stock by building type (use), climate region, vintage (age), size, and energy consumption.

2.2.3 Results

2.2.3.1 Site-Specific Factors

Climate

Arguably the first site-specific factor to evaluate when considering a natural ventilation retrofit is the local climate. A large portion of California has a temperate, dry climate that is ideal for natural ventilation. In these locations, natural ventilation can often be used to provide both outside air minimums and also space cooling for the majority of the year. Other portions of the state have more extreme conditions, but tend to still have relatively low humidity levels. These areas often too have a substantial diurnal swing where the temperature changes dramatically between day and nighttime hours. In these locations, a supplemental mechanical heating or cooling system may be required to condition the buildings when outside conditions are at their extremes. Additionally, a night flush strategy that uses the building thermal mass may be an option for these climates.

Ideally, when assessing the potential for energy savings, suitable ventilation strategies would be identified for each building type in each climate region.

Winds

Not all climates have a prevailing wind direction. In much of the USA, it is unusual to find a prevailing wind direction occurring over 50% of the time. This means that most of the time, it is either calm, or the winds are coming from another direction, so that a good ventilation design will not rely too heavily on the dominant wind direction.

However, most California climate zones have a prevailing wind direction, particularly those along the coast. This direction will vary with the season and the time of day. There is often a substantial shift in the winter wind patterns.

It is worth considering that the "prevailing wind direction" is in reality a fairly broad range of directions. For example, in Sacramento, nominal SSW prevailing summer daytime winds come from directions between 180° and 230°. As will be shown in Project 3, wind pressures and the resulting ventilation rates can vary considerably over such a wide range of wind directions.

Sacramento's prevailing winds shift to 140°-200° at night, and to 300°-340° during winter daytime. When optimizing building shape and orientation to take advantage of such wind patterns, it is important to consider the overall ventilation strategy; the floor plate cannot be narrowest for all wind directions. If night cooling is more critical than high airflow rates in the afternoon, the building can be shaped and oriented accordingly.

Another consideration that can be critical for natural ventilation design is extended periods of calm, during which time we would expect very little wind driven ventilation. Figure 2.1 through Figure 2.3 show that, while mild winds are fairly common, they typically occur overnight and during the colder months. Calm is generally defined in most meteorological records in the US as wind speeds 2 knots or less. Extended calm conditions are relatively rare in the daytime.

Figure 2.1: Wind Direction and Strength in Sacramento

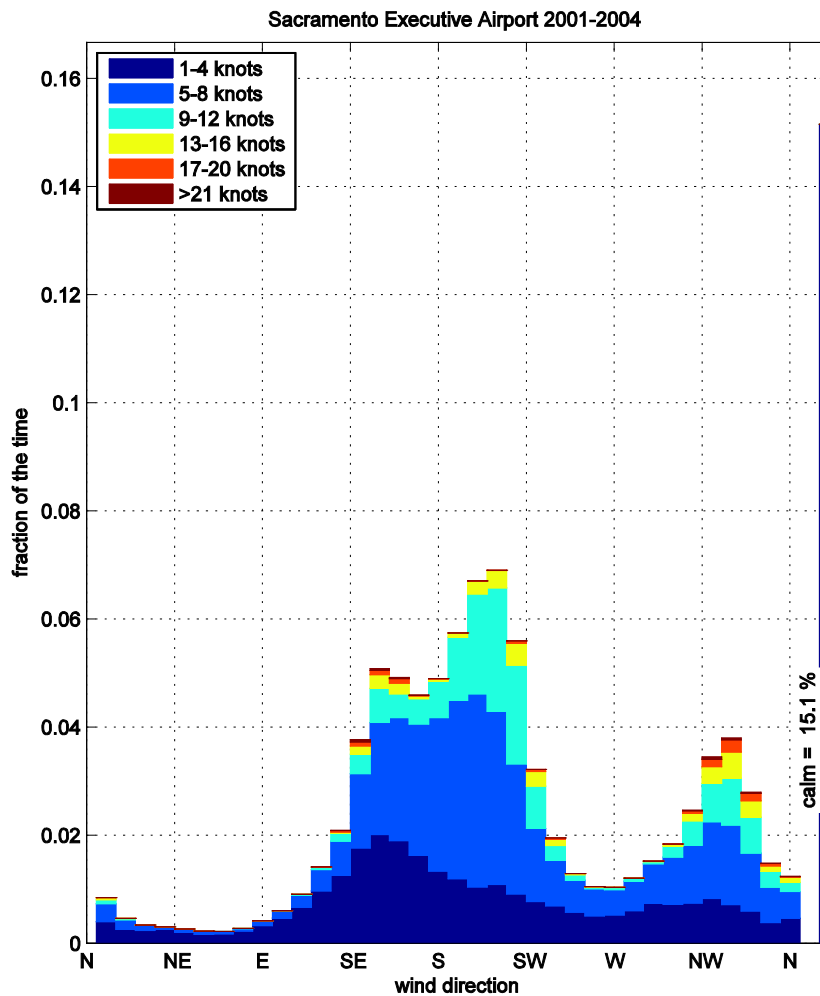

2 knots = 1 m/s = 2.3 mph. Wind speeds measured at a height of 10m in open country.

Figure 2.2: Wind Direction and Strength in Sacramento During Warmer Times of Day

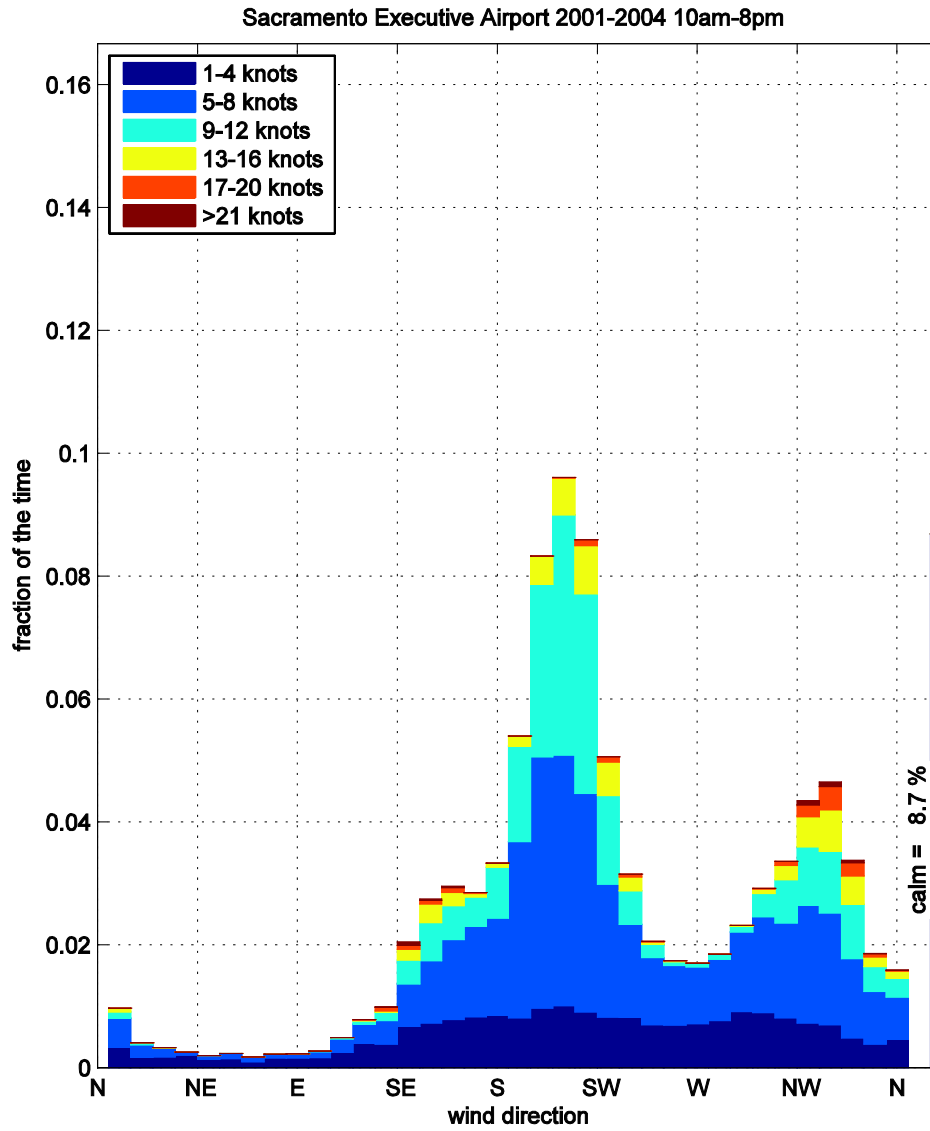

2 knots = 1 m/s = 2.3 mph.

Figure 2.3: Extended Periods of Calm Winds in Sacramento

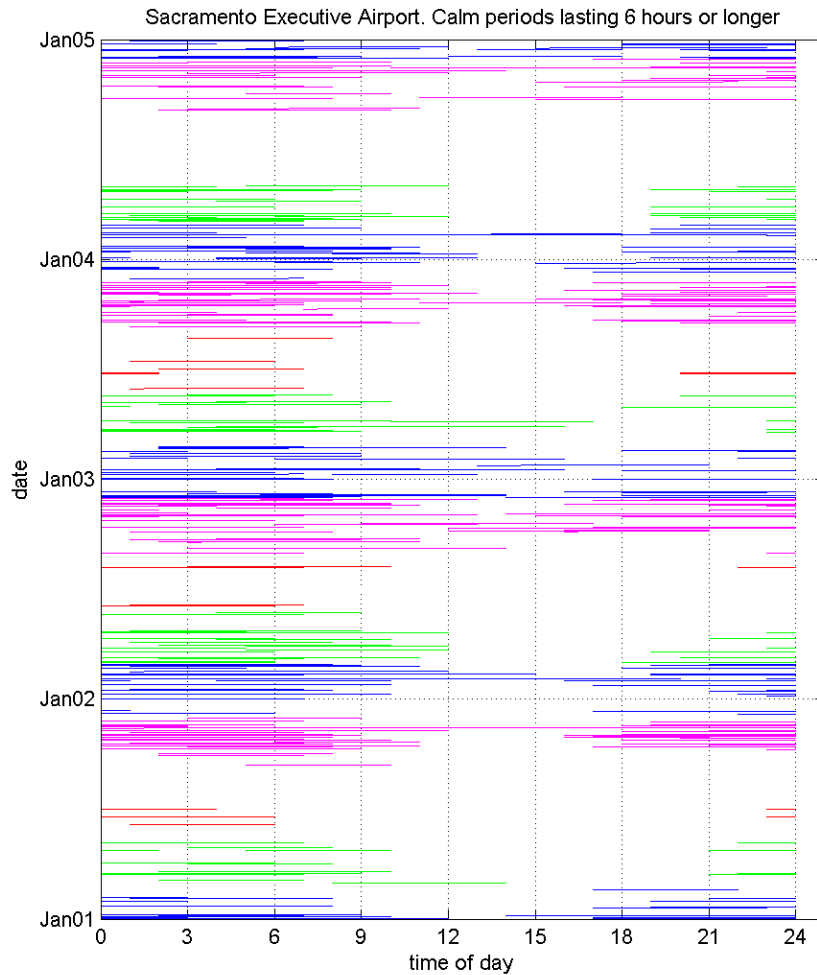

Blue is winter, green is spring, red is summer, magenta is autumn.

Surroundings

The more exposed a building is to the wind, the more potential it has for wind-driven natural ventilation. If the building is either taller than its surroundings or well offset from its neighbors, then it will be exposed. The upper floors will tend to be more exposed.

This effect was quantified in the first round of wind tunnels tests described in Section 5.1, and sample results are presented in Figure 2.4 through Figure 2.6.

The ventilation rates are presented as a fraction of approach flow wind speed passing through $\frac{1}{2}$ of the total open window area. Conceptually, flow enters through one half of the area at this speed and exits through the other half, though of course this is a gross simplification and

should not be considered a real velocity at the window; it is only to be used to calculate the ventilation rate.

Figure 2.4: Building A, From Wind Tunnel Test Series 1

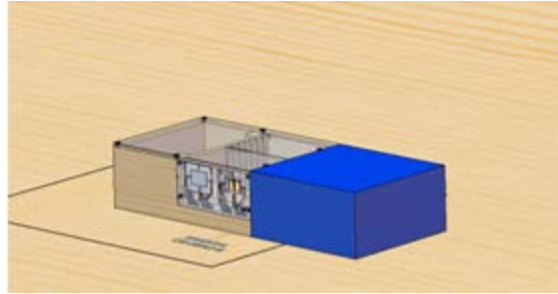

It is a 2 story building with ventilation measured in central bay of floor 2.

Figure 2.5: Plan (top) View of Central Bay Showing Window Locations.

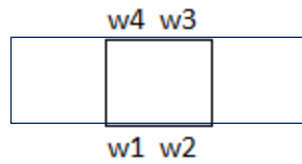

North winds (0 degrees) come from the top of the image, towards window 4. A fully-open window represents 3% of the floor area of the bay.

Figure 2.6: Ventilation Rate vs. Wind Direction. Windows are Open as Indicated in the Legend

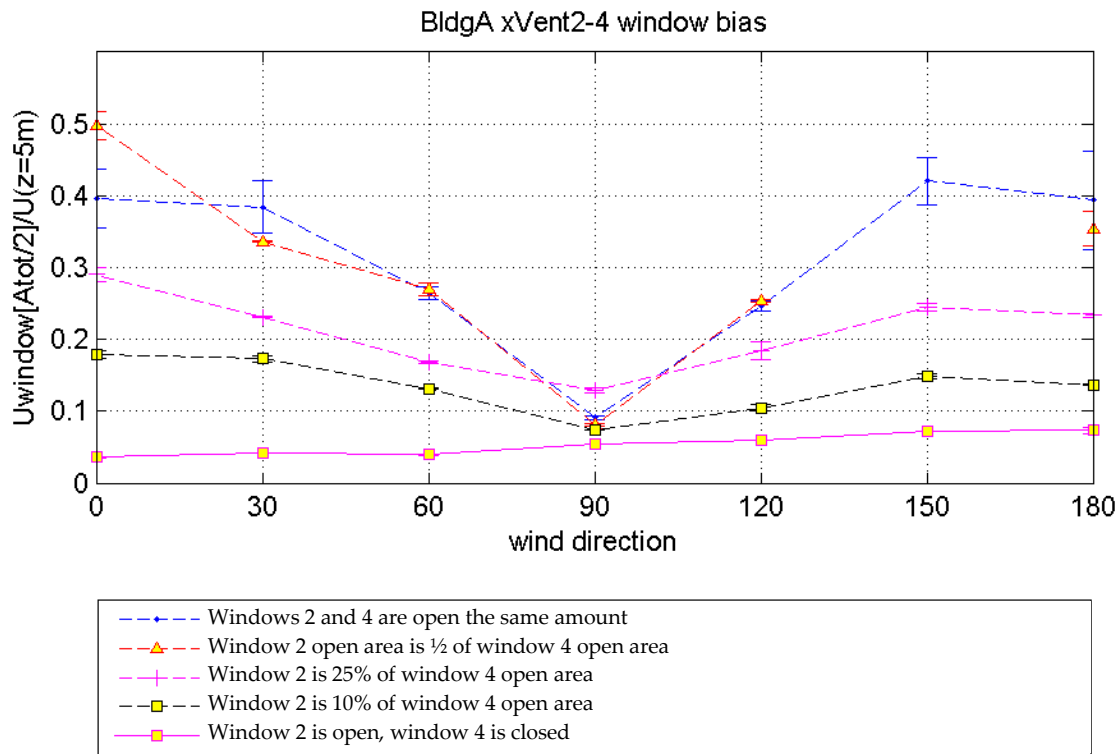

Tests were run at multiple wind speeds, and for multiple turbulence intensities. The normalized window air speeds ($U_{\text{window}}/U_{\text{ref}}$) were independent of these parameters.

The wind speed ratios through the windows were also independent of the window size, but depended on the window ratio. The more the second window is closed, the more the flow resembles single-sided, single-orifice ventilation.

The most important line in Figure 2.6 is probably the lowest ventilation rate for a single opening. This sets a minimal window velocity ratio for all conditions of about 0.03. Figure 2.7 illustrates the effects of surrounding the building with other larger structures. Even in these conditions, the flow rates do not drop below the single sided values. Some discussion of why a single opening is a less efficient ventilation strategy is provided in Section 4. Essentially, for a single opening, the flow rate is no longer well predicted by time varying pressure differences between locations on the façade, whereas the fluctuating pressures generally provide good predictions for multiple openings.

Even where cross ventilation is not possible, as shown in Figure 2.8, multiple openings on the same window face doubles the ventilation rate over what is achieved with a single opening. With simple measures like providing two separate openings to an interior space, the minimum window wind speed ratio is raised above 0.05.

A calculation using minimum window air speeds reveals that sheltered buildings do have the potential for wind-driven natural ventilation. If we use apply a low value of $U_{\text{window}}/U_{\text{ref}} = 0.05$ to a room with 12 ft. ceilings and a single window measuring 4% of the floor area (which is the minimum area recommended in ASHRAE 62.1), the resulting ventilation rate is

Volume flow rate per hour/ room volume = ACH

$$0.05 * 0.02 * A_{\text{floor}} * 3600(\text{s/hr}) / (A_{\text{floor}} * \text{Height}) = 1 \text{ ACH per m/s of wind at } U_{\text{ref}}.$$

where 0.02 is half the window area and $H = 3.6 \text{ m}$ (12 ft.). A fairly mild breeze will meet minimum outside air requirements.

This also means that on a moderately windy afternoon in Sacramento (winds of 10 knots, or 5 m/s, a space with the 4%-of-floor-area windows with an exposed windward face and cross ventilation (for which $U_w/U_{\text{ref}} = 0.5$) will see 50 ACH. It is likely in such a situation that windward windows would be closed by occupants, to avoid discomfort.

Clearly, then, natural ventilation is not limited to exposed buildings with cross ventilation, though perhaps such buildings present opportunities for more novel ventilation methods, and the wind will drive air through slots and ducts in this situation. A sheltered building will need to more carefully control heat gain, and may require more and larger windows, but the sheltering would have to be quite extreme to prevent wind driven ventilation from meeting basic requirements for outside air.

Figure 2.7: Ventilation Rate for Building A, from Wind Tunnel Test Series 1

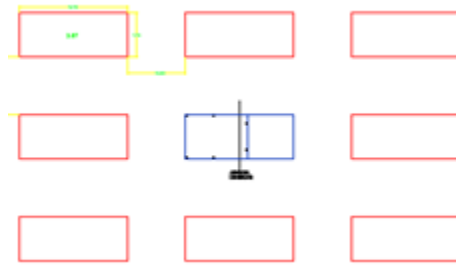

In this configuration it is surrounded by buildings with the same footprint, but twice as tall. At full scale, it is 22 ft. tall, and 45 ft. wide by 110 ft. long. The “streets” are 60 ft. wide.

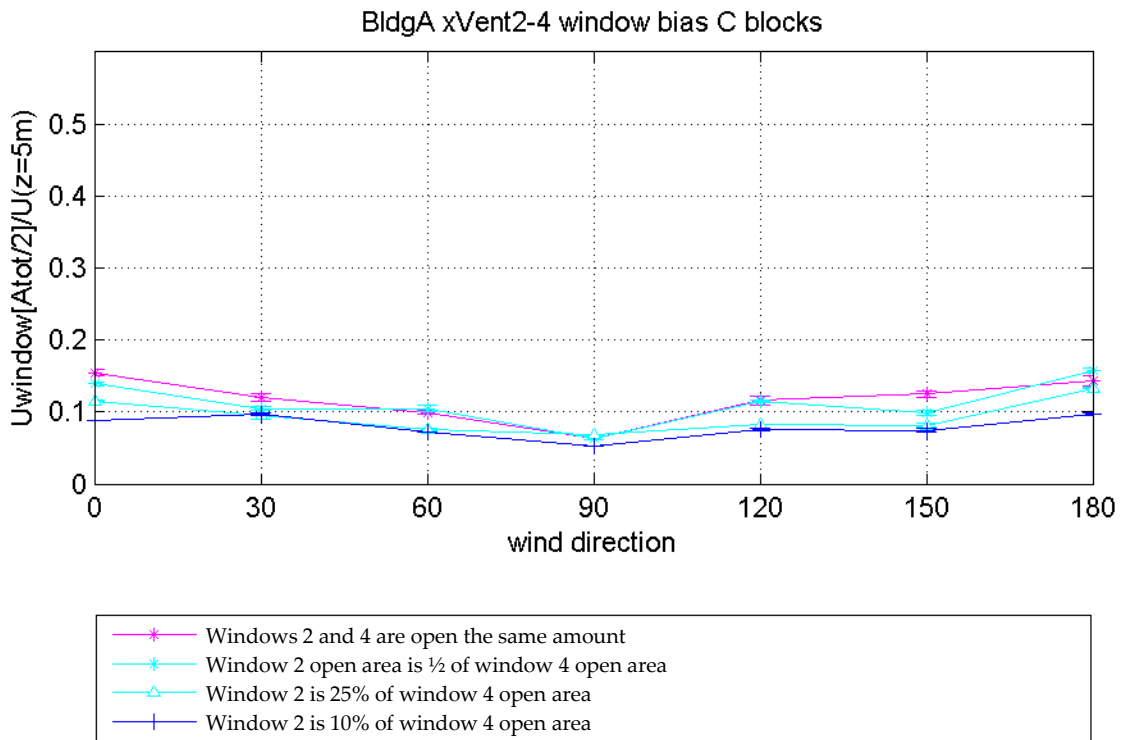
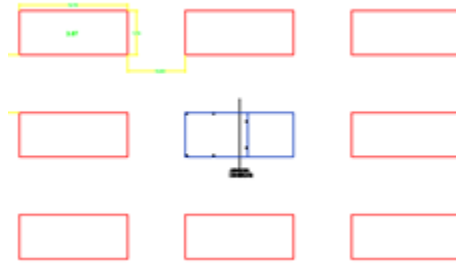
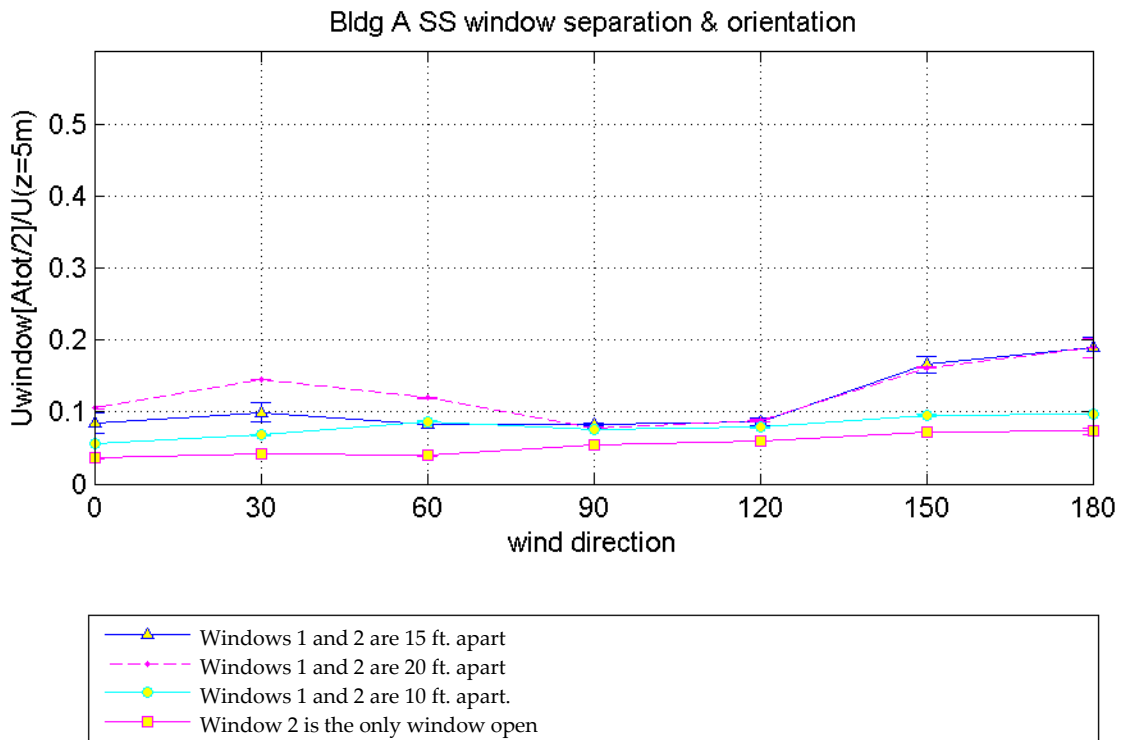

Figure 2.8: Ventilation Rate for Building A, From Wind Tunnel Test Series 1



In this configuration it is surrounded by buildings with the same footprint, but twice as tall. At full scale, it is 22 ft. tall, and 45 ft. wide by 110 ft. long. The “streets” are 60 ft. wide.



Methods of characterizing the degree of sheltering of buildings were investigated. GIS data concerning building footprints, elevations, and zoning were obtained for Sacramento. This information was imported into Google Earth. Examples are shown in Figure 2.9.

Figure 2.9: Image of Sacramento from GIS Database, Building Heights are Shown in Feet



The CEUS data, discussed in more detail below, were used to determine a typical breakdown of commercial building to be located in Sacramento:

- Almost 60,000 ft² (at least 2) very small offices from any era.
- 5 large offices: 3 big, 1 bigger, 1 biggest (target 400-500,000 ft²); any era after 1940, preferably evenly distributed.
- 4+ Health buildings:
- 1+ small (total nearly 30,000), 2 big, ideally all before 1990
- 1 quite big (200,000-250,000) and newer (ideally after 1978)
- 5+ retail buildings: 2+ small (total 60,000), 2 medium, 1 big (200,000-300,000).
- Any era, tend to be recent or newer.

- 6+ miscellaneous, (4+ small (total 120,000), 2 big), any era.
- 4 Schools, 2+ small (60k total ft²), 2 medium; 2 old, 1 recent, 1 new.
- 2 lodging, 1+ small (20k total), 1 medium. 1 older, 1 newer.
- 1 medium food store, any era.
- 1 big warehouse, or a couple of medium ones (total 150,000-200,000 ft²)

The original plan called for the analysis of a square mile section of the city. However, not all building types could be found in a given square mile, and a single area might not be representative, so instead a transect line approach as used in which a line was drawn transecting the city. The buildings meeting the above list criteria that were closest to the line were selected for evaluation for natural ventilation suitability. This approach was determined to give a more representative sample of the city – from outlier buildings on the perimeter to more sheltered buildings at the interior of the city – than a random square-mile region would have yielded. The transect, along with the selected buildings, is shown in Figure 2.10.

Unfortunately, this kind of detailed GIS database information was not available for subsequent cities that we contacted. We believe this approach could have some value, but comparable GIS data would be needed for other climates zones around the state. Fortunately, this task appears to be less urgent, with the finding that sheltered buildings are likely to have adequate wind driven ventilation potential, unless information from the building energy simulations reveals that much higher rates of ventilation are needed than we currently anticipate.

Figure 2.10: Sacramento Transect in Google Earth (Partial)

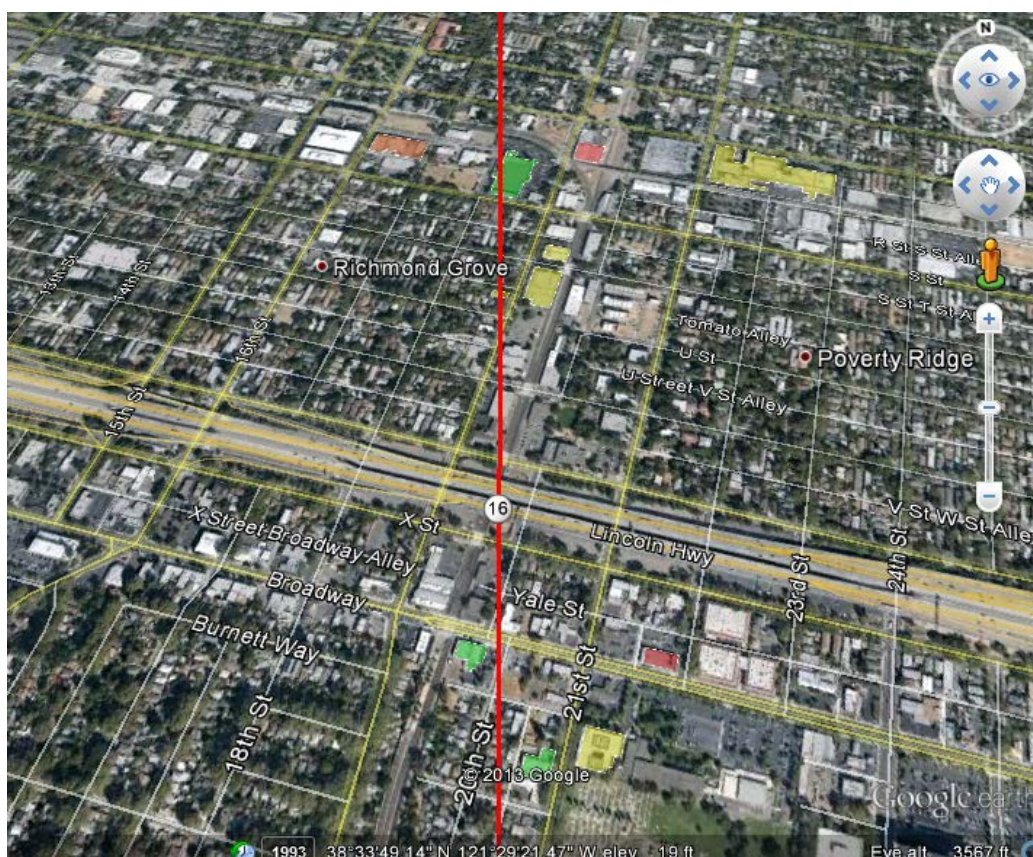

Building types are color coded. Offices are yellow, retail is green, schools are blue, lodging in purple, warehouses in brown, other/ miscellaneous in red

Air Quality

Naturally ventilated buildings face many of the same challenges as mechanically ventilated buildings where nearby, local pollution sources are concerned. For example, kitchen odors will enter through the HVAC air intakes or through open windows. A poorly sited air intake will spread these smells throughout the building. On the other hand, you can move your HVAC air intake, but this is more difficult for operable windows downwind of the kitchen exhaust. The same logic applies to any gas or other pollutant which is not effectively removed by the HVAC filtering system. While this does add another unique challenge to the ventilation design for some sites, we do not expect local pollution sources to eliminate a significant portion of the commercial building stock from consideration of natural ventilation.

One common concern for occupants of buildings with operable windows is pollution from nearby roadways. Models of pollution concentration near roadways indicates that short term exposure limits (1 hr, 8 hr) to pollutants such as CO are seldom exceeded, though longer term exposure (cumulative over the years) are being researched. CO concentrations can be readily

monitored, as they are in parking garages, so that window operation can be directed accordingly.

Concentrations of pollutants from vehicle exhausts tend to drop dramatically with distance above the roadway, so operable windows at street level are the most vulnerable. These are also likely to be subject to constraints due to noise and security concerns.

2.2.3.2 Building-Specific Factors

Size, Shape, Orientation, and Internal Configuration

This study is focused on the potential energy savings from natural ventilation retrofits to existing buildings rather than on new construction. The scope is limited to consider only wind-driven natural ventilation in the form of single-sided and cross-ventilation through the use of operable windows. Practical limitations prevent the consideration of adding a central shaft for stack driven ventilation. This makes the size and shape of the building a key factor as there are both physical and code limitations on the acceptable depth of a naturally ventilated floor plate.

Internal partitions add to the challenge of ventilating deep into the floor plate. For example, a traditional perimeter-and-core zoning scheme for many office buildings, with the private offices along the perimeter and open offices at the core, tends to limit the potential naturally ventilated section to the depth of the perimeter office.

It is common for natural ventilation guidelines to recommend that a building have a long, narrow floor plate and be oriented with the narrow dimension parallel to the prevailing winds, because this can considerably enhance the potential for cross ventilation during these winds if the building has an exposed (i.e. unsheltered) upwind face.

Building Construction

Building massing is important to consider when evaluating natural ventilation opportunities. Heavyweight constructions, such as concrete or stone, will retain coolth longer than lightweight constructions such as steel or wood framed buildings. Buildings with heavy construction can take advantage of a night flushing strategy to charge the thermal mass of the building during unoccupied hours. By opening windows at night, when ambient temperatures are typically cooler, the building mass can be passively cooled or “charged”. Depending on the climate and use of the building, this strategy may allow the building material to absorb enough coolth to keep the interior at a comfortable temperature through the warmest period of the following day. Subsequently, the building can again be “flushed out” with cooler night air.

In addition to massing, the façade design of naturally ventilated buildings needs to prevent excessive solar heat gains from entering the building. This can be managed on existing buildings by adding shading devices and/or by upgrading the existing glazing.

Thermal Loads

The functions performed within an existing building will play a large role in the natural ventilation suitability assessment. It is suggested that heat gains at the façade be limited to 4 W/ft² per sunpatch floor area; and that heat gains from the lights and equipment within the

space be limited to 2 W/ ft² (McConahey 2008). Some existing buildings may require an energy efficiency upgrade to reduce both external and internal heat gains before considering a natural ventilation retrofit.

2.2.3.3 California Commercial End Use Survey (CEUS)

Building Type

There are twelve building types in the CEUS database: Small & Large Office, Restaurant, Retail, Food \Liquor, Refrigerated & Unrefrigerated Warehouse, School, College, Health Care, Hotel \Motel, and Miscellaneous. The team began the characterization study by examining which building types consume the most energy. Figure 2.11 below shows the CEUS breakdown for energy consumption by building type.

Figure 2.11: Annual Energy Use by Building Type

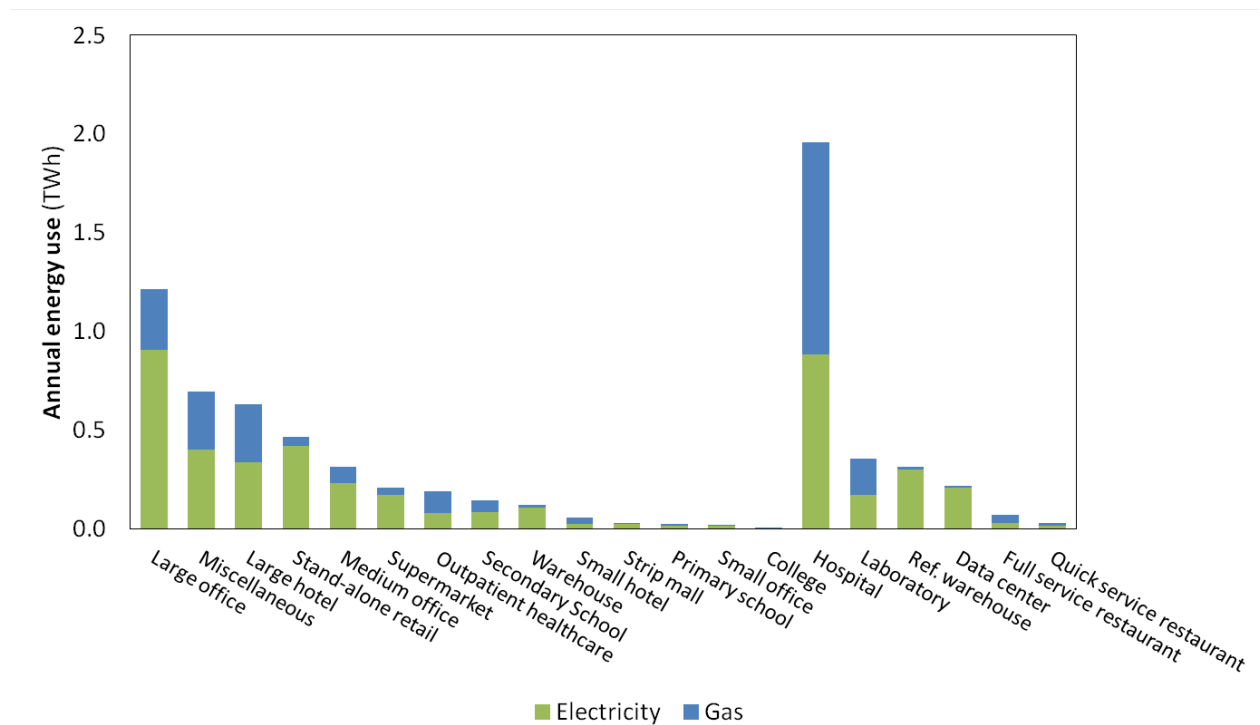

Source: California Commercial End Use Survey (CEUS)

As shown in Figure 2.11, large offices are one of the top energy consumers across the state. Office buildings are potentially strong candidates for natural ventilation retrofits based on their typical ventilation requirements, cooling loads, size, shape and function. From this, the team chose office buildings as the pilot building type to study in more detail using CEUS.

Internal Heat Load

Ideally the internal loads of a naturally ventilated building should be held at or below 2 W/ ft² (McConahey 2008). The CEUS database was queried to gauge the number of office buildings that met this criteria. Figure 2.12 below provides graphs of both lighting and equipment load densities for California office buildings.

Figure 2.12: Cumulative Percentage Plots Showing Lighting and Equipment Power Densities for California Office Buildings

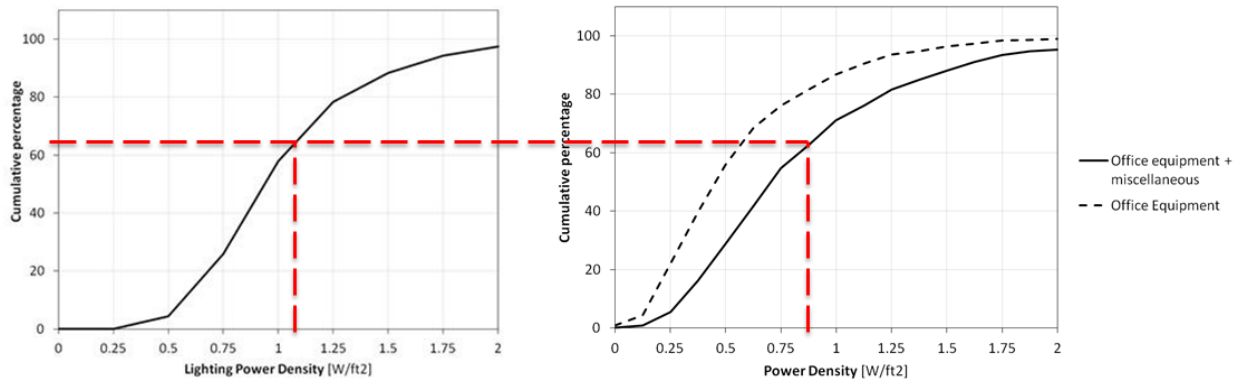

*Miscellaneous includes cooking, refrigeration and other miscellaneous appliances.

Source: California Commercial End Use Survey (CEUS)

The figures above show that more than 60% of California office buildings have combined lighting and equipment power densities lower than 2 W/ ft². Only 25% of all buildings currently have lighting power densities lower than 0.75 W/ ft². However, with the increasing availability of low energy lighting solutions, such as LED lighting, lighting power density reductions will soon be more easily achievable, down to the 0.75 W/ ft² range. This would allow up to 1.25 W/ft² of equipment power without exceeding the 2 W/ ft² limit. This would increase the number of office buildings potentially suited for natural ventilation to 80% based on load density.

Floor Plate Depth

The California Mechanical Code requires that naturally ventilated spaces be within 20 feet of operable windows. Therefore it was worth examining the percentage of office buildings that have widths greater than 40 feet.

Figure 2.13 shows that only 20% of California office buildings have floor plates with depths less than 40 feet. If however, performance-based criteria were developed that allowed for increased depths to be naturally ventilated to say double that width (80 feet), over 50% of all office buildings would be eligible.

Figure 2.13: Cumulative Frequency Distribution of Floor Plate Depths for California Office Buildings (N = 628)

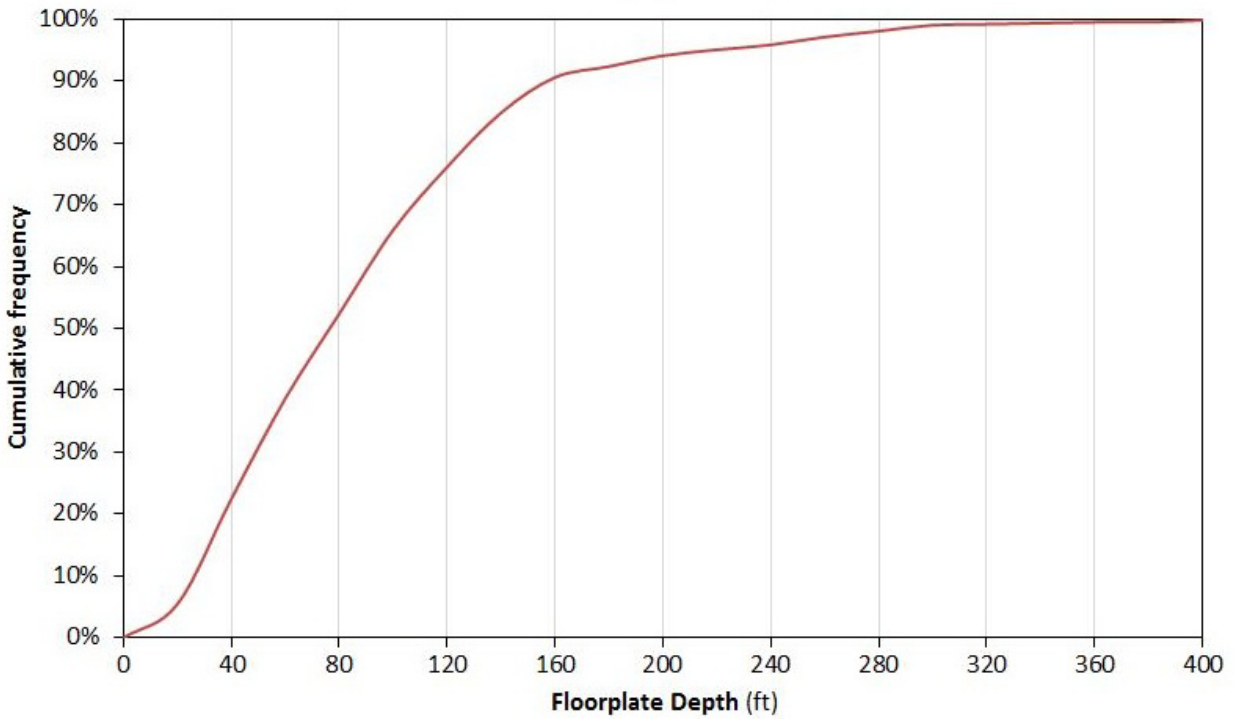

Source: California Commercial End Use Survey (CEUS)

Climate Region

The CEUS database provides the climate zone where each building is located. Figure 2.14 provides a map of the sixteen Title 24 climate zones as developed by the California Energy Commission for regions of California with similar climatic characteristics.

Figure 2.14: Map of the California Building Climate Zones

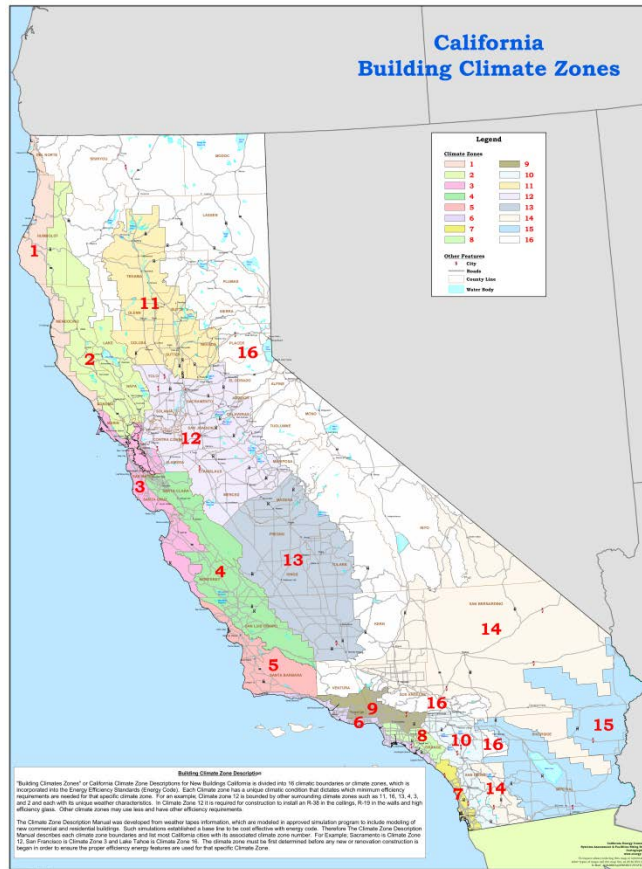

Source: California Energy Commission.

A parallel effort on this project focused on the technical potential for energy savings through natural ventilation retrofits, using energy modeling simulations in EnergyPlus. The team needed a way to expand the results of focused building simulations in each climate region to the statewide scale. The CEUS database contains estimations for annual electricity use by climate zone. Figure 2.15 below shows the energy breakdown by climate zone from the CEUS.

Figure 2.15: Estimated Annual Electricity Use by Title 24 Climate Zone for California Buildings

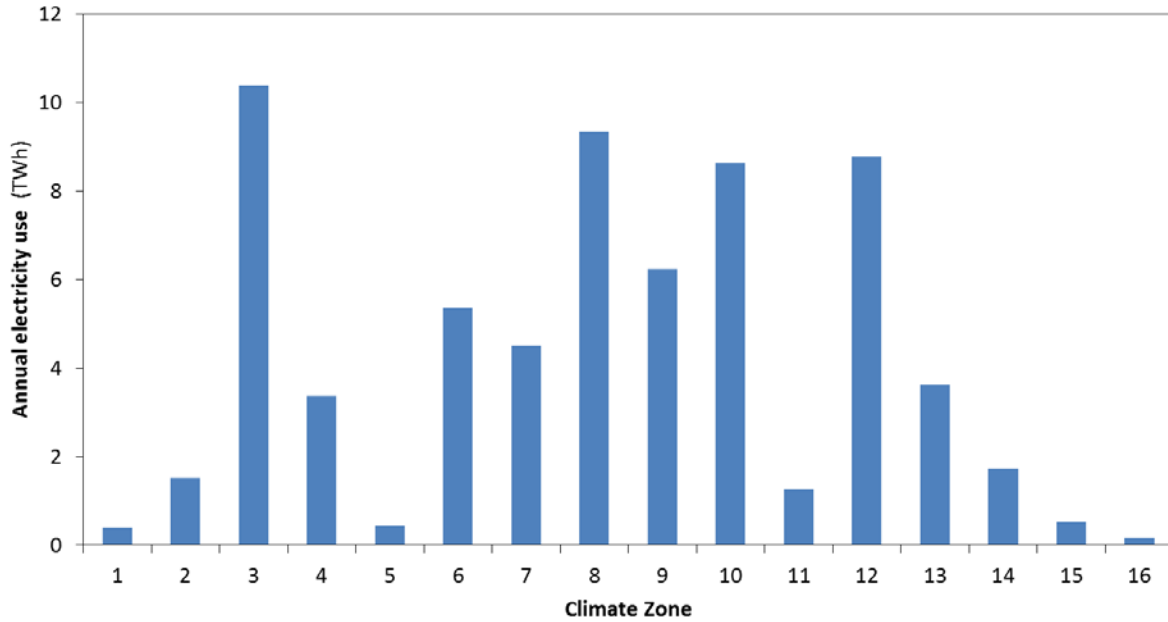

Source: California Commercial End Use Survey (CEUS)

The team again wanted to specifically investigate office buildings. Figure 2.16 shows the estimated annual electricity use of California office buildings by climate zone.

Figure 2.16: Estimated Annual Electricity Use of California Office Buildings by Climate Zone

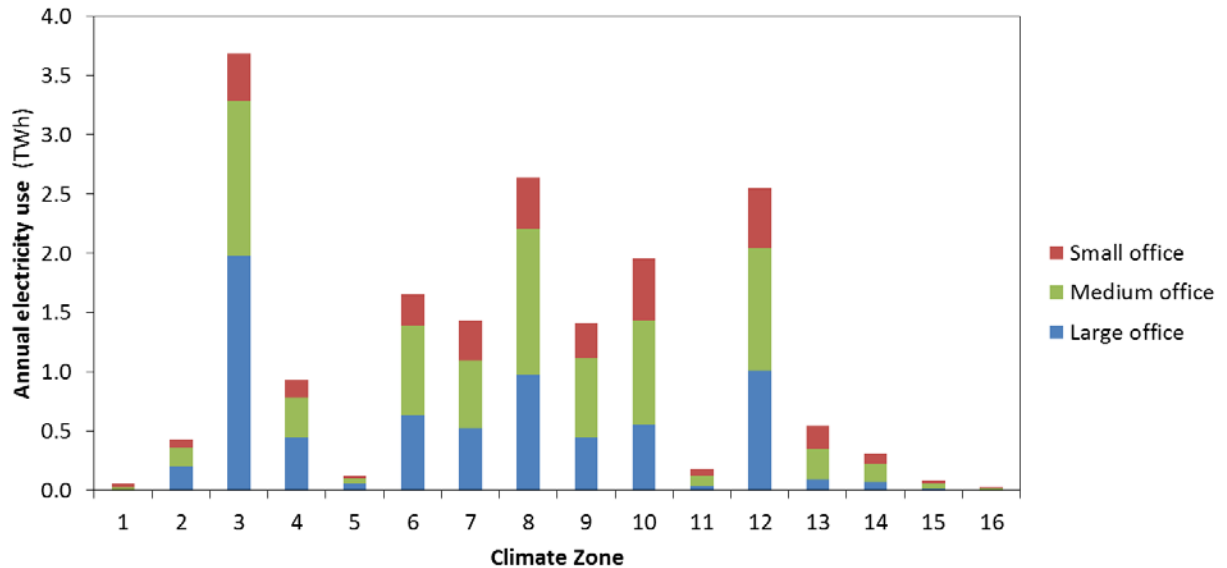

Source: California Commercial End Use Survey (CEUS)

Vintage

The specific age of each building in the CEUS database is not specified. Buildings are placed into one of four vintages: Pre-1941, 1941-1978, 1979-1990, and 1991-2003. Figure 2.17 below shows the energy consumption of the buildings by vintage.

Figure 2.17: Annual Energy Use by Vintage

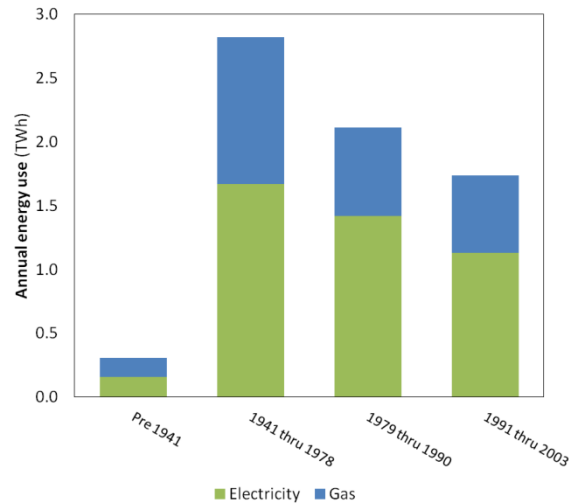

Source: California Commercial End Use Survey (CEUS)

Existing Naturally Ventilated Buildings in California

A goal of this study was to estimate the percentage of buildings that are naturally ventilated in California. It was envisaged that this could be done by reaching out to local ASHRAE contacts across the state. However, the team discovered that the CEUS database contains information about the presence of operable windows, mechanical ventilation and cooling, and cooling loads for the buildings surveyed. The CEUS database does not specifically state that a building is naturally ventilated, but inferences can be made based on these relevant fields.

One method used to estimate the prevalence of natural ventilation from the CEUS database was to examine the number of buildings that reported no cooling load. Of the 2703 buildings in the database, 238 of them (9%) report no cooling load. Similarly, the buildings in the database are subdivided into *activity areas*. Each of buildings in the CEUS database can have up to eight activity areas. For the 2703 buildings, there are a total of 12,052 building activity areas. There are 873 activity areas (7%) without cooling (Figure 2.18).

Figure 2.18: Percentage of Buildings With and Without Mechanical Cooling and Ventilation

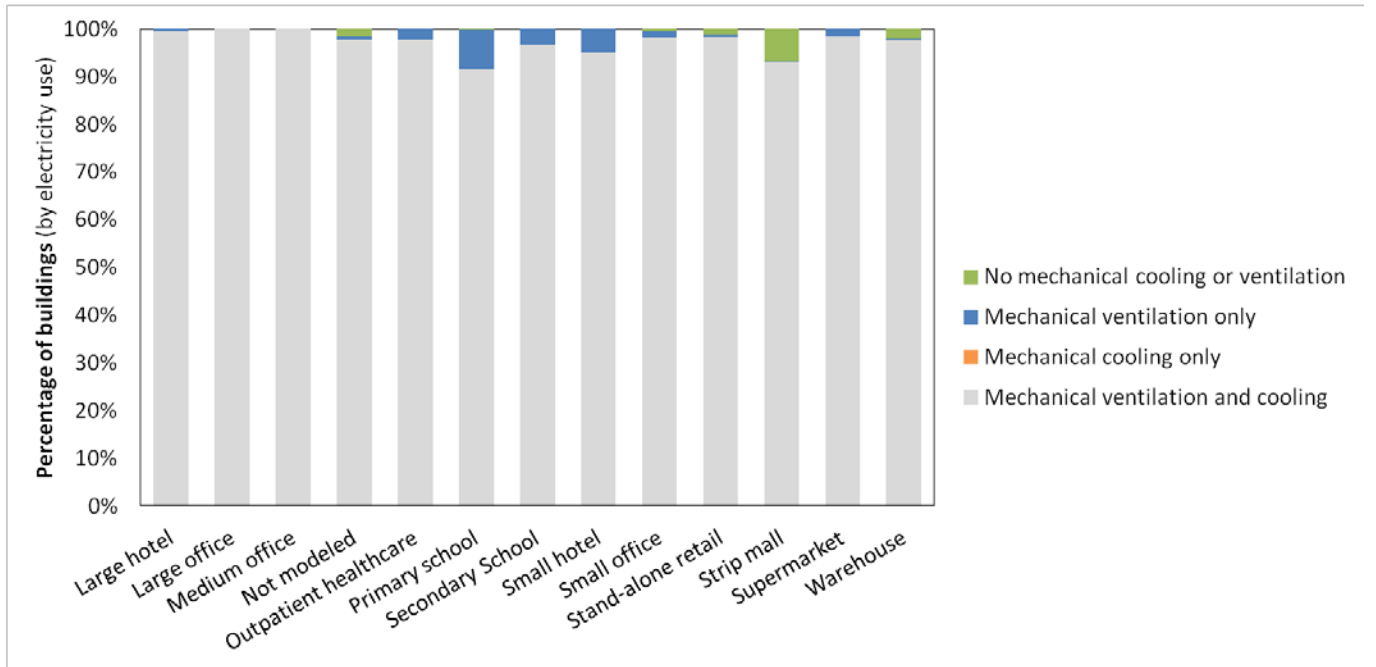

Source: California Commercial End Use Survey (CEUS)

Another parameter examined was the percentage of operable vs. fixed windows. In total, 14.2% of the windows (by area) are listed as operable in the CEUS database. Figure 2.19 below provides a breakdown showing the distribution by building type.

Figure 2.19: Percentage of Windows Listed as Operable vs. Fixed by Building Type

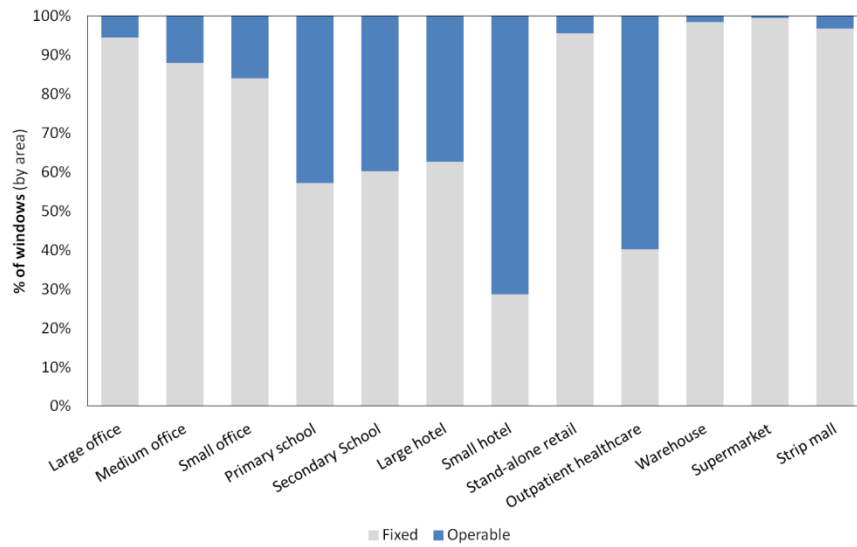

Source: California Commercial End Use Survey (CEUS)

2.2.4 Conclusions

Valuable information was gathered from the investigation of the CEUS database on the existing commercial buildings in California. From this study, building types, climates, and vintages were prioritized for further investigation in the technical potential section of this project. A method was also developed for expanding the results of focused modeling to California statewide energy savings, the details of which are discussed further in the following section.

The methods used to approximate the current number of naturally ventilated buildings in California are not exact. However the data contained in CEUS suggests that between 7-9% of California buildings do not contain mechanical ventilation or cooling systems.

2.3 Modeling With EnergyPlus to Assess Building Energy Consumption and Demand Reduction Potential

2.3.1 Introduction

The purpose of Task 1.3 is to estimate the potential energy and cost savings from retrofitting California commercial buildings for natural ventilation using the energy simulation tool EnergyPlus.

2.3.2 Development of Baseline Building Models

The first major challenge in this task was to develop a set of baseline energy models that represent the existing California commercial building stock. An ideal representation of the California building stock would include an energy model for every building in the state, but this is clearly unrealistic. To reduce the number of energy models, the first step was to prioritize building types to be modeled. After consultation with designers and engineers, five building types were selected based on natural ventilation feasibility, statewide energy consumption, and market acceptability (i.e. whether typical owners and occupants of the building type would be amenable to natural ventilation) – see Figure 2.20. Ultimately, of the five building types with highest priority, three were chosen to be modeled: small, medium and large offices. Offices represent 40% of the electricity use of California commercial buildings deemed feasible for natural ventilation, and 27% of the electricity use of all commercial buildings in the state.

Figure 2.20: Statewide Electricity Use of California Commercial Buildings by Building Type

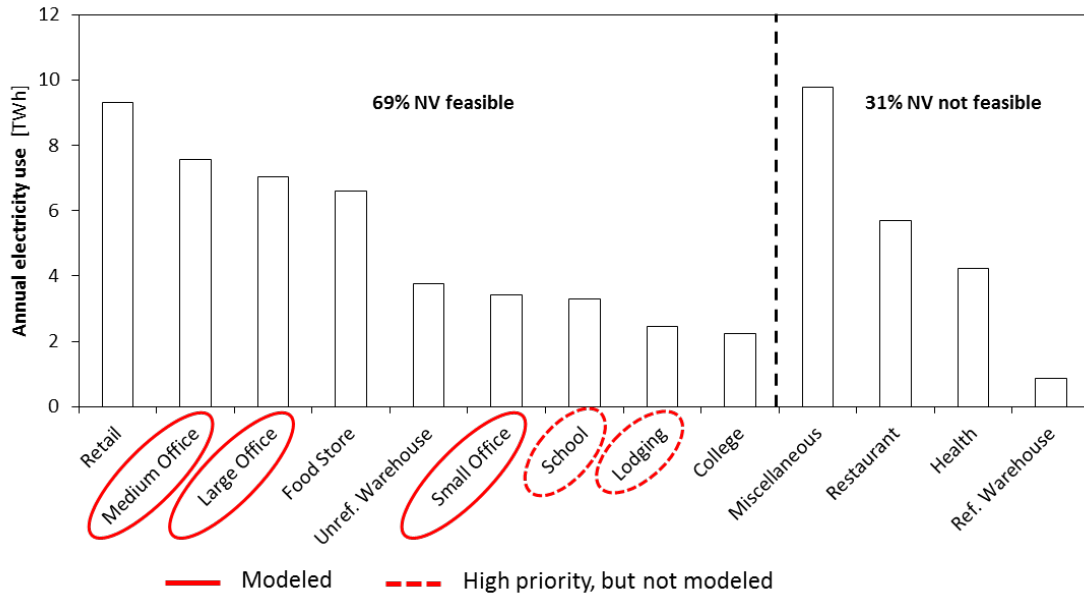

Source: CEC (2006).

Each building type was divided into 80 groups and a unique building model was crafted for each group. The 80 groups result from combining the sixteen California Climate Zones (Figure 2.14), with the five vintages in Table 2.3. 80 groups for three building types results in 240 unique baseline building models.

The US Department of Energy (DOE) has sponsored the development of commercial reference building models in EnergyPlus to be used for assessing building technologies and developing energy codes and standards (Deru *et al.* 2011). These sixteen commercial building prototypes are designed to be representative of approximately two thirds of the US commercial building stock, as reported in the Commercial Buildings Energy Consumption Survey (CBECS) database. Pacific Northwest National Laboratory (PNNL) has used the commercial reference building models to estimate national energy savings associated with the new ASHRAE Standard 90.1-2010 (Thorton *et al.* 2011). Building on the PNNL approach, our methodology for estimating the potential energy savings of natural ventilation retrofits in California commercial buildings uses EnergyPlus and the DOE commercial reference building models but involves significant modification of the models to represent the particular characteristics of the existing commercial building stock in California.

Table 2.3: Vintage Categories Used to Group Building Models, and Corresponding Title Twenty Four Year

Vintage	Title 24 Year
Pre 1941	1978 (downgraded)
1941-1978	1978
1979-1990	1987
1991-2003	1998
Post 2003	2008

For each baseline building model, the starting point was the corresponding post-1980 DOE reference building model for San Francisco (ASHRAE climate zone 3C). The DOE model was then modified to be more representative of the existing California commercial building stock for that building's group, based on data from the CEUS database, archived versions of California's Building Energy Efficiency Standards, also known as Title 24, and other sources, as listed in Table 2.4.

The first release of Title 24 was in 1978. For building models intended to represent the 1941 to 1978 vintage, the 1978 Title 24 standard was used as the reference, and the models of Pre-1941 vintage buildings were based on 1978 Title 24 with reduced levels of envelope insulation and increased window U-values. The rationale for using the 1978 standard for buildings built before that date was partly that it was assumed a fraction of the buildings would have undergone some envelope improvements over the intervening years; and partly we assumed that a fraction would have used building materials and components that would have met the 1978 code if it had been in place. This logic was also applied to the later vintages, such that the publication dates of the historical codes fell within the range of dates that defined each vintage.

Table 2.4 presents the sources for each energy model input and the following subsections describe in more detail the derivation of each input that was modified from the DOE models.

Building Form

Figure 2.21 and Figure 2.22 present the basic geometries and zone configurations for the three models. For the medium and large office building models, the building footprints (i.e. the floor areas and aspect ratios) are the same as the corresponding DOE commercial reference building models. The depth of the perimeter zones, however, is increased from 4.57m to 6.10 m (15 ft. to 20 ft.) to maximize the amount of floor area that can be naturally ventilated based on the Title 24-2008 requirement that all of the space must be within 20 ft. of an operable window to be naturally ventilated.

Table 2.4: Sources for Building Model Inputs

Input Category	Building Model Input	Source
Form	Window to wall ratio Orientation	CEUS
	Floor area Aspect ratio	DOE prototype models
	Wind pressure coefficients	ASHRAE Handbook of Fundamentals 2008
Fabric	Glazing type Wall, floor and roof constructions	DOE prototype models
	Wall, floor, roof and window insulation levels	Title 24 Standard
	Envelope air tightness	Measured data (Persily, 1998)
Program	Lighting density Occupant density Plug and process loads Ventilation rates	Title 24 Standard and other sources
	Hot water demand Operating schedules and setpoints	DOE prototype models
Equipment	HVAC equipment Hot water equipment Refrigeration equipment	DOE prototype models

Figure 2.21: Small, Medium, and Large Office Building Models

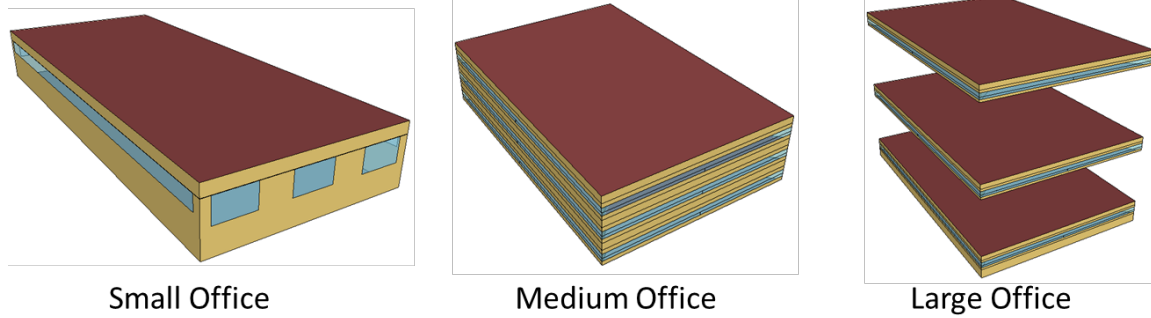
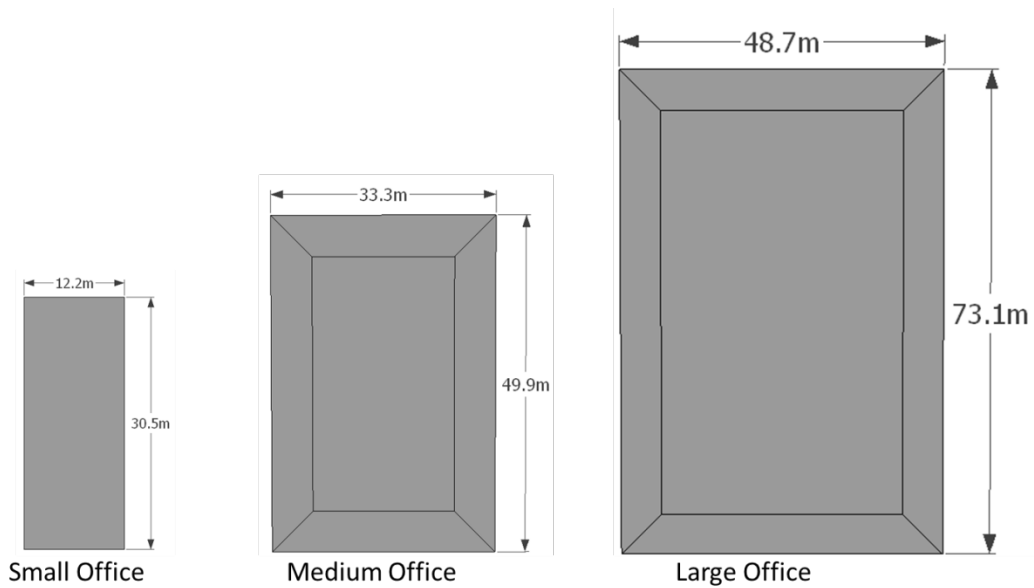

Figure 2.22: Zone Configuration and Dimensions of the Small, Medium, and Large Office Energy Models



The footprint of the small-office model was modified from the original DOE model to make it more representative of buildings that are conducive to natural ventilation. The number of zones was reduced from five to one, the floor plate area was reduced significantly and the floor plate depth was reduced to 12.2 meters (40 ft.) so that the entire building can be served by natural ventilation. The basic form for each of the three models is summarized in Table 2.5.

Table 2.5: Form Characteristics of the Three Building Models

Building Type	Floor Area (m²)	Dimensions (m)	Number of floors
Small office	372	30.5 x 12.2	1
Medium office	4,982	49.9 x 33.3	3
Large office	46,320	73.1 x 48.7	12 + basement

Fabric

The window, wall, floor and roof construction materials remain unchanged from the original DOE models. In each model, the thickness of the insulation was varied to match the minimum U-value from the corresponding year of Title 24 Standard, as listed in Table 2.3. The original DOE models represent unintentional air infiltration using a simple constant infiltration rate. The building models used here model infiltration using the Airflow Network, a bulk airflow model integrated with EnergyPlus, and therefore account for the variability of infiltration with temperature and wind speed. An effective leakage area of 0.01 cm² per m² of exterior wall surface area was applied to all walls and roofs, based on the work of Persily and Ivy (2001) that provides mean values for the effective leakage area in different building types. The same effective leakage area was applied to all the vintages, based on previous research by Persily (1998) that suggests that there is no correlation between building age and air tightness.

Program

The lighting power density and interior equipment power density for the baseline building models are 13.99 W/m² (1.3 W/ft²) and 8.07 W/m² (0.75 W/ft²), respectively. These values were obtained by analyzing the electricity end use data for office buildings in the CEUS database. The occupant density value used for this study is 13.93 m² per person (150 ft² per person), which is the average of the DOE reference building model value of 18.58 m² per person (200 ft² per person) and the T24 Alternative Calculation Manual value of 9.29 m² per person (100 ft² per person). The minimum ventilation rate for all vintages is 0.000762 m³/s per m² of floor area (0.15 ft³/min per ft² of floor area), per the Title 24-2008 requirement for offices.

Equipment

Three versions of each of the sixteen DOE commercial reference building models were previously developed by NREL to account for variations based on the age of existing building stock: new construction, post-1980 construction, and pre-1980 construction. The HVAC equipment types and efficiencies for each version are based on the minimum requirements of ANSI/ASHRAE/IESNA Standard 90.1-2004 for new construction, ASHRAE Standard 90.1-1989 for post-1980 construction, and an analysis of historical equipment efficiencies for pre-1980 construction (Deru *et al.* 2011).

HVAC system types and efficiencies for all four CEUS vintages were modeled using those defined in the post-1980 construction versions of the DOE reference building models for the following two reasons. First, the two most recent vintages, 1979-1990 and 1991-2003, are well

represented, as an average, by Standard 90.1-1989. The next ASHRAE Standard 90.1 was not released until 2001, so most of the buildings constructed between 1990 and 2003 were built to the 1989 standard. Buildings built from 1979-1990 were mostly built under previous, less stringent standards. Applying the 1989 standard to the buildings built in this earlier era will lead to a conservative estimate for energy savings for this particular vintage.

Second, the two oldest vintages, pre-1941 and 1941-1978, likely do not contain their original equipment and possibly have had comprehensive upgrades that involve changing systems types (i.e. converting from CAV to VAV). When considering expected equipment life, it is reasonable to assume that buildings constructed before 1979 would have undergone at least one major HVAC equipment retrofit. Depending on the age and use of the building, and when the retrofit took place, system types and equipment efficiencies may vary significantly. The post-1980 construction versions were therefore seen as a good middle-of-the-road representation for this large source of variation in potential performance. The HVAC system types for the three building types are listed in Table 2.6.

Table 2.6: HVAC System Types for the Three Building Models

Building Type	HVAC System
Small office	Packaged single zone system
Medium office	Multizone VAV with electric reheat
Large office	Multizone VAV with reheat using hot water from a gas boiler

Comparison of the Baseline Energy Models with CEUS Survey Energy Data

Figure 2.23 through Figure 2.25 show comparisons of the energy end-use breakdowns for large, medium-sized, and small offices taken from the CEUS database with those generated by the baseline energy models for two California climates. The box and whiskers represent the distribution for the buildings in the CEUS database, where the top and bottom box represent the inner quartiles and the whiskers represent the lesser of the maximum value and 1.5 times the median value. The data for two representative building models are indicated by ‘x’. It is important to note that the energy end-use data in CEUS are not from measured data, but are from calibrated energy models. The largest differences are for fans and pumps – this is likely due to the reference models being based on variable air volume (VAV) systems and variable speed pumping for hot and chilled water, whereas the buildings in the CEUS database use both constant air volume (CAV) and VAV systems and both fixed and variable speed pumps.

Figure 2.23: Energy End-Use Breakdown for Large Offices

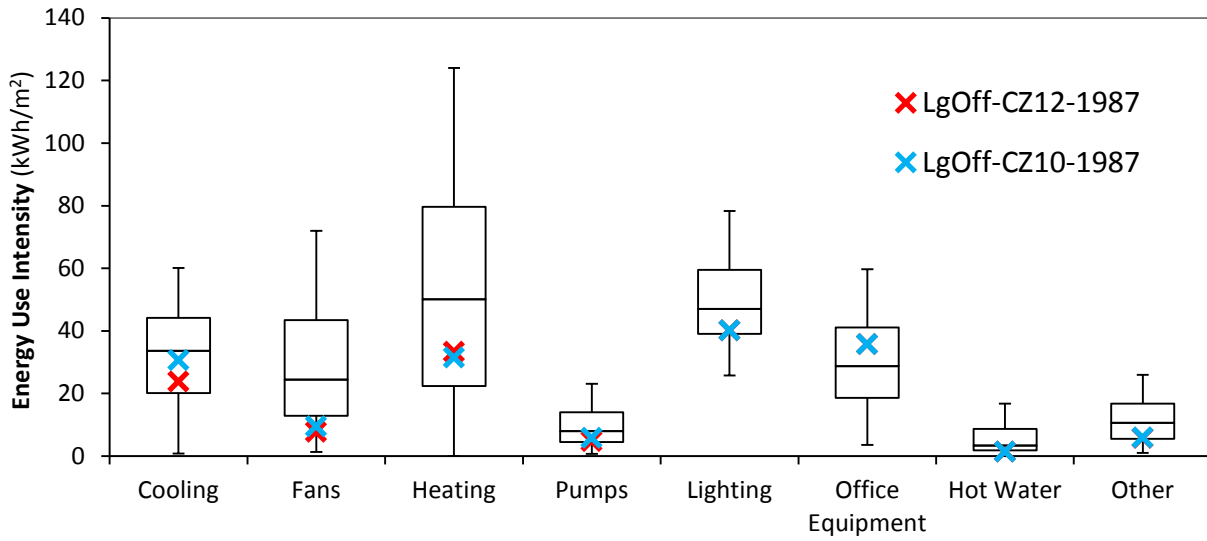

Figure 2.24: Energy End-Use Breakdown for Medium Offices

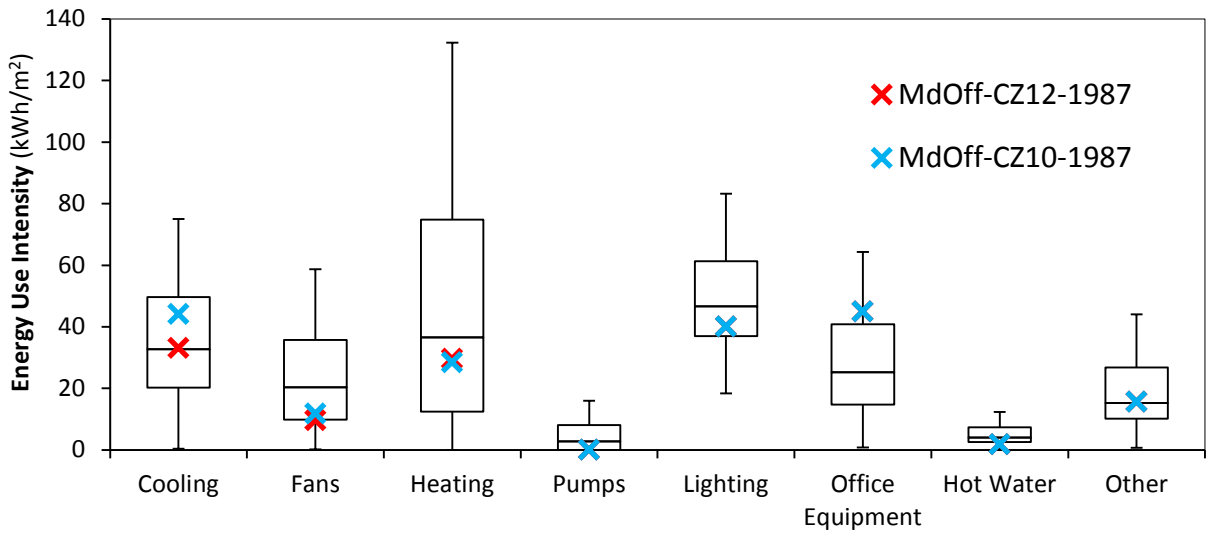
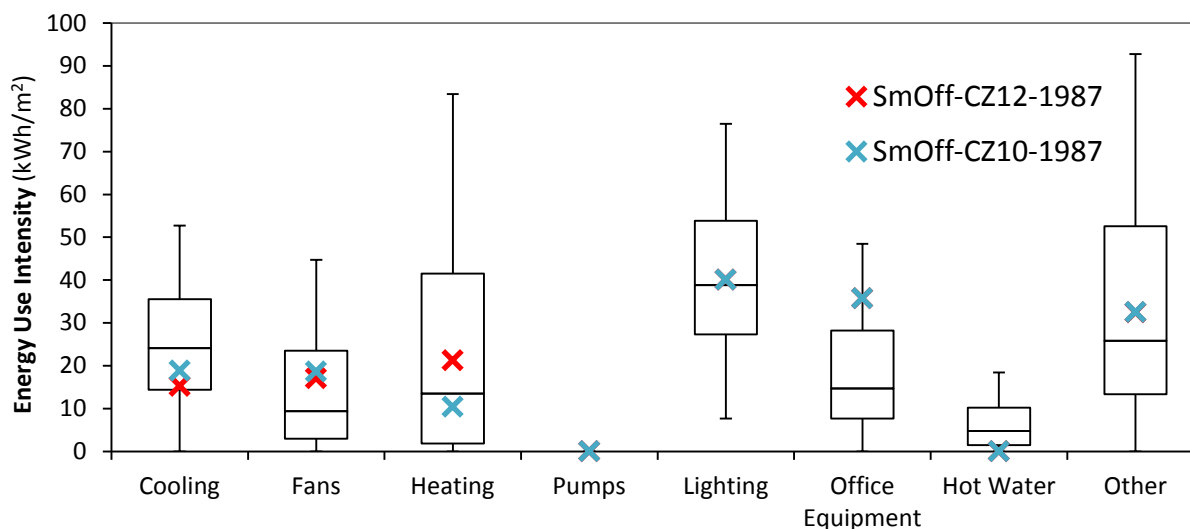

Figure 2.25: Energy End Use Breakdown for Small Offices



2.3.3 Development of Retrofit Building Models

In order to estimate the energy and cost savings from natural ventilation retrofits, a total of four scenarios are developed for each building model:

1. **B1 Baseline:** This is the baseline model as described in the previous section.
2. **B2 Baseline with Cooling Load Reduction Measures:** This scenario is the baseline model with an aggressive set of cooling load reduction measures added. The measures are described in further detail later in this subsection.
3. **NV1 Natural Ventilation:** This scenario is the baseline model with operable windows added in all zones that are code compliant for natural ventilation (i.e. zones within 20 ft. of an operable window). The building is operated in 'mixed mode', i.e. the mechanical cooling and ventilation are turned off when the air temperature in the zone is above 22°C (71.6°F), which is the temperature above which window opening is enable when the outside temperature is lower than the inside temperature, and below the setpoint for mechanical cooling. Ceiling fans and blinds that block direct beam solar radiation are deployed in cooling mode. The natural ventilation modeling is described in further detail in the following subsection.
4. **NV2 Natural Ventilation with Cooling Load Reduction Measures:** This is the natural ventilation model with the aggressive set of cooling load reduction measures added.

The rationale for modeling these four scenarios for each building model is as follows. It is widely accepted that a building must minimize its cooling load in order to make natural ventilation feasible in all but the most benign climates. An aggressive set of cooling load reduction measures was therefore developed specifically to increase the efficacy of natural ventilation based on the work of McConahey (2008) and on the *Advanced Energy Design Guide for*

Small to Medium Office Buildings (ASHRAE *et al.*, 2011). Modeling the four scenarios allows the separation of the energy and cost savings due to the load reduction measures from the savings due to natural ventilation. Table 2.7 presents the list of cooling load reduction measures implemented in the retrofit models. Most are straightforward, but several require further description.

Lighting and Interior Equipment Power Density Reduction

This measure reduces the internal gains by reducing power densities to the levels recommended in the above AEDG (ASHRAE *et al.*, 2011).

Ceiling Fans

Ceiling fans offer a reduction in cooling load by providing air movement that increases the operative temperature at which occupants feel comfortable. For this study, it is assumed that ceiling fans enable a 1.4°C (2.5°F) increase in the upper limit of the thermal comfort band, based on ASHRAE Standard 55-2010. The additional plug load due to the overhead fans is accounted for as follows. Based on the estimate that one 950W overhead fan can serve 250 ft², the interior equipment power density for the model is increased by 0.861 W/m² (0.08 W/ft²). The ceiling fan load profile follows the general interior equipment daily load profile except that ceiling fans do not run during the colder part of the year (November 1 through March 31).

Supply Air Temperature Reset

The supply air temperature setpoints in the multi-zone buildings (Large and Medium offices) are reset so as to maintain the supply air temperature at the highest possible value that will satisfy all the zone cooling loads at minimum supply air flow rate (the 'Temperature First' strategy in EnergyPlus). This strategy was found to perform better, in terms of energy consumptions, than the strategy that finds the lowest supply air flow rate that will satisfy all the zone cooling loads at the maximum setpoint temperature (the 'Flow First' strategy in EnergyPlus).

Solar Shading

Overhangs and side fins reduce the cooling load by decreasing the amount of solar radiation that reaches the window. In the models, overhangs are installed above all south, west and east facing windows, while vertical fins are installed on all east and west facing windows. The shading devices were sized using the free online tool from Sustainable by Design (http://www.susdesign.com/overhang_recs/index.php). The depth of the overhangs and fins is equal to 65% of the window height. The height of the overhang above the window and the distance of the fin from the window edge are both 10% of the window height.

Supply air temperature reset control, Venetian blinds and ceiling fans were implemented in all three of the scenarios other than the baseline on the assumption that, in practice, each measure would be cost-effective enough to be implemented as part of any retrofit intervention.

Table 2.7: Cooling Load Reduction Measures

Measure Category	Cooling Load Reduction Measure
Program	<ol style="list-style-type: none"> 1. Reduce the lighting power density from 13.99 to 8.07 W/m² (1.3 to 0.75 W/ft²) 2. Reduce the interior equipment power density from 8.07 to 5.92 W/m² (0.75 to 0.55 W/ft²) 3. Implement daylighting controls 4. Install ceiling fans 5. Implement supply air temperature reset based on the warmest zone for multi-zone buildings (Large and Medium offices)
Fabric	<ol style="list-style-type: none"> 1. Decrease SHGC and U-value of windows to Title 24 2008 standards 2. Install exterior solar shading (overhangs and fins) 3. Install Venetian blinds, controlled to 'block beam solar' (some beam is transmitted due to reflection between slats).

2.3.4 Natural Ventilation Modeling

Natural ventilation is modeled using the Airflow Network, a bulk airflow model integrated with EnergyPlus. Operable windows are modeled using the Detailed Opening object.

Key Features of the Natural Ventilation Modeling are as Follows.

HVAC Control

The medium and large offices each have four perimeter zones and one core zone, as depicted in Figure 2.22. Only the perimeter zones have windows, thus only the perimeter zones have natural ventilation. In the small office model, the entire building is a single zone and is served by natural ventilation. All zones with natural ventilation operate in 'mixed mode' – the mechanical heating and cooling system operates to prevent the zone air temperature falling below the heating setpoint or exceeding the cooling setpoint, as in a conventional system. When the zone temperature is between the temperature above which windows may open and the cooling setpoint, the VAV terminal boxes are forced closed; this control logic is implemented in the EnergyPlus Energy Management System (EMS), which allows code added by the user to supplement the pre-defined control algorithms. The mixed mode control algorithm implemented is conservative in that it uses setpoint values that vary only with time of day and not with the outside temperature history, as in the adaptive comfort model for natural ventilation. The number of hours of during which the zone temperature setpoint was exceeded was used as the metric for thermal discomfort; by this metric, thermal discomfort was predicted to occur in less than two percent of the occupied hours.

Window Opening Area

The opening area of the windows is equal to 5% of the zone floor area. The opening area is modulated by applying a multiplier that is proportional to the indoor - outdoor air temperature difference, within a band, as depicted in Figure 2.26.

Figure 2.26: Modulation of the Window Opening Area Based on Indoor-Outdoor Temperature Difference

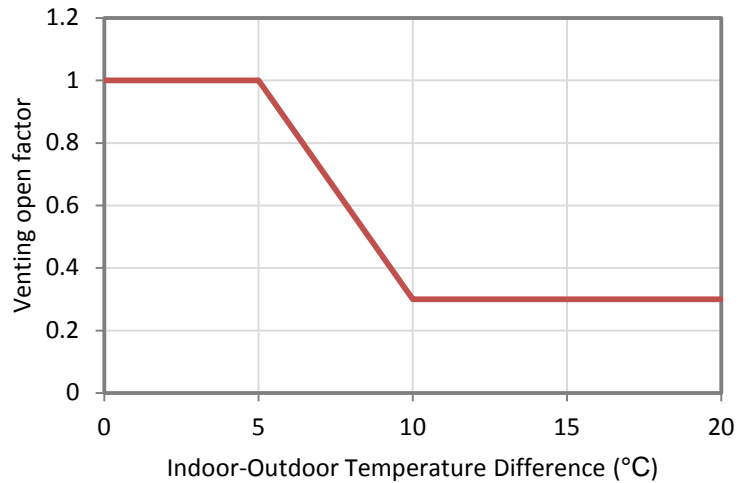

Wind pressure coefficients: Wind pressure coefficients for the buildings were taken from the examples in the ASHRAE Handbook of Fundamentals, which apply to cuboidal buildings on unobstructed sites. Figure 2.27 shows a schematic of the window geometry and wind pressure node locations for the medium and large offices. In the medium and large office models, the perimeter zones are limited to single sided ventilation by the zone configuration. The perimeter zones are each assigned two wind pressure nodes, rather than one surface average wind pressure coefficient. The two wind pressure nodes are then assigned different wind pressure coefficients (again, taken from the ASHRAE Handbook of Fundamentals) and therefore have different wind pressures, generating single-sided, wind-driven steady flow. This model is based on the assumption that each perimeter zone has no internal partitions or other obstructions that would significantly impede flow between the two operable windows. The sequence of activities in the Program reported here was such that it was not possible to use the new models developed in Project 3, and described below, in this study, which constituted part of Project 1. The configuration of the small office, however, allows for cross ventilation and the windows are each assigned surface average wind pressure coefficients.

Figure 2.27: Schematic Elevation of the Office Building Model With Window Geometry and Wind Pressure Nodes

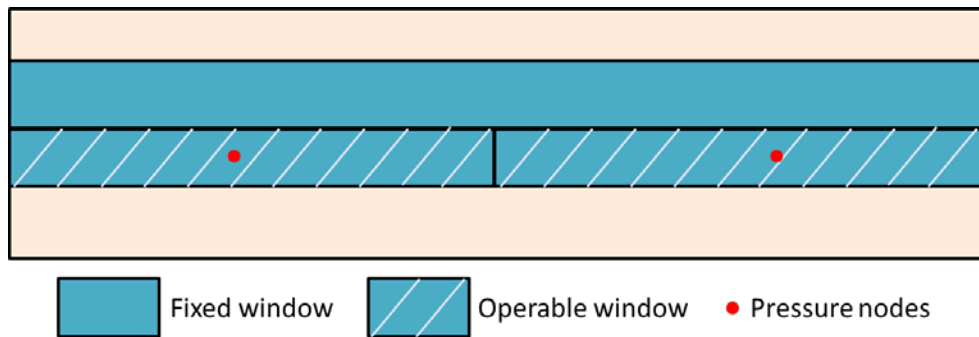

[Schematic, not to scale]

2.3.5 Estimating Statewide Energy Savings from Building Models

Weighting factors were used to scale modeled energy consumption values to produce estimates for all offices in California. The adopted approach borrows from a method originally developed by Pacific Northwest National Laboratory (PNNL) that used the DOE commercial building prototypes and statistical weights based on national disaggregated construction volume data to estimate national energy savings associated with the new ASHRAE Standard 90.1-2010 (Thorton *et al.* 2011). The scaling method used here accounts for the mix of office buildings by size and by the estimated floor area of offices in each climate zone. Weighting factors were calculated using 2011 census population data (see footnote [13]) and 2006 electricity use data from the CEUS database (CEC, 2006). A detailed explanation of the weighting factor calculation method is given in Section 2.3.12. The method is also described in Dutton *et al.* (2013).

2.3.6 Energy Consumption Results

EnergyPlus was used to perform annual simulations of each building type and vintage for each of the four scenarios described above for each climate zone. Figure 2.28 through Figure 2.30 show the EUI's for the heating, cooling and fan use by scenario for each building type. The values obtained for each CZ are averaged across the state, weighted by the total floor area of the particular building type in the particular CZ. The EUI for scenario B1 is substantially greater than the values for B2, NV1 and NV2 for the large and medium offices as compared to the small offices. One reason for this is that the B2, NV1 and NV2 retrofits are assumed to include provision of a supply air temperature reset (SATR) algorithm for the multi-zone buildings (large and medium) whereas it was assumed that all the baseline buildings that are older than the most recent vintage do not have SATR. (It is recognized that some of the older buildings will have had control systems retrofits that included SATR but the fraction is unknown.)

Figure 2.28: Breakdowns of HVAC EUIs by Scenario for the Large Office

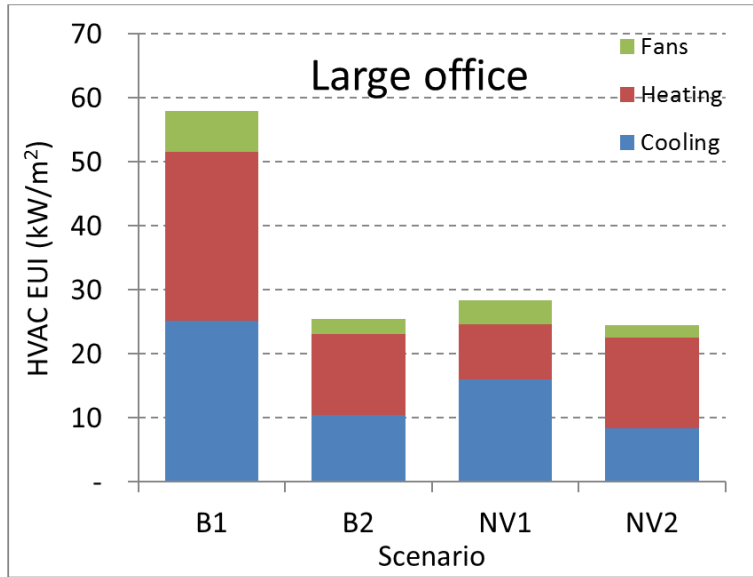

Figure 2.29: Breakdowns of HVAC EUIs by Scenario for the Medium Office

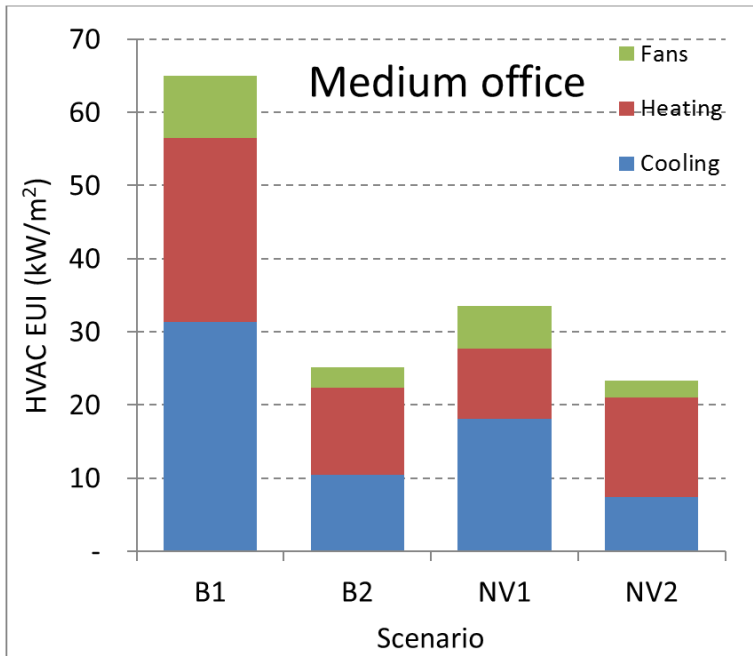
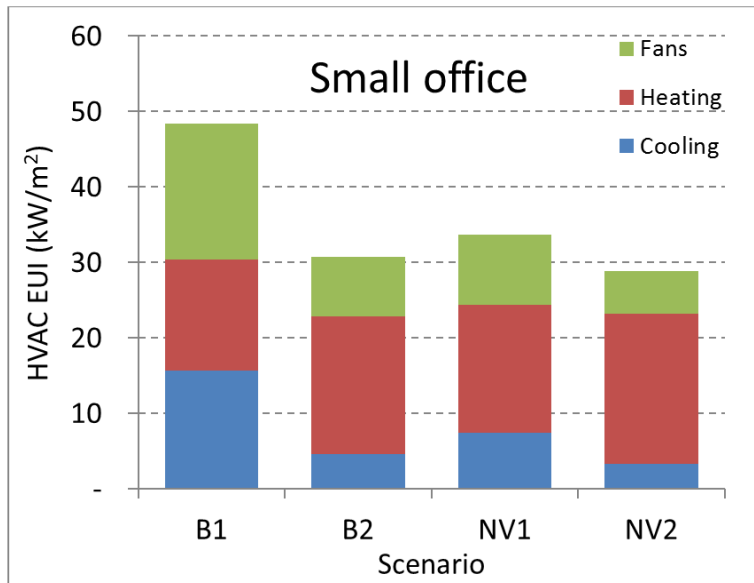

Figure 2.30: Breakdowns of HVAC EUIs by Scenario for the Small Office



The increased heating energy consumption in Scenarios B2 and NV2 is due to the lower heat gains from lights and plug loads relative to Scenarios B1 and NV1.

Figure 2.31 shows the state-wide site energy consumption and carbon emissions for the large, medium and small offices, broken down by scenario.

Figure 2.31: Breakdowns by Scenario of the State-Wide Site HVAC Energy Consumption (Left) and Carbon Emissions (Right) for the Large, Medium and Small Offices

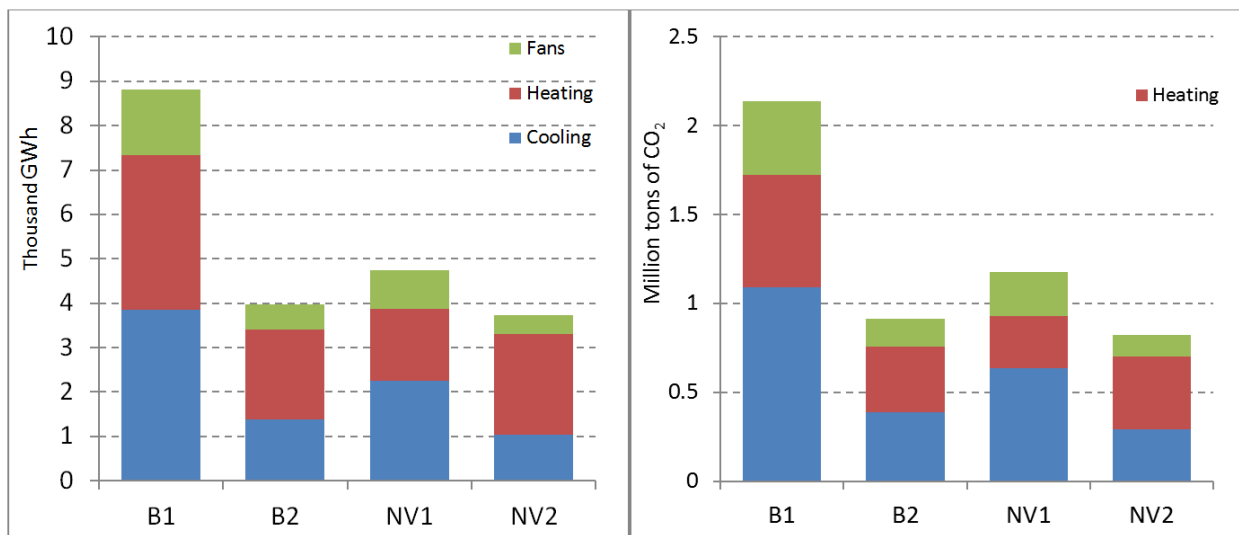

Figure 2.32 shows the breakdowns of the average HVAC EUI's for the heating, cooling and fan use for the Large, Medium and Small offices, weighted by floor area, for the 16 California Climate Zones.

Figure 2.32: Breakdowns of HVAC EUIs by Climate Zone and Scenario

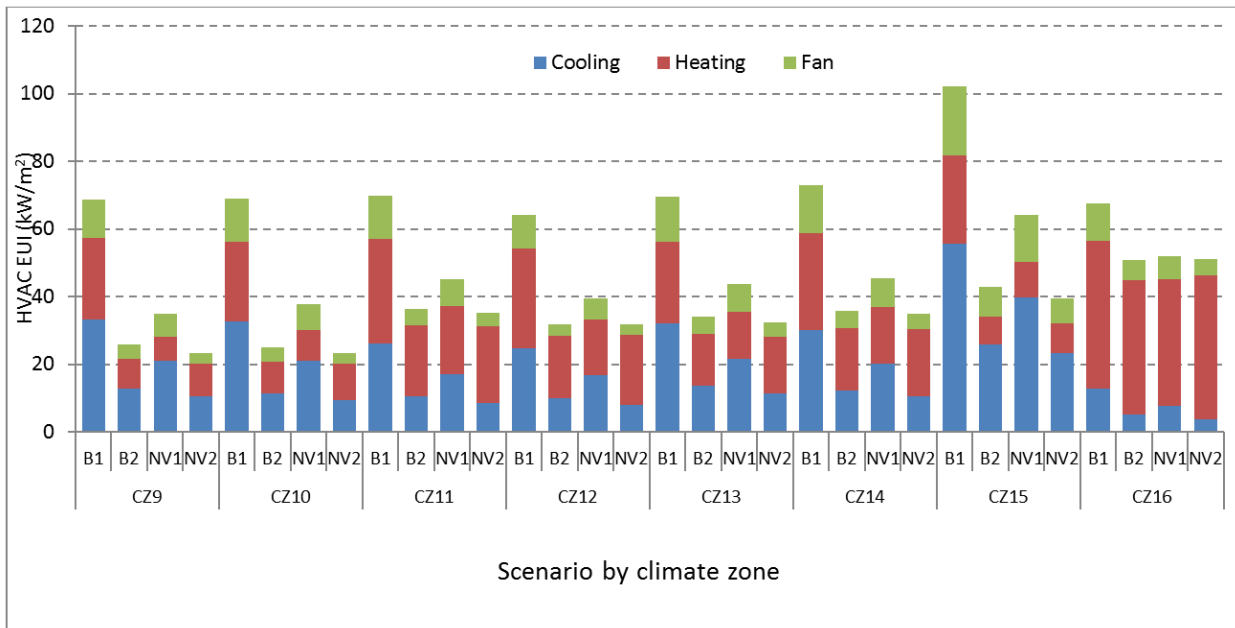
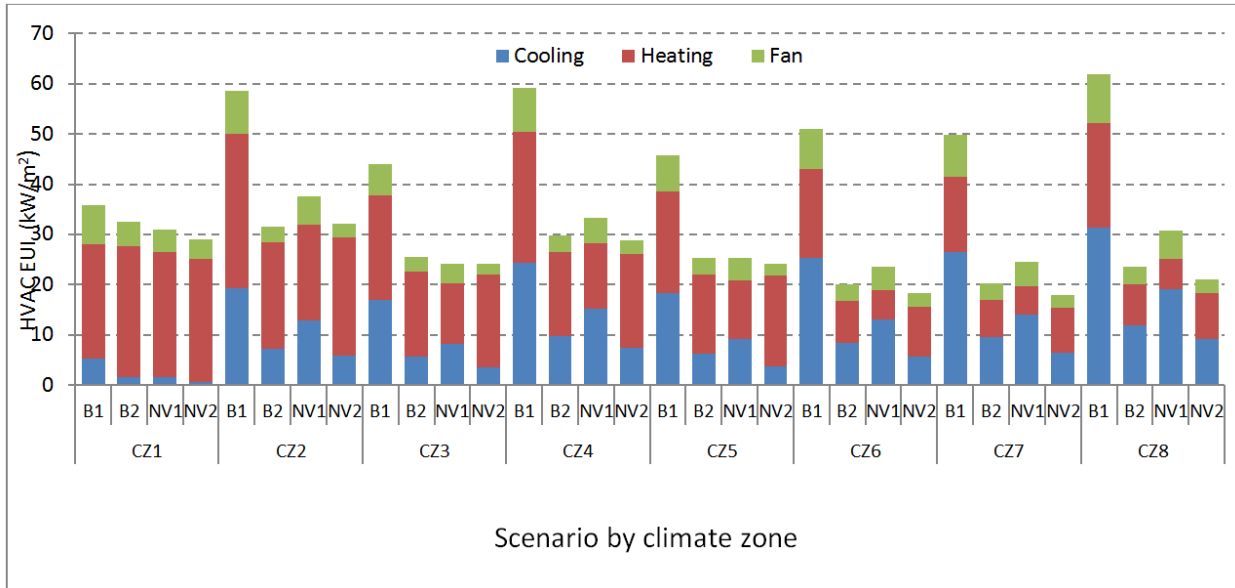

Figure 2.33 through Figure 2.35 show the breakdowns by scenario of the whole building EUI's for the large office. The energy savings for the high efficiency scenarios, B2 and NV2, are relatively greater than for the HVAC EUI's because of the electricity savings due to the reduced lighting power density and plug loads

Figure 2.33: Breakdowns of Whole Building EUIs by Scenario for the Large Office

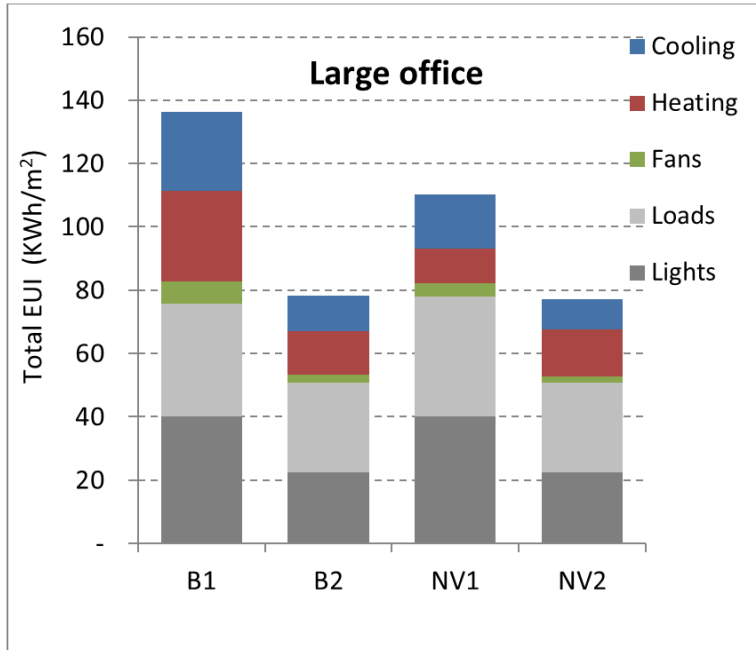

Figure 2.34: Breakdowns of Whole Building EUIs by Scenario for the Medium Office

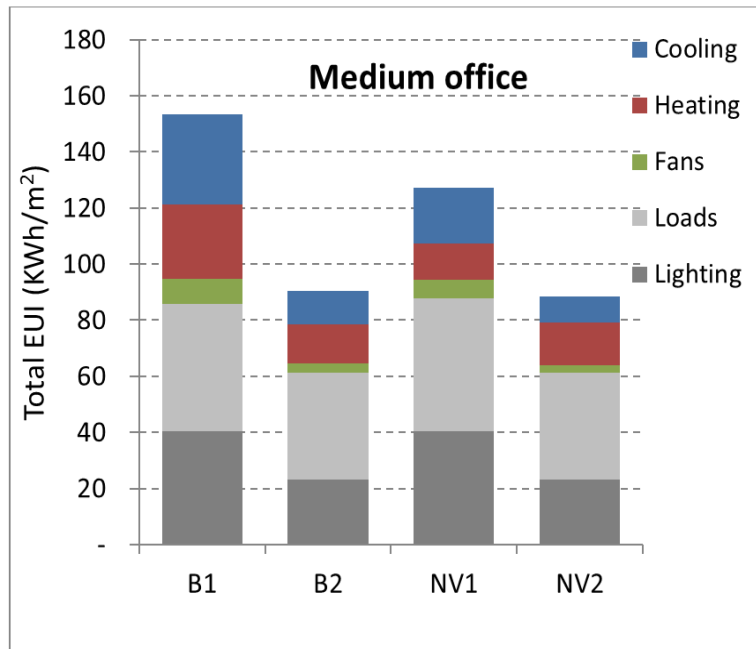

Figure 2.35: Breakdowns of Whole Building EUIs by Scenario for the Small Office

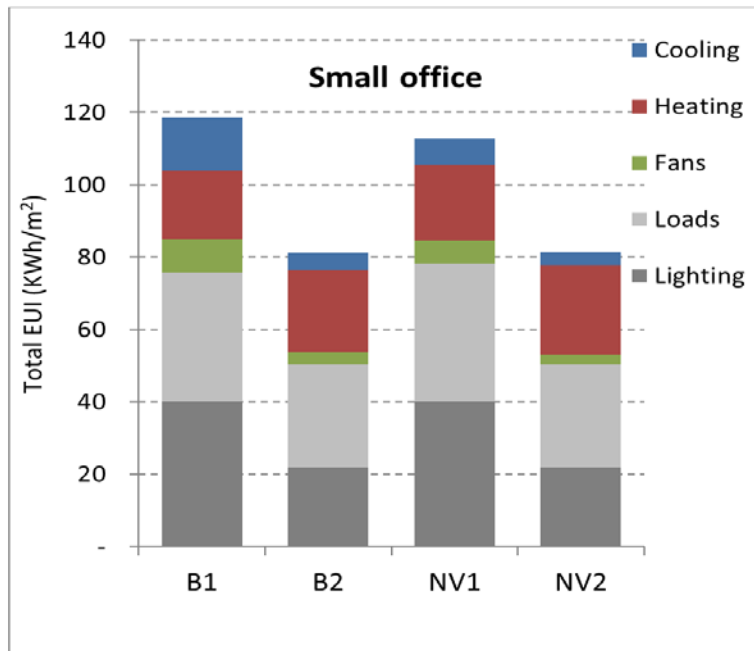

Figure 2.36 and Figure 2.37 show the state-wide electricity costs and cost savings by climate zone and scenario for the large, medium and small offices.

Figure 2.36: State-Wide Electricity Costs by Climate Zone and Scenario for the Large, Medium and Small Offices

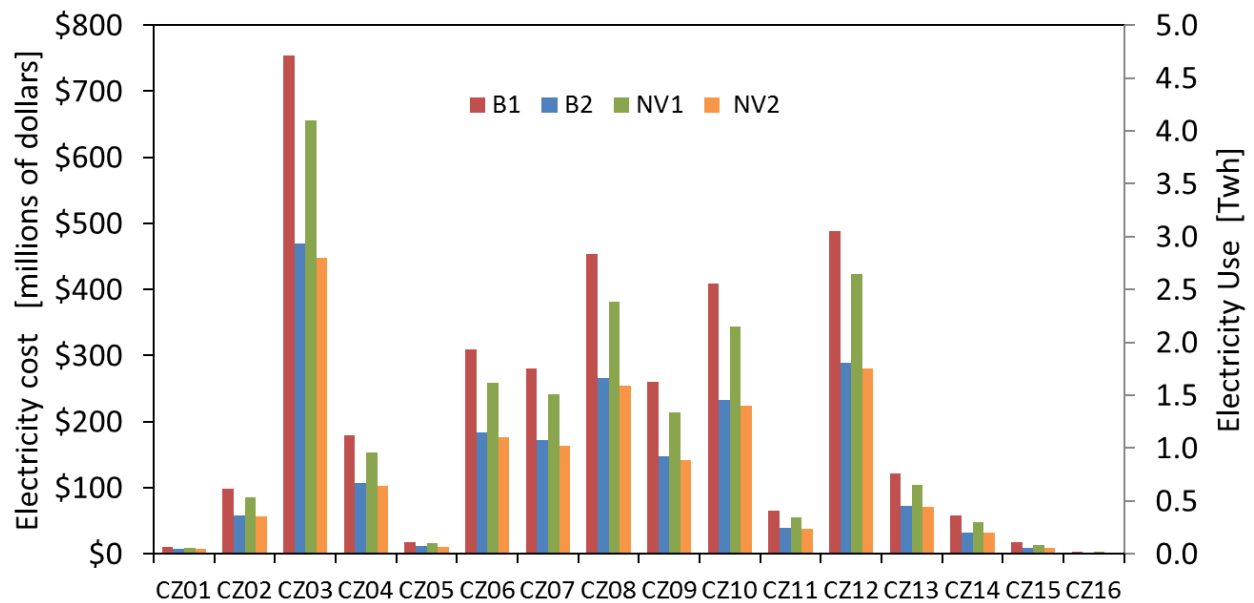

Figure 2.37: State-Wide Electricity Costs Savings by Climate Zone and Scenario for the Large, Medium and Small Offices

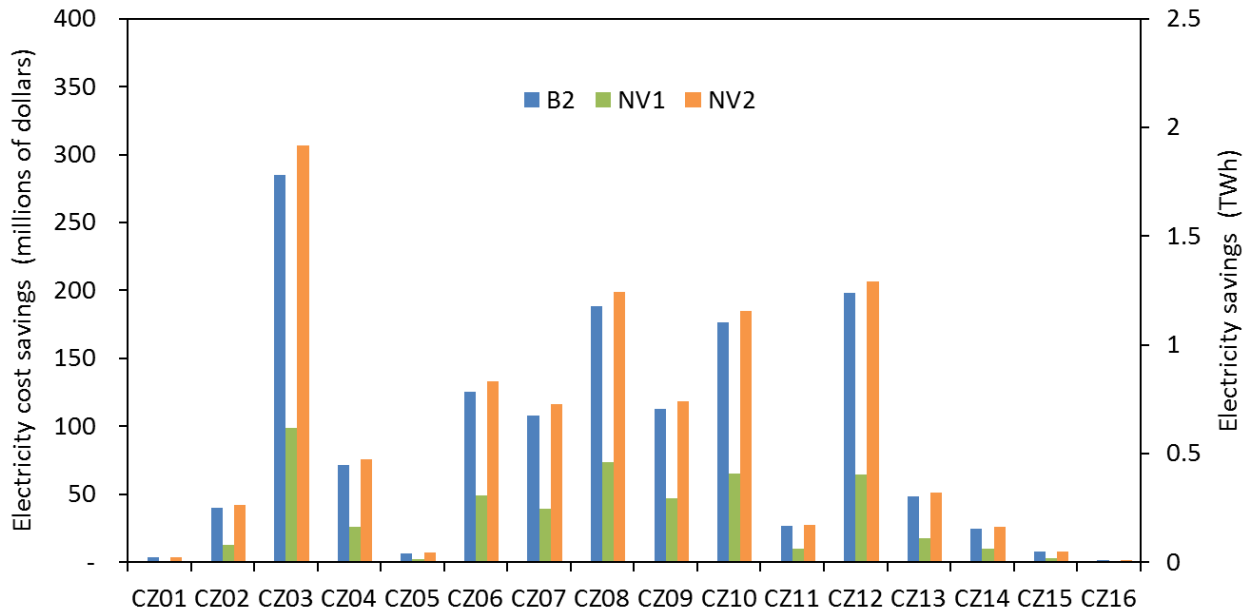
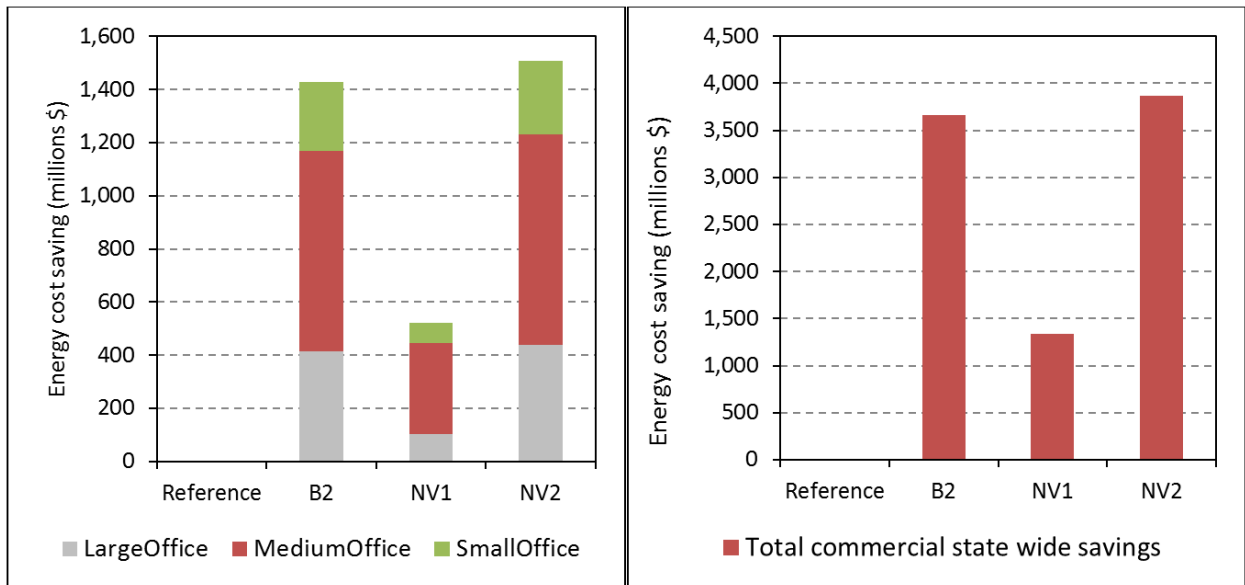

Figure 2.38: State-Wide Energy Cost Savings by Scenario for the Large, Medium and Small Offices (Left) and for all Applicable Building Types (Right)



The graphs shows the state-wide energy cost savings by scenario for the large, medium and small offices and for all applicable building types, as defined in section 2.3.2.

2.3.7 Energy Consumption Discussion

The results presented in Section 2.3.6 indicate that the savings obtained from the energy efficiency measures alone and from natural ventilation alone are by no means additive. A comparison of the results for the B1 and NV1 scenarios in Figure 2.31 indicates that the cooling energy savings from natural ventilation alone are ~44%, though this includes savings from adding SATR control to the pre 2008 vintage buildings when implementing the natural ventilation retrofit. Comparison of the results for B2 and NV2 indicates that the cooling energy savings due to natural ventilation are ~25% once the efficiency measures and SATR control have been implemented in both cases. The absolute energy savings from natural ventilation after implementing the energy efficiency measures are ~17% of the savings from natural ventilation, and SATR control in pre 2008 buildings, without the energy efficiency measures.

It should be noted that the performance predictions and the associated savings estimates are based on generic natural ventilation system designs that have not been optimized in terms of window configuration and internal layout of partitions and openings. Consequently, the results presented here may not represent the full technical potential of the systems considered.

2.3.8 Construction Cost Estimation

The construction cost estimates developed for this study were prepared by a team of certified cost engineers in coordination with the design team in a multidisciplinary approach. The level of accuracy for the estimates was based on recommendations set forth by the Association for the Advancement of Cost Engineering International (ACEI), which were used to develop the estimate classification matrix in Table 2.8. The five levels are based on the level of completion of the design.

Table 2.8: Estimate Classification Matrix

Estimate Level	Estimate Description	Design Phase	Level of Design Completion	Methodology	Accuracy Range
5	Rough Order of Magnitude	Planning Schematic Design	0% to 5%	Parametric Models Capacity Factored Historical Costs	L: -20% to -50% H: +30% to +100%
4	Concept Feasibility	Planning Schematic Design	1% to 15%	Equipment Factored Parametric Models	L: -15% to -30% H: +20% to +50%
3	Budget Authorization	Planning Schematic Design Design Documents	10% to 40%	Unit Costs Assemblies	L: -10% to -20% H: +10% to +40%
2	Budget Control Estimate	Preliminary Design Engineering Design Documents Construction Documents	30% to 70%	Detailed Unit Cost with Forced Detailed Take-Off	L: -5% to -15% H: +5% to +30%
1	Bid	Detailed Design Engineering Construction Documents	50% to 100%	Detailed Unit Costs Detailed Take-Off Production Based Estimate	L: -2% to -5% H: +3% to +15%

Construction cost estimates were developed for each of the retrofit scenarios (B2, NV1, and NV2) described in Section 2.3.3 above. Assuming three standard baseline models for small, medium, and large office buildings, each scenario represents a baseline building that would require retrofits to improve energy efficiency and/or to allow for mixed mode operation. A list of retrofit construction activities was determined for each scenario and building size. Required retrofits were broken down into four categories: Energy Efficiency (EE) improvements, HVAC modifications, façade modifications for Operable Windows (OW), and additional building systems controls for Mixed Mode (MM) operation. Table 2.9 shows which retrofits were considered for each scenario.

Table 2.9: Consideration of Required Retrofits per Scenario

Scenario	Retrofits Required
B1	-
B2	EE, HVAC
NV1	OW, MM
NV2	EE, HVAC, OW, MM

Each retrofit category contains a menu of construction activities that were applied based on building size and HVAC system type. Table 2.10 provides a list of the key activities considered per retrofit category.

Table 2.10: Key Construction Activities per Retrofit Category

EE	HVAC	OW	MM
Add external shading	Upgrade DDC controls	Replace portion of fixed windows with operable windows	Add motorized window actuators and associated controls
Replace glazing	Add VFD to pumps		Add weather station
Replace lighting with high efficiency lamps	Replace constant volume system with variable air volume		
Reduce plug load (add occupancy control)			
Add ceiling fans			

A range of construction costs was determined for each of the activities listed in Table 2.10 to account for the variations within each scenario. This was done to capture the level of intensity required for each retrofit across the climate zones and vintages that make up the existing building stock in California. These estimates are classified as Class 5 Rough Order of Magnitude with the primary characteristic being the conceptual level of design definition. The pricing used is current year 2014 USD and is based on an internal database of benchmarked projects and input from local San Francisco Bay Area contractors and suppliers.

The Construction Costs Include the Following Items:

- construction price, including
 - contractor direct costs
 - contractor indirect costs/general conditions

- contractor overhead and profit

The Following Owner Soft Costs are Excluded:

- preliminary engineering
- final design
- project management for design and construction
- construction administration and management
- professional liability and other non-construction insurance
- fees for legal, permits, reviews, surveys, testing, inspection and start up
- Owner contingency
- escalation beyond 2014

2.3.9 Cost Benefit Analysis

Table 2.11 summarizes the costs for different scenarios and notes the dependence on vintage and size. A simple return on investment (ROI) metric has been defined for use as a cost-effectiveness metric:

$$ROI = \frac{\textit{Annual savings}}{\textit{Implementation cost}}$$

ROI is then the fraction of the implementation cost that is paid back each year, equivalent to a simple interest rate paid by the investment in the retrofit measures. It is also the reciprocal of the simple payback period. Figure 2.39 shows the state-wide return on investment by vintage for the large, medium and small offices for Scenario B2.

The ROI is substantially greater for the late vintage buildings because it is assumed that they already have windows that comply with Title-24 2008 whereas the retrofit measures for the earlier vintages include upgrading the windows to comply with Title-24 2008. The other measures shown in Table 2.7 have significantly greater ROI's than the window replacement measure. In particular, the implementation of the SATR control algorithm for the Large and Medium offices in the earlier vintages is very cost effective. It does not contribute to the ROI for the late vintage buildings because it is assumed that it is already implemented in the corresponding baseline buildings. The increase of ROI with size for the late vintage buildings is a reflection of the lower ROI for the envelope measures compared to the reduced ROI for lighting power density and interior equipment power density, which is independent of size.

Table 2.11: Summary of the Costs per Unit Floor Area of the Different Retrofit Measures Simulated

		Small Office (\$/sf)	Medium Office (\$/sf)	Large Office (\$/sf)	Comments
B2	Energy Efficiency	10.08 - 30.09	6.22 -19.31	3.89 -14.18	Low: 2008 vintage, no new glass
	HVAC controls	0	0.00 - 0.84	0.00 - 0.39	Low: no controls retrofit
	Total	10.08 - 30.09	6.22 -20.15	3.89 -14.57	
NV1	Energy Efficiency	2.29	1.92	1.80	Ceiling fans & Venetian blinds
	HVAC controls	0	0.00 - 0.84	0.00 - 0.39	Low: no controls retrofit
	Operable Windows	1.00 - 11.00	0.76 - 6.12	1.69 - 4.93	Low: pre-1941, already operable
	Total	3.29 - 13.29	2.68 - 8.88	3.50 - 7.12	
NV2	Energy Efficiency	10.13 - 20.13	6.23 -13.97	3.98 - 10.77	Low: 2008 vintage, no new glass
	HVAC controls	0	0.00 - 0.84	0.00 - 0.39	Low: no controls retrofit
	Operable Windows	1.00 - 11.00	0.76 - 6.12	1.69 - 4.93	Low: pre-1941, already operable
	Total	11.13 - 31.13	6.99 -20.93	5.68 - 16.09	

Figure 2.39: State-Wide Return on Investment by Vintage for the Large, Medium and Small Offices for Scenario B2

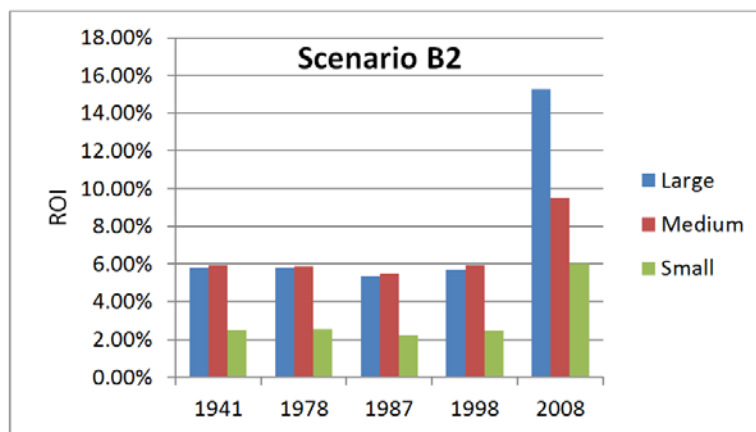

Figure 2.40 shows the state-wide return on investment by vintage for the large, medium and small offices for Scenario NV1. The higher ROI values for the early vintage buildings reflect the assumption that buildings built before the adoption of mechanical cooling in California have windows that were originally operable and that the cost of restoring them to operability is an order of magnitude less than the cost of replacing fixed windows. The ROI for the Medium office is significantly greater than for the Small office because of the benefits of implementing SATR in all but the late vintage buildings. The Large Office also benefits from SATR but the cost/benefit is offset by the cost of providing the motorized actuators for all the windows required for smoke control in high rise buildings.

Figure 2.40: State-Wide Return on Investment by Vintage for the Large, Medium and Small Offices for Scenario NV1

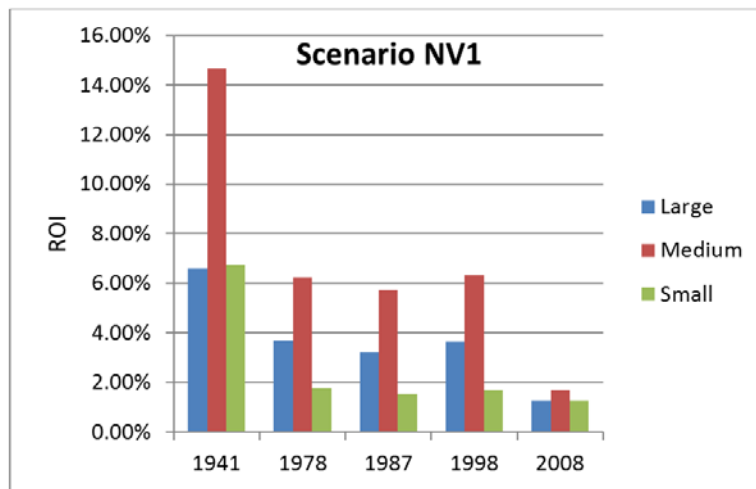

Figure 2.41 shows the state-wide return on investment by vintage for the large, medium and small offices for Scenario NV2. In contrast to the NV1 scenario, the predicted ROI is no greater for the early vintage buildings because it is assumed that the cost of upgrading the windows to Title 24 2008 standard is not significantly different for previously operable windows than for previous fixed windows. As in the NV1 scenario, the late vintage case shows a higher ROI because the expensive glazing replacement measure is not required, though this difference is offset by SATR being included in the baseline scenario.

Figure 2.41: State-Wide Return on Investment by Vintage for the Large, Medium and Small Offices for Scenario NV2

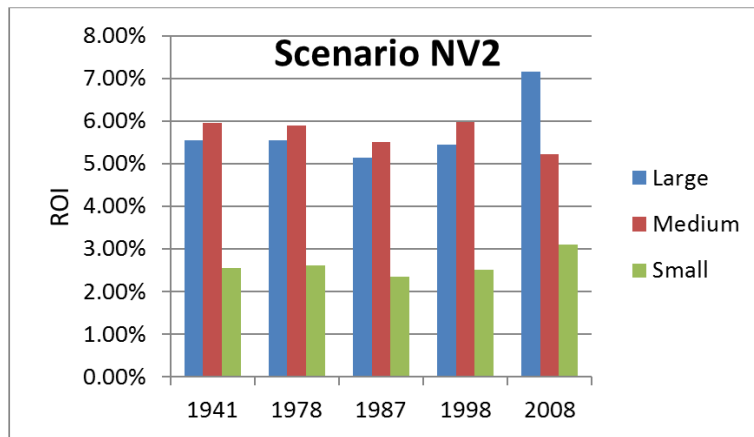
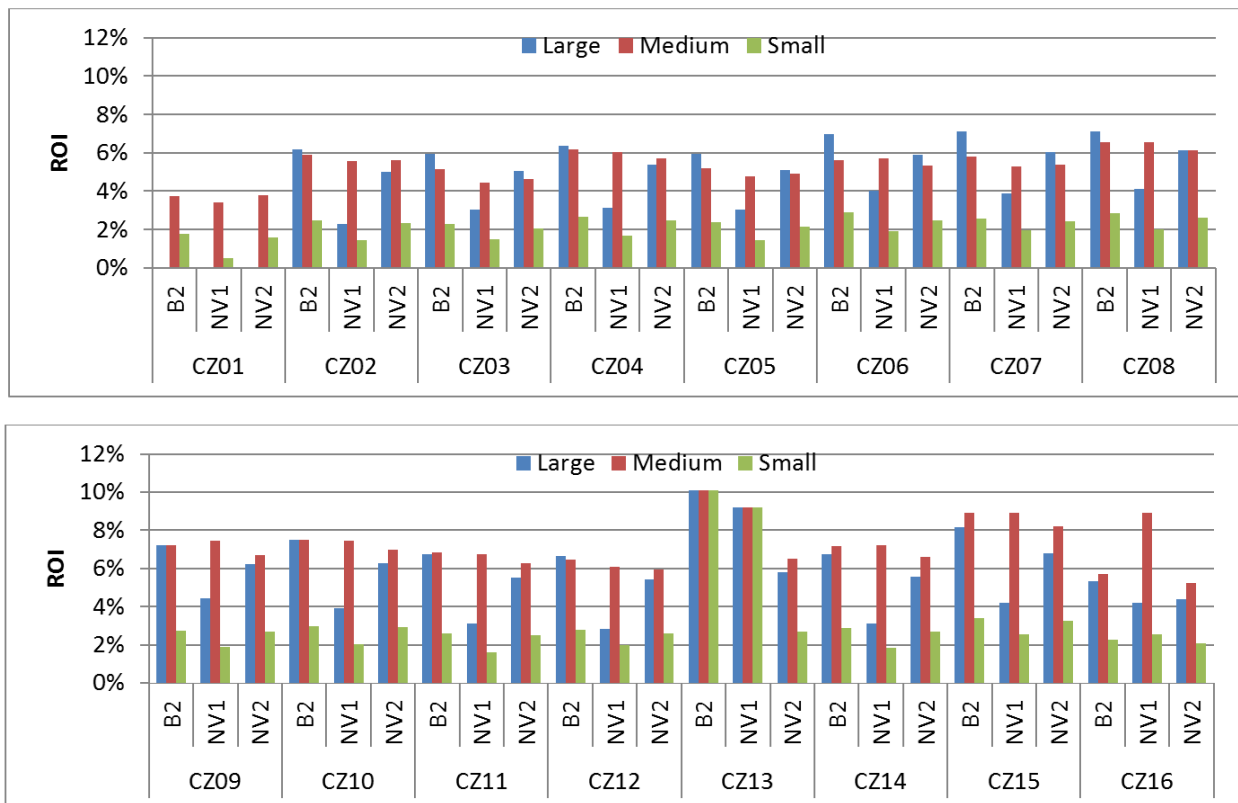

Figure 2.42 shows the results presented in Figure 2.39 through Figure 2.41 broken out by climate zone. The ROI's increase from CZ1 to CZ15, reflecting the increased opportunity for savings presented by the increased cooling loads. CZ1 and CZ16 have significantly lower cooling loads than the other climate zones. There are no large office buildings in CZ1 in the 2003 CEUS database used in the project.

Figure 2.42: State-Wide Return on Investment by Climate Zone and Scenario for the Large, Medium and Small Offices



2.3.10 Cost Benefit Discussion

The key conclusions of the cost benefit analysis can be summarized as follows:

- Control system upgrades that enable SATR have a good ROI, as indicated by the results for the non-late vintage Large and Medium offices compared with the corresponding results for the Small office.
- Light power density and plug load reduction measures also have a good ROI compared to envelope load reduction measures (blinds and exterior shading), as indicated by the scenario B2 results for late vintage buildings, to which window replacement and SATR are not applicable.
- Unsealing previously operable windows to re-enable natural ventilation may have a good ROI, though costs are more uncertain than for the other measures considered.
- The cost of replacing fixed windows with operable windows has a low ROI, as does upgrading fixed windows.

In situations where the use of natural ventilation, primarily in new construction, enables the cost of a mechanical cooling system to be avoided, the ROI appears likely to be much higher, though this situation was outside the scope of the analysis reported here.

It should be noted that the cost estimates used in the analysis reported here are necessarily approximate, since detailed designs were not produced.

2.3.11 Recommendations

Development of detailed natural ventilation system designs would allow system performance to more closely approach its optimum. This would allow improved estimates of cost effectiveness that could be used to inform utility incentive programs.

The analysis reported here did not include explicit disaggregation of the different measures in each of the main scenarios (B2, NV1 and NV2), so a number of the conclusions reported above were inferred by comparing the results for different cases, typically particular combinations of scenario and vintage. A more detailed analysis that involves disaggregation of different measures would produce explicit estimates of the ROI of the different measures.

2.3.12 Appendix: Detailed Weighting Method

CEUS is a “stratified random sample of 2,800 commercial facilities” collected mostly in 2003, from the “service areas of Pacific Gas & Electric, San Diego Gas and Electric, Southern California Edison, Southern California Gas Company and the Sacramento Municipal Utility District” (CEC, 2006).

We based our estimates of the distribution of office energy use among climate zones on CEUS statewide electricity use data. The CEUS data provided electricity use for California, broken down by building type, size, and forecasting climate zone. However, CEUS building size categories differ from the sizes of the three U.S. DOE office building reference models. CEUS groups all offices as being either small or large. Small offices are then divided into small,

medium and large subcategories. The large offices are divided into small, medium, large and census. Census buildings were a group of exceptionally large buildings that were included in the census. The DOE office models are categorized as small medium and large, without any subdivisions. Therefore, we mapped building energy model types onto the CEUS building types, as shown in Figure 2.43. This mapping allowed us to estimate the amount of electricity consumed by each building energy model type, given in Figure 2.44.

Figure 2.43: CEUS to U.S. DOE Building Mapping

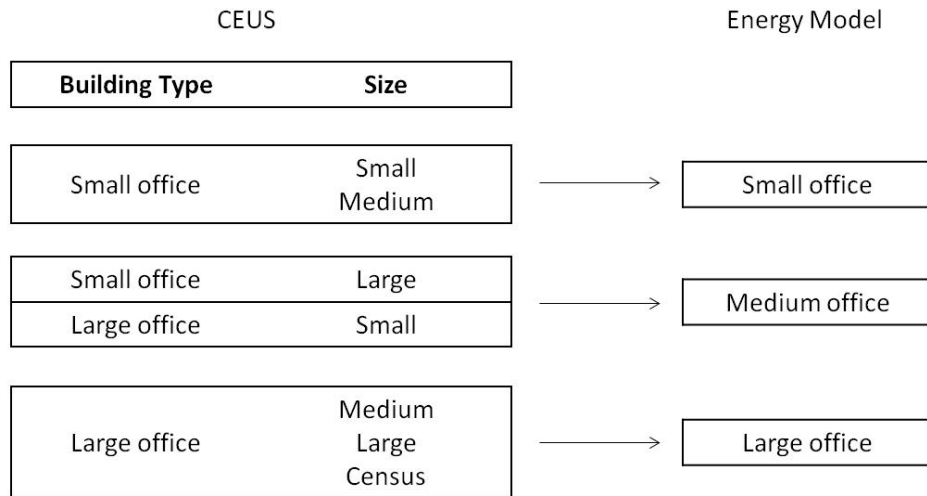

The forecasting climate zones of CEUS also differ from Title-24 climate zones. To generate weights for each of the Title-24 climate zones, we mapped electricity use from CEUS, categorized by forecast climate zone, to electricity use by Title-24 climates zones. This mapping entailed obtaining a list of California cities and their populations, and then identifying the Title-24 climate zone and forecast climate zone applicable to each city, using two data sets.^{12;13,14} Using this mapping, we binned population in each forecast zone by Title-24 climate zone to generate the “population weights” given in Table 2.12. Next, we multiplied population weights from Table 2.12 by the total energy use for each forecasting climate zone from CEUS, to calculate the total electricity energy use per Title-24 climate zone and building type, as shown in Figure 2.44. The buildings surveyed for the CEUS only included buildings that fell within the areas where electricity is provided by the group of Investor Owned Utilities (IOU). The utilities that are not

¹² California Department of Finance, E-1: City/County Population Estimates with Annual Percent Change – January 1, 2011 and 2012 http://www.dof.ca.gov/research/demographic/reports/estimates/e-1/documents/E-1_2012_Internet_Version.xls

¹³ California Energy Commission, Building Energy Efficiency Standards, Reference Appendices, Appendix JA2. 2008. http://www.energy.ca.gov/maps/renewable/building_climate_zones.html

¹⁴ California Emissions Estimator Model, User’s Guide, Appendix F: <http://www.aqmd.gov/docs/default-source/caleemod/climatezoneszipcode.xls?sfvrsn=2>

part of the Investor Owned Utilities (IOU) group, include the Sacramento Municipal Utility District (SMUD), the Los Angeles Department of Water and Power (LADWP), and various different municipal utilities. Based on consultation with the Energy Commission, and data provided on state wide total commercial building electricity use, two different scaling factors were calculated and applied to the state wide electricity use reported in CEUS . A scaling factor of 1.31 was applied to account for the additional areas not covered by the IOU's, and a second factor of 1.10 was then used to scale from 2002 electricity use to 2009 consumption. No complete data were available for 2010 onwards.

Table 2.13 summarizes the CEUS data representing total energy use by forecast zone. The areas of California where electricity use data were not collected for CEUS are concentrated in forecast climate zones 11, 12, 14, 15, and 16. Of these areas, the only one that contains significant population centers is forecast climate zone 12, which includes parts of Los Angeles. The missing energy use data from forecast climate zone 12 corresponds to missing energy use data from Title-24 climate zone 9, which, if it had been present, would have resulted in minor corrections to the weighting factors used in this study. This limitation is not expected to have significantly impacted the overall results of the study.

Figure 2.44: Estimated Electricity Use by Title-Twenty Four Climate Zone and Office Size

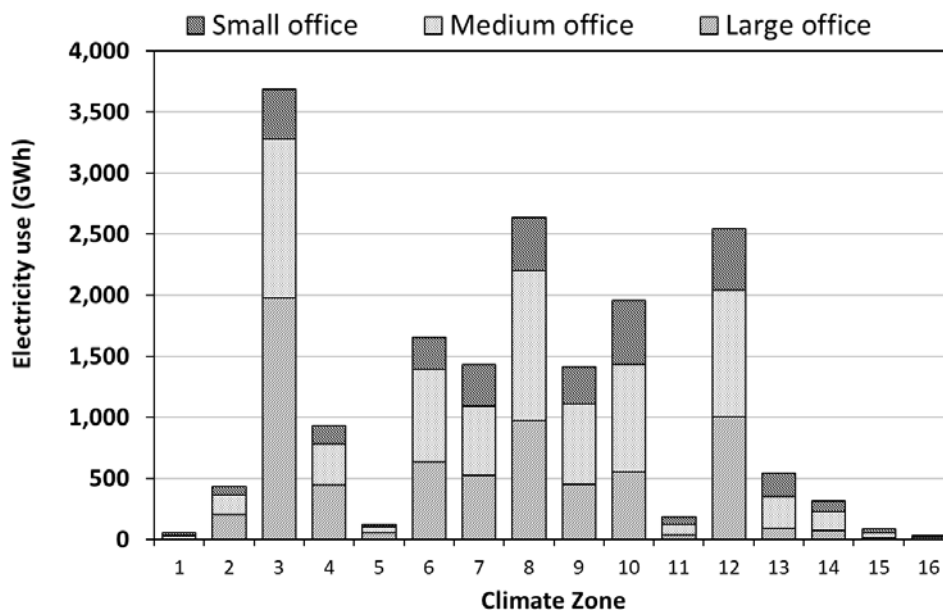

We estimated the total floor area for each building group by dividing the disaggregated electricity use given in Figure 2.44 by the average electricity energy use intensity for that building group in the CEUS Database. For example, if the average electricity EUI for large offices in CZ12 from the 1987 vintage was 100 kWh/m² and the estimated stock electricity use was 100 million kWh, then the estimated floor area would be 1 million m². The estimated floor areas for all 240 building groups are presented in Table 2.14. CEUS does not contain data beyond 2003; for the 2008 vintage, an incremental increase in statewide electricity use of 10%

was assumed, and an improvement in EUI of 10% over the previous vintage (1991-2003) was assumed in estimating the floor area of the stock built to 2008 Title 24 code.

Finally, the energy savings for each building model were estimated by first multiplying the EUI's for each building model by the estimated floor area for that building group to get the total stock energy use. The difference between the baseline model stock energy use and the stock energy use for each of the retrofit scenarios, represent the statewide energy savings attributed to the retrofits.

Table 2.12: California Population, Proportional Population Breakdown by Forecasting Climate Zone and Title-Twenty Four Climate Zone

		Forecasting Climate Zone																Total	
		1	2	3	4	5	6	7	8	9	10	11	12	13	14	15	16		
T24 Climate Zone	1	0.41																0.01	
	2	0.20			0.11	0.05													0.02
	3			0.00	0.08	0.93													0.11
	4				0.47														0.06
	5				0.06														0.01
	6								0.36	0.03				0.05					0.06
	7													0.57					0.05
	8								0.51	0.30		0.89							0.17
	9								0.09	0.55		0.11	0.99					1.00	0.15
	10								0.04	0.02	0.79			0.38					0.12
	11	0.09	0.20	0.18															0.03
	12	0.30	0.79	0.24	0.27	0.02	1.00												0.12
	13			0.58	0.00				0.88										0.06
	14			0.01					0.06		0.09	0.13							0.02
	15										0.08						1.00		0.02
	16		0.02	0.00					0.06		0.00	0.00		0.01		1.00			0.01
	Total	1.00	1.00	1.00	1.00	1.00	1.00	1.00	1.00	1.00	1.00	1.00	1.00	1.00	1.00	1.00	1.00	1.00	1.00

Table 2.13: Electricity Use (GWh) for California Offices, Broken Down by Building Type and Forecasting Climate Zone

		Forecasting climate zone															Total	
		1	2	3	4	5	6	7	8	9	10	11	12	13	14	15		16
Building Type	Large Office		77	104	941	2,039	624	32	1,611	533	154			926				7,041
	Medium Office	70	122	333	725	1,338	612	70	1,897	877	515			995				7,554
	Small Office	71	82	229	313	406	272	70	602	438	330			606				3,418
Total		141	281	666	1,979	3,783	1,507	172	4,110	1,848	999			2,526				18,012

Table 2.14: Estimated Floor Areas by Building Type, Vintage and Climate Zone (Thousand M²)

California Climate Zone	Large Office					Medium Office					Small Office				
	1941	1978	1987	1998	2008	1941	1978	1987	1998	2008	1941	1978	1987	1998	2008
CZ01						13	141	119	38	16	9	101	60	24	10
CZ02	53	568	640	510	219	74	785	667	212	91	23	242	143	57	25
CZ03	724	5,327	5,502	3,885	1,669	539	3,984	3,183	5,170	2,221	389	1,315	906	745	320
CZ04	79	840	947	548	235	173	1,237	786	718	308	44	758	435	365	157
CZ05	10	110	124	72	31	9	97	83	66	28	6	99	57	48	20
CZ06	153	1,630	1,668	1,171	503	224	2,388	1,918	1,163	499	62	667	175	770	331
CZ07	136	1,456	1,451	1,231	529	119	1,270	1,080	1,110	477	126	1,216	1,254	570	245
CZ08	251	2,678	1,685	1,343	577	249	2,656	2,672	1,804	775	108	1,154	1,154	920	395
CZ09	104	1,110	659	455	195	175	1,742	1,521	1,212	521	8	957	765	332	143
CZ10	95	1,011	858	684	294	280	1,579	2,330	1,337	574	169	3,119	2,149	882	379
CZ11	12	86	81	77	33	37	230	395	315	135	47	502	426	158	68
CZ12	363	2,597	2,444	2,332	1,002	392	2,773	1,641	2,095	900	411	1,225	1,216	926	398
CZ13	23	247	223	177	76	108	647	466	334	143	34	1,175	512	408	175
CZ14	12	131	111	89	38	39	420	357	285	122	17	184	156	125	54
CZ15	2	24	20	16	7	10	104	88	70	30	5	58	49	39	17
CZ16	1	11	10	8	3	2	23	20	16	7	2	25	21	17	7
Grand Total	2,018	17,827	16,423	12,598	5,412	2,443	20,076	17,325	15,942	6,848	1,463	12,796	9,480	6,385	2,743

2.4 Implementation and Barriers to Implementation

2.4.1 Introduction and Background

The goal of this task is to identify and evaluate barriers to implementation of natural ventilation in California commercial buildings related to culture, security, cost, acoustics, air quality and fire safety codes. The evaluation examines the validity of these barriers and, where appropriate, recommends means to reduce or remove them.

Note: Full details of the analysis of acoustics and fire barriers to implementation may be found in Appendices A and B, respectively.

2.4.1.1 Fire Safety Codes and Standards

Current building fire safety code language does not adequately consider an engineered approach for natural ventilation relative to fire/life safety and prescriptive code requirements often conflict with the needs of naturally ventilated buildings.

There are several challenges to implementing natural ventilation in new and existing buildings. New construction projects face stringent regulations regarding health and life safety. Most existing buildings have been designed based on sealed building concepts that oppose airflow through the façade to the interior portions. For old and new buildings, the benefits of natural ventilation need to be realized in an economical manner while maintaining the level of safety that is expected in modern design.

California is one of only a few state governing bodies in the United States that includes “occupant life safety” smoke control provisions among its fire safety regulations. These smoke control provisions, and their potential for inconsistent interpretation, can be a significant barrier to implementing natural ventilation strategies in high rise and atrium buildings

Section 403.4 of the California Building Code (CBC) governs high-rise structures and deviates from the model International Building Code (IBC) provisions by requiring a passive or active smoke control system. CBC Section 909.1 states that the objective of a smoke control system is to provide tenable conditions for the evacuation or relocation of occupants. Although this section presents a format from which a building’s fire protection systems might be properly engineered, application and interpretation of the requirements of this code section is subject to the approval of the local authorities.

The benefits of using a smoke control system in a sealed building are easily recognized. Since a natural path for smoke removal is not readily available, mechanical ventilation is used for mitigation. Using a smoke control system to create pressure differences across barriers or to prevent smoke migration through permanent openings, a designer does not have to consider much loss of airflow to the exterior for natural ventilation. The evacuation of occupants is protected by the system of pressurized barriers, while the floors themselves are not subject to the overpressures that drive smoke to other floors. With additional safety measures, such as fire and smoke barriers and automatic sprinkler systems, the model code provides a multifaceted approach to aid in protection of occupants.

2.4.1.2 Acoustic Design Standards

External noise breaking into buildings through ventilation openings is often used as an argument against natural ventilation and for supporting mechanical ventilation and air conditioning. The aim of this section is to identify the extent to which this perception of external noise as a problem may be unjustified and to reduce any unnecessary impediment to the use of natural ventilation in new or renovated buildings. Consideration of the feasibility of natural ventilation with regard to the external noise environment, and of the control of external noise break-in, is included.

Aspects of sustainable design not directly relevant to the perceived impediment that external noise poses to the use of natural ventilation are not considered. In particular:

- Standards for noise egress (e.g., mechanical equipment noise breaking out from a building) and their effects on the environment are not considered.
- Naturally ventilated and mixed mode buildings often incorporate related design elements, such as exposed concrete ceilings, which can impact the acoustic environment and post occupancy survey results. Such elements will be considered only in terms of the attempt to separate the direct implications of external noise break in from the effects of other aspects of design.
- Potential improvement to the internal acoustic environment of offices by the use of sound absorbing materials is not discussed.
- The potential for masking sound systems to mitigate the negative acoustic effects of natural ventilation strategies is identified. However, consideration of the design or selection of masking sound systems is not directly relevant to the consideration of perceived impediments to natural ventilation and is not included.

2.4.1.3 Impact of Climate Change

Climate models predict a host of both acute and chronic risks for regions within California. As climate change accelerates, increasingly serious implications arise and awareness of these short- and long-term risks and potential vulnerabilities provides important context for adaptation planning. Specifically, within California the energy usage, resiliency and vulnerability of buildings will be impacted to varying degrees depending on a variety of factors, including building type, microclimate, and extent of natural ventilation employment. In this section we have analyzed the effect of climate change on buildings that utilize natural ventilation and the impact that this change will have on the future implementation of natural ventilation.

Due to the intrinsic reliance of natural ventilation on the surrounding environment, any future climate change will undoubtedly impact the operations and effectiveness of overall building energy performance. Long-term trends that are predicted to arise include overall dry bulb temperature increases, as well as an increase in frequency of rolling electrical “brown-outs” due to increased stress on the existing electrical grid in the future. These trends will result in an expected widespread increase in energy usage associated with building cooling and an overall decrease in building heating requirements. However, since the changes in these two

conditioning requirements tend to offset each other, the overall carbon emissions of buildings are not expected to change significantly as a result of the expected future climate changes. It will also leave buildings relying heavily upon passive design approaches, including natural ventilation, particularly vulnerable during power outages. Later sections contain a discussion of these conclusions and how they were determined.

2.4.1.4 Ambient air quality

Dutton *et al.* (2013) point out that occupants of naturally ventilated offices have fewer Sick Building Syndrome (SBS) symptoms than occupants of air-conditioned offices, but that natural ventilation strategies increase occupant exposure to outdoor air contaminants like particulate matter (PM) and ozone. Both are known to have significant health impacts and related healthcare cost impacts. .

In mechanically ventilated buildings, outdoor air passes through a particle filter before being delivered to the occupied space, but in naturally ventilated buildings, outdoor air enters the occupied space directly through operable windows. In both types of buildings, PM and ozone are removed from the air to some extent by deposition on indoor surfaces. Several studies have quantified the relationship between the indoor concentrations divided by the outdoor concentrations (I/O ratio) of particulate matter in air-conditioned commercial buildings. However, few prior studies have assessed indoor concentrations of PM or ozone in naturally ventilated offices.

The associated study focused on analyzing the costs and benefits of health-related impacts of retrofitting California offices to use natural ventilation. However, the information we present here focuses on the ambient air data and pollutant exposure model that formed only a portion of the study.

2.4.2 Methods

Natural ventilation methodologies themselves are not described in detail in this Section. The following tasks were undertaken:

2.4.2.1 Fire Safety Codes and Standards

Identify the fire safety codes and standards that present barriers to the design and construction of new naturally ventilated buildings or the conversion of existing buildings to naturally ventilated buildings during a renovation process to include but not be limited to:

- Identifying regulatory or technical barriers in new buildings.
- Identifying regulatory or technical barriers in existing buildings for retrofit.
- Modeling typical high rise structures to investigate performance of naturally ventilated systems and inform potential solutions or guidance for the development of codes.

Code, Standard and Literature Research

Codes, standards and research papers were reviewed to identify regulatory and/or technical barriers to using natural ventilation or mixed mode systems as smoke control systems in both

existing and new buildings. The review focused on atria, malls and high rise structures as these are the space types the California Building Code (CBC) requires have smoke control systems.

Atrium/Mall and High Rises - Modeled Case Studies

To inform potential solutions and provide guidance for performance-based analysis code development, two case studies were developed: An atrium/mall (Figure 2.45) and a high rise office building (Figure 2.46). Computer models were built to simulate and study the effects of fire, fire suppression system, occupant egress, smoke control system, wind effects, and to determine model reliability. Natural means of smoke control were examined.

Figure 2.45: 15m, 30m, and 45m Tall Mall/Atrium Models

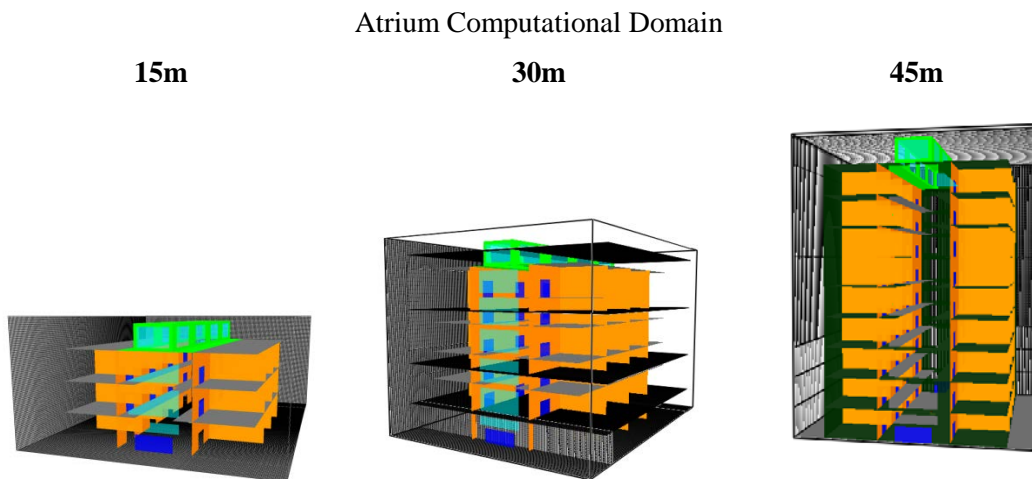
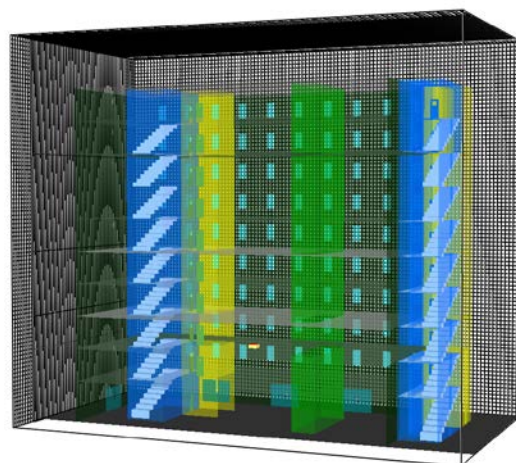

Figure 2.46: High-Rise Model



Details of the model, software and sensitivity analyses can be found in Appendix B.

Recommended Code Language

Recommendations for code changes are presented to address the barriers of naturally ventilated atria, malls, and high-rise structures. Recommendations are based on the code, standard and literature research and supported by the case study models.

2.4.2.2 Acoustic Design Standards

The following approach was used.

- Identify legacy acoustic design standards that have been developed for mechanically ventilated buildings.
- Consolidate published research, including post occupancy surveys, to determine a basis from literature for different or new noise criteria for naturally ventilated and mixed mode buildings.
- Describe example acoustic measurements in naturally ventilated offices and compare the results with post occupancy survey acoustical data, where available, to begin the process of validating and developing new criteria.
- Relate consideration of criteria to external noise environments from the point of view of the feasibility of different natural ventilation strategies.
- Review available products and components for noise control in natural ventilation systems.
- Propose directions for further work.

Aspects of sustainable design not directly relevant to the perceived impediment that external noise poses to the use of natural ventilation are not considered. In particular:

- Standards for noise egress (e.g., mechanical equipment noise breaking out from a building) and their effects on the environment are not considered.
- Naturally ventilated and mixed mode buildings often incorporate related design elements, such as exposed concrete ceilings, which can impact the acoustic environment and post occupancy survey results. Such elements will be considered only in terms of the attempt to separate the direct implications of external noise break in from the effects of other aspects of design.
- Potential improvement to the internal acoustic environment of offices by the use of sound absorbing materials is not discussed.
- The potential for masking sound systems to mitigate the negative acoustic effects of natural ventilation strategies is identified. However, consideration of the design or selection of masking sound systems is not directly relevant to the consideration of perceived impediments to natural ventilation and is not included.

A description of the acoustic terminology used in this report is given in Appendix A of the Acoustic report (Appendix B to this report). Included is a description of the different aspects of the overall (ambient) noise in an office (mechanical systems noise, occupational noise and external noise breaking in).

2.4.2.3 Impact of Climate Change

Previous experience on climate adaptation in the context of California climate zones, coupled with runs of the WeatherShift™ weather projection software, were used to understand how the expected climate change within California will affect the implementation of natural ventilation.

2.4.2.4 Ambient Air Quality

The modeling method presented in Dutton *et al.* (2013) included first-order estimates of the difference between annual occupant exposure to ozone and PM2.5 in naturally- and mechanically ventilated offices. These differences were converted to the differences in the number of health outcomes and costs were estimated for each health outcome case to estimate economic consequences of broader adoption of natural ventilation. Figure 2.47 illustrates the methodology. In a similar fashion, costs were estimated for differences in SBS for natural ventilation versus air conditioning based on a review of data from 11 studies.

The exposure model used empirical data to estimate indoor hourly ozone and PM2.5 concentrations for mechanically and naturally ventilated buildings.

Coincident weather and outdoor contaminant data were collated into 15 unique data sets from 15 cities, each representative of a California Title-24 climate zone. There are 16 California Title-24 climate zones in total; however, climate zone 16 is sparsely populated, has limited data, and is not well represented by any single city, so it was omitted from the analysis. In several zones, such as zone 4, data were only analyzed for the more populous portion of the zone; however, insufficient data are available to assess whether the populous region’s air quality is representative of air quality across the zone.

Figure 2.47: Method for Estimating Increased Health Cases Due to Ozone and PM2.5 Exposure

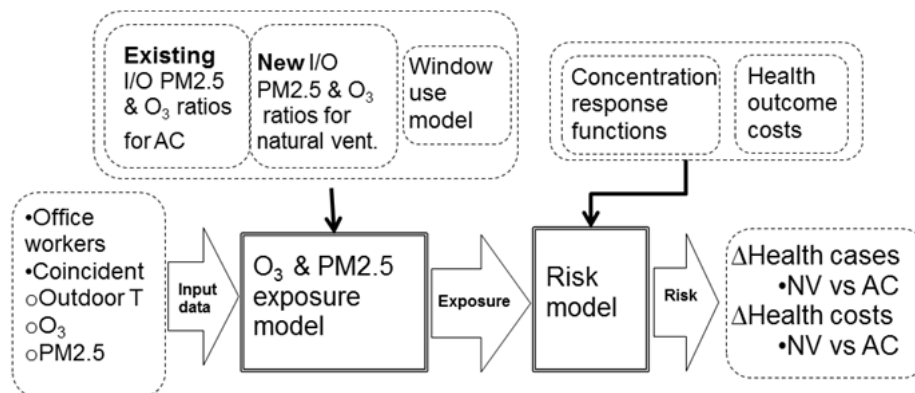

Meteorological stations in or near each of the 15 cities were identified and outdoor air quality monitoring stations near these meteorological stations were identified. Hourly outdoor ozone and PM2.5 data from the U.S. EPA's online repository of ambient air quality data was used from up to three air quality monitoring stations per city to limit missing data. In most cases year to year, 2006-2009 data varied enough to conclude that no single year was considered representative. Approximately half of the locations exhibited insufficient hourly PM2.5 data, so daily average values were used.

Other factors that may impact office IAQ, such as occupant density were not considered in this analysis. Table A1 in Dutton *et al.* (2013) lists incidence C-R functions for ozone and PM2.5.

2.4.2.5 Project Experience and Client Contacts

The data from three main sources was collected, analyzed; used to help determine socio-technical and social barriers to natural ventilation; and formulate responses to help overcome those barriers.

2.4.2.6 Data Collection

- CBE Surveys

The Center for the Built Environment's (CBE) Occupant Indoor Environmental Quality survey database provided statistics from 7 naturally ventilated and 12 mixed-mode buildings which were compared to those of 355 mechanically ventilated and conditioned buildings.

- Case Studies

The 19 buildings listed in Table 2.15 below were reviewed as case studies of naturally ventilated or mixed-mode systems. Most of these buildings are commercial and retrofitted, and all are located in California. Some of them are naturally ventilated new buildings.

- Stakeholder Interviews

Twelve people, including stakeholders, including architects, engineers, operators, owners and users, were directly interviewed for this study regarding natural ventilation issues. A consulting engineering company's internal survey added an additional 7. Interviews were often associated with specific case-studies. In these cases, questions were both general and specific to the case studies.

- Data Analysis

The quantitative data from the CBE surveys indicates how naturally ventilated and mixed-mode buildings are perceived in comparison to a large building, mechanically ventilated benchmark.

The qualitative data from the case studies and interviews was used for two analyses: integrative and comparative. The integrative analysis highlighted and mapped issues commonly mentioned during interviews and shared among the stakeholders. The

comparative analysis segregated responses by stakeholder to help determine how each profession perceived natural ventilation.

From the qualitative analysis, prevailing socio-technical and social barriers were identified and summarized. Recommendations of how to overcome the identified barriers are presented.

2.4.2.7 Socio-Technical Barriers

A socio-technical factor involves the interaction between people and technology. As an example, a socio-technical factor would be concerned with the intersection of technical and human quality of natural ventilation: Does a new technology make it easier for occupants to open windows? Does a new signaling system provide more surety to occupants about when they should open windows?

2.4.2.8 Social Barriers

A social factor involves interaction between people or groups of people only. An example of a social factor might be the power relations between groups or individuals. Who gets to decide, and how do personal biases, interests or fears affect how and if a natural ventilation retrofit happens?

Table 2.15: Case Study List

Case-studies	City	Year built	Year retrofit	activity	Size (now)	Original	Now	Envelope Window	HVAC	Continuous ownership	Driver for renovation	
Retrofit cases	Oakland City hall	Oakland	1914	1995	office public	100000	operable windows	operable windows	Retain operable windows	Natural ventilation (NV) only, Original radiant heat upgraded, no cooling	yes	Seismic Rehab Interior renovation
	Richmond City Hall	Richmond	1960s	2009	office public	70000	operable windows	sealed	Yes New sealed windows	Mechanical ventilation (MV)	yes	Seismic Rehab Major renovation
	Berkeley Civic Center	Berkeley	1940	1999	office public	77000	operable windows	operable windows	operable windows, ventilation shafts narrow floor plates, fans enable cross-ventilation; open floor plan; exposed thermal mass	NV, Perimeter radiant heating, AC taken out during the last retrofit, packaged units installed in new IT center on fourth floor and converted penthouse (on	yes	Seismic Rehab Interior renovation
	Hallidie Building	San Francisco	1917	2006	office	34800	operable windows	operable windows	operable windows	unknown	yes	Historical renovation
	IDeAs	San Jose	1965	2007	office	6557	sealed	operable windows	operable windows	Mixed-mode (MM) NV and MV - Radiant floor	yes	Major renovation
	FAIS Arts Pavilion	San Francisco	1920-30	2009	educational	17500	operable windows	operable windows	Yes: new operable windows replacing old operable ones	Mixed-mode (MM) NV and MV	no	Major renovation
	DPR San Diego Office - 5010 Shoreham	San Diego	1978	2009	office	24000	sealed	operable windows	New windows / some of them operable	Mixed-mode (MM) NV and efficient HVAC system	no	Major renovation
	Advanced Light Ssource Building (LBI)	Berkeley	1993	2010	lab	30926	operable windows	operable windows	Few operable windows	Building mainly runned using mechanical systems (lab) Part of the building is using NV	yes	Technical renovation
	Integral Group Oakland Office	Oakland	1930	2010	office	16373	operable windows	operable windows	No Retain operable windows	Mixed-mode (MM) NV and MV Radiators	no	Major renovation
	Stop Waste.org, 1537 Webster	Oakland	1926	2008	Office	14000	operable windows	operable windows	operable windows	Mixed-mode (MM) NV and efficient MV Packaged RTU, VAV, CO2 sensors	no	Major renovation
	Thoreau Center for Sustainability	San Francisco	1899/1933	1996	NGO Office	73000	operable windows	operable windows	Operable windows Reduce internal gains	Mixed-mode (MM)	no	Major renovation
UCLA Kinsey Hall, aka Humanities Building	Los Angeles	1930	2007	Office Classroom	142000	operable windows	operable windows	operable windows retained	Mixed-mode (MM) with radiant ceiling panels, UFAD, displacement, forced air	yes	Seismic Rehab Major renovation	
New constructions	San Marco Palomar College	San Marco	2011	-	educational	110000	operable windows	-	New operable windows	Mixed-mode (MM) NV and efficient HVAC system operable windows in each classroom	-	New construction
	New San Francisco Federal Building	San Francisco	2006	-	Public/Office	550000	operable windows	-	New operable windows	NV as a cooling mechanism, perimeter heating hot water finned tube convectors built into facade mullion	-	New construction
	Morphosis Arch Studio	Culver City	2011	-	office	11400	operable windows	-	New operable windows	NV	-	New construction
	Kirsch Center for Environmental Studies	Cupertino	2005	-	educational	22000	operable windows	-	New operable windows	Concurrent mixed-mode using radiant cooling slab and ceiling fans	-	New construction

Note: Ten out of twelve retrofit cases were originally built with operable windows; the two exceptions are retrofits from 1960-1980 retail and offices. These cases recall the characterization of existing buildings by Kendrick et al. (1998).

2.4.3 Results

2.4.3.1 Fire Safety Codes and Standards

Literature Review

Reports and experimental data show that natural ventilation may be quantitatively examined to determine effectiveness during a fire. However, little guidance is available to building stakeholders and AHJ's to incorporate fire preparedness into the design process. AHJ's may include federal, state, or local building and fire authorities or any other governing body that has a stake in the design and construction of buildings.

Viewpoints that need to be considered during the design process include those of building owners, insurance companies, and the eventual occupants of the building. Each stakeholder will have their own set of goals for the smoke system. Guidance from new research and computer modeling techniques may reveal sound engineering principles that stakeholders and AHJ's can use to implement natural ventilation without compromising life safety goals.

The origin of present smoke control techniques may be found in testing and experiments from the early 1970s. A commonly referenced study that precipitated code development was conducted by the Brooklyn Polytechnic Institute in 1972 in a high-rise office building (DeCicco et al., 1972). Commissioned by the New York City Fire Department, this was one of the first large-scale studies of the effectiveness of stair pressurization systems. In their report, the authors concede that varying fire protection systems, building geometries and mechanical systems should be considered when developing guidance for design.

Full-scale fire tests performed at the Plaza Hotel in Washington, D.C. in 1989 showed promise in the use of open windows during a fire event, but the evidence of this is limited to only one test. In that case, the building was not protected by automatic fire sprinklers and the mechanical ventilation system failed during the test, yet smoke did not move outside of the compartment of origin during the sprinklered test with a fire twice as large as any other in the study (Klote, 1990).

Smoke control measures for stairs and elevators were also considered as part of the overall tenability strategy for both occupant egress and emergency responders. In the 1980 MGM Grand fire in Las Vegas, most of the occupants succumbed to smoke inhalation in an area several stories above the fire due the movement of smoke up the elevator shaft (Best & Demers, 1972). While stair systems are widely used as part of an overall egress strategy, it is noted that elevator smoke control is much more difficult to design and implement (Stroup, 2003). Reported issues include high leakage areas to the exterior, inability for stair and elevator doors to close, and a negative impact on the stairwell smoke control system (Miller & Beasley, 2008; Klote, 1984).

Today's calculation methods for smoke transport in tall buildings are based on much of the work performed in the 1960s by Tamura, Wilson, McGuire, and others (Tamura, 1970; Wakamatsu, 1968; Tamura & Wilson, 1967; McGuire, 1967). Further research and empirical correlations for use in smoke transport were developed by Quintiere, Heskestad, Klote, Milke and others (Klote, 1984; Klote & Milke, 2002) that were able to take advantage of developing

interest and research funding as well as advances in computer programming and technology. These ideas and equations were incorporated into modern codes and standards such as NFPA 72 and 92 as well as the IBC (NFPA, 2006 & 2007).

Code Review

In California, some fire safety requirements found in the State Building and Fire Codes (CBC, CFC) can be potential barriers to design of naturally ventilated buildings. High rises, atria and mall buildings trigger smoke control systems to be in accordance with Section 909 of the CBC. This section is based on the International Building Code (IBC) but is amended by the California State Fire Marshall (CSFM). Smoke control systems primarily depend on mechanical ventilation and pressurization.

These code requirements were originally based on engineering judgment and have evolved with accumulation of experiential and research data. However, they do not yet adequately address natural ventilation system options, and they lack prescriptive criteria that would encourage building owners to pursue more energy efficient designs.

While research and experimental data have shown that natural, passive, and hybrid ventilation may be quantitatively examined to determine effectiveness on tenability, codes provide little guidance to building designers and AHJ's to incorporate these approaches into the design process.

Barriers to Natural Ventilation -New Buildings

The modern prescriptive smoke control method for high-rise buildings is the pressurization approach outlined in the Section 909 of the CBC (CBSC, 2010). This utilizes the concept of a "pressure sandwich" created above and below the fire event floor in order to prevent the spread of smoke. When a building is opened to the environment by means of operable windows or other opening on the façade, the pressurization approach might not be feasible. Using supervised windows with motorized closers is usually cost prohibitive to accomplish the required pressure differentials. Further, other prescriptive elements such as pressurized stairwells might be affected by a reduction or elimination of mechanical ventilation (Bowers *et al.*, 2010).

Several portions of the California Building Code allow for a performance-based approach to smoke control. For buildings not required to be fully sprinklered, Section 909.6.1 allows an engineered approach to achieve pressure differences of 12.5Pa or calculated to twice the pressure effects of the design fire. However, in a naturally ventilated building, there may be little or no pressure effects when windows or doors are open.

Section 909.9 lists those aspects that need to be considered, including dynamics of the design fire, its location, and effectiveness of sprinklers. Section 909.4 requires a rational analysis to include stack effect, temperature effect of fire (through convective heat transfer), HVAC system considerations, climate effects (high and low temperatures, wind) and allows for a performance-based approach for the duration of operation, generally 20minutes or 1.5 times calculated egress times as specified in 909.4.6.

CBC 909.6 requires an engineered approach to the pressurization method based on the criteria in 909.9. Minimum design pressure differences across smoke barriers for use of this method are based on NFPA 92A, Section 5.2. In a sprinklered building, a pressure difference of 12.5 Pa is specified. This pressure difference is to be maintained under specified conditions of stack effect and wind and was developed based on full scale room fire experiments. The method for determination of the design pressure difference is given in NFPA 92A, Section A.5.2.1, (NFPA, 2006).

Barriers to Natural Ventilation - Existing Buildings

The California Existing Building Code (CEBC) allows buildings to utilize performance or prescriptive means of evaluating the level of life safety afforded to occupants. Smoke control is listed in Section 1301 as part of a performance-based evaluation of the building, but there are no requirements for smoke control beyond what is provided in Section 909 (CBSC, 2010). In the analysis provided, smoke control is treated as part of a holistic fire protection approach, and natural ventilation is recognized as a portion of that methodology. A key element to modifications or alterations to existing buildings is that they cannot become less safe than the existing condition per CEBC Section 601.2.

The CEBC categorizes alterations into three groups based on the amount of building space that will be modified. Level 2 and 3 alterations most nearly match those of modifying a building for natural ventilation, as those levels include work to be done on windows and doors.

Requirements for this level of change are similar to many of those found in the CBC for new structures, including required modifications for sprinklers, means of egress, and fire-resistance ratings for occupancies. However, the code does not provide guidance for existing smoke control systems, nor does it require the addition of such systems if they are not already present.

Modeled Case Studies - Atrium/Mall

Short atria or those with lower ceiling heights showed little resistance to plume rise and subsequent smoke mitigation (Figure 2.48). The upper region of the atria filled with smoke early in the development of the fire. Naturally ventilated atria with operable skylights allowed for tenable conditions at a higher level than in unvented ceiling areas. Models reached a quasi-steady state after approximately 400 seconds with the exception of the 15m run which completely lost tenability soon after.

Winter effects were mainly studied since stack effects are greatest when outdoor temperatures is colder than the indoor temperatures. In the 15m atrium/mall model, winter effects had little effect on smoke movement out of the skylight windows. This was expected, as stack effect is generally not seen in lower structures. Tenability was found to still stay above the lower two floors after 400 seconds.

Figure 2.48: Soot Density (Visibility) in 15 m Tall, Naturally Ventilated Atrium/Mall, t = 400s

Smokeyview 6.0.7 - Nov 2 2012

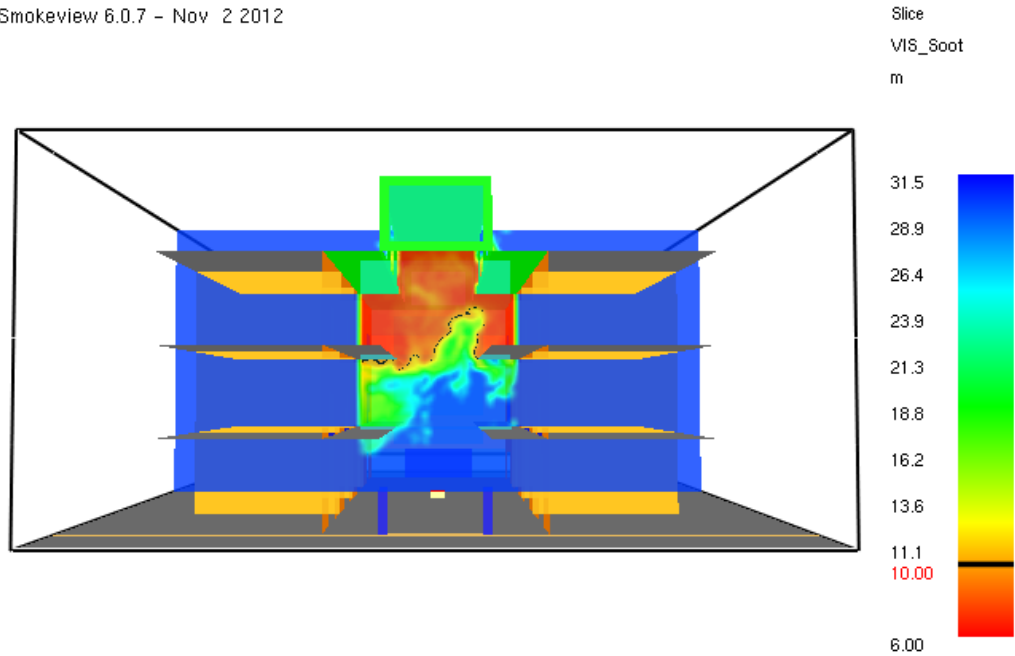

The 30m tall atrium/mall was relatively unaffected by the effects of smoke (Figure 2.49). Only the top two floors lost tenability after 400s in the open building. This aligns with results of hand calculations.

Figure 2.49: Soot Density (Visibility) in 30 m Tall, Naturally Ventilated Atrium/Mall, t = 400s

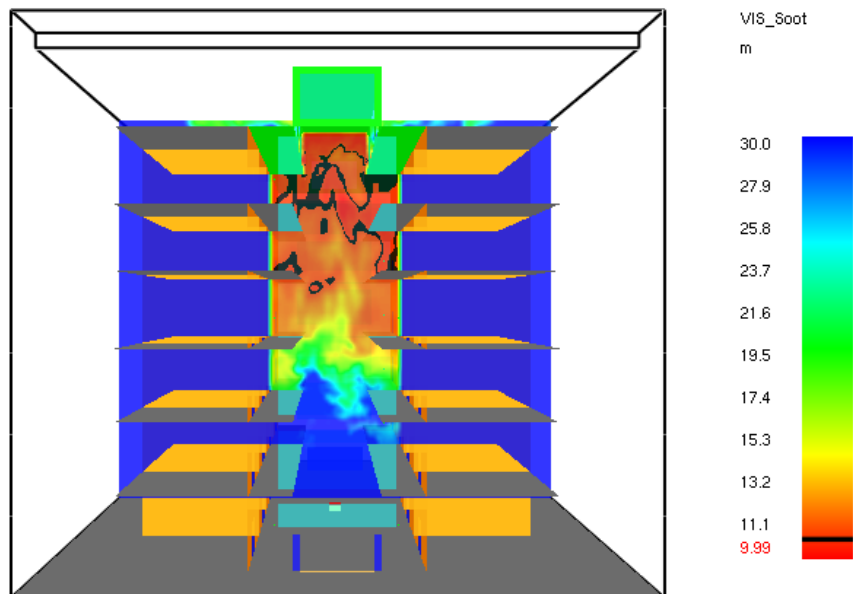

Modeled Case Studies – High Rise

While tenability on the fire floor was lost within the fire's growth period, the upper floors remained tenable throughout the evolution (Figure 2.50). In no-wind evolutions, tenability was above 10m for the first 600s. Based on egress calculations, this was more than adequate time to evacuate the floors surrounding the fire floor and get occupants into the protected stairwells.

Figure 2.50: Soot Density (visibility) in High-Rise Model, t = 400s

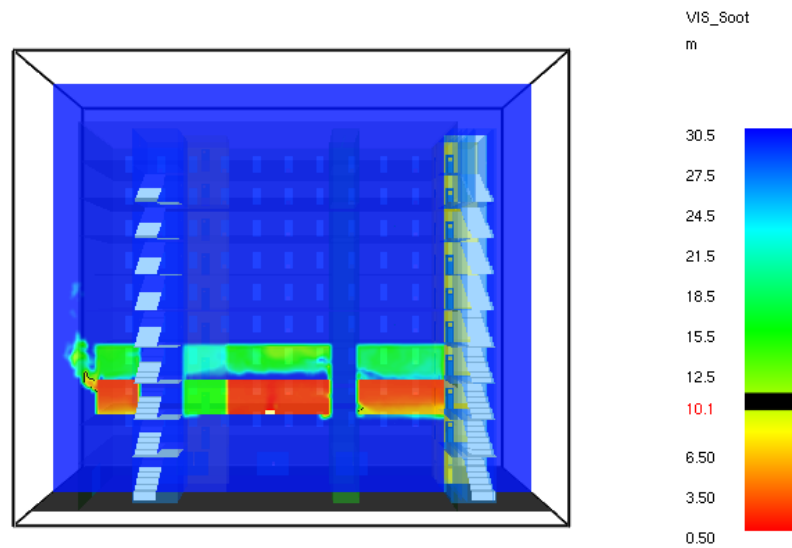

Results from studies of 12.7m/s (28.4mph) prevailing winds resulted in greater tenability, even on the fire floor. Smoke was seen blowing out of the leeward side of the building, lessening the amount of mass entrained within the structure (Figure 2.51)

Figure 2.51: Soot Density (Visibility) in High-Rise Model with 28.3 mph Wind, t = 1200s

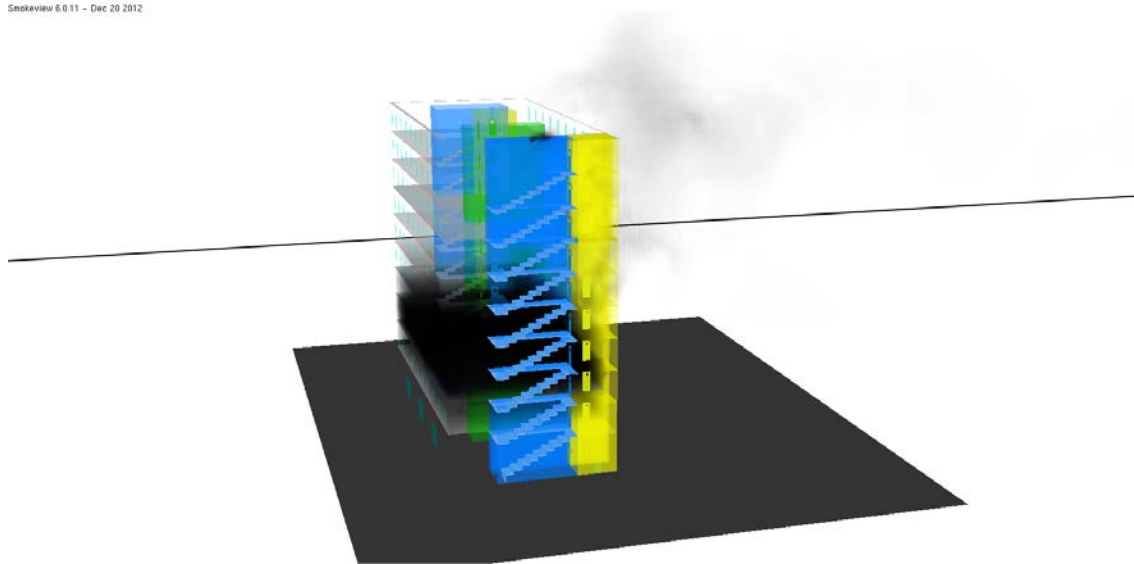

Visibility was maintained throughout the modeling evolution on the upper floors, and the fire floor did not lose tenability until after 700s (Figure 2.52). This provided even greater egress time for occupants. Results showed that the upper floors did not lose tenability past the prescriptive requirement in CBC Section 906.4 of 20min (CBSC, 2010)

Figure 2.52: Soot Density (Visibility) in High-Rise Model Fire Floor

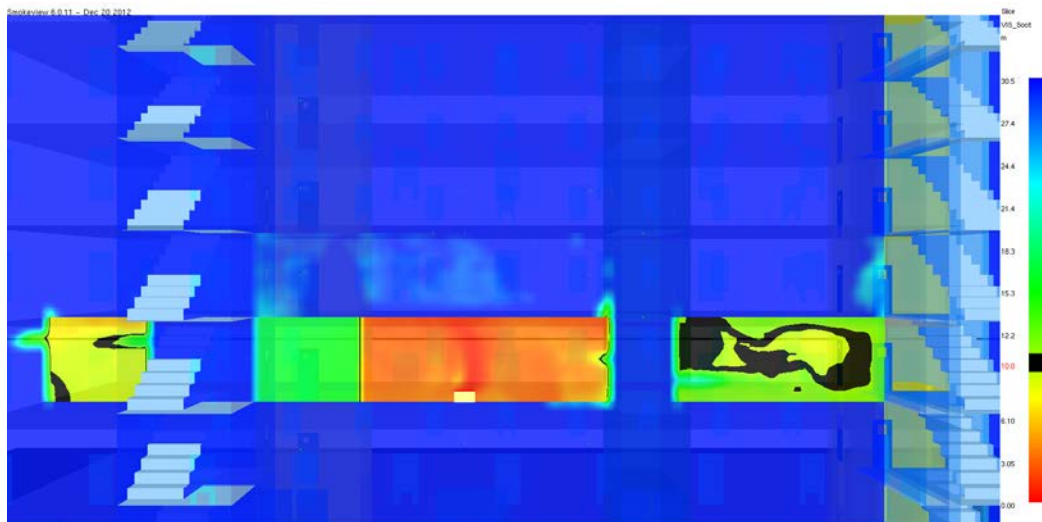

Velocity vectors of the leeward side of the building showed a tendency for wind turbulence to first turn back toward the structure in a rolling manner, then going up the façade and returning to the stream above (Figure 2.53). This rolling effect did not create enough velocity or pressure differential to force the smoke back into the structure. Instead, it had the effect of entraining more air into the smoke and moving it away from the structure.

Figure 2.53: Velocity Profile on Leeward Side of High-Rise Model With 28.3mph Wind

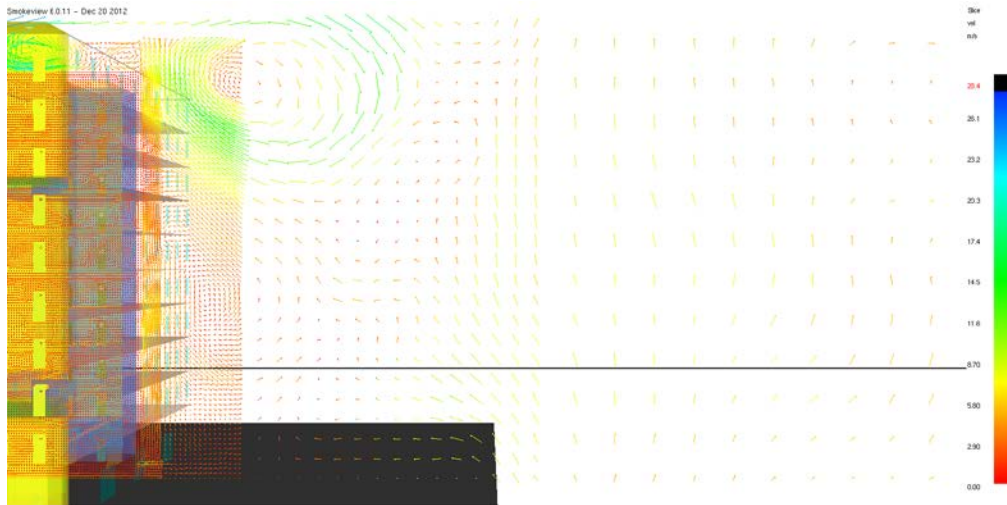

2.4.3.2 Acoustic Design Standards

Legacy Criteria

The interior acoustic design of office buildings is not regulated and acoustic criteria are discretionary. Internationally recognized standards provide recommended guidelines for internal background noise limits, as described in Table 2.16.

Table 2.16: Legacy Criteria

Country	Standard	Noise Limit – Open Office	Noise Limit – Enclosed Office
US	ASHRAE 20112*	NC40 (45dBA)	NC30 (35dBA)
Australia/New Zealand	AS/NZS 2107:20003 “Acoustics – Recommended design sound levels and reverberation times for building interiors”	Satisfactory: 40 dB LAeq Maximum: 45 dB LAeq	Satisfactory: 35 dB LAeq Maximum: 40 dB LAeq
UK	BS 8233: 19994 “Sound insulation and noise reduction for buildings – Code of Practice”	45-50 dB LAeq**	Cellular Office Good: 40 dB LAeq Reasonable: 50 dB LAeq Executive Office Good 35 dB LAeq Reasonable 40 dB LAeq

See Appendix B for footnotes.

These standards are roughly consistent, recommending that the background noise should not exceed 40 dBLAeq to 50 dBLAeq in open offices and 5dB to 10dB lower in cellular or executive offices. The standards generally assume that buildings are sealed and air conditioned and that

the recommended noise limits are met by controlling the steady background noise from building systems.

Achieving these standards for control of external noise in naturally ventilated buildings in noisy urban environments is often not feasible and, hence there is a perception that natural ventilation results in unacceptably high indoor noise levels, which acts as a barrier to its implementation.

Natural Ventilation Changes Sensitivity to Noise

Sensitivity to background noise in sealed air-conditioned buildings is well established.⁷ However, when natural ventilation is used, peoples' sensitivity to noise is believed to change. This change may be attributed to the following factors:

- The expectation of a low noise environment is less.
- The appreciation of non-acoustic benefits, such as reduced energy consumption and enhanced quality of the work environment, may facilitate compromise on noise levels.
- Different noise sources are known to provoke different annoyance responses.⁸ The legacy criteria are primarily based on steady state mechanical systems noise. External noise ingress to buildings depends on the surrounding environment. When noise has a character that is more representative of the outdoor environment it is possible that it is may be considered more acceptable.
- Continuous versus time varying noise interferes differently with speech intelligibility. Statistical noise levels for a time varying signal, such as auto traffic noise, may be used to estimate the % of time that speech will be disrupted.
- Control of ventilation through operable windows or vents also allows control over external noise ingress. It is hypothesized that workers will accept higher noise levels coming through a window if they have control over when the window is open. By introducing a level of control, individual sensitivity to noise may be managed. Although this benefit is difficult to quantify, it is viewed as a positive factor in the adoption of natural ventilation.⁶
- People adapt to their environments and urban dwellers may be tolerant of urban sounds as a necessity of city life.

Literature and PostOccupancy Survey Reviews

Literature reviews led to the following summary (Table 2.17) table:

Table 2.17: Summary of Research

Section	Main Conclusions
3.2.1 Annoyance, Task Interference and Health Effects Studies	It may be possible to carry out some office tasks in levels of up to 68dBA to 70dBA. However, workers may be significantly annoyed by noise levels above 55dBA.
3.2.2 Speech Intelligibility	To facilitate communication across short distances and allow for adequate phone use, noise levels should not exceed 55dBA to 60dBA.
3.2.3 Subjective Surveys Combined with Noise Measurements	External noise was reported to be more of a problem than internal noise. The noise level deemed to be “Just right” varied depending on the task being carried out. People generally felt that the noise level to which they were accustomed was “Just right” and were, therefore, seen as having adapted to their acoustic environment. 55dBL _{Aeq} may be an acceptable criterion in European offices.
3.2.4 References Relating to External Noise Break-In	Early UK guidelines put forward a criterion of 55dBA for auto traffic noise inside offices. A study in a single office in the UK found a negative reaction to external noise levels of 51dBL _{Aeq} to 55dBL _{Aeq} where overall noise was in the range 59dBL _{Aeq} to 62dBL _{Aeq} . A laboratory study using city street noise as the background noise source found that good speech intelligibility for office use could be achieved with a background level of 59dBA.
3.2.5 International Studies	Research indicates that response to noise and, hence, appropriate criteria may vary by region.
Section	Main Conclusions
3.2.6 Post Occupancy Surveys	Acoustic concerns are one of the top areas of complaint in sustainable offices. Dissatisfaction with speech privacy is generally a much greater concern than noise level. Respondents sitting near operable windows, and therefore exposed to the most external noise, reported higher satisfaction rates than those near sealed windows or located away from windows.

This research indicates that the allowable level of noise break in to naturally ventilated buildings could be set higher than the building services noise criteria for sealed mechanically ventilated buildings.

While a preponderance of the work suggests that 55dBL_{Aeq} may be appropriate, a suitable criterion cannot be conclusively determined from the research. This is due to the following:

- Regional and individual responses are likely to vary.
- Different noise sources are known to provoke different annoyance responses.

- Response to noise may be related to non-acoustic factors such as:
 - Noise predictability
 - Attitudes to the noise or noise source
 - Perceived necessity of a noise or how usual it is or by beliefs that a responsible authority should be able to reduce the noise.²⁴
- Noise character. Including frequency content, temporal variability and the presence of impulsive or tonal characteristics. These are defined in the full report. Refer to Appendix B.

Measurements

Measurements were taken in three buildings: two were naturally ventilated and the third was mechanically ventilated and conditioned (Table 2.18). The latter was intended to be used as a basis for comparison, but exhibited noise levels much lower than for a typical office. So while its sound travel characteristics were used, the noise level from an “average” office was superimposed. Measurements were made with the following aims:

- Measure overall noise levels in the offices.
- Identify external noise break-in levels and/or external noise environment.
- Consider the relationship between objective acoustic measures and post occupancy survey results and users’ comments.
- Quantify room acoustic characteristics relating to privacy.
- Comment on the measurements with regard to setting appropriate criteria for external noise break-in.

Post-occupancy surveys were completed for both naturally ventilated buildings.

Table 2.18: Buildings and Measurements

Building	Description	External Noise	Room Finishes	Measurements
David Brower Center, Berkeley, CA	Four story naturally ventilated building with operable windows.	Exposed to auto traffic noise from Oxford Street to the East and Allston Street to the North. The south façade is exposed to lower noise levels and has a partial line of site to Oxford Street.	Exposed concrete ceilings and carpet floors. In Suite 400, hemp coffee bean sacks, understood to contain sound absorptive foam, have been suspended below the concrete ceiling.	Measurements were carried out in: Suite 460 Private Offices (at East façade), Suite 460 Open Office (interior away from windows), Suite 460 Large Conference Room (at north façade), Suites 400 (at south façade).
Loisos + Ubbelohde, Alameda, CA	Office on the second story of a two story building. Natural ventilation by means of operable windows. A sliding glass door to an external balcony and stair is also often left open.	The site is away from major roads and is affected by intermittent noise from a ship repair yard.	Connected open offices with wood floors: Room 1: gypsum board ceiling at approx. 10'. Room 2: underside of the pitched roof exposed, with a height varying between approx. 10' and 17'. Finish material applied to the underside of the pitched roof, between the beams.	Measurements were made in Rooms 1 and 2.
560 Mission Street, Suite 700, San Francisco, CA	Conventional mechanically ventilated office.	Building is in a downtown environment has sealed windows.	Carpet floor and acoustic tile ceiling.	Measurements of room acoustics only were made for purposes of comparison.

Table 2.19: Summary of Measured Noise Levels

Building	Space	Windows	L _{Aeq} , dB	L _{A90} , dB	Comments
David Brower Center, Berkeley, CA	Suite 460 Private Offices	Open	50-58	42-48	Auto Traffic Dominant
		Closed	42-47	35-37	
	Suite 460 Open Office	None	49	39	Auto Traffic Audible
	Suite 460 Large Conference Room	Open	51-52	47-48	Auto Traffic Dominant
		Closed	41	34	
	Suite 400	Open	48	43	Autos 45-50dBA.
	External	N/A	68	59	Façade Level.
Loisos + Ubbelohde, Alameda, CA	Room 1	Varies	46-50	37-45	People talking and plotters/copiers. External noise was not a subjectively significant contributor to the ambient noise in the office
	Room 2	Varies	52	38	
	External Noise	N/A	56	51	Delivery trucks, distant airplanes, general marina noise. Façade Level.

Figure 2.54: Articulation Index Versus Communication Distance

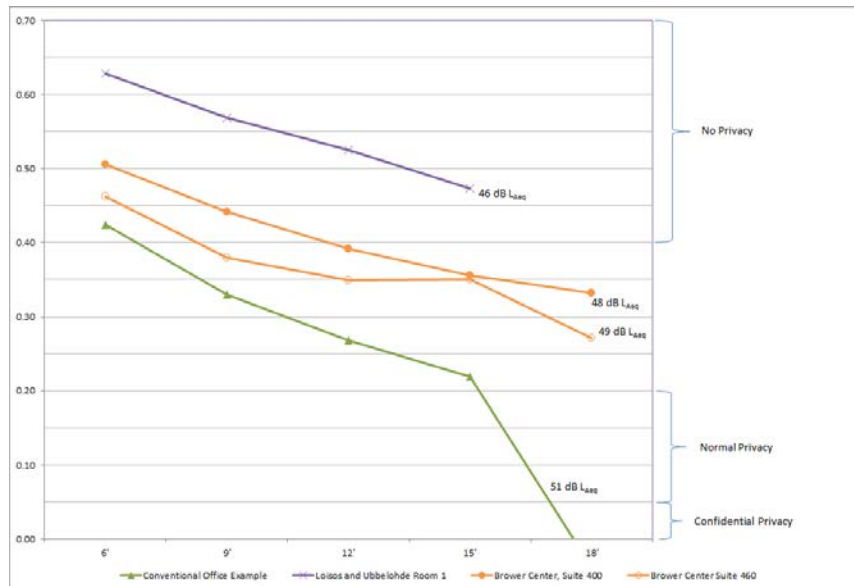

The Articulation Index (AI), which typically measures speech privacy between cellular offices, was calculated for the open office areas of the three buildings. Normal privacy between cellular offices typically ranges from AI of 0.05 to 0.20. Speech becomes more readily understood at AI > 0.20. Above AI=0.40, there is essentially no privacy.

The Brower Center is one of the two naturally ventilated buildings and is located near significant roadways. It exhibited external break-in noise similar to the suggested maximum allowable, 55 dB_{ALeq} (Table 2.20). Thirty one (31) percent of occupant respondents complained about outdoor traffic noise and 24% complained about “other” outdoor noise. However, indoor noise sources (people talking), privacy issues and “echoing” of sound were reported as problems by 1.9 to 2.8 times the number of respondents reporting that outdoor traffic noise is a problem. Accordingly, the AI ranged between 0.25 and 0.50

Table 2.20: Noise Issues and the David Brower Center

Noise Issue	% of responses
People talking on the phone	86
People overhearing my conversations	86
People talking in neighboring areas	84
Excessive echoing of voices or other sounds	60
Telephones ringing	36
Outdoor traffic noise	31
Office equipment noise	29
Other outdoor noise	24
Mechanical (heating, cooling and ventilation systems) noise	7
Other	3

The other naturally ventilated building (Loisos + Ubbelohde) is located away from major transit routes, but is near a shipyard. The L_{Aeq} measured *outside* the building is of the order of the suggested criterion for external noise *inside* offices and external noise is generally not a significant contributor to the internal noise. Despite the relatively quiet noise environment, external noise is still occasionally an issue due to the nature of the outdoor noise. This indicates the need to consider the type of noise source and its temporal variability and illustrates the inadequacy of a single figure criterion expressed as L_{Aeq}.

Both buildings experienced low background noise levels. This was expected to contribute to a low privacy rating.

Noise Environments and Feasibility of Natural Ventilation

Natural ventilation opening location and type will depend on the natural ventilation strategy. Air inlets and outlets are generally either:

- At the façade, e.g. operable windows, louvers, acoustically attenuated vents, etc.
- At roof level, e.g. chimneys, stacks and wind towers. These are often similar to traditional Middle Eastern methods such as Iranian wind towers (*bādgīr*)

Generally the air path between space and a roof level opening will be longer than that between an occupied space and a façade opening. For example, air may enter a space through operable windows but exit via a chimney. The chimney presents an opportunity to provide sound attenuating surfaces, whereas the window generally does not. On this basis, the feasibility of natural ventilation is often determined by façade noise ingress.

Level Difference (D) is defined as the difference in exterior and interior sound levels. Weighted Level Difference (D_w) is the weighted version used to describe the broad band noise level difference. Table 2.21 gives external noise limits for feasibility of various natural ventilation opening types based on a criterion for external noise break-in to office space of 55 dB L_{Aeq} .

Table 2.21: Feasibility of Natural Ventilation (Based on Noise Only)

Type of Natural Ventilation Opening (See Sections 5.3)	Approximate Level Difference, D_w dB L_{Aeq}	Max. Feasible L_{ext} , dB L_{Aeq}
Operable Windows	10 – 15	65 – 70
Open windows with carefully oriented geometry and/or strategically located sound absorption	12 – 20	67 – 75
Integrated Facades Design	20 – 25	75 – 80
Acoustically Attenuated Ventilators	20 – 30	75 – 85
<i>Sealed thermal glazing with mechanical ventilation - Included for comparison</i>	~30	85

Other Acoustic Issues

Ventilation may lead to other acoustic issues, such as actuator noise, wind noise, privacy and changing external noise environment (Table 2.22).

Table 2.22: Other Acoustic Issues

Actuator Noise	When windows or vents are opened automatically based on thermostat or Building Management System controls, noise from the actuators may be heard in occupied space. Actuator noise may be noticeable and distracting as it is likely to have a tonal character as well as being intermittent. While the noise itself could be an issue, most complaints seem to arise when the environmental sensors are set to too narrow ranges and the actuators operate frequently.
Wind Noise	Consideration of wind generated noise may be required at wind or solar towers or at: Openings to the wall cavity could behave as Helmholtz or open pipe resonators. Closely spaced repeating elements or sharp edges could give rise to vortex shedding.
Privacy	Dual skin facades can introduce significant privacy issues between occupied spaces if these spaces share a common façade cavity. Such situations require detailed acoustic design consideration. The routing of exhaust shafts from different occupied spaces or from different floors should be considered from the point of view of acoustic cross talk between spaces. Where air moves through a building, it may need to pass through internal sound isolating partitions. The air transfer openings or devices at these partitions must provide appropriate sound attenuation.
Changing External Noise Environment	Internal noise levels in a naturally ventilated building could change over time if the external noise environment changes. Such changes could result from planning changes (traffic rerouting, industrial facilities opening/closing etc). Gradual changes in urban noise (dominated by auto traffic) are possible. Internal combustion engines vehicles could get quieter ³⁴ and the % of electric and hybrid vehicles on the roads will likely increase. However the benefits of such changes may be undermined by an increase in traffic due to population growth. ³⁵

Noise Control Products

Table 2.23 lists various acoustically attenuated ventilators.

Table 2.23: Acoustically Attenuated Ventilators

Product Type	Description								
Silenceair	<p>These are Australian products but are available in the US. See www.silenceair.com. They are intended for attenuated air transfer for natural ventilation.</p> <p>Silenceair products are available for external facade applications and are designed to fit within the depth of a 240mm wall. These include:</p> <ul style="list-style-type: none"> Silenceair Brickvent (a single module) Silenceair Window Vent (25 modules grouped together) Silenceair Wall Vent (10 modules grouped together) <p>The Window Vent and Wall Vent products allow larger volumes of air to be transferred through a single unit.</p> <p>The sound attenuation is provided by a reactive, quarter wave resonator mechanism.</p>								
Background Ventilators	<p>There are many of these available, mostly in the UK to meet UK residential code requirements, including those from Passivent (www.passivent.com), Greenwood (www.greenwood.co.uk) and Ryttons (http://www.vents.co.uk/products.asp).</p> <p>These are through-wall ventilators, usually comprising one or more pipes with sound absorptive lining and louvers, or controllers, at each end. They are used to provide background ventilation when windows are closed in residential buildings. It is generally assumed that the possible airflow is insufficient for commercial use.</p> <p>While background ventilators are not intended for air transfer for naturally ventilated commercial buildings, they are not necessarily of a constricted or high pressure drop design. However they are relatively small and hence are likely to be impractical. For example, to transfer 300l/s at 1Pa pressure difference, the following numbers of ventilators would be required:</p> <table border="0" data-bbox="747 1323 1153 1522"> <tr> <td style="padding-left: 40px;">Background Ventilator (Passivent Fresh 90)</td> <td style="text-align: right; padding-left: 20px;">146</td> </tr> <tr> <td style="padding-left: 40px;">Silenceair Brickvent</td> <td style="text-align: right; padding-left: 20px;">65</td> </tr> <tr> <td style="padding-left: 40px;">Silenceair Wall Vent</td> <td style="text-align: right; padding-left: 20px;">7</td> </tr> <tr> <td style="padding-left: 40px;">Silenceair Window Vent</td> <td style="text-align: right; padding-left: 20px;">3</td> </tr> </table> <p>Acoustic Window Slot Ventilators have not been considered as “acoustic” models do not appear to perform significantly better than standard models.¹⁷</p>	Background Ventilator (Passivent Fresh 90)	146	Silenceair Brickvent	65	Silenceair Wall Vent	7	Silenceair Window Vent	3
Background Ventilator (Passivent Fresh 90)	146								
Silenceair Brickvent	65								
Silenceair Wall Vent	7								
Silenceair Window Vent	3								
Acoustic Louvers	<p>These are standard noise control products available in a range of dimensions, configurations and performances, typically from 4” to 24” deep. Manufacturers include IAC (www.industrialacoustics.com) and Vibro-Acoustics (www.vibro-acoustics.com).</p> <p>These are metal louvers with sound absorptive material included inside the louver blades. Perforated metal on the underside of the blades exposes the sound absorption.</p> <p>Generally, these are used to reduce noise break out from mechanical</p>								

Product Type	Description
	equipment rooms and other noisy enclosures. They are not designed to keep rain and wind out of occupied spaces but may be used in conjunction with valves etc. as part of an integrated design. They have been used over operable windows ³⁴ but at the cost of daylight and views. Acoustic louvers may be particularly useful in the case of indirect air intake via cool basements.
Proprietary lined duct “boot” type silencers	<p>Custom attenuators could be based on, or incorporate, proprietary lined duct boots. These are standard noise control items intended for attenuated air transfer in mechanically ventilated buildings. However, there is no obvious reason why these should not be appropriately sized for the lower pressure drops in a natural ventilation application.</p> <p>Coordination between disciplines would be required to provide a design that was suitable for external applications.</p> <p>Z-shaped silencers could fit within a partition. Larger models would require a double stud partition. U or C shaped silencers are intended to fit in a ceiling void. Location with a bulkhead is also possible, e.g., with an L-shaped silencer.</p> <p>Products include Ruskin, Dynasonics, IAC QuietVent, Vibro Acoustics CT Cross Talk Silencers. These manufacturers produce similar products in a variety of sizes and shapes.</p>
Attenuation of Roof Level Openings	<p>Subject to maintaining appropriately low pressure drops, standard mechanical noise control methods may be used in stack ducts. Sound absorptive duct lining may be suitable. The performance of such measures may be reduced by the larger size of these ducts compared to a conventional mechanical ventilation system.</p> <p>Acoustically attenuated devices are available for roof level vents. See www.monodraught.com. Monodraught wind catchers are available with 25mm and 50mm thick acoustic foam lining.</p>

Table 2.24 indicates sound reduction properties for acoustically attenuated ventilators. $D_{n,e,w}$ is a single figure, broad band value, weighted according to BS EN ISO 717. R_w is equal to $D_{n,e,w} - 10 + 10 \log(\text{area})$ and comparable to the Sound Transmission Class (STC). Where manufacturers list octave band values for Transmission loss, the average from 125Hz to 4kHz is given and is taken to be of the same order as the R_w .

Table 2.24: Sound Reduction Data for Devices for External Air Transfer

Ventilator	Example Product	Dn,e,w (C;Ctr)	Rw
Silencair	Silencair Window Vent (25 modules) or Wall Vent (10 modules)		26
	10-0001-01 Silencair 240 or Silencair Brickvent		25
Background Ventilator	Passivent, Fresh 80	50	23
	Passivent, Fresh 90	45	19
	Passivent, Fresh 99H	42	15
	Greenwood AWW39 Acoustic Wall Ventilator	39(0;-2)	11
	Greenwood MA3051 Wall ventilator	55(-1;-3)	24
	Greenwood AAB Acoustic Airbrick	46(0;-2)	21
Acoustic Louvers	IAC Model R (12" deep)		(12)
Proprietary Lined Boot	Estimated range for boots between 1'10" long and 4' long		20 to 31
Monodraught Wind Catchers	GRP800, 25mm acoustic foam lining	26	14*
	GRO1000, 25mm acoustic foam lining	24	14
	GRO1000, 50mm acoustic foam lining	31	21

See Appendix B for footnotes.

To compare the air flow performance through many devices with different sizes, the volume flow rate has been divided by the overall cross section area. This gives a measure of the volume flow rate per area of the wall taken up by the device. Depending on the geometry of the ventilator, it is not a true face velocity. It has been plotted for a variety of devices on Figure 2.55.

Note that:

- Data given for example proprietary lined duct “boot” type attenuators represent the maximum and minimum values in the published ranges for many different sizes of silencer.
- Volume flow rates for different devices are quoted in different pressure drop ranges making comparison difficult.

Figure 2.55: Volume Flow Rate/Overall Cross Section Area Verses Pressure Drop

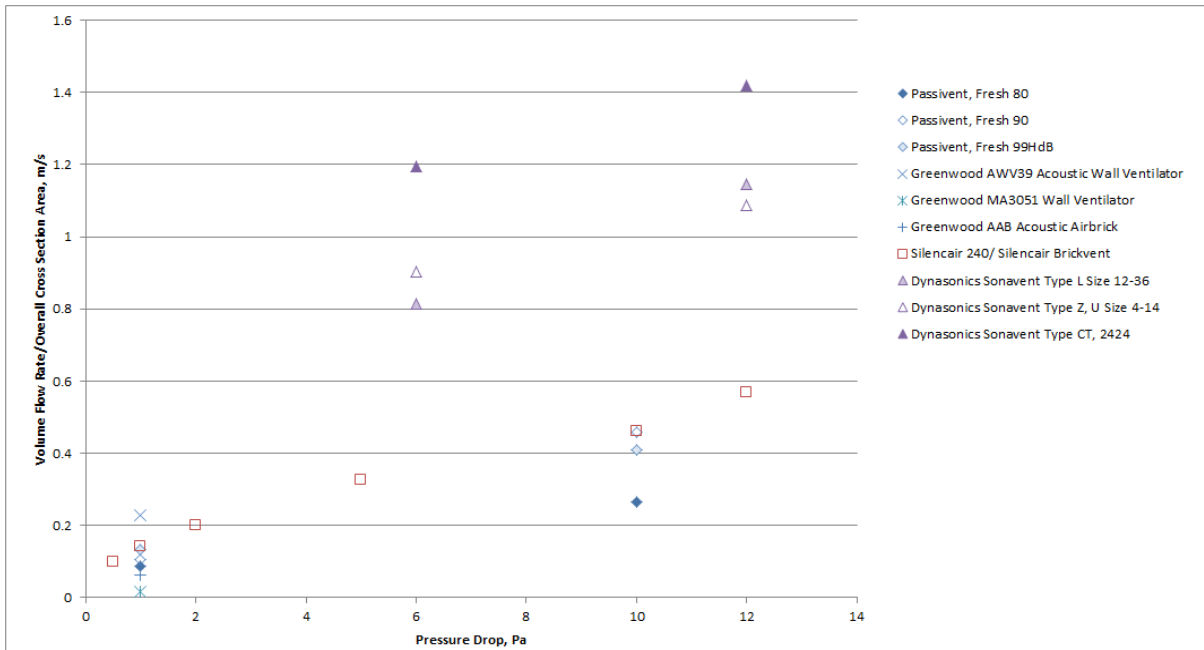

2.4.3.3 Impact of Climate Change

It is expected that current climatic zones will begin to take on the characteristics of warmer, present-day areas in response to an increase in overall temperature. Figure 2.56 indicates that an increase on the order of 5°F will result in a climate shift in which Oakland’s microclimate will take on the characteristics of present-day Sacramento, and the microclimate specific to Riverside will largely resemble current-day Palm Springs.

The likely future temperature gain, in the range 3-8°F, will alter the overall operations of existing buildings, with an upward trend in cooling-related energy usage and a decrease in heating-related energy usage. These trends can be seen for all building types in Figure 2.56, when the current temperature is at or above 60°F. Due to the fact that heating and cooling demands tend to change in an inverse relationship, the overall annual energy demand will likely remain largely unchanged in most regions of California. This applies to all building types, including those employing natural ventilation. Since there will not be a distinct change in energy demand, overall carbon emissions of buildings are not expected to change drastically (Figure 2.57).

As these trends apply to all building types, not limited to ones that employ natural ventilation, it is useful to examine a previous study on future climate adaptation.¹⁵ The study analyzed building designs that incorporate varying degrees of dependence on water cooling via mechanical forced-air conditioning. The conclusion of the study was that certain resiliencies as well as vulnerabilities arise in response to expected climate change scenarios. Additional

¹⁵ Arup proprietary report.

resiliency comes from the ability to cope with above-design external temperatures, due to conservative design estimates of coincident cooling loads. However, there is also additional vulnerability due to the inherent dependence on air conditioning, which leads to partial or complete unoccupancy in the event of power outages or significant chilled-water curtailment events.

Figure 2.56: Building EUI Associated With Cooling Demand (Upper) and Heating Demand (Lower)

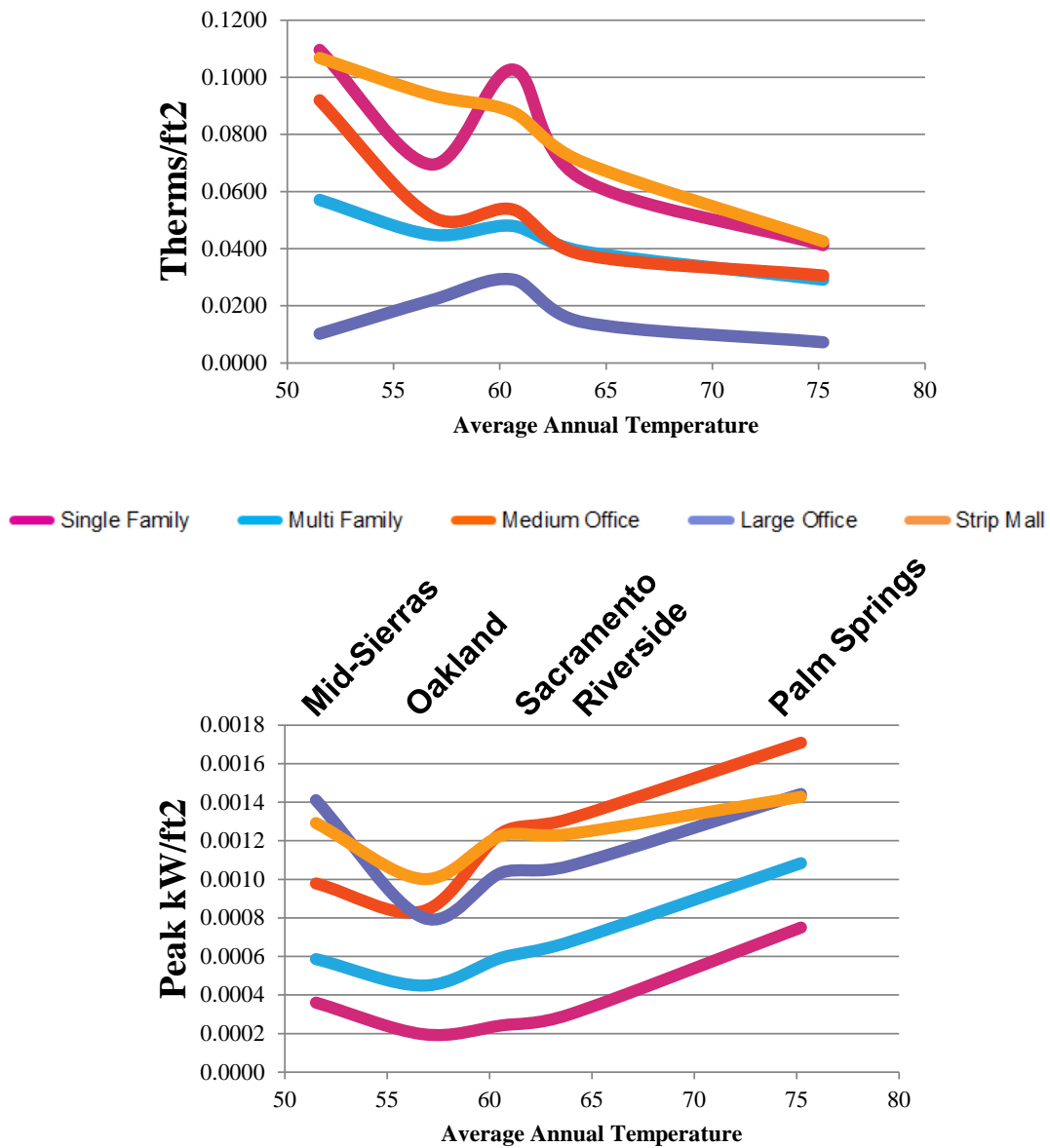
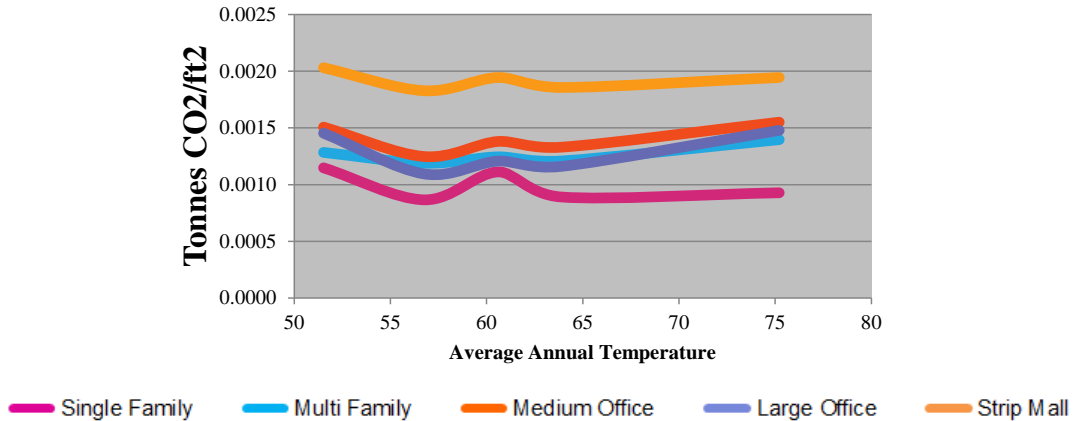

Figure 2.57: Variation of Building Carbon Emissions With Average Temperature



Buildings that are naturally ventilated also prove to be both more resilient and more vulnerable in the event of future climate change predictions. Their resistance to solar gains, significant thermal capacity and insulation, and passive air circulation systems embody passive survivability principles. Thus, these buildings are more likely to remain operational during chilled-water or electrical service disruptions. However, naturally ventilated buildings have been specifically designed for the “current” climate. Sustained heat waves, excessive daytime temperatures, or sustained warm nights may cause too much interior heat buildup to be effectively released at night. Therefore, the most resilient of buildings are likely to be those with mixed-mode capability (operable windows) and those with elevated supply air setpoints ($\geq 60^{\circ}\text{F}$) that can maintain comfortable conditions with non-refrigerated outside air supply longer than systems designed for conventional 55°F air supply.

To help model building performance in a multitude of possible future climates, a future weather-prediction application, WeatherShift™, has been applied to site-specific research to give future climate scenarios. In the analysis of natural ventilation suitability for San Francisco, a pessimistic scenario, with an aggressive greenhouse gas trajectory, RCP8.5 and a 90% probability factor, was applied. The WeatherShift™ model charts the daytime and nighttime potential for using natural ventilation for conditions now, in 40 years’ time, and in 80 years’ time. Based on the results of this simulation, nighttime warming is identified as an important trend. The occurrence of nighttime warming has already been seen in historical data and is reflected in the simulation of future climate expectations. The phenomenon of nighttime temperatures growing at a faster rate than daytime temperatures means that diurnal ranges are shrinking. Since the daytime and nighttime temperatures will both increase, the potential to naturally ventilate during the daytime will increase and the potential for nighttime flushing via natural ventilation will also increase, in moderate conditions. These results are reflected in Figure 2.58.

Figure 2.58: Future Projections of Potential for NV in San Francisco

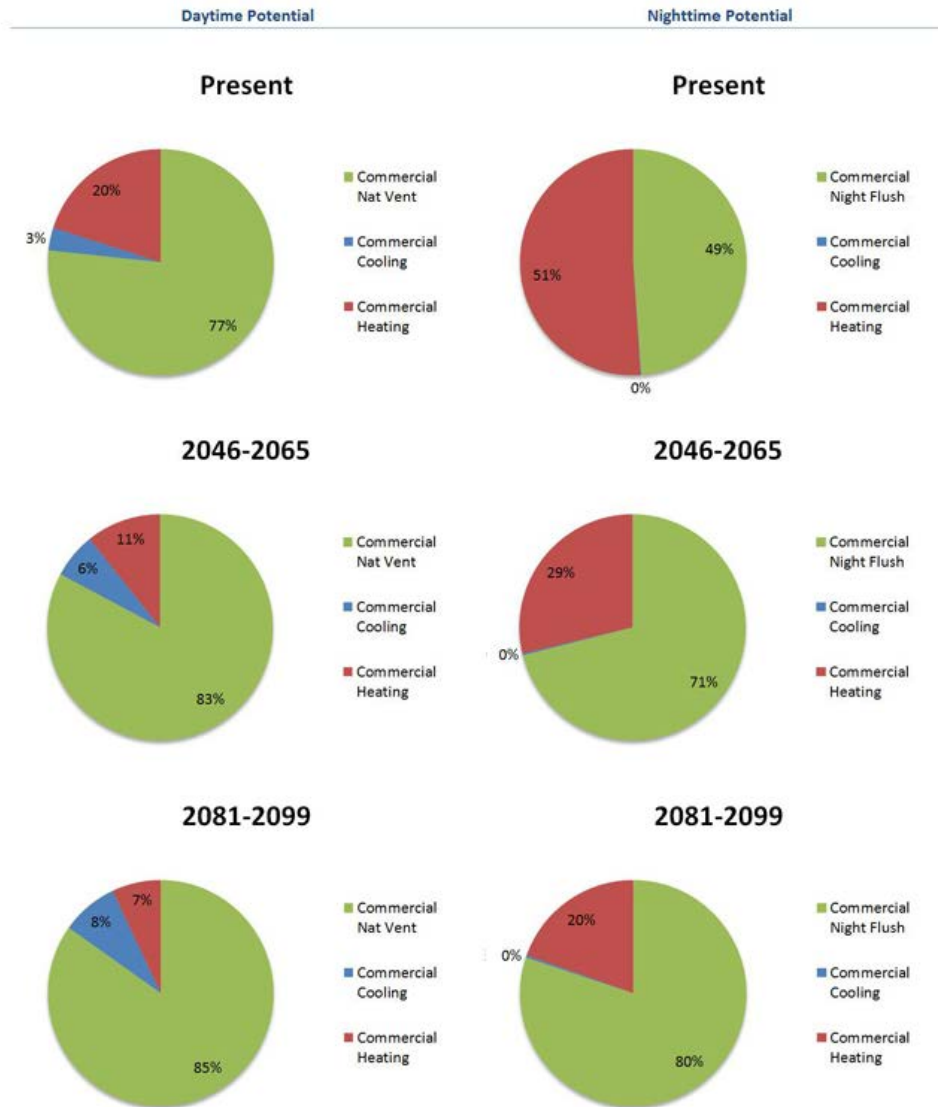

Under the same pessimistic simulation condition, RCP8.5, 90%, average design dry bulb temperatures for summer and winter temperatures are also shown to increase universally (Figure 2.59).

Figure 2.59: Future Projections of Temperature in San Francisco

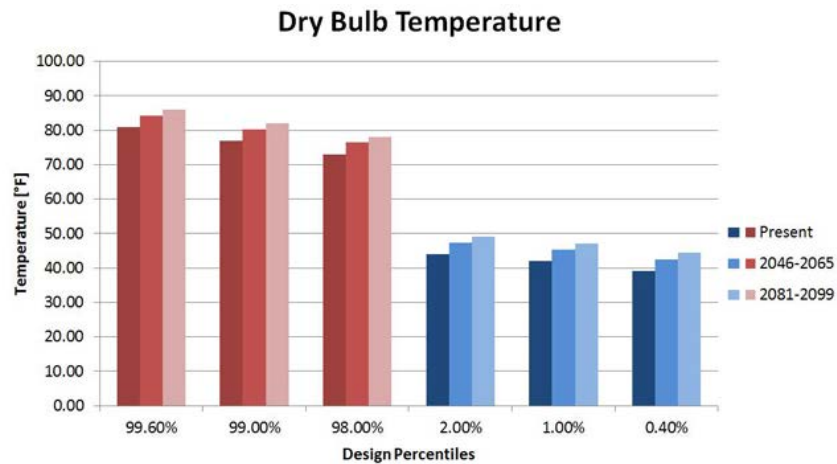

These future climate predictions are consistent with the previous studies discussed.

2.4.3.4 Ambient Air Quality

Table 2.25 below is from Dutton *et al.* (2013). It shows, for each of the 15 California Title24 climate zones, the representative city's mean daytime temperature, daytime fraction of open windows, average daytime PM2.5 and ozone levels, indoor/outdoor pollutant exposure delta and total cost of increased medical-cases. The last three columns (incremental pollutant exposure and medical case costs) include two scenarios: Scenario A represents the lower end of the range of Indoor-to-Outdoor ratio of pollutant ratios. Scenario B represents the higher end of this range.

Population figures are not included, so it is difficult to determine which percentage of the climate zone population lives in/near the representative city. Similarly, non-representative towns/cities are not included so it is unclear how pollutant levels vary throughout the climate zone and population in general.

Table 2.25 summarizes the incremental costs incurred per 10,000 workers and related to Δ ozone and Δ PM2.5 exposures for scenarios A and B. Both scenarios assume a 10-percent penetration of natural ventilation compared to air conditioning. Costs were negative in one climate zones because the annual pollutant exposures were lower in naturally ventilated offices than in air-conditioned offices. Lower exposures in naturally ventilated offices in these climates were a result of less opening of windows than in other climate zones. The reduced use of windows was triggered by lower average outdoor temperatures and resulted in low ventilation rates.

Health costs can be assumed to scale proportionally with the number of buildings that are retrofitted.

Table 2.25: Title-24 Climate Zone Analysis Summary Data

T2 4C Z	Rep. City	Daytime mean outdoor temp. (°C)	Daytime fraction of open windows	Average daytime outdoor PM2.5 (µg/m ³)	Average daytime outdoor ozone (ppb)	ΔC ^a PM2.5 Exposure (ug/m ³) Scenario A B		ΔC ^a ozone Exposure (ppb) Scenario A B		Total ΔCost in millions \$ Scenario A B	
1	Arcata	11.8	0.25	8.0	24.5	0.32	0.09	0.04	-0.45	\$0.65	\$0.00
2	Sonoma	17.1	0.40	9.0	24.3	0.46	0.20	0.87	0.38	\$2.97	\$1.29
3	Bay Area	15.8	0.37	10.1	23.3	0.61	0.30	0.59	0.12	\$13.87	\$6.23
4	San Jose	18.0	0.43	11.3	26.7	0.70	0.39	1.07	0.54	\$10.02	\$5.45
5	Santa Maria	17.0	0.40	8.2	29.2	0.50	0.27	0.95	0.35	\$1.66	\$0.81
6	Oxnard	17.1	0.41	12.9	34.3	0.78	0.42	1.17	0.47	\$11.29	\$5.72
7	San Diego	18.7	0.46	10.5	38.5	0.73	0.43	1.65	0.86	\$9.47	\$5.37
8	Anaheim	19.7	0.49	14.3	36.1	0.96	0.96	1.79	1.79	\$37.77	\$37.77
9	Burbank	21.1	0.49	13.5	44.3	1.00	0.61	2.31	1.42	\$28.47	\$17.39
10	Riverside	22.2	0.49	17.2	41.4	1.24	0.74	2.03	1.18	\$32.02	\$19.06
11	Redding	19.8	0.43	12.6	34.5	0.85	0.48	1.43	0.73	\$6.72	\$3.74
12	Sacramento	19.8	0.43	12.6	34.5	0.85	0.48	1.43	0.73	\$26.79	\$14.91
13	Fresno	21.3	0.41	20.5	41.8	1.18	0.61	1.57	0.73	\$18.27	\$9.25
14	Lancaster	21.3	0.41	7.5	45.0	0.48	0.26	1.64	0.73	\$4.06	\$2.05
15	Palm Springs	27.8	0.41	8.0	48.1	0.49	0.26	1.25	0.28	\$3.01	\$1.29
						Total annual costs in millions of dollars				\$207.0	\$130.3

^a ΔC = naturally ventilated building indoor contaminant concentration minus air-conditioned building indoor concentration, adjusted to account for the proportion of time occupants spend in the office.

The impact of natural ventilation retrofits to 10 percent of California’s office stock was analyzed with respect to prevalence of SBS symptoms and associated costs. The range of reported reductions (25 to 66 percent) was used for the upper and lower bounds of the model for naturally ventilated offices. Calculations indicate that 22,000 to 56,000 fewer people would report symptoms in a given week. Based on an average annual cost of \$207million (2012 basis) for treatment of SBS, health costs were reduced health costs by \$4.3 million to \$11.5 million.

There are several sources of uncertainty highlighted in the LBNL/CPP study.

- Data on indoor-to-outdoor concentration ratios of particles and ozone are sparse, particularly from naturally ventilated offices.
- Occupants' actual use of windows.
- Concentration-Response (C-R) functions that predict annual cases of those outcomes are based on studies of the general population, including susceptible infants and elderly, but the office worker population does not include those more vulnerable types of individuals, so office workers are presumably less susceptible to ozone and particles than the C-R functions would indicate.
- Unit costs for health effects.

Based on these uncertainties, the estimates in this paper should be considered order-of-magnitude estimates rather than absolute values.

The paper offers several strategies to mitigate exposure to outdoor air ozone and particulate matter in naturally ventilated building.

2.4.3.5 Project Experience and Client Contacts

CBE Survey Data

The percentile curves below represent occupant satisfaction ratings of 374 new and retrofitted buildings, as logged in the Center for the Built Environment's Occupant Indoor Environmental Quality survey database. Each building is represented by a point. Blue diamonds (n=355) represent mechanically ventilated and conditioned buildings, orange triangles (n=12) represent mixed-mode buildings, and green squares (n=7) represent naturally ventilated buildings.

Figure 2.60 shows that occupants of mixed-mode and naturally ventilated buildings are more satisfied with their building than those in mechanically ventilated and conditioned buildings.

Figure 2.60: General Building Satisfaction for Naturally Ventilated Buildings, Mixed-Mode Buildings and CBE Database

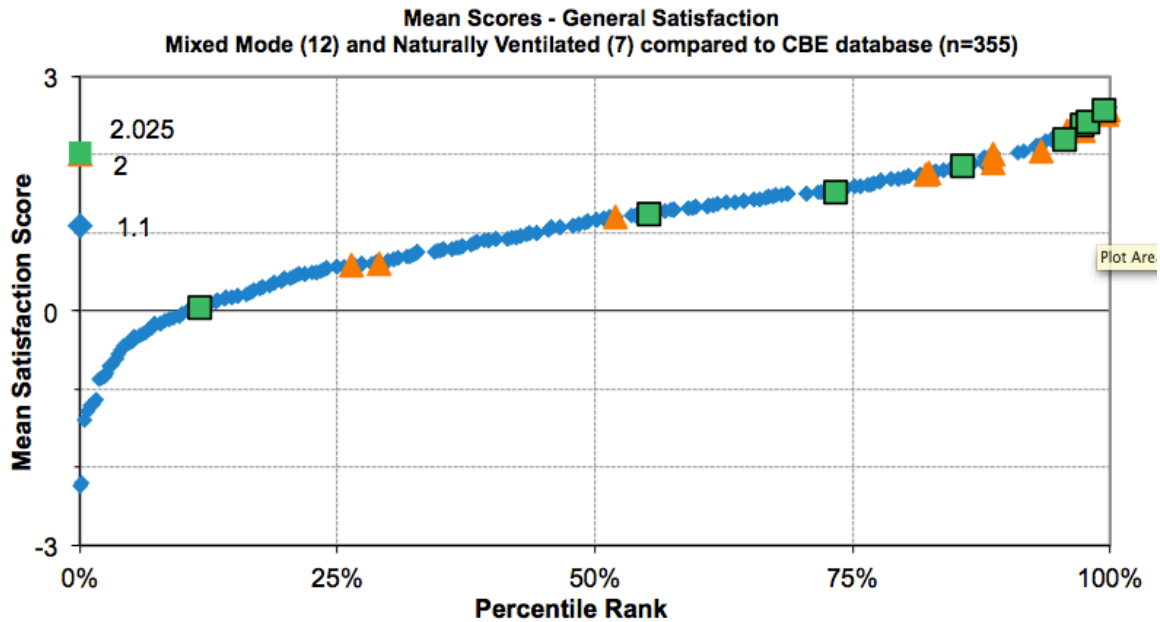

Figure 2.61 shows that occupants of naturally ventilated buildings are more satisfied with their thermal comfort in naturally ventilated and mixed mode buildings than those in mechanically ventilated and conditioned buildings. There tends to be greater satisfaction associated with naturally ventilated buildings than mixed mode buildings. All but one of the naturally ventilated or mixed mode buildings thermal comfort score falls within the top 40 percentile.

Figure 2.61: Thermal Comfort for Naturally Ventilated Buildings, Mixed-Mode Buildings and CBE Database

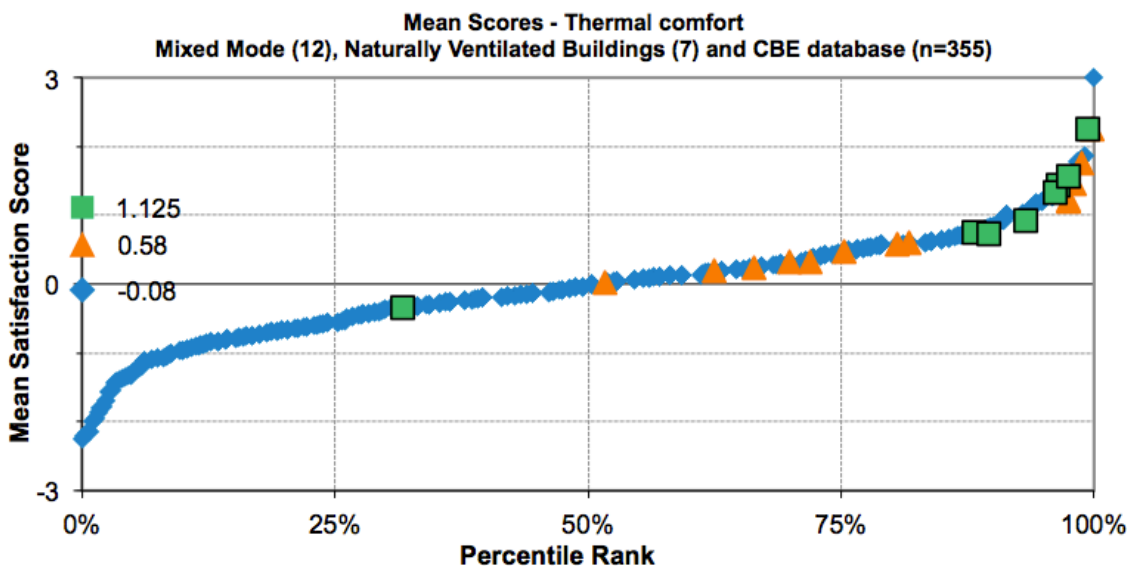

Figure 2.62 shows that occupants of naturally ventilated and mixed mode buildings are more satisfied with their air quality than those in mechanically ventilated and conditioned buildings.

Figure 2.62: Air Quality for Naturally Ventilated Buildings, Mixed-Mode Buildings and CBE Database

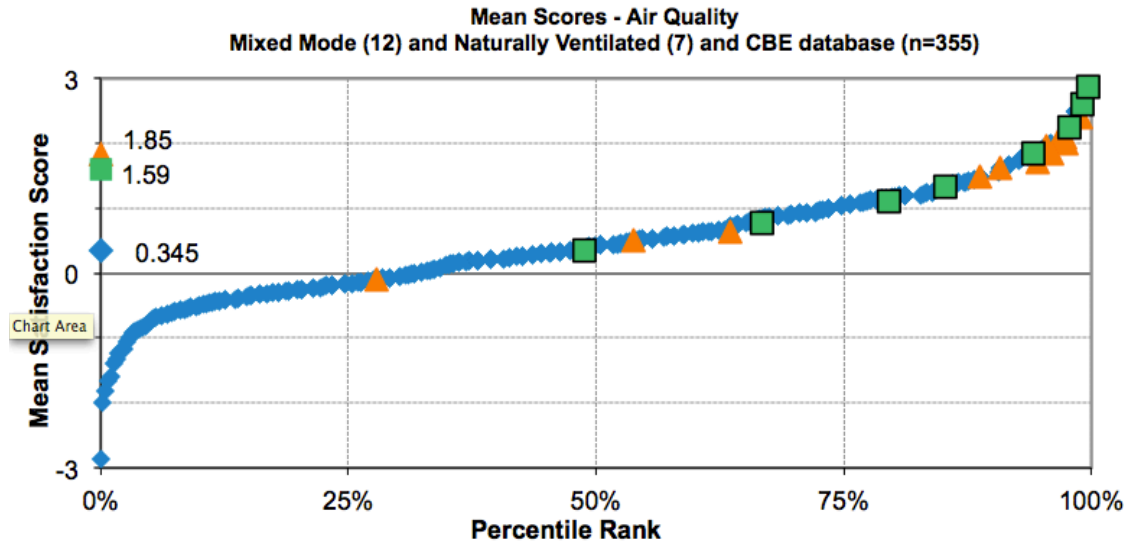
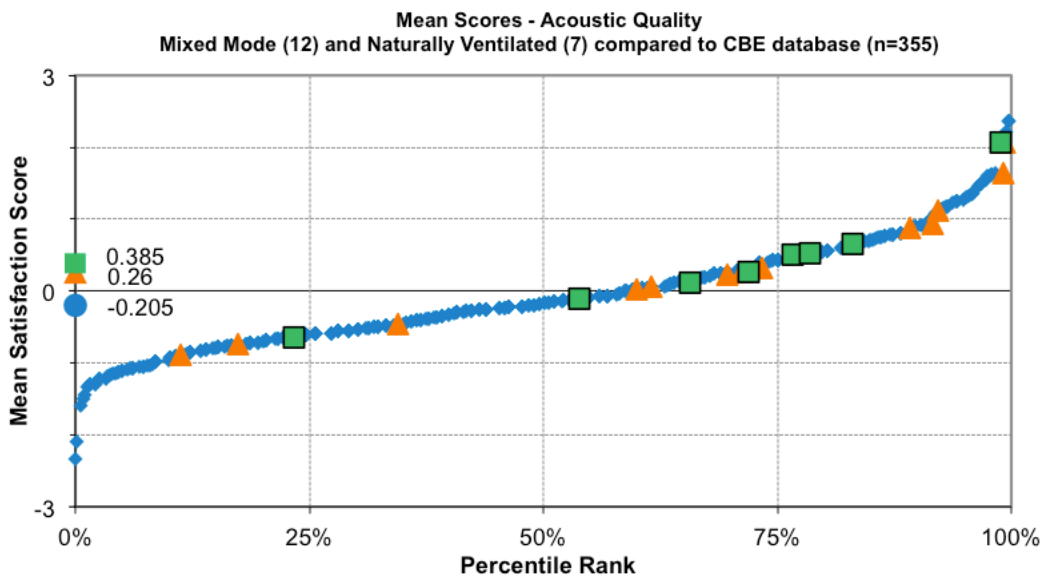

Figure 2.63 shows that occupants of naturally ventilated and mixed mode buildings are more satisfied with their acoustical environment than those in mechanically ventilated and conditioned buildings. However, the average score is closer to the 50th percentile and there are more outliers falling into the lower percentile rankings.

Figure 2.63: Acoustic Quality for Naturally Ventilated Buildings, Mixed-Mode Buildings and CBE Database



Naturally ventilated and mixed-mode buildings show higher satisfaction for all nine categories shown in Figure 2.64. Naturally ventilated and mixed-mode buildings show comparable results (difference below 0.3) for general building satisfaction, workspace satisfaction, office layout, air quality, lighting and acoustic quality. Naturally ventilated buildings score noticeably higher than even mixed mode buildings in the “cleanliness and maintenance” and “thermal comfort” categories.

Figure 2.64: Average Scale Score by Category for Naturally Ventilated Buildings, Mixed-Mode Buildings and CBE Database

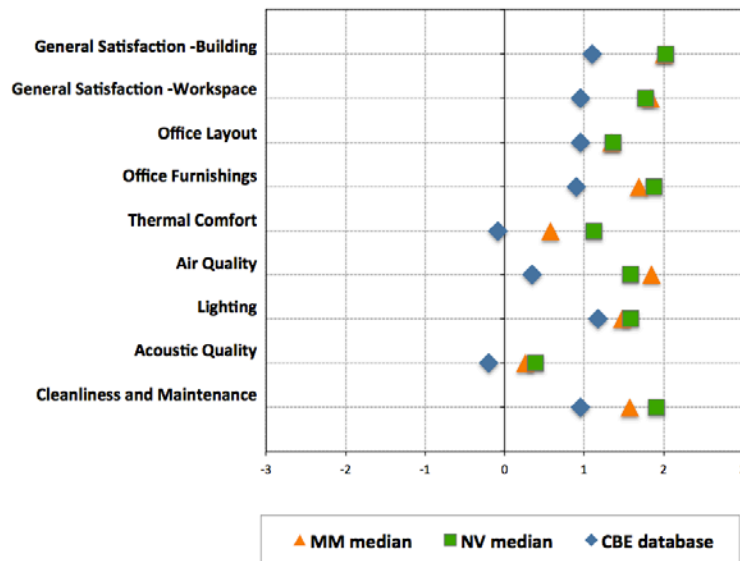

The statistical information indicates a strong preference for naturally ventilated and mixed-mode buildings. However the sample size of naturally ventilated and mixed mode buildings (19 out of 374) is relatively small.

Interviews and Case Studies - Integrative Analysis

The following opinions were prevalent across all stakeholder types:

- Natural Ventilation was not seen as an independent strategy, but rather a complex strategy that was linked to many other issues and parameters: user type and tendencies, passive design strategies, air flow dynamics, acoustics, fire/life safety, security, comfort “deadbands”, etc.
- Figure 2.65 attempts to map and connect all aspects mentioned.
- Many technical issues associated with natural ventilation were hard to overcome. For example: How can user behavior be managed? How can acoustics and air quality be controlled?
- The lack of guidelines within Codes made it risky to implement natural ventilation as a single strategy.

- Codes, standards and LEED® mainly focus on mechanical systems and on the importance of control. They are seen as important barriers to natural ventilation as they may bias designers to implementing mechanical equipment. ASHRAE 62.1 from 2007 to 2010, allows natural ventilation but clearly pushes designers toward implementation of mechanical systems. Guilty by association, the current LEED® rating system still refers to ASHRAE 62.1 2007. Many air quality and energy credits are easier to earn when using mechanical systems versus natural ventilation systems.
- The lack of guidelines (or “lack thereof”) within Codes made it difficult to defend proposed natural ventilation systems.

Figure 2.65: Map of Natural Ventilation and its Connections

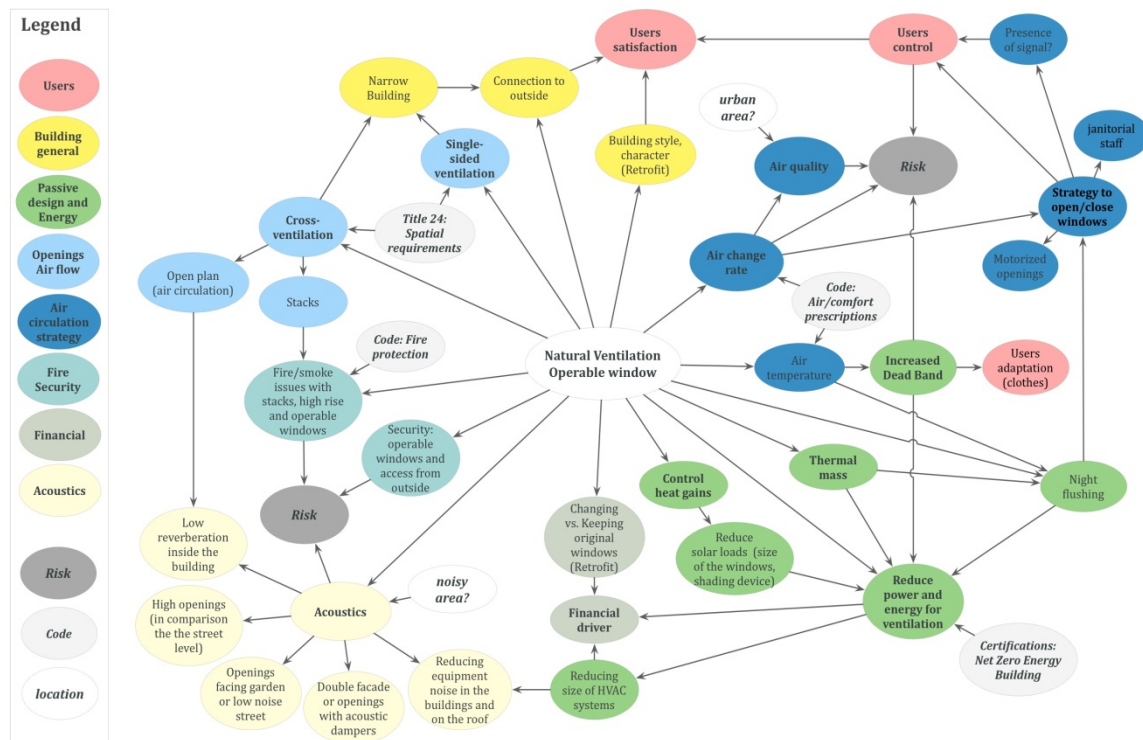

Interviews and Case Studies - Comparative Analysis

This section attempts to compare and contrast perspectives of various stakeholder groups: architects, engineers, owners, operators and occupants.

The following individual opinions were evident amongst specific stakeholder members:

Architects:

- Often enthusiastic about natural ventilation systems. Pointed out that responsive building layouts (open plan, cross-ventilation, stack) and operable windows were important elements.

- Concerned about preserving historical aesthetics of existing buildings when considering retrofit options.
- Integration of technical elements is important. One element can impact another.
- Aware of visible aspects linked to natural ventilation.
- Aware of adaptive comfort and how it relates to energy savings.
- Saw engineers as either enthusiastic or conservative and less confident towards the users. One interviewee stated, “you know there's this idea among engineers that occupants won't do stuff, we have to convince them that this is not the case...I rely on users to make natural ventilation happen”.

Engineers:

- Had a wide understanding of constraints associated with natural ventilation: control of solar loads, acoustics, operational strategies, etc. Most of the constraints of Figure 2.65 came from the engineers.
- Were in favor of natural ventilation, but doubted natural ventilation would be relevant as a single strategy (versus mixed-mode).
- Understood air change rate, temperature and humidity levels depended on user behavior and outside weather conditions.
- Were pessimistic about occupants’ capability to interact properly with the building. As one interviewee put it, “Most of the time users do not understand what makes more or less air...most of the time they don’t know what to do because they are often not educated [in ventilation system operation] or not interested”.
- Generally didn’t associate natural ventilation with energy savings, better air quality or comfort. This was primarily due to the abovementioned pessimism towards occupant control.
- Viewed mixed-mode, hybrid systems as better solutions than natural ventilation by itself.
- Commonly agreed on the positive psychological impact of operable windows.
- Viewed codes barriers to natural ventilation.
- One architect confessed that architectural implementation of natural ventilation elements was perhaps easier and less risky than the engineer’s control and risk aspects: “If something doesn't work, [engineers] get questions”.
- Due to grandfathered codes, viewed retrofits as a great opportunity to retain existing natural ventilation features like operable windows. This was provided the retrofit was not about improving the envelope.

- Viewed operator's role as highly important for success; for acceptance among occupants and for energy efficiency.

Owners:

- Feared user's complaints and impossibility to control indoor air temperatures.
- Most reluctant to implement natural ventilation and operable windows.
- Perceived as desiring tried and tested, standardized HVAC and control systems: One interviewee noted, "Clients wants standards. Their view of comfort is generalized, whereas users want something highly defined".
- View operable windows in mixed-mode systems as expensive, unnecessary features. Why pay for both mechanical and natural ventilation equipment? Engineers and architects felt that they often had to push the owner to keep operable windows in the mixed-mode design.
- An owner's energy officer, who was one of our most pragmatic and positive respondents, stated, "Make it a priority...put the proper commissioning requirements in the contract specification and base your budget on life-cycle costs, and get feed-back and buy-in from occupants".

Operators:

- Diverse attitudes toward natural ventilation due to diverse experiences.
- Those supporting natural ventilation found it important that occupants should be able to adapt their clothing.
- Important to explain building and system operation to the occupants at the beginning.
- Viewed control devices telling users when to open/close windows (red/green light) favorably since that would avoid arbitrary behavior, generate discussions and encourage users to operate windows properly.
- Those maintaining naturally ventilated buildings did not consider outdoor acoustics as an issue due to a lack of occupant complaints.
- Those favoring mechanical ventilation and control systems were usually more concerned about maintaining well-defined conditions and operating schedules than appeasing occupants. They were skeptical towards occupant understanding of buildings: "We explain systems to them because they don't get it. They just know 'give me hot because I'm cold'...some people are selfish".
- Agreed on energy issues and wished their building was exemplary.

Occupants:

- Clearly showed their enthusiasm for operable windows and personal control.

- Didn't see topic of ventilation as appealing or interesting, so had no preference.
- Some sensitive to design issues: they could be proud of the historic aspect of their retrofitted building.
- Had a varied opinion of what made a "good occupant". A range of definitions were presented:
 - Someone who was "excited about his/her space and interested".
 - "Someone who didn't complain too much".
 - Someone who "knows how the building works and why the building works like that", they should "use the building as a tool", "be able to use clothing" and have "a sense of collective issues", especially if their working space is shared. "In order to control their environment, occupants can use: windows, fan, etc. That's really low tech...but you need to know how all of that can work together".
- Did not perceive occupants as "good".
- Viewed educating occupants to understand and interact with their building as important, though they weren't sure that this was done enough.

2.4.4 Conclusions

The following are conclusions drawn from each research topic.

2.4.4.1 Fire Safety Codes and Standards

Code Modifications – New Buildings

IBC Section 403 requires smoke control systems for atria, malls and high rises. The purpose is to facilitate smoke removal in post-fire salvage and overhaul operations. The CBC Section 403 deviates from the IBC as it requires smoke control systems to provide tenable conditions for the evacuation and relocation of tenants. While this paper does not question the CBC's focus on occupant safety, we do recommend that Section 909 be changed to reflect the nationally-accepted IBC's approach to allowing "other approved designs that will produce equivalent results". This change would not be detrimental to the safety of occupants, but instead would allow designs to be based on research, empirical data, and state-of-the-art computational analyses. This would also be consistent with the history of code development, which has been based on engineering judgment and has evolved with increased experience, testing and improvements to computer simulation software. Such an engineered approach is allowed by other parts of the CBC.

Code Modifications – Retrofit of Existing Buildings

The CEBC's Section 1301 lists smoke control as part of a Recommendations for changing the CEBC's language are fewer, since it is already friendly performance-based evaluation of the building, but only imposes such systems on retrofits of high-rises, not atria or malls. CEBC Section 601.2 requires modifications or alterations to retain at least the safety level of the pre-retrofitted building. Although the CEBC has many requirements that are similar to the CBC's

requirements for new buildings, none provide guidance for modifying existing smoke control systems, or adding new ones where smoke control systems are not already present.

Modeled Case Studies

While there is room to expand the number of case studies and, the few studies this research presents indicate that modern analysis software is capable of proving whether engineered designs meet tenability requirements and provides some insight as to the potential for natural ventilation openings to be included in smoke control systems for atria, malls and high-rises.

2.4.4.2 Acoustic Design Standards

International legacy acoustic standards for offices are roughly consistent, recommending 40 dBLAeq to 50 dBLAeq in open offices and 5dB to 10dB lower in cellular or executive offices. They generally assume that buildings are sealed and air conditioned and that the recommended noise limits are met by controlling the steady background noise from building systems.

This research indicates that the allowable level of noise break in to naturally ventilated buildings can be set higher than the building services noise criteria for sealed mechanically ventilated buildings. Although inconclusive, the preponderance of the work suggests that 55dBLAeq may be appropriate.

However, it is not clear that such a criterion would be universally acceptable. Frequency content, temporal variability and the presence of impulsive or tonal characteristics of the external noise environment must be considered. Regional and individual responses are likely to vary. The research is inconclusive partly because people seem to adapt to their noise environments.

Use of natural ventilation can lead to very low internal noise levels (since there is no, or reduced, mechanical systems noise) which can exacerbate privacy problems. Masking sound can help in these situations.

Based on a criterion of 55dB LAeq, natural ventilation by means of operable windows should be feasible in external noise environments up to 65dB to 70dB LAeq. This range of external noise environment may be increased to 67dB to 85dB LAeq by the use of acoustically attenuated air transfer strategies. Increasing the acoustic attenuation generally increases the pressure drop so achieving the maximum attenuation to allow natural ventilation at the upper end of this external noise range may not always be possible.

Further work is recommended:

- Carry out noise measurements in, and/or outside, many naturally ventilated, and mixed mode, office buildings for which there are existing Post Occupancy Survey data. Identify the level of external noise break in and not just the overall noise level. Since responses to noise appear to vary by region, focus on buildings in California.
- Instigate cooperative global research with acoustic consultants providing noise data from one or two naturally ventilated buildings and arranging subjective surveys to be carried out to build up an extensive database.

- Continue sound laboratory investigations of the effects of external noise break-in, including a more comprehensive range of external noise sources, such as construction, freeway, aircraft and mechanical plant noise. Inclusion of typical occupational office noise in the simulations could also be considered.
- Consider the choice of noise index, or statistical noise descriptor, and the use of octave or third octave bands analysis, etc., to account for the frequency content, temporal variability and any impulsive or tonal characteristics of then external noise environment.

2.4.4.3 Impact of Climate Change

The analysis described in this section suggests that natural ventilation will provide an increase in potential for building conditioning throughout the year. Due to foreseeable overall dry bulb temperature increases, building energy consumption due to cooling demands will rise and building energy consumption for heating-related demands will fall. These trends work to offset each other and keep the typical annual energy consumption of buildings constant. The ramification of this is for a net zero change in carbon emissions due to climate change. The expected shrinkage in diurnal ranges will result in an increase in conditioning potential of natural ventilation during the day and provide more nighttime flushing. As temperatures are expected to increase in both winter and summer months in areas such as San Francisco, this potential will only be magnified.

The future increase in frequency of electrical “brown-outs” due to increased peak demand will alter the vulnerability and resiliency of buildings that rely on natural ventilation for part or all of their cooling needs. These buildings will prove to be more vulnerable in the face of sustained heat waves where passive nighttime flushing becomes ineffective, but more resilient due to resistance to solar gains in comparison to their all-mechanically-ventilated counterparts. Natural ventilation’s strong dependence on the outside environment means that it will undeniably be affected by future climate change. However, by implementing a mixed-mode system with above-design external temperatures, buildings will offer the most resilience and potential benefit in response to modeled climate change.

2.4.4.4 Ambient Air Quality

Dutton *et al.* (2013) conclude that retrofitting a small fraction of mechanically ventilated office building to natural ventilation may reduce the likelihood of Sick Building Syndrome (SBS), but results in a higher exposure of ozone and particulate matter which increases several adverse occupant health effects. Although the incremental increase in exposure is very small, the costs assigned to the resulting adverse health effects are significant and likely outweigh the reduction in SBS.

To minimize healthcare costs, exposure to ozone and PM could be substantially reduced by keeping windows closed on peak (10th percentile) ozone and PM exposure days. However, such a control strategy would likely require mixed-mode systems relying on mechanical cooling and ventilation for the “high pollutant” hours, which tend to coincide with periods of hot weather.

2.4.4.5 Project Experience and Client Contacts

The CBE survey research, case studies and interviews lead to the conclusion that there are three major socio-technical barriers and three major social barriers to implementation of natural ventilation:

Socio-Technical Barriers

Natural Ventilation is perceived as “Too Risky”. Engineers are hesitant to implement natural ventilation without a backup mechanical system. While natural ventilation used to be the only way to bring air into buildings, closely controlled mechanical ventilation and air conditioning systems have dominated the scene for the past 40 years and our culture has grown to expect them. Natural ventilation is not considered as an efficient design strategy, but rather a seasonal possibility. It leaves the indoor climate (temperature, humidity and air quality) subject to the outdoor climate and also the control preferences of occupants and/or building operators. Additionally, engineers need to struggle to prove their design to owners, and while design guidance and analysis tools are available, codes and standards work against natural ventilation.

Natural Ventilation is perceived as “Too Complex”. As Figure 2.65 suggests, there are many concerns, both direct and indirect, that could discourage implementation of natural ventilation systems. It is usually not one single concern but more likely a multitude of concerns that can render a natural ventilation system useless. For example, in one case study a building’s natural ventilation system was to operate throughout the summer and shoulder seasons. Several issues arose after design: a technical issue rendered a control system used to inform occupants when to open/close windows inoperable; upper level windows designed to take advantage of the stack effect appeared to be inoperable; and concerns about noise and air pollution led to the owner to run the mechanical system throughout the entire year. While most strategies for natural ventilation are compatible, some of them can be contradictory. For example, exposed thermal mass can be coupled with nighttime flushing to cool the building overnight. The next day high outdoor air temperatures are tempered by the cool mass. However, exposed hard surfaces tend to reflect sound and can lead to acoustical issues. Another example is where the opportunity for cross-ventilation leads to open plan offices. The open plan allows air to cross the space and condition all occupants, but also puts occupants in an environment where conversations are more easily overheard and noticed. This can lead to higher levels of dissatisfaction.

There is an industry wide lack of holistic thinking about Natural Ventilation. Table 2.26 “Principal responsibilities and interactions in the design team” from CIBSE AM10 on Natural Ventilation (cf. Section 2.2) shows that natural ventilation should be highly organized and orchestrated at various technical levels and phases of design, construction and occupancy. It demands the active involvement from all of the main stakeholders: architects, engineers, owners and facility managers. But in many cases, it seems that the project team (and even subcomponents of the team) is more siloed: each stakeholder works in a vacuum and expects the others to fulfill their obligations to contribute to system design. Table 2.26 shows that natural ventilation needs to be holistically addressed, at various technical levels and at all phases of the project.

Social Barriers

Natural Ventilation is seen as an option rather than of a feasible ventilation strategy. In mixed-mode buildings, the use of the natural ventilation mode may not be optimized. A comparison of four case-study buildings showed that the natural ventilation mode of mixed-mode systems was not used as often as it could be, primarily because the mechanical systems made users forget about opening windows during mild weather.

Figure 2.66: Natural Ventilation: Implemented Versus Used: Qualitative Analysis

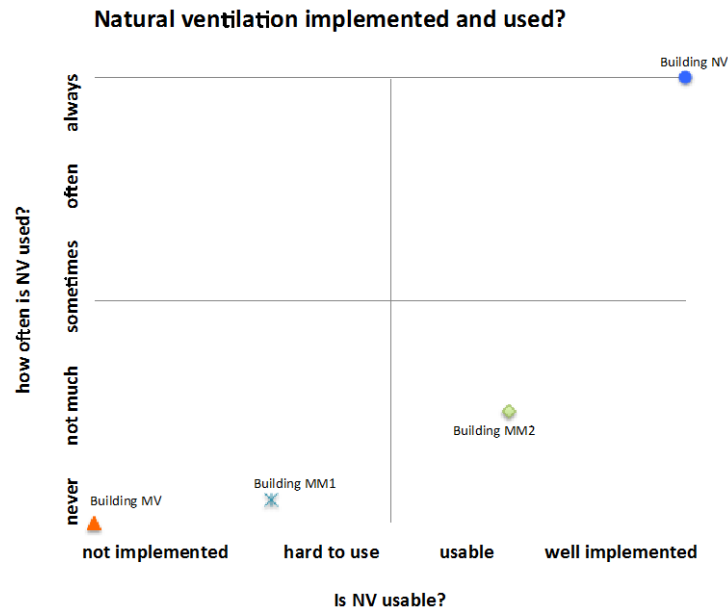

Occupants are accustomed to Mechanical Ventilation and Conditioning Systems. The author of the ASHRAE Journal Article, "Finding the Right Mix", states: "since the introduction of air-conditioning by Willis Carrier's 1906 patent, a half-dozen generations of Americans have become accustomed to mechanical conditioning of indoor spaces...". Interviews elicited the societal pressure argument summarized by the phrase "in our society" on several occasions. They also suggest that the "good user", one who can adapt and interact with the building, is a rare breed. Codes and standards help keep our society in this state.

Table 2.26: Principal Responsibilities and Interactions in the Design Team — Source: CIBSE AM10

Category	Client (owner)	Architect	Building services engineer	Client (facilities manager)
Briefing	Define: <ul style="list-style-type: none"> — site/location — activities — occupancy — performance criteria — control preferences 	Comment on: <ul style="list-style-type: none"> — area/volume requirements — plan depth/massing — orientation — spatial relationships — performance criteria 	Comment on: <ul style="list-style-type: none"> — performance criteria 	Comment on: <ul style="list-style-type: none"> — performance criteria
Ventilation strategy	Take ownership of strategy Question implications for: <ul style="list-style-type: none"> — lifecycle cost — occupant satisfaction — control options — CDM issues 	Define relationships of supply and exhaust for different purposes: <ul style="list-style-type: none"> — zoning — airflow paths — geometry — application of principles — CDM issues — operational instructions 	Define flowrates to achieve: <ul style="list-style-type: none"> — indoor air quality — cooling — local extraction of pollutants — control Pre-commissioning CDM issues Draft simple instructions for users	Question implications for: <ul style="list-style-type: none"> — occupants satisfaction — operation — maintenance — CDM issues
Ventilation openings	Implications for: <ul style="list-style-type: none"> — appearance — operation — maintenance — access — replacement 	Preliminary sizing of vent openings Opening type Weathering Security Clashes with other elements Airtightness/thermal performance Interface with building envelope	Preliminary sizing of ventilation openings for supply and exhaust Performance prediction in relation to briefing criteria Pollution and noise control Access for maintenance	Access for: <ul style="list-style-type: none"> — commissioning — cleaning — maintenance
Actuator		Implications for: <ul style="list-style-type: none"> — appearance — achieving required free area opening — achieving required ventilation purpose 	Choice of type in relation to: <ul style="list-style-type: none"> — weight and size of openings — type of opening — location (low or high level) — opening parameters 	Implications for: <ul style="list-style-type: none"> — operation — maintenance — replacement
Linkage		Number of openings operated Geometry and connections Maintenance and cleaning	Commissioning requirements Maintenance and cleaning	Implications for: <ul style="list-style-type: none"> — operation — maintenance
Controls	Implications of control and logic for occupant operation and satisfaction	Control logic Operation during construction Status feedback	Control logic: <ul style="list-style-type: none"> — status feedback — automatic/normal/fire modes — occupant override — wind/rain/snow thresholds 	Implications for: <ul style="list-style-type: none"> — operation — maintenance
Installation and commissioning	Recognise importance Ensure time in programme	Recognise importance Ensure time in programme	Commissioning requirements Access Witnessing	Access for commissioning Commissioning requirements
Operation and maintenance	Allow for training		Fine tuning Simple user instructions	Fine tuning CDM issues

Different stakeholders have different design priorities. Although interviews indicated all stakeholders generally favor natural ventilation, each ultimately has their own role, priorities, concerns and drivers. Table 2.27 presents a qualitative comparison of interview and survey responses to questions covering general building concerns and those related to ventilation. Each

horizontal bar represents priority level. While architects and occupants prefer natural ventilation over mechanical ventilation, ventilation in itself does not rank amongst either party's highest priorities. Conversely engineers and operators indicate one of their highest interests is ventilation but implementing natural ventilation systems is a relatively low priority.

Table 2.27: Priorities in the Design

	GENERAL CONCERNS								AS IT RELATES TO VENTILATION...		
	Design/Shape (material)	Image/Comm (unmaterial)	Social issues	Financial aspects Costs	Comfort	Energy savings	Ventilation	Compliance to the main code (avoid risk)	Natural ventilation (vs. Mechanical ventilation)	Importance given to personal control (users)	Importance given to central control (operator)
Architects	██████████	██████████	██████████	██████████	██████████	██████████	██████████	██████████	██████████	██████████	██████████
Engineers	██████████	██████████	██████████	██████████	██████████	██████████	██████████	██████████	██████████	██████████	██████████
Owners	██████████	██████████	██████████	██████████	██████████	██████████	██████████	██████████	██████████	██████████	██████████
Operators Managers	██████████	██████████	██████████	██████████	██████████	██████████	██████████	██████████	██████████	██████████	██████████
Occupants	██████████	██████████	██████████	██████████	██████████	██████████	██████████	██████████	██████████	██████████	██████████
Codes and Standards (general)	██████████	██████████	██████████	██████████	██████████	██████████	██████████	██████████	██████████	██████████	██████████

Solutions to Socio-Technical Barriers

Socio-technical barriers require technical solutions and a social consensus around their acceptance.

Retrofits should not be subject to new codes and standards. If retrofits would have to achieve all latest codes and standards, they would be considerably more expensive and many owners might reconsider their choice to retrofit. Also, the retrofits would sometimes necessitate further demolition that contradicts historical preservation. Retrofits by default suggest improving buildings and owners should be allowed to decide what they want to renovate. Finally, the argument made by ASHRAE 62.1-2010 to explain why mechanical ventilation should come in addition to natural ventilation in the last version of its standard is related to prescribed envelope performance of new buildings leading to higher air tightness and risk of mold.¹⁶ In the case of older buildings, this argument might be incorrect. For these reasons, depending on the original state of the building and the intent of the renovation, the latest codes and standards may not apply for retrofit cases. As one of our interviewees suggested, grandfathering codes might be a fair way to renovate buildings and to retain natural ventilation without adding mechanical systems.

¹⁶Allyson Wendt, 2009 article at <http://www2.buildinggreen.com/article/ashrae-requires-mechanical-ventilation-naturally-ventilated-commercial-buildings>.

Existing buildings should be seen as opportunities. Many existing buildings have operable windows and were once naturally ventilated. Most of them also incorporate complementary features like thermal mass, narrow footprints, tall floor-to-floor heights, etc. Retaining these features is a real opportunity. Retrofit also can be a good opportunity to improve buildings who are not so well adapted. In one case study, a naturally ventilated building was retrofitted on two occasions. First, in the 1960's, windows were sealed shut and the interior was partitioned. Later, in the late 90s, windows were unsealed, the internal partitions were removed, ventilation stacks replaced dumbwaiters and thermal mass was exposed. This argument supports the classification of building vintages and opportunities for natural ventilation by Kendrick *et al.* (1998).

The current emphasis on sustainable design is expediting technical solutions and standards that promote natural ventilation. Pragmatic industry guidance for implementing natural ventilation in new and renovated buildings is increasing as is the technology that makes it more feasible. Ventilated façades, interstitial blinds and electrochromic (smart) glass minimize direct solar loads. Phase-change materials take on a role similar to thermal mass. LED lights replace less efficient fluorescent lighting. Occupancy sensors turn off lights and power strips overnight and on weekends. Acoustic dampers and louvers reduce the impact of exterior noises. Etc. Also, ASHRAE Standard 55-2004 allows a wider range of comfort temperatures. Finally, certain features of sustainable buildings are proving to offer multiple benefits. For example, narrow building plans are conducive to both daylighting and natural ventilation. Designers need to become more aware of these technologies and exemplary case studies and use them to inform their own designs.

Natural Ventilation can be organized and implemented. It may take the right team to do it, but natural ventilation can be organized and implemented. As CIBSE AM10's table (Table 2.26 herein) illustrates, the stakeholders need to function as a coherent team. The architect needs to focus not only on the aesthetics of design but also the forms and details that maximize ventilation potential. The engineers need to solve all technical issues throughout the project (pollution and noise control, airflow rate, etc.). The client is mentioned twice and plays perhaps the most important role as owner and facility manager. The owner needs to be very active upfront, whereas the facility manager needs to participate throughout the design. In most cases the facility manager needs to be involved throughout building operation. In one extreme case study where a naturally ventilated building did not include an automation system, occupants were reminded to operate their windows throughout the day by signals. The janitorial staff assumed this role outside of normal occupied hours.

Solutions To Social Barriers

Social barriers require focus on the interaction between groups of people.

Occupants want to work in naturally ventilated buildings and can become responsible, active participants. When asked what constitutes a good building, many interviewees emphasized the importance of engaging building occupants. Passive, naturally ventilated buildings require occupants to become active users and break out of the passive state perpetuated by active

mechanical systems. This is not a foreign concept to most since natural ventilation is often used in private homes. The CBE survey data clearly shows occupants prefer naturally ventilated buildings over mechanically ventilated and conditioned buildings. Occupants can be encouraged to act in many ways, including building walkthroughs, fewer dress codes/restrictions, communication from facilities management staff at the start of each season, and incorporation of red light/green light user signals. Mechanical systems in mixed-mode buildings could be disabled during certain times of the year.

Open the design process to the occupants. Interviewees suggested that knowing the users of the building was a positive point for implementing natural ventilation. In some retrofit cases, occupants might already be used to natural ventilation so might not be averse to retaining such a system. Even if not, or in the case of newly constructed buildings, opening ventilation and comfort discussions to users could influence decisions in favor of natural ventilation and additional passive solutions.

Introduce natural ventilation gradually. As explained above, there is a lack of stakeholder confidence in occupants due to their long-standing relationship with air-conditioning systems. However, the move towards natural ventilation could happen via incremental steps. Mixed-mode or hybrid ventilation can be seen as a first step towards this move. This would be especially in the case for new buildings or retrofits involving currently sealed buildings.

Engage and encourage the design team. While ventilation and natural ventilation do not appear to be the highest priorities for most stakeholders, The CBE occupant satisfaction survey shows that thermal comfort, acoustic quality and general satisfaction are highest for naturally ventilated buildings. This alone proves that natural ventilation is a relevant solution and stakeholders should reconsider their priorities and get fully aligned with natural ventilation as a project goal.

Summary

In summary, many barriers and solutions are valid for both retrofit and new buildings, however retrofit cases offer further opportunities. Table 2.28 below summarizes barriers, solutions and arguments.

Table 2.28: Barriers, Solutions and Arguments for Natural Ventilation

	Barriers	Solutions / Arguments
Socio-technical issues	<ul style="list-style-type: none"> - Natural ventilation is perceived as “too risky” - Natural ventilation is perceived as “too complex” - There is an industry-wide lack of holistic thinking about natural ventilation 	<ul style="list-style-type: none"> - Retrofits should not be subject to new codes and standards - Existing buildings should be seen as opportunities. - The current emphasis on sustainable design is expediting technical solutions and standards that promote natural ventilation - Natural ventilation can be organized and implemented.
Social issues	<ul style="list-style-type: none"> - Natural ventilation is seen as an option rather than a feasible ventilation strategy. - Occupants are accustomed to mechanical ventilation and conditioning systems. - Different stakeholders have different design priorities. 	<ul style="list-style-type: none"> - Occupants want to work in naturally ventilated buildings and can become responsible, active participants - Open the design process to the occupants - Introduce natural ventilation gradually - Engage and encourage the design team

CHAPTER 3:

Thermal Comfort in Offices With Elevated Air Movement

3.1 Introduction

In naturally ventilated (NV) buildings, occupants have been found to experience equally acceptable thermal comfort as in air conditioned (AC) buildings, but over a wider range of indoor temperatures (de Dear and Brager, 1998). This phenomenon is accounted for by the adaptive model of thermal comfort, which predicts such a wider range (ASHRAE, 2004). The causes are not fully understood, but include the cooling effect of the elevated air movement that results from open windows, climatically adapted clothing change resulting from knowledge that a NV interior temperature will be related to the exterior temperatures, physiological adaptation, and the psychological benefits of having available personal control of the environment. In many NV buildings, operable windows are the most prominent source of air movement and personal cooling control, but it makes sense to supplement them with ceiling and desk fans. Such air movement devices now can use very small amounts of electricity, and give occupants air motion and personal control that are not dependent on outside wind conditions or on the occupants' distance from, or access to, an operable window.

This study investigates thermal comfort in office buildings equipped with both windows and fans. Three buildings were tested. One entirely NV building was studied intensively over time. Occupants were repeatedly surveyed over a course of a full year about their perceptions, satisfaction, and thermal preferences using a "right now" survey that obtains point-in-time responses to the environment. Coincident physical measurements were made of the environment and occupant behavior. The surveys were conducted 3 times/day for 2 weeks each month or for 2 weeks every two months when the weather was mild. Hourly window opening and fan operation was monitored, and the space's temperature, relative humidity, and CO₂ profiles were measured in 5 minute intervals. The resulting data helps address a variety of questions concerning behavior, adaptation, and comfort:

- How do occupants interact with windows and fans? And how to model behaviors of window and fan operation?
- How do adaptive opportunities and actions affect comfort?
- How do occupants' perceptions about air quality, temperature, and air movement relate to measured environmental conditions?
- Under what conditions are occupants comfortable? How do these compare with the adaptive comfort standard ASHRAE 55?

In addition to this first building, two more office buildings with operable windows and ceiling fans were surveyed. The CBE Occupant Satisfaction Survey was administered once in each building to obtain people's long-term experience of the indoor environmental quality (IEQ) and

its effect on their work performance. The main IEQ categories are thermal comfort, indoor air movement, perceived air quality, lighting, acoustics, space, and quality of furnishings and upkeep. Occupants' window and fan usage are also examined. An identical set of core questions of the CBE survey have by now been administered in over 600 buildings with over 65,000 individual surveys, resulting in a large database of responses that can be used as a performance benchmark of IEQ in the entire building stock. The scores from an individual building survey can be compared against the accumulated scores in the CBE occupant satisfaction database, using either the entire database or filtered subsets thereof.

3.2 Literature review

3.2.1 Comfort in Naturally Ventilated Buildings

The ASHRAE database (de Dear, 1998) compiles data from previous thermal comfort studies that used a "right now" survey and simultaneous physical measurements of environmental conditions at the occupant's workspace. Both AC and NV buildings are included. The measured air speed in NV buildings is two to three times higher than in AC buildings, but is still a fairly low value, averaging 0.3 m/s (60 fpm). This airspeed produces the equivalent of 2°C (4°F) cooling. The air movement is primarily due to flow through windows, and is probably less than optimal in warm conditions. The database shows that in both NV buildings and AC buildings, when occupants feel neutral or warm, the great majority are split between preferring more air movement or no change, and very few want less (Arens *et al.*, 2009; Brager *et al.*, 2004; Toftum, 2004; Zhang *et al.*, 2007).

Fans are one way to provide this desire for increased air movement. They can act as backup to less predictable wind-driven flows through windows in NV buildings. In climates with large daily temperature swings, they provide instantaneous comfort when air temperature is warm, and allow the windows to be closed during the hotter parts of the day while air movement for convective cooling is maintained. Fans can cool the occupants from above (ceiling fans) or from the side (stand and desktop fans, local air jets from personal systems (PEC)).

The combination of NV and fans is very energy-efficient. A modern ceiling fan provides 1.2 m/s air movement at occupant level using only 8 W (Zhai *et al.*, 2013), and a personal fan at desk or head level provides 1.5 m/s on the upper part of the body with only 3 W. HVAC cannot supply the equivalent level of cooling (over 3°C (6°F)) this efficiently. Buildings cooled by NV together with fans are feasible in many climates, limited primarily by whether the system provides an acceptable level of comfort. The acceptable climatic range can be expanded with 'mixed-mode' designs that use AC as a backup to NV during warmer periods, or in warmer sections of the building.

Laboratory studies of comfort under ceiling fans have shown that people can be comfortable at temperatures as high as 30°C (86°F) with airspeeds over 1 m/s (McIntyre, 1978; Rohles *et al.*, 1983; Scheatzle *et al.*, 1989). This holds even in humid climates (Kubo *et al.*, 1997; Zhai *et al.*, 2013). Studies of head-level air flow show similar levels of comfortable air movement and temperature (Zhang *et al.*, 2010).

Responding to such considerations, ASHRAE Standard 55 was recently modified to expand the allowable airspeed range in neutral to warm conditions (Arens *et al.*, 2009). This change enables new opportunities to use air movement in buildings to improve both energy and comfort performance. The standard specifies an inner zone in which ceiling fans can operate automatically in response to room temperature (Figure 3.1). (In the previous standard, fans had to be individually controlled, which in office buildings represented a severe limitation to their use.) The standard's outer zone requires only group control, which is also easier to satisfy in design than individual control.

Figure 3.1: ASHRAE Standard 55, Elevated Air Movement for Thermal Comfort

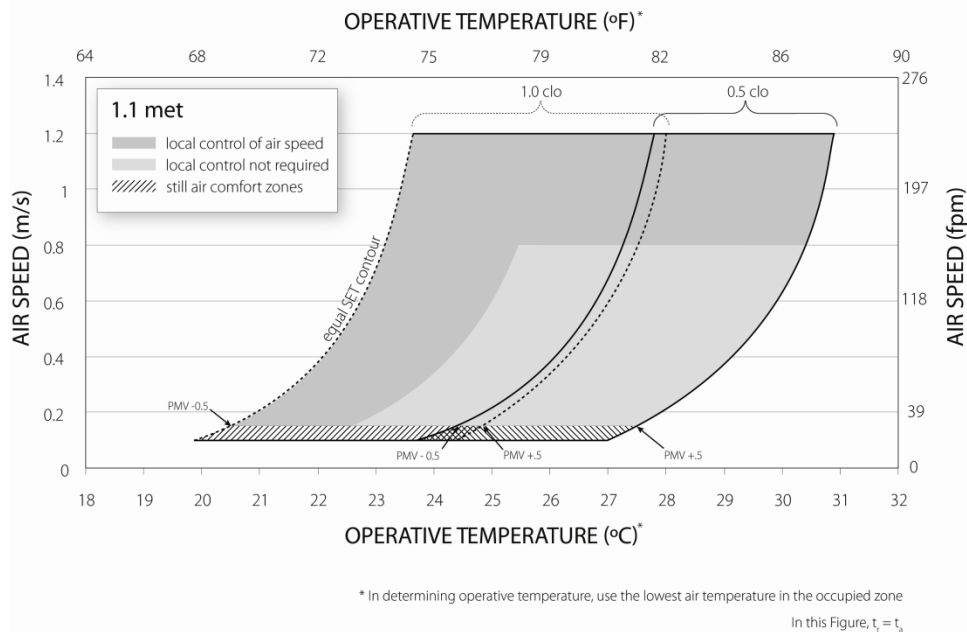

Source: Arens *et al.*, 2009.

3.2.2 Adaptive Action in Office Buildings

In NV buildings, occupants have control over windows and may also have control over doors, blinds, fans, personal heaters and standing air conditioners (for heating). Ability to access these controls is one reason why occupants accept a wider range of indoor temperatures. Several studies have looked at the factors that lead occupants to exercise these adaptive opportunities and the effects that they have on comfort.

Although the details of the methodologies and results vary, studies investigating window and fan behavior have consistently found that windows are used more frequently at lower temperatures than fans and that there is a strong correlation between usage patterns and both indoor and outdoor temperature (Liu *et al.*, 2012; Nicol, 2001; Raja *et al.*, 2001; Haldi and Robinson, 2008). Raja *et al.* (2001) found that the temperature threshold for opening windows was 20°C (68°F) indoors, with a steep rise in the frequency of opening at 27°C (81°F). This is similar to the use of fans, which started being used at 20°C (68°F) indoor and 15°C (59°F)

outdoor.. Employing a different metric, Haldi and Robinson (2008) found that there was a 50% probability of a window being open at 26°C (79°F) indoors and 23°C (73°F) outdoors compared to 28°C (82°F) indoors and 26°C (79°F) outdoors for fans.

Liu *et al.* (2012) found that the sequence of window and fan usage was part of a pattern of using controls that do not consume energy (windows, doors, curtains) before low energy alternatives (fans, air conditioners (for heating)). In addition to temperature, air movement preference and thermal sensation influence window opening behavior (Raja *et al.*, 2001; Nicol, 2001).

Adaptive control has also been analyzed by researchers mainly with an aim of identifying the effect of personal control on occupants. Comparing the thermal sensation of occupants who had and had not taken adaptive actions (windows, cold drinks, and fans), Haldi and Robinson (2008) found that those who had taken action had lower thermal sensations at high temperatures than those who had not. Even perceived control influences an occupant's thermal comfort and overall satisfaction of the work space (Paciuk, 1990).

3.2.3 Air Quality

Indoor air quality is an important contributor towards the overall satisfaction of occupants in buildings. Studies have shown that poor indoor air quality is one of the main reasons for sick building syndrome symptom, respiratory illness and short term sick leave (US EPA, 1991).

Studies by Seppänen and Fisk (2004) and Kajtár *et al.* (2003) have also shown a much higher chance of sick building syndrome symptoms in air conditioned buildings than in naturally ventilated buildings. The reasons for this are not fully understood.

However there are two potential downsides to NV designs. If a building relies entirely on window opening for its ventilation (the case at our test building,) there may be times when windows are all closed. During such times there may be a buildup of CO₂ and moisture originating from occupants, and other pollutants originating from indoor finishes and furnishings.

When the windows are open, unfiltered outdoor environment may have worse pollution than is found indoors, especially for ozone and particulates. NV buildings with operable windows will have less filtration and less absorptive area along the air's path into the building; this may result in higher levels of indoor particulates and ozone. It may also suggest design and operational modifications to time ventilation to respond to outdoor pollution concentrations.

Chapter 4 provides an analysis of indoor air quality risks associated with open windows.

3.3 Description of NV Test Building

The case study building is the office of Loisos + Ubbelohde, an architecture and energy consulting firm in Alameda, CA. As one of relatively few naturally ventilated offices with ceiling fans in the Bay Area, it is suited to the objective of this study. The office is 2,790 sf and is on the second floor of a 2-story building (Figure 3.2). It is made with wood frame construction with approximate R values of 30 in the floor and ceiling and 11 in the walls. Three of the four façades (not the southwest) of the building are glazed (15% overall window to wall ratio) with

double pane glass. Because it has low thermal mass, automated sun shades and insulation, the operative temperature indoors is approximately equal to the air temperature. Air temperature is used as a stand-in for operative temperature in the following analysis.

The office has two rooms of approximately equal size. 7 of the 13 occupants have their desks in the front (northeast) room. Overall, there are high internal loads from computers. There is also a printer, copier, and server in the front room, so it has higher internal loads than the back. The front room also has four ceiling fans and an exhaust fan that is usually turned off (Figure 3.2). The front room also has two personal fans at desktop level. The back room does not have any ceiling fans or an exhaust fan. Two people in the back room do have personal fans. The back room is glazed on two sides. There is no central heating in the office; it is mostly heated by internal gains, although there are also five personal electric heaters.

Figure 3.2: Photos and Drawings of Case Study Building

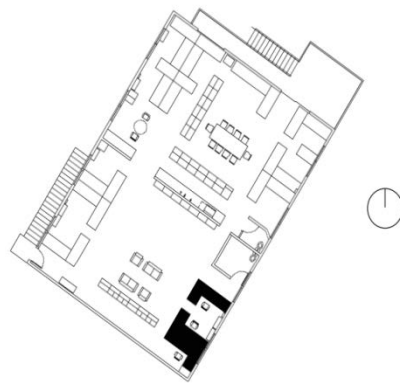
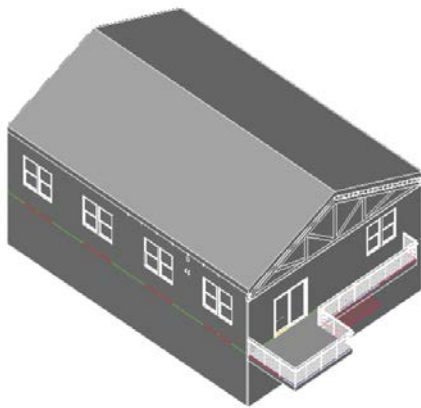

3.4 Physical Measurements and Occupant Satisfaction Survey

The office was extensively monitored from October 2011 to October 2012.

3.4.1 Outdoor Data Monitoring

Two hobo data loggers located outside the building recorded temperature and relative humidity at 5 minute intervals. Outdoor running mean temperature was calculated as a weighted average of the temperatures for the last 7 days using $\alpha=0.66$ (Nicol and Humphreys, 2002).

An outdoor weather station was set up at the top of a 10m high structure right outside of the building. A vane anemometer recorded wind velocity and direction every 5 minutes.

Outdoor CO₂ levels were also recorded.

3.4.2 Indoor Environment Monitoring

Hobo data loggers were distributed in every workstation, recording temperature and relative humidity at five minute intervals. 10 were placed in the front room and 6 in the back room to monitor local variation within each room.

The settings of the four ceiling fans in the front room of the office were monitored via a voltage recorder. The settings of the personal fans were not recorded. The settings of the five personal heaters were also monitored by voltage recorder.

Two time lapse cameras were set up in the front and the back rooms to take pictures of the window positions every 5 minutes. These pictures were read to determine opening percentages for each hour, as illustrated in Figure 3.3.

CO₂ levels were recorded in both the front and back rooms. More extensive air quality measurements that also considered ozone and particle levels were performed by LBNL from September to November 2011.

Figure 3.3: Window Opening Percentages

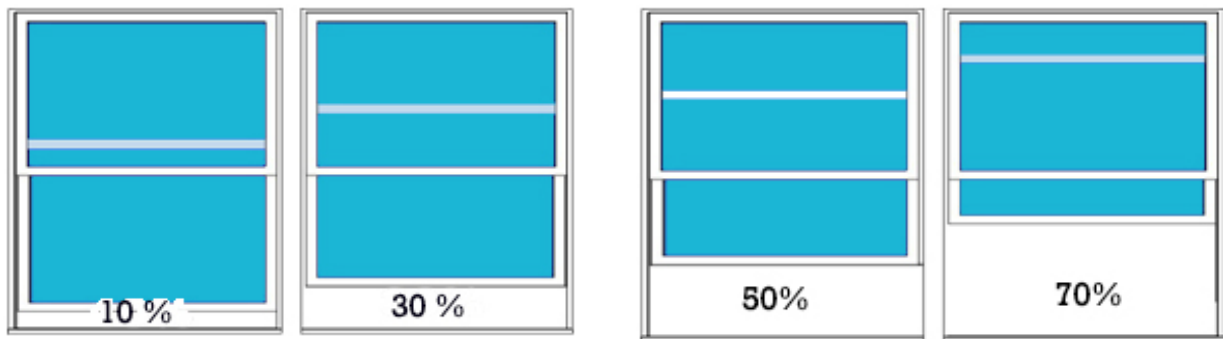

3.4.3 Occupant Survey

The occupants answered a custom “right now” survey 2 weeks per month between October 2011 and October 2012. The survey was administered three times a day, asking about thermal comfort (sensation, acceptability, and preference) as well as air movement, air quality, noise, and clothing. The occupants were reminded by email when it was time to go to a web link. The survey consisted of continuous scales that could be marked anywhere with the cursor. Thermal sensation responses were converted to the 7-point ASHRAE scale from -3 (cold) to 3 (hot). The responses to questions about thermal, air movement, and air quality acceptability were also converted to a 7-point scale from -3 (not at all acceptable) to 3 (very acceptable).

The full survey is included in an appendix (Section 3.7).

3.5 Results

3.5.1 Outdoor and Indoor Air Temperature Analysis

Alameda experiences a typical Bay Area climate, with mild winters and summers except for short periods of extreme high temperatures. The progression from hot to cold is not smooth; there are often large differences between one day and the next.

Figure 3.4 shows the seasonal distributions of air temperature for outdoors (Hobo 3), the front room (Hobo 12), and the back room (Hobo 14). In winter and swing seasons, back room air temperature was slightly warmer than the front room temperature, because windows were normally closed during these seasons and front door in the front room was open frequently. In the summer, the temperatures in the two rooms were very close. Figure 3.5 shows the air temperature during the different times of day throughout the year. In these figures, white is 23°C (73°F) with yellow and blue being warmer and cooler, respectively. The darker the colors the more extreme the temperatures are.

Outdoor air temperatures were generally cool. Typical winter temperatures were between 5 and 18°C (41-64°F) and summer between 15 and 26°C (59-79°F) (Figure 3.4a). There were hot periods in April to November, but even these were confined to daytime; the evening to mid-morning hours were consistently cool. In addition to this diurnal variation, there was also considerable variation between days in the same week. Two or three days may be hot in the afternoon and

then the next few days were likely to be comfortable or even a bit cool at that same time (Figure 3.5a).

Indoors, by contrast, the temperature was usually warm over the course of the year, mostly at least 23°C (73°F). The cool periods were mostly during the mornings in November to April; many mornings that started out cold turned into warm afternoons. As with the outdoor temperature, clusters of days varied considerably one to the next (Figure 3.5b-c). The total range of indoor temperatures in the summer was smaller than the rest of the year, about 10°C (18°F) as opposed to 15°C (27°F) in the swing and winter seasons (Figure 3.4).

Figure 3.4: Seasonal Temperature Distributions

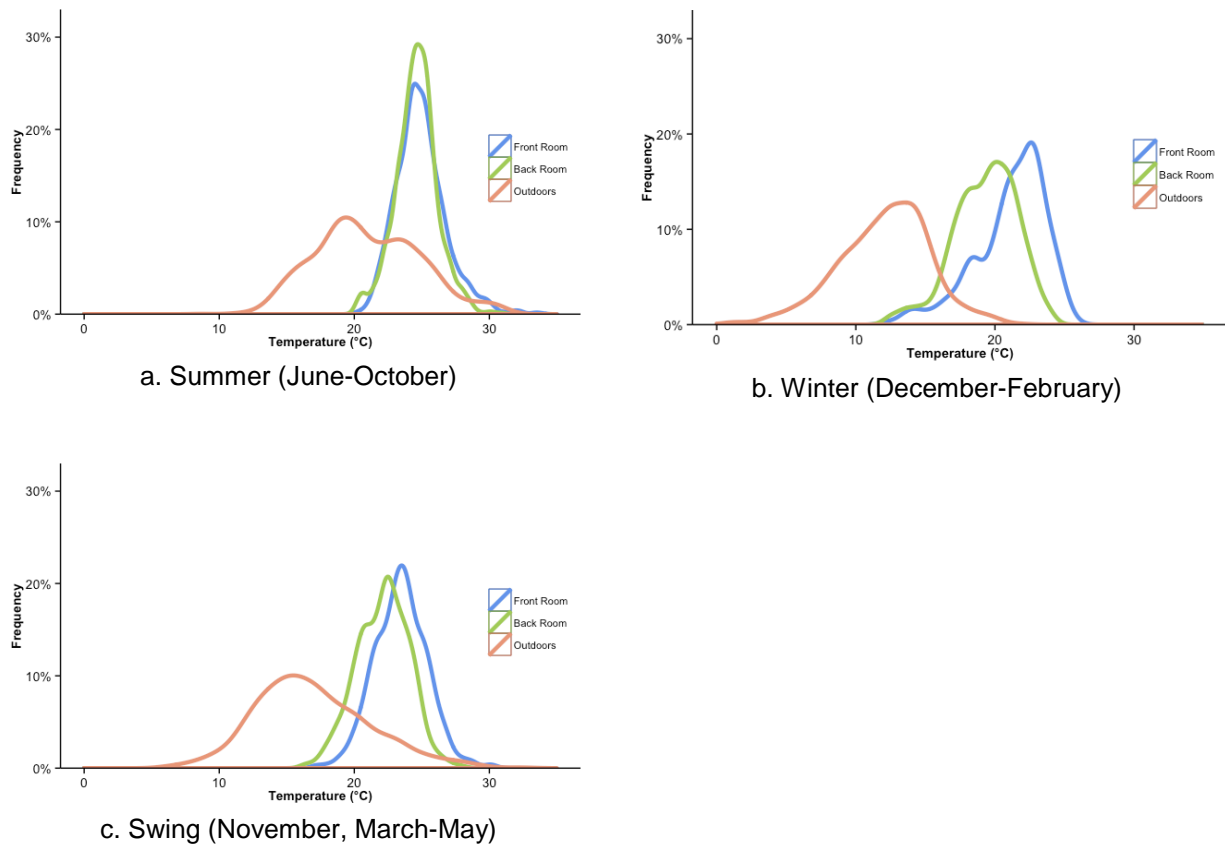
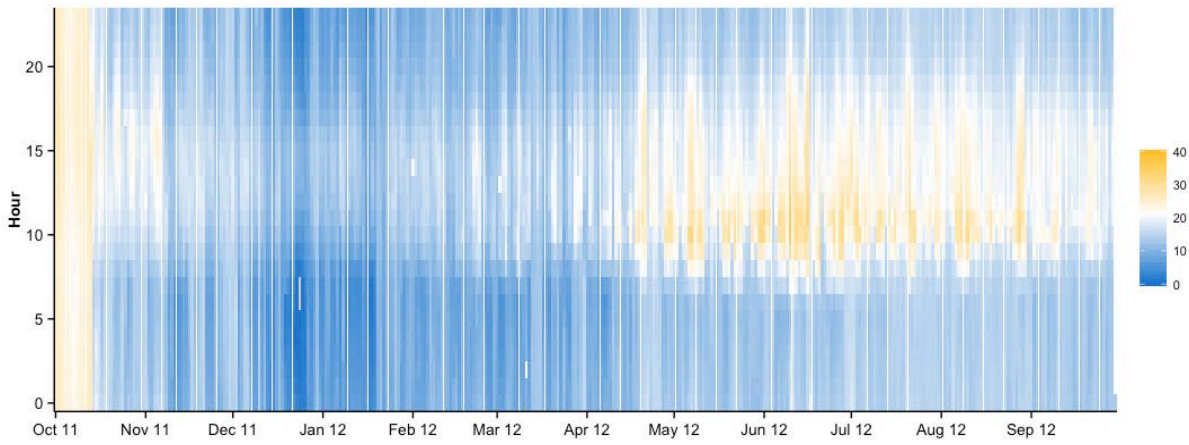
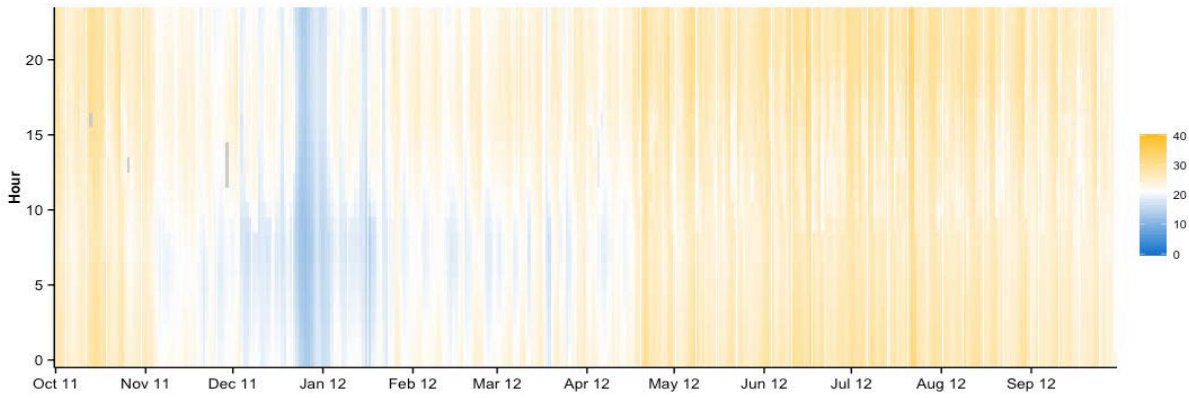

Figure 3.5: Annual Temperature Patterns



a. Outdoor



b. Front Room

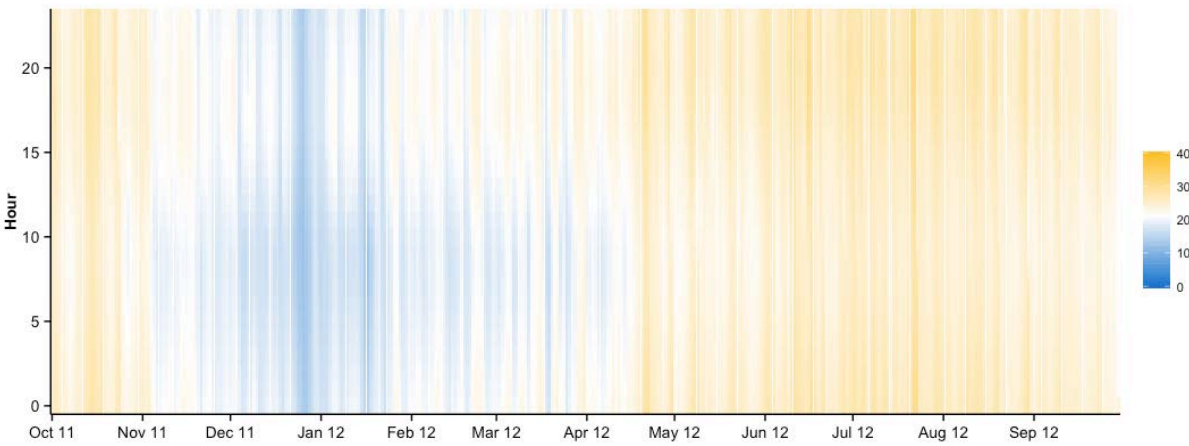

c. Back Room

The indoor temperature throughout the office space was relatively uniform: variation between the measurement points was generally less than 1°C (2°F). Nevertheless, the back room is consistently cooler than the front room by about 2°C (4°F) in the swing and winter seasons. Possibly this is because of higher internal loads in the front room due to higher occupancy and more plug loads. In the summer, the difference is much smaller, generally less than 1°C (2°F). The extreme temperature differences in the winter (January through April) are caused by personal portable heaters.

For the rest of the analysis, we use Hobo 12 for the front room and Hobo 14 for the back room because there is very little difference between hobos in the same room, and these loggers have the most complete data.

During occupied hours, the indoor temperature (y-axis) was consistently above the outdoor (x-axis) especially at lower outdoor air temperatures (Figure 3.6). This is attributable to internal loads from people and equipment, and lack of mechanical ventilation. Even in summer, the outdoors were often cool and windows closed in evenings and early mornings, so indoor air temperatures were higher than outdoors.

Figure 3.6: Indoor-Outdoor Temperature Comparison

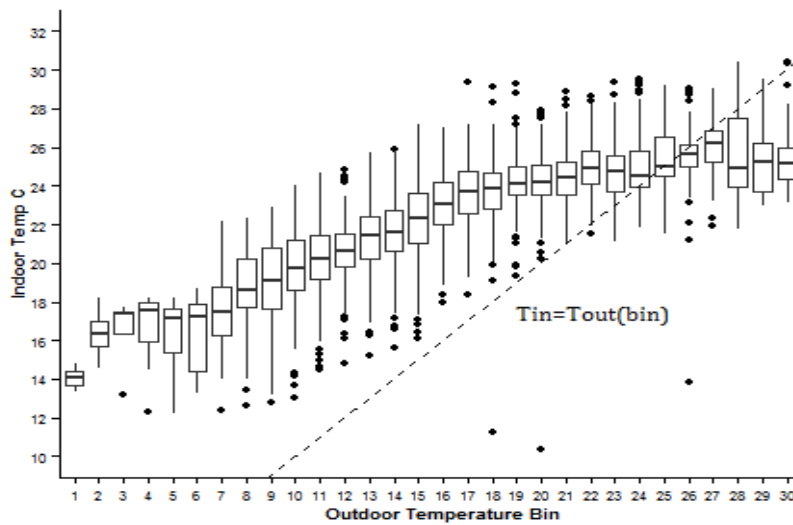

3.5.2 Wind analysis

Outdoor wind speed between 3-6 m/s (7-13 mph) was observed in the afternoons between April to September shows a wind rose of velocity binned per 5°C (9°F). Wind direction is predominantly from northwest, perpendicular to the building's long facade.

Figure 3.7: Hourly Wind Speed

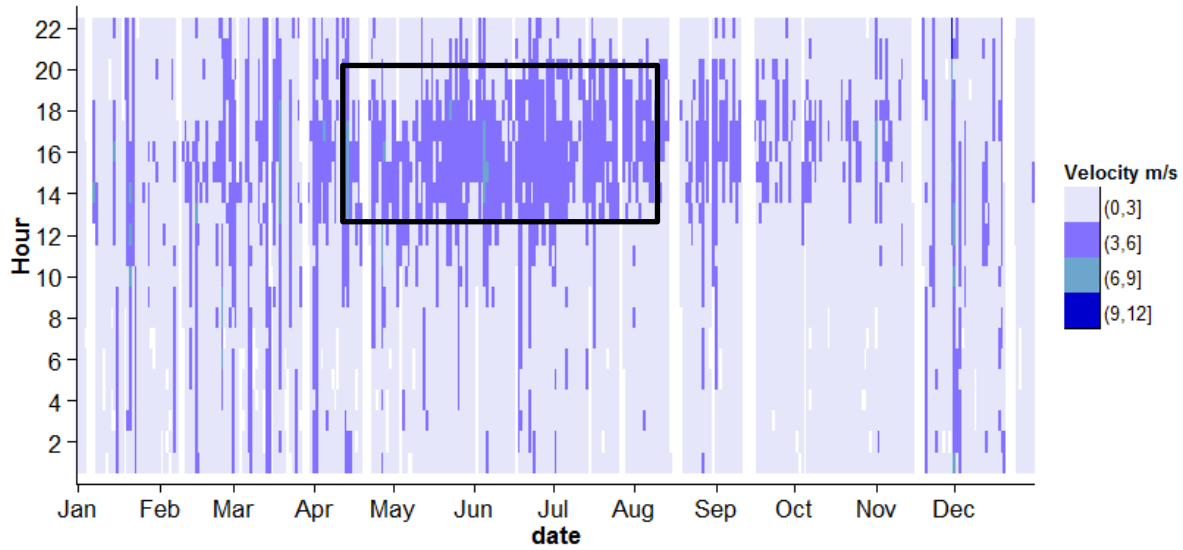
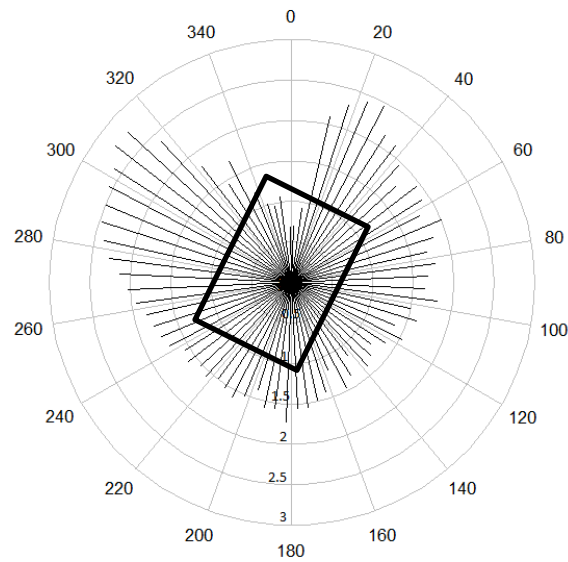

Figure 3.8: Annual Wind Rose



3.5.3 Clothing

Occupants changed their clothing levels significantly through the year ($p < 0.001$ - ANOVA test). In summer, occupants wore a clothing range of 0.5-0.6 clo (0.55 median), which is 0.2 clo units less than the winter range of 0.7- 0.8 clo (0.75 median) (Figure 3.9). This seasonal difference is wider than the 0.07 difference found in the ASHRAE RP-884 and RP-921 databases and similar

to what has been found in Japan (Schiavon and Lee, 2013; Goto *et al.*, 2007). Even so, the winter range is substantially different than the “typical winter indoor” value of 1.0 clo (ASHRAE, 2010).

Our data shows a running mean outdoor temperature with $\alpha = 0.66$ (Nicol and Humphreys, 2002) to be the best temperature metric for explaining clothing variation ($R^2 = 0.35$, $p < 0.001$). Multiple linear regressions including both outdoor and indoor temperature found indoor temperature to be an insignificant predictor variable ($p = 0.814$), which implies that occupants’ wardrobe decisions are independent of indoor temperature.

Figure 3.9: Monthly Clothing Patterns

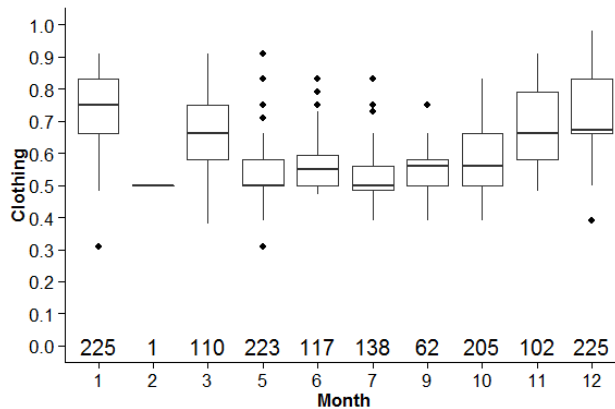

3.5.4 Windows

The fifteen windows in the front and back rooms of the office (Figure 3.10) were photographed every five minutes for a year to determine when and how much they are open. The patterns of opening show a strong temporal dependence on both monthly and daily timescales. Figure 3.11 shows that the windows are only opened between April and October. Figure 3.12 indicates that windows are most often opened in the morning (left chart) and closed in the evening (right chart) as people go home. Figure 3.13 shows window opening frequencies for all 15 windows for three seasons: summer, swing, and winter. It is interesting to note that opening patterns vary considerably among occupants. Some people open their windows very frequently; while others leave theirs closed all the time (Figure 3.13). One explanation for why some of the windows are not opened is location. Most of the windows are paired (e.g. f2 with f3), and often only one window is opened and the other one is left unadjusted (Figure 3.10, Figure 3.13).

Figure 3.10: Window Positions and Labeling

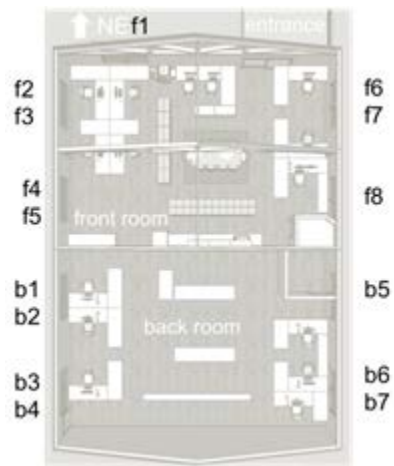

Figure 3.11: Window Opening by Month

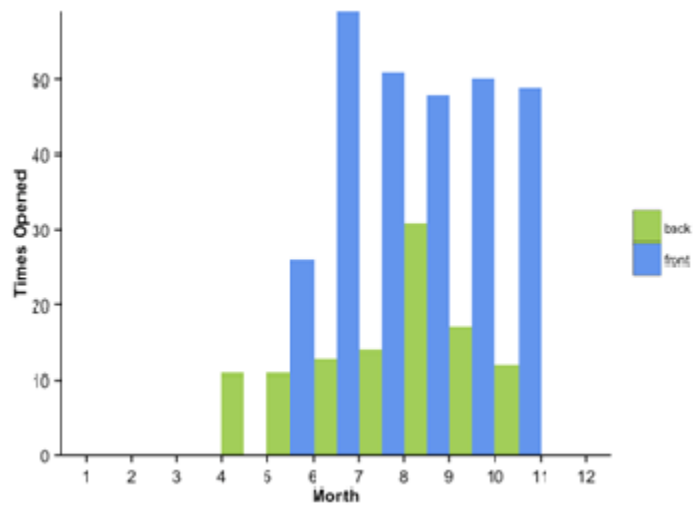

Figure 3.12: Window Daily Adjustment Patterns

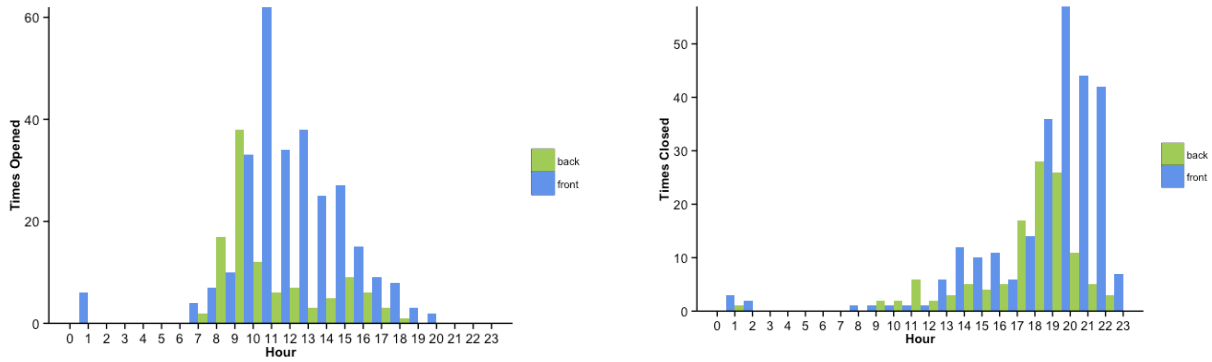
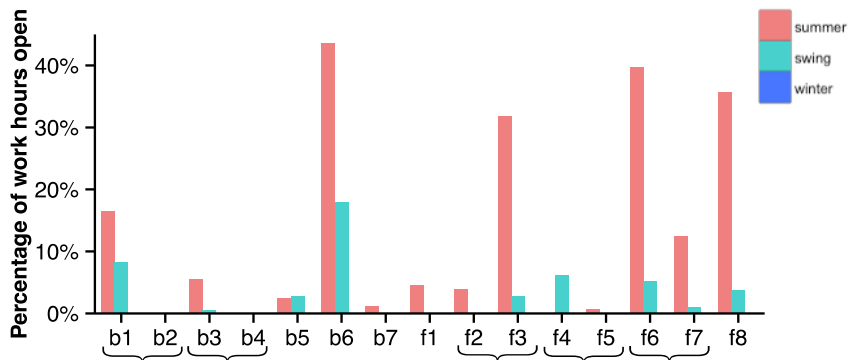

Figure 3.13: Window Opening Frequency



Considering only the times when the state of the window changed from closed to open or from open to closed helps uncover the conditions under which people adjust their windows. It would make sense for people to be more likely to open windows at higher indoor temperatures and close them at low indoor temperatures. But the data show that people are more likely to take the action of closing windows at higher temperatures and opening them at lower ones (Figure 3.14a&b). This shows that window opening is occupancy driven: people open them in the morning when they come in and close them in the evening when they leave (Figure 3.12). Because it is cooler in the morning than the evening (Figure 3.5), windows tend to be opened at cooler temperatures than when they are closed. Figure 3.14c&d examines this question further by considering temperature distributions for window adjustments that occurred only between 2 and 4 pm. With the shorter time period, there is less time-dependent temperature variation, and changes in window state are unlikely to be a result of people coming or leaving. The pattern for the front room is unclear, but for the back room, the temperature when a window is closed tends to be lower than for when it is opened (Figure 3.14c&d). This supports the idea that the counterintuitive result in 3.15a&b is caused by occupancy and time-of-day effects.

Figure 3.14: Indoor Temperature When Windows are Adjusted

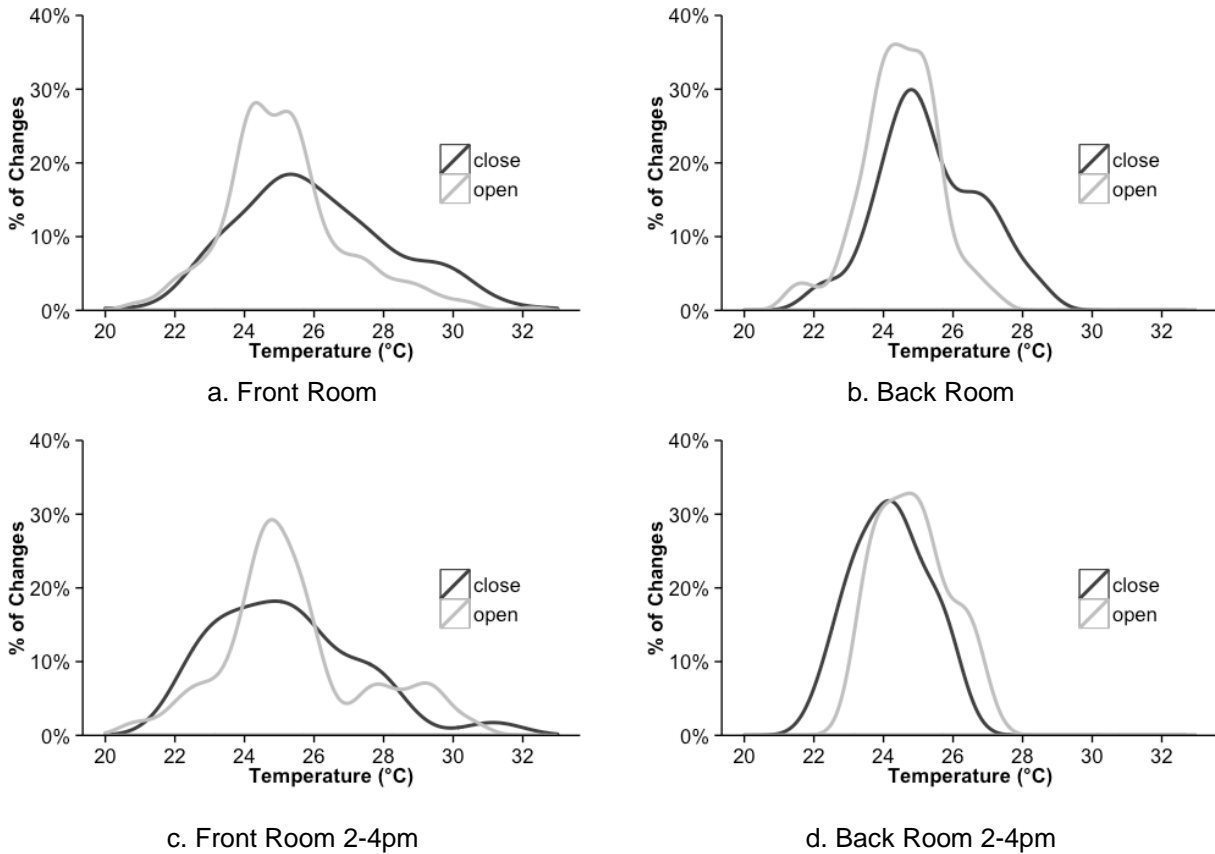
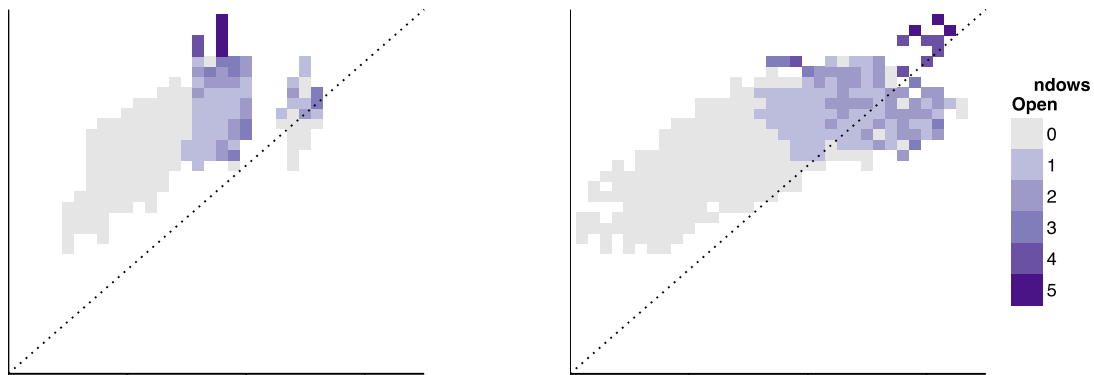

Figure 3.15 shows the average number of windows open for various combinations of indoor and outdoor temperature. Outdoor temperature is represented both with the outdoor running mean for each day and with the concurrent temperature for each opening position. The equal temperature contour is overlaid on the data for reference. Only work hours are shown. Graphically, the number of windows open appears to be more strongly related to outdoor temperature, either concurrent or running mean, than indoor temperature because there is a distinct vertical dividing line at 15°C (59°F) between outdoor temperatures at which windows are open. This is consistent with one occupant's explanation (during a conversation) that they open the windows on days that are likely to become hot, before it is actually too warm in the space. This would be appropriate NV operation. It is however interesting to note that at least one window was open 90% of the time that outdoor air was warmer than indoor.

Figure 3.15: Windows Open vs. Indoor and Outdoor Temperature



3.5.5 Fans

The settings of the four ceiling fans in the front room of the office were monitored via a voltage recorder. The settings of the personal fans were not recorded, and the back room does not have ceiling fans, so only the front room is considered in this analysis (Figure 3.16).

Figure 3.16: Fan Position and Labeling



The ceiling fans are turned on much less frequently than the windows are opened (115 times during the year compared to almost 400 times) but mostly over the same April to October time period (Figure 3.17, Figure 3.11). Within a day, fans are more likely to be turned on in the morning or early afternoon and turned off in the late afternoon or evening when people are leaving (Figure 3.18). Since there is a wider distribution of hours when fans are frequently turned on than turned off, one may conclude that turning on a fan is temperature driven while

turning it off is best explained by occupancy. Unlike the windows, which show large differences in usage frequency (Figure 3.13), the fans are all used approximately the same amount (Figure 3.19). However, this is not because all four fans are usually on at the same time; Figure 3.20 shows that about half of the time only one fan is on.

Figure 3.17: Fan Use by Month

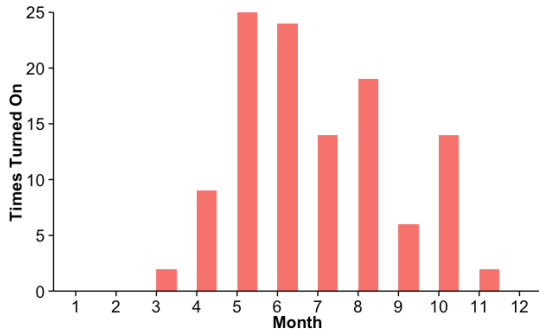

Figure 3.18: Fan Daily Adjustment Patterns

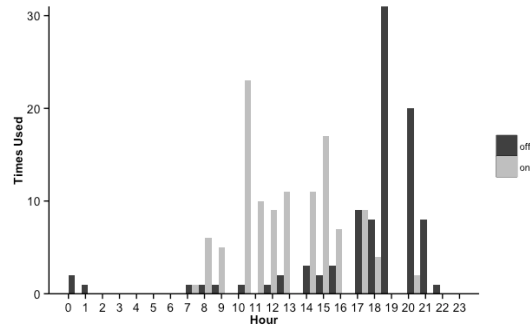

Figure 3.19: Fan Usage Frequency by Season

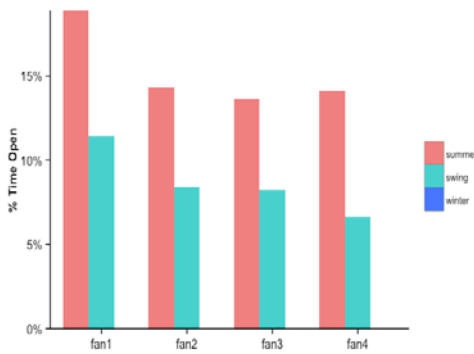
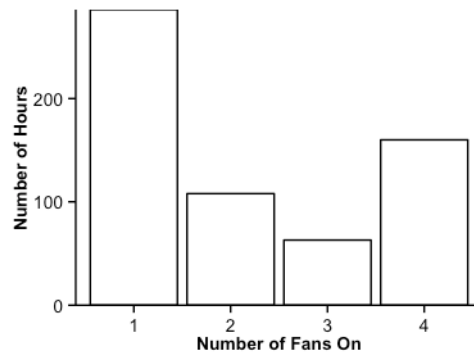
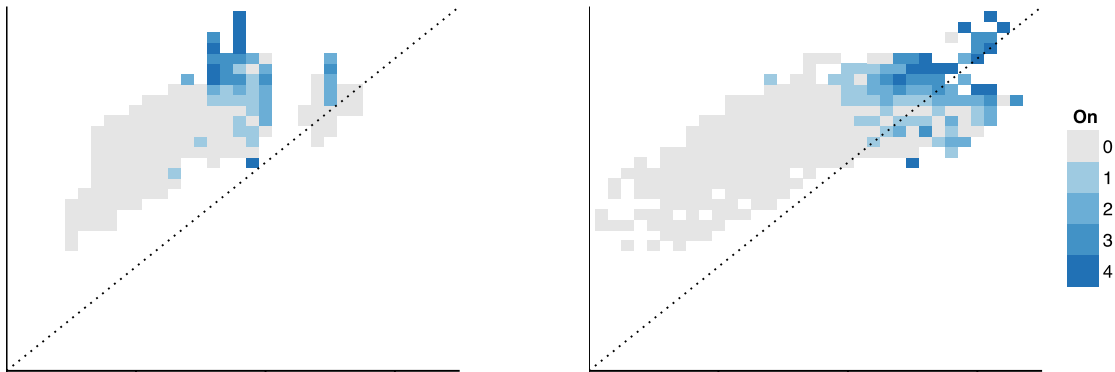

Figure 3.20: Number of Fans On



For the combinations of indoor and outdoor temperature that occur during work hours, the number of fans on appears to be more related to the indoor than outdoor temperature. This is unlike the windows patterns that are more closely related to outdoor temperature (Figure 3.15). It was expected that fans would be on almost all the time when the outdoor temperature is warmer than the indoor because air movement is then the best way of achieving thermal comfort. However, at least one fan was on only 40% of the time that indoor temperature was greater than concurrent outdoor (Figure 3.21). The fans start being used at higher indoor and outdoor temperatures than the windows—26 and 21°C (79 and 70°F) vs. 23 and 16°C (73 and 61°F), respectively (Figure 3.22).

Figure 3.21: Fans on vs. Indoor and Outdoor Temperature



3.5.6 Interactions Between Windows and Fans

Occupants started opening the windows frequently at an indoor temperature of 21-22°C (70-72°F) and a concurrent outdoor temperature of 16°C (61°F). While people turned on fans at lower temperatures, they only used them frequently at indoor temperatures above 18°C (64°F) and outdoor temperatures above 24°C (75°F).

When the fans are on, the windows are very likely to also be open. Of the 18% of work hours when the fans are on, 47% of the time the windows are also open. Conversely, if at least one window is open, the fans are likely to be off: of the 34% of work hours when the windows are open, the fans are also on only 29% of the time (Figure 3.22).

Figure 3.22 Combinations of Windows and Fans vs. Temperature

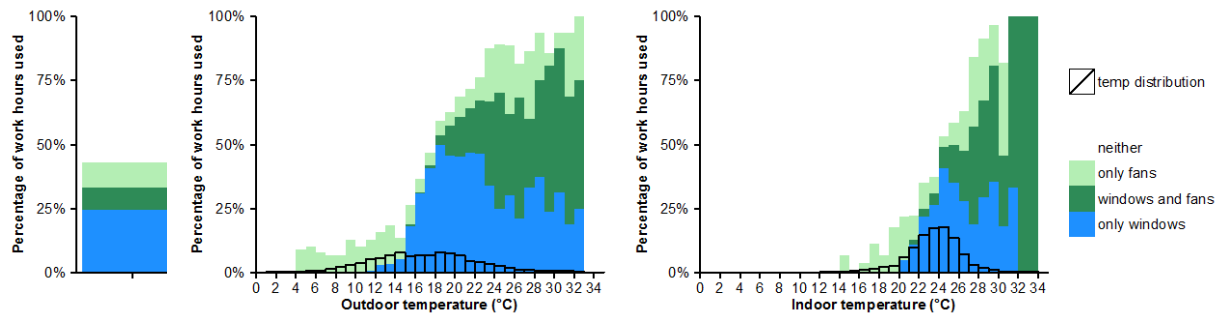

3.5.7 Heaters

The settings of the five personal heaters were monitored via a voltage recorder. Their locations are shown in Figure 3.23.

Figure 3.23: Heater Positions and Labeling

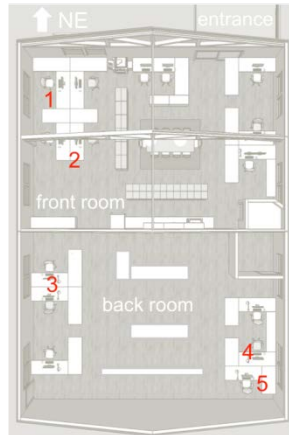

The portable heaters are turned on very infrequently — only 89 times for a total of 210 hours in all of 2012. They are used from October to April (Figure 3.24). Surprisingly they are not usually turned on until after 10 or 12 noon even though the indoor temperature is colder earlier in the morning (Figure 3.25, Figure 3.5). Like the windows, there are large differences in usage frequency between the different heaters (Figure 3.26).

Figure 3.24: Heater Use by Month

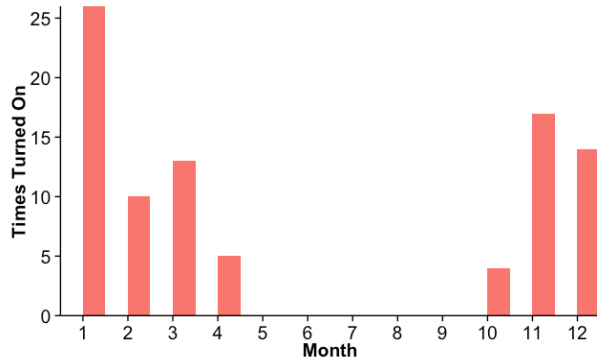

Figure 3.25: Heater Daily Adjustment Patterns

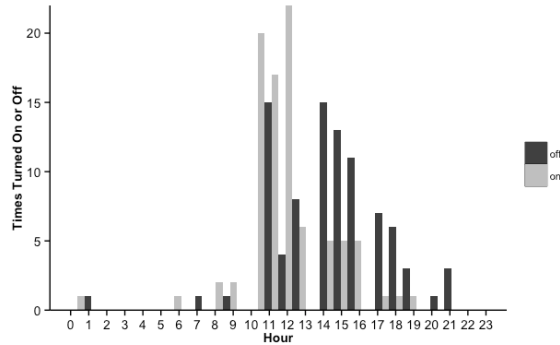

Figure 3.26: Heater Usage Frequency

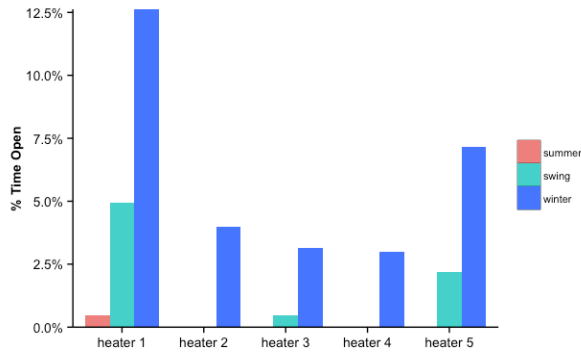
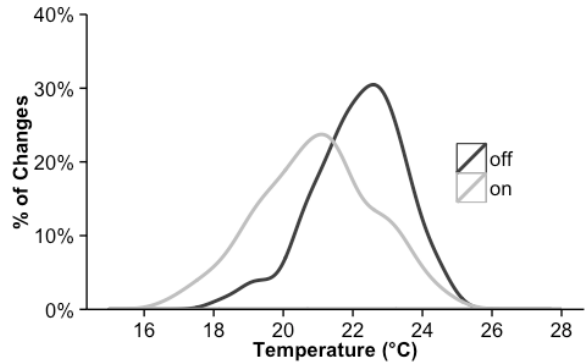

Figure 3.27: Temperature When Adjusted



Considering only those times when the state of the heater changed from off to on or vice versa shows that the heaters tend to be turned on at lower temperatures and off at higher ones, although there is clear overlap (Figure 3.27).

The heaters are used only in a narrow range of indoor and outdoor temperatures: less than 25°C (77°F) indoors and 20°C (68°F) outdoor running mean. But even in these ranges, the heaters are off the majority of the time (Figure 3.28, Figure 3.29).

Figure 3.28: Number of Heaters on

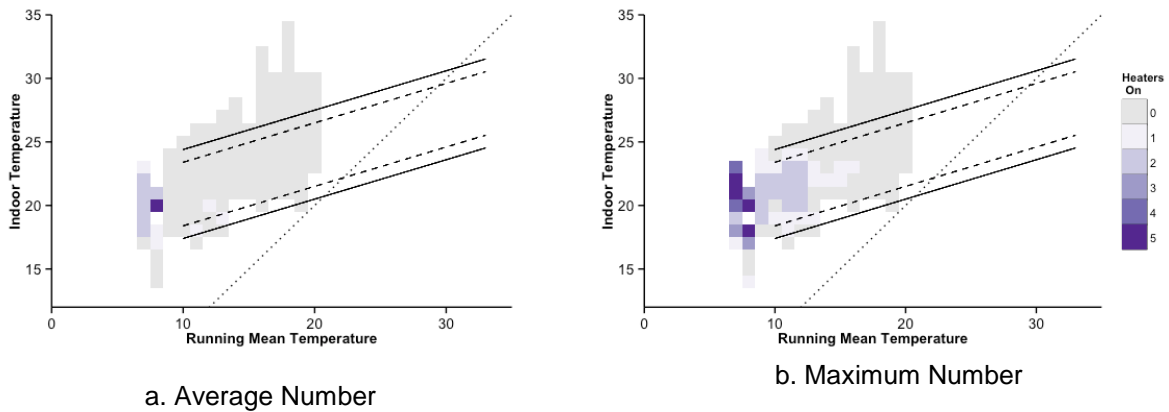
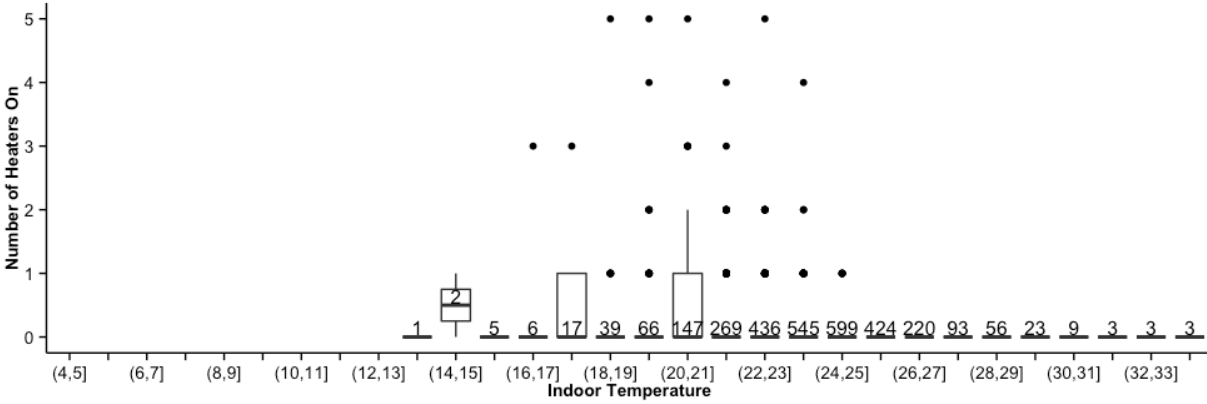
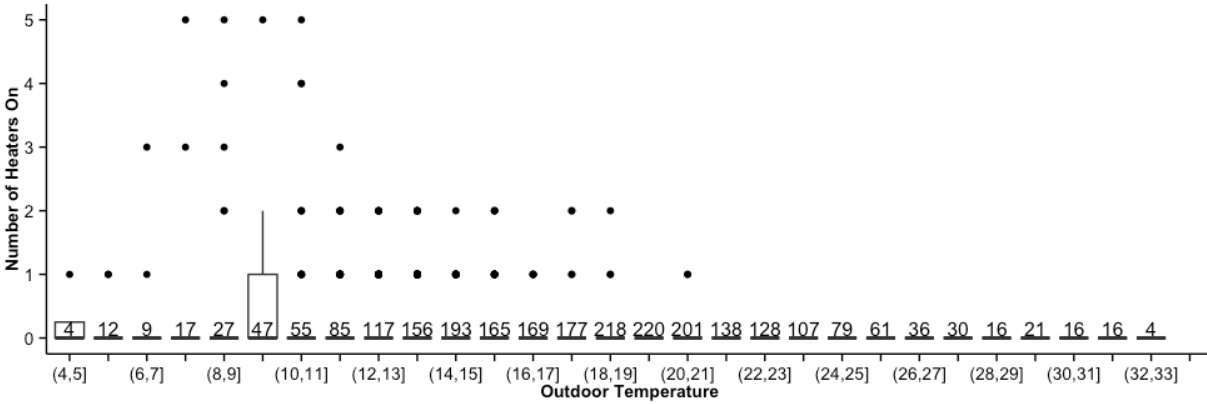

Figure 3.29: Temperature and Number of Heaters on



a. Heaters and Indoor Temperature



b. Heaters and Outdoor Temperature

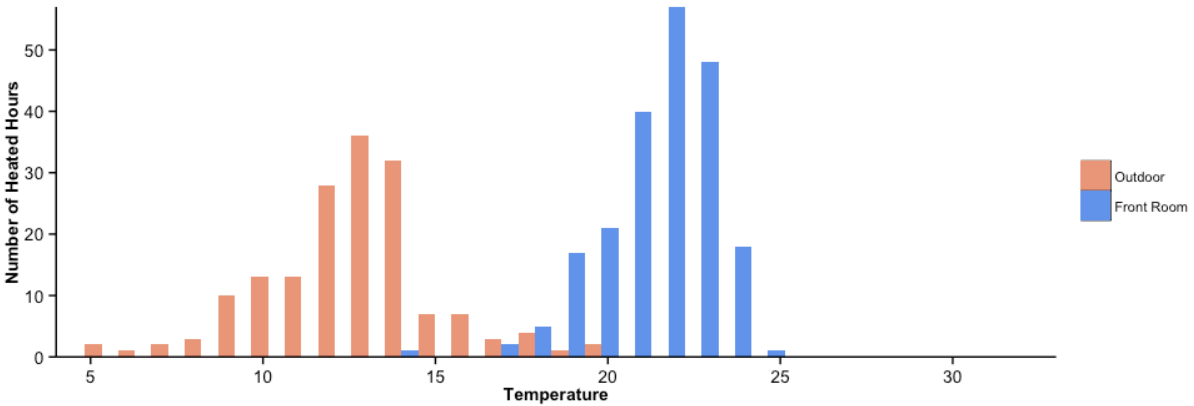

c. Temperature of Heated Hours

Although the fans and heaters are turned on a similar number of times (115 vs. 89), the heaters are on for less time overall. Figure 3.30 compares the lengths of time that each adaptive mechanism is used. Heaters are used mostly for short durations (left side), while windows and fans are commonly used up to 12 hours at a time.

Figure 3.30: Window, Fan, Heater Usage Durations

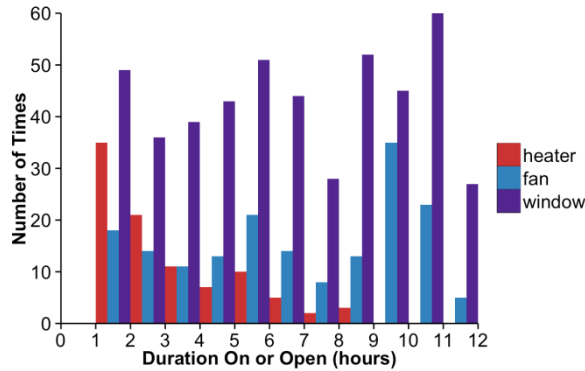

3.5.8 CO₂ Measurement and Perceived Air Quality

Operable windows facilitate a high air exchange rate between outdoors and the interior space. Although most of the ventilation studies cited in the literature review were carried out in mechanically ventilated buildings, the effects of ventilation also apply to naturally ventilated buildings.

3.5.8.1 CO₂

CO₂ was monitored in the front and back rooms as well as outside for 11 months. The outdoor concentration was relatively constant whereas the indoor concentration fluctuated at both weekly and monthly time scales. In particular, there are high indoor concentrations up to 600 and 700 ppm from November to March when the windows mostly remain closed. During the rest of the year, the CO₂ concentration in both the rooms has much less variation and is closer to outdoor levels. Although the concentrations in the front and back rooms are more similar to each other than to the outside, the back room generally has about 100 ppm more CO₂ than the front room throughout the year (Figure 3.31). Perhaps the difference comes from the front door and the small exhaust fan in the front room that intermittently caused outdoor air to enter even in the winter.

Figure 3.31: Monthly CO₂ Concentrations

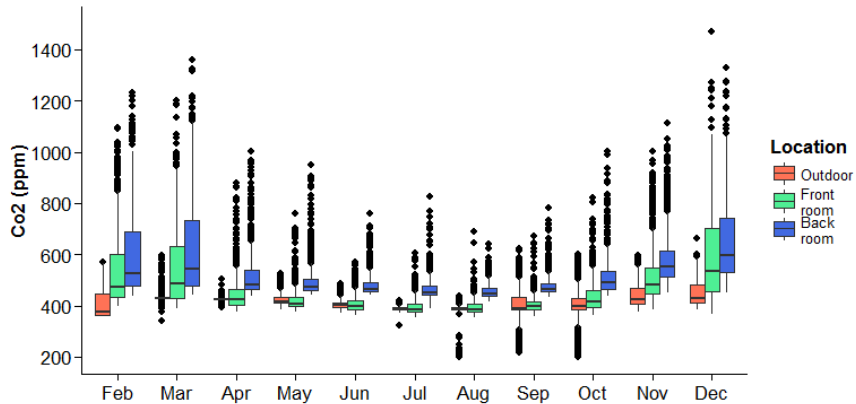

3.5.8.2 Perceived Air Quality (PAQ)

The perceived air quality based on the survey results in this building is remarkably good: it was rated unacceptable less than 1% of the time throughout the year.

Table 3.1 shows the results of single variable regressions of PAQ with the subjective survey responses (in the blue rows: thermal acceptability, thermal sensation, thermal preference, air movement satisfaction, air movement preference) and physical measurements (in the uncolored rows). By far the most important predictor of perceived air quality is air movement satisfaction—it accounts for nearly half of the variation in PAQ. (Figure 3.32 shows this regression on a box plot where the width of the box is related to the number of observations in that bin.) The next most important parameter is thermal acceptability. It is interesting that both these parameters are subjective assessments rather than physical measurements and that their most closely associated physical measurements (number of windows open, number of fans on, thermal sensation) are not correlated with PAQ.

Table 3.1: Linear Regressions with PAQ

	Slope	Intercept	R ²
Air movement satisfaction	0.72	0.51	0.46
Thermal acceptability	0.45	1.16	0.18
Relative humidity	-0.07	5.00	0.07
CO₂ concentration	0.00	3.44	0.07
Air movement preference	-0.54	2.25	0.04
Number of fans on*	0.06	2.64	0.02
Indoor temperature	0.03	1.49	0.01
Outdoor temperature	0.01	2.01	0.00
Number of windows open†	0.03	2.15	0.00
Temperature preference	0.10	2.17	0.00
Thermal sensation	0.04	2.18	0.00

*Only front room results because there are no ceiling fans in the back room.

†Number of windows open in the same room as the occupant whose vote is being considered.

Figure 3.32: PAQ vs. Air Movement Satisfaction

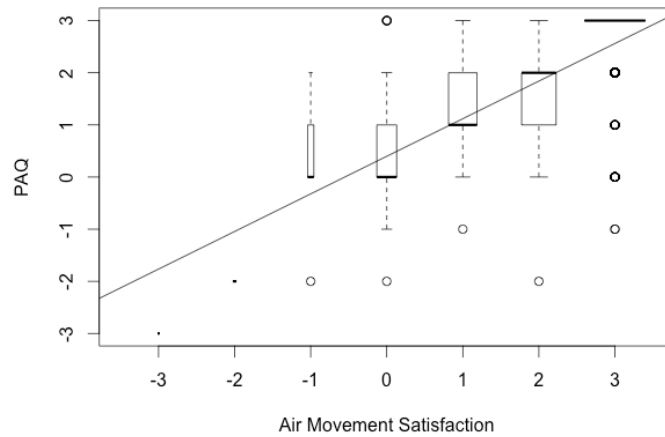

Some studies in climate chambers have found that air quality is perceived to be worse at higher temperatures (Fang *et al.*, 1998), but this result is not seen in the current study or another study carried out by this group (Zhang *et al.*, 2011). Other previous studies have shown that increased air movement increases perceived air quality (Melikov and Kaczmarczyk, 2012). Because occupants can open windows or turn on fans to increase air movement when they feel hot or are dissatisfied with the air quality, it is possible that changes in air movement explain the lack of temperature dependence.

3.5.9 Thermal Sensation and Comfort

3.5.9.1 Thermal Sensation and Modeling

Figure 3.33 shows the relationship between thermal sensation and indoor air temperature. From cold to neutral, thermal sensation increases with temperature as expected. It is interesting that after about 22°C (72°F) the curve flattens out and the rate of increase is less. A probable explanation is that the occupants start opening windows and turning on fans when they become too warm above those temperatures, and the convective cooling from air movement offsets the rise in temperature.

Figure 3.33: Thermal Sensation vs. Indoor Temperature

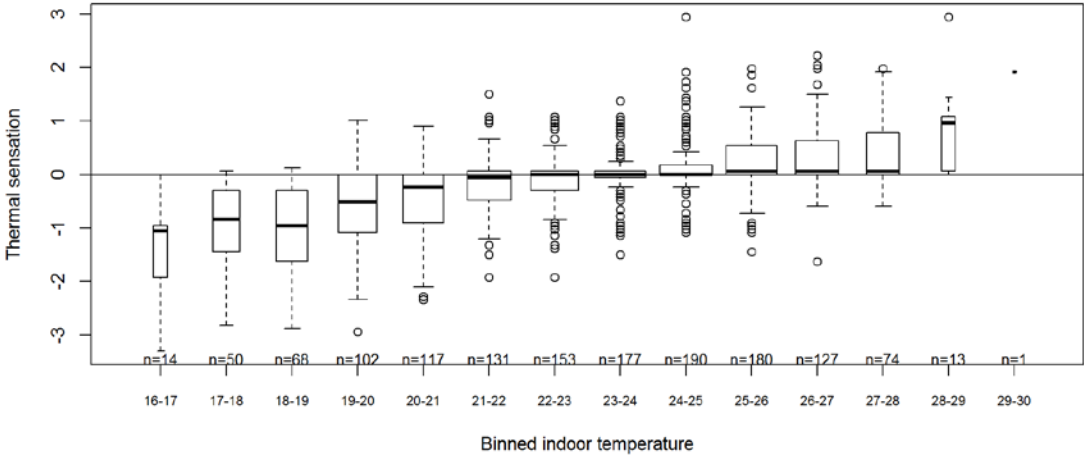
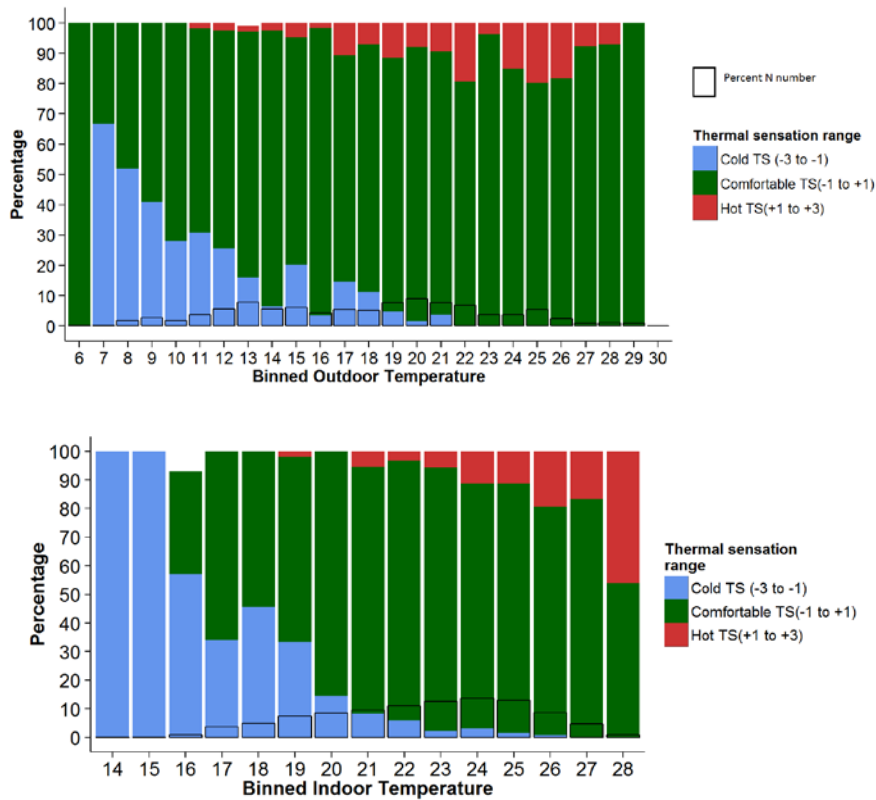

Figure 3.34 shows the percentages of people cold, comfortable and hot for each degree bin of outdoor temperature. The percentage of comfortable occupants increases with temperature. It is interesting to note that some occupants are voting that they are too hot even when the outdoor temperature is less than 18°C (64°F). These occupants have heaters and therefore experience high indoor temperatures by choice, and they indicate that the temperature is acceptable despite voting warm.

Figure 3.34: Percentage of Occupants Satisfied



Because thermal sensation is only one indicator of comfort, it is important to understand the factors that influence it. We conducted pair-wise correlations between thermal sensation, thermal acceptability, indoor temperature, running mean temperature, clothing, air movement satisfaction, noise satisfaction and perceived air quality. Thermal sensation was correlated with indoor temperature ($R = 0.5$), running mean temperature ($R = 0.4$) and clo ($R = -0.32$). Including all three predicted variables did not improve the fit over a single variable fit with indoor temperature. Interestingly, thermal acceptability was correlated with variables not correlated with thermal sensation, i.e. air movement satisfaction ($R = 0.6$), noise satisfaction ($R = 0.42$) and perceived air quality ($R = 0.45$).

Running separate linear regressions between thermal sensation and indoor temperature for the three seasons and the whole year gives such similar results that the neutral indoor temperature varies by less than 2°C (4°F) between the seasons ($23\text{-}24.6^{\circ}\text{C}$) ($73\text{-}76^{\circ}\text{F}$). These differences are well within the standard error of the fits. The adaptive model predicts that the neutral temperature will vary depending on the outdoor conditions, but we saw a very small difference between seasons. Perhaps this is due to the mild climate of Alameda and the variable weather patterns that intersperse hot and cold days during most of the year (Figure 3.6).

Using a thermal sensation range of ± 1 as representing 'comfortable', we get a comfort dead band between 16.6°C and 30°C ($69.9\text{-}86^{\circ}\text{F}$). This wide range agrees with the previously

observations that occupants in naturally ventilated buildings with adaptive opportunities accept wider deviations from the neutral temperature. In our case the deviation is $\pm 6.7^{\circ}\text{C}$ (10°F). This is twice as wide as the bandwidth recommended by ASHRAE Standard 55 for HVAC buildings. Similar broad deadbands have been found in naturally ventilated buildings (Indraganti, 2010; Indraganti and Rao, 2010); broad deadbands appear to be one of the key benefits of naturally ventilated buildings.

3.5.9.2 Metrics of Thermal Comfort

Defining the comfort zone remains a current issue in standards committees such as ASHRAE SSPC 55. There is great intra- and interpersonal variability in occupants' neutral temperatures and in the ranges of temperature above and below these neutrals that occupants find acceptable. The ASHRAE Standard 55 comfort zone is based on prediction of a population's mean thermal sensation or predicted mean vote (PMV) and the predicted percent dissatisfied (PPD) associated with PMV deviations from neutral. The Standard recommends a PMV range of ± 0.5 . This corresponds to 10% dissatisfied (90% satisfied) by the PPD curve, but hypothesized local thermal discomfort effects reduce the satisfaction to 80%, which is the actual satisfaction value found in most comfort field studies. The adaptive comfort zone for NV buildings is also set to provide 80% satisfied, but it encompasses a wider range of temperatures. The adaptive zone is based on field study data, and dispenses with both the PMV model and with the local thermal discomfort hypothesis (de Dear and Brager, 1998).

Field surveys have increasingly added a question about thermal acceptability to supplement the thermal sensation question. The thermal acceptability metric can be used directly to determine the range of thermal sensation values that provide the most relevant aspect of 'satisfaction' for building occupants. Figure 3.35 shows the percentage of people satisfied in a particular indoor temperature bin, as defined by three thermal sensation ranges: ± 0.85 , ± 1 , and ± 1.5 . The threshold is defined as the temperature at which 80% occupants are satisfied. The ± 1.5 range matches most closely with the thermal acceptability threshold.

This study's results can be compared with the thresholds for the ASHRAE 884 database (Zhang *et al.*, 2011). The summer threshold (temperature at which 80% occupants vote "acceptable") for the Alameda building is $21\text{-}27^{\circ}\text{C}$ ($70\text{-}80^{\circ}\text{F}$) while for the ASHRAE database (for NV buildings) is $22\text{-}30^{\circ}\text{C}$ ($70\text{-}86^{\circ}\text{F}$). The winter threshold range for the Alameda building is $18\text{-}24^{\circ}\text{C}$ ($64\text{-}75^{\circ}\text{F}$) while it is $19\text{-}27^{\circ}\text{C}$ ($66\text{-}81^{\circ}\text{F}$) for the ASHRAE database. Perhaps the lower hot season threshold ranges from the current study are due to the mild climate in Alameda, in which the occupants are less able to adapt to hot weather than the other respondents in the ASHRAE database.

Figure 3.35: Thermal Sensation and Thermal Acceptability

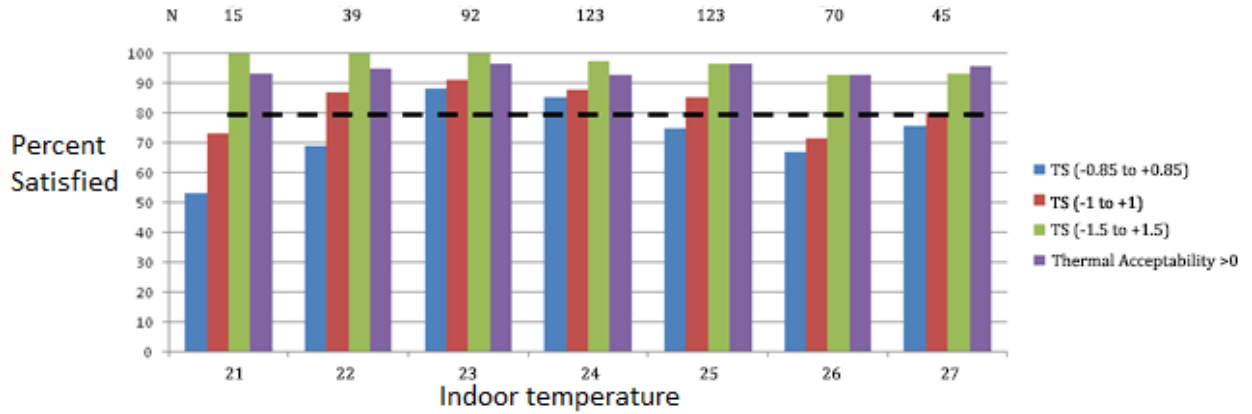

a. Summer (June-October)

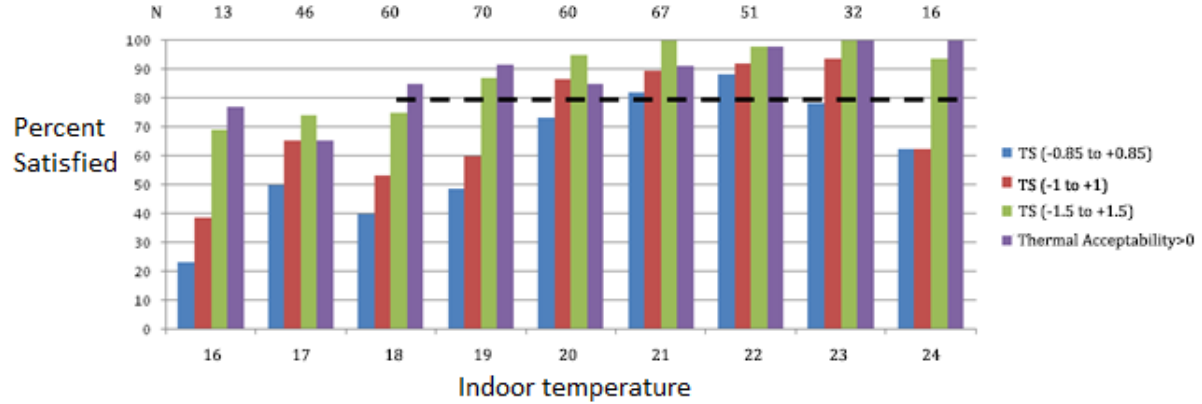

b. Winter (December-February)

Only bins with at least 5 votes are shown.

Figure 3.36 calculates the percentage of people voting “unacceptable” for each thermal sensation range. The points show the raw data, and the smoothed curve is the result of probit analysis. Compared to the standard PMV-PPD curve, the one based on this field study data is broader and indicates that the 20% dissatisfaction threshold does not occur until thermal sensations of ± 2 .

Figure 3.36: Thermal Sensation and Percent of People Dissatisfied

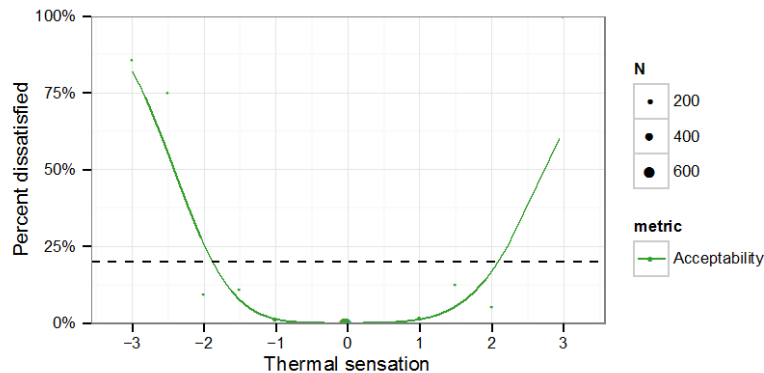

3.5.9.3 Comparison with the Adaptive Model

Figure 3.37 shows the thermal sensation votes plotted on an indoor temperature vs. outdoor running mean temperature graph. The parallel lines represent the 90% (dotted) and 80% (solid) acceptable ranges defined by the adaptive model in ASHRAE 55. In the Standard, thermal sensation votes between -1 and +1 (slightly cool to slightly warm) are considered satisfied. The distribution of green points shows that a majority of occupants do not feel warm/hot or cool/cold even at temperatures lying outside the comfort zone defined by the adaptive standard. Hot and cold discomfort votes are distributed sparsely at the extreme end of the outdoor running mean temperature scale. Also many votes were cast at outdoor temperatures of less than 10°C (50°F), which is not covered by the adaptive standard.

Figure 3.37: Adaptive Comfort Overlay

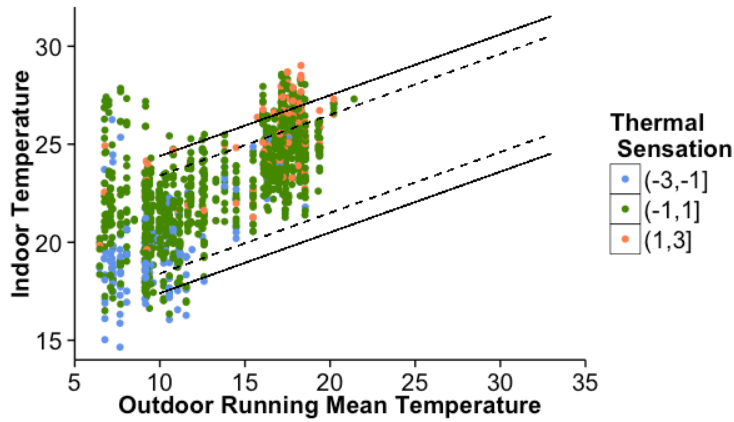
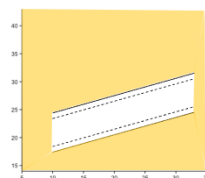
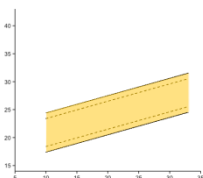
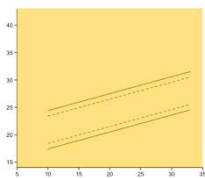
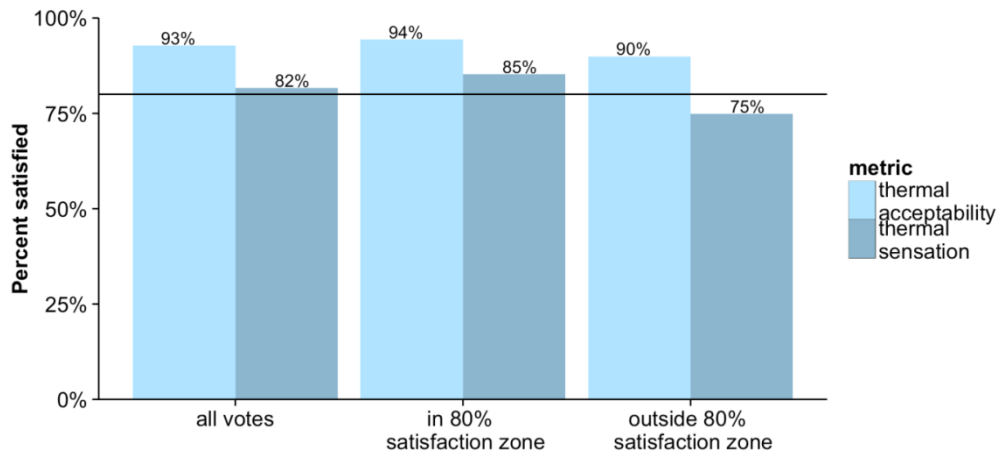

Figure 3.38 examines thermal satisfaction inside and outside of the 80% satisfaction zone of the ASHRAE 55 adaptive standard using acceptability and sensation ± 1 . At least 90% of the time, the occupants voted that they were comfortable regardless of where they were in the ASHRAE comfort zone. Using thermal sensation as the comfort metric shows more difference between the regions, though: the occupants are clearly closer to neutral temperature in the 80% satisfaction zone than outside it.

Figure 3.38: Thermal Satisfaction in ASHRAE 55 Adaptive Zones



A more detailed way to compare the survey responses with the adaptive comfort range is to bin the votes based on both the outdoor running mean temperature and the indoor temperature. Figure 3.39 shows the percentage of satisfied votes, as defined by acceptability, for each bin. The number of votes in that bin is displayed on top of each box.

Figure 3.40 only shows those bins with more than 5 votes and compares three metrics of satisfaction with the adaptive model. For the thermal sensation chart (b), a star is overlaid on uncomfortable bins with more cool votes, and circles for bins with more warm votes. Comparing these charts reveals that thermal acceptability is the least stringent metric of satisfaction and that temperature preference is the strictest. Of the 45 bins that fall within the 80% satisfaction zone in Figure 3.40, 3 (1%) have less than 80% satisfaction based on acceptability, 14 (31%) based on thermal sensation between -1 and 1, and 20 (44%) based on temperature preference.

Figure 3.39: Thermal Acceptability and Binned Temperatures

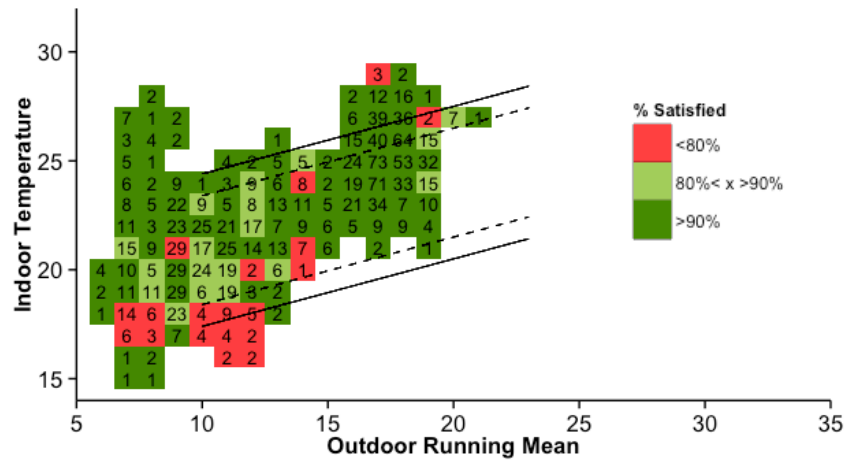
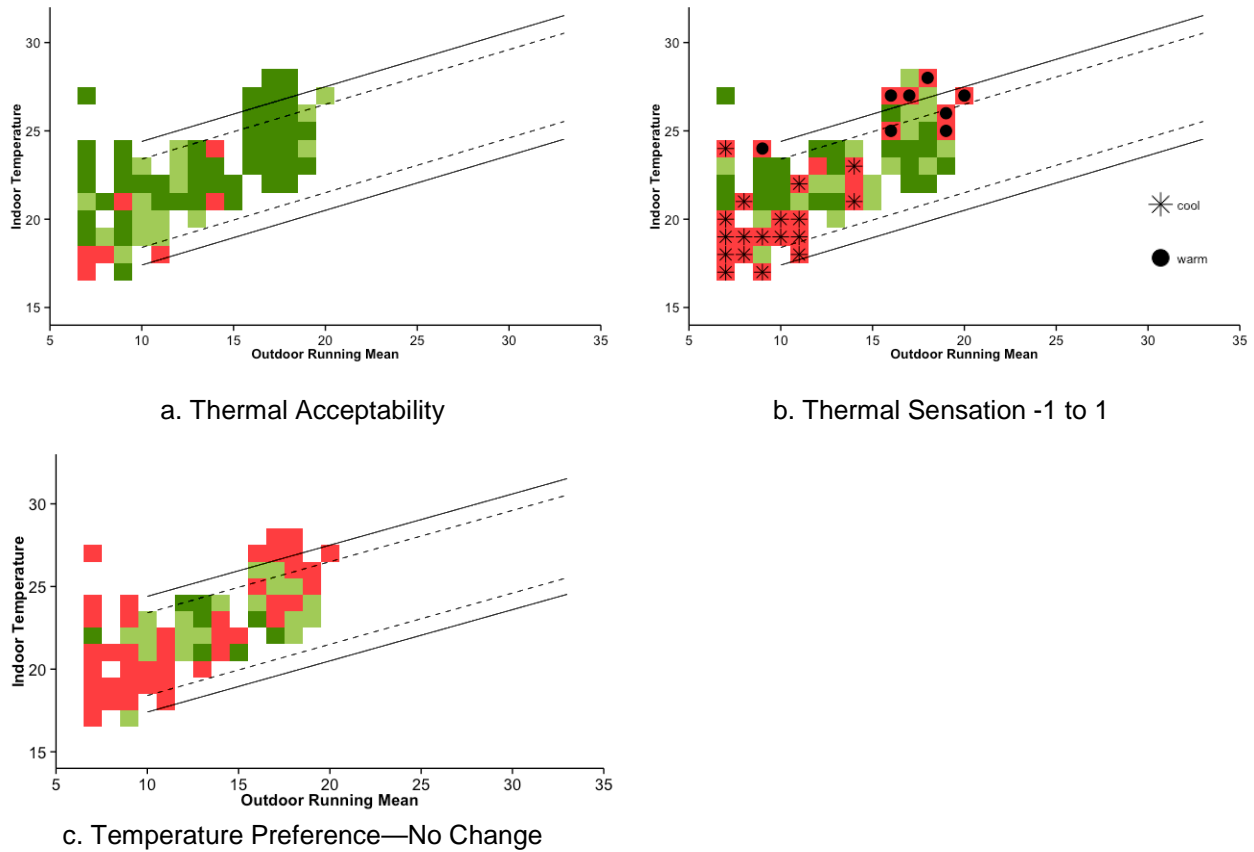

Figure 3.40: Satisfaction and the Adaptive Comfort Zone



3.5.9.4 Sensitivity-Based Comfort Model

The current ASHRAE 55 adaptive comfort standard was derived from a dataset of 21,000 observations in 160 buildings on 4 continents in diverse climatic zones (de Dear and Brager, 1998). First the neutral temperature for each building during each season was calculated based on a linear regression between operative temperature and mean thermal sensation. These building-specific neutral temperatures were then plotted with their respective mean monthly outdoor temperature. A second regression was performed between the neutral temperatures and mean monthly temperatures of the buildings to derive a comfort equation that relates neutral temperature to mean monthly temperature.

This second regression equation became the neutral temperature line (orange) in the ASHRAE 55 adaptive standard (Figure 3.41). The 80% and 90% satisfaction lines are calculated by inserting thermal sensation values of ± 0.85 (80% satisfied) and ± 0.5 (90% satisfied) into the regression equation. The values of ± 0.85 and ± 0.5 are taken from Fanger's PMV/PPD curve.

Figure 3.41: ASHRAE 55 Adaptive Comfort Chart

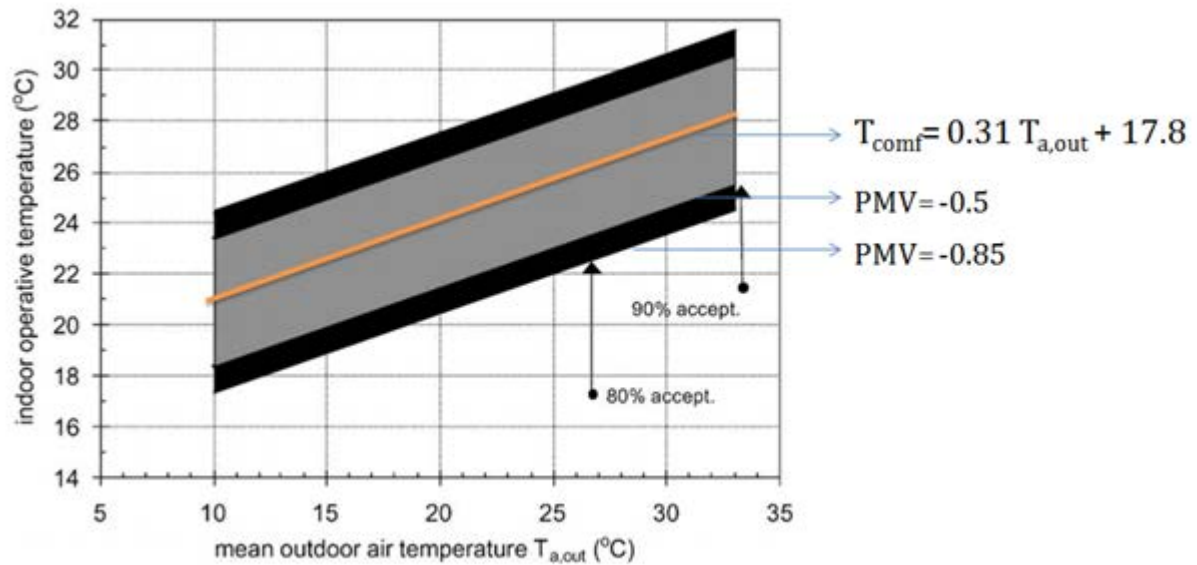

This method has been very successful in changing the comfort requirements in the standards. It is easy to use by design professionals and allows a quick understanding of comfort in a specific climate. Nevertheless there are some drawbacks to this method:

- Averaging the votes for each building before regression leads to a loss of information about individual preferences (Humphreys *et al.*, 2013).
- The 80% and 90% satisfaction lines are derived based on the PMV/PPD relationship, which was developed for air conditioned buildings.
- The current modeling assumes that adaptation occurs linearly with temperature, but the rate of adaptation might be different for different temperature bands.
- The current adaptive comfort zone does not allow any flexibility to incorporate location-specific comfort expectations. For example in locations with high diurnal swings occupants might be expected to accept a broader temperature band.
- The current model does not apply to outdoor running mean temperatures below 10 or above 33°C (50-91°F) and does not offer any guidance about what indoor temperatures may be comfortable in these zones.

We developed a sensitivity-based method inspired by Humphreys *et al.*, (2013) that can address some of these limitations. This method divides the indoor temperature range into different bands with the idea that people are more sensitive to changes in temperature when they are already hot or cold than when they are close to neutral. In this case, three temperature bands are used ($T_{in} < 24$, $24 < T_{in} < 27$, $T_{in} > 27$). For each band, the sensitivity or change in thermal sensation per change in degree of indoor temperature is calculated. The sensitivity is the largest in the cool

zone (less than 24°C (75°F)) and almost zero in the neutral zone (between 24°C and 27°C (75-81°F)) (Figure 3.42).

For each one degree bin of outdoor running mean temperature we calculated an average thermal sensation. The neutral temperature for each of these bins was determined based on the sensitivity value of the indoor temperature band it is in. For example, a data point with a thermal sensation of 0.5 at an indoor temperature 24°C (75°F) would give a neutral temperature of 21.2°C ($24 - 0.5/0.18$) (70.2°F). The 80% satisfaction limits were calculated similarly based on thermal sensation of ± 1 (Figure 3.43).

Figure 3.44 compares the sensitivity-based comfort zone calculated from this field study's data to the ASHRAE 55 zone. The sensitivity-based version has wider limits and extends into lower outdoor running mean temperatures.

Figure 3.42: Thermal Sensitivities

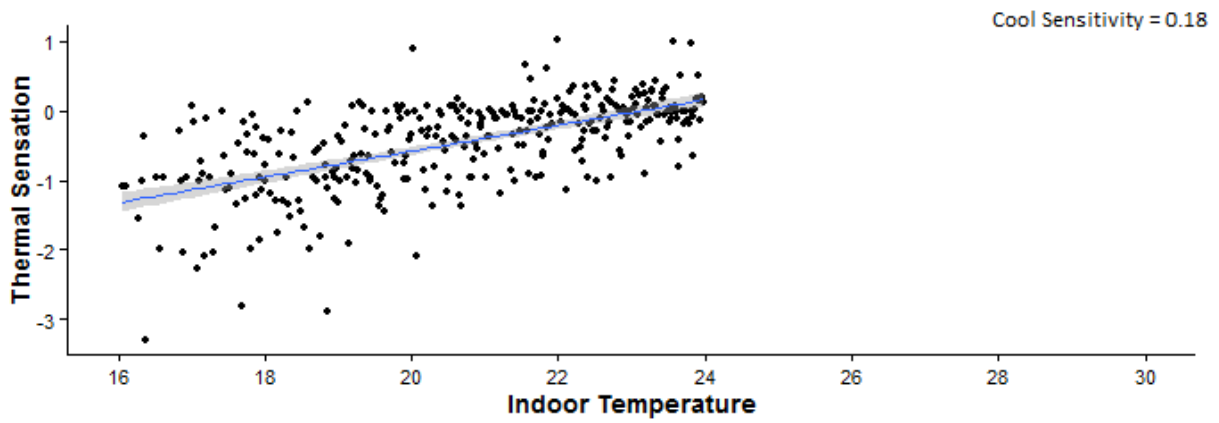

a. Cool Zone (<24°C)

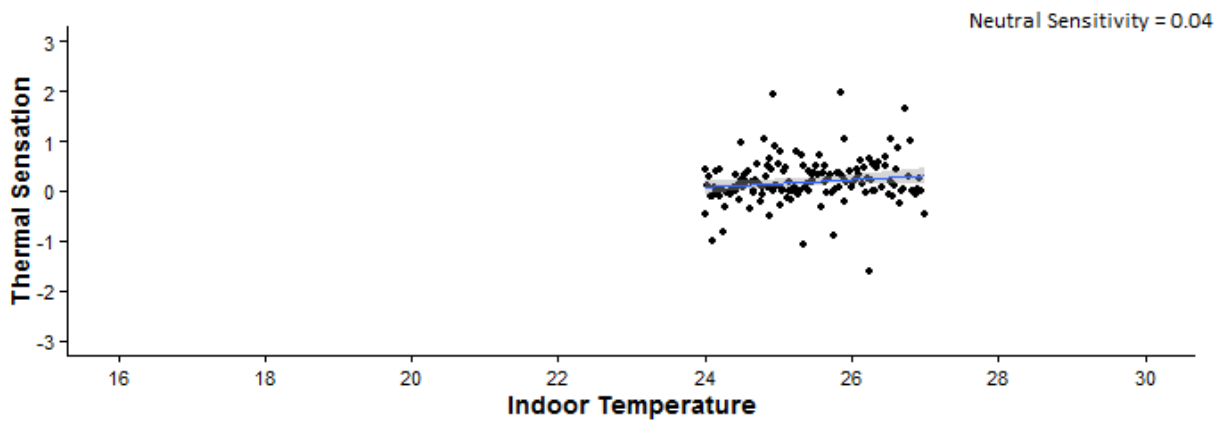

b. Neutral Zone (24°C > T_{in} > 27°C)

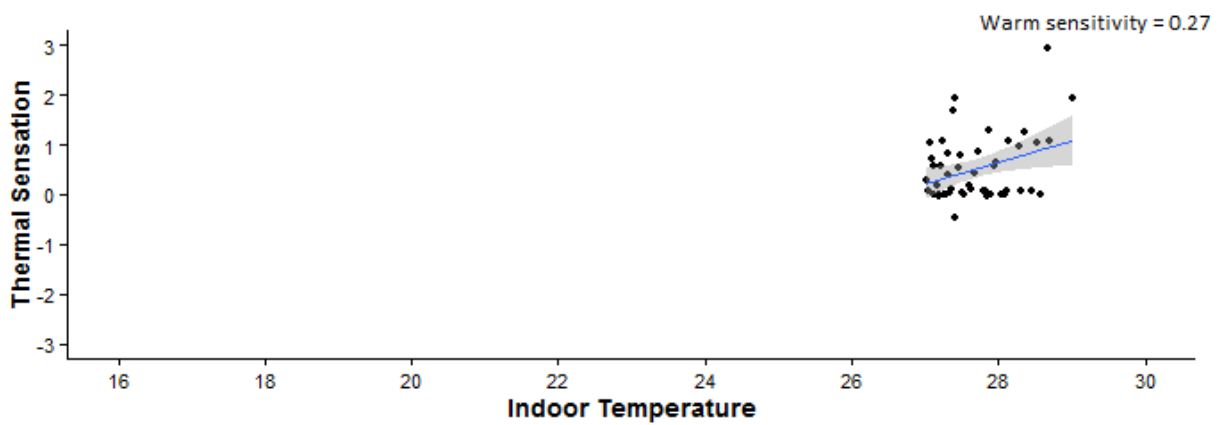

c. Warm Zone (>27°C)

Figure 3.43: Sensitivity-Based Adaptive Chart

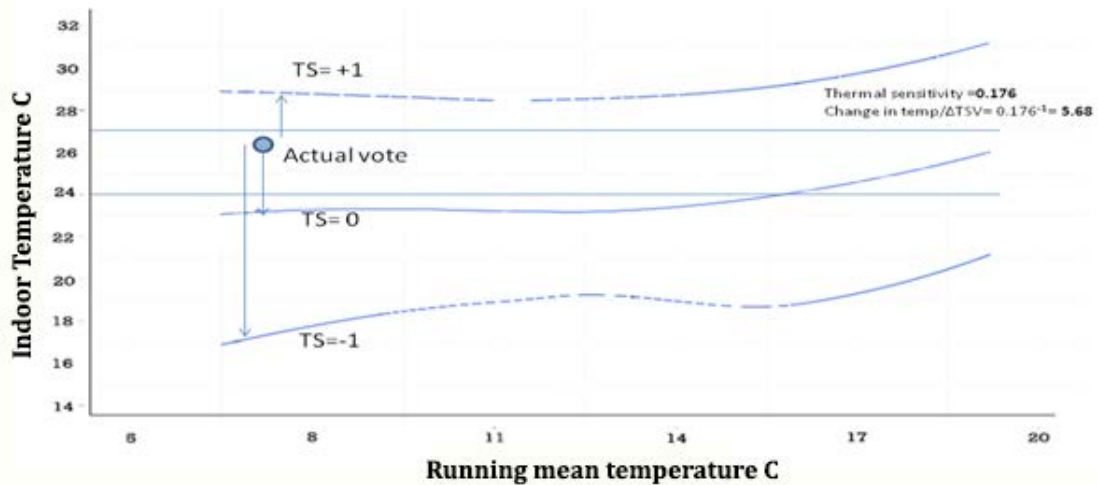
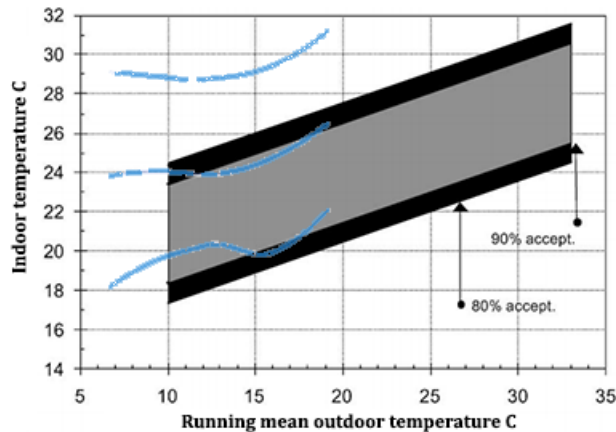

Figure 3.44: Sensitivity-Based vs. ASHRAE Adaptive Comfort Zones



3.5.10 Background Surveys in Other Offices with Operable Windows and Ceiling Fans

The thermal comfort of occupants in two mixed-mode office buildings with operable windows and ceiling fans was also investigated using the Center for the Built Environment (CBE) general survey. The survey asks about occupants' satisfaction in nine areas of indoor environmental quality including thermal comfort, light, indoor air quality, acoustics, and noise. Since it has been administered for the last 15 years, a database containing 65,000 data sets from over 600 buildings has been built up. This database provides a benchmark for comparing the survey results from these two buildings.

The two buildings are the DPR building Phoenix and the University of Washington Biosciences Lab. We chose these buildings because they have ceiling fans, which is very uncommon. While

they are not located in California, the results are applicable in California climates because as mixed-mode buildings, they are not entirely dependent on outdoor conditions. The indoor temperature ranges are similar to those of mixed-mode buildings in California.

3.5.10.1 DPR

DPR is a net zero energy building in Phoenix, AZ. It was certified from the International Living Future Institute (ILFI) through its Living Building Challenge. The building has ceiling fans, 87 operable windows, an 87 foot long zinc-clad solar chimney and a 79 kW-dc rated photovoltaic array (Figure 3.45). It is operated as a mixed-mode building with the mechanical cooling switching on at temperatures above 27°C (81°F). Modules about windows and fans were added to the general survey to address the specific features of this building. 37 out of 45 employees answered the survey (82% response rate).

Figure 3.45: DPR Net Zero Building, Phoenix



Source: DPR Website

Overall Satisfaction

The overall satisfaction with the building is high: 97% of occupants were satisfied. This positions the building in the top 5% of the entire database. In addition, 92% of the occupants were satisfied with the fact that the building has natural ventilation features.

Temperature Satisfaction

The mean score for temperature satisfaction is 0.97 on a scale that goes from -3 to 3. This is much higher than the entire database (-0.13), LEED buildings (0.42), and mixed-mode buildings (0.62). In fact it is ranked in the 91st percentile of the entire database (Figure 3.46). This may be surprising since the temperature setpoint is at 28°C (82°F), but clearly the operable windows and ceiling fans allow people to be comfortable.

Figure 3.46: Temperature Satisfaction Percentile Ranking, DPR

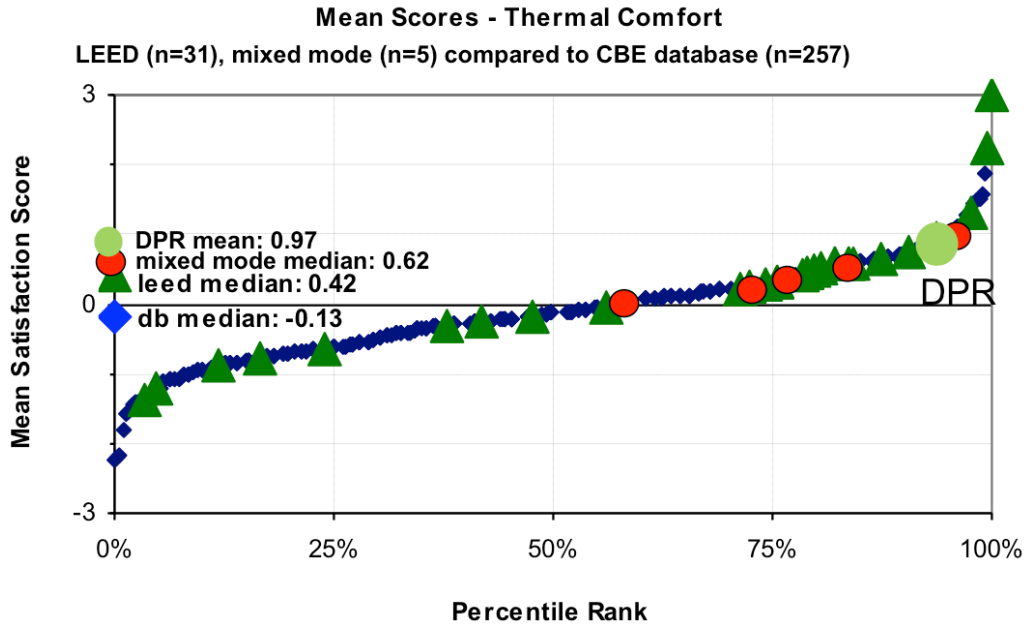
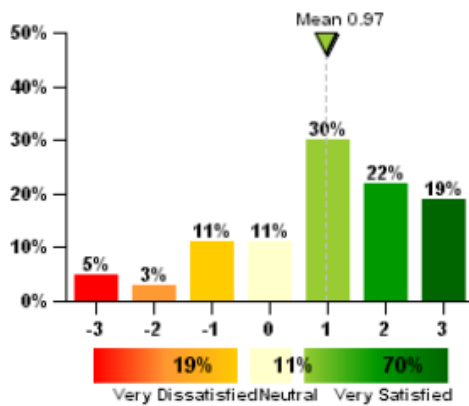

Figure 3.47 and Figure 3.48 show the distribution of satisfaction votes. Including the neutral votes as satisfied, 81% of the occupants were satisfied with the temperature and 72% were satisfied with the ability to control temperature. 75% occupants felt that thermal comfort in their workspace enhanced their ability to get their job done.

Figure 3.47: Satisfaction with Temperature, DPR

Figure 3.48: Satisfaction Temperature Control, DPR

How satisfied are you with the temperature in your workspace?



N=37

How satisfied are you with your ability to control the temperature in your workspace?

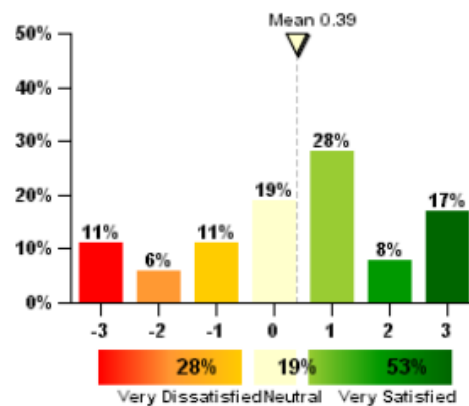

N=36

Air Movement

75% of occupants were satisfied with the amount of air movement in the workplace and 67% felt that it enhanced their ability to get their job done.

Ceiling Fans

83% of occupants were satisfied with ceiling fans in their workspaces. 70% of occupants indicated that fans provide relief from being too warm and that the air movement made them comfortable. The most frequent reasons that occupants were dissatisfied with fans were that air movement might be disruptive (papers blown about), and that airspeed might be too high for comfort (Figure 3.49).

Windows

97% of occupants were satisfied with the operable windows. 78% felt that the windows reduced stuffiness and provided connection to the outdoors. 53% felt that windows provided relief from being too warm and the air movement made them comfortable. The main reason for being dissatisfied with windows was that they let in too much dust and odor. Other people were dissatisfied because they do not have operable windows nearby.

Air Quality

89% of occupants were satisfied with the air quality. This puts the DPR building in the 79th percentile of the database. 87% of occupants feel that the indoor air quality in their workspaces enhanced their work productivity.

Figure 3.49: Reasons for Dissatisfaction with Fans, DPR

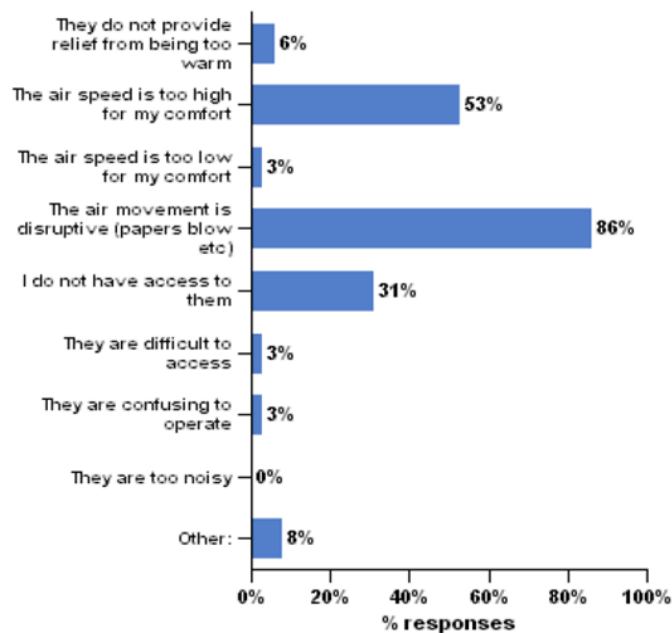

Acoustics

80% of the occupants were satisfied with the noise level in their workspace, which ranks this building in the 85th percentile of the entire database. 73% occupants were satisfied with speech privacy. Among those who were dissatisfied, speech privacy, people talking in neighboring areas, people overhearing their private conversation, and excessive echoing of voices were the most common complaints. Fans were not listed as a possible reason for dissatisfaction with acoustics in the survey. The closest choices are noise from “office equipment,” from “mechanical heating and cooling equipment,” and “other”. Because these areas did not cause much dissatisfaction, the fans were probably not causing much noise.

Figure 3.50: Reasons for Dissatisfaction with Acoustics, DPR

You have said you are dissatisfied with the acoustics in your workspace. Which of the following contribute to this problem? (check all that apply)



3.5.10.2 *Molecular Engineering and Sciences Building, University of Washington*

The Molecular Engineering and Sciences Building at the University of Washington is a mixed-mode building with ceiling fans (Figure 3.51).

Figure 3.51: University of Washington Building and Natural Ventilation Strategies

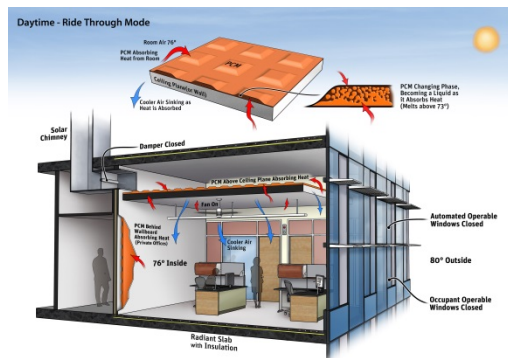
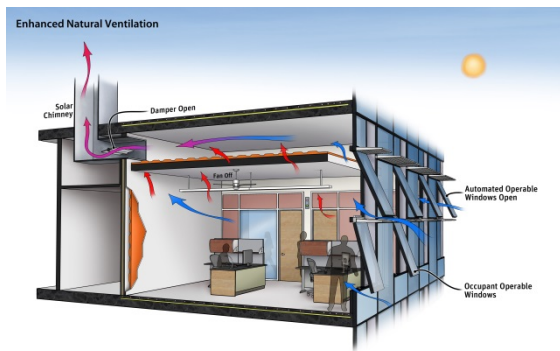

Architecture by ZGF and HVAC system by AEI

Overall Satisfaction

92% of the occupants were satisfied with the building overall. This positions it in the top 8% of buildings in the CBE database.

Temperature Satisfaction

The mean score for temperature satisfaction is 0.38 on a scale that goes from -3 to 3, which is higher than the database average (-0.13), but lower than the LEED buildings average (0.42), mixed-mode buildings (0.62), and DPR (0.97). It is ranked in the 70th percentile of the entire database (Figure 3.52).

Figure 3.52: Temperature Satisfaction Percentile Ranking, UW

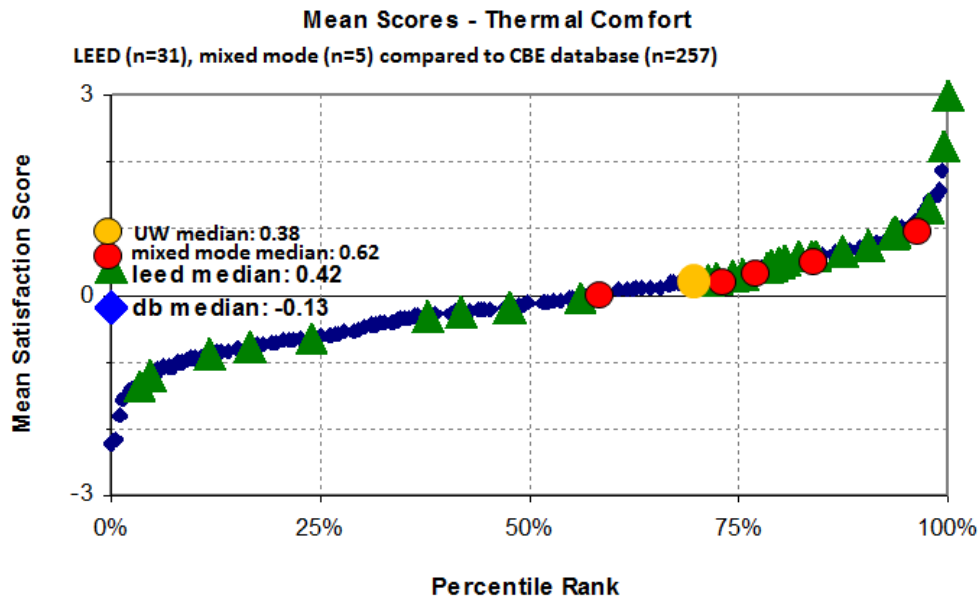

This mixed-mode building suffers from a problem that is now very common in mechanically cooled buildings—it is being overcooled by the mechanical system. In the survey results, overcooling is seen as the primary reason for temperature dissatisfaction in both summer and winter. 62% and 88% of people who were dissatisfied with the temperature said that the workspace was often too cold, in warm/hot and cool/cold weather respectively (Figure 3.53). One person said that the only time they were warm was after working out, and that otherwise they wear a winter coat and sometimes a winter hat indoors. Only 6% in warm/hot weather and 0% in the cool/cold weather said that the workspace is often too warm. The temperature set points are 20–22°C (68–72°F) for offices and 20–21°C (68–70°F) for the laboratories year round. From the survey results, these temperatures are too low comfort, and they are also likely to be too low to take advantage of the installed ceiling fans.

Figure 3.53: Reasons for Temperature Dissatisfaction, UW

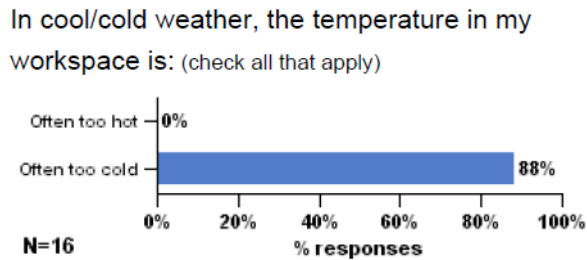
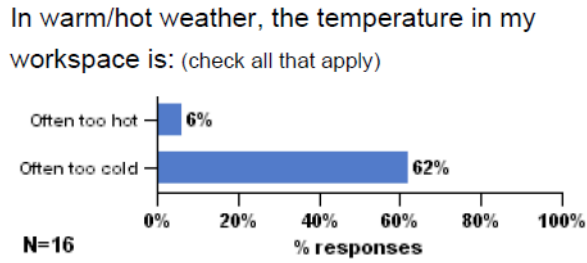

About twice as many people are satisfied with the temperature than are satisfied with their ability to control temperature. This is perhaps not surprising given that being too cold is overwhelmingly the problem, and the types of control available to them (window blinds/shades and ceiling fans) do not help them become warmer. Also, almost half of the respondents don't have any control of their indoor environment (Figure 3.56).

Figure 3.54: Satisfaction With Temperature, UW



Figure 3.55: Satisfaction Temperature Control, UW

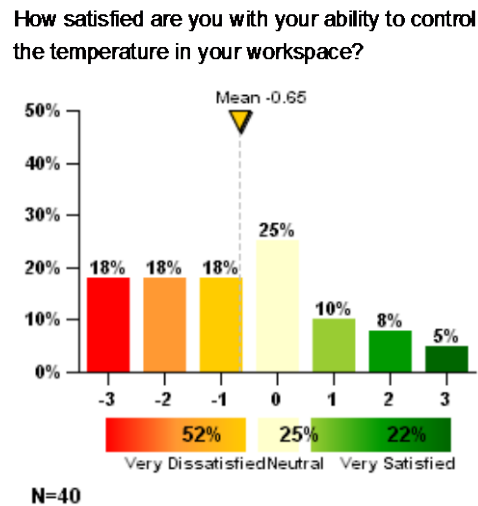
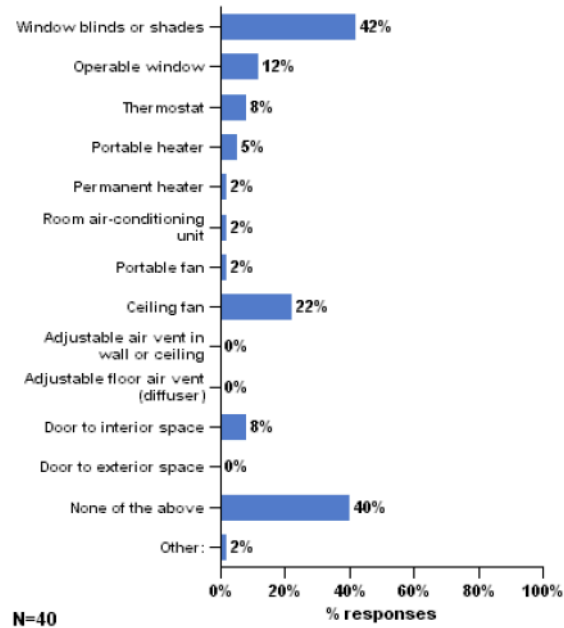

Figure 3.56: Access to Environmental Controls, UW

Which of the following do you personally adjust or control in your workspace? (check all that apply)



Air Movement

93% of occupants were satisfied with the amount of air movement in the workplace and 93% felt that it enhanced their ability to get their job done.

From the survey responses from DPR and UW, it is seen that UW is being operated at lower ambient air temperature than DPR, and the ceiling fans are not operated at as high as the velocity in DPR. It will be valuable to take temperature and airspeed measurements in the two buildings in the future.

Ceiling Fans

100% of occupants were satisfied with ceiling fans in their workspaces. When asked reasons that someone might be dissatisfied with ceiling fans, the most frequent reason was that they do not have access to ceiling fans. Only 18% said that the air movement might be too disruptive (paper blow etc.). 5% (two people) said that the fans are visually distracting (Figure 3.57).

Figure 3.57: Reasons for Dissatisfaction with Ceiling Fans, UW

Below is a list of reasons someone might be dissatisfied with ceiling fans. Which ones do you agree with? (check all that apply)

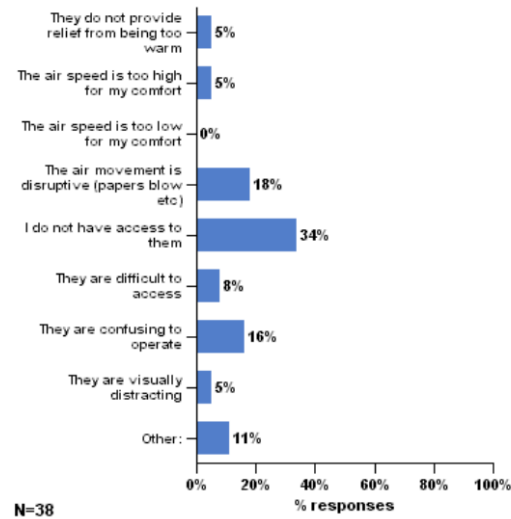

Windows

Only 6% of occupants (2 people) were dissatisfied with the operable windows. 91% use them daily or weekly in the warm/hot season, and everyone is confident that opening and closing them will have the desired effect. The most common reasons for opening windows are to increase air movement (75%), let in fresh air (75%), and feel cooler (50%). Like fans, the main reason for being dissatisfied with windows is not having access to one.

Air Quality

The mean rating of air quality was 1.28, which puts this building in the 89th percentile of the CBE database.

Acoustics

The levels of satisfaction with acoustics were very similar to those with temperature: 51% of people were satisfied, putting the building in the 69th percentile. The major reasons for dissatisfaction with acoustics were all related to sound privacy (i.e. either overhearing or being overheard by other people) (Figure 3.58). In the open-ended comments, multiple people said that they dislike the open plan design and would prefer cubicles, mostly because of these acoustical problems. Outdoor traffic noise did not cause any acoustical dissatisfaction.

Figure 3.58: Reasons for Dissatisfaction With Acoustics, UW

You have said you are dissatisfied with the acoustics in your workspace. Which of the following contribute to this problem? (check all that apply)

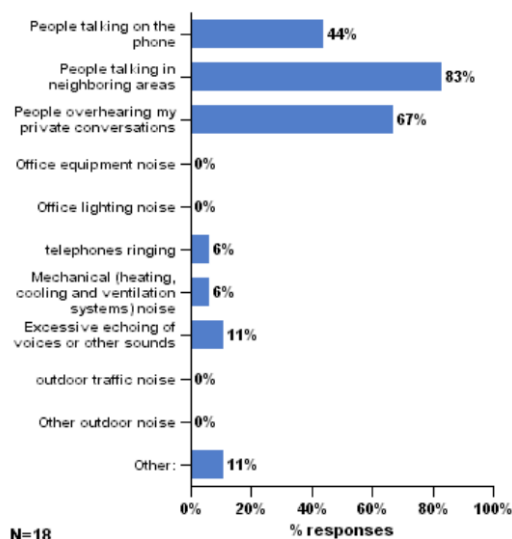

3.6 Conclusion and Future Work

In the Alameda building, people use windows and fans very effectively to achieve thermal comfort. Windows are used most often: they are open 67% of the time during summer work hours. Fans are only used 21% of summer work hours, and for 75% of this time, the windows are also open. Windows also start being opened at lower indoor air temperatures: around 23°C (73°F) compared with 26°C (79°F).

The window opening/closing patterns are heavily driven by occupancy. In the warm season, people are likely to open their windows when they arrive and close them when they leave at the end of the day. Because of this, it makes sense that window opening is more closely related to outdoor temperature than indoor. Fans, on the other hand, are not routinely turned on when occupants arrive, and their use is more closely related to indoor temperature.

The perceived air quality (PAQ) in this building is very good: it was rated unacceptable in only 13 out of 1,408 votes, which is less than 1%. The statistical analysis shows that the most important predictor of perceived air quality is air movement satisfaction.

The occupants of this building are comfortable over a broad range of temperatures, from 16-30°C (61-86°F). Although there is a noticeable difference in satisfaction as defined by thermal sensation inside and outside the ASHRAE 55 80% satisfaction zone, there are still many regions outside the 80% satisfaction zone with high satisfaction.

Comparing acceptability and sensation votes reveals that a sensation range of ± 1.5 most closely matches the 20% dissatisfied limit. This is substantially wider than the ± 0.85 range defined by the PMV-PPD curve.

A “sensitivity-based” adaptive model is developed based on the current study data. Unlike the adaptive model in ASHRAE 55, this model is developed for a specific climate based on the idea that how much a change in temperature affects comfort depends on the temperature range. The sensitivity-based model counts for different types of climates when using climate-based regression coefficients.

The thermal comfort ranking of the DPR mixed mode buildings is very high: 92nd percentile, 83% and 97% of occupants are satisfied with the ceiling fans and operable windows in their workspaces. These zero and low energy opportunities for adaptive control allow high thermal satisfaction even at a temperature setpoint of 28°C (82°F). The thermal comfort ranking for the UW building is not as high, 70th percentile. Part of the dissatisfaction is due to the overcooling of the building: the building was maintained at 20-22°C (68-72°F) year-round. This type of operation is counterproductive to the mixed-mode concept of the building, negatively impacting both its energy efficiency and comfort. It is very likely that if this building were allowed to operate closer to the adaptive model neutral temperature, it would have very successful satisfaction rankings.

The detailed study of a single NV building used innovative techniques for examining adaptive comfort. A profitable direction for future work would be to apply these techniques to larger datasets, such as the ASHRAE database. For example, it would be interesting to divide the buildings in the database by climate, creating a sensitivity-based adaptive model for each climate, and then comparing the models. Developing a window-opening model is another area for future study. The goal would be to identify physical parameters that best estimate the opening/closing of a window, allowing improvement to the operation algorithms and schedules in energy simulation software like EnergyPlus. Another interesting direction for the future work would be to compare the effectiveness of using fans and windows in a purely naturally ventilated building (like the one in this study) to their use in a naturally ventilated zone of a mixed-mode building. Such evidence is needed for the important decision whether the ASHRAE adaptive comfort chart may be applied beyond NV buildings alone, but rather to occupant-controlled NV zones in mixed-mode buildings.

Chapter 3 Appendix: Right Now Survey

Full details of the survey are available on the Center for the Built Environment website at <http://www.cbe.berkeley.edu/research/survey.htm>.

1. TEMPERATURE

Right now, how acceptable is the temperature at your workplace?

Very acceptable    Not at all acceptable

You feel (Please mark on the scale)?

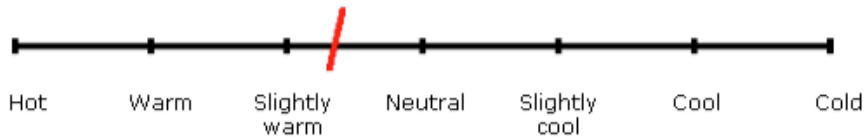

You would prefer to be:

Cooler No change Warmer

2. AIR MOVEMENT

Right now, how acceptable is the air movement at your workplace?

Very acceptable    Not at all acceptable

You would prefer:

More air movement No change Less air movement

3. AIR QUALITY

Right now, how acceptable is the air quality at your workplace?

Very acceptable    Not at all acceptable

Continue >>

4. NOISE LEVEL

Right now, how acceptable is the noise level at your workplace?

Very acceptable    Not at all acceptable



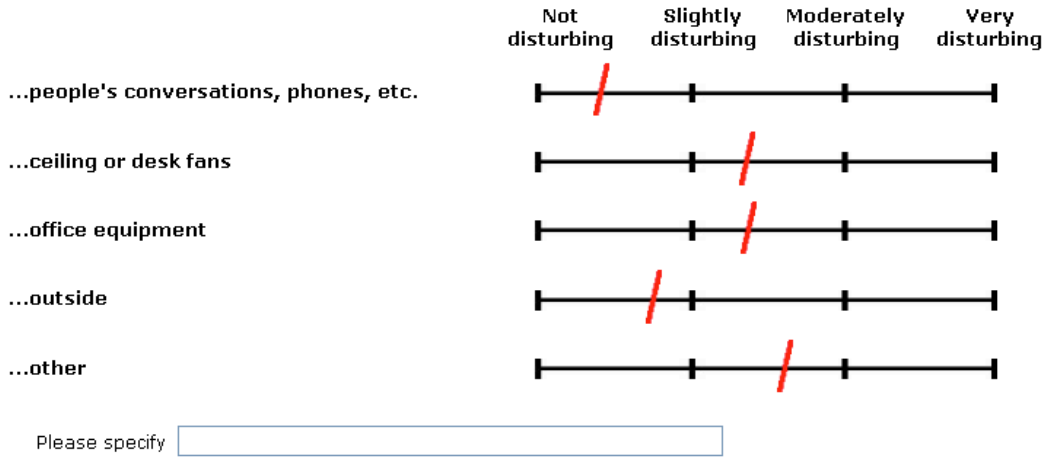



Please rate the noise from.....



If you have additional comments, click [here](#)

5. CLOTHING

Please mark in the list below all the garments you are wearing now.

- | | | | |
|--|---|--|---|
| <input type="checkbox"/> Short-sleeved shirt or blouse |  | <input type="checkbox"/> Sweater or jacket |  |
| <input type="checkbox"/> Long-sleeved shirt or blouse |  | <input type="checkbox"/> Tie |  |
| <input type="checkbox"/> Shorts |  | <input type="checkbox"/> Trousers, pants |  |
| <input type="checkbox"/> Skirt or dress |  | | |
| <input type="checkbox"/> Sandals or open-toed shoes |  | <input type="checkbox"/> Shoes, sneakers, or boots |  |

Continue >>

CHAPTER 4: Ozone and Particle Exposures in Naturally Ventilated Offices

4.1 Background

This work focuses on analyzing the health-related risks and benefits of retrofitting California offices to use natural ventilation. These costs and benefits are quantified both in terms of the number of cases of specific health outcomes and the monetary value to society. Quantifying the monetary value of these costs and benefits aids in weighing tradeoffs and analyzing the significance of a building's ventilation choices.

Relative to conventional practice, natural ventilation in offices can significantly reduce building energy consumption (Borgeson and Brager, 2011). Natural ventilation also changes indoor environmental conditions. Prevalence rates of sick building syndrome symptoms and exposures to outdoor air pollutants differ between naturally ventilated and conventional air conditioned buildings.

Sick building syndrome symptoms are acute health symptoms associated with occupancy in a building and not clearly attributable to a specific disease. Common symptoms include headache and irritation of eye, nose, or throat. A substantial body of research indicates that occupants of naturally ventilated offices have fewer sick building syndrome symptoms than occupants of air-conditioned offices (Seppänen and Fisk, 2002). Sick building syndrome symptoms are 30 to 200 percent more frequent in air-conditioned buildings. Prior efforts to quantify the costs of sick building syndrome symptoms have focused narrowly on medical costs to treat symptoms (US EPA, 2007). Responses from a survey of workers in 100 U.S. offices indicate an increase in self-reported illness absences and reduced productivity as a result of sick building syndrome symptoms (Brightman, 2005). However, weaknesses in survey questions limit the validity of these results. At least one additional study has found an increase in the number of sickness absences and hospital visits for female occupants of air-conditioned buildings compared to occupants of naturally ventilated offices (Preziosi *et al.*, 2004). Neither of these studies is sufficient to fully quantify potential secondary costs associated with sick building syndrome symptoms.

Applying natural ventilation strategies in buildings is expected to change occupants' exposures to outdoor air contaminants compared to the exposures to these pollutants for occupants of air-conditioned buildings. Of particular importance are effects of natural ventilation on exposures to two outdoor pollutants: particulate matter (PM) and ozone. Both are known to have significant health impacts (Pope *et al.*, 2002; Samet *et al.*, 2000; Weschler, 2006). A recent analysis estimated that, by 2020, the Clean Air Act (US EPA, 2011) will have prevented more than 230,000 early deaths with an associated direct economic benefit of \$2 trillion, primarily from reducing exposures to PM and ozone. A separate study (Hall *et al.*, 2008) found that the cost of exposure to particles less than 2.5 microns in diameter (PM_{2.5}) and ozone in California alone was more than \$28 billion annually.

Buildings provide partial shelter from outdoor air pollutants such as PM and ozone. In conventional air conditioned buildings, outdoor air passes through a particle filter before being delivered to the occupied space, but in naturally ventilated buildings, outdoor air enters the occupied space directly through operable windows. In both types of buildings, PM and ozone are removed from the air to some extent by deposition on indoor surfaces. Several prior studies have quantified the indoor concentrations divided by the outdoor concentrations (IO ratio) of PM, including particles smaller than 2.5 microns, in air-conditioned commercial buildings (Wu *et al.*, 2011; Burton *et al.*, 2000). Weschler (2000) summarizes the results of several studies of IO ratios of ozone in buildings, in which the majority of the commercial buildings used air conditioning. However, few prior studies have assessed indoor concentrations of PM or ozone in naturally ventilated offices.

No prior studies were identified that assessed how exposures to ozone and PM resulting from natural ventilation affect occupants' health and health-related costs in comparison to those for occupants of air-conditioned buildings. In addition, there are no prior reports of the costs and benefits associated with reduction in sick building syndrome symptoms in naturally ventilated buildings.

4.2 Methods

4.2.1 Basic Approach

Annual exposures to ozone and particles less than 2.5 micrometers in diameter (PM_{2.5}) for office workers in naturally ventilated offices were compared to the exposures of workers in conventional air-conditioned offices with sealed windows and particle filtration. Based on the differences in contaminant exposures, the differences in the numbers of cases of several health outcomes were predicted. The costs associated with each health outcome were estimated to quantify the economic consequences of broader adoption of natural ventilation. Because of uncertainties in several parameters the resulting estimates of health effects and health-related costs have substantial uncertainty.

An exposure model estimates indoor hourly ozone and PM_{2.5} concentrations and occupants' exposures to those contaminants based on typical time spent at work. The model is based on a set of constants derived from both existing empirical data and new data collected through four case studies of naturally ventilated offices. Using the exposure model plus measured outdoor particle, ozone, and temperature data from 15 cities throughout California, the difference in exposures for occupants of naturally ventilated versus air-conditioned offices were estimated. The cities were selected to represent the largest population centers in each of the 15 California Title-24 climate zones. A health impact assessment model was used to translate exposures into health outcomes and their associated costs. The health impact model uses published literature relating exposures of ozone and PM_{2.5} to specific health outcomes in the form of concentration-response (C-R) functions that predict annual cases of those outcomes.

In addition, the effects of natural ventilation versus air conditioning on prevalence rates of sick building syndrome symptoms was estimated based on a review of data from 11 studies (Seppänen and Fisk, 2002). The associated health costs were estimated based on an estimate of the annual health care costs for symptoms and the size of the affected population.

4.2.2 Field Study Methods

Because limited data have been published on indoor ozone and particle concentrations in naturally ventilated offices, additional measured field data were needed. Accordingly, data were collected on indoor and outdoor concentrations of ozone and PM_{2.5}, ventilation rates, and window usage in four naturally ventilated offices. Measured ozone and PM_{2.5} were assumed to be from outdoors and brought into the building via ventilation. For periods where spikes in indoor concentrations were evident, associated with indoor sources of particles, the associated data were excluded from the analysis. Indoor pollutant concentrations were therefore considered to be independent of occupant density, and hence occupancy was not directly surveyed.

The study buildings were either solely naturally ventilated or could be operated in natural ventilation mode. Priority was given to offices in the research team's local area because of the need for daily site visits to monitor window use. The four buildings selected represent typical naturally ventilated offices in a range of sizes.

Office 1 occupies the second floor of a two-story building located in Alameda CA. The office space has a total floor area of 250 m², split into two large open-plan areas. The building does not have a mechanical ventilation system. When necessary, space heating is provided by small electrical resistance heaters. Twelve overhead ceiling fans with fully variable control are available for occupants to use to increase indoor air movement. Fifteen sash windows located on all four sides of the office provide natural ventilation for fresh air and cooling. Data were collected during the period 9/6/11 to 12/4/11. Office 1 was monitored for a longer period than the other three offices described below, to take advantage of coincident weather and window-use monitoring by UC, Berkeley at the same location – see Chapter 3.

Office 2 is located on the second floor above mixed retail units in a built-up area of downtown Oakland CA. It is a 1,050-m² open-plan space with an aspect ratio of 0.75 and windows on all four sides. A dedicated outside air system provides mechanical ventilation in the central core area. Baseboard heaters provide space heating. Data were collected from 6/15/12 to 7/1/12, including days when minimum core mechanical ventilation was provided and days when no mechanical ventilation was provided.

Office 3, located in El Cerrito CA, is a small, 172-m², open-plan space. All heating and cooling is provided by a Fujitsu mini-split air-source heat-pump system; this unit conditions air when required. The heat-pump system did not operate during the period of study, 7/2/12 to 7/20/12.

Office 4 is located on the fifth floor of a large civic building in downtown Berkeley CA. Ventilation is provided by operable windows, supported by a stack ventilation chimney in the center of the open-plan office. Hydronic baseboard heaters provide heating.

A perfluorocarbon tracer method was used to assess time-averaged ventilation rates. Vials that passively emit perfluorocarbon tracer at a constant and known rate were installed throughout the study buildings. During the data collection period, an automated bag sampling system was used to collect up to 16 separate cumulative air samples. Each sample collection bag was filled over a period of between one and four hours, depending on the daily sampling frequency. Samples were taken every hour when practical, to increase time resolution of the ventilation rate data. The concentration of perfluorocarbon tracer in each bag sample was measured using a calibrated gas chromatograph with electron capture detector. The number of vials used in each study building was adjusted to maintain expected perfluorocarbon tracer concentrations between 0.5 - 2 ppb for the range of typical ventilation rates (1.46 to 3.66 m³/h -m²). Previous calibration studies have shown that maintaining concentrations within this range improves the accuracy of the final concentration measurement. A mass balance calculation was used to calculate the time-averaged air exchange rate based on the concentration of perfluorocarbon tracer in each sample bag and the rate at which the perfluorocarbon tracer was emitted from the vials. In the study of Office 1, ventilation rate and contaminant measurements were supplemented by outdoor weather data collected during a coinciding UC, Berkeley study of occupant thermal comfort.

Three 2B-Tech ozone monitors (Model 205) measured ozone concentrations, with one instrument located outdoors adjacent to each of the buildings and two located indoors. Indoor temperature and humidity were recorded throughout the monitoring period. Depending on the size of study building, between three and six TSI Dusttrak particle monitors, with size-selective inlets of <2.5µm, were used to measure indoor and outdoor mass concentrations of PM2.5.

In Office 1, the team from UC, Berkeley, performing research for part of this research effort, collected data on window use (see Chapter 3). To measure window states, the team installed, on ceiling joists facing the two open-plan offices, two digital cameras (Canon PowerShot A570), each with a wide-angle lens (Opteka HD² 0.20X Professional Super AF fisheye lens, real angle of view = 174 deg.). The camera firmware was modified so that the camera could be controlled automatically using scripting (Konis, 2011). This feature was used to automate the acquisition of images at regular (five-minute) intervals. Composites of the daily batches of images were made into movies that were examined visually to determine window positions. In the other three buildings, window status was determined by visual inspection at intervals ranging from every hour to twice daily.

4.2.3 Data Analysis Methods

The difference between contaminant concentrations in naturally ventilated offices and those in conventionally air-conditioned offices is given by

$$\Delta C = C_{NV} - C_{AC} \quad (4.1)$$

where C_{NV} is the contaminant concentration in the naturally ventilated building and C_{AC} is the contaminant concentration in the reference air-conditioned building.

The exposure model applied in this analysis estimates the indoor ozone and PM2.5 concentrations based on a combination of measured outdoor concentrations and typical indoor-to outdoor (IO) concentration ratios. The indoor contaminant concentrations for any given hour are given by Equations (4.2) and (4.3) for the hypothetical reference air-conditioned building and a naturally ventilated building, respectively

$$C_{AC} = IO_{AC} \times C_o \quad (4.2)$$

$$C_{NV} = (IO_{NV_wo} \times Z_{wo} + IO_{NV_wc} \times Z_{wc}) \times C_o \quad (4.3)$$

where C_o is the outdoor contaminant concentration, IO_{AC} is the ratio of indoor to outdoor concentrations of contaminants in mechanically ventilated buildings, Z_{wo} is the fraction of workday time with windows open, Z_{wc} is the fraction of workday time with windows closed, IO_{NV_wo} is the IO ratio when windows are open, and IO_{NV_wc} is the IO ratio when windows are closed. The values of the three model constants, IO_{AC} , IO_{NV_wc} , and IO_{NV_wo} , are specific to each contaminant type. Constants IO_{NV_wc} and IO_{NV_wo} are based on new case study data, and IO_{AC} values are based on published data shown in Table 4.1. A window-use model (Haldi and Robinson, 2009) was used to estimate the proportion of open windows (Z_{wo}) for each hour of the location weather data. This stochastic window-use model describes the probability of a window being open, P_w , using a polynomial function given by Equation (4.4). Haldi and Robinson (2009) found that a fourth-order polynomial equation was required to model the relationship between outdoor air temperature and window use.

$$\text{logit}(p_w) = \log\left(\frac{p_w}{1-p_w}\right) = a + b_1 \times T_{out} + b_2 \times T_{out}^2 + b_3 \times T_{out}^3 + b_4 \times T_{out}^4 \quad (4.4)$$

where T_{out} is the outdoor air temperature in °C, using the regression parameters, $a = -2.275 \pm 0.008$, $b_1 = (5.45 \pm 0.23) \times 10^{-2}$, $b_2 = (-0.70 \pm 3.24) \times 10^{-4}$, $b_3 = (3.86 \pm 0.17) \times 10^{-4}$, $b_4 = (-1.112 \pm 0.029) \times 10^{-5}$.

Applying the assumption that there are a large number of windows in each building, the proportion of open windows in the building (Z_{wo}) is assumed equal to the probability of each individual window being open, P_{wo} (Dutton *et al.*, 2012), and the proportion of closed windows Z_{wc} is then unity minus Z_{wo} .

$$Z_{wo} = P_{wo} \quad (4.5)$$

$$Z_{wc} = 1 - Z_{wo} \quad (4.6)$$

Based on published hourly outdoor ozone and PM2.5 concentration data (US EPA, 2012), Equations (4.7) and (4.8) were used to calculate average annual work-time indoor ozone and PM2.5 concentrations for naturally ventilated and air-conditioned buildings.¹⁷

¹⁷ The Environmental Protection Agency Air Quality System.
http://www.epa.gov/airquality/airdata/ad_data.html

$$C_{NV_A} = \frac{\sum_{hours} C_O \times ((IO_{NV_WO} \times Z_{WO}) + (IO_{NV_WC} \times Z_{WC}))}{\text{Total hours}} \quad (4.7)$$

$$C_{AC_A} = \frac{\sum_{hours} (IO_{AC} \times C_O)}{\text{Total hours}} \quad (4.8)$$

The work period was assumed to be 8 a.m. to 6 p.m. Monday through Friday.

The average annual difference in indoor work-time average concentration is therefore given by Equation (4.9):

$$\Delta C_A = C_{NV_A} - C_{AC_A} \quad (4.9)$$

4.2.4 Calculation of Effects of Retrofits in California's Offices

The health impacts and associated costs of retrofitting 10 percent of California's air-conditioned office stock to use natural ventilation were estimated. Impacts and costs scale directly with the percentage of offices retrofit.

First, coincident weather and outdoor contaminant data were assembled, producing 15 unique data sets from 15 cities, each representative of a California Title-24 climate zone. There are 16 California Title-24 climate zones in total; however, climate zone 16 is sparsely populated, has limited data, and is not well represented by any single city, so it was omitted from the analysis. In several zones, such as zone 4, data were only analyzed for the more populous portion of the zone; however, insufficient data are available to assess whether the populous region air quality is representative of air quality across the zone.

Meteorological stations in or near each of the 15 cities were identified and Hourly Global Surface Data (DS3505) were downloaded for each site from the NCDC Climate Data Online database (NCDC, 2012).¹⁸ Next, outdoor air quality monitoring stations near each of these meteorological stations were identified and their hourly outdoor ozone and PM2.5 data were downloaded from the US EPA online repository of ambient air quality data (see footnote [18]). It was necessary to use up to three air-quality monitoring stations per city to limit missing data. Data were examined for completeness and consistency among locations within a single climate zone. In most cases, data from the years 2006-2009 were employed; there was enough variation in data from year to year that no single year was considered representative. The hourly record of outdoor ozone concentrations was comprehensive for the majority of locations; however, for approximately half of the locations, there were insufficient hourly PM2.5 data. When hourly PM2.5 data were unavailable, daily average values were used.

¹⁸ National Climatic Data Center, Climate Data Online; Global Hourly Surface Observations, dataset ID DS3505. <http://hurricane.ncdc.noaa.gov/pls/plclimprod/poemain.accessrouter>

Exposure models were applied to each of the 15 data sets, to estimate the incremental difference between occupant exposures to ozone and PM2.5 in naturally ventilated and air-conditioned office buildings. Then, the numbers of cases of several health outcomes were calculated (including premature death, chronic bronchitis, and asthma) for each representative city. The scope of this study limited the exposure modeling to PM2.5 and ozone from outdoor air, other factors that may impact office indoor air quality, such as occupant density were not considered in this analysis. Existing published concentration versus health response functions were applied to estimate the health impacts of incremental exposures. Table A1 in Dutton *et al.* (2013) lists concentration-response functions for ozone and PM2.5.

Next, the economic costs of the exposures were estimated by multiplying the incremental number of cases of health outcomes by unit costs for health outcomes. In general, the unit costs were “willingness-to-pay values” that account for health care costs, lost work, and pain and suffering. For hospital admissions and non-fatal heart attacks, only cost-of-illness values, which accounted for health care costs and lost work, were available. The unit costs are given in Table A2 of Dutton *et al.* (2013). These calculations account for the proportion of the year spent at work (Sekhar *et al.*, 2003; Zuraimi *et al.*, 2004) and the fraction of the California population working in offices (CA SEDD, 2012).¹⁹ Of California’s 38 million residents, approximately 14 million are employed, and 5 million were identified as being in predominantly office environments. Office employment comprises management, business and financial operations, office and administrative support, architecture and engineering, legal, computer and mathematical, and community and social services occupations.

The population in each climate zone was calculated by overlaying population data by city from the Department of Finance and a list of cities by climate zone from Building Standards.^{20,21} Office workers in each climate zone were assumed to be proportional to population, with a ratio of five office workers for every 38 residents. Office worker population data for each climate zone are given in Table A4 of Dutton *et al.* (2013). Summing the results from each climate zone provided risk and outcome cost estimates for California as a whole.

4.2.5 Calculation Methods for Sick Building Syndrome Symptoms

The change in sick building syndrome symptoms among office workers was also estimated for the case of ten percent of California office buildings retrofitted to natural ventilation. The baseline prevalence of sick building syndrome symptoms in conventional air-conditioned buildings (SBSBASE) was based on the combined average prevalence (16.8 percent) of weekly

¹⁹ CA SEDD. California State Employment Development Department, OES Employment and Wages by Occupation; 2012. <http://www.labormarketinfo.edd.ca.gov>

²⁰ California Department of Finance, E-1: City/County Population Estimates with Annual Percent Change – January 1, 2011 and 2012 http://www.dof.ca.gov/research/demographic/reports/estimates/e-1/documents/E-1_2012_Internet_Version.xls

²¹ California Energy Commission, Building Energy Efficiency Standards, Reference Appendices, Appendix JA2. 2008. http://www.energy.ca.gov/maps/renewable/building_climate_zones.html.

eye, nasal, headache, and tiredness/fatigue symptoms reported from a survey of 100 U.S. offices (Brightman, 2005). Seppänen and Fisk (2002) reported that sick building syndrome symptoms in air-conditioned buildings are 30 to 200 percent greater than in naturally ventilated buildings, which translates to a 25- to 67-percent reduction in sick building syndrome symptoms in naturally ventilated buildings compared to those in air-conditioned buildings. A reduction in sick building syndrome symptoms ($\Delta\%SBS_{NV}$) reported by occupants in naturally ventilated buildings compared to occupants of air-conditioned buildings has been documented for a range of naturally ventilated buildings in a range of climates, with varying window-usage patterns. This includes one significant study performed in California (Mendell *et al.*, 1996).

In the absence of data on the willingness-to-pay valuations of sick building syndrome symptoms, costs valuations were limited to cost-of-illness data associated with sick building symptom health care costs. These health care costs amount to an annual average of \$206 per office worker (US EPA, 2007) after adjusting for medical cost inflation.

The predicted number of people reporting sick building syndrome symptoms avoided in a given week (ΔSBS_{NV}) is calculated by Equation (4.10). Symptoms were translated into dollar costs (2012 prices) using Equation (4.11).

$$\Delta SBS_{NV} = \Delta\%SBS_{NV} \times SBS_{BASE} \times \text{Office population} \quad (4.10)$$

$$\Delta CostSavings_{SBS_{NV}} = \Delta SBS_{NV} \times Cost_{SBS} \quad (4.11)$$

where ΔSBS_{NV} is the change in the number of people reporting sick building syndrome symptoms, and $COST_{SBS}$ is the annual health care cost per person with sick building syndrome symptoms.

4.3 Results

4.3.1 Reference Model for Conventional Offices

Table 4.1 summarizes prior published data on ozone and PM2.5 IO ratios and associated air exchange rates in conventional air conditioned buildings. The values of IO_{AC} for the reference air-conditioned buildings provided subsequently given in Table 4.5 were based on the IO ratios in Table 4.1. Given the significant range of published IO ratios, model predictions incorporated two scenarios (A and B), representing the lower and upper ranges of published IO data. Under scenario A, exposures to ozone and PM2.5 in the reference air-conditioned building will be lower than under scenario B. Therefore, the difference in exposures between a naturally ventilated office building and an air-conditioned reference office building will likely be greater under scenario A than under scenario B. Values of IO_{AC} for PM2.5 were chosen to be representative of the range of reported IO ratios in Table 4.1. Values of IO_{AC} for ozone were derived using a three-step process and a combination of IO ratio data described in Table 4.1 and published air exchange rate data from Bennett *et al.* (2011, Tables D1-D40, Air Exchange Summary for Buildings 1-40). First, a simple model relating IO ratios to reported air exchange rates (for air change rates of 0.4 and 1.9 h⁻¹) was produced based on the published data in Table 4.1. This model is given by Equation (4.12) with a standard error of 0.2, in the IO ratio.

Table 4.1: Summary of Reported Ozone & PM2.5 IO Ratios in Offices

Contaminant	Building location	I/O ratio (air change rate h ⁻¹)	Reference
Ozone	New Jersey, USA	0.22 (0.4 ACH), 0.54 (4ACH)	Weschler et al. 1989
Ozone	Southern California, USA	0.3 (0.3 ACH), 0.7 (1.9 ACH)	Weschler et al. 1994
Ozone	Boston MA, USA	0.3	Moschandreas et al. 1981
PM2.5	Across USA	7.2µg/m ³ /14.7µg/m ³ =0.49 ^a	Burton et al. 2000
PM2.5	California, USA	0.64 ^b (0.3-1.2), 0.59 ^c (0.3-1.2) SD ^d : 0.29	Bennett et al. 2011 (see summary in Table A5 of Dutton <i>et al.</i> , 2013)

^a Calculation based on geometric mean of indoor concentrations divided by geometric mean of outdoor concentrations.

^b Office buildings mean.

^c Geometric mean.

^d SD = standard deviation.

$$\text{I/O ratio} = 0.085 \times \text{Air exchange rate} + 0.3 \quad (4.12)$$

Second, typical office building air exchange rates (0.89 ACH with a standard deviation of 0.365) were estimated based on tracer gas decay measurements from eight California office buildings (Bennett *et al.*, 2011, Tables D1-D40, Air Exchange Summary for Buildings 1-40). Finally, the upper and lower ranges of typical ozone I/O ratios were derived from the linear ACH-IO ratio model using the range of ventilation rates from 1.24 ACH (0.89 + 1 standard deviation) to 0.52 ACH ((0.89 – 1 standard deviation). The resulting lower and upper values for IO_{AC} constants, compiled in Table 4.2, were 0.34 (std. error: 0.2) and 0.41 (std. error: 0.2) respectively.

Table 4.2: Model Constants for Air-Conditioned Mechanical Ventilated Buildings

Model parameter	AC Model constants	
	Ozone, IO ratio	PM, IO ratio
Mechanical ventilation (IO _{AC}) For Scenario A	0.34	0.5
Mechanical ventilation (IO _{AC}) For Scenario B	0.41	0.6

4.3.2 Results of Case Studies in Naturally Ventilated Offices

From the measured hourly IO ratios of PM2.5 and ozone, approximate upper and lower bounds (excluding outliers) were calculated. Upper bounds were found to coincide with periods when windows were open and ventilation rates were high; the lower bounds corresponded to periods of closed windows and low ventilation rates. Table A3 of Dutton *et al.* (2013) gives the average, minimum, and maximum hourly IO ratios of PM2.5 and ozone for three cases: windows open, windows closed, and overall average irrespective of window state. Weekday periods were

defined as Monday to Friday from 8 a.m. to 6 p.m. A T-test was performed on IO ratios during closed-window and open-window periods. Table 4.3 and

Table 4.4 summarizes IO results and the probabilities (P-values) that the differences in the two data sets are different due to chance alone.

Table 4.3: Measured Weekday Period, Hourly IO PM2.5 Ratios

Office Study	Mean I/O Ratio (Windows Closed)	Mean I/O Ratio (Windows Open)	P-Value	Peak I/O Ratio, Windows Open
Office 1	0.48 SD:0.12	0.61 SD:0.20	5.2E-07	0.98
Office 2	NA ^a	0.24 SD:0.10	NA ^a	0.52
Office 3	0.62 SD:0.08	0.79 SD:0.10	1.3E-07	0.95
Office 4	NA ^a	0.54 SD:0.19	NA ^a	0.96

Table 4.4: Measured Weekday Period, Hourly IO Ozone Ratios

Office Study	Mean IO Ratio (Windows Closed)	Mean IO Ratio (Windows Open)	P-Value	Peak IO Ratio, Windows Open
Office 1	0.18 SD:0.11	0.37 SD:0.18	1.5E-22	0.78
Office 2	NA ^a	0.24 SD:0.10	NA ^a	0.52
Office 3	0.18 SD:0.07	0.28 SD:0.14	1.9E-05	0.54
Office 4	NA ^a	0.39 SD:0.10	NA ^a	0.68

^A weekday data with closed windows insufficient for statistically significant result

In Office 1, weekday monitoring periods were known to include periods of soldering by occupants, which increases indoor concentrations of PM2.5. Spikes in indoor particles, unrelated to trends in outdoor air particles, were also identified in a significant proportion of the data from Office 3. Based on visual inspections, these periods were excluded from the assessment of IO ratios.

Based on the data in Table 4.3 and Tables 4.4, four model constants, shown in Table 4.5, were derived for use in the exposure model for occupants of naturally-ventilated offices. During closed-window periods, the averages of IO ratios were 0.55 (SD:0.19) and 0.18 (SD:0.09) for PM2.5 and ozone respectively. Closed-window constants are representative of the typical observed average IO ratios during closed-window periods.

For the windows-open condition, the selected model constants represent IO ratios when all office windows are open. The measured data did not include any periods when all of the windows were open; therefore, peak IO ratios during open-window conditions were used to generally inform the selection of model constants.

Table 4.5: Exposure Model Constants for Naturally Ventilated Offices

Model Parameter	Model Constants	
	Ozone, IO ratio	PM2.5, IO ratio
Closed Window (IO _{NV_wc})	0.2	0.55
Open Window (IO _{NV_wo})	0.8	0.95

4.3.3 Results of Exposure and Health Risk Calculations

Figure 4.2 and Figure 4.3 give the total number of cases for a range of health outcomes for 15 Title-24 climate zones for scenarios A and B, based on the 500,000 office workers who would be affected if 10 percent of California offices were retrofitted to natural ventilation.

Figure 4.2: Total CA Cases of Health Outcomes Related to Changes In PM 2.5 Exposure

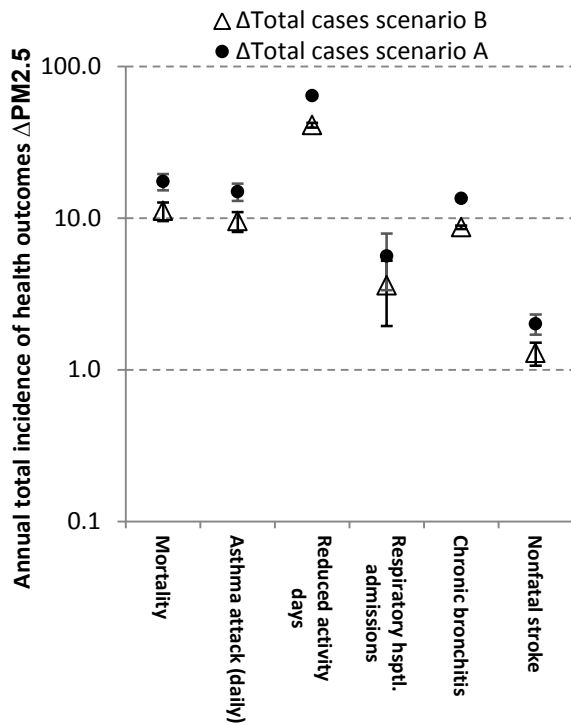
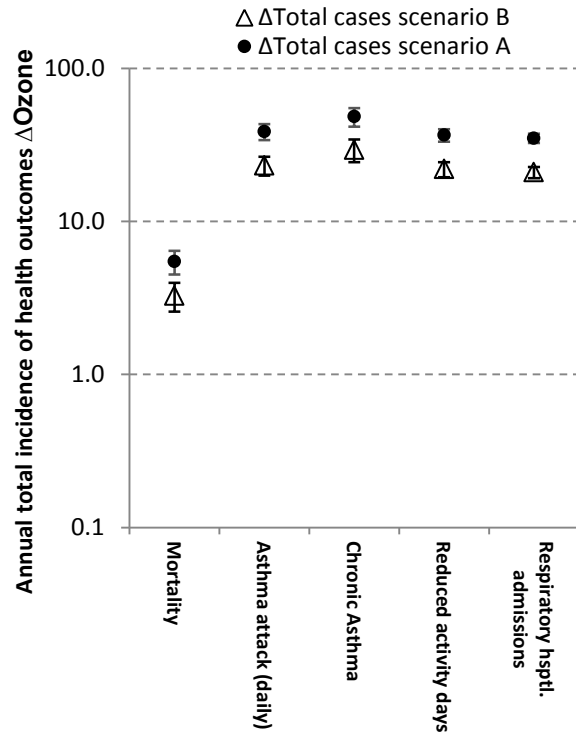

Figure 4.3: Total CA Cases of Health Outcomes Related To Changes In Ozone Exposure



Error bars on Figure 4.2 and Figure 4.3 indicate the uncertainty in the total number of cases for each health outcome (SD_{Total}) based only on the uncertainty in the coefficients used in each of the concentration-response functions. An uncertainty estimate for all of California (SD_{Total}) was calculated by combining the uncertainty in the number of cases in each Title-24 climate zone (SD_{cz}) using Equation (4.13).

$$SD_{Total} = \sqrt{\sum_{CZ} SD_{CZ}^2} \quad (4.13)$$

As a consequence of Equation (4.13), the uncertainty in the consolidated California figure was smaller as a percentage of total costs than is the case for the costs for individual climate zones. Because of the limited scope of this study, the analysis did not extend to incorporating the uncertainty related to numbers of cases of health effects into an overall combined uncertainty in costs. The central estimate of the number of cases of each health outcome was translated into an associated annual monetary cost, shown in Figure 4.4 and Figure 4.5. The error bars shown in these figures represent only the uncertainty in the monetary value of each health outcome, based on a single standard deviation either side of the central figure; standard deviations of health outcome monetary values are given in Table A2 of Dutton *et al.* (2013).

Figure 4.4: Total CA Costs of Health Outcomes Related to Changes in PM 2.5 Exposure

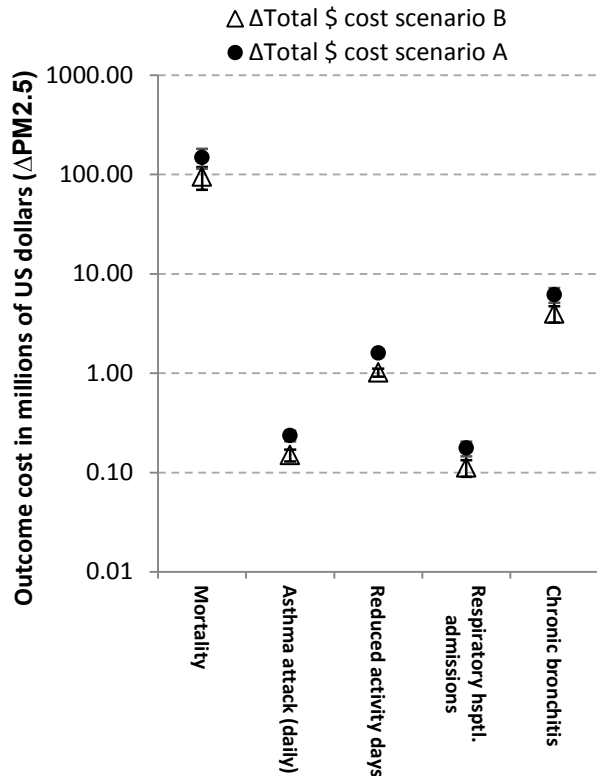

Figure 4.5: Total CA Costs of Health Outcomes Related to Changes in Ozone Exposure

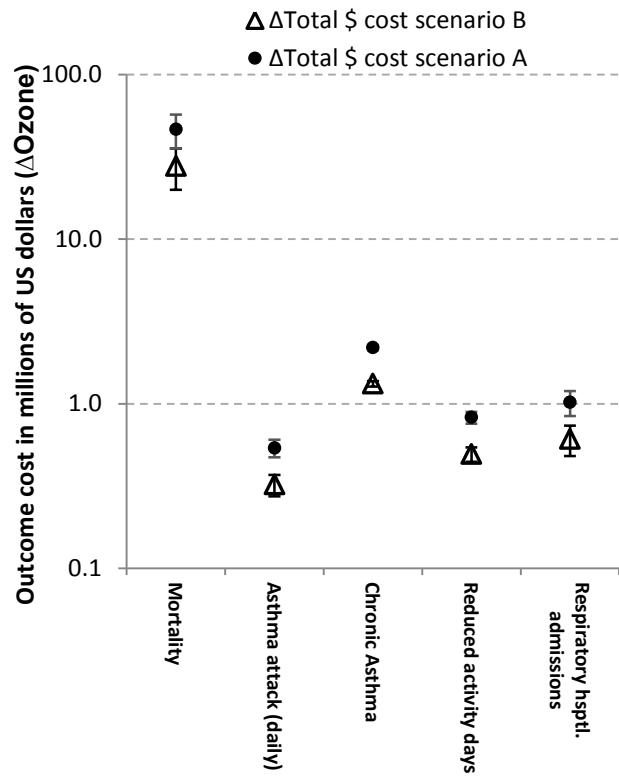

Table 4.6 gives summary data for each data set, including average outdoor temperature, average outdoor ozone and PM2.5 concentrations, and the changes in exposures used in the risk analysis. Also included is the annual average window-open fraction. As expected, window use was found to be significantly increased during the summer months; thus, natural ventilation increased ozone and PM2.5 exposure during the summer and lowered exposure during the winter compared to the exposures in mechanically ventilated buildings. Averaging changes in

indoor concentrations over the whole year, including both winter and summer months, and adjusting for time spent at work resulted in comparatively small differences in annual average exposure-related concentrations between the two types of buildings (change in PM_{2.5} < 2 µg/m³, change in ozone < 3 ppb).

Table 4.6: Summary Results for Title-24 Climate Zones

T24C Z	Representative city	Daytime mean outdoor temp. (°C)	Daytime fraction of open windows	Average daytime outdoor PM _{2.5} (µg/m ³)	Average daytime outdoor ozone (ppb)	Change in PM _{2.5} ^a (µg/m ³) Scenario A B		Change in ozone ^a (ppb) Scenario A B		Total change in health-related cost in millions \$ Scenario A B	
1	Arcata	11.8	0.25	8.0	24.5	0.32	0.09	0.04	-0.45	\$0.65	\$0.00
2	Sonoma	17.1	0.40	9.0	24.3	0.46	0.20	0.87	0.38	\$2.97	\$1.29
3	Bay Area	15.8	0.37	10.1	23.3	0.61	0.30	0.59	0.12	\$13.87	\$6.23
4	San Jose	18.0	0.43	11.3	26.7	0.70	0.39	1.07	0.54	\$10.02	\$5.45
5	Santa Maria	17.0	0.40	8.2	29.2	0.50	0.27	0.95	0.35	\$1.66	\$0.81
6	Oxnard	17.1	0.41	12.9	34.3	0.78	0.42	1.17	0.47	\$11.29	\$5.72
7	San Diego	18.7	0.46	10.5	38.5	0.73	0.43	1.65	0.86	\$9.47	\$5.37
8	Anaheim	19.7	0.49	14.3	36.1	0.96	0.96	1.79	1.79	\$37.77	\$37.77
9	Burbank	21.1	0.49	13.5	44.3	1.00	0.61	2.31	1.42	\$28.47	\$17.39
10	Riverside	22.2	0.49	17.2	41.4	1.24	0.74	2.03	1.18	\$32.02	\$19.06
11	Redding	19.8	0.43	12.6	34.5	0.85	0.48	1.43	0.73	\$6.72	\$3.74
12	Sacramento	19.8	0.43	12.6	34.5	0.85	0.48	1.43	0.73	\$26.79	\$14.91
13	Fresno	21.3	0.41	20.5	41.8	1.18	0.61	1.57	0.73	\$18.27	\$9.25
14	Lancaster	21.3	0.41	7.5	45.0	0.48	0.26	1.64	0.73	\$4.06	\$2.05
15	Palm Springs	27.8	0.41	8.0	48.1	0.49	0.26	1.25	0.28	\$3.01	\$1.29
						Total annual costs in millions of dollars				\$207.0	\$130.3

^aConcentration in naturally ventilated building minus concentration in air-conditioned building, adjusted to account for the proportion of time occupants spend in the office.

Figure 4.6 and Figure 4.7 summarize the incremental costs incurred per 10,000 workers and related to changes in ozone and PM_{2.5} exposures for scenarios A and B. Both scenarios assume a 10-percent penetration of natural ventilation compared to air conditioning. Costs were negative in several of the climate zones because in those climates the annual pollutant exposures were lower for occupants of naturally ventilated offices than for occupants of air-conditioned offices. Lower exposures for occupants in naturally ventilated offices in these climates were a result of less opening of windows than in other climate zones, and the absence of a mechanical ventilation system to maintain ventilation when windows are closed. The reduced use of windows was triggered by lower average outdoor temperatures and resulted in low ventilation rates.

Figure 4.6: Annual Costs per 10,000 Workers in Millions of U.S. Dollars for Each Title-24 Climate Zone Under Scenario A

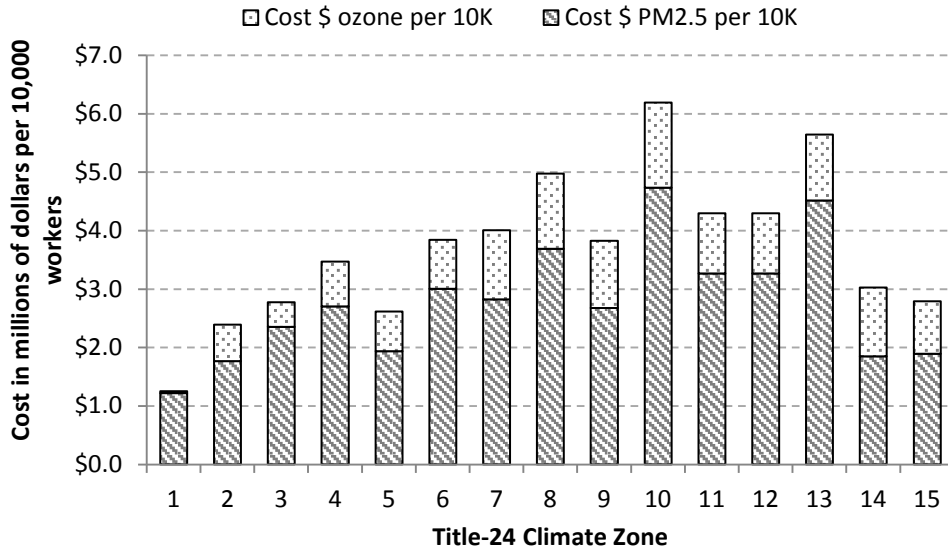
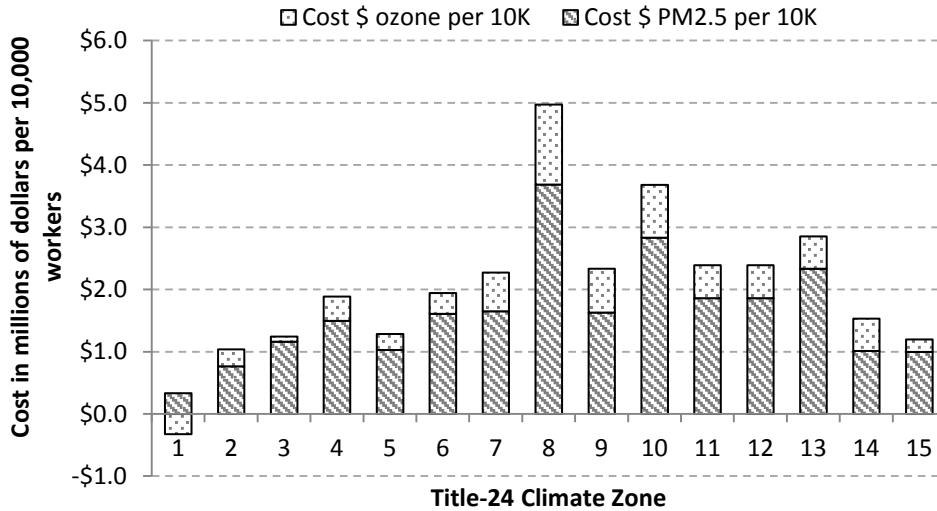

Figure 4.7: Annual Costs per 10,000 Workers In Millions of U.S. Dollars for Each Title-24 Climate Zone Under Scenario B



Health costs can be assumed to scale proportionally with the number of buildings that are retrofitted, so the costs associated with 50-percent retrofit penetration would be five times greater than the costs listed in this paper. To first order, the health impact estimates for a natural ventilation retrofit of 10 percent of California offices would apply equally to a natural ventilation retrofit of 10 percent of the office floor area of 100 percent of the office buildings although no consideration is given in this analysis to the feasibility of such retrofits.

4.3.4 Changes in Sick Building Syndrome Symptoms

The effects of retrofits to natural ventilation of 10 percent of California's office stock was estimated assuming 25 to 66 percent reductions in sick building syndrome symptoms in naturally ventilated offices (Seppänen and Fisk, 2002). For retrofits affecting 10 percent of California's 5 million office workers, the model predicted that 22,000 to 56,000 fewer people would experience symptoms in a given week. Based on an average annual cost of treatment for symptoms (\$206 at 2012 prices), this reduction in symptoms reduced health costs by \$4.5 to \$11.5 million.

4.3.5 Analysis of Mitigation Options

The impacts of two mitigation methods on exposure-related health costs were evaluated. Both methods assume that forecasts of daily average PM_{2.5} and ozone concentrations would be used to pre-emptively close windows to limit occupants' exposures on high-pollution days. Occupants are assumed to be instructed to close windows during these times. Because occupants are known to value having control over their own windows (Ackerly, 2012), the percentage of days when use of windows was restricted was limited to the 10 percent of days with the poorest air quality. Outdoor daily average concentration thresholds were identified and used to define the days with restricted window use. Concentration thresholds differed for each climate zone, so that the days with restricted window use occurred when the outdoor air pollution was above the 90th percentile of the observed pollution data for each city. In method one (M1), mechanical ventilation with air conditioning is substituted for natural ventilation on high-pollution days; in method two (M2), windows are simply closed on high-pollution days. Figure 4.8 and Figure 4.9 give the total incremental health-related costs for naturally ventilated compared to air-conditioned, buildings when these two mitigation methods are implemented in three Title-24 climate zones. The three zones (4, 8, and 12) are represented by data from the cities of San Jose, Anaheim, and Sacramento respectively. Scenario A model coefficients were used for this comparison. The results are illustrated in Figure 4.8 and Figure 4.9.

Results indicate that restricting window use on high-pollution days can mitigate a proportion of the incremental health costs associated with contaminant exposure that results from natural ventilation. In climates with significant inter-seasonal temperature swings, such as Title-24 climate zone 12, costs related to PM_{2.5} exposures were lower for naturally ventilated buildings with the mitigation strategy than for the air-conditioned reference building. In the case of Title-24 climate zone 12, low PM_{2.5}-related costs resulted from a combination of minimal window use in the winter (reducing exposures) and the application of mitigation strategies on poor-air-quality days (further reducing exposures). However, this analysis does not consider the possibility that lower ventilation rates on days when window use is restricted are likely to increase sick building syndrome symptoms and other adverse effects associated with low outdoor air ventilation rates.

Figure 4.8: Ozone-Related Incremental Costs By Strategy

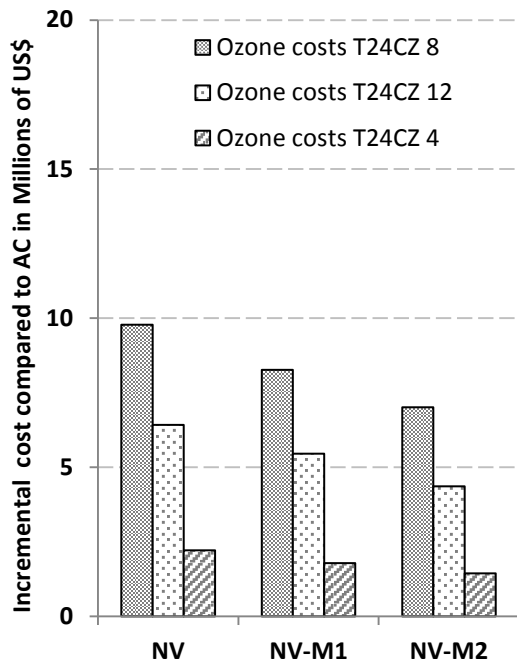
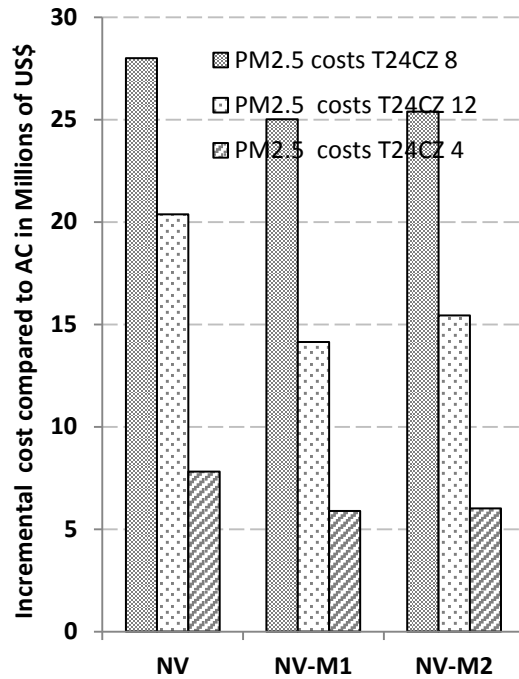

Figure 4.9: PM2.5-Related Incremental Costs By Strategy



4.4 Discussion

This analysis projects significant increases in adverse health effects from occupant exposures to ozone and particulate matter if offices in California were to substitute natural ventilation for traditional mechanical ventilation and air conditioning. The analysis also projects coincident reductions in occupants’ sick building syndrome symptoms. However, the costs of increased ozone and PM-related health effects outweigh the benefits from reduced sick building syndrome symptoms. If 10 percent of California’s office buildings were retrofitted to use natural ventilation, the estimated net annual health-related cost is \$130 to \$207 million. Although these costs appear high, the projected number of workers who experience adverse health effects is small. Roughly 14 to 23 premature deaths are projected per 500,000 workers in the retrofitted buildings. At the same time, for every 500,000 workers in retrofitted buildings, a projected 22,000 to 56,000 fewer workers experience weekly sick building syndrome symptoms, which have a much lower monetary value than the more serious health outcomes from exposure to pollutants. This analysis does not consider the potential energy and cost savings and carbon emission reductions of natural ventilation retrofits. The potential energy saving from removing mechanical air conditioning in California offices are estimated to be significant (Borgeson and Brager, 2011).

There are many substantial sources of uncertainty in the projections in this study. Data on indoor-to-outdoor concentration ratios of particles and ozone are sparse, particularly from

naturally ventilated offices. Other large sources of uncertainty include occupants' actual use of windows, C-R functions and unit costs for health effects. The C-R functions are based on studies of the general population, including susceptible infants and elderly, but the office worker population does not include those more vulnerable types of individuals, so office workers are presumably less susceptible to ozone and particles than the C-R functions would indicate. Consequently, the estimates in this paper should be considered order-of-magnitude estimates rather than absolute values.

Another limitation is the incomplete information on the costs of SBS symptoms and health effects of particles and ozone. The analysis only accounts for the projected health-care costs of SBS symptoms. If SBS symptoms significantly reduce work performance, significant cost savings could be attributed to their reduced prevalence in naturally-ventilated buildings. However, acute symptoms from increased exposures to particles and ozone in naturally ventilated buildings may also decrease work performance.

Analysis of two potential mitigation strategies that restrict window use on high-pollution days indicates that health effects and associated costs from exposure to outdoor air ozone and particulate matter could be reduced. As noted above, both strategies assume that forecasts of daily average PM_{2.5} and ozone concentrations would be used to pre-emptively close windows to limit occupant exposures on high-pollution days; in one strategy, additional mechanical ventilation is provided, and in the other it is not. For both strategies, practical considerations would need to be addressed. One significant consideration is that windows are often used for ventilation cooling during hot periods. These hot periods are likely to coincide with periods of restricted window use because elevated ozone levels are associated with hot weather; this would likely result in occupant thermal discomfort unless alternative cooling was provided. Given what is known about ventilation rates and sick building syndrome symptoms, an increase in these symptoms is expected during periods when windows are closed. In addition, further analysis would be needed to assess any costs associated with increased exposure to indoor-generated contaminants as a result of any decrease in ventilation rates.

Other mitigation strategies might include installing particle filtration and ozone removal systems inside naturally ventilated buildings. Ion generators have been proposed as an energy-efficient particle control technology. These generators emit ions that attach to particles, causing the particles to be charged; as a result of the charge, the particles rapidly deposit on indoor surfaces. Ion generators have no fans, thus they consume little energy, and have no particle collection surfaces. However, the performance data on ion generators are very mixed, and these generators can produce ozone. Siegel *et al.* (2007) reviewed the literature on ion generators and concluded that they "do not have a role in sustainable indoor environments." Another option, not analyzed, would be to use stand-alone particle filter systems distributed throughout the building. For this strategy to be effective, the rate of airflow through the filters would need to be comparable to the rate of entry of outdoor air. A possible mitigation option for ozone is to install materials in the building that react with and remove ozone at a higher rate than conventional materials, along with natural air movement to these surfaces. Activated carbon mats are an example of a material that is effective in removing ozone (Cros *et al.*, 2012). Further study is needed to determine the costs and performance of these mitigation options.

4.5 Conclusions

Retrofits that increase the use of natural ventilation in California's office buildings are projected to increase several adverse health effects as a result of occupant exposures to ozone and particulate matter from outdoor air. Although the number of workers affected would be small if 10 percent of California offices were retrofitted, the high costs assigned to the resulting adverse health effects result in projected annual costs of one to two hundred millions of dollars per year for each 10 percent of California's office buildings converted from traditional mechanical ventilation with air conditioning to natural ventilation.

The same retrofits are projected to reduce the number of workers experiencing weekly sick building syndrome symptoms. For each 10 percent of California's office buildings converted to natural ventilation from traditional mechanical ventilation with air conditioning, a projected 22,000 to 56,000 fewer workers experience weekly sick building syndrome symptoms. However, the estimated health care cost savings from reduced sick building syndrome symptoms are overshadowed by the health-related costs from increased exposures to ozone and particles.

The health effects and costs from increased exposures to ozone and particulate matter in naturally ventilated buildings could be substantially reduced by keeping windows closed on the days with the 10-percent highest levels of ozone and particulate matter, respectively. Mechanical cooling would likely be needed to maintain comfort, and mechanical ventilation would be needed to prevent an increase in sick building syndrome symptoms.

CHAPTER 5: Model Development

5.1 Introduction

Project 3 is concerned with the development of new tools for modeling wind-driven natural ventilation and for their introduction to the engineering and design communities in California. These new tools take the form of new modules in EnergyPlus that allow calculation of wind-driven ventilation in a range of different configurations as described below.

The approach adopted to develop these tools consisted of a series of sequential steps set out in different tasks. The first step, in Tasks 3.1 and 3.2, was to develop new understanding of the flows that develop within buildings when various openings are made in the façade. This was achieved by a combination of wind tunnel tests carried out by CPP Wind Engineering and CFD simulations by UCSD. The results of these tests and computations were analyzed by UCSD to develop an understanding of the different ventilation regimes and from this the dependence of the flow on the various parameters of the problem – building geometry, opening location, wind speed and direction, etc. – was established.

Based on this new understanding, the second step, in Task 3.3, was to develop and test new algorithms that relate the ventilation flow with these parameters, so that a predictive capability was established. These algorithms were then tested extensively against results in the literature and the new results obtained in the current wind tunnel tests and the CFD calculations. As a result confidence in the new algorithms was established, along with their limitations and estimates of the accuracy for different scenarios and flow conditions. This step was carried out by UCSD.

The third step was the implementation of these new algorithms into EnergyPlus, which was carried out in Task 3.4 by LBNL. Algorithms for cross-ventilation previously available in EnergyPlus (as a result of an earlier collaboration between UCSD and LBNL) were updated allowing new algorithms for single-sided and corner ventilation to be implemented, providing a significant upgrading of the potential of EnergyPlus for natural ventilation calculations.

Finally, in Task 3.5, the new version of EnergyPlus was introduced to the community through three 1-day training sessions held in San Francisco, Los Angeles and San Diego.

In order to represent non-domestic buildings in California, a generic rectangular building with a range of opening configurations was chosen. A wide range of scenarios including the effects of surrounding buildings was studied, and the details are provided in the following sections in this chapter.

Figure 5.1: Sketch of Wind-Driven Natural Ventilation Problem

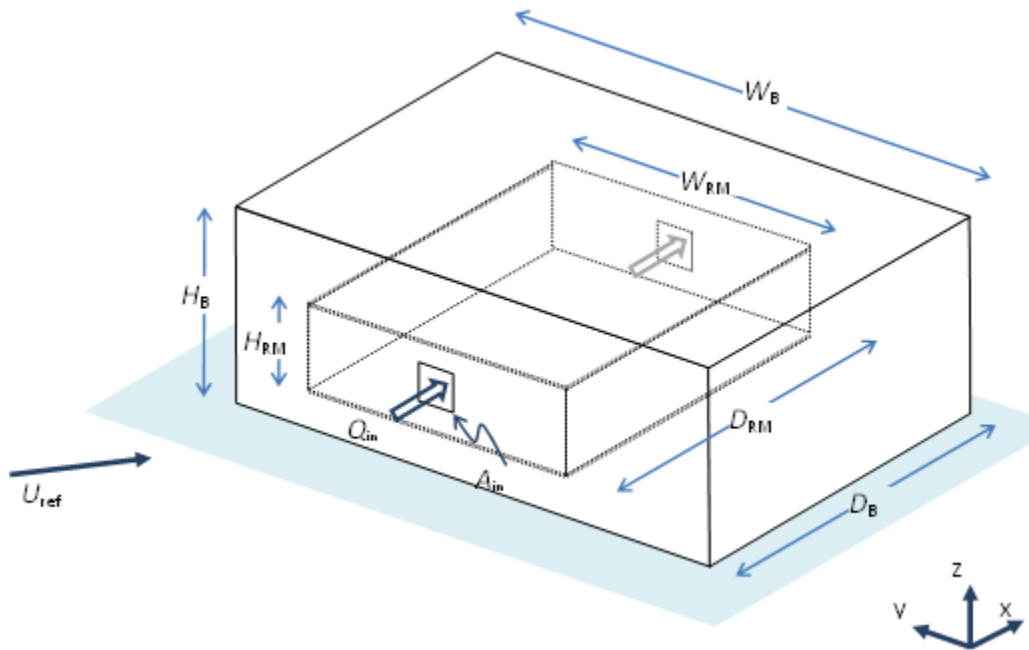

The general scope of the problem is indicated in Figure 5.1. A rectangular building of width W_B , depth D_B and height H_B contains a room of width W_{RM} , depth D_{RM} and height H_{RM} . The room has one or more openings, with typical area A_{in} . There is a wind of speed U_{ref} approaching the building leading to a volume flux passing through the room, Q_{in} , which is the total volume flux if flow enters through more than one opening. The wind speed U_{ref} is defined at an upstream location undisturbed by the presence of the building, at reference height z_{ref} , which may be fixed, e.g. 10m, or linked to the building, e.g. H_B .

For a given room, both buoyancy-driven and wind-driven ventilation flows can be important. The former tend to be dominant when external wind forcing is low and/or the temperature difference between inside and outside the room is sufficiently large. In situations where the wind is dominant, different flow regimes can result depending on the distribution of openings around the room. Three situations can be distinguished, depending on the relative position of the openings (Figure 5.2):

- (a) Cross-ventilation, CV, in which the openings are on opposite sides of a room
- (b) Single-sided ventilation, SS, in which the openings are on the same side of the room
- (c) Corner ventilation, CR, in which the openings are on adjacent sides of the room.

Figure 5.2: Three Flow Regimes for Wind-Driven Ventilation

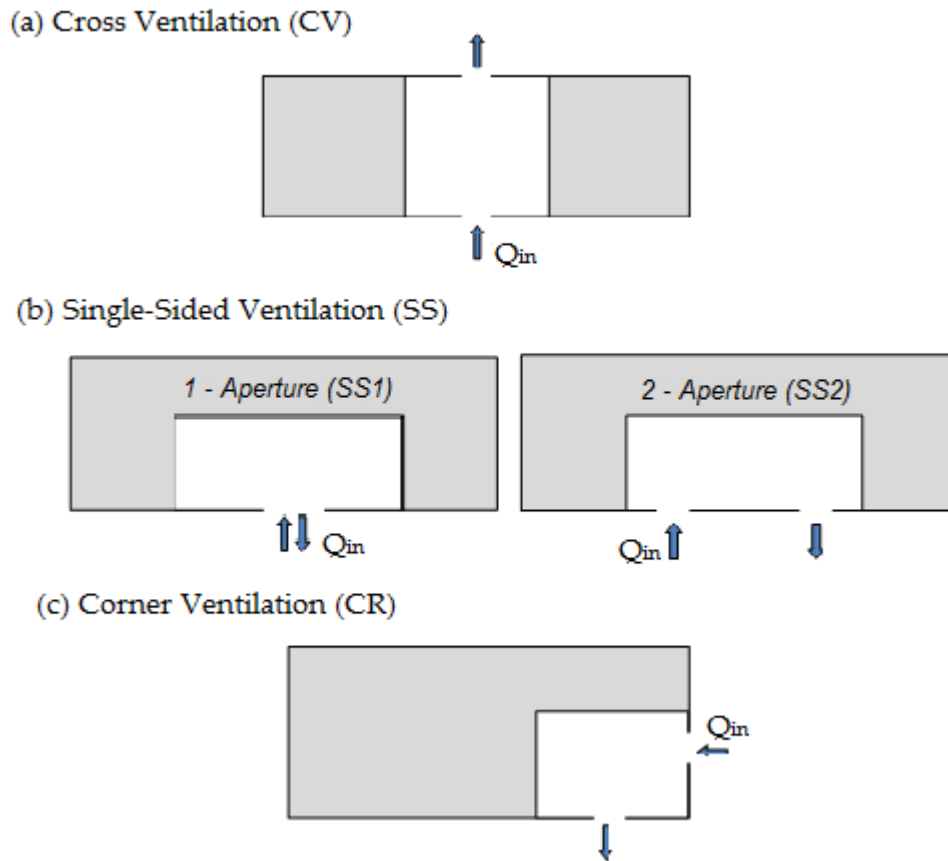

Wind tunnel tests were carried out in Task 3.1 to investigate all three regimes:

- Cross-ventilation – rooms with 2, 3 and 4 openings, equal and unequal opening areas
- Single-sided – rooms with 1 and 2 openings, equal and unequal opening areas
- Corner ventilation – room with 2 openings, equal opening areas

In addition to variations in the openings, the effect of the following was also investigated:

- Building shape
- Building environment (blocks, complex surroundings)
- (Wind speed, turbulence)

In each case, a set of wind angles was tested, typically every 22.5° or 30°. A total of more than 2000 tests were carried out across three campaigns. Full details are given in Section 5.1.

On the modeling side, investigations using a combination of CFD and analysis of the wind tunnel data were carried out to produce new and improved algorithms for implementation in the building energy code EnergyPlus. In summary:

- Cross-Ventilation
 - * 1-inlet case with bigger range of more realistic opening and room sizes
 - * Multiple-inlet capability
 - * Wind angle effects
- Single-Sided Ventilation
 - * 1-inlet case: enhance existing EnergyPlus capability by providing the user with option to allow the model to calculate input (local velocity)
 - * 2-inlet case: new model to compute the flow rate as a function of the wind angle and opening separation using Task 3.1 data
- Corner Ventilation
 - * Some characteristics of both CV and SS, although more closely aligned with former; flow rate sufficiently well-modeled with existing algorithms

Finally, these models have been implemented in EnergyPlus with algorithms that are

- Computationally simple and inexpensive
- Expressed in terms of parameters that are already available in EnergyPlus
- Easily incorporated into the existing software framework

The details of this work are described in the following sections. Section 5.1 describes the wind tunnel test and the CFD and algorithm developments are discussed in §5.2. The implementation of the algorithms into the new modules in EnergyPlus and the training are described in §5.3. The conclusions for Project 3 are given in §5.4.

5.1 Wind Tunnel Tests

Wind tunnel testing was performed with the goal of creating a rich and useful database of concentration decay, pressure, and velocity measurements for use in the investigation of natural ventilation over a range of building shapes, window configurations, and surroundings.

5.1.1 Introduction and Background

In order to provide estimates of natural ventilation potential based on building geometry, window configuration, and surroundings, the ventilation mechanisms of representative cases must be understood. To aid in this understanding, wind tunnel testing was carried out in the CPP wind engineering laboratory in Fort Collins, Colorado.

5.1.2 Methods

To provide data for the estimation of ventilation rate, the tracer concentration time-history of an initially tracer-filled, naturally-ventilated, scale model room was measured. Pressures around the ventilation openings were recorded simultaneously. Many building and ventilation configurations were tested, through a range of wind directions, over the course of three principal measurement campaigns. The availability of simultaneous concentration and pressure time series permits the connection between external pressure and internal ventilation to be investigated.

In separate tests, velocities across the face of a model building were measured with hot-film anemometry, along with simultaneous surface pressures. This data is of value for setting, or checking, boundary conditions in CFD simulations, with the velocity data being particularly useful in cases where shear across an opening could be driving air exchange.

Flow visualization was also performed for some cases, and is especially useful in cases of poor internal mixing, revealing the structure of the internal flows.

5.1.2.1 Wind Tunnel Similarity Criteria

An accurate simulation of the boundary-layer winds is an essential prerequisite to any atmospheric wind tunnel study. The similarity requirements can be obtained from dimensional arguments derived from the basic equations governing fluid motion. Detailed discussion of these requirements is given in the EPA fluid modeling guideline (US EPA, 1981) and by Cermak (1971, 1975, 1976).

5.1.2.2 Scale Model and Wind Tunnel Setup

Testing was carried out in each of two CPP closed circuit boundary layer wind tunnels, as shown in Figure 5.3. Prior to ventilation testing, a suitable boundary layer simulation was developed in the wind tunnel to reproduce appropriate scale characteristics of velocity gradient and turbulence intensity. Turning vanes at the tunnel elbows maintain a homogeneous flow at the test section entrance, and spires and a trip at the leading edge of the test section begin the development of the atmospheric boundary layer simulation. The long boundary layer development region between the spires and the test building is filled with roughness elements in a pattern experimentally set to develop the appropriate approach wind profile and surface

roughness length. The test building was installed on the tunnel turntable, allowing measurements to be made at any chosen wind direction.

Figure 5.3: CPP Closed Circuit Wind Tunnel 1

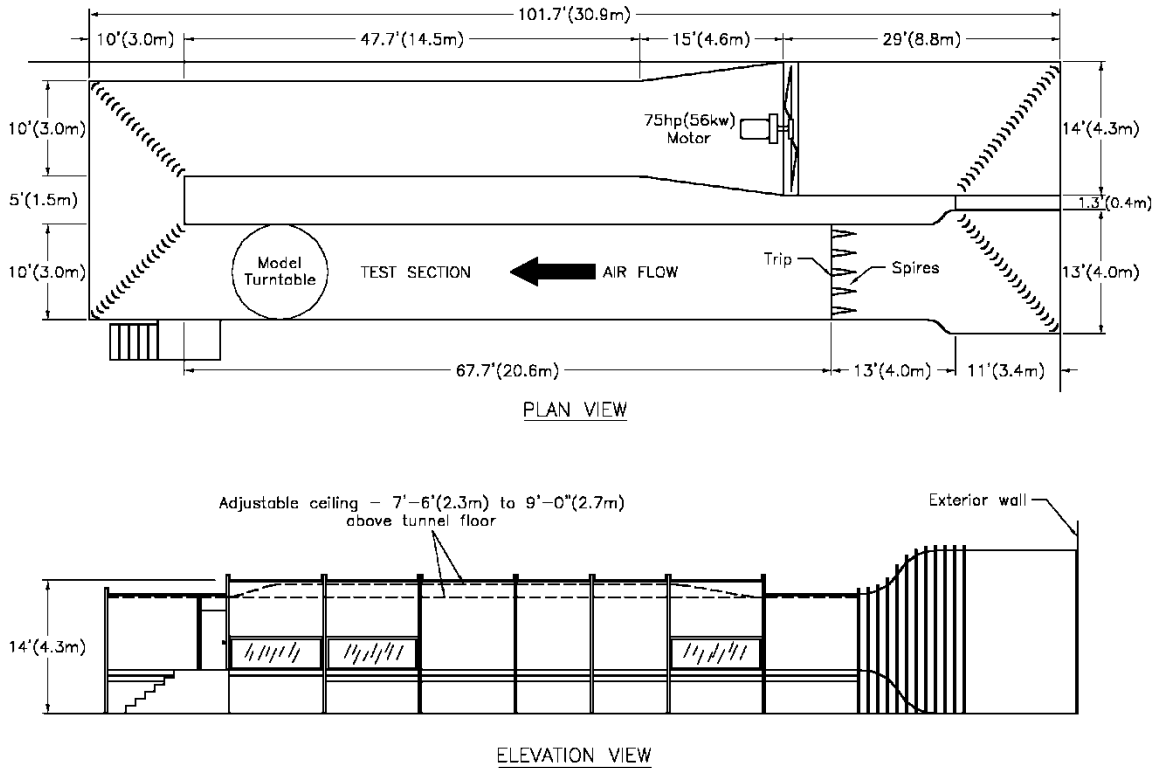

Source: CPP Wind Engineering

Each test building was modeled at 1:70 scale, and equipped with pressure taps, tracer injection ports, and concentration receptor locations. Depending upon the test iteration, different model surroundings were installed to investigate their effects. A combination of stereolithography and traditional model building techniques (wood, closed-cell foam, Plexiglas) were used to create the test building and surroundings.

5.1.2.3 Data Acquisition

To obtain an estimate of the ventilation rate, time series concentration data were collected at receptor locations mounted at approximately mid-room height through the test building floor. The building was flushed with a fixed concentration of ethane-in-nitrogen gas that was mixed using mass flow controllers (MFC's). A solenoid valve was used to control the flow of tracer gas into the test building through ports in the floor. The building was purged for a pre-set time sufficient to allow the concentration to reach a near-steady state. Depending upon the test iteration, a range of 2500ppm-5000ppm ethane tracer was achieved. After the pre-set filling time, the solenoid valve closed, and the building ventilated naturally for the remainder of the test. Fill/ empty times varied between campaigns, depending on room volume, available flow rate, and ventilation, but 40 seconds filling, 40s ventilate was typical in the January 2013 model.

To measure the concentration decay, two fast flame ionization detector (FFID) units were mounted close beneath the test building and routed to receptor locations inside the structure. Tubing length was kept to a minimum to maximize frequency response. The FFIDs were two Cambustion Model HFR400 heads, as shown in Figure 5.4, connected to a Model HFR200 control panel. Both FFID units were calibrated using pre-mixed gasses prior to testing. The receptor locations varied depending upon the specific test iteration. Simultaneous concentration decay and pressure measurements were collected at 250 Hz.

A cooling fan was incorporated under the model building to minimize any buoyancy effects due to unintended heating of the building floor by the heat of the FFID flame chambers.

Figure 5.4: Fast Flame Ionization Detector Head

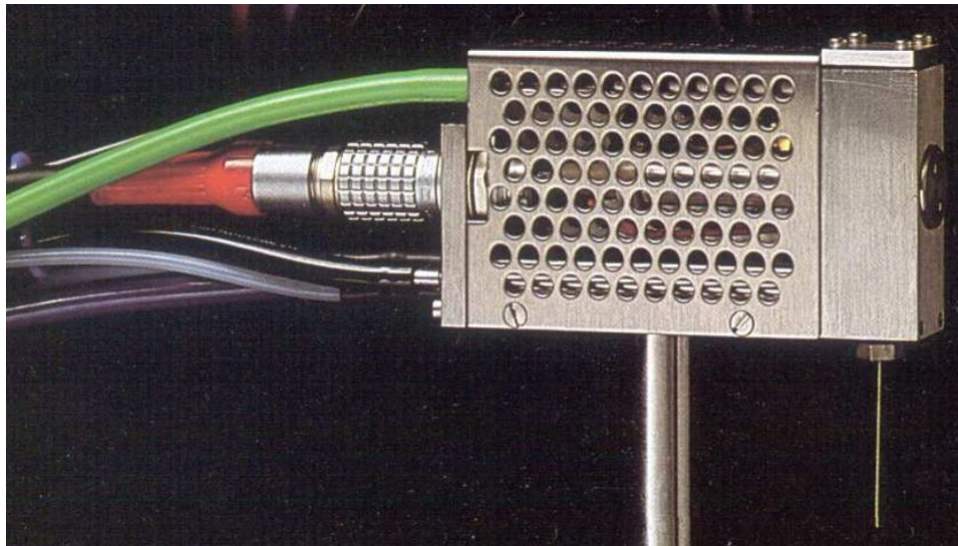

Source: Cambustion Limited

Hot-film anemometry was used to gather velocity data at locations of interest around the test building facade. The constant temperature anemometer systems used were Dantec MiniCTA units calibrated against a Pitot-static tube. 1 kHz filters in the MiniCTA units result in flat velocity response to around 500 Hz. The hot-film probes were mounted vertically, as depicted in Figure 5.5, with the hot-film itself centered at mid window height. In this orientation the hot-films are nominally equally sensitive to both horizontal components of velocity, as indicated by the “disc” in Figure 5.5, with a cosine response to the vertical component.

Figure 5.5: Hot-Film Orientation

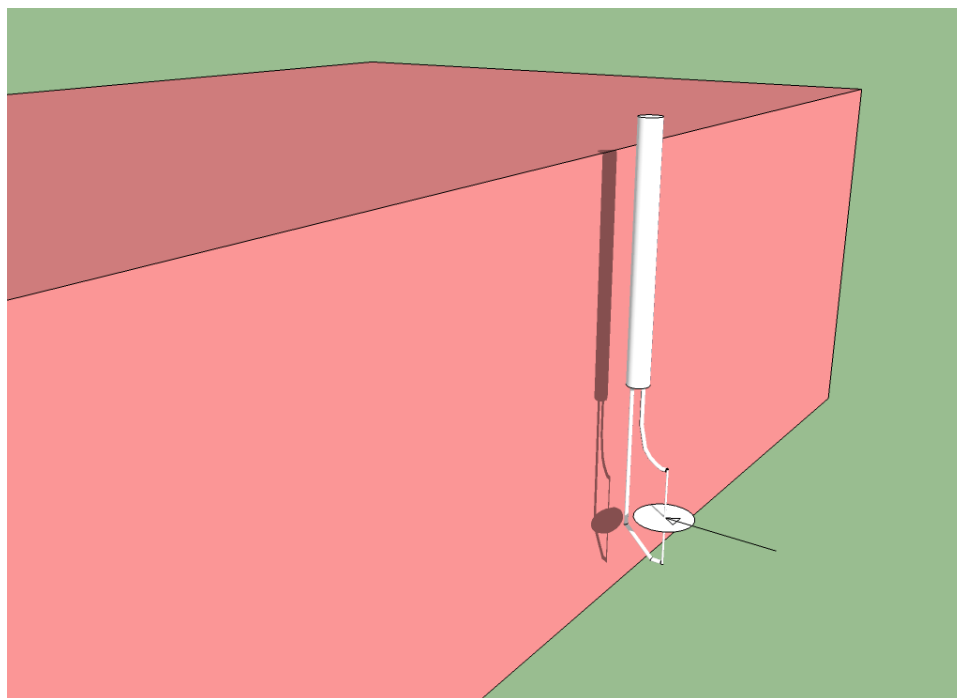

Source: CPP Wind Engineering

Time-resolved pressure measurements were taken concurrently with both concentration decay and hot-film anemometry measurements. Flush surface pressure taps were located on building walls and around building openings, exact locations depending upon test iteration and building configuration. The taps were attached with flexible tubing to individual pressure transducers mounted in CPP's multi-pressure data acquisition system (MPS) located beneath the turntable, as shown in Figure 5.6. Pressures were measured relative to the static pressure at a point above the model. The wind tunnel reference velocity was measured with a Pitot-static tube attached to a Setra Model 267 pressure transducer. A National Instruments PXI system was used to collect up to 64 pressures, in addition to the hot-film or concentration data, at 250 and 1000Hz respectively.

The transfer function of the length of tubing from the pressure tap to the pressure transducer is compensated for in software, so surface pressures can be reliably reported to beyond 100Hz.

Flow visualization was conducted on particular runs of interest. To accomplish the flow visualization, a smoke system using a mixture of pharmaceutical mineral oil and UV dye was used to charge the test building. The smoke wand was then removed and the building allowed to naturally ventilate while being recorded from above. A lower velocity tunnel speed was required to allow the video camera to capture the flow structure.

Figure 5.6: Measurement Instrumentation Beneath Test Building

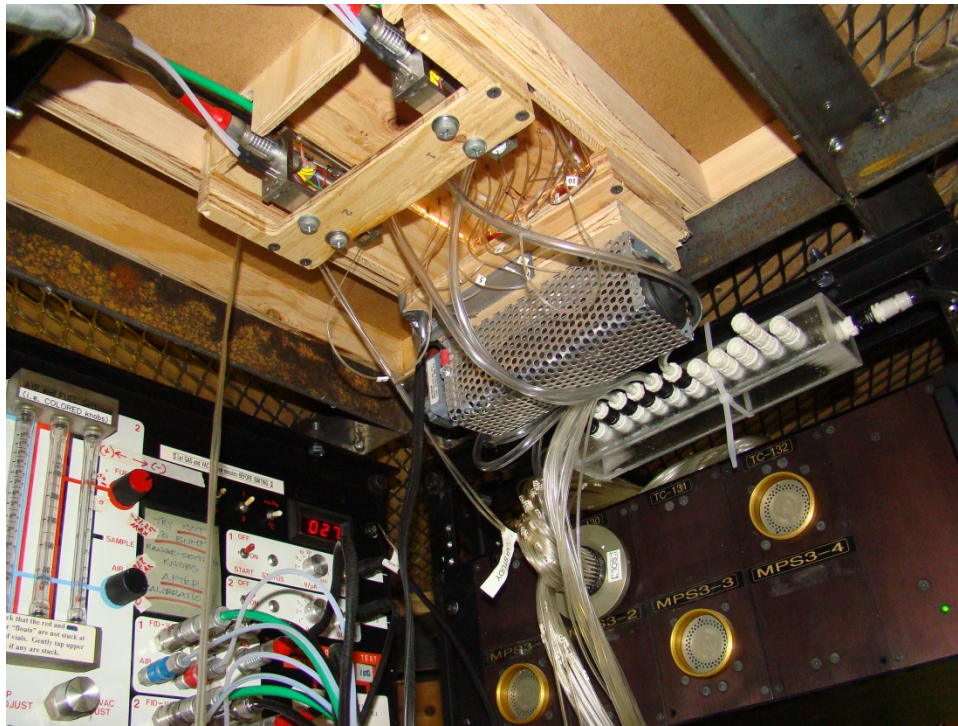

From bottom left clockwise: FFID control panel; pair of FFID heads mounted beneath test building; heat dissipation fan housing; tracer gas manifold; and MPS system with pressure tap tubing.

Source: CPP Wind Engineering

5.1.3 Results

Three CEC natural ventilation wind tunnel testing campaigns have been carried out by CPP since December 2011. Time series concentration decay data, pressure data, and flow visualization are available for all three testing campaigns. The most recent January 2013 campaign contains the addition of velocity data at locations around the building facade. Bear in mind, these results are a description of the available data, not a presentation of the data itself. Wind tunnel data are available for all cases described.

5.1.3.1 CEC Natural Ventilation – January 2013

The most recent round of natural ventilation wind tunnel testing investigated 1- and 2-aperture single-sided and corner ventilation cases. It was completed with a test building containing replaceable window elements. During concurrent concentration decay and pressure measurement, windows were either plugged or removed depending upon test iteration. O-ring seals were used to prevent leakage around the window plugs or sills of installed window frames. The wind tunnel fan drive frequency for all concurrent velocity and pressure tests was set to 45 Hz, resulting in tunnel wind speeds of around 10 m/s. For concurrent concentration decay and pressure runs, wind tunnel drive frequency was set to 30 Hz, resulting in tunnel wind speed of approximately 6 m/s.

Four test building shapes were evaluated and the dimensions of each are listed in Table 5.1. To create the required building shapes, Masonite boxes, Plexiglas, or foam were added to the instrumented base building to create the desired geometry. Figure 5.7 through Figure 5.11 are images of each building shape installed in the wind tunnel with a description of the specific test iteration. Pressure taps were located around window openings as well as inside the building. Hot-film velocity measurements were located along the outside wall at mid-window height. Figure 5.12 and Figure 5.13 depict the pressure tap locations. Concentration and velocity measurement locations in addition to window labels are shown in Figure 5.14. The entire interior volume of the test building is open for all cases with the exception of the 2-Story Corner case which includes a dividing wall.

Table 5.1: Test Building Dimensions – January 2013

Building Shape	Length (in)	Width (in)	Height (in)
2-Story	7.6	18.7	3.9
2-Story Corner ²²	15.2	18.7	3.9
2-Story Fin ²³	7.6	18.7	3.9
4-Story (Top & Bottom)	7.6	18.7	7.3

²² Wall divider inserted in 2-Story Corner case between windows S4 and S5 extending to midline of window N2, cutting room volume in half.

²³ Nine vertically oriented 0.5" x 3.9" x 0.25" fins were installed on either side of windows S1 through S8.

Figure 5.7: 2-Story Building Shape

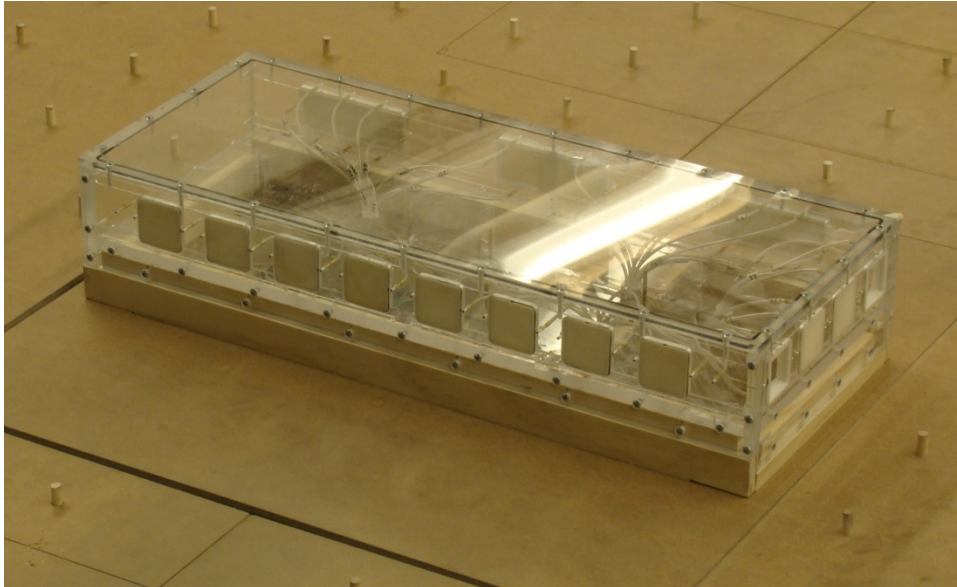

2-Story building shape with surrounding peg roughness configured for concurrent concentration decay and pressure measurement. Windows E1 and E4 open.

Source: CPP Wind Engineering

Figure 5.8: 2-Story Corner Building Shape

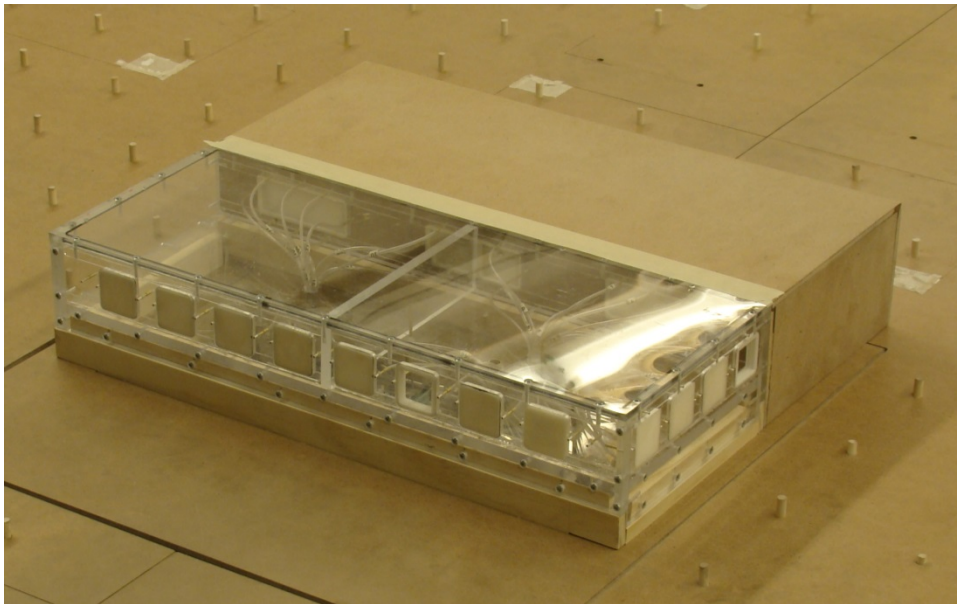

2-Story Corner building shape with surrounding peg roughness configured for concurrent concentration decay and pressure measurement. Note dividing wall location. Windows S6 and E4 open.

Source: CPP Wind Engineering

Figure 5.9: 2-Story Fin Building Shape

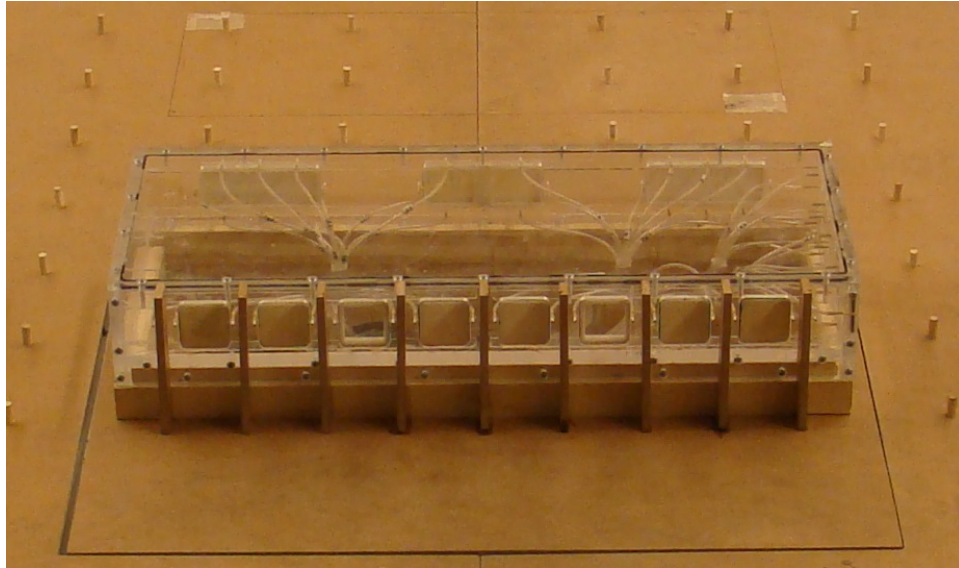

2-Story Fin building shape with surrounding peg roughness configured for concurrent concentration decay and pressure measurement. Windows S3 and S6 open.

Source: CPP Wind Engineering

Figure 5.10: 4-Story Bottom Window Level Building Shape

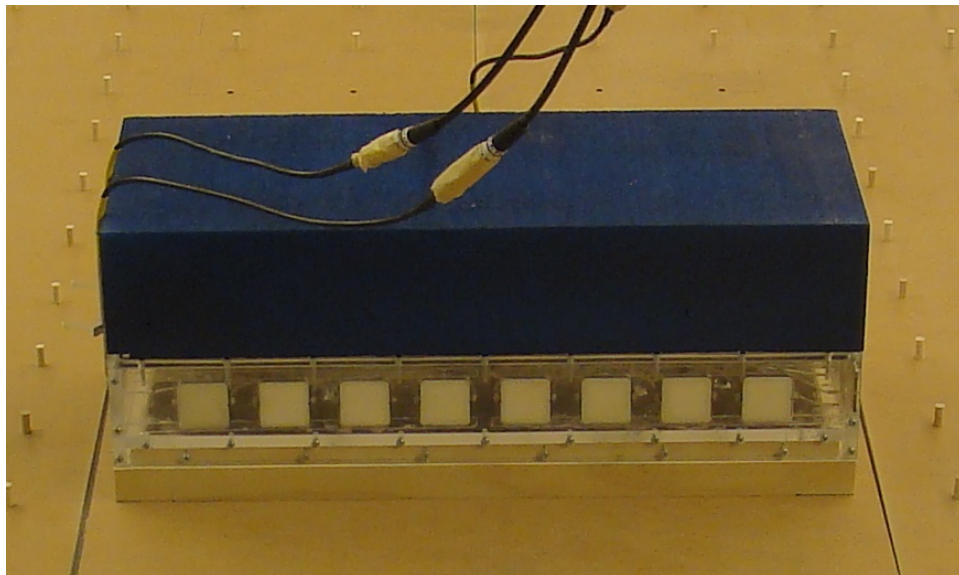

4-Story Lower Window Level building shape with surrounding peg roughness configured for concurrent velocity and pressure measurement. Hot films at locations 4, 5, and 6. Windows plugged.

Source: CPP Wind Engineering

Figure 5.11: 4-Story Top Window Level Building Shape

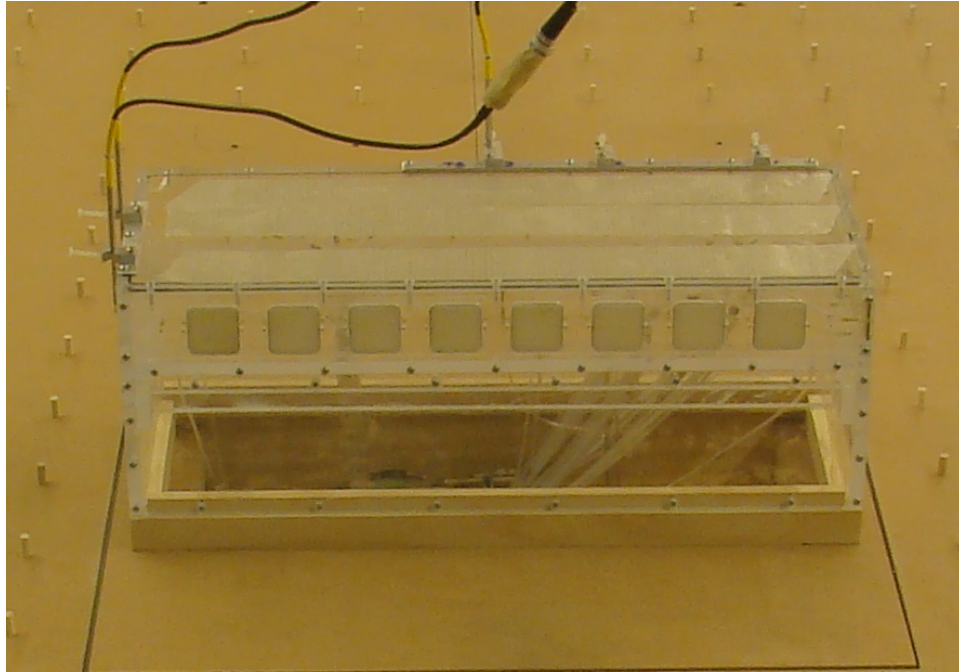

4-Story Upper Window Level building shape with surrounding peg roughness configured for concurrent velocity and pressure measurement. Hot films at locations 4, 5, and 6. Windows plugged.

Source: CPP Wind Engineering

Figure 5.12: Test Building Layout Pressure Tap Locations

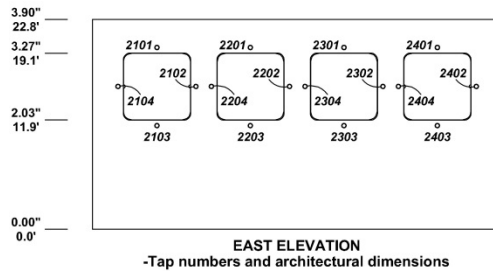
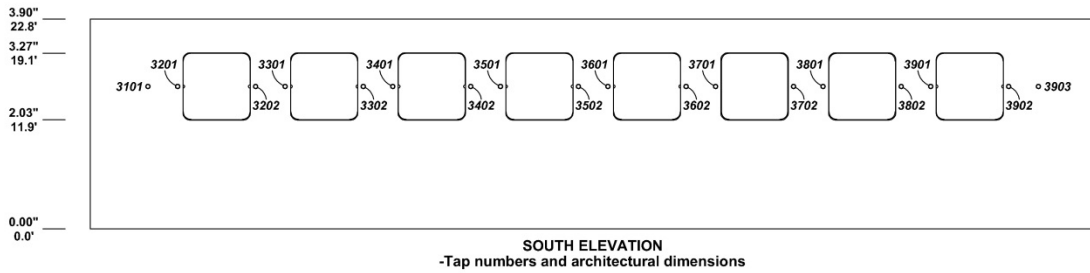
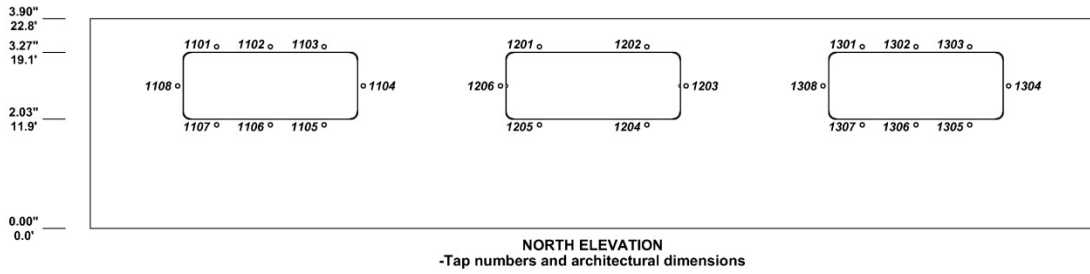

Source: CPP Wind Engineering

Figure 5.13: Test Building Layout With Internal Pressure Tap Locations

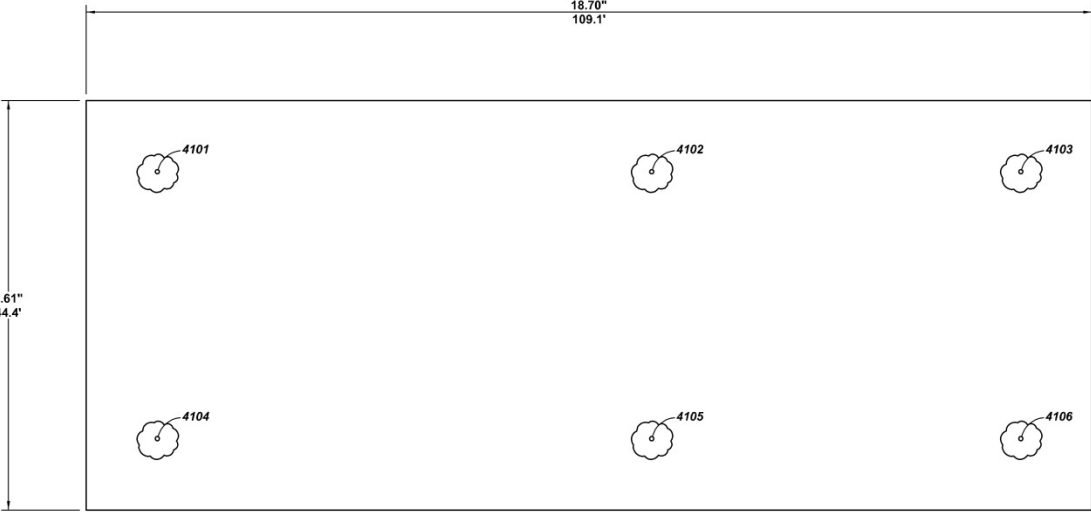

ROOF
-Tap numbers and architectural dimensions



Source: CPP Wind Engineering

Figure 5.14: Test Building Layout With Velocity Measurement, FFID Receptor, and Window Locations

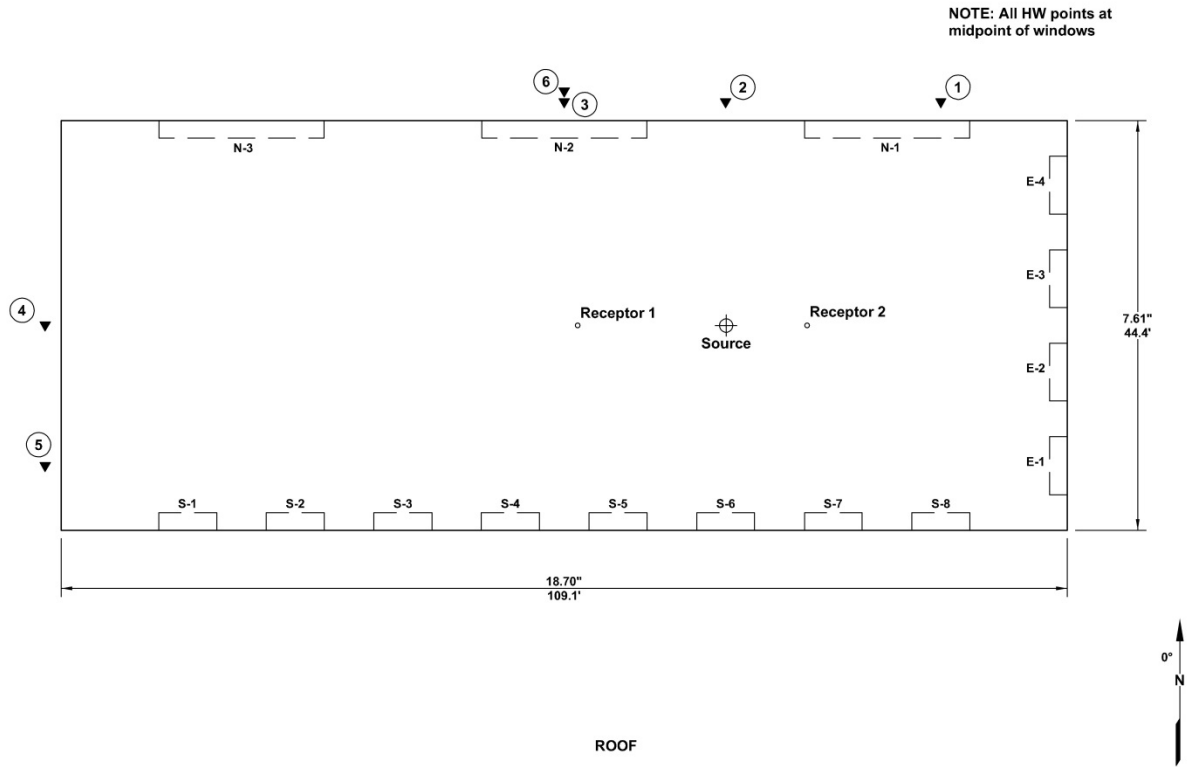

Source: CPP Wind Engineering

The January 2013 wind tunnel testing was comprised of three data collection segments; concurrent velocity and pressure, concurrent concentration decay and pressure, and flow visualization. Not all configurations were tested in each segment. The following tables provide a catalogue of available wind tunnel measurement data. Concurrent velocity and pressure configurations are listed in Table 5.2, concurrent concentration decay and pressure configurations are listed in Table 5.3 through Table 5.5, and flow visualization configurations are listed in Table 5.6. Each table includes the azimuth range for which data are available and the increment at which data were collected. Turntable layouts for each building shape and surrounding model have been included in Figure 5.15 through Figure 5.27.

Table 5.2: Velocity and Pressure Test Summary – January 2013

Azimuth (Increment)	Building Shape	Window Level	Open Window(s)	Surrounding Model	Road Width (in)
0-180 (11.25)	2-Story	-	-	Pegs	-
0-180 (11.25)	2-Story	-	-	2-story	10
0-180 (11.25)	2-Story	-	-	2-story	20
0-180 (11.25)	2-Story	-	-	4-story	10
0-180 (11.25)	2-Story	-	-	4-story	20
0-180 (11.25)	4-Story	Bottom	-	Pegs	-
0-180 (11.25)	4-Story	Bottom	-	2-story	10
0-180 (11.25)	4-Story	Bottom	-	2-story	20
0-180 (11.25)	4-Story	Bottom	-	4-story	10
0-180 (11.25)	4-Story	Bottom	-	4-story	20
0-180 (11.25)	4-Story	Top	-	Pegs	-
0-180 (11.25)	4-Story	Top	-	2-story	10
0-180 (11.25)	4-Story	Top	-	2-story	20
0-180 (11.25)	4-Story	Top	-	4-story	10
0-180 (11.25)	4-Story	Top	-	4-story	20

Table 5.3: Concentration Decay and Pressure Test Summary - Surrounding Model Pegs – January 2013

Azimuth (Increment)	Building Shape	Window Level	Open Window(s)	Surrounding Model	Road Width (in)
0-337.5 (22.5)	2-Story Corner	-	S6, S8	Pegs	-
0-337.5 (22.5)	2-Story Corner	-	E2, S6	Pegs	-
0-337.5 (22.5)	2-Story Corner	-	E4, S6	Pegs	-
0-270 (22.5)	4-Story	Bottom	E1, E4	Pegs	-
0-180 (22.5)	4-Story	Bottom	N2	Pegs	-
0-180 (22.5)	4-Story	Bottom	S1, S8	Pegs	-
0-180 (22.5)	4-Story	Bottom	S3, S6	Pegs	-
0-337.5 (22.5)	4-Story	Bottom	S1, S4	Pegs	-
0-270 (22.5)	2-Story	-	E1, E4	Pegs	-
0-180 (22.5)	2-Story	-	N2	Pegs	-
0-180 (22.5)	2-Story	-	S1, S8	Pegs	-
0-180 (22.5)	2-Story	-	S3, S6	Pegs	-
0-180 (22.5)	2-Story Fin	-	S3, S6	Pegs	-
0-337.5 (22.5)	2-Story	-	S1, S4	Pegs	-

Table 5.4: Concentration Decay and Pressure Test Summary - Surrounding Model 2-Story – January 2013

Azimuth (Increment)	Building Shape	Window Level	Open Window(s)	Surrounding Model	Road Width (in)
0-270 (22.5)	2-Story	-	E1, E4	2-Story	10
0-180 (22.5)	2-Story	-	N2	2-Story	10
0-180 (22.5)	2-Story	-	S1, S8	2-Story	10
0-180 (22.5)	2-Story	-	S3, S6	2-Story	10
0-337.5 (22.5)	2-Story	-	S1, S4	2-Story	10
0-270 (22.5)	2-Story	-	E1, E4	2-Story	20
0-180 (22.5)	2-Story	-	N2	2-Story	20
0-180 (22.5)	2-Story	-	S1, S8	2-Story	20
0-180 (22.5)	2-Story	-	S3, S6	2-Story	20
0-337.5 (22.5)	2-Story	-	S1, S4	2-Story	20
0-180 (22.5)	2-Story Fin	-	S3, S6	2-Story	10
0-180 (22.5)	2-Story Fin	-	S3, S6	2-Story	20

Table 5.5: Concentration Decay and Pressure Test Summary - Surrounding Model 4-Story – January 2013

Azimuth (Increment)	Building Shape	Window Level	Open Window(s)	Surrounding Model	Road Width (in)
0-270 (22.5)	2-Story	-	E1, E4	4-Story	10
0-180 (22.5)	2-Story	-	N2	4-Story	10
0-180 (22.5)	2-Story	-	S1, S8	4-Story	10
0-180 (22.5)	2-Story	-	S3, S6	4-Story	10
0-337.5 (22.5)	2-Story	-	S1, E4	4-Story	10
0-270 (22.5)	2-Story	-	E1, E4	4-Story	20
0-180 (22.5)	2-Story	-	N2	4-Story	20
0-180 (22.5)	2-Story	-	S1, S8	4-Story	20
0-180 (22.5)	2-Story	-	S3, S6	4-Story	20
0-337.5 (22.5)	2-Story	-	S1, S4	4-Story	20
0-337.5 (22.5)	2-Story	-	S1, S4	4-Story	10
0-270 (22.5)	4-Story	Bottom	E1, E4	4-Story	10
0-180 (22.5)	4-Story	Bottom	N2	4-Story	10
0-180 (22.5)	4-Story	Bottom	S1, S8	4-Story	10
0-180 (22.5)	4-Story	Bottom	S3, S6	4-Story	10
0-337.5 (22.5)	4-Story	Bottom	S1, S4	4-Story	10
0-180 (22.5)	2-Story Fin	-	S3, S6	4-Story	10
0-180 (22.5)	2-Story Fin	-	S3, S6	4-Story	20

Table 5.6: Flow Visualization Video Summary – January 2013

Azimuth (Increment)	Building Shape	Window Level	Open Window(s)	Surrounding Model	Road Width (in)
0-45 (11.25)	2-Story	-	S1, S8	Pegs	-
0, 67.5, 90, 112.5	2-Story	-	N2	Pegs	-
45, 90, 157.5, 180, 202.5	2-Story	-	E1, E4	Pegs	-
90, 157.5, 180, 202.5	2-Story	-	E2	Pegs	-
90, 157.5, 180, 202.5	2-Story Corner	-	E3, S6	Pegs	-

Figure 5.15: 2-Story Building Shape With 2-Story Surrounding Model and 10in Road Width Turntable Layout

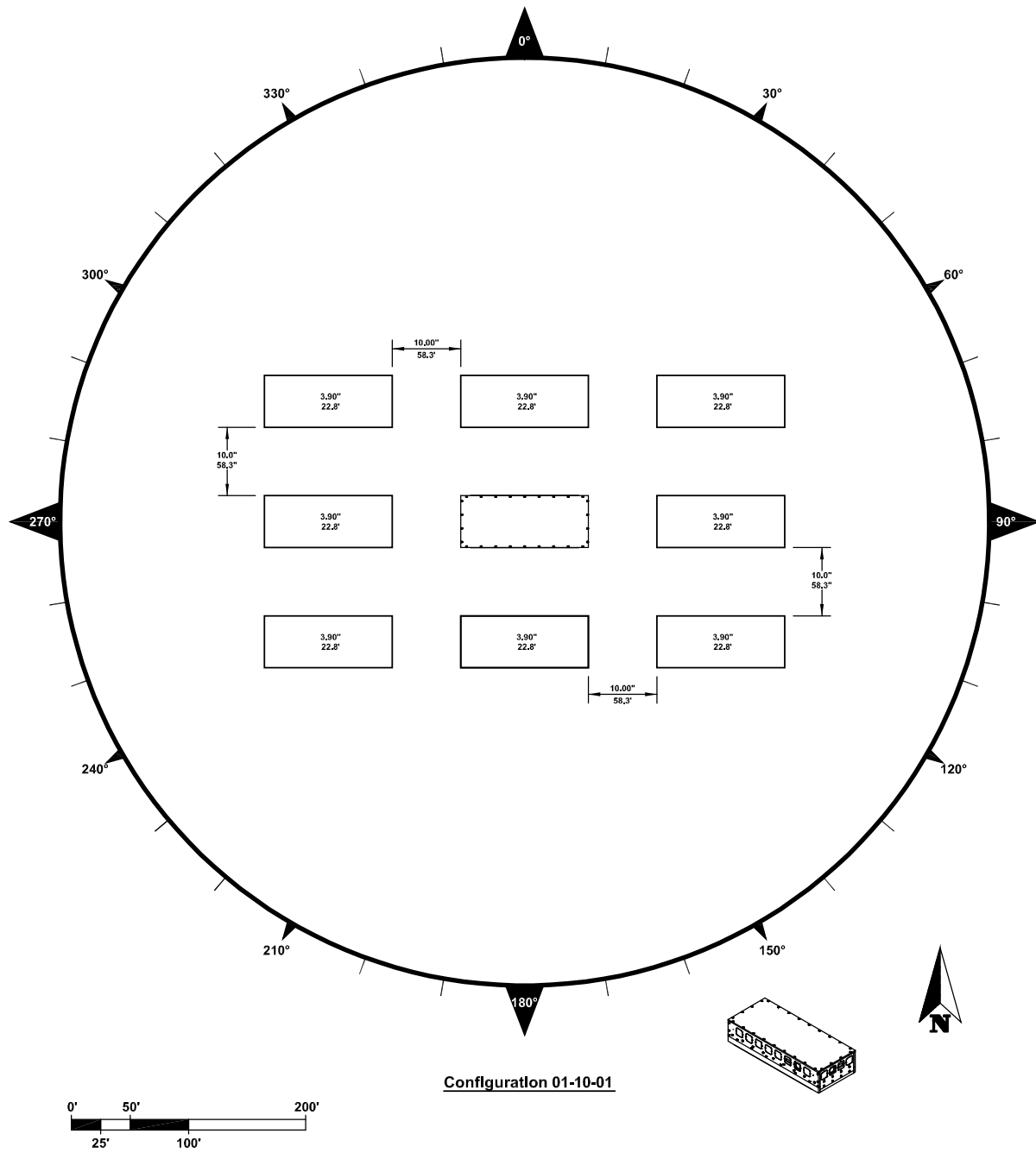

Source: CPP Wind Engineering

Figure 5.16: 2-Story Building Shape With 4-Story Surrounding Model and 10in Road Width Turntable Layout

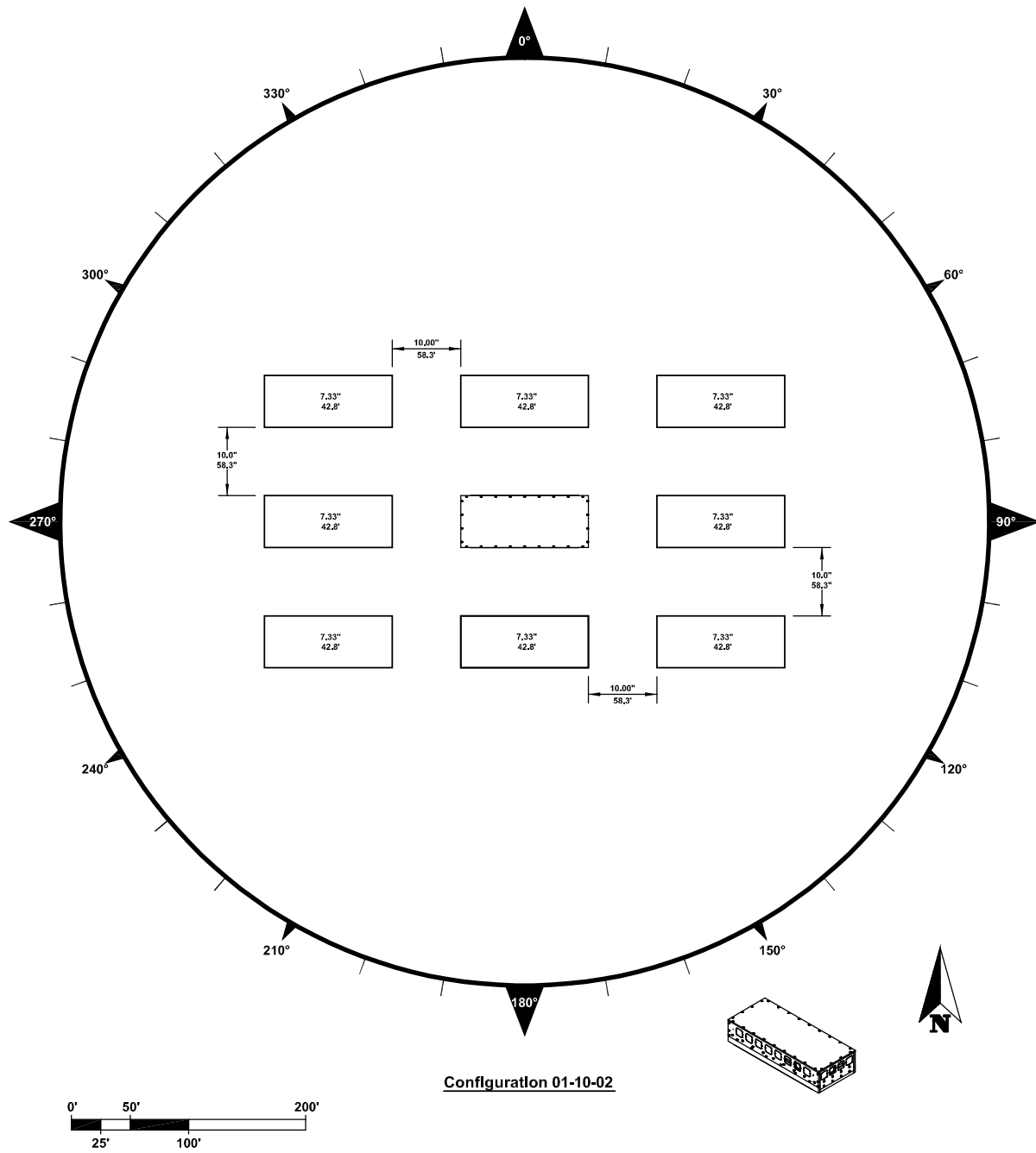

Source: CPP Wind Engineering

Figure 5.17: 2-Story Building Shape With 2-Story Surrounding Model and 20in Road Width Turntable Layout

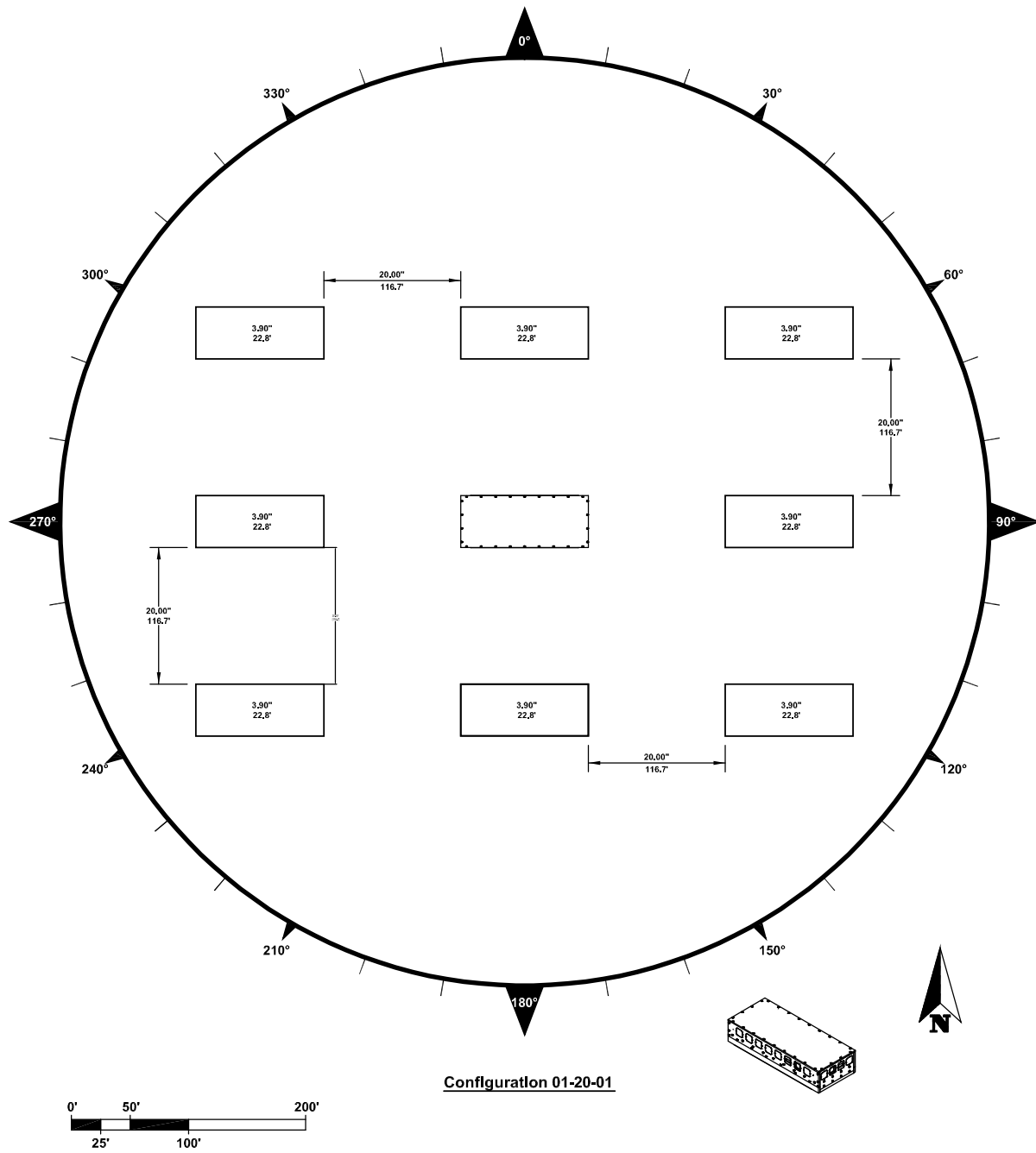

Source: CPP Wind Engineering

Figure 5.18: 2-Story Building Shape With 4-Story Surrounding Model and 20in Road Width Turntable Layout

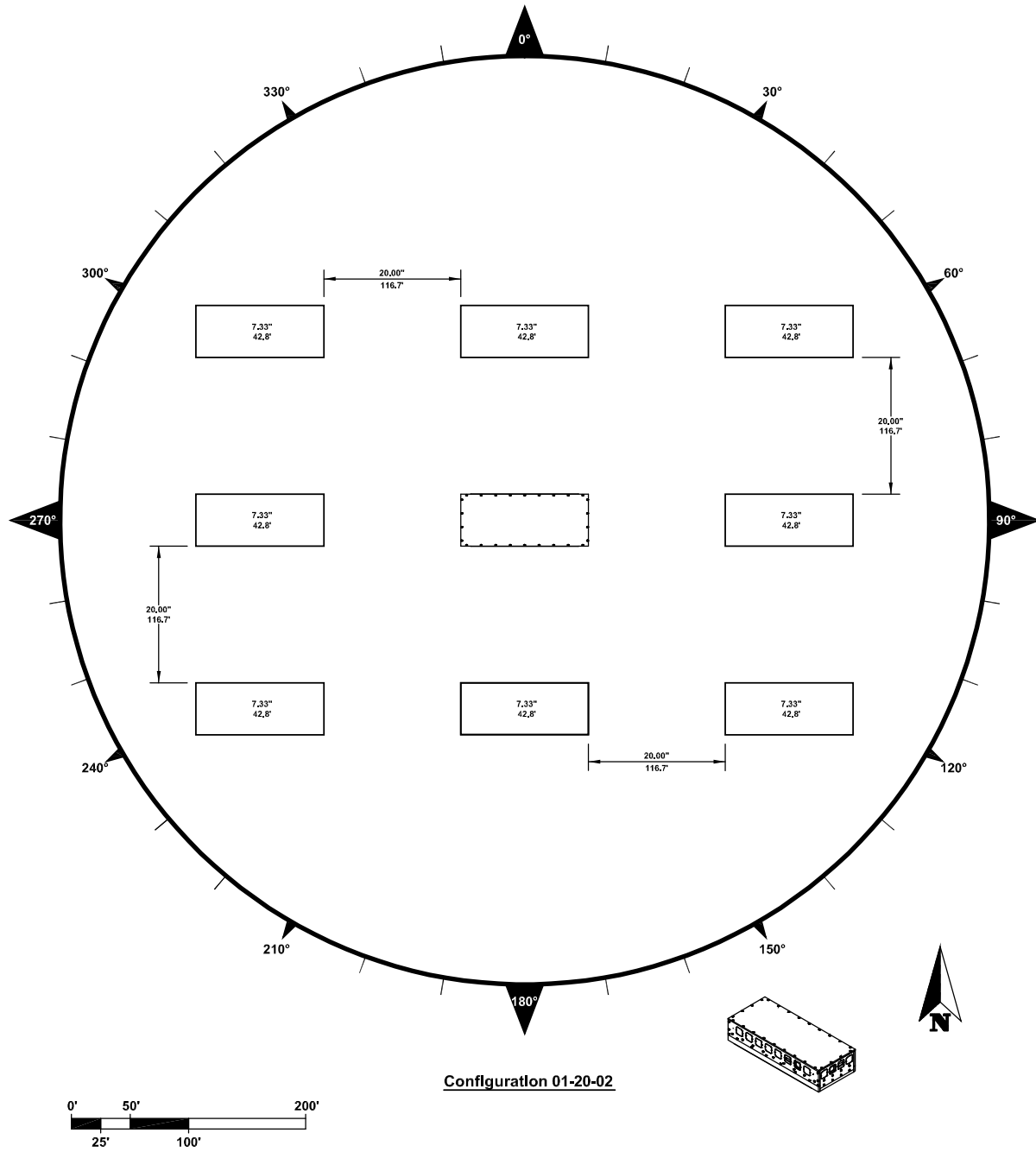

Source: CPP Wind Engineering

Figure 5.19: 4-Story Top Window Level Building Shape With 2-Story Surrounding Model And 10in Road Width Turntable Layout

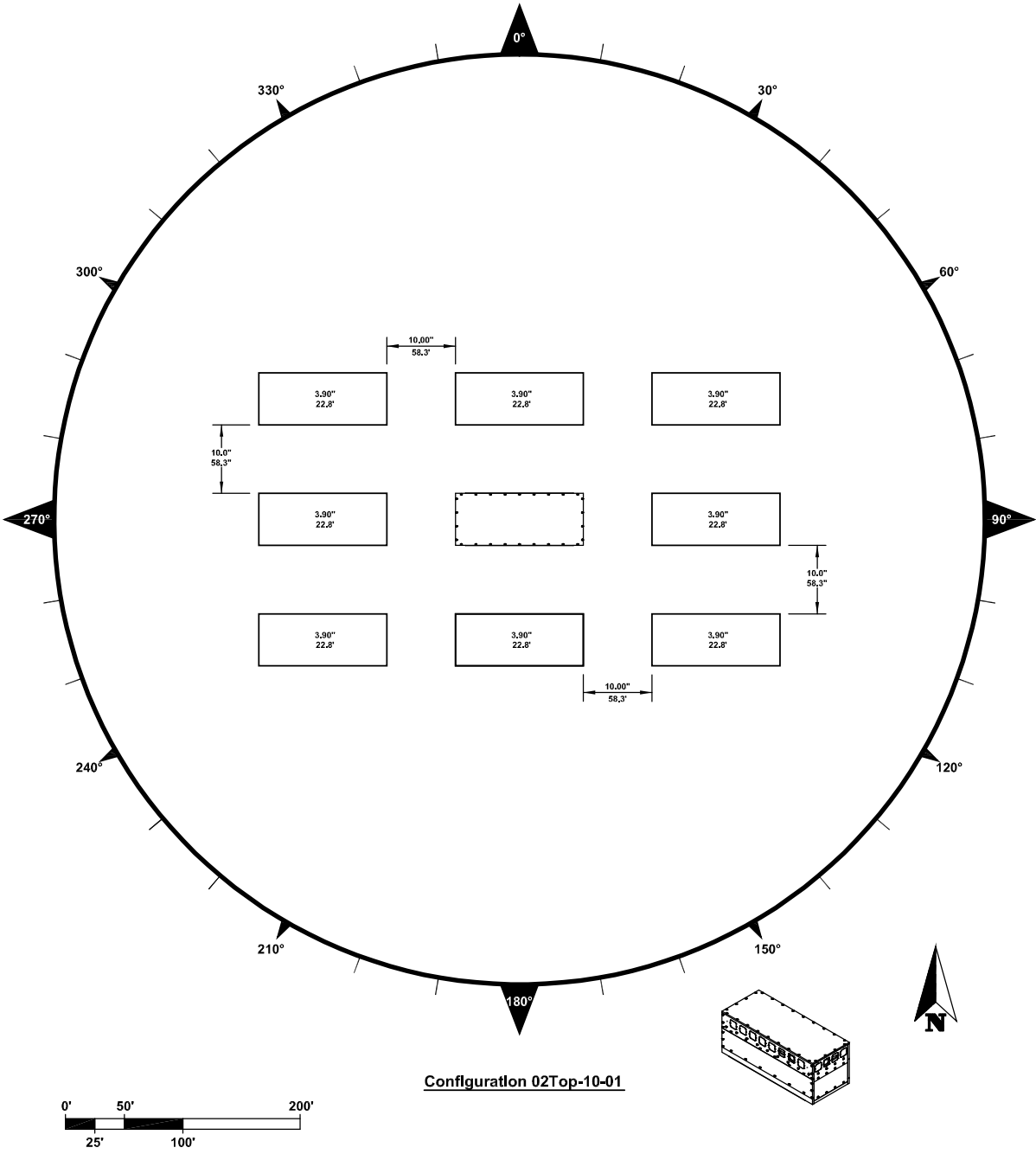

Source: CPP Wind Engineering

Figure 5.20: 4-Story Top Window Level Building Shape With 4-Story Surrounding Model and 10in Road Width Turntable Layout

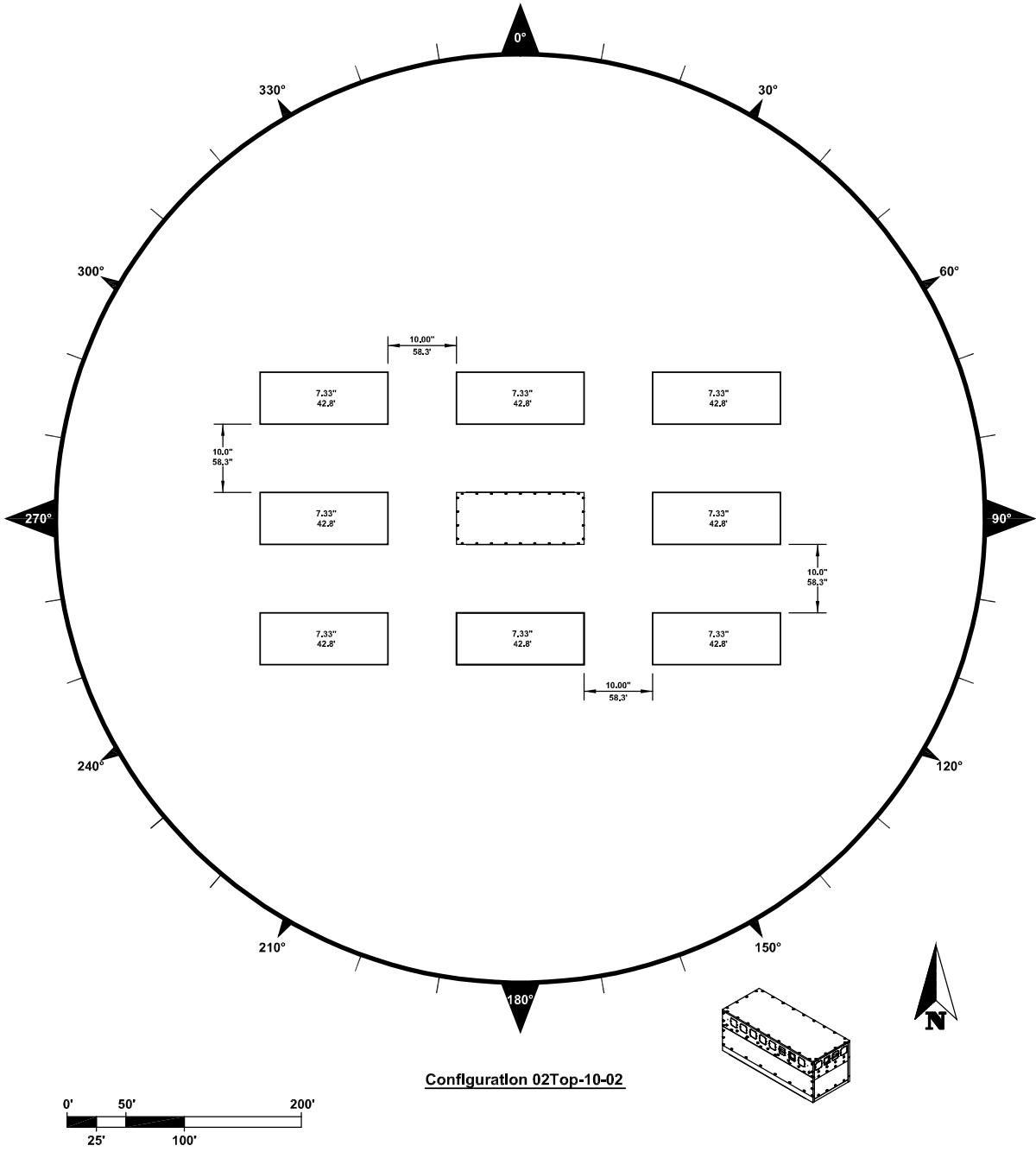

Source: CPP Wind Engineering

Figure 5.21: 4-Story Top Window Level Building Shape With 2-Story Surrounding Model and 20in Road Width Turntable Layout

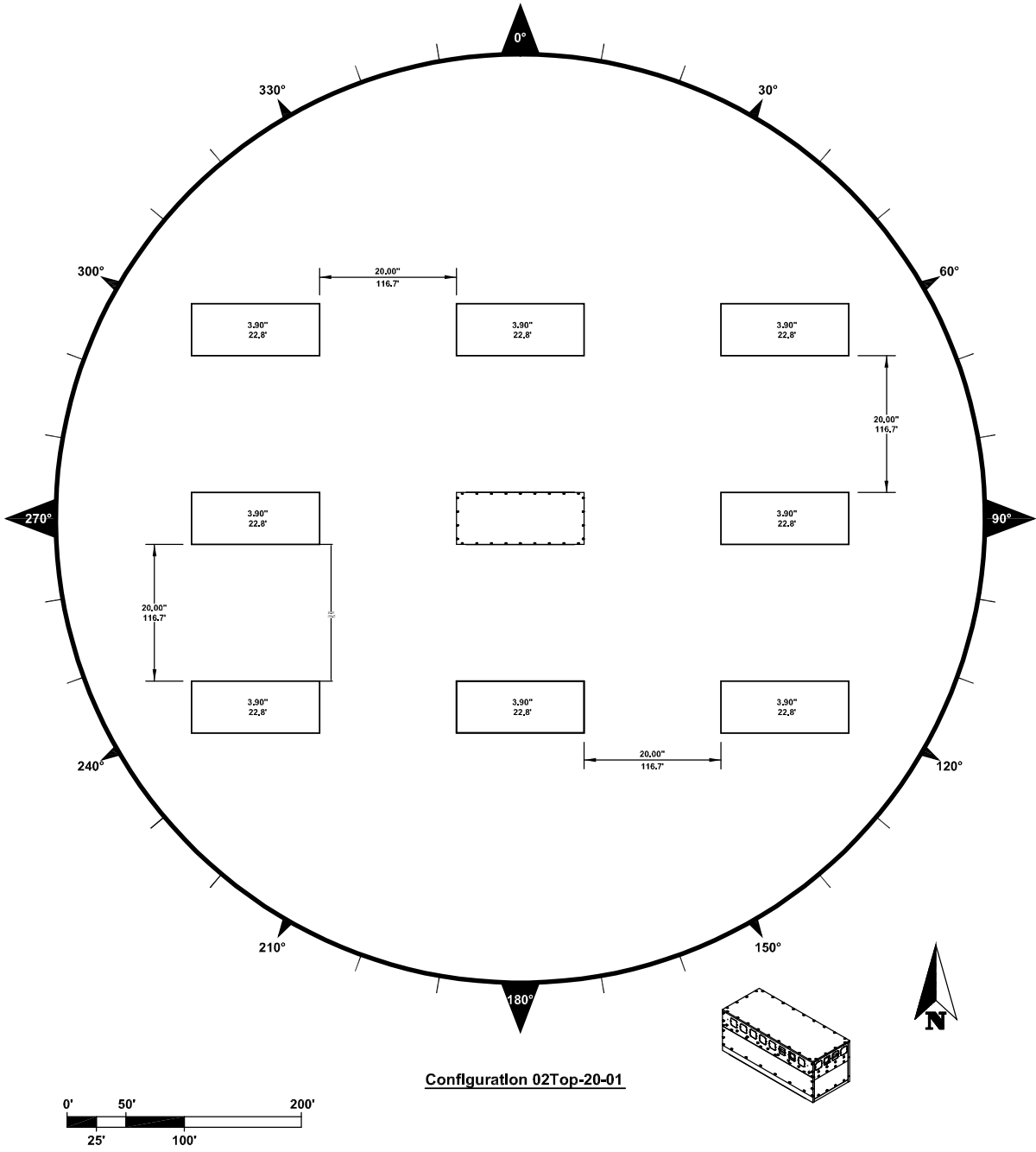

Source: CPP Wind Engineering

Figure 5.22: 4-Story Top Window Level Building Shape With 4-Story Surrounding Model and 20in Road Width Turntable Layout

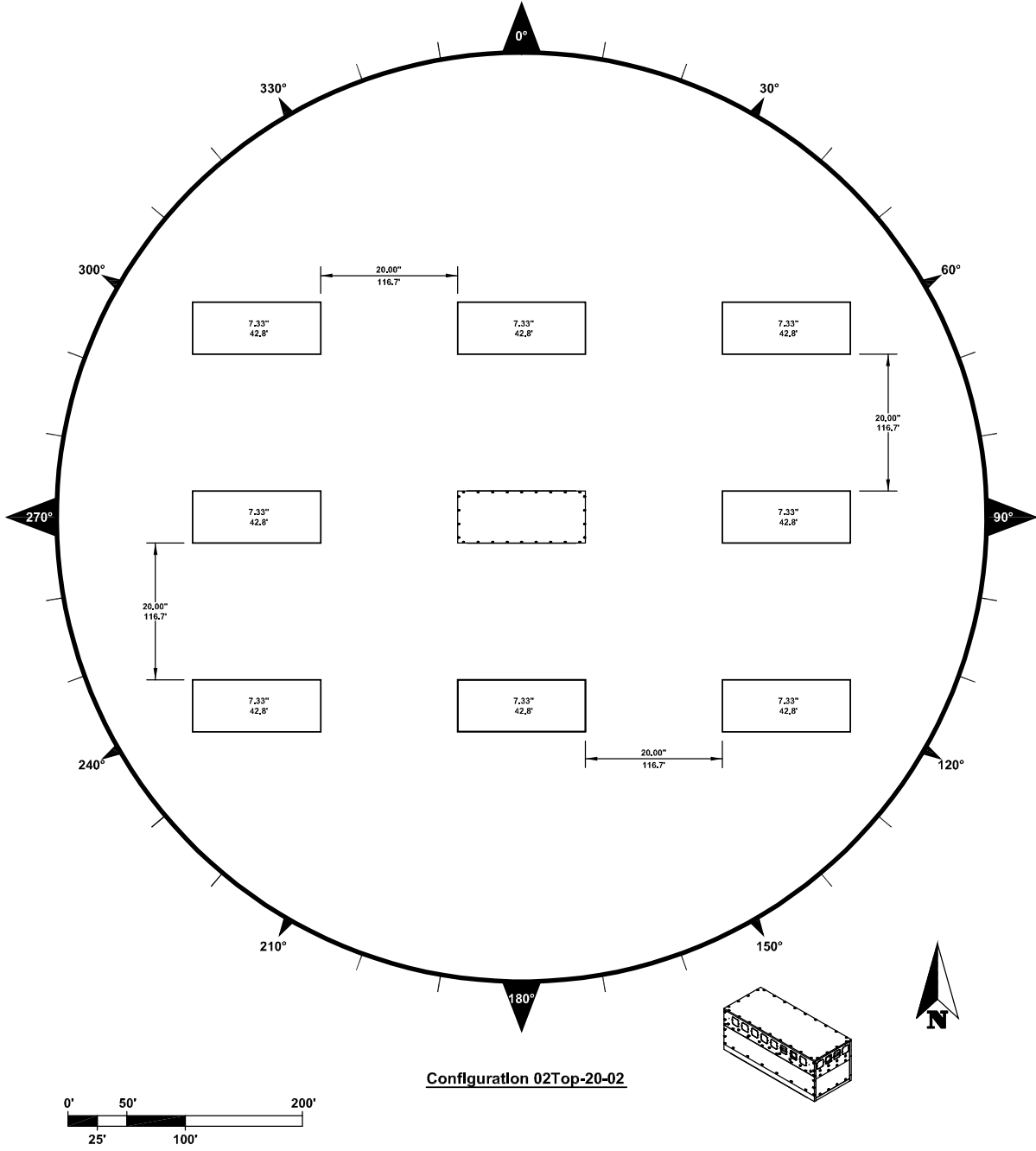

Source: CPP Wind Engineering

Figure 5.23: 4-Story Bottom Window Level Building Shape With 2-Story Surrounding Model and 10in Road Width Turntable Layout

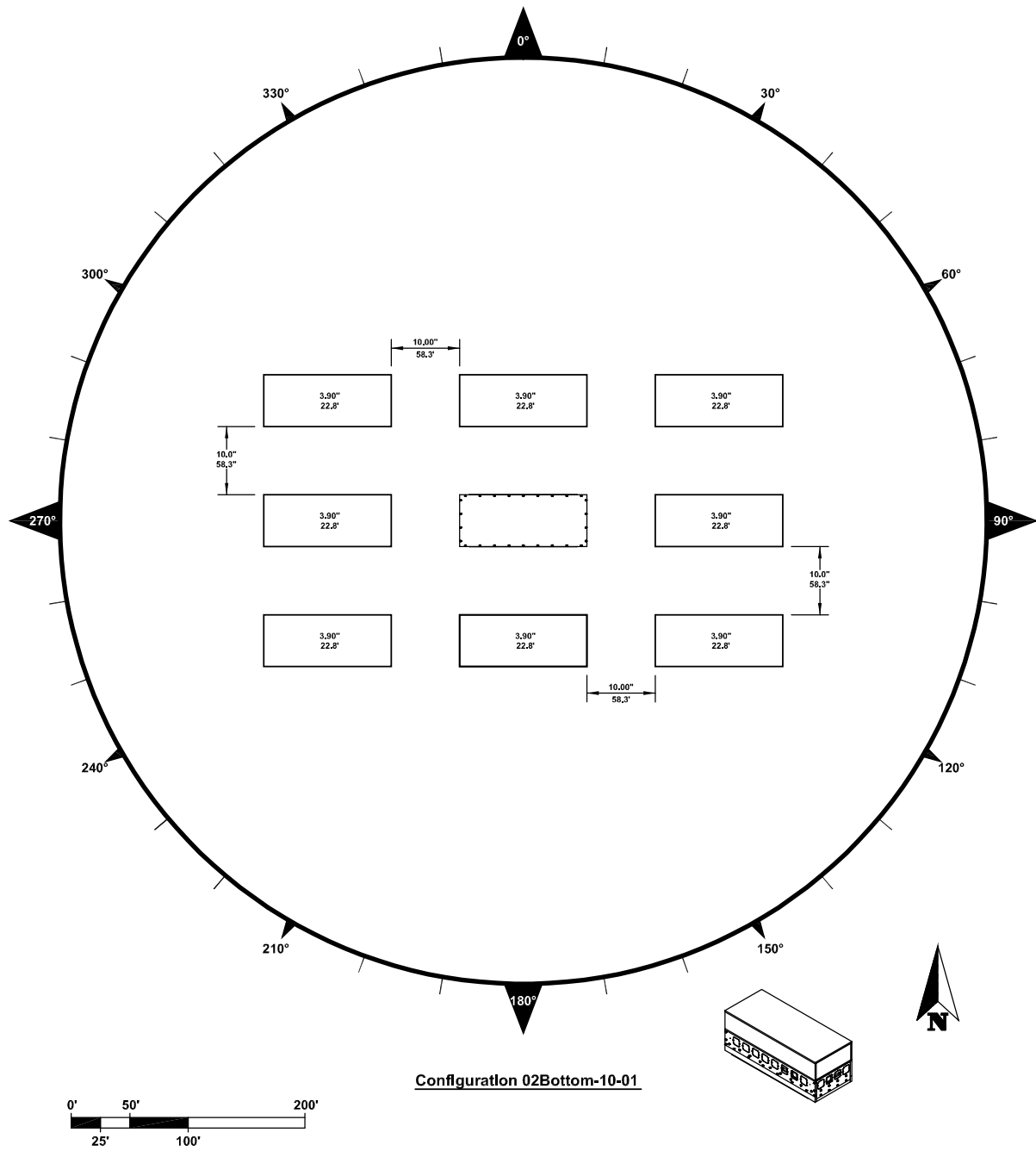

Source: CPP Wind Engineering

Figure 5.24: 4-Story Bottom Window Level Building Shape With 4-Story Surrounding Model and 10in Road Width Turntable Layout

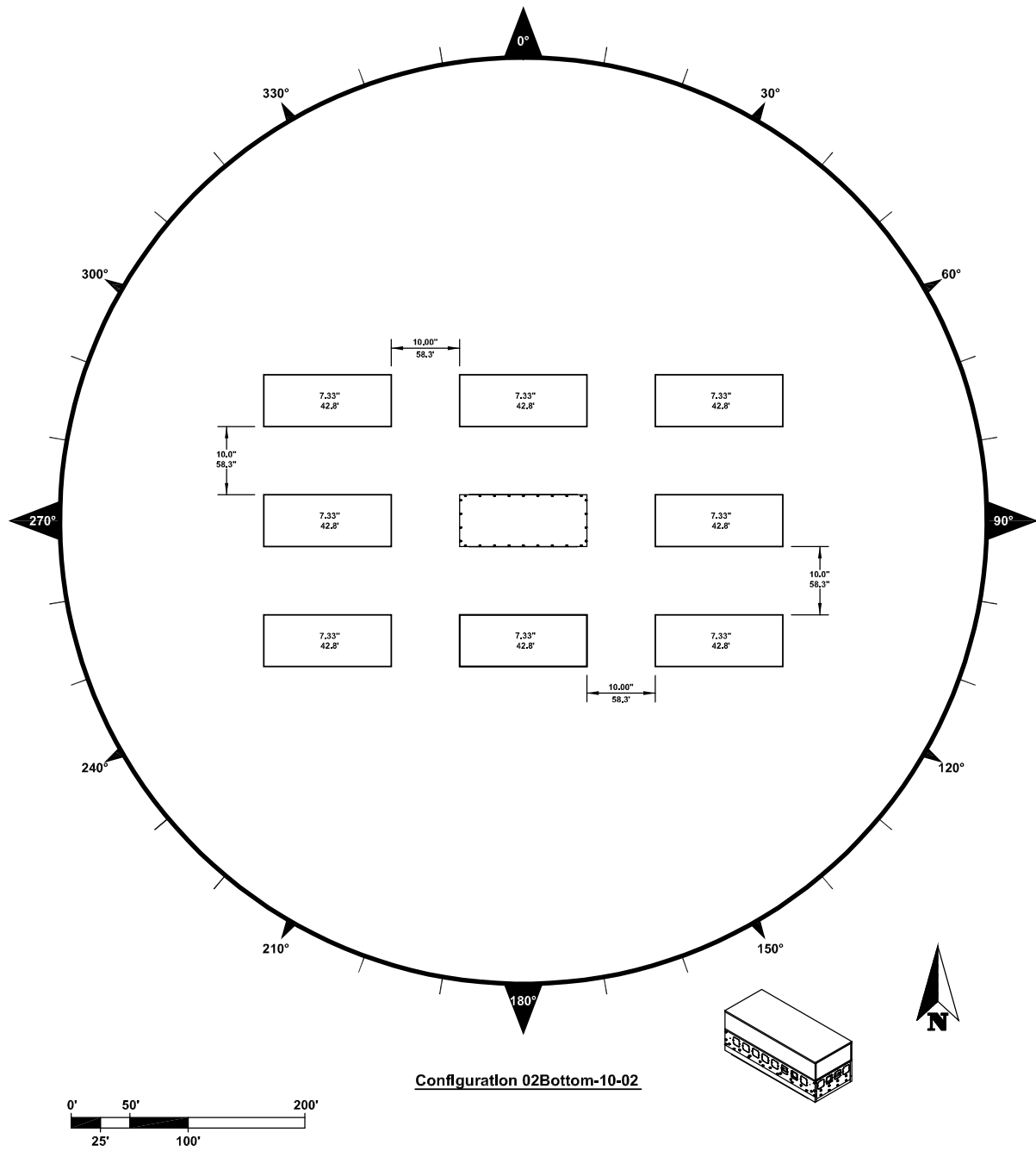

Source: CPP Wind Engineering

Figure 5.25: 4-Story Bottom Window Level Building Shape With 2-Story Surrounding Model and 20in Road Width Turntable Layout

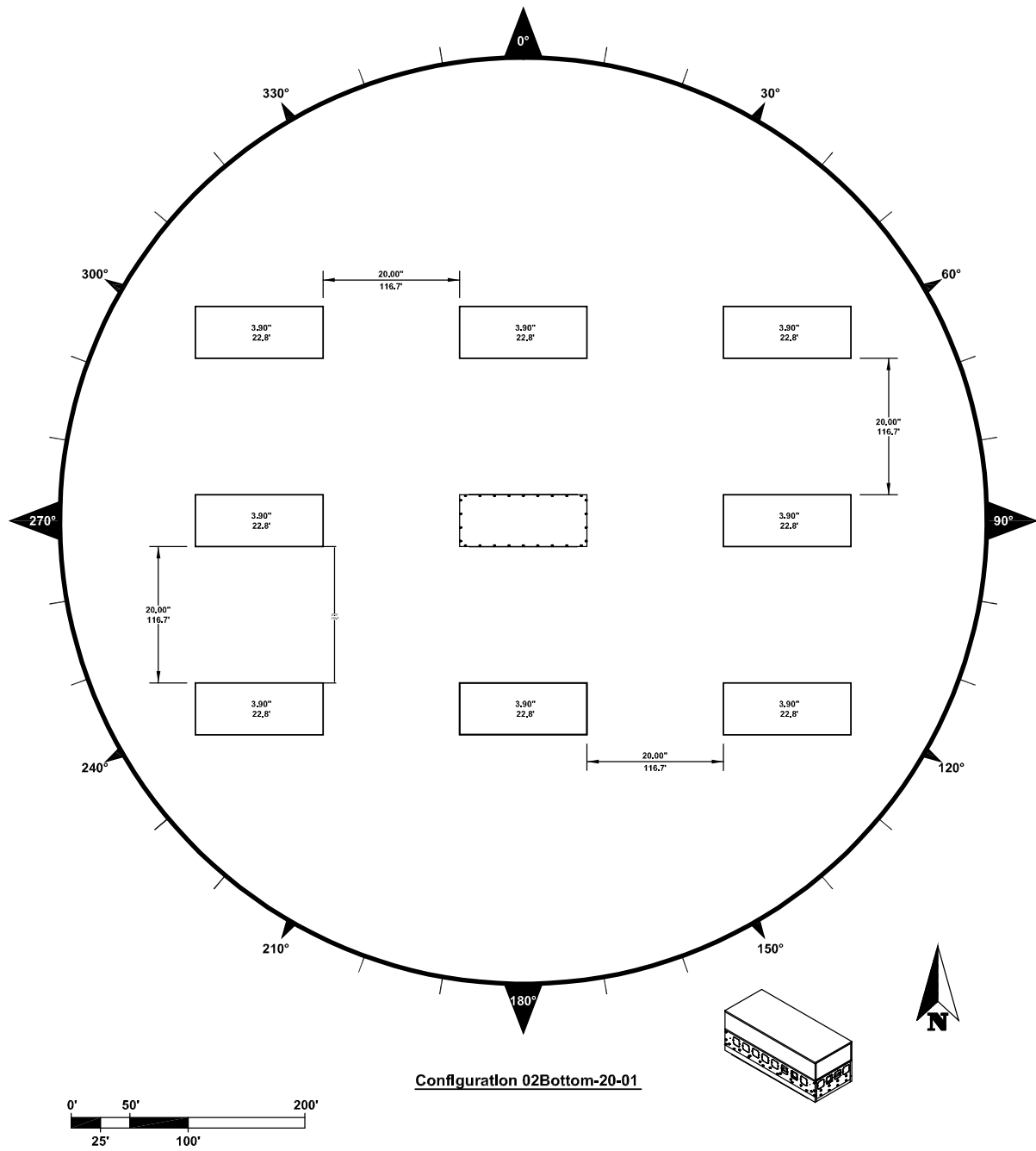

Source: CPP Wind Engineering

Figure 5.26: 4-Story Bottom Window Level Building Shape With 4-Story Surrounding Model and 20in Road Width Turntable Layout

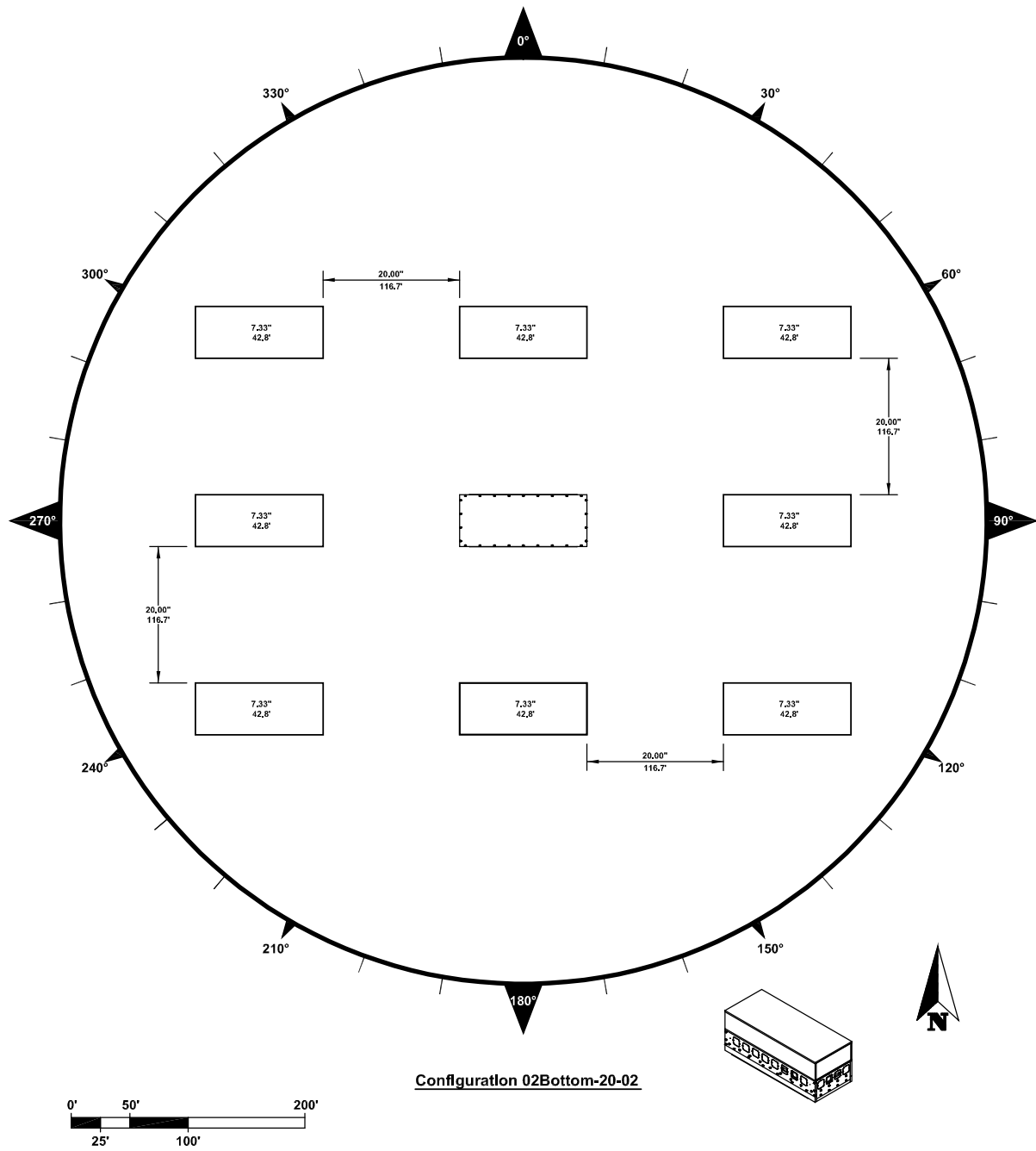

Source: CPP Wind Engineering

Figure 5.27: 2-Story Corner Building Shape Turntable Layout

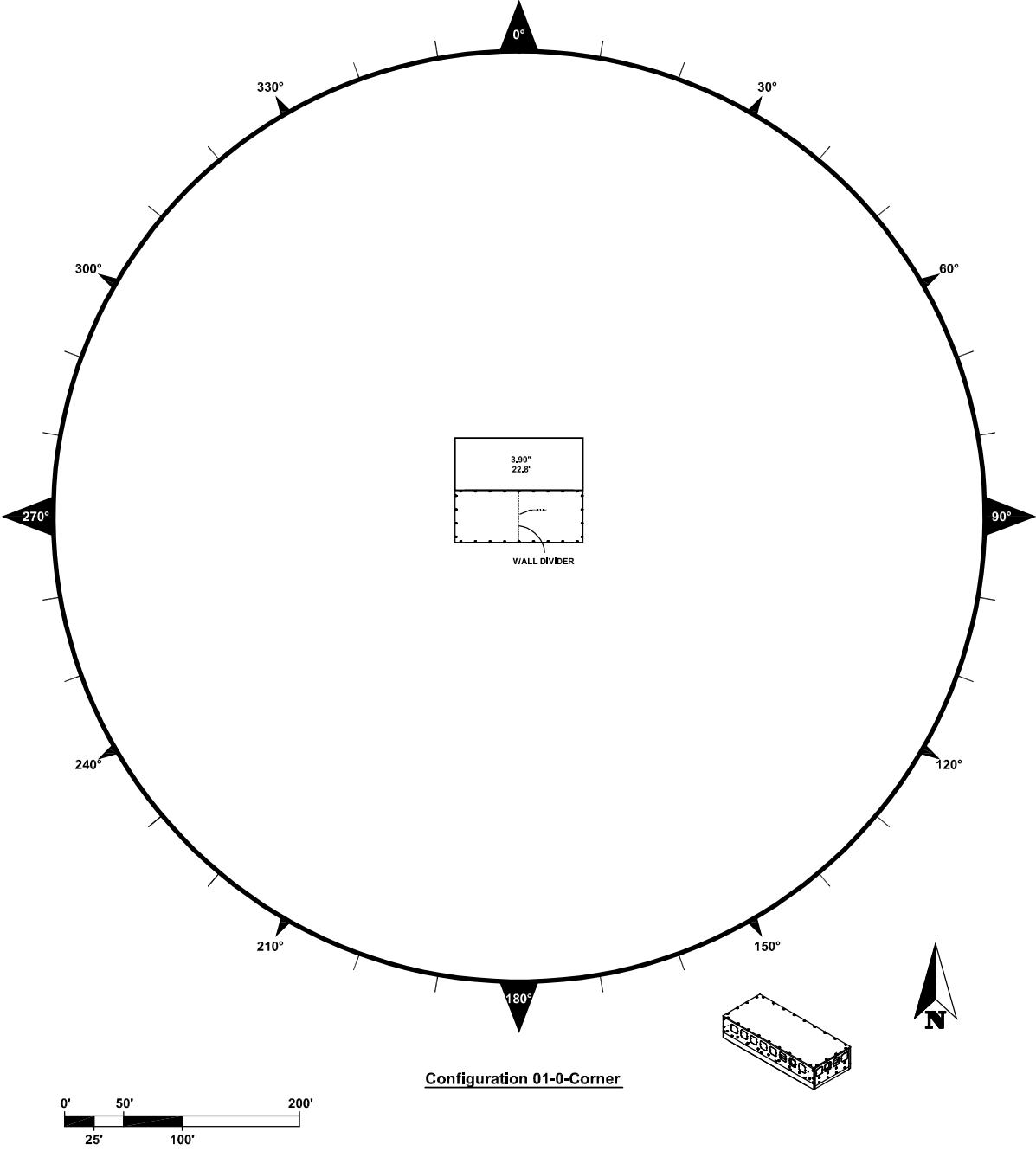

Source: CPP Wind Engineering

5.1.3.2 CEC Natural Ventilation – February 2012

Expanding on previous testing, the data collection initiated in February 2012 focused on a test building with a pair of windows located on both north and south building facades as well as a door located on the east face of the structure. Model surroundings were varied along with building shape for various window operating schemes. Data were collected for single sided ventilation, cross ventilation, and partially open window cases. Test iterations also included the Alameda Building model and site specific surroundings out to a radius of 326ft full scale. The wind tunnel layout for the Alameda Building case is shown in Figure 5.28 along with an overhead view of the building layout in Figure 5.29. Table 5.7 lists the building shapes tested along with their associated dimensions. Building Shape A, Building Shape C, roughness pegs, and the Alameda site model surroundings were tested for each building case.

Building layouts and turntable diagrams have not been included due to the large number of iterations. These layouts and diagrams are available by request. Numerous window combinations and dimensions were tested, resulting in approximately 200 unique building configurations for which pressure and concentration decay data were collected. Due to the number of iterations tested and the large variable space, a detailed test summary has not been provided, but is also available upon request.

Table 5.7: Test Building Dimensions – February 2012

Building Shape	Length (in)	Width (in)	Height (in)
A	7.7	18.7	3.9
C	7.7	26.7	3.9
D	7.7	30.7	7.6
E	15.7	30.7	7.6
F ²⁴	7.7	18.7	3.9
Alameda ²⁵	see note	see note-	see note-

²⁴ Modified window locations (building massing and layout available upon request)

²⁵ Based on full scale Alameda Building site

Figure 5.28: Alameda Test Building in Wind Tunnel – December 2011



Source: CPP Wind Engineering

Figure 5.29: Close-Up View of Alameda Test Building – December 2011

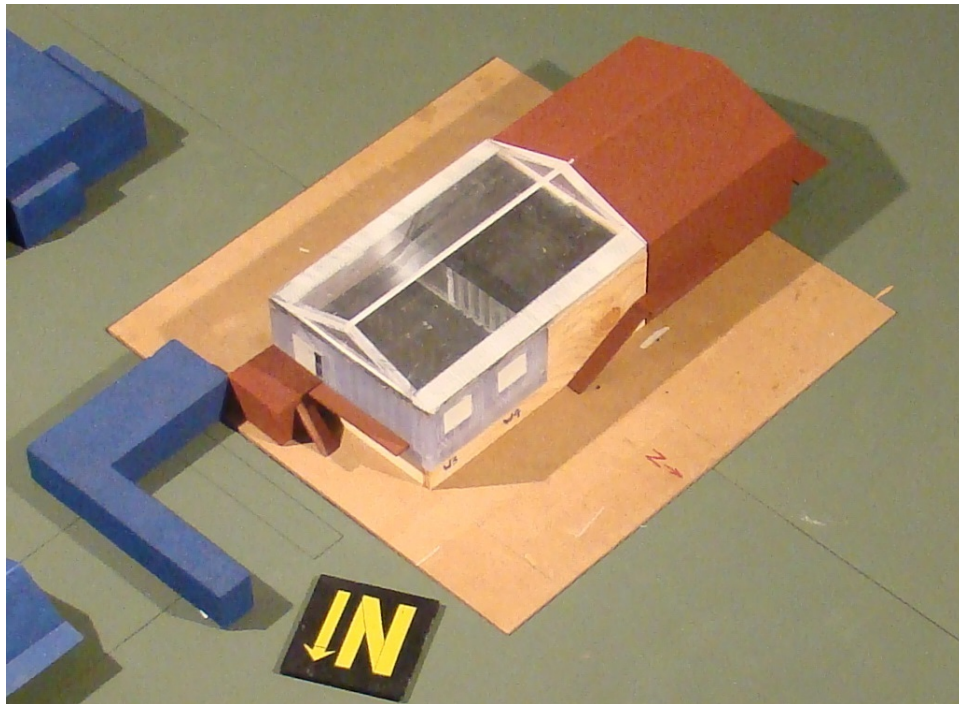

Source: CPP Wind Engineering

Figure 5.30: Close-Up View of W1, W2, and D2 on Alameda Test Building – December 2011

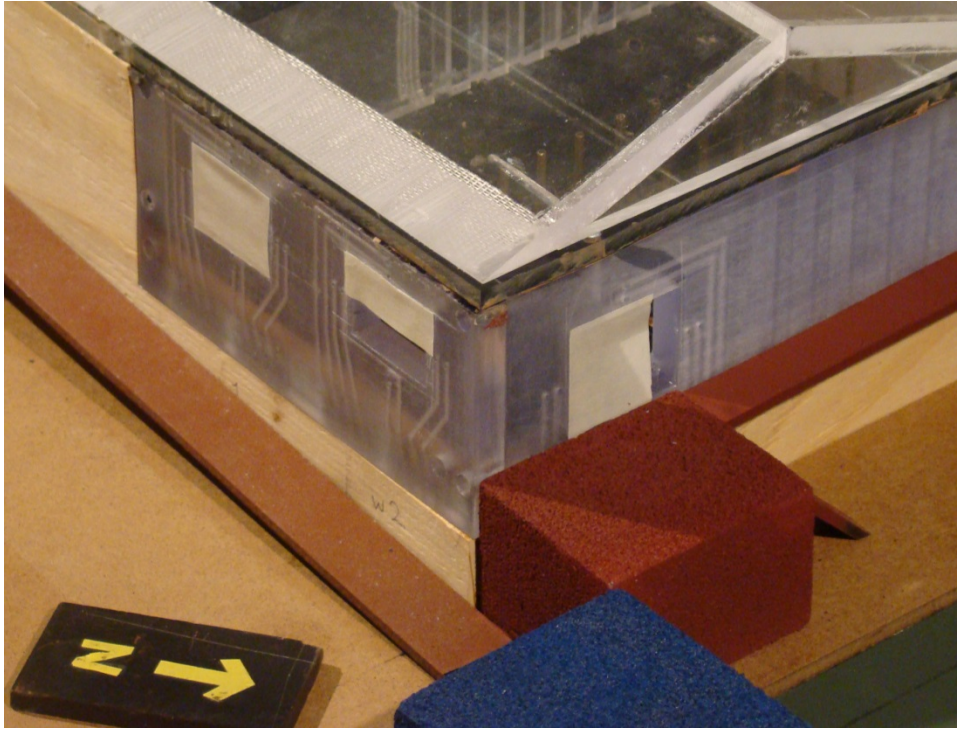

Source: CPP Wind Engineering

Figure 5.31: Close-up View of W3, W4 on Alameda Test Building – December 2011

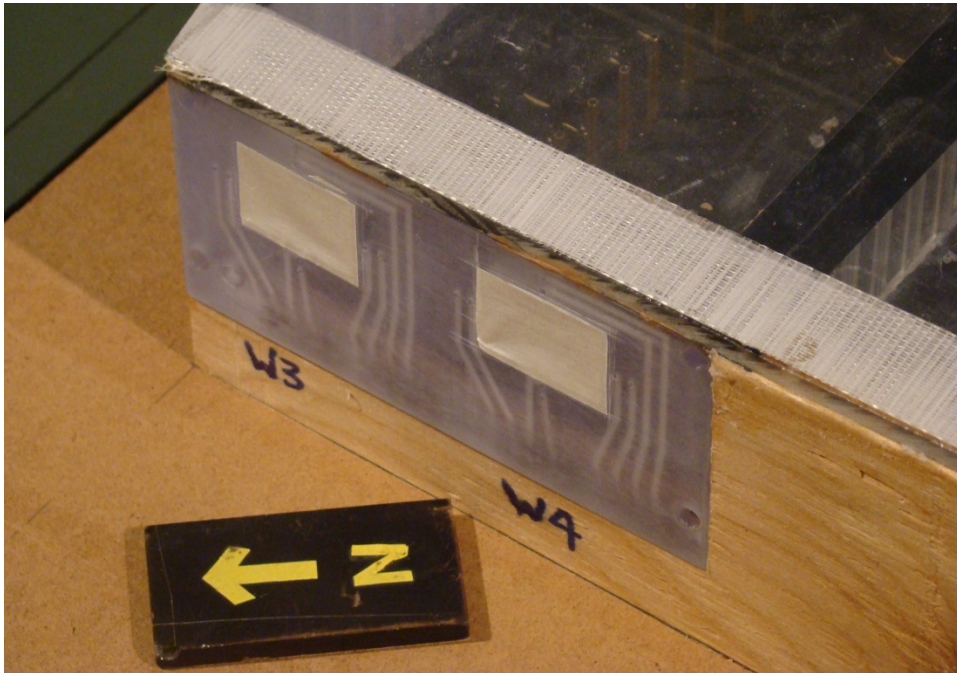

Source: CPP Wind Engineering

5.1.3.3 CEC Natural Ventilation – December 2011

The December 2011 natural ventilation tests were carried out on a test building with two windows located on the same face. Closed-cell foam was added to create the massing for different building shapes as shown in Figure 5.32 through Figure 5.34. During all tests, only a single window (rightmost) was open. Three building shape configurations were tested, their dimensions listed in Table 5.8. Building shape, room depth, receptor position, and wind tunnel fan drive frequency were varied during the test iterations. Peg roughness surroundings were used for all iterations. Flow visualization videos were recorded for most cases.

Table 5.8: Test Building Dimensions – December 2011

Building Shape	Length (in)	Width (in)	Height (in)
A	7.7	18.7	3.9
B	7.7	26.7	3.9
C	7.7	18.7	7.6

Figure 5.32: Building Shape A – December 2011

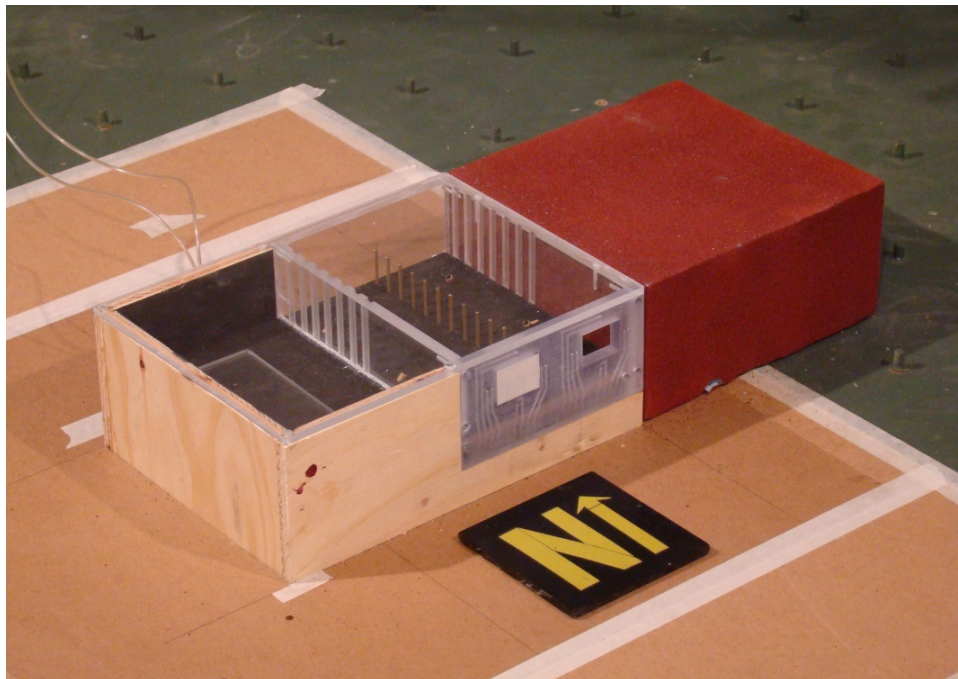

Source: CPP Wind Engineering

Figure 5.33: Building Shape B – December 2011

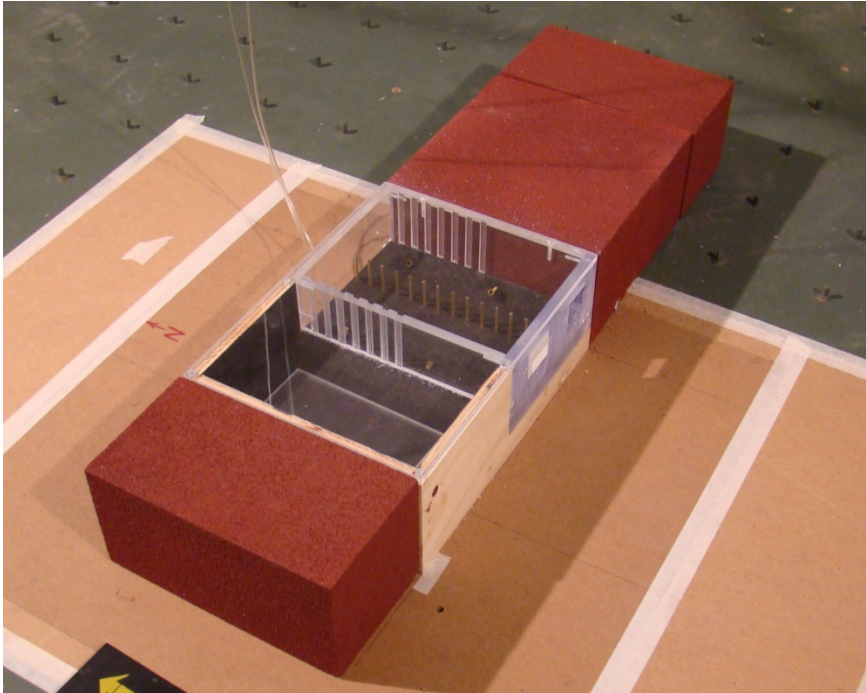

Source: CPP Wind Engineering

Figure 5.34: Building Shape C – December 2011

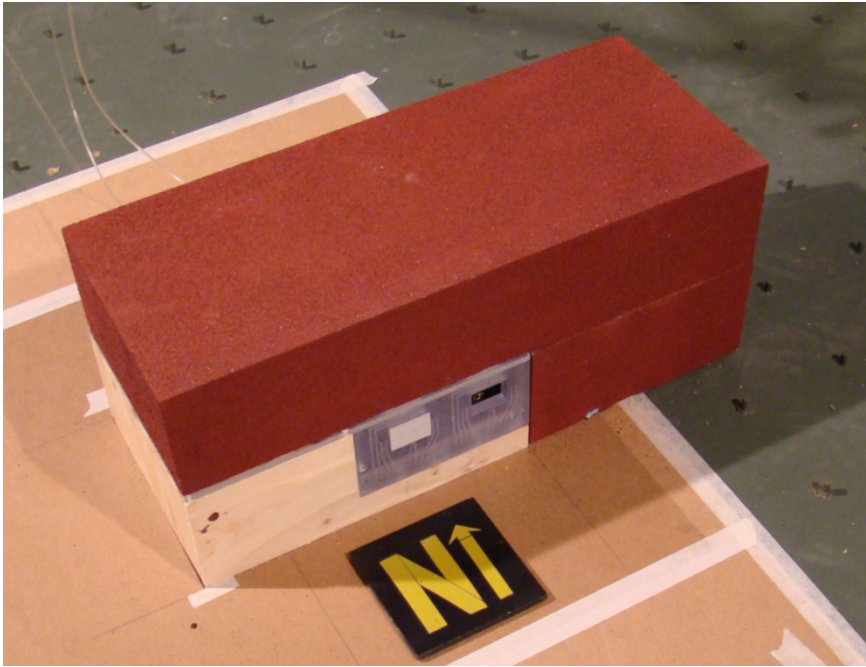

Source: CPP Wind Engineering

Table 5.9: Concentration Decay and Pressure Test Summary – December 2011

Azimuth (Increment)	Building Shape	Room Depth (in)	FID-1 Location	FID-2 Location	Drive Frequency (Hz)
0-180 (15)	A	7	12	3	35
0-180 (15)	A	7	3	12	35
0-180 (15)	A	4.9	6	12	35
0-180 (15)	A	3.4	9	12	35
90-180 (15)	A	7	1	10	35
90-180 (15)	A	7	5	8	35
135-180 (15)	A	7	3	12	20
135-180 (15)	A	7	3	12	50
0-180 (15)	B	7	3	12	35
0-180 (15)	C	7	3	12	35
0-180 (15)	C	3.4	9	12	35

5.1.4 Conclusions

Spanning 3 measurement campaigns, the CPP natural ventilation dataset is extremely rich and detailed. It has only been possible to present here an overview of the parameters which were varied in each campaign, and the nature of the available data. The interested reader is therefore referred to the web page <http://cec.cppwind.com> as the initial point of contact. From here they may obtain an Excel workbook listing all the tests carried out in each of the three principle campaigns. The complete time series – for concentration, pressure, and velocity, as applicable – would then be available for specific runs on request.

5.2 CFD simulations and Algorithm Development

The ultimate goal of Project 3 is the addition of improved and extended capabilities for predicting wind-driven natural ventilation to EnergyPlus through the incorporation of appropriate algorithms, developed in Task 3.3. The raw material for these algorithms comprises data, either experimental data from wind tunnels, say, or computationally-derived data from software simulations. It is the purpose of Task 3.2, together with the wind tunnel studies of Task 3.1, to provide that raw material. As a result this section discusses both the setting up and running of CFD simulations and the analysis of wind tunnel data, as appropriate.

This section is divided into 4 parts, each dealing with one of the four ventilation regimes illustrated in Figure 5.2:

5.2.1 Cross-ventilation

5.2.2 Single-sided ventilation with 1 aperture

5.2.3 Single-sided ventilation with 2 or more apertures

5.2.4 Corner ventilation

In each case the model developed for that regime is described along with the algorithms produced for implementation in EnergyPlus.

5.2.1 Cross-Ventilation

5.2.1.1 Introduction

With the widespread use of mechanical air conditioning, natural ventilation has become a rare feature in the cooling and ventilation systems of modern commercial buildings. Yet in most of these buildings there is potential for energy savings and consequent reductions in greenhouse gas emissions from lower chiller and fan energy consumption. Most overhead mechanical ventilation cooling systems use inflow air temperatures of 15°C. Ventilation fan induced heating and heat transfer in ducts results in a temperature increase of up to 5°C between cooling coil and inflow into the conditioned space, creating a need for active cooling even when the outside air temperature is as low as 10°C. The combination of these inflow conditions and the need to prevent overheating result in an opportunity for natural ventilation based cooling whenever the outside air is between 10° and 25°C (CEN, 2007). Clearly, in hot climates, cooling by natural ventilation cannot fully replace mechanical systems. For this reason, the recent resurgence in natural ventilation relies on systems whose performance can be predicted and controlled, often in hybrid configurations where active cooling and mechanical ventilation is available when needed. In this contemporary approach, natural ventilation can deal with thermal and air renewal requirements in the cold and mild seasons but has a more limited role in summer when warmer outside air leads to overheating.

This section focuses on the first of the natural ventilation regimes illustrated in Figure 5.2, namely cross-ventilation. In this regime, flows are characterized by significant inflow velocity conservation as the air flows through façade openings as an approximately axisymmetric jet. This feature is essential to guarantee that the air effectively sweeps across the room before dissipative effects become dominant. In contrast with displacement ventilation (Linden, 1999), which is used in both mechanical and natural ventilation systems, CV is mostly used in natural ventilation because the large zone airflow velocities, typically above 0.3m/s, are unacceptable in a mechanically-conditioned environment (ASHRAE, 2010).

The CV airflow pattern in a room of width W , height H and depth D , depends on the dimensionless ratio between the inflow area and the room cross-section, $A' = A_{in}/A_{RM}$ (Carrilho da Graça & Linden, 2003), where the cross-sectional area is $A_{RM} = W \cdot H$. For $A' > 0.5$ the flow is unidirectional and the room volume is predominantly occupied by an expanded jet, while for lower area ratios, the flow exhibits one or more recirculation regions as the air entrained by the jet returns to the inflow region to be re-entrained (Carrilho da Graça, 2003). Figure 5.35 shows a laser-induced fluorescence flow visualization of a water model used to study two-dimensional CV flow, clearly showing the two flow components: the jet, which is the dark region in the center of the image, and the recirculation regions on either side of the jet (Maurel *et al.*, 1996).

Modern buildings create increased isolation from the outside environment. This trend is also apparent in current CV designs: while traditional natural ventilation systems tended to use large openings (1-4m²), recent and foreseeable future systems tend to use smaller openings (0.2-1m², leading to $A' \ll 0.5$). The contrast is clear: whereas a traditional system using a 1.5m² inflow area in a 30m² room implies $A' = 0.05$, contemporary systems rely on multiple inflow configurations that allow for efficient heat removal with controlled indoor airflow velocities, leading to a typical $A' \sim 0.01-0.02$ (Zhai *et al.*, 2011). Further, for the typical airflow velocities and aperture dimensions used in building ventilation, the CV flow is invariably turbulent ($v \approx 0.5\text{m/s}$, $A_{in} \approx 0.5\text{m}^2 \Rightarrow \text{Re} > 10^5$).

Figure 5.35: Top View of a Cross Ventilated Cavity With $A' < 0.5$

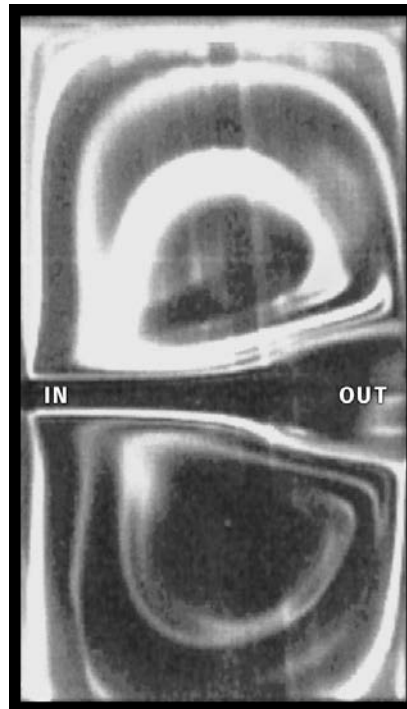

The water entrained by the jet is detrained at the outlet, creating two recirculation zones.

Source: J.E. Wesfreid.

Currently, designers of CV system have three possibilities to predict the ventilation performance of a given room/window configuration (listed here in order of increasing cost): simplified models implemented in dynamic thermal simulation tools, CFD modeling (Carrilho da Graça *et al.*, 2004; 2012) and wind tunnel scaled models (Lo *et al.*, 2013). Wind tunnel tests can be time consuming, expensive and are generally limited to inflow velocity and surface pressure measurements (although, in more complex setups, a non-buoyant tracer gas can be used to study indoor pollutant effects). Although CFD is becoming more widespread, and is expected to play an increasing role in ventilation design in the next decades, it is still not fast enough to be used in whole year simulation design scenarios. Simplified models implemented in dynamic thermal simulation tools are the most accessible option for design and building energy

certification. Furthermore, a successful simplified model requires careful analysis that results in increased insight and understanding of the design parameters that control the room flow field and air temperature.

The goal of the research presented in this section is to develop a simplified CV flow model, extending the applicability of the existing large single-opening model (Carrilho da Graça & Linden, 2003; Carrilho da Graça, 2003) to smaller and multiple-inflow openings, as well as to wind that is not perpendicular to the inflow façade. We begin with a review of existing models for the two flow components (jet and recirculation), followed by experimental measurements and CFD simulations of CV flows. Subsequent sections present the proposed modeling approach and the CFD simulations used to test the modeling assumptions and obtain the model correlation constants. These results are then extended to allow for multiple inlet configurations and wind directions.

The two-zone CV flow model presented in this section consists of analytical expressions to predict characteristic velocity and temperature variation in the two flow regions using as inputs the inflow velocity, internal gains, and relevant room geometry parameters that are available in contemporary dynamic thermal simulation software such as EnergyPlus (Crawley *et al.*, 2001). The model is developed using dimensional analysis, flow similarity, and sensible heat conservation, experimental results and CFD simulations. Although the proposed model approach is zonal, the model cannot be characterized as a ‘zonal model’ because it does not rely on low velocity zones where simplified flow equations apply and are solved numerically (Inard *et al.*, 1996).

5.2.1.2 Previous Research

In this section we review numerical, experimental and full-scale studies of CV flows with recirculation regions from the literature.

(a) CFD Simulations

Existing comparisons between experimental CV flows and Reynolds-averaged Navies-Stokes (RANS) CFD simulations provide guidance on the turbulence models that lead to the lowest error in predictions of internal airflow velocities for this type of flow. A recent RANS study on wind-driven CV for an isolated cube (Ramponi & Blocken, 2012), based on existing measurements (Karava *et al.*, 2011), indicated that the SST (shear-stress transport) $k-\omega$ model had a better capability to predict the direction of the inflow jet (due to improved capacity to predict external detached flows). Another recent comparison by van Hooff *et al.* (2013) showed that, for a transitional wall jet with a recirculation, the SST $k-\omega$ model gave the best results. Evola & Popov (2006) compared the standard $k-\varepsilon$ and RNG (renormalization group) $k-\varepsilon$ models for prediction of internal CV flows in a wind tunnel scaled model, concluding that the RNG model is superior to the standard $k-\varepsilon$ model. Stavrakakis *et al.* (2008) obtained a similar conclusion in a CFD validation based on a full-scale isolated single zone CV building. Chen (1995) studied five variants of the $k-\varepsilon$ model for internal natural and mixed convection predictions, including a case with a jet and recirculation, concluding that the standard $k-\varepsilon$ and RNG $k-\varepsilon$ were the better performing models. CFD has also been used to study CV

configurations with multiple inflow jets: Lai & Nasr (1998) performed a successful validation of CFD (with the standard, RNG and Reynolds-stress $k-\varepsilon$ models) for simulation of 2-D CV flows with merging plane jets, while Karimpour *et al.* (2011) used the standard $k-\varepsilon$ model to study the merging distance for two parallel plane jets, obtaining good agreement.

(b) Experiments

In a recently published study, Bangalee *et al.* (2013) used water models and CFD simulations (RNG $k-\varepsilon$ turbulence model) to study three-dimensional CV flows with recirculation regions, concluding that, as a result of increased exposure of the indoor volume to the inflow jet, configurations with multiple inflow windows had increased capacity to remove indoor pollutants compared with single inflow configurations. Karava *et al.* (2011) studied a wind tunnel scaled model of an isolated single-room CV building with variable opening areas and positions, showing that momentum conservation between inflow and outflow can lead to an increase in the overall flow rate that cannot be predicted using the aperture-equation-based approach. This effect, initially identified by Kato *et al.* (1992) and quantified by Carrilho da Graça (2003), is only present when three simultaneous conditions occur: the inflow faces the outflow, the outflow velocity is at least half of the inflow velocity and the outflow area is much larger than the inflow area. As discussed above, as a result of smaller aperture areas, these conditions are unlikely to occur in contemporary CV applications.

(c) Analytical Solutions

Although there is no analytical solution for a complete CV flow, the literature contains analysis relevant to its component parts. Consider first the jet region. For the simpler case of an unconfined axisymmetric jet there is a solution for the jet velocity profile in the self-similar region that occurs after the initial potential core shear layer development region (approximately six diameters from the outlet, see Figure 5.36). If this solution is applicable to the confined jets that are found in CV then the average jet velocity and air entrainment rate can be calculated in a straightforward way. Several authors have studied its applicability to confined jet flows. Initial work on simplified analytical modeling of turbulent confined jets focused on comparison of experimental studies with simplified solutions of the mass and momentum conservation equations with application in industrial furnace optimization (Curtet, 1958; Becker *et al.*, 1963). In these cases the jet flows into a co-flowing stream with variable velocity. When the co-flow velocity is low the flow field displays axisymmetric recirculation regions surrounding the jet. More recently, Liu *et al.* (1997) performed an experimental study on turbulent air jets confined by cavities with variable diameter with the goal of predicting orifice size in cardiovalvular regurgitation using measured average jet velocity. In this study A' varied between 0.035 and 0.25 providing some overlap to the range relevant to natural CV discussed above. The study concluded that free jet self-similar solutions can be applied to the core region of the confined jet, with a small correction factor to increase velocity decay for the cases with larger jet to cavity diameter ratios ($A' > 0.1$, in order to model the increased momentum dissipation at the cavity walls). This approach is promising for modeling the jet portion of the field in natural CV because, as a result of the lower A' values that are common in these cases, it is likely that the confinement correction will be negligible.

Figure 5.36: Schematic of the Development of a Jet From Airflow Through a Window

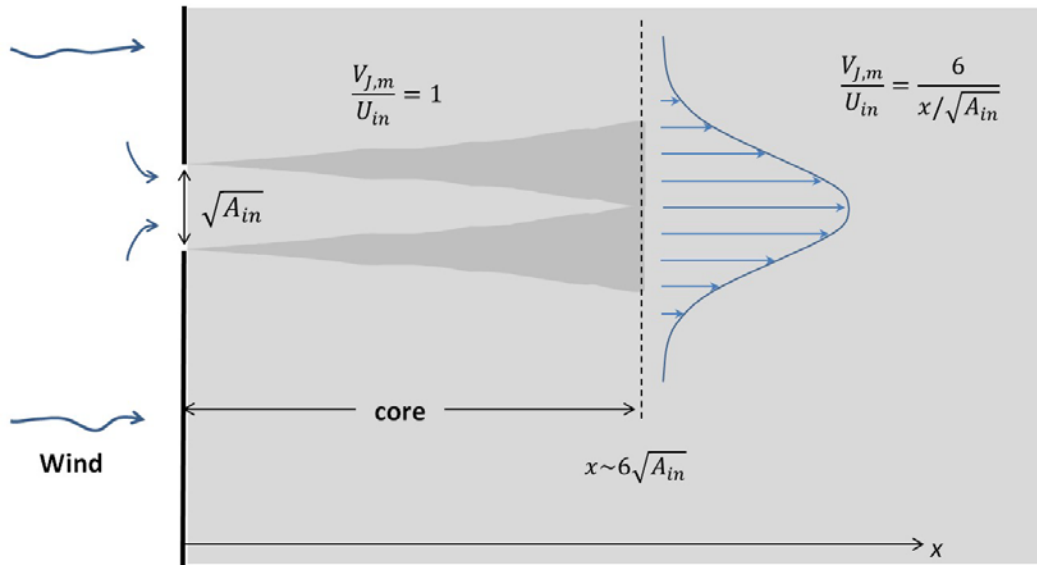

After the initial development in the 'core' region, the jet transitions into the axisymmetric decay region.

In the recirculation regions, simplified modeling of this part of the flow is difficult because it is a secondary flow feature, driven by momentum transfer in the shear layer at the edge of the jet (Carrilho da Graça & Linden, 2003). However, the geometry and behavior of the flow in these regions resembles a lid-driven cavity flow or LDCF (Shankar & Deshpande, 2000), a configuration that has been extensively studied, both numerically and experimentally. A LDCF is the recirculating flow that results from a 'lid' driven across the open face of a cavity at a constant velocity. Prasad & Koseff (1989) used a water model to investigate transitional LDCF flows ($Re = 3200$), concluding that these flows exhibit self-similar velocity profiles. Figure 5.37 compares the recirculation region velocity profile from their experiments with experimental results for a 2-D CV flow at $Re = 2500$ (van Hooff *et al.*, 2013), and confirms the similarity between the recirculation flow that results from these two, apparently different, geometries: the average ratio between maximum velocity in 2-D jet and maximum velocity in recirculation is approximately 4.5 in the LDCF and 4.4 in the 2-D CV flow (Figure 5.37).

Figure 5.37: Comparison Between Measured Velocities in a LDCF and CV Flow

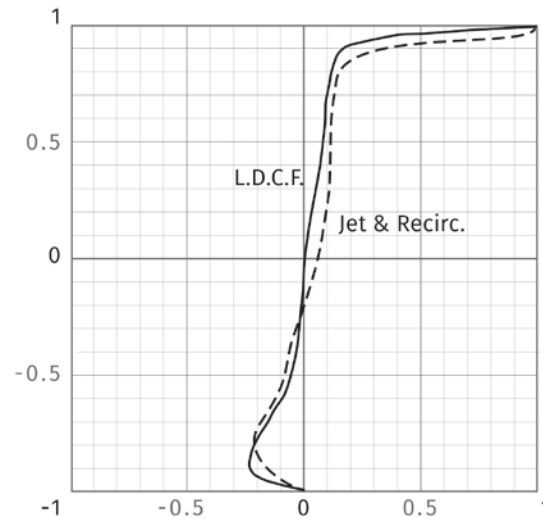

Horizontal axis: non-dimensional x velocity. Vertical axis: non-dimensional depth in the cavity (the cavity lid, $y = 1$, cavity wall, $y = -1$). LDCF data from Shankar & Deshpande (2000), CV data from van Hooff *et al.* (2013)

5.2.1.3 Modeling Approach

The main hypothesis of the proposed simplified two-zone model is the characterization of the CV flow as an axisymmetric free jet driving the recirculation regions into a lid driven cavity flow (Figure 5.38). This hypothesis involves three main premises:

- The jet region of the flow can be characterized using an unconfined jet solution (as shown by Liu *et al.*, 1997).
- The flow in the recirculation regions is similar to a LDCF.
- Buoyancy effects can be neglected.

The interrelation between jet and LDCF is apparent in the increased entrainment of the confined jet relative to a free jet (Carrilho da Graça & Linden, 2003). This increased entrainment is visible in the time evolution of the jet volume flux after it enters an initially stagnant cavity: Figure 5.38 shows the predicted variation of the jet flow rate along the depth of CV room, as calculated in a transient CFD simulation, using the RNG $k-\epsilon$ turbulence model. Initially, near the inlet, the recirculation regions that form in the space between the jet and the lateral walls are driven by momentum flow from the confined jet just like the entrainment process that occurs in a free jet. Before the jet leaves the room it rejects the entrained flow, which is then re-entrained by the jet.

In the case shown in Figure 5.38 the ratio between jet overall flow rate and inflow rate is 6.4 versus 4.3 for the classical non-confined entrainment solution (Ricou & Spalding, 1961), an increase of approximately 50% due to the cumulative buildup of jet entrainment in the recirculation regions. This result shows that the flow in the recirculation regions is under-

predicted using unconfined jet entrainment theory; further, as shown in Figure 5.37, the recirculation flow is similar to the LDCF profile.

The role of each approach in the model is discussed in the next sections.

(a) Dimensional Analysis

The purpose of dimensional analysis is to identify the minimal set of variables that can be combined into non-dimensional variables used to characterize the flow in the analytical model expressions that will be developed.

The parameters that we propose to use in the non-dimensional analysis are: the room depth D (i.e. the distance from the inflow to the outflow vents), room cross-sectional area A_{RM} , and the inflow aperture area A_{in} . With these parameters we compose two non-dimensional variables that are used in the model:

$$D' = \frac{D}{\sqrt{A_{in}}}, A' = \frac{A_{in}}{A_{RM}} \quad (5.1)$$

The length $A_{in}^{1/2}$ is an effective diameter for the inlet, and characterizes the jet geometry. D' is a direct analog of the normalized coordinate along the jet trajectory, $x' = x/A_{in}^{1/2}$, that is used in free jet flow characterization (see Section 5.2.1.3(c), below). The simplified nature of the model excludes detailed geometric aspects, such as the shapes of the apertures, their positions in the façade, and alignment between inflow and outflow.

Figure 5.38: Time Evolution of the Flow Rate of a Jet Entering an Initially Stagnant Cavity

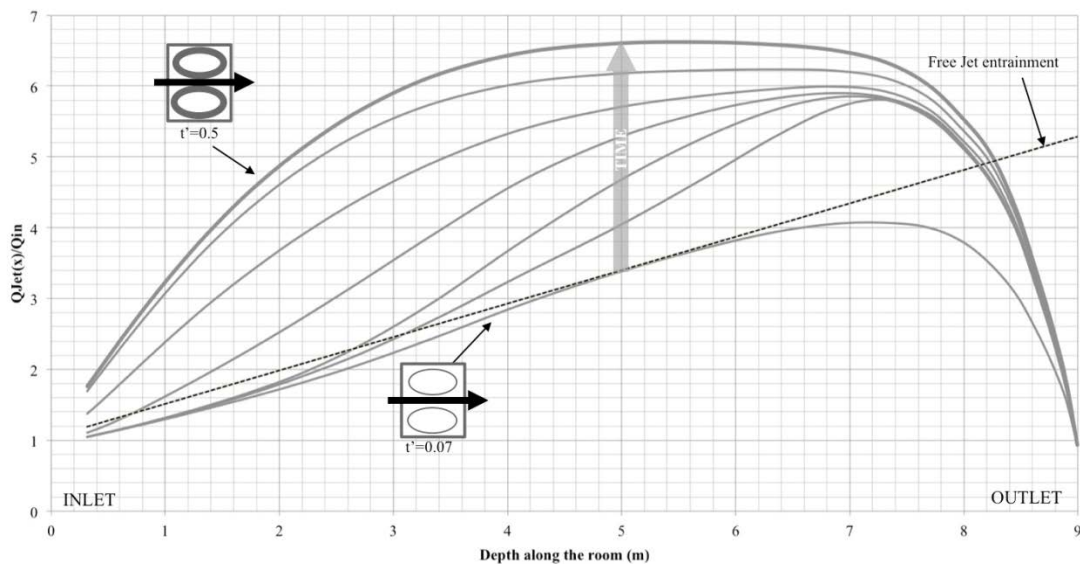

This process builds up a rotating flow in each recirculation region that increases in velocity and flow rate until it reaches a point where the momentum flux in the jet is balanced by the momentum sinks in the cavity walls. The recirculating velocity field stabilizes in an equilibrium between the jet momentum source and the viscous dissipation momentum sinks (in the room surfaces). In the figure, non-dimensional time $t' = t/FT$, where the flushing time $FT = VRM/Q_{in}$. Room dimensions were $D = 9\text{m}$, $W = 13.5\text{m}$, $H = 2.4\text{m}$ and $A_{in} = 0.5\text{m}^2$.

(b) Flow Similarity

In the present context, the principle of flow similarity can be stated thus: for a given room geometry with a stable flow regime (laminar or turbulent), there is a unique linear relation between inflow velocity and airflow velocity in a given point in the flow, i.e.

$$V(x, y, z) = U_{in} \cdot F(x, y, z) \quad (5.2)$$

where the non-dimensional function F varies with room geometry, flow regime and position in the room. The coordinate system adopted has the x -coordinate along the room depth, the z -coordinate vertically upwards and the y -coordinate across the room. For the simplified two-zone model proposed in this study, the function F depends only on the region of the flow and the two non-dimensional variables A' and D' :

$$F(x, y, z) = C_n \cdot f(A', D') \quad (5.3)$$

where the constant C_n depends on the region of the flow and, in principle, can be obtained experimentally or from a numerical flow simulation (CFD).

(C) Jet and Recirculation Regions: Experimental Results (Self-Similar Velocity Profiles)

The characteristic velocity in the jet region is estimated from the free jet centerline velocity $V_{J,m}$ averaged along the room depth (Figure 5.36), for which analytical expressions are available. The initial portion of free jet flow, the potential core, extends up to $x = x_c \approx 6A_{in}^{1/2}$ and is characterized by shear layer development along the perimeter of the jet, so that here $V_{J,m} = U_{in}$. After this phase the jet transitions into a self-similar profile whose centerline velocity decays as $1/x'$ (Awbi, 2013). Thus

$$V_{J,m}/U_{in} = \begin{cases} 1 & x' \leq x'_c \quad (\text{potential core}) \\ K/x' & x' \geq x'_c \quad (\text{self-similar profile}) \end{cases} \quad (5.4)$$

A review of experimental studies of turbulent round jets (Kandakure *et al.* 2008) shows that typical values of K range between five and seven. The core region length x_c extends from the inflow point up to 5-10 inflow diameters (Pani, 1972). For simplicity, this study adopts an average value of 6 for both K and x'_c .

To estimate the average jet velocity we integrate along the depth of the room, including both the core region and the $1/x'$ velocity decay region, to derive an average maximum jet velocity, which will be used as the characteristic jet region velocity scale:

$$\overline{V_{J,m}} = U_{in} \cdot \frac{1}{D'} \left\{ 6 + 6 \cdot \ln \left(\frac{D'}{6} \right) \right\} \quad (5.5)$$

This expression is valid for rooms whose depth is larger than six jet characteristic diameters, a condition that holds true for all relevant model application cases (shorter rooms are usually served by smaller openings, thereby ensuring in practice the condition $D' > 6$).

Real inflow windows and doors have diverse shapes, ranging from a square opening to a vertical or horizontal slot. Pani (1972) and Winoto *et al.* (1991) studied the effect of variable

orifice shape in three-dimensional free-jet (with aspect ratios as large as ten) and proposed a small adjustment in the decay constant K of less than 10%. This small effect is ignored in the present model.

Analysis of the CFD CV flow simulations that will be presented in the next sections revealed that the room containment effect leads to higher velocities for cases that combine a large inflow opening with a small room cross-section area. To account for this flow containment behavior the model multiplies the average free jet velocity by the non-dimensional scaling parameter $A'^{1/2}$. From flow similarity one can expect flow velocity in the recirculation region to scale linearly with average jet region velocity.

The jet region is defined as the volume bounded at each point x along the room depth by the curve in the y - z plane where the jet velocity drops to 50% of its maximum centerline value. This ensures the jet region is a flow volume that is clearly dominated by the jet behavior. The recirculation regions are defined as all points in the flow where the x -velocity u is negative, i.e. its boundary corresponds to $u = 0$.

(d) The Combined Model

The model expressions combine the three approaches mentioned above. Volume-averaged jet region velocity is predicted using the following expression:

$$V_J = C_{V,J} \cdot U_{in} \cdot \frac{\sqrt{A'}}{D'} \left\{ 6 + 6 \cdot \ln \left(\frac{D'}{6} \right) \right\} \quad (5.6)$$

The correlation constant $C_{V,J}$ is needed because equation (5.5) predicts average maximum centerline velocity whereas V_J refers to a volume-average over the jet region. This constant is obtained from a set of CFD simulations presented below that also test the validity of the simplified formula proposed. Note that when $A' > 0.5$ the flow has no recirculation regions and scaling the jet velocity is much simpler: $V_J = Q_{in}/A_{RM}$.

The recirculation region is characterized by flow that moves backwards in the room. The hypothesis for scaling the flow in the recirculation region states that its velocity also scales with the driving jet velocity; therefore the model uses a similar expression for this region, but with a different correlation constant:

$$V_R = C_{V,R} \cdot U_{in} \cdot \frac{\sqrt{A'}}{D'} \left\{ 6 + 6 \cdot \ln \left(\frac{D'}{6} \right) \right\} \quad (5.7)$$

To predict the maximum recirculation flow rate Q_R we multiply the average velocity by the room cross-section area A_{RM} and use a third correlation constant $C_{Q,R}$:

$$Q_R = C_{Q,R} \cdot U_{in} \cdot \frac{A_{RM} \sqrt{A'}}{D'} \left\{ 6 + 6 \cdot \ln \left(\frac{D'}{6} \right) \right\} \quad (5.8)$$

The correlation expressions obtained apply in the turbulent regime that occurs for the flow velocities found in typical CV flows. The CFD simulations used to obtain the correlation constants $C_{V,J}$, $C_{V,R}$ and $C_{Q,R}$ are also for that regime. For this reason the correlations presented below have the functional form

$$V_n = av + b \quad (5.9)$$

where n can be 'J' or 'R' (for jet and recirculation regions, respectively), v is a velocity scale, and a and b are constants resulting from a least-squares fit. The model has a lower limit on the value of v : if it is too small the flow is no longer turbulent. This limit implies that the point $v = 0$ is never achieved, avoiding the unrealistic prediction of $V_n(0)=b$.

(e) Sensible Heat Conservation

CV flow patterns with recirculation regions can sustain significant temperature variations between the two main flow zones. Heat gains in each zone may result from internal convective gains from occupants or heat exchange with internal surfaces. For the case of adiabatic walls we can enumerate a few simple principles that apply to sensible heat conservation in this context:

- When heat is placed in the jet region the internal temperature is uniform (there is mixing between jet and recirculation regions and, aside from the outlet, there are no sinks, so temperature becomes constant across the flow).
- When heat is placed in a recirculation region there is an increase of temperature in this region until, with the available mixing between jet and recirculation, the heat flux into the jet equals the gain.
- The sensible heat gain conservation problem is linear: any case is a linear combination of two base cases (gains in the jet or gains in the recirculation regions).

We begin the analysis with the perfectly mixed solution obtained when a heat flux q_J is added in the jet region:

$$\rho c_p Q_{in} \cdot \Delta T_{RM} = C_{T,RM} \cdot q_J \Rightarrow \Delta T_{RM} = C_{T,RM} \frac{q_J}{\rho c_p Q_{in}} \quad (5.10)$$

The more complex case of a heat flux q_R in the recirculation region results in different temperature increases in the two zones:

$$\left. \begin{aligned} \rho c_p Q_R \cdot \Delta T_R &= C_{T,R} \cdot q_R \Rightarrow \Delta T_R = C_{T,R} \frac{q_R}{\rho c_p Q_R} \\ \rho c_p Q_R \cdot \Delta T_J &= C_{T,J} \cdot q_R \Rightarrow \Delta T_J = C_{T,J} \frac{q_R}{\rho c_p Q_R} \end{aligned} \right\} \quad (5.11)$$

When $A' > 0.5$ the flow has no recirculation regions (Carrilho da Graça & Linden, 2003) and the room temperature increase simply becomes one half of the outflow increase (the resultant average of the linear temperature increase along the room depth). Since heat is treated as non-buoyant, the preceding analysis can be applied to internal pollutants such as humidity or CO₂.

Table 5.10 shows the definition of all variables predicted by the model. Because of the self-similar velocity profile in the recirculation, the near-wall velocity (used to predict forced convection) can be estimated by multiplying the characteristic recirculation velocity by two.

Table 5.10: Definitions of Output Variables

Output variable	Symbol	Units	Definition
Jet velocity	V_J	m/s	Volume-averaged jet region velocity. The averaging volume is bounded at each point (x) along the room depth by the line in the y - z plane where the jet velocity drops below 50% of its maximum (centerline) value.
Recirculation zone velocity	V_R	m/s	Area-averaged velocity in the y - z plane with maximum flow. The averaging area is the recirculation part of the room cross-section. Typically the plane of maximum flow occurs at $x \sim 2D/3$ ($D/3$ before the outlet).
Recirculation zone flow rate	Q_R	m^3/s	Total flow rate for the recirculation regions in the plane of maximum flow (see above).
Jet temperature rise	ΔT_J	$^{\circ}C$	Volume-averaged temperature variations in the jet region, over the same volume used to define the jet velocity average.
Recirculation zone temperature rise	ΔT_R	$^{\circ}C$	Volume-average temperature variations in the recirculation region. The average is calculated over the cuboidal volume placed in each recirculation containing the volumetric sensible heat gains (see main text).

5.2.1.4 CFD Simulations

The role of CFD in the model is two-fold: test the validity of the assumptions and obtain the correlation constants that best fit the range of room geometries considered below. This is achieved by running a series of test cases, each with a different room geometry, computing the flow variables defined in Table 5.10 in each case, and then seeking linear relationships between the flow variables and their corresponding scales according to equations (5.6)-(5.8) and (5.11). While the room geometry was varied, the external (building) geometry, the heat sources and the incoming wind were all fixed.

In the rest of this section, we describe the physical configurations modeled, the setting-up of the CFD model and conclude with a discussion of validation carried out.

(a) Configurations Modeled

The physical set-up simulated in each case consisted of an isolated building in which a single room containing constant volumetric heat sources was cross-ventilated by a steady mean wind. The details of each aspect are described below.

- **Building**
The building was cuboidal in shape with width 24m, height 9m and depth 0.2m greater than the room depth (corresponding to a 0.1m thickness to the external walls and window openings). It is representative of a small 3-story office building at full-scale.
- **Room**
The building contains a single room open to the external environment, with one opening in each of the two façades along the short horizontal dimension. In the default configuration the two openings are of equal size and opposite one another in the center of each room wall and positioned midway between floor and ceiling. The room itself is positioned centrally both horizontally and vertically with respect to the building façade, and is therefore representative of a second-floor office.

Table 5.11 lists the room geometries used to develop the model. The database contains the typical room sizes for which single opening CV systems may be used, ranging from a small office ($4.5 \times 4.5 \times 2.3\text{m}$) up to a large room ($13.5 \times 18 \times 2.3\text{m}$). Room height H varied between 2.3m and 3.4m and the inflow aperture area A_{in} varied between 0.25 and 1m^2 .

Comparison between the room geometry set used and the set used in the existing model (Carrilho da Graça & Linden, 2003) shows significant differences:

$$\text{New CV model: } 12 < x' < 36, 0.5\% < A' < 5\%$$

$$\text{Existing CV model: } 2 < x' < 18, 3.2\% < A' < 21\%$$

The smaller openings used in the new model result in more space for jet development along the room length. In all but the shortest rooms the jet will enter the self-similar profile phase, characterized by a $1/x'$ centerline velocity decay rate (see Section 5.1.2.3(c)). Further, the lower A' used in the current database results in smaller jet confinement effects.

- **Heat sources**
In order to predict the temperature increase, constant heat flux was inserted into the recirculation regions for different room geometries. The volumes containing the heat gains extended over the whole depth of the room, from floor to ceiling, and in the lateral direction from a plane extending from halfway between the window edge and the wall, all the way to the wall (see Figure 5.39). A source density of 50W/m^3 was used.
- **Wind and Environment**
The wind speed was 10m/s at 10m reference height, and assumed to be appropriate to an urban boundary layer (see also the discussion of velocity inlet boundary conditions below).

Table 5.11: Test Cases Used to Develop Correlations

Case	Opening area A_{in} (m ²)	Room width W (m)	Room depth D (m)	Room height H (m)
1	0.25	4.5	4.5	2.3
2	0.25	6.0	9.0	2.3
3	0.25	11.0	9.0	2.3
4	0.5	6.0	9.0	2.3
5	0.5	9.0	6.0	2.3
6	0.5	9.0	9.0	2.3
7	0.5	9.0	13.5	2.3
8	0.5	9.0	18.0	2.3
9	0.5	11.0	9.0	2.3
10	0.5	13.5	9.0	2.3
11	0.5	13.5	9.0	3.4
12	0.5	13.5	18.0	2.3
13	0.75	6.0	9.0	2.3
14	0.75	11.0	9.0	2.3
15	0.75	13.5	18.0	2.3
16	1.0	9.0	9.0	2.3
17	1.0	9.0	9.0	3.4
18	1.0	9.0	13.5	2.3
19	1.0	9.0	13.5	3.4
20	1.0	9.0	18.0	2.3
		RANGE (max:min ratio)		
	4.0	3.0	4.0	1.5

Figure 5.39: Location of Heat Sources in CFD Simulations

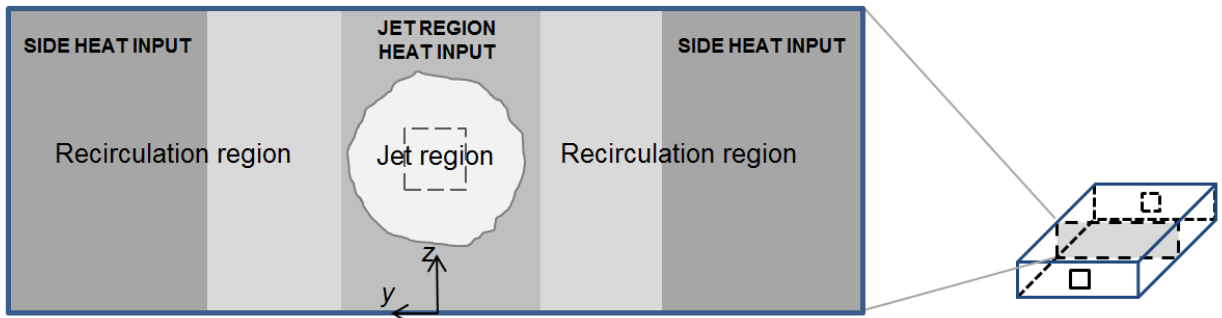

Volumetric heat sources are located in recirculation regions between the outer wall and half-way to the window, and extend the full depth of the room. Note that heat input in the jet region was considered for test purposes only and does not feature in the model itself.

(b) CFD Set-Up

All CFD simulations were performed using the code ANSYS® FLUENT, Release 14.5, using the steady simulation option.

Under the categories below we describe how the physical configurations defined above were translated into CFD input, how convergence was monitored and how results for use in developing the correlations were obtained.

- Computational Domain and Grid

In order to model the flow inside the room in a more realistic way, both this flow and the external flow around the building were modeled together (rather than, say, using a separate stage to generate the conditions at the inlet aperture). The disadvantage is that the computational domain must be large enough to avoid undue influence of the boundaries of the domain on the building flow, but at the same time resolve the flow across the apertures and within the room adequately. A structured grid was used whose overall dimensions were based on standard recommendations (e.g. Franke *et al.*, 2007) that use the building height as the appropriate scale: thus the limits in each coordinate direction were $-5H \leq x \leq 15H$, $-W/2-5H \leq y \leq W/2+5H$, $0 \leq z \leq 6H$. This was adjusted in cases where the wind was not aligned with the x -direction so that the boundaries parallel and perpendicular to the wind were sufficiently far away.

The grid resolution was chosen to give precedence to regions of high variation variation – adjacent to solid walls, and in the shear layers developing downstream of the apertures inside the room – using inflation factors of between 1.1 and 1.2 used to expand the cell size away from these areas. The net result was a grid of approximately $1.0-1.5 \times 10^6$ cells in total, with $1.2-1.5 \times 10^5$ cells within the room.

- Models

Two different turbulence models were used in all the simulations, namely the SST $k-\omega$ and RNG $k-\varepsilon$ models, since these had been shown to perform best among the RANS turbulence models in a number of investigations (see Section 5.2.1.2(b)). In both cases, the ANSYS® FLUENT ‘advanced wall treatment’ was selected, which assesses the grid resolution and uses wall functions if the grid spacing is sufficiently large.

Note that the heat introduced into the room is treated passively, so that the energy equation is solved to give the redistribution of heat in the room but the effect on the flow equations, through the introduction of a buoyancy term, is not modeled.

- Boundary Conditions

Standard choices for boundary conditions in this type of problem were used in the simulations. At the upstream (inlet) boundary of the computational domain, vertical profiles for the velocity variables were specified: a logarithmic mean velocity profile, specified using the reference velocity and height (Section 5.2.1.4(a), ‘Wind and environment’) and a roughness height $z_0 = 0.3\text{m}$ appropriate to an urban boundary layer profile; and turbulence

variables (k , ε , ω) as given by Ramponi & Blocken (2012). The downstream face was treated as a constant (zero) pressure boundary; while the top and side boundaries were assigned symmetry conditions (zero gradient). Solid surfaces were specified as no-slip boundaries.

- Numerical Scheme

Second-order accurate schemes were selected for all the equations.

- Convergence Monitoring

The standard practice in monitoring convergence is to track both the residuals for each equation and some pointwise or integral properties of the solution as the simulation progresses, and to consider the solution converged when the residuals are all less than some small threshold, such as 10^{-4} and the variation in the flow properties is likewise less than a specified tolerance. In most cases here the residuals were unsuitable monitors since they leveled off at least an order of magnitude above this threshold, so the primary convergence monitors used were instead the correlation parameters themselves, i.e. V_I , V_R , etc. These parameters showed a variety of behavior, ranging from convergence to constant values in some cases, to oscillations of varying amplitude in others. Each simulation was therefore run until one or other of these behaviors was observed – continuing the simulation for additional numbers of iterations – and then averaging the results over a sufficient number of iterations, typically 1000, to at least two oscillation periods and smooth out the variations. The quasi-steady nature of the CFD solution was also observed by Ramponi & Blocken (2012) in their simulations of similar geometries. It is probably due to conflict between the attempt to find a steady solution to the problem and the intrinsically unsteady nature of the combined exterior/interior flow.

- Post-Processing

The flow variables defined in Table 5.10 are averages over volumes or areas whose boundaries depend on the flow, e.g. the surface of 50% maximum centerline x-velocity used in the definition of V_I . The standard post-processing capabilities of ANSYS® FLUENT are insufficient to calculate these parameters, and so the UDF (user-defined function) facility was used. UDF's are routines written in C that can be called during a simulation; in this case, the UDF was called at the end of each iteration to calculate the flow parameters and write their values to a file, which can be examined during the simulation, either during a run or at the end of a batch of iterations.

(c) Validation

There are no published experimental studies of detailed flow fields inside a cross-ventilated room for the building/room geometries considered here. Ramponi & Blocken (2012) investigated the simulation of the experimental results of Karava *et al.* (2011) using ANSYS® FLUENT and found velocity profiles deduced from PIV measurements across the small model-scale test room ($0.1\text{m} \times 0.1\text{m} \times 0.08\text{m}$) could be adequately reproduced. This result was exploited here by basing the computational set-up on the successful set-up in Ramponi & Blocken (2012) and therefore by-passing the need for extensive validation runs.

Validation of the flow rate was carried out for a selection of the CV tests performed in Task 3.1 (see Section 5.1.3.2). ANSYS® FLUENT was first run to generate the steady flow field; this was then used to drive the time-evolution of the concentration field in a transient simulation, starting from a room uniformly seeded with tracer gas. The computed concentration decay rates agreed very well with the observations for a number of different aperture arrangements.

A further validation exercise was carried out to confirm the suitability of CFD modeling to the CV flows of interest. For this purpose, the test case defined by Nielsen (1990) and previously studied by Chen (1995), was simulated in a steady 3-D run of ANSYS® FLUENT, consisting of a room with a single two-dimensional inlet and outlet (Figure 5.40). The computational grid comprised 4×10^5 cells, with 10 cells across the inlet and 20 across the outlet. The simulation was carried out at a scale appropriate to a CV room, with cross-sectional dimensions $9\text{m} \times 3\text{m}$ and length 3m in the normal direction, and compared with experimental data at model scale (1:33.6) but the same inlet Reynolds number ($Re = 5000$).

Figure 5.40: Comparison of CFD simulation of Diffuser Flow With Experimental Data

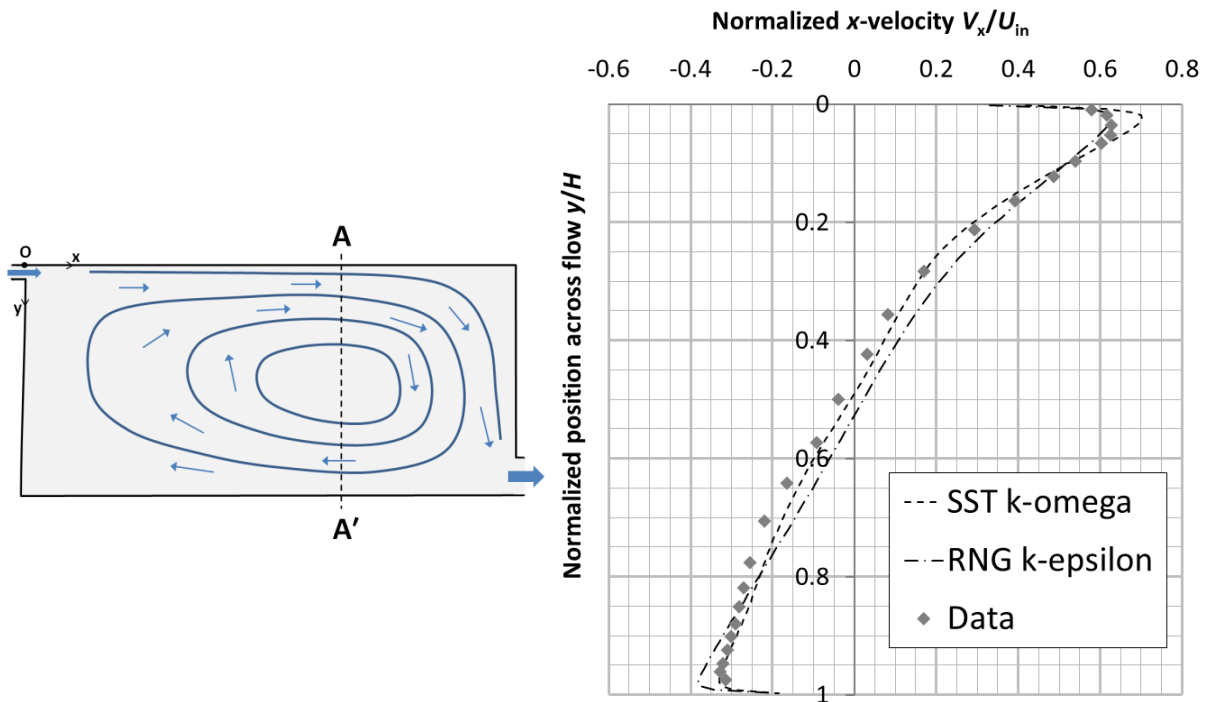

The graph plots the profile of x-velocity (normalized with the inflow velocity) over the cross-section AA'. Results are shown for using two different turbulence models for the CFD simulations.

The graph in Figure 5.40 compares the velocity profile in a plane two-thirds of the way along the flow, showing good agreement with the experimental results. Note that this is the same location relative to the inlet at which the maximum flow rate typically occurs in CV flows. Besides the pointwise comparison, the CV correlation parameters, V_I , V_R and Q_R , were also computed using suitable definitions for this set-up: for example, the mean jet velocity, V_I , is the

average over the part of AA' for which the flow is positive and exceeds 50% of the maximum value. Comparisons with the experimental values are given in Table 5.12, which shows that the CFD simulation predicts the experimental values in general to within 10%.

Table 5.12: Percentage Error in X-Velocity Profile Using Different Flow Metrics

	RNG $k-\epsilon$ (%)	SST $k-\omega$ (%)
Mean Jet Velocity (V_J)	1	12
Mean Return Velocity (V_R)	6	1
Mean Return Flow (Q_R)	7	5

5.2.1.5 Results

In this section we present the results of CFD runs to simulate CV flows. There are two parts: (a) presents the findings of the runs to develop the model correlations; while (b) examines the sensitivity of the results to variations in some parameters kept constant in (a).

(a) Correlations

Figure 5.41 shows a plan view of the CFD solution field for a typical CV case ($W = 9\text{m}$, $D = 13.5\text{m}$, $H = 3.4\text{m}$, $A_{in} = 1\text{m}^2$), clearly displaying the distinct character of the two flow regions and the internal temperatures that occur when heat is added to the recirculation regions.

Figure 5.42 shows plots of the data derived from the CFD simulations of these test cases, including the lines giving the best fit to the data. Each point is obtained by computing the scaling parameter based on the room parameters (x -axis) and the relevant averaged parameter from the CFD solution (y -axis). The plots test the proposed scalings given in equations (5.6)-(5.8) for V_J , V_R and Q_R : the better the scalings have captured the dominant flow features and mechanisms, the smaller will be the scatter of the points around a straight line.

Table 5.13 gives the quantitative details of these plots, in the form of the best-fit linear correlations for each variable and turbulence model. The minimum quadratic difference correlations are evaluated using the Pearson product-moment correlation coefficient, r . Overall the results confirm the modeling assumptions. The precision level of the correlations is variable, with the highest correlation occurring for the jet velocity and the lowest for the recirculation velocity, but all are within engineering precision goals (average error below 15%). In the case of the temperature variation coefficient an average value is used.

Figure 5.41: Velocity and Temperature Increase at Mid-Room Height for Case 19

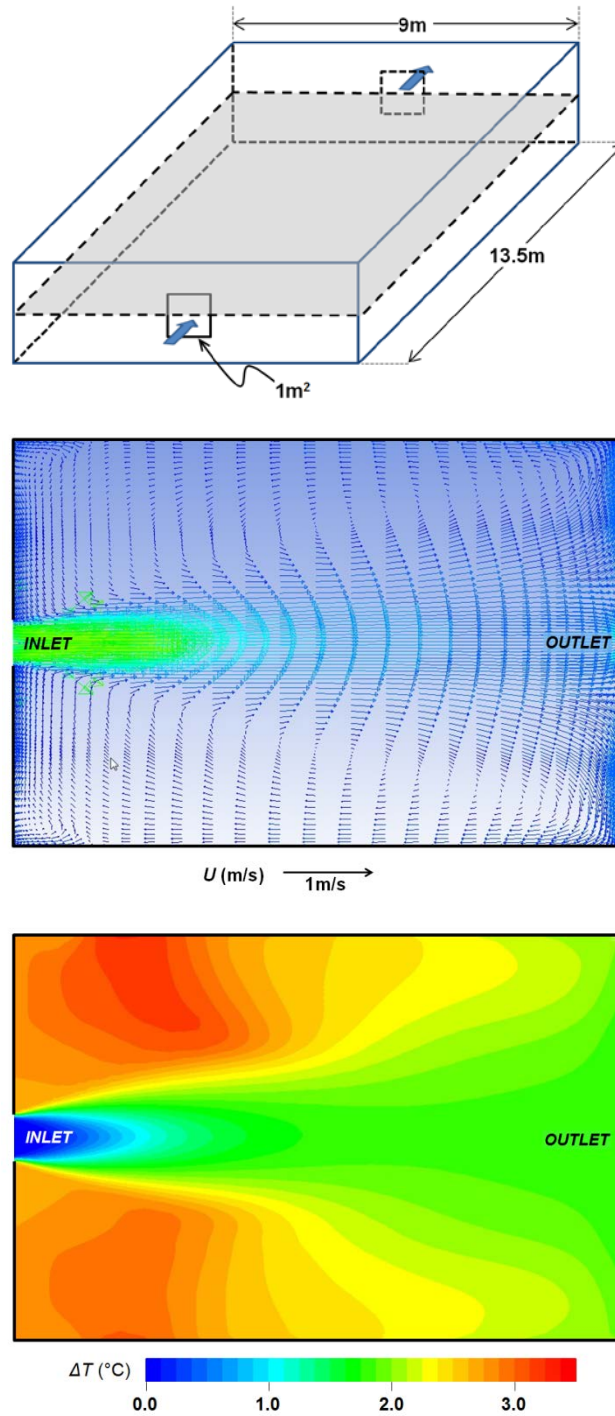

Velocity and temperature increase (case with gains in the recirculation regions) are shown at mid-room height for room with $W = 9\text{m}$, $D = 13.5\text{m}$, $H = 3.4\text{m}$, $A_{\text{in}} = 1\text{m}^2$.

Figure 5.42: Correlation Results for Jet Velocity, Recirculation Velocity and Recirculation Flow Rate

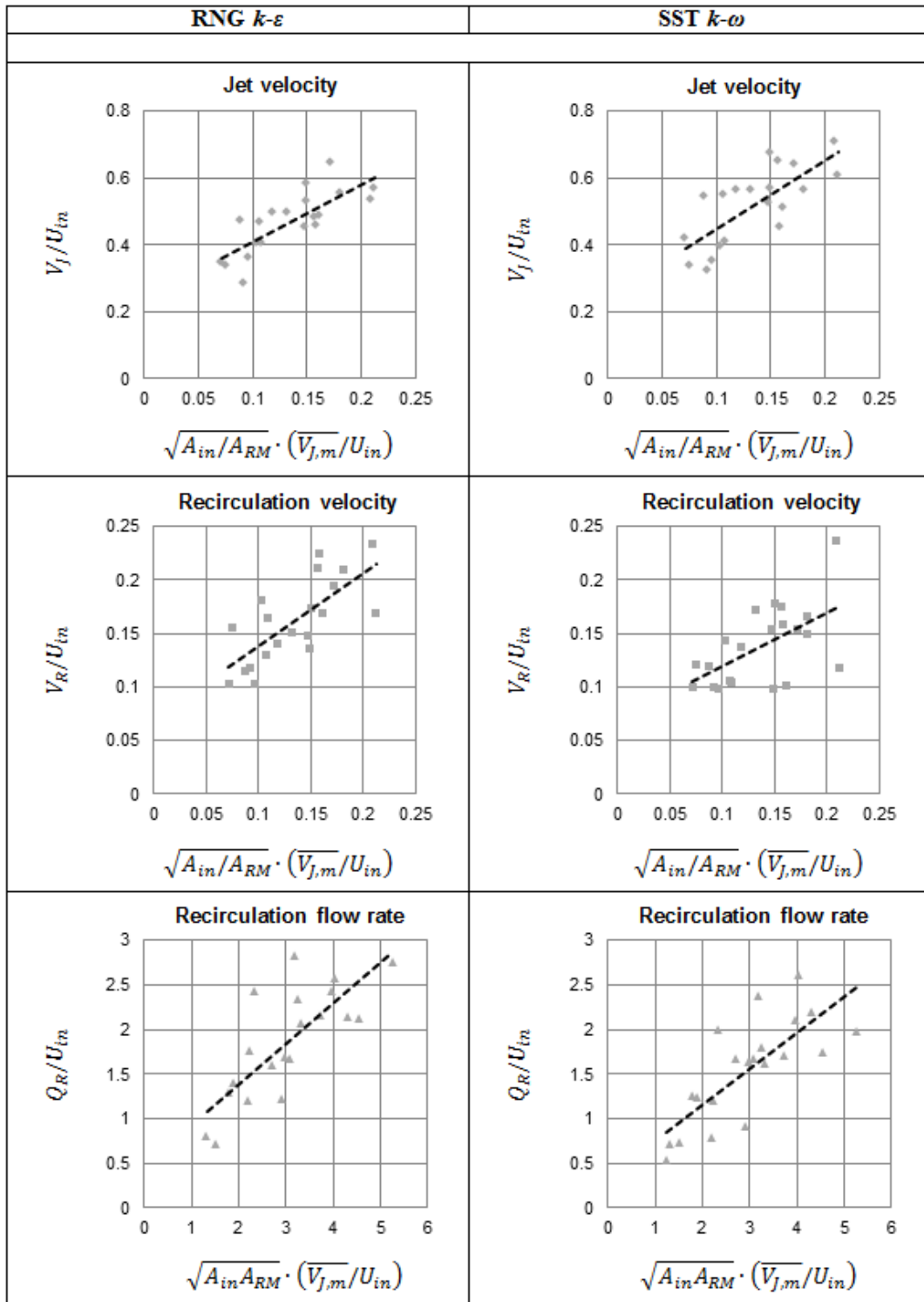

Results are shown for two different turbulence models: RNG $k-\epsilon$ (left-hand column) and SST $k-\omega$ (right-hand column).

Table 5.13: Correlation Formulae in the Form $Y = aX + b$

Physical quantity	Y	X	Turbulence model	a	b	r	Average % error
Jet velocity	V_j/U_{in}	$\sqrt{A_{in}/A_{RM}} \cdot (\overline{V_{j,m}}/U_{in})$	RNG $k-\epsilon$	1.711	0.240	0.783	10
			SST $k-\omega$	2.035	0.245	0.740	14
			Average	1.873	0.243	-	-
Recirculation zone velocity	V_R/U_{in}	$\sqrt{A_{in}/A_{RM}} \cdot (\overline{V_{j,m}}/U_{in})$	RNG $k-\epsilon$	0.685	0.070	0.729	14
			SST $k-\omega$	0.496	0.070	0.565	17
			Average	0.591	0.070	-	-
Recirculation zone flow rate	Q_R/U_{in}	$\sqrt{A_{in}A_{RM}} \cdot (\overline{V_{j,m}}/U_{in})$	RNG $k-\epsilon$	0.453	0.481	0.773	17
			SST $k-\omega$	0.376	0.451	0.726	19
			Average	0.415	0.466	-	-
Jet temperature rise	ΔT_j	$\frac{q_R}{\rho c_p Q_{in}}$	RNG $k-\epsilon$	0.868	0	-	6
			SST $k-\omega$	0.831	0	-	8
			Average	0.849	0	-	n/a
Recirculation zone temperature rise	ΔT_R	$\frac{q_R}{\rho c_p Q_{in}}$	RNG $k-\epsilon$	1.338	0	-	6
			SST $k-\omega$	1.432	0	-	7
			Average	1.385	0	-	-

(b) Sensitivity Analysis

The proposed model neglects the effects of outflow aperture position and buoyancy. In this section, the validity of these simplifying assumptions is analyzed using a limited set of CFD simulations with the aim of comparing a base case (Table 5.11, Case 4, a 6m × 9m × 2.3m room with $A_{in} = A_{out} = 0.5m^2$) with alternate cases where the neglected feature is included.

Outflow Aperture Position and Number

In order to test the influence of outlet aperture area and position, the following seven variations of the base case were simulated:

- * Base case with a large outlet, aligned with the inlet, and $A_{out}/A_{in} = 1.5, 2.0, 2.5$ and 3.0
- * Base case with single outlet, offset from the inlet, and $A_{out}/A_{in} = 1.0, 2.0$
- * Base case with two outlets, offset from the inlet, and $A_{out,1} = A_{out,2} = 0.71m^2$ (so that the effective combined area of the two outlets, $A_{out,1} \cdot A_{out,2} / \sqrt{(A_{out,1}^2 + A_{out,2}^2)}$, equals A_{in}).

In the second and third cases, the outlets were offset so that in each case they were midway between the base case outlet position and a side wall.

Table 5.14 presents a comparison between the base case and the above variations, giving the percentage relative difference for each of the three velocity-related correlation parameters. The table indicates that outlet position and number do not significantly influence internal velocities.

The cases for which the outlet was larger than the inlet showed a significant deviation in the recirculation velocities compared with the base case when the outlet was more than twice the inlet area. In these circumstances there would be a large model error, and it is therefore recommended that the model should not be used for cases where $A_{out}/A_{in} > 2$.

Table 5.14: Sensitivity Test Results

Parameter Variation	Difference From Base Case (%)		
	V_J	V_R	Q_R
$A_{out} = 1.5A_{in}$	2	3	3
$A_{out} = 2.0A_{in}$	1	4	4
$A_{out} = 2.5A_{in}$	6	43	41
$A_{out} = 3.0A_{in}$	6	42	40
$A_{out} = A_{in}$, outlet offset	10	10	8
$A_{out} = 2.0A_{in}$, outlet offset	13	7	8
2 outlets, effective $A_{out} = A_{in}$	5	4	2
Buoyancy included	0	4	3
Buoyancy included, half wind speed	2	11	10

For each parameter variation, columns show percentage relative difference in correlation parameters compared with base case.

Effects of Buoyancy

The model does not consider the effect of buoyancy forces on the indoor velocities. These forces are approximately perpendicular to the CV flow inertial forces. The relative importance of buoyancy and momentum fluxes can be assessed by means of the Richardson number $Ri = QB^{1/2}/M^{5/4}$, where Q is the volume flux, B the buoyancy flux and M the momentum flux. For the cases listed in Table 5.11, the maximum value of Ri was found to be 0.084, indicating buoyancy effects were unlikely to be important. In order to check this assertion, the base case with a wind speed reduced by half was simulated with and without buoyancy. Table 5.14 shows that the difference in the average jet and recirculation velocities was around 10% or less (within the model precision goal).

5.2.1.6 Model Extension

Engineering design cases where the model will be applied are expected to include rooms with multiple inflow apertures and sites with variable wind direction. As will become clear in this section, both of these features influence indoor velocities and must be modeled.

(a) Extension to Multiple Inflow Apertures

Many CV building designs use multiple inflow openings (Zhai *et al.*, 2011; Carrilho da Graça *et al.*, 2004). It is frequently the case that the difference in wind-generated pressure across the building, Δp , is large compared with the difference in pressure across the inlet façade, so that each window experiences approximately the same pressure. In this case, if the discharge

coefficient, C_d , is similar for all apertures, the inflow velocity is also approximately constant for the different openings:

$$Q_{in}^{(i)} = C_d A_{in}^{(i)} \sqrt{\frac{2\Delta p}{\rho}} \Rightarrow U_{in}^{(i)} = \frac{Q_{in}^{(i)}}{A_{in}^{(i)}} = C_d \sqrt{\frac{2\Delta p}{\rho}} \quad (5.12)$$

A constant inflow velocity does not imply a constant jet and recirculation velocity since A_{in} may vary between openings. For example, a room with two equally spaced inflow openings of area 0.5 and 1.0m² will have internal velocities that differ by more than 30% (the larger opening generating higher velocities as the jet does not decay as much inside the room, see the 'Room C' column, in Table 5.15).

The simplest approach to multiple inflow modeling is to treat the flow generated by adjacent openings as the addition of independent flows, generated by single openings, each occupying a part of the room width (Figure 5.43). The case shown in Figure 5.44 is an 18m-wide room with two inlets; this is viewed as being equivalent to two independent flows in 9m-wide rooms placed side by side.

Figure 5.43: Schematic Illustration Of Procedure to Model A 2-Aperture Room as A Combination Of 1-Aperture Rooms

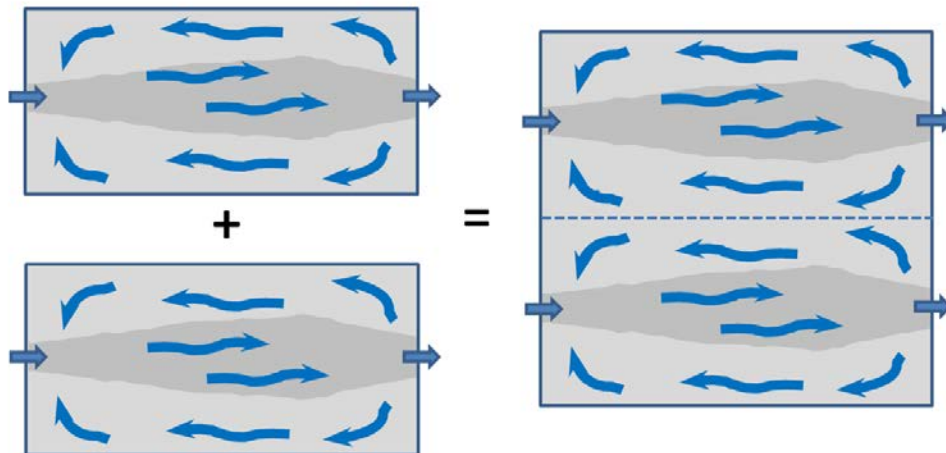

Detailed analysis of the flow results for the cases shown in Table 5.15 reveals that the difference in airflow velocities between the 2-inlet room and the equivalent 1-inlet rooms differ on average by less than 5%, as shown in the bar charts in Figure 5.45, and will therefore be neglected. In light of these results, applying the model to multiple inflow openings is a simple repeat process that generates a set of recirculation room velocities and temperature increases. The quantitative comparisons above suggest that the differences between the 2-inlet room flow and its 1-inlet 'components', for example the deviation of the jets towards the outlet end of the room in Figure

5.44 compared with the flow in Figure 5.41, are not significant as far as the (averaged) correlation parameters are concerned.

Figure 5.44: Top View of Room With 2 Inlets and 2 Outlets

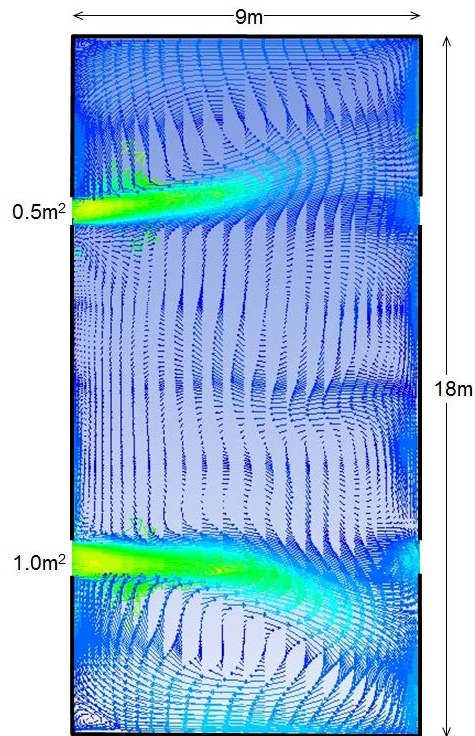

Velocity field is shown at mid-room height for room with $W = 18\text{m}$, $D = 9\text{m}$, $H = 2.3\text{m}$ and two apertures of 0.5m^2 (upper) and 1m^2 (lower)

Table 5.15: Cases and Results for the Side-by-Side Configuration

	Aperture		Room A	Room B	Room C
A_m (m ²)	1		0.5	1.0	0.5
	2		0.5	1.0	1.0
V_J/U_{in} (-)	1	Side-by-side	0.428	0.542	0.427
		Single	0.462	0.543	0.462
	2	Side-by-side	0.421	0.545	0.561
		Single	0.462	0.543	0.543
V_R/U_{in} (-)	1	Side-by-side	0.133	0.229	0.134
		Single	0.124	0.209	0.124
	2	Side-by-side	0.127	0.198	0.208
		Single	0.124	0.209	0.209
Q_R/U_{in} (m ²)	1	Side-by-side	1.306	1.880	1.312
		Single	1.306	1.906	1.306
	2	Side-by-side	1.340	1.814	1.904
		Single	1.306	1.906	1.906

Figure 5.45: Comparison of Flow Parameters for 2-Inlet Room With Corresponding 1-Inlet Rooms

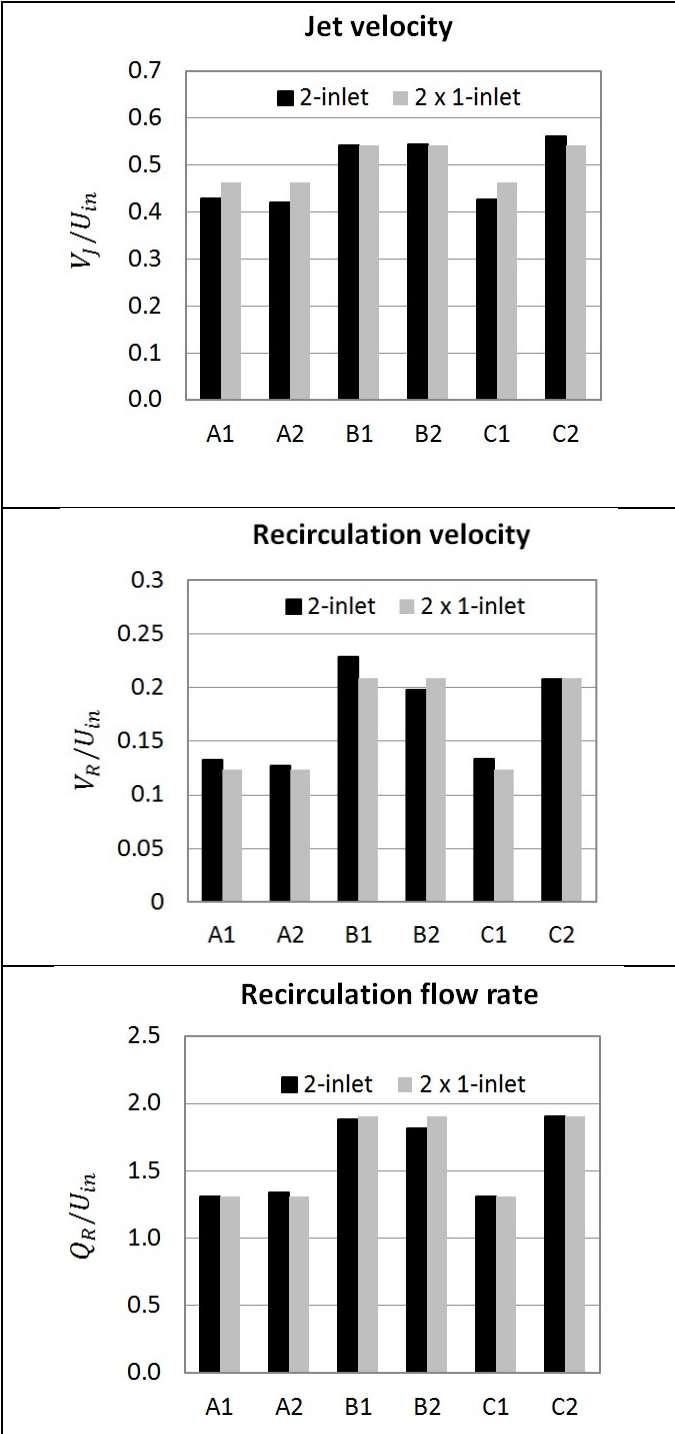

Jet velocity, recirculation velocity and recirculation flow are compared between the two halves of 3 different 2-inlet rooms, A-C and the corresponding 1-inlet rooms.

The results presented in this section were obtained for a case with two inflow apertures. Exploratory tests for cases with three and four apertures indicate that the results presented remain valid. Further work would be necessary to quantify the effects of non-aligned apertures and unequal numbers of inlet and outlet apertures.

(b) Extension to Variable Wind Direction

CV systems are sensitive to wind direction and tend to perform better in climates with a predictable wind pattern, such as the afternoon sea breeze characteristic of coastal cities. In any real wind-driven CV building variations in the wind direction are continuously changing the volumetric flow rate and direction of the inflow jets, thereby increasing mixing in the room by exposing the recirculation regions to direct jet flow (Ji *et al.*, 2011). For a given room, wind-driven flow rate is a function of the total static pressure difference, whereas inflow jet direction is influenced by external flow direction.

Figure 5.46 shows a schematic representation of the effects of incoming wind angle on the CV flow: as the inflow jet deviates from the normal direction its effective inflow area is reduced, resulting in a larger velocity for the same flow rate. Because indoor velocities scale linearly with inflow velocity, this area reduction will have a relevant impact on the indoor velocity field. This oblique inflow geometry has two main effects on the flow and consequent correlation predictions: the inflow area is reduced, creating a larger inflow velocity for a given flow rate, and the room flow path length is increased, resulting in a larger apparent room depth. The first effect increases indoor velocities while the second decreases the velocities. Quantitatively the effects can be modeled by two changes in flow geometry:

$$A_{in,\varphi} = A_{in} \cos \varphi, D_{\varphi} = \frac{D}{\cos \varphi} \quad (5.13)$$

The effect of the change in depth is limited by the possibility of the jet hitting the room side walls; it is difficult to quantify the exact variation in jet developing depth. The effect of the change in inflow area dominates that of the change in depth, although this may not be the case if the aperture depth (wall thickness) is comparable to the inlet characteristic diameter, as this will tend to align the inflow jet normal to the façade

From a practical point of view, the designer would like to use the zero-wind-angle correlation formulae, in conjunction with the standard external parameters of total inflow Q_{in} and inlet area A_{in} , for non-zero wind angles with minimal adjustment. For $\varphi > 0$, the relevant jet driving velocity is no longer $U_{in} = (Q_{in}/A_{in})$, but is instead the component in the jet direction, $U_{in,\varphi}$, say, which is approximately $Q_{in}/(A_{in} \cos \varphi)$. Similarly, the relevant volume-averaged jet velocity, $V_{J,\varphi}$, is the average component along the jet. We can, therefore, correct for the wind angle to first order by including a factor of $1/(\cos \varphi)$ in the x-coordinate of Figure 5.42, while retaining the y-coordinate as $V_{J,\varphi}/U_{in}$.

Figure 5.46: Schematic of Jet Resulting From Wind at Angle Φ to Façade.

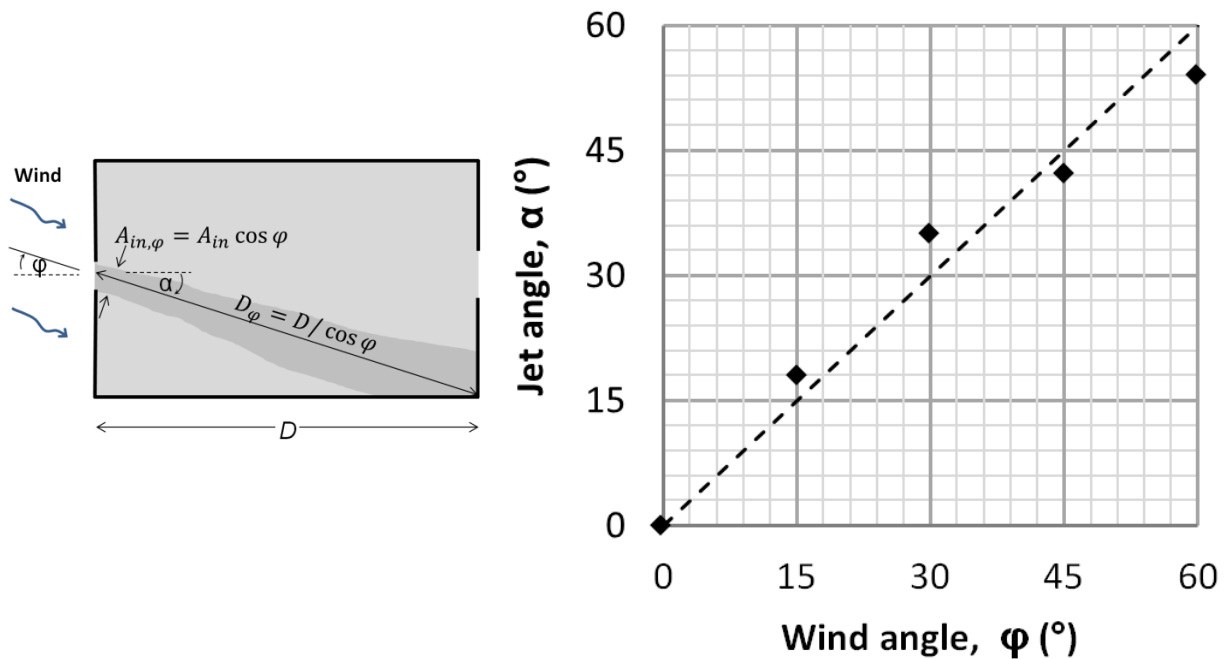

The jet enters the room at an angle α (left); the graph (right) shows that it is close to the wind angle, ϕ .

The effect of this adjustment factor is illustrated in Figure 5.47. For the example of the $6\text{m} \times 9\text{m} \times 2.3\text{m}$ room with 0.5m^2 inlet aperture, the normalized volume-averaged jet velocity $V_{J,\phi} / U_{\text{in}}$ was computed from CFD runs at wind angles of 15° , 30° , 45° and 60° and plotted against the unadjusted x -coordinate (open symbols) and the adjusted x -coordinate (solid symbols). The y -value increases with wind angle, since Q_{in} decreases. The inclusion of the adjustment factor satisfactorily brings the cases with non-zero wind angle into line with the correlation curve. The mean error is 8%, within the range for the correlation dataset.

Figure 5.47: Jet Velocity Correlation Applied to Non-Zero Wind Angles

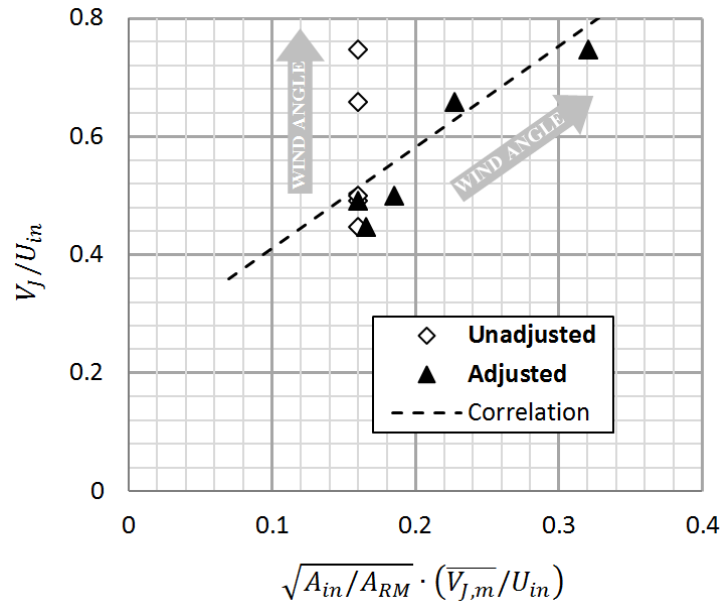

For a CV room in an isolated building, the combination of wind effects with jet inflow angle variation (and the consequent increase in flow driving velocity), results in an unexpected increase in indoor airflow velocity up to a 60° departure from normal incidence. Figure 5.48 shows the results of CFD runs for the above case with wind angles up to 60°. The left-hand figure plots the variation of inflow x -velocity U_{in} with wind angle, while the center figure shows the wind angle adjustment factor $1/\cos(\varphi)$. The right-hand figure plots the effective inflow velocity, which is the product $U_{in}/\cos \varphi$, together with the average jet velocity magnitude at the inlet deduced from the CFD results. The net combined effect of the two mechanisms is a higher consistency for CV flows with variable wind angle: the increase in inflow velocity partially compensates the decrease in overall flow rate. Note that the simulations suggest there is additional enhancement of velocities over and above the geometric wind angle effect. Eventually, however, the jet flow will break down as the wind approaches a direction parallel to the façade, and the inlet velocity $U_{in,\varphi}$, will decrease; this, combined with the overall decrease in flow rate due to the falling pressure difference across the building, means that the driving jet velocity falls off rapidly as φ approaches 90°.

5.2.1.7 Conclusions

Room airflow patterns in cross-ventilation depend on the ratio between inflow and room cross-section area $A' = A_{in}/A_{RM}$. When $A' > 0.5$ the flow resembles a unidirectional piston flow with no recirculation regions. Here we have focused on the more common and complex case of flow with recirculation regions, $A' < 0.5$. For this case, the results presented above confirm the possibility of characterizing the flow as a confined axisymmetric jet flow that drives the recirculation regions into a lid driven cavity flow.

Figure 5.48: Wind Angle Effects on Inlet Velocity

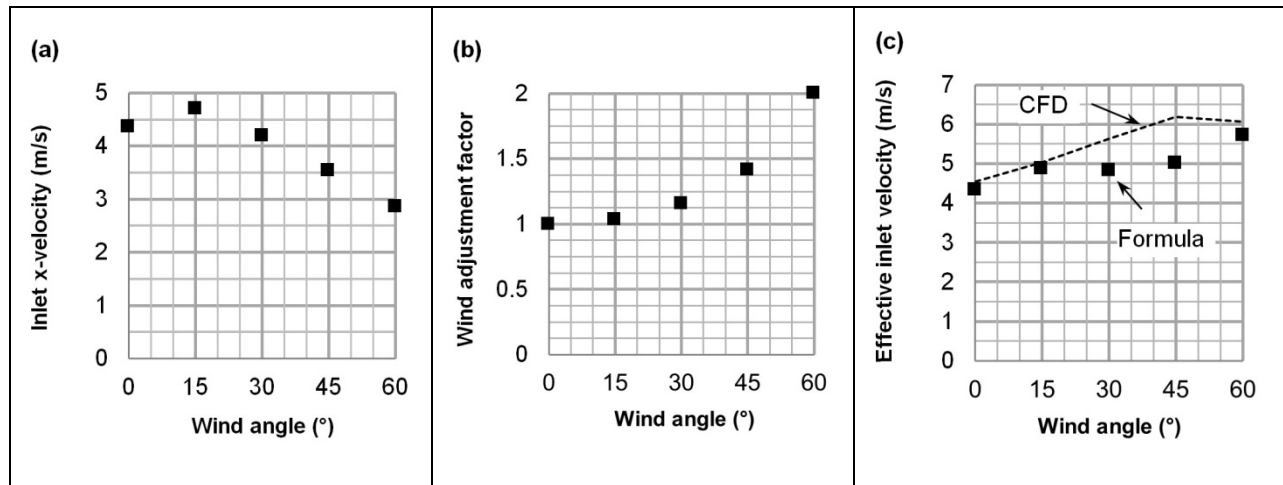

(a) Angle variation of the inlet x-velocity (or equivalently overall flow rate). (b) Inflow velocity variation with angle. (c) Combination of the two effects shows a surprising increase in room velocities up to 60°; solid symbols are values expected due to wind adjustment factor; dashed line is taken directly from simulation results.

The model correlation expressions predict the average indoor velocities in two distinct regions of the flow, the jet and recirculation regions, using a linear function of inflow velocity and two non-dimensional variables, namely A' and D' , the ratio of room depth to characteristic inflow diameter. Indoor velocities are proportional to $A'^{1/2}$ and inversely proportional to D' : longer rooms have lower indoor velocities (due to increased jet decay), while rooms with a larger inflow to room cross-sectional area have higher velocities for the same inflow rate. Maximum airflow rate in the recirculation region varies with $A_{RM}^{1/2}$: wider rooms have larger recirculation flow rates (a useful feature to dilute the heat gains that may exist in these regions). Internal heat gains in the recirculation regions lead to large local temperature increase. In contrast, when heat is placed in front of the inflow jet region the temperature increase is approximately uniform in the whole flow volume. For the typical inflow velocity and internal sensible heat gain density that occurs in CV buildings, buoyancy effects, outlet geometry and aperture shape factor do not have a significant impact on airflow velocities and internal temperature distribution.

The results of this study also show that rooms with multiple inflow openings can be modeled as a set of single inflow opening rooms in parallel. In these cases, interference of the adjacent recirculating flows leads to negligible change in indoor velocities. For isolated CV buildings, variations in wind direction change the inflow driving velocity in a way that compensates the decrease in static pressure that occurs for non-normal wind angles, making CV flows partially self-regulating.

5.2.2 Single-Sided Ventilation with 1 Aperture (SS1)

Many examples of natural ventilation studies and research focus on cross-ventilation because of its increased potential to achieve large flow rates that maximize free-cooling capacity. In practice this potential is difficult to extract because large natural ventilation flow rates are

incompatible with office tasks and may result in draft induced discomfort (particularly in the jet region of the flow). In addition, most rooms in the perimeter of the building do not have opposing external walls. In this context the use of SS systems that induce a lower, more manageable, flow rate becomes attractive. Due to their lower flow rates the cooling capacity of SS systems is more limited (restricted to lower loads or a higher upper temperature limit), but more usable.

There are two types of single sided ventilation (SS) systems: single and multiple opening. Single opening systems are the typical option for small offices while systems with multiple openings in distinct zones of the façade are the choice for large rooms. In terms of the physical picture of single-sided ventilation, there is a fundamental divide between one opening and more than one opening, since in the former case the external air entering and the internal air being removed must both pass through the same opening, while in the latter case there can be a clearer division between inlet and outlet openings. This difference means the single-opening case is somewhat limited in its ability to ventilate a room, whereas a room with two openings on the same façade can give a substantial supply of fresh air under many circumstances. The predominant mechanisms for wind driven flow are different in each system: single opening systems are driven by wind shear effects, while multiple opening systems are driven by static pressure differences.

In this section, we discuss the 1-aperture case, appropriate to modest ventilation requirements, while the more general case of 2 or more apertures is analyzed in Section 5.2.3.

5.2.2.1 Models for 1-Aperture Single-Sided Ventilation

The simplest application of natural ventilation in office buildings is in small single office spaces, where the problem of meeting the comfort targets of different users does not arise, since typically these spaces only have one or two occupants. For these small office spaces SS can be an optimal strategy since the limited depth does not require the use of CV, unlike deep offices, which are difficult to ventilate effectively using a SS system. Furthermore, it is likely that such offices would have just one window open at any given time.

Figure 5.49 illustrates the 1-aperture single-sided set-up. The room contains a single open window of area A_{in} , at a height z_w above the ground, through which there is a wind-driven ventilation flow Q_{in} . The wind speed approaching the building is $U_{ref} = U(H_B)$, i.e. measured at the building height; while at the building surface there is a local wind velocity U_L parallel to the façade.

Figure 5.49: Single-Sided 1-Aperture Set-Up and Notation

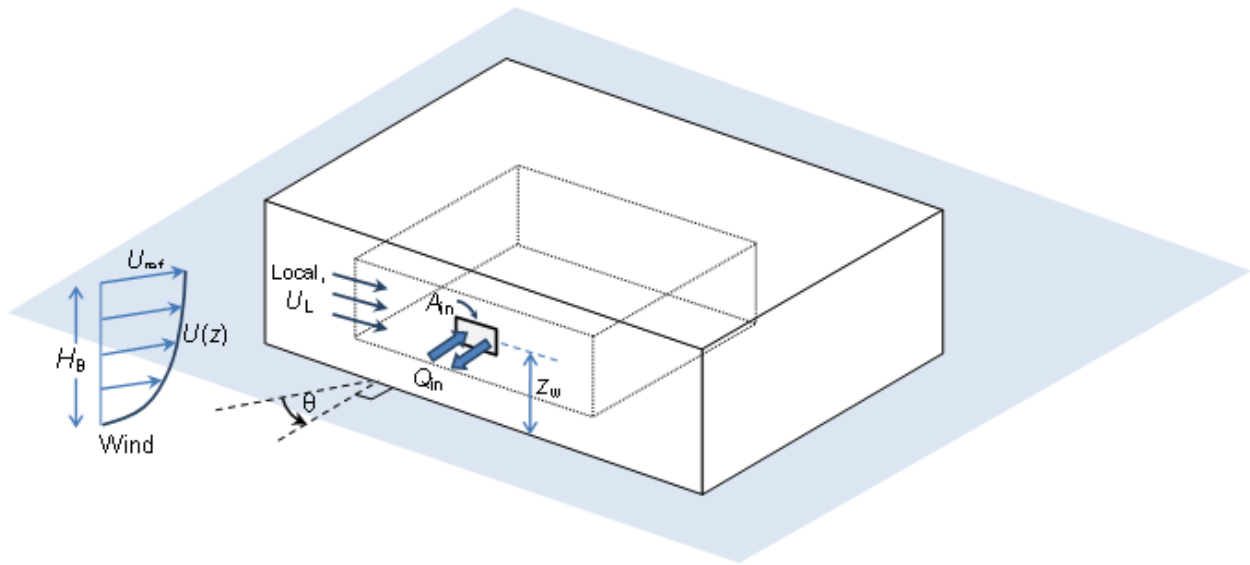

The flow past the opening causes a shear layer to grow normal to the opening, which entrains outside air that is injected into the room at the downstream edge of the window. Early work on simplified modeling of this process was performed by Warren in the 1970's and 80's (Warren, 1978, 1986; Warren & Parkins, 1985). This work was based on full scale and wind tunnel tests, and its main result was a formula to predict the SS single-opening shear-driven ventilation flow-rate :

$$Q_{in} = 0.1A_{in}U_L \quad (5.14)$$

The multiplying factor of 0.1 is a correlation coefficient, derived using ventilation rate data from an amalgam of measured tracer gas decay values and hot wire probe velocities.

In practice, expression (5.14) is difficult to apply because even for a simple cubic shaped isolated building the local wind velocity varies considerably along the façade. To overcome this difficulty Warren proposed a lower accuracy engineering design formula based on a conservative, low estimate of the average value of the ratio between the local and reference (building height) wind velocities, namely $U_L/U_{ref} = 0.25$, so that

$$Q_{in} = 0.025A_{in}U_{ref} \quad (5.15)$$

This average expression is used in many comparisons with more recent wind tunnel tests and detailed numerical simulations (RANS and LES), for different incoming wind directions, in spite of the fact that Warren published more detailed values of the coefficient depending on wind direction, for example, 0.023 for 90° wind and 0.05 for 0° wind (Warren, 1986).

Figure 5.50: Turbulent Shear Layer Exchange Interpretation for SS 1-Aperture Ventilation

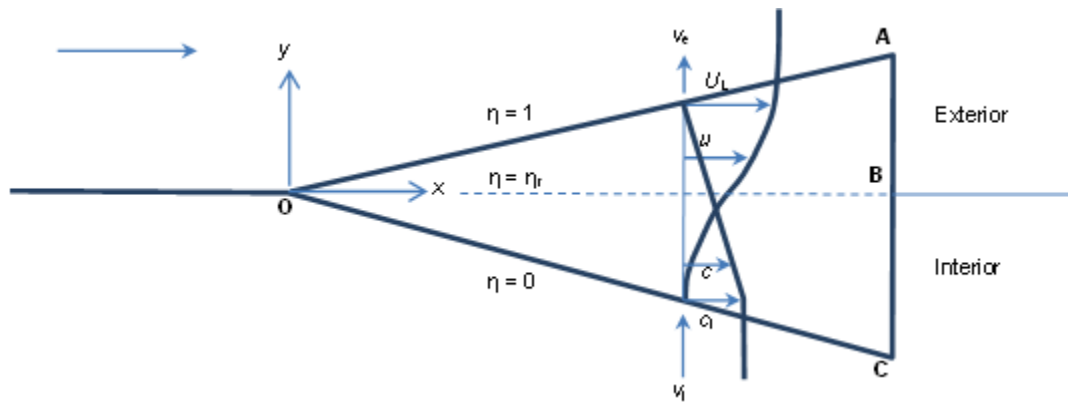

Source: Warren (1978).

Warren (1978) also proposed an analytical analysis of the ventilation process based on the turbulent exchange in a shear layer that starts in the windward edge of the window, a direct application of the Morton-Taylor-Turner entrainment hypothesis (Morton *et al.*, 1956) – see Figure 5.50. In this original interpretation, the SS ventilation process is the result of a two-way turbulent exchange at the shear layer that develops from the edge of the window. A set of results that has subsequently become available indicates that Warren’s original interpretation of the turbulent exchange process is incorrect.

In a paper published one year earlier, Champagne *et al.* (1976) showed that the shear layer spreads towards the low velocity region (in the SS case, into the room). According to Dimotakis (1986) this tilt is a direct consequence of an asymmetric entrainment rate: the shear layer entrains predominantly from the high-velocity outside air. For the SS shear layer with stagnant air on one side and on the other the entrainment ratio expression proposed by Dimotakis (1986) shows that more than 70% of the fluid is entrained from the outside. Further, the spread towards the low velocity region results in most of the shear layer air going into the room, as shown by Kato *et al.* (2006a) in a set of numerical simulations (see Figure 5.51). These LES simulations show regions of outflow in the leading edge of the shear layer and near the end along the top and bottom of the window. Measurements of the shear layer velocity profile in a wind tunnel model by Yamanaka *et al.* (2006) confirm the simulation results shown in Figure 5.51. These results lead to a picture of the ventilation process that is quite different from Warren’s interpretation: the shear layer predominantly entrains outside air and penetrates into the room, mass conservation is assured by outflow perpendicular to the window plane in localized regions along the perimeter of the window.

Figure 5.51: Results of Numerical Simulation of Flow Past a Single Opening

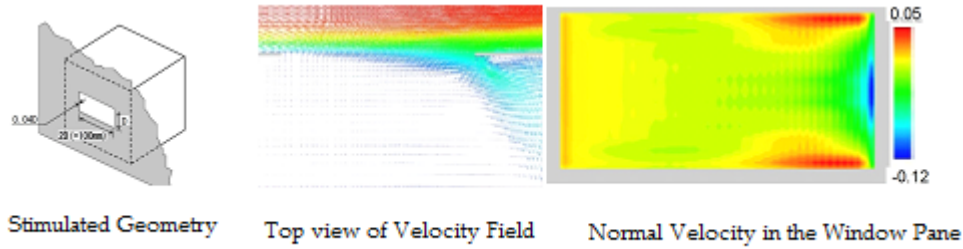

Source: Kato *et al.* (2006a), reproduced with permission from the authors.

Consider the case of a wind driven flow parallel to the façade along the x coordinate (window width), shown in Figure 5.51. The flow is considered to be invariant with z . For a turbulent shear-layer the self-similar velocity profile is approximately linear (a small approximation from the more accurate error function representation) between the high and, in the present case, still regions of the flow. For simplicity we consider that $\frac{3}{4}$ of the entrained air comes from the outside air and flows into the room. The shear layer width grows linearly with x (Pope, 2000):

$$\delta(x) = \frac{3}{4} \cdot 0.2x \quad (5.16)$$

where the value 0.2 adopted here is a rounding of the upper end of the experimentally obtained values for this parameter (Yamanaka *et al.*, 2006). For simplicity, we consider that the shear layer velocity profile is linear (a small approximation on the experimentally determined error function profile), the integration along the x -coordinate (width of the window) is then simply $U_L \cdot W/2$. Further integration along the height of the window results in:

$$Q_{in} = \frac{3}{4} 0.2W \cdot H \cdot \frac{U_L}{2} = 0.075A_{in} U_L \quad (5.17)$$

The value obtained is 25% lower than the 0.1 value proposed by Warren but is within 5% of the average of the values obtained in a wind tunnel by Chu *et al.* (2011) and Kato *et al.* (2006b). (In both cases the ratio U_L/U_{ref} measured by Warren for a 90° wind angle was used to convert U_L into U_{ref} .)

Several authors have performed comparative studies between the simple Warren expression and full-scale and wind tunnel measurements as well as different CFD approaches, and have shown that it performs as well as – and sometimes better than – CFD models. Chu *et al.* (2011) performed a wind tunnel experiment on shear-induced SS ventilation and proposed a correlation expression that depends on incoming wind direction and is based on their experimental results and other studies. This correlation deviates from (5.15) by less than 30% across the whole angle range tested (0-180°). The average error is 17% with zero bias. The angle variation and predicted values are similar to the correlation proposed by Larsen and Heiselberg (2008) (this correlation also includes thermal effects, discussed in Section 5.2.3.9). Yamanaka *et al.* (2006) proposed a general correlation expression based on wind tunnel measurements that is

similar to expression (5.15) but uses an average coefficient of 0.03 (a 25% variation on the coefficient proposed by Warren (1986)). Jiang *et al.* (2003) compared expression (5.15) with LES results validated by wind tunnel tests, and found good agreement for flow rate prediction on the windward side. Evola and Popov (2006) extended the comparisons and showed that expression (5.15) produces comparable results to CFD simulations using the RNG $k-\varepsilon$ turbulence model and superior results to the standard $k-\varepsilon$ model. Bu & Kato (2011) showed that expression (5.15) outperformed LES against wind tunnel measurements for leeward and windward configurations. Caciolo *et al.* (2012) compared expression (5.15) with RANS and LES simulations (validated by real scale measurements). Again, expression (5.15) proved superior to RANS and comparable to LES.

The present study does not analyze the effect of window shape or external wall depth. The study by Kato *et al.* (2006a) included the influence of external wall thickness and concluded that when the opening wall is thinner the shear layer momentum is conserved and the SS ventilation efficiency is higher.

5.2.2.2 Local Velocity Formula

EnergyPlus permits the calculation of wind-driven flow Q_w through a single opening via a formula similar in form to (5.14):

$$Q_w = C_w \cdot (A_{in} F) \cdot V \quad (5.18)$$

in which C_w is the opening ‘effectiveness’ and V is the ‘local’ wind speed. (F is the fraction of area open and is not considered further here.) The effectiveness parameter C_w is intended to allow for non-normal wind incidence: it has a value between 0 and 1, and it may be auto-calculated or input by the user – if auto-calculated, its value lies between 0.3 and 0.55 depending on the wind direction. The wind speed V is the wind speed at opening height, $U(z_w)$ – see also (5.40).

The flow rate depends on the direction of the wind relative to the window orientation. The formula (5.18) attempts to allow for this through the C_w factor, since the EnergyPlus local wind speed varies with height but is independent of building/window orientation. Comparing (5.18) with the earlier formula (5.14), which was shown to perform well in validation tests, we therefore seek an expression for U_L in terms of V , say $U_L = \Psi(\theta) \cdot V$, where θ is the angle between the wind and the façade containing the opening.

We have developed such an estimate of U_L as a function of θ by analysis of wind tunnel data from Task 3.1. The data analyzed were obtained in the January 2013 campaign (see Section 5.1.3.1 and summary in Section 5.2.3.11). In these tests, velocity was measured using hot film probes at 3 positions on one façade, as indicated in the inset in Figure 5.52, for a set of wind angles at 11.25° intervals over the range $0^\circ \leq \theta \leq 180^\circ$.

From the isolated building data three different building/velocity-measurement-height combinations were analyzed, namely

2-story/Floor 2 ($z_w/H_B = 0.68$)

4-story/Floor 2 ($z_w/H_B = 0.36$)

4-story/Floor 4 ($z_w/H_B = 0.83$)

giving a total of 9 cases altogether and a variety of ratios for the window height relative to the building height as indicated.

Figure 5.52: Wind Tunnel Measurement Points for Analysis of Local Velocity U_L

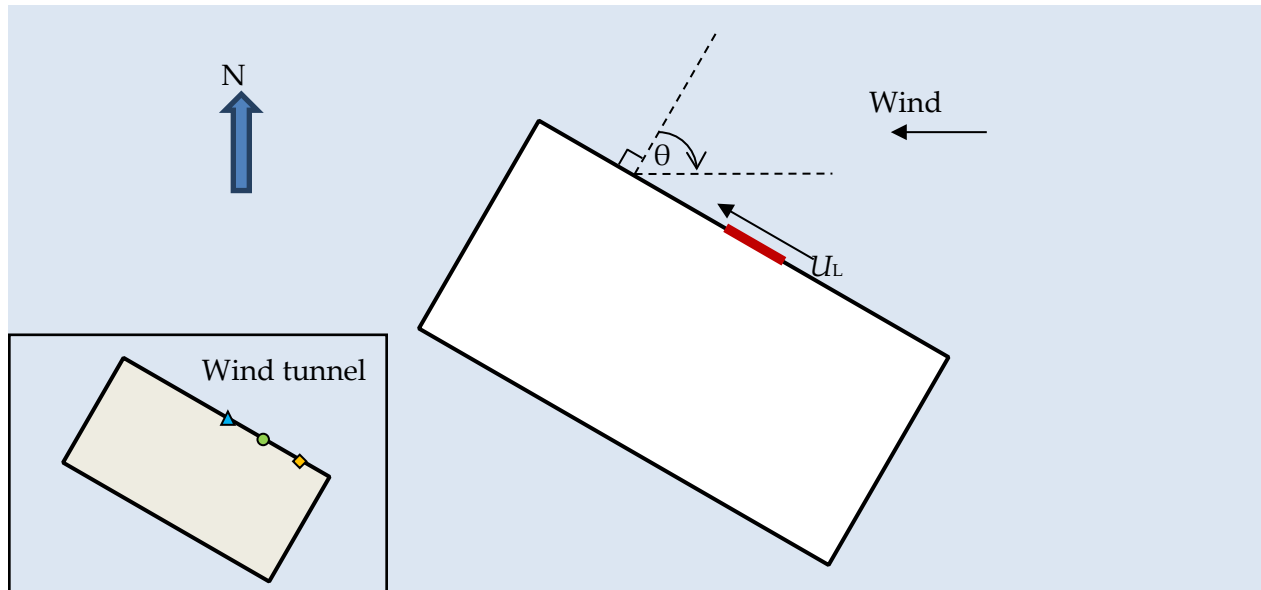

Figure 5.53 gives plots of $U_L(\theta)/U(z_w)$ for all 9 cases, where $U(z_w)$ is the wind speed at the opening mid-height. The 2-story graph also contains the data points from Warren & Parkins (1985), marked as 'WP85', who measured local velocity near the center of a 1:25 scale model of a single-story building. Their measurement location most closely matches the 'Center' curve.

Figure 5.54 plots the average of these 9 curves together with a data-fitting curve composed of a Gaussian superimposed on a linear base value:

$$\frac{U_L}{U(z_w)} = G(\theta) + L(\theta) \quad (5.19)$$

where

$$G(\theta) = 0.527 \exp\{-0.000638(\theta - 62)^2\} \quad (5.20)$$

$$L(\theta) = 0.25 - 0.00028\theta \quad (5.21)$$

for $0^\circ \leq \theta \leq 180^\circ$; if $180^\circ \leq \theta < 360^\circ$ θ is replaced with $(360^\circ - \theta)$ in the above formulae.

Figure 5.53: Local Velocity $U_L/U(z_w)$ as Function of Wind Angle for Wind Tunnel Data Analyzed

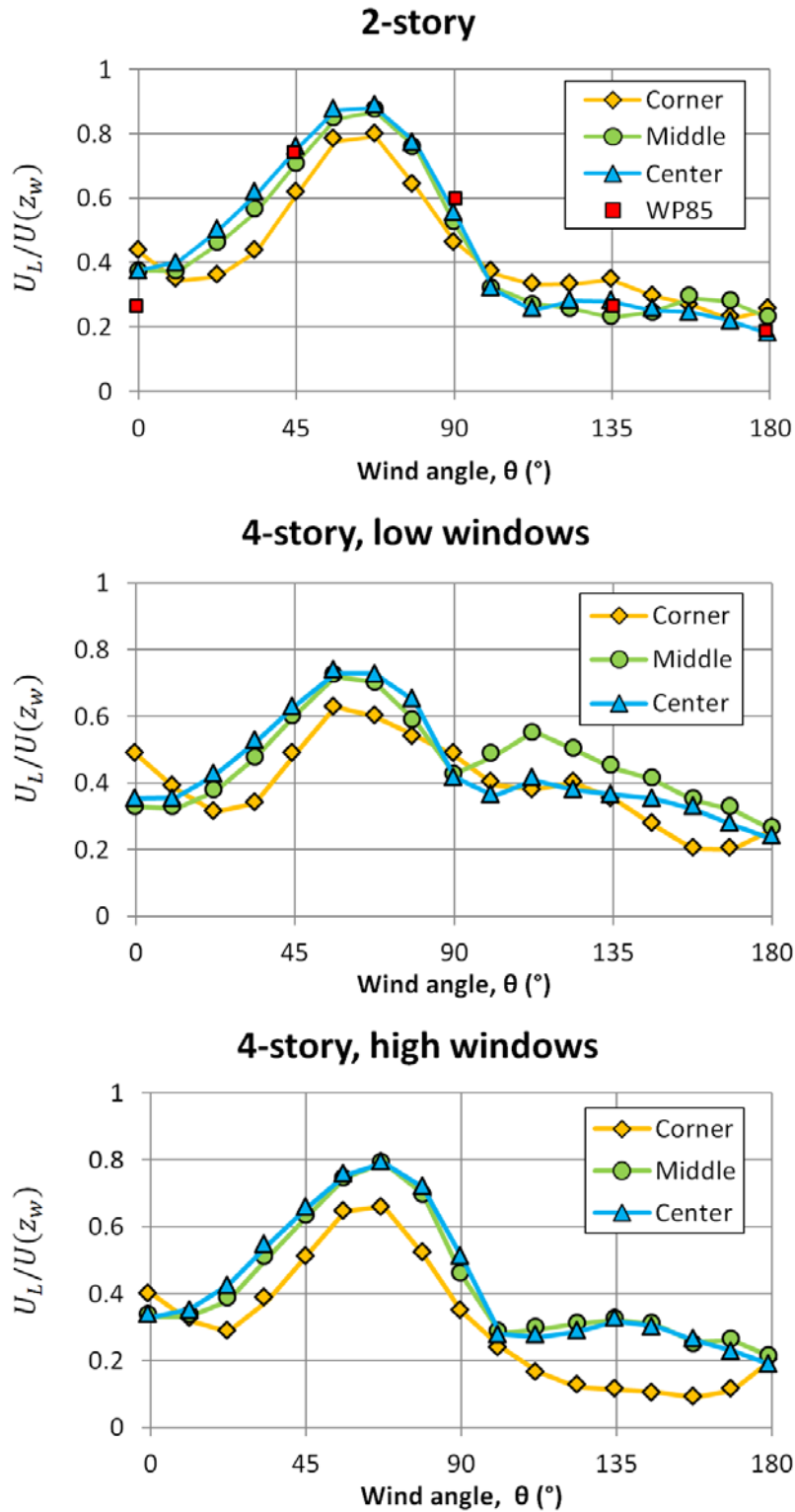
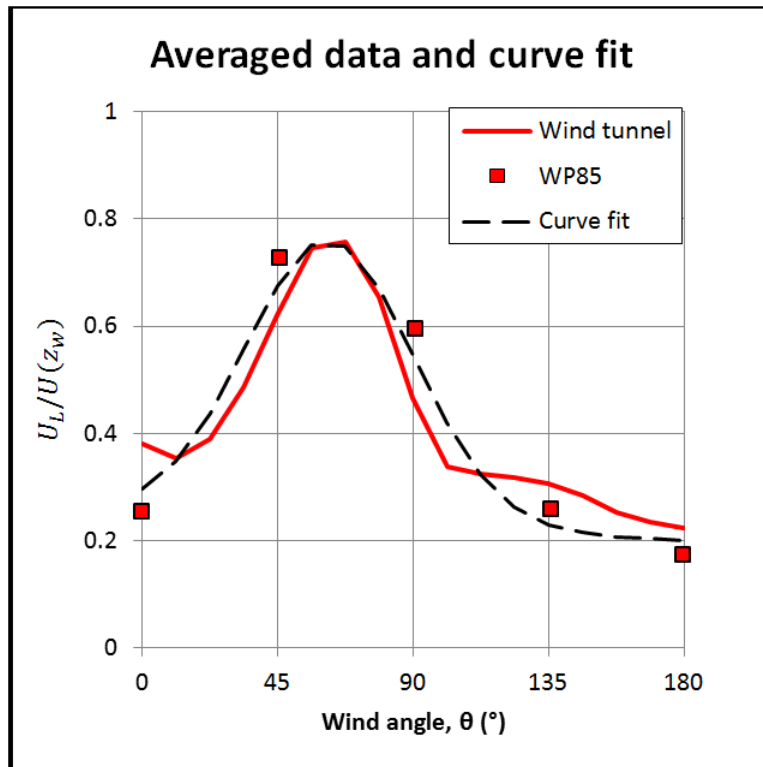

Figure 5.54: Wind Tunnel Data, Averaged Over All Cases, Plotted With Curve to fit Data



The mean error between the average data curve and the formula (5.19) is 13%. The data points from Warren & Parkins (1985) are also consistent with the average, with mean error 12% relative to the formula.

Note that the predictions for Q_w in EnergyPlus using the modified local velocity are significantly smaller than with the current formula: the auto-calculated C_w is in the range 0.3-0.55, so $Q_w/(A_{in} V)$ is in the same range; however, Figure 5.54 shows U_L/V is in the range 0.3-0.75, and therefore $Q_w/(A_{in} V)$ is considerably smaller, in the range 0.03-0.075. The flow increases as θ increases from zero, when the wind is normal to the window, to a maximum at $\theta = 60^\circ$. There is a 15% decrease when the wind is parallel to the window ($\theta = 90^\circ$), with a further reduction as the window is located in the lee of the building.

5.2.2.3 Conclusions For 1 Aperture Case

Analysis of the present wind tunnel data shows that the ventilation scales with the local velocity at the window. The present data are consistent with historical data and are well represented by (5.19)-(5.21) for the full range of wind angles. This curve fit provides the required algorithm for implementation in EnergyPlus.

5.2.3 Single-Sided Ventilation With 2 or More Apertures

Rooms larger than a double office with openings on a single façade are typically ventilated by more than one opening, and therefore require a multiple-opening SS ventilation system. Wind

driven ventilation in SS multiple opening systems is primarily the result of static pressure differences between the openings: inflow occurs in the openings with higher pressure and outflow occurs in the openings with the lower pressure, crossing the room in a trajectory approximately parallel to the façade (a flow pattern that resembles cross ventilation). Cóstola *et al.* (2010) showed that wind generated pressure variations along the façade can be significant with, therefore, the potential to generate useful flow rates.

The turbulent flow is accompanied by unsteadiness in the pressure field, which means the pressure difference not only changes with time but can also change sign. This leads to a contribution to the ventilation rate provided the frequency is low enough: if the pressure difference fluctuates too rapidly then it drives fluid in and out again before it has had a chance to mix with the internal air. Included in unsteady effects are the low-frequency periodic effects of Strouhal vortex shedding. The unsteady contribution is particularly important when the mean pressure difference is approximately zero, but is present in all cases.

In order to explore the potential of single-sided natural ventilation we will focus on a building containing a room with two openings as the simplest case of multiple-opening single-sided ventilation of practical interest and importance. Despite earlier study, this is the first attempt to quantify the ventilation rate in this situation in terms of parameters describing both the wind and the building.²⁶ We use wind tunnel data from Task 3.1, in which pressure, velocity, and ventilation rates were measured for a variety of wind, building and opening configurations, and develop correlations for the ventilation rate from these measurements.

5.2.3.1 Model Outline

Consider the non-dimensional flow rate $Q'_{in} = Q_{in}/(A_{in}U_{ref})$, where A_{in} is the area of one opening and U_{ref} is the wind speed at 10m, $U(10)$. We postulate three possible mechanisms that contribute to Q'_{in} :

- (i) *Mean Pressure Difference* When the mean difference in pressure at the two opening locations, Δp , is non-zero, this drives a mean ventilation flow that scales with $|\Delta p|^{1/2}$.
- (ii) *Unsteady Pressure Difference* This gives rise to a contribution that scales with $(\sigma_{\Delta p})^{1/2}$, where $\sigma_{\Delta p}$ is the standard deviation or RMS of the pressure fluctuations. It includes periodic Strouhal forcing ('pumping') at relevant wind angles.
- (iii) *Shear Layer Mechanism* This was discussed in some detail in connection with 1-aperture single-sided ventilation in Section 5.2.2. Its contribution to the ventilation rate, if present, scales with the local velocity parallel to the façade, U_l .

²⁶ Warren (1986) measured single sided ventilation driven by multiple openings in a single façade in a full scale building. Perhaps due to full scale measurement difficulties this study was inconclusive and did not result in a model.

This suggests that the flow rate Q'_{in} for 2-opening single-sided ventilation be written in terms of three possible contributions:

$$Q'_{in} = \left\{ a_p |\Delta c_p| + a_\sigma \sigma_{\Delta c_p} \right\}^{1/2} + a_s U_L' \quad (5.22)$$

*Mean
pressure
difference*

*Unsteady
pressure
difference*

*Shear layer
mechanism*

where a_p , a_σ and a_s are constants, and Δc_p and $\sigma_{\Delta c_p}$ are pressure-coefficient-like expressions of the mean and fluctuating parts of the pressure difference (see (5.23)).

The development of this correlation will take place in two stages.

- The first stage will show that this gives a satisfactory representation of the ventilation rate in terms of the flow variables: data from the wind tunnel tests of Task 3.1 are used to provide ventilation rates and the corresponding Δc_p , etc, and the constants are then evaluated by means of a least-squares fit to the data. This will also show that for two openings the shear layer contribution to the single-sided ventilation rate can be neglected, i.e. $a_s = 0$.
- The second stage focuses on transforming (5.22) into an expression based explicitly on parameters characterizing the set-up, such as the opening separation, s , and the wind angle, θ . This is achieved by developing expressions for the mean and unsteady pressure difference as functions of these parameters (since $a_s = 0$)

$$\begin{aligned} \Delta c_p &= f(s, \theta, \dots) \\ \sigma_{\Delta c_p} &= g(s, \theta, \dots) \end{aligned}$$

and then calculating new correlation constants a_p and a_σ by again matching the ventilation data from the wind tunnel tests via (5.22).

5.2.3.2 Problem Description

Figure 5.55 shows a building in the 2-aperture single-sided configuration. The centers of the openings are separated horizontally by a distance s , and are located at a height z_w above the ground. The openings are taken to be of the same area, A_{in} , and are at the same vertical level z_w . The mid-point between the openings, M , is a horizontal distance y_m from the building edge.²⁷ The horizontal wind, whose magnitude upstream is U_{ref} at reference height z_{ref} approaches from a direction making an angle θ with the normal to the openings façade, where $|\theta| \leq 180^\circ$.

²⁷ An equivalent way to specify the locations of the openings across the façade would have been to use their coordinates y_1 and y_2 , say. However choosing s and y_m is more physically appealing and gives better insight into the dependence of the pressure difference parameters on window position.

Figure 5.55: Single-Sided 2-Aperture Set-Up and Notation

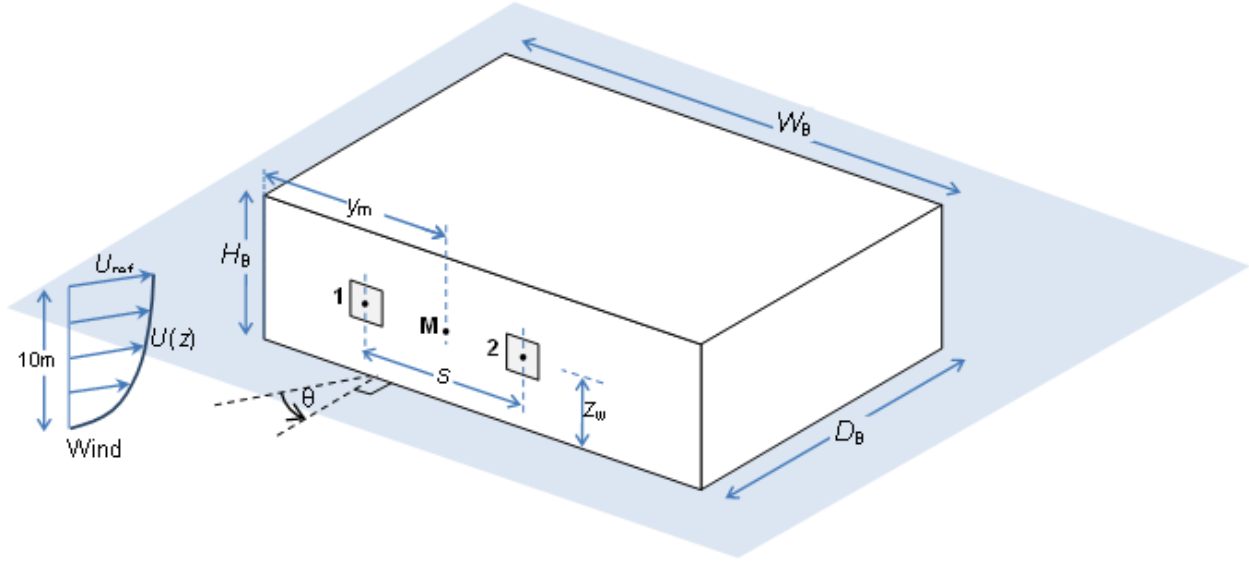

As noted above, the static pressure difference between the two openings, $\Delta p = p_1 - p_2$, will play a crucial role in the model. The mean and unsteady components of the pressure difference are given by its time-average and RMS, $\overline{\Delta p}$ and $\sigma_{\Delta p}$, respectively.²⁸

Non-dimensional quantities will be used throughout the analysis, and are denoted with a prime, e.g. s' , and defined as follows:

- Horizontal lengths: $s' = s/W_B$, $y_m' = y_m/W_B$
- Vertical lengths: $z_w' = z_w/H_B$
- Local velocity: $U_L' = U_L/U_{ref}$
- Volume flow rate: $Q' = Q/(A_{in} U_{ref})$

The static pressure (difference) uses a pressure coefficient notation, defined as follows:

$$\Delta c_p = \frac{\overline{\Delta p}}{\frac{1}{2} \rho_a U_{ref}^2}, \quad \sigma_{\Delta c_p} = \frac{\sigma_{\Delta p}}{\frac{1}{2} \rho_a U_{ref}^2} \quad (5.23)$$

²⁸ The local pressure at an opening, $p(t)$, is taken to be the average over the corresponding part of the envelope of the closed building. Then if two openings are labeled '1' and '2', the pressure difference $\Delta p(t) = p_1(t) - p_2(t)$. Since in practice the pressure is a time series, $\{\Delta p_i\}_{i=1}^N$, where $\Delta p_i = p_1(t_i) - p_2(t_i)$, the steady and unsteady parts of the pressure difference are characterized in terms of the mean and standard deviation of the time series as follows:

$$\overline{\Delta p} = \frac{1}{N} \sum_{i=1}^N \Delta p_i, \quad \sigma_{\Delta p} = \frac{1}{N} \sum_{i=1}^N (\overline{\Delta p} - \Delta p_i)^2.$$

5.2.3.3 Data Used in Analysis: a Summary

The data analyzed were those acquired in the final phase of tests in Task 3.1. For full details see Section 5.1.3.1; or refer to the summary in Table 5.16 in Section 5.2.3.11.

In summary:

- The test set-up comprised a model building containing a single room occupying an entire floor. The room had apertures distributed around its perimeter that could be open or closed.
- The building was either isolated or surrounded by a set of similar blocks of different heights and spacings to represent different urban environments.
- Measurements were made in either
 - * 'Closed box' tests where all apertures were closed and pressure and velocity measured around the building envelope
 - * Ventilation tests, where 1 or 2 apertures were open and pressure and concentration decay of a tracer gas in the room were measured

The cases selected for analysis are shown schematically in Figure 5.56.

- Building/room:
 - * 2-story, isolated (Figure 5.56(a), denoted 2-Iso)
 - * 4-story, isolated with Floor 2 room (Figure 5.56(b), denoted 4B-Iso)
 - * 2-story, low+widely-spaced blocks (Figure 5.56(c), denoted 2-LowWide)
- Openings:
 - * Wide separation (denoted S1:S8 and marked in red in Figure 5.56)
 - * Narrow separation (denoted S3:S6 and marked in yellow in Figure 5.56)
- Wind angles:
 - * 9 wind directions, namely 0° , 22.5° , ..., 180°

This gives a total of 54 cases in all.

Cases selected

This choice enabled consideration of the effect, to varying degrees, of

- Wind direction
- Opening separation
- Vertical position of openings in façade
- Sheltering by surrounding buildings

Figure 5.56: Building/Room Configurations Analyzed. S1:S8 Openings Shaded Red, S3:S6 Shaded Yellow

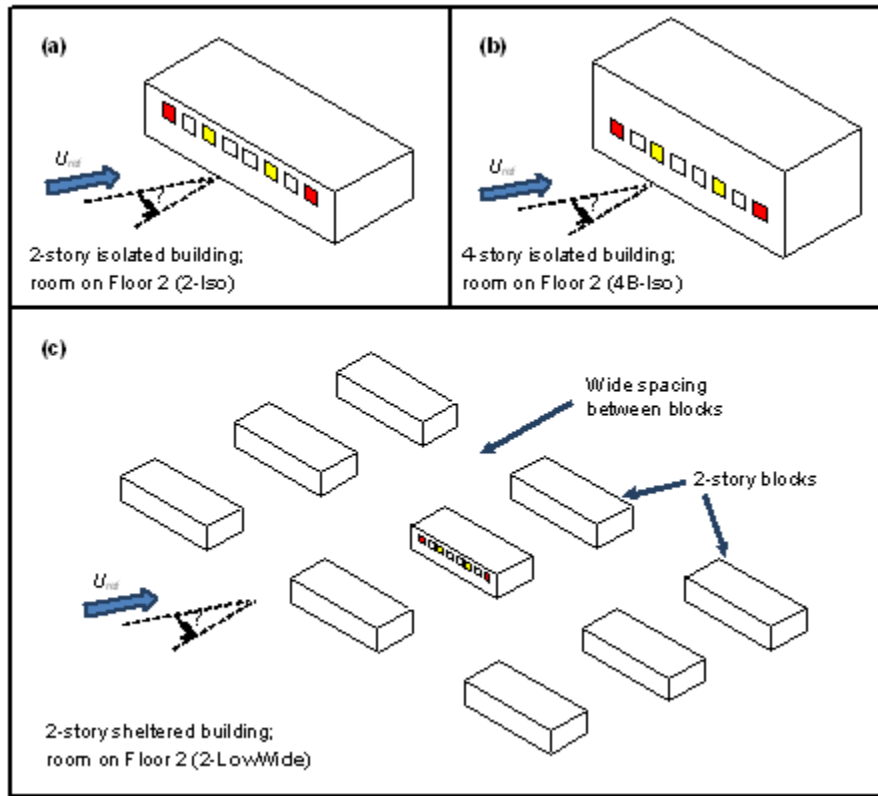

5.2.3.4 Illustrative Example

It is instructive to examine data from one of the scenarios, focusing on flow rate and pressure difference. These data are plotted in Figure 5.57 for the scenario of Figure 5.56(a). Graph (a) plots the non-dimensional ventilation rate Q'_{in} as a function of wind angle θ for the 2-story isolated building for both opening separations. Graph (b) shows the corresponding mean pressure difference coefficients, Δc_p , and graph (c) the unsteady pressure difference coefficients $\sigma_{\Delta c_p}$. The opening separation is $s' = 0.75$ and $s' = 0.32$ for wide and narrow separations, respectively.

Figure 5.57: Example of Non-Dimensional Flow Rate and Mean and Fluctuating Parts of Pressure Difference for 2-Story Isolated Building

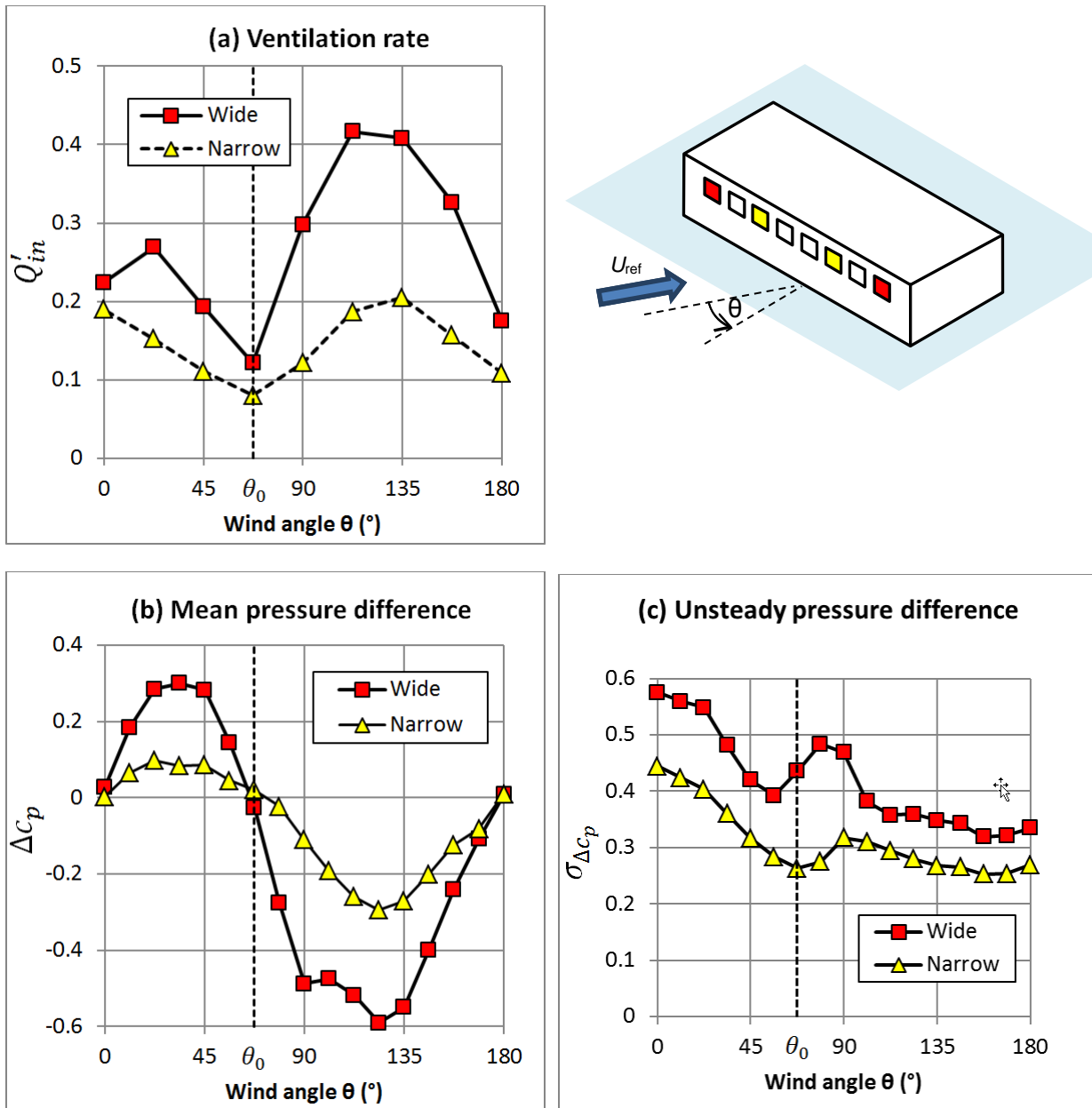

Note the following.

1. There is a clear correlation between the ventilation rate (a) and the mean pressure difference (b), with the maximum flow rate attained when the pressure difference magnitude is greatest, and the minimum flow rate when the mean pressure difference is zero.

2. However, there is a non-zero flow rate at all angles, even when the mean pressure difference is zero. The minimum flow rate is significant – still 30-40% of the maximum – suggesting that other effects besides the mean pressure difference are important contributors to the ventilation flow rate.
3. There is a substantial flow rate when the wind is head-on ($\theta = 0$), despite the negligible mean pressure difference. Unsteady effects must therefore be the major contributor to flow rate under these conditions.
4. Opening separation has an important effect on the flow rate; for the cases in the graphs there is an approximately linear increase with separation.
5. The change in sign of the pressure difference at $\theta = \theta_0$ corresponds to a change in mean flow direction, i.e. inflow is primarily through aperture 1 for $\theta < \theta_0$ and through aperture 2 for $\theta > \theta_0$. Note that $\theta_0 \neq 90^\circ$: there is a significant ventilation flow when the openings façade is parallel to the oncoming wind direction (c.f. cross-ventilation case where flow rate is minimum for 90° wind angle).

The corresponding plots for the scenarios in Figure 5.56(b) and (c) show the same features and qualitative behavior.

These points suggest that the mean pressure difference has a strong correlation with the flow rate, but cannot explain all the features of the dependence on wind angle, in particular the high values at 0° and 180° , for which $\Delta c_p \sim 0$.

The discussion of the unsteady pressure difference earlier noted that this also contributes to the flow rate. Figure 5.57(c) shows that

- (a) The maximum magnitude occurs when the wind is head-on, c.f. the local maximum in flow rate at this same angle (point (3) above).
- (b) There is the same general trend with wind angle for both separations, with a reduction in the magnitude as the separation between the openings decreases, as observed for the mean pressure difference.

The unsteady pressure is based on the standard deviation of the pressure which, by definition, includes all frequencies of fluctuations. As noted earlier, the higher frequencies will not contribute to the ventilation, so the effect of a low-pass filter applied to the pressure difference was investigated, in which only the frequencies low enough to allow fluid to penetrate significantly into the room are retained.²⁹ It was found that the effect on the curves in Figure 5.57 was to leave their shape essentially unchanged and but reduce the values by around 40%. Thus we would expect the use of filtered data rather than unfiltered data would be simply to

²⁹ The threshold used was that the frequency f is low enough that the fluid penetrates at least a distance equal to the room depth in one period. In our case this leads to the criterion $f \lesssim 30 \sqrt{\Delta c_p}$.

change the coefficients in the correlation compared with using unfiltered data. Hence at this level of approximation it is acceptable and more convenient to use the standard deviation.

5.2.3.5 Correlating Flow Rate With Pressure And Velocity

The selected experimental data provide a set of ventilation rates $Q'_{in,obs}$ spanning a range of conditions; we also have the corresponding pressure and velocity measurements giving rise to those ventilation rates. The first stage is therefore to correlate the two directly by linear regression, i.e. assuming the relationship given earlier in (5.22):

$$Q'_{in,corr} = \{a_p |\Delta c_p| + a_\sigma \sigma_{\Delta c_p}\}^{1/2} + a_s U_L' \quad (5.22)$$

Using the pressure, velocity and flow rate measurements from the database of 54 cases specified above, the procedure was

- Fix values for coefficients a_p , a_σ , a_s in the flow rate formula (5.22)
- Compute $Q'_{in,corr}$ from formula and velocity/pressure data for each case in the database
- Compute the Pearson coefficient r for the plot of $Q'_{in,corr}$ against $Q'_{in,obs}$

The coefficients were varied systematically over ranges based on some initial manual comparisons. The optimal combination of coefficients is the one giving the largest r , which was found to occur when $a_p = 0.20$, $a_\sigma = 0.10$ and $a_s = 0$, with maximal value of $r = 0.84$. Thus

$$Q'_{in,corr} = \{0.2|\Delta c_p| + 0.1\sigma_{\Delta c_p}\}^{1/2} \quad (5.24)$$

Figure 5.58: Comparison of Formula and Data for Optimal Coefficient Values

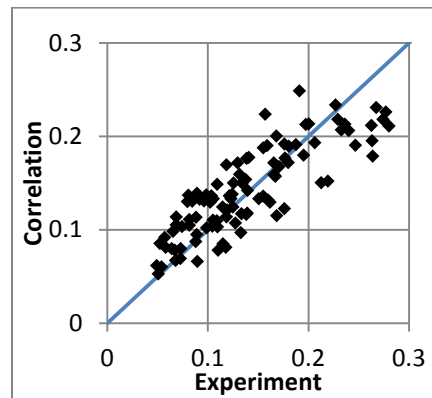

Figure 5.58 is a scatter plot of observed values versus predictions from the correlation (5.24). The representation of the experimental data across the cases is good; this is encouraging in view of the range of conditions treated together, and strengthens the argument for the proposed dependence of the flow rate on the pressure difference. The implied absence of the shear layer term is also reasonable, since conditions at the opening will tend to be unfavorable to this mechanism in the 2-opening case. The coefficients for the pressure difference terms are of

comparable magnitude, i.e. both steady and unsteady pressure variations make important contributions to the ventilation.

5.2.3.6 Correlating Flow Rate With Configuration Parameters

In a design situation the pressure data needed to evaluate Q'_{in} from (5.24) are not available as independent variables. Therefore, out of practical necessity, Δc_p and $\sigma_{\Delta c_p}$ need to be re-expressed in terms of accessible independent parameters of the problem, such as the opening separation, wind angle, and so on. A further round of analysis was therefore carried out to obtain these 'synthetic' pressure difference coefficients, which can then be reintroduced into the flow rate correlation (5.24) and new values found for the constants.

The first step is to assess which independent parameters to use. In general, Δc_p and $\sigma_{\Delta c_p}$ can be written as functions of non-dimensional parameters as follows:

$$c_p = f(\theta, s', y'_m, z'_w, \mathbf{B}, \mathbf{S}) \quad (5.25)$$

$$\sigma_{\Delta c_p} = g(\theta, s', y'_m, z'_w, \mathbf{B}, \mathbf{S}) \quad (5.26)$$

where the wind angle θ and geometric parameters s' , y'_m and z'_w were defined earlier and

\mathbf{B} represents the building shape (W_B/H_B , D_B/H_B) and surface features

\mathbf{S} represents the surroundings of the building: explicit buildings, background roughness

Note the wind velocity has already been scaled out of the problem by using pressure coefficients. The opening areas do not appear in the above statements since we seek to describe the pressure difference parameters appropriate to a sealed building. It will be assumed that the two openings are at the same height, so that we consider only pairs of points with the same vertical coordinate z_w .

We divide the parameters into primary and secondary categories:

- Primary: θ, s', y'_m
- Secondary: $z'_w, \mathbf{B}, \mathbf{S}$

We have investigated the dependence of the pressure difference parameters in some detail for the primary parameters, and in preliminary outline for the secondary parameters. This is mainly for pragmatic reasons, since although there is some variation in the secondary parameters in the available data it is insufficient for a systematic study of the effect of their variation. The analysis therefore reduces to the finding the functions f and g in equations (5.25) and (5.26), respectively.

We have used the pressure data for the long 'South' façade, which is shown schematically in the top-left portion of Figure 5.59, for two main reasons. First, this the façade pertinent to the ventilation runs; and second, it also offers the richest source of pressure difference data: there are 18 pressure sensors along the façade at the same vertical height (mid-window height), indicated by dots in the figure, and there is one test for each of the 17 wind angles. Thus Δp computed for pairs of sensors will correspond to a wide range of values of s' and y'_m , with good

resolution in the wind angle θ . Analysis of these data allowed the forms for the functions f and g to be deduced. The following process was repeated for the 3 building/room/environment (B, S) cases, and the results pooled.

Different approaches were used for the mean and fluctuating parts.

(a) Mean Pressure Difference

The mean pressure difference $\overline{\Delta p} = \overline{p_1} - \overline{p_2}$, and therefore one approach to finding the dependence on the primary parameters is to compute \overline{p} at each sensor location and combine these in all possible ways to give the corresponding pressure differences. However, it is possible to do better than this, since the mean pressure distribution at each wind angle is sufficiently smooth to allow a curve $\overline{p}(y)$ to be fitted (a 4th-order polynomial gave an excellent representation in all cases considered). This procedure enables *any* two values of y along the façade to be used in computing Δc_p , and not just the sensor positions, resulting in a continuous map of $\Delta c_p(s, y_m)$ for each set of wind and external parameters. This works because Δc_p depends *linearly* on the pressure difference.

Figure 5.59: Mean Pressure Profile Along Façade, 2-Story Isolated Building, $\theta = 45^\circ$

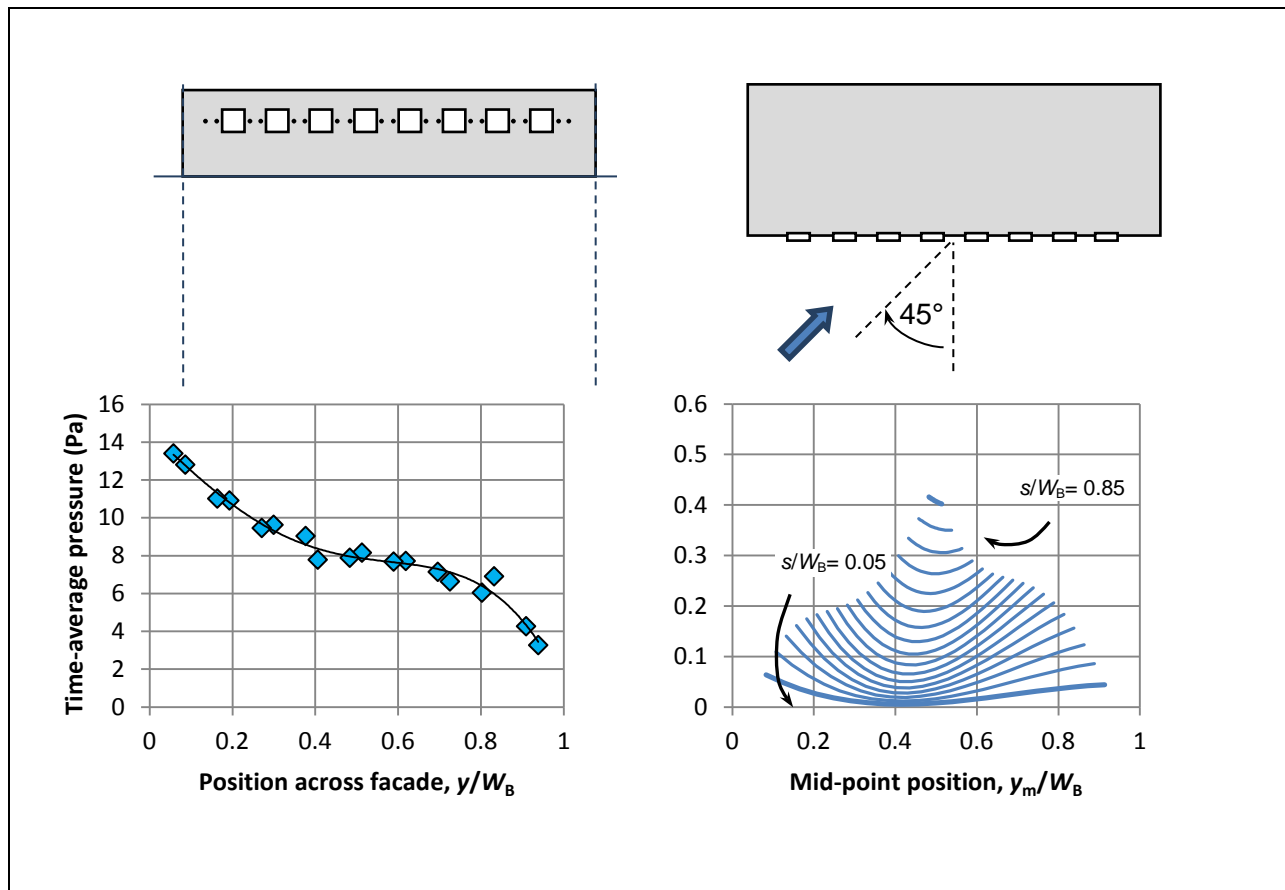

Figure 5.59 gives an example of this process for the 2-story isolated building, shown schematically above the graph, and a wind angle $\theta = 45^\circ$ (so that the façade is on the windward side of the building, and pressures are all positive). Each point on the left-hand graph is the time-averaged pressure at that sensor; the fourth-order polynomial used to fit the data has a Pearson correlation coefficient $r = 0.991$. Then pairs of points are selected: for a given separation s' , which is varied between 0.05 and 0.85, the mid-point of the pair y'_m is varied continuously over the range $s'/2 \leq y'_m \leq 1 - s'/2$. The resulting curves form a map $\Delta c_p(s', y'_m)$, and are plotted in the right-hand graph in Figure 5.59. The map was generated for all 17 wind angles for the 2-story isolated building, and then the whole process repeated for the other two scenarios, 4B-Iso and 2-LowWide.

Note that the lines of constant separation s' are quite horizontal, i.e. Δc_p depends primarily on the separation of the openings s' and only weakly on the position of the openings along the façade, y'_m , for a given separation. As the wind angle is varied this pattern is repeated.³⁰ This suggests we may simplify the data by averaging each curve $s' = \text{constant}$ over y'_m to give $\overline{\Delta c_p}(s'; \theta)$. The result of this process is plotted in

Figure 5.60 for the 2-story isolated building, plotted as a series of curves $s' = \text{constant}$ (values 0.05, 0.15, ..., 0.85). The red dots denote the points that would be obtained from averaging the corresponding curves in Figure 5.59.

We observe that at a given angle there is an approximately linear increase in $\overline{\Delta c_p}$ with separation (since the curves are at equal increments of s'), which further suggests modeling these curves (dropping the overbar) according to the formula

$$\Delta c_p(s', \theta) = s' \cdot \Pi(\theta) \quad (5.27)$$

for some universal shape function $\Pi(\theta)$. The shape is well-approximated by a piecewise-sinusoidal form:

$$\Pi(\theta) = \begin{cases} \Delta_1 \sin \left[\frac{\theta}{\theta_0} \cdot 180 \right] & \theta \leq \theta_0 \\ -\Delta_2 \sin \left[\frac{(\theta - \theta_0)}{(180 - \theta_0)} \cdot 180 \right] & \theta_0 \leq \theta \leq 180^\circ \end{cases} \quad (5.28)$$

³⁰ The main exception to this is near $\theta = 90^\circ$, when there are strong gradients in mean pressure near the edges, introducing a more marked dependence on the location of the openings when either is near an edge.

for adjustable constants Δ_1 and Δ_2 and $\theta_0 = 67.5^\circ$. By optimizing the least-squares fit of this formula to the points in Figure 5.60(a), values of 0.44 and 0.69 were found for the constants Δ_1 and Δ_2 , respectively. Substituting these into (5.27) and (5.28), and generalizing the result to negative wind angles, we obtain a formula for the mean pressure difference between the two openings:

$$\Delta c_p = \begin{cases} 0.44 \operatorname{sgn}(\theta) \sin(2.67|\theta|) \cdot s' & |\theta| \leq \theta_0 \\ -0.69 \operatorname{sgn}(\theta) \sin(288 - 1.6|\theta|) \cdot s' & \theta_0 \leq |\theta| \leq 180^\circ \end{cases} \quad (5.29)$$

$$\theta_0 = 67.5^\circ \quad (5.30)$$

Figure 5.60: Pressure Difference for 2-Story Isolated Building: (a) Mean and (b) Unsteady Parts

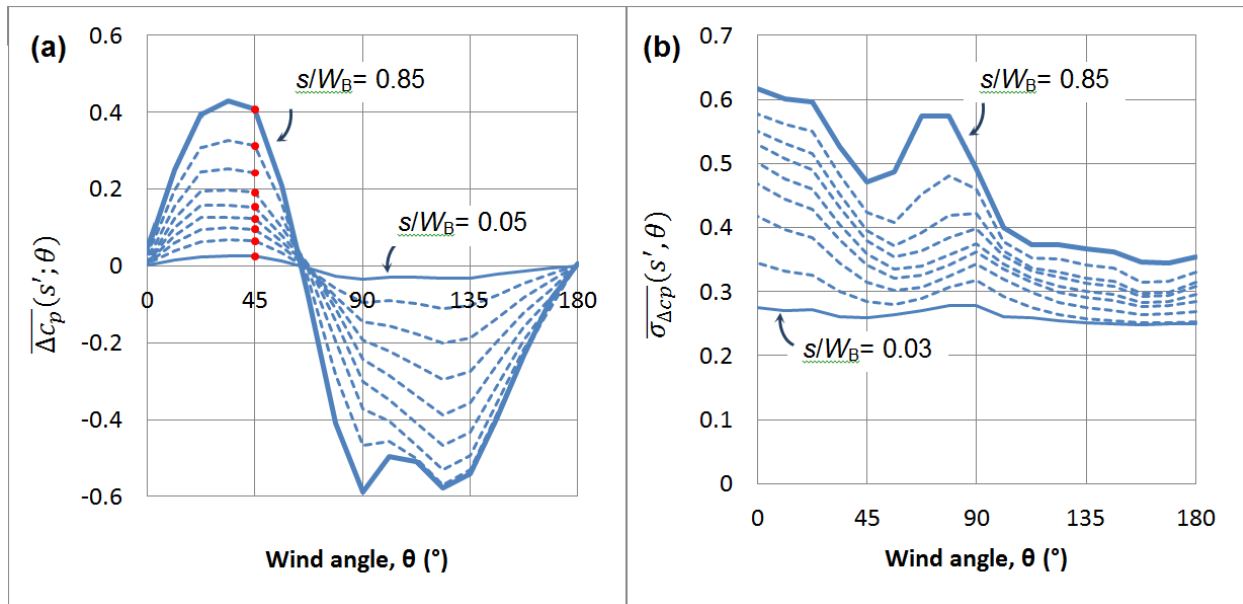

(b) Unsteady Pressure Difference

An entirely analogous procedure was followed to model the unsteady part of the pressure difference, $\sigma_{\Delta c_p}$, i.e. determine the standard deviation of the pressure difference as the two measurement locations are varied along the façade, average over the mid-point location and repeat for each wind direction and building scenario. The main difference compared with the mean pressure is that it is no longer possible to use a curve fit to the data, i.e. a curve fit of $\sigma_{\Delta c_p}(y)$ cannot be utilized since $\sigma_{\Delta p} \neq \sigma_{p1} - \sigma_{p2}$. Thus instead, all possible pairs of points were considered to generate a finite set of values $\{\sigma_{\Delta c_p}(s_i, y_{m,j})\}$ for each wind direction and building scenario. Because of the regular arrangement of sensors along the façade, these values could be grouped into sets with closely-matched separations but different mid-point coordinates, to give a discrete map of variation.³¹

³¹ The values of s' available were 0.03, 0.11, 0.21, 0.32, 0.43, 0.53, 0.64, 0.75, 0.85.

The y_m -averaged curves of $\sigma_{\Delta c_p}$ for the 2-story isolated building are shown in Figure 5.60(b). There is again a monotonic increase in $\sigma_{\Delta c_p}$ with separation, broadly linear, and here superimposed on a minimum value. Dropping the overbar, this suggests we represent the curves as

$$\sigma_{\Delta c_p}(s', \theta) = \Sigma_0 + s' \cdot \Sigma(\theta) \quad (5.31)$$

for another 'universal' shape function $\Sigma(\theta)$ and minimum threshold Σ_0 . Each curve $s' = \text{constant}$ in Figure 5.60(b) is approximated by a straight line, whose slope therefore varies between zero and a maximum value for the widest separation $s'_{max} = 0.85$ (see Figure 5.61):

$$\Sigma(\theta) = \frac{1}{s'_{max}} \left\{ \frac{(\delta_2 - \delta_1)}{180} \theta + \delta_1 \right\} \quad (5.32)$$

where δ_1 and δ_2 are adjustable constants. Using the data in Figure 5.60(b), together with the corresponding results from the other two building scenarios, the best fit is obtained with $\delta_1 = 0.36$, $\delta_2 = 0.11$ and $\Sigma_0 = 0.24$.

Figure 5.61: Linear Approximation to Unsteady Pressure Difference Curves

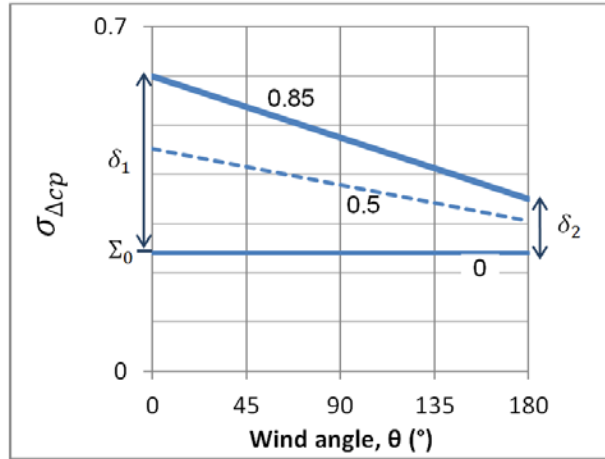

The resulting formula for $\sigma_{\Delta c_p}$ is then

$$\sigma_{\Delta c_p} = 0.24 + \{0.423 - 1.63 \times 10^{-3} |\theta|\} \cdot s' \quad (5.33)$$

This is the parameter-based counterpart to the data-based formula (5.24).

Figure 5.62 shows an example of Δc_p and $\sigma_{\Delta c_p}$ generated by (5.29) and (5.33), respectively, compared with the data for maximum separation the 2-story isolated building and wide opening separation.

Having approximated the two pressure coefficient terms in (5.24) in terms of the dimensionless opening separation and the relative wind angle, it is necessary to re-calculate the optimum

values of the coefficients a_p and a_σ . The best fit occurs with $a_p = 0.173$ and $a_\sigma = 0.042$, and combining with the previous results the final correlation formula for the non-dimensional flow rate Q'_{in} is therefore

$$\frac{Q_{in}}{A_{in} U_{ref}} = \{0.01 + [0.173 |\Pi(\theta)| + 0.042 \Sigma(\theta)] \cdot s'\}^{1/2} \quad (5.34)$$

This is the parameter-based counterpart to the data-based formula (5.24).

Figure 5.62: Example Comparison of Model and Data for Pressure Difference Coefficient

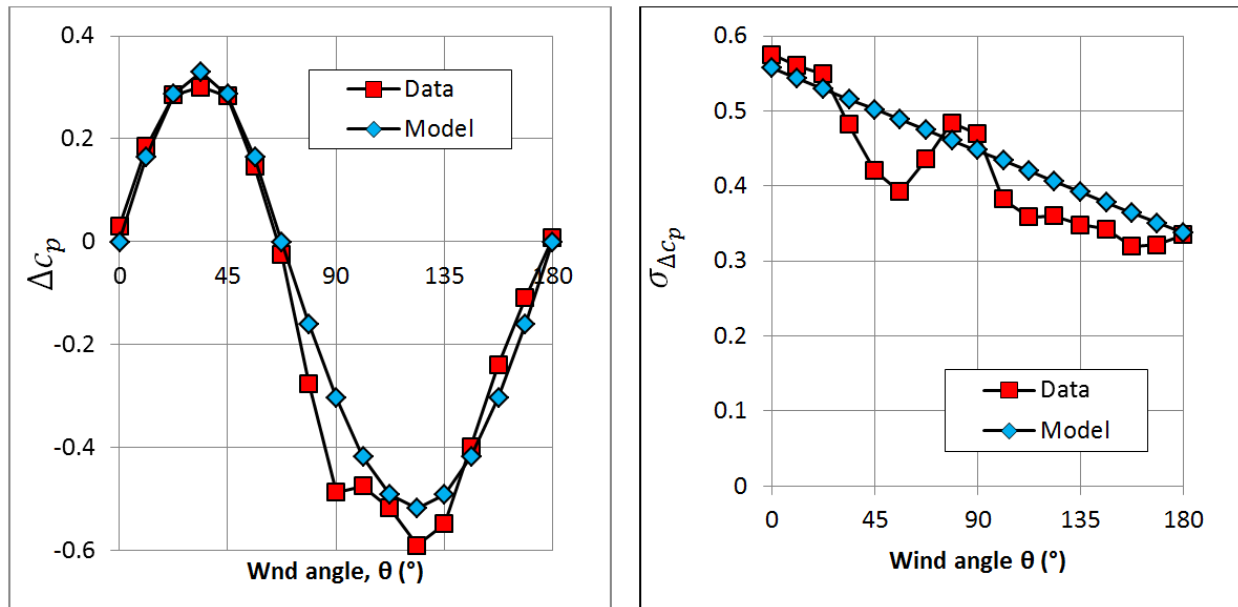

Figure 5.63 shows the comparison between the flow rate prediction using this formula and the experimental data. Each graph shows experimental data (red squares/yellow triangles) plotted against model prediction (blue diamonds). Cases in the left-hand column, (a)-(c), are for wide separation $s'=0.75$, those in right-hand column, (d)-(f), narrow separation, $s'=0.32$. The three rows are for 2-story isolated, 4-story isolated and 2-story with low density surroundings, respectively. The percentage mean error is shown for each scenario; the mean error over all 6 scenarios is 27%.³²

³² The percentage mean error for prediction X compared with data Y is defined by $|X-Y|/(0.5*(X+Y))*100$.

The flow Q_{in} is defined to be positive when opening #1 is the inlet and opening #2 is the outlet. Since Δp is defined as $p_1 - p_2$, this can occur when $\Delta c_p > 0$, which in turn corresponds to certain relative wind angles, i.e.

$$Q > 0 \text{ if } 0 < \theta < \theta_0 \text{ or } -180 < \theta < -\theta_0 \quad (5.35)$$

$$Q < 0 \text{ otherwise}$$

Note that the sense of Q is not necessarily well-defined for all such angles, e.g. when the unsteady contribution in (5.24) is significant: nevertheless, we retain this definition for all angles.

Figure 5.63: Comparison of Predicted Flow Rates with Experimental Data, Indicating Mean Error for each Scenario

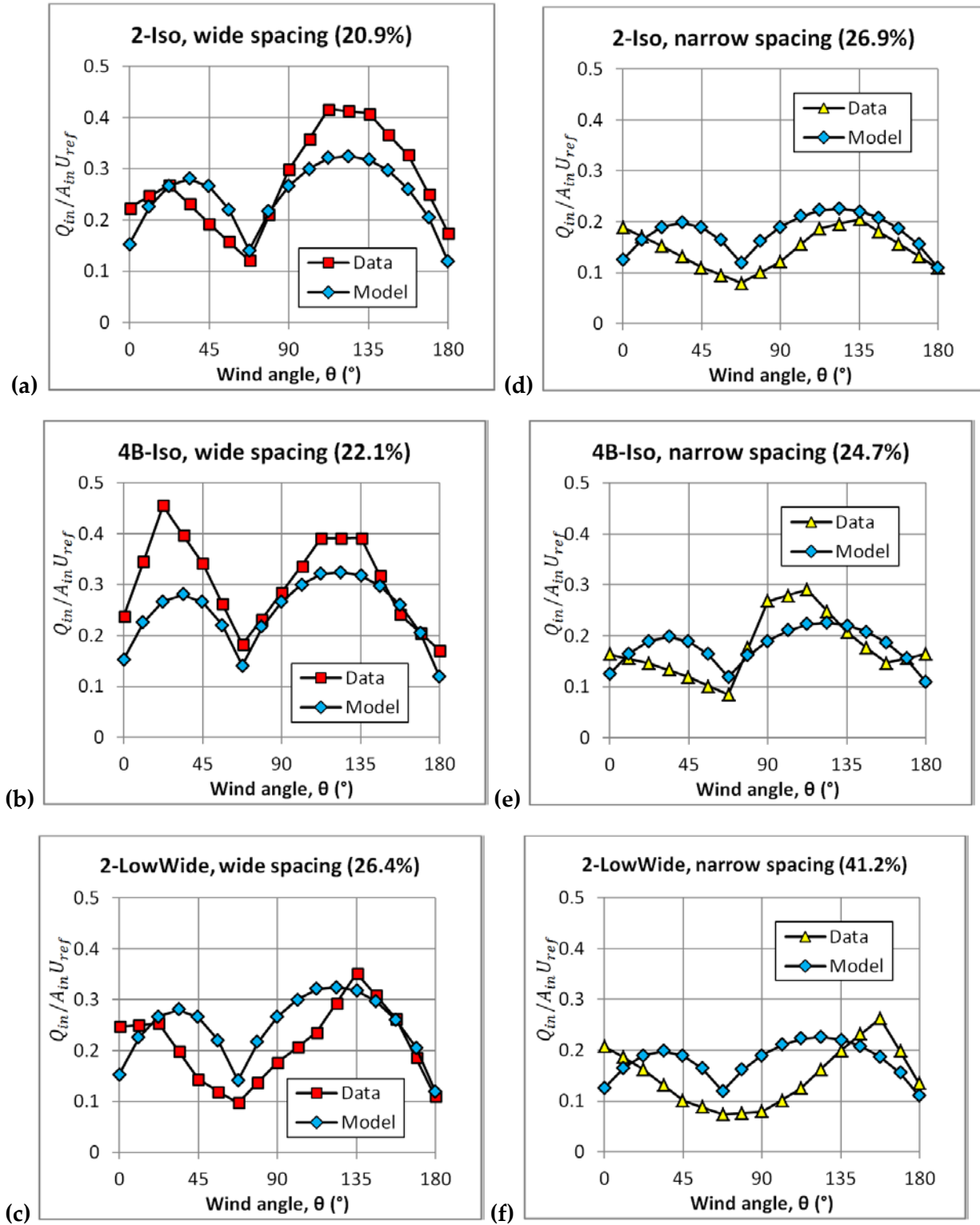

5.2.3.7 Adaptation to EnergyPlus

The formula derived for the ventilation rate can be used as a standalone result. However, it can also be re-interpreted in terms of an equivalent static pressure difference which, if applied, would result in the given flow rate. Thus if the two openings are viewed as nodes in a pressure network, specification of the pressure difference would give the required flow rate for the room. EnergyPlus contains such a model, and therefore framing the flow rate correlation as a pressure difference will make the calculation of 2-opening single-sided ventilation essentially invisible to the user. The inversion is achieved as follows.

Figure 5.64 shows a nodal representation of the 2-aperture single-sided case, in which 0 = ambient, 1 = node at upstream outer surface, 2 = node at downstream outer surface and R = room.

Figure 5.64: Pressure Network for 2-Opening Single-Sided Room

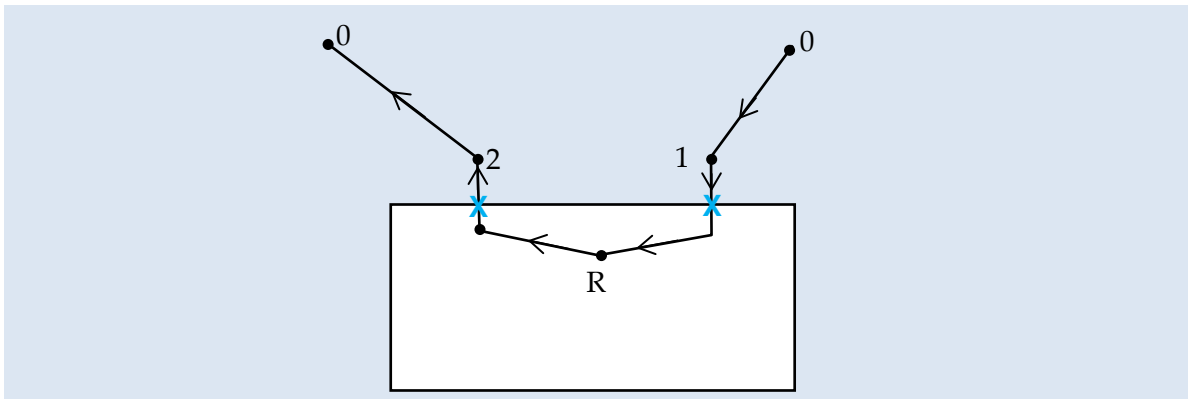

Let the openings have areas A_1 and A_2 , not necessarily equal, and a discharge coefficient C_d , which is assumed equal, and let Q be the flow rate through the system. Then it can be shown that the pressure difference between the two openings, Δp_{12} , is related to the flow rate by

$$\frac{\Delta p_{12}}{\frac{1}{2}\rho V^2} = \frac{1}{C_d^2} \left(\frac{Q/A_{eff}}{V} \right)^2 \quad (5.36)$$

where the effective area A_{eff} is defined by

$$A_{eff} = \frac{A_1 A_2}{(A_1^2 + A_2^2)^{1/2}} \quad (5.37)$$

and V is a reference velocity. The left-hand side of (5.36) is a pressure coefficient, $\Delta c_{p,12}^E$, say, and our task is to express this in terms of the flow rate in equation (5.34) but using the definition of a pressure coefficient appropriate to EnergyPlus.

The first step is to re-write (5.36) as follows:

$$\Delta c_{p,12}^{E+} = \frac{1}{C_d^2} \left(\frac{A_{in}}{A_{eff}} \right)^2 \left(\frac{U_{ref}}{V} \right)^2 Q'^2 \quad (5.38)$$

where $Q' = Q/(A_{in}U_{ref})$ is the non-dimensional flow rate of equation(5. 34), which is expressed in terms of Q , the window area A_{in} and the wind speed at 10m height, U_{ref} .

The factor $(A_{in}/A_{eff})^2 = 2$, since $A_1 = A_2 = A_{in}$, and therefore $A_{eff} = A_{in}/\sqrt{2}$. The factor (U_{ref}/V) relating the velocity scale used in the correlation with that used in the EnergyPlus pressure coefficient may be simplified by noting the following.

- (i) EnergyPlus assumes the surface pressure due to wind, p_w , is derived from a pressure coefficient C_p using the local wind speed *at window height*, $V_{ref}(z_w)$, i.e.

$$p_w = \rho_a [V_{ref}(z_w)]^2 C_p / 2 \quad (5.39)$$

Hence the reference velocity $V = V_{ref}(z_w)$.

- (ii) EnergyPlus characterizes the vertical wind profile as a power law in z , defined in terms of the local atmospheric boundary layer depth δ and a power law exponent α . EnergyPlus also uses an ‘interpolation’ formula to derive the above local wind speed from that measured at the met. site, U_{met} , according to

$$V_{ref}(z) = U_{met} \left(\frac{\delta_{met}}{z_{met}} \right)^{\alpha_{met}} \left(\frac{z}{\delta} \right)^{\alpha} \quad (5.40)$$

where the subscript ‘met’ denotes conditions at the met. site, and the default values are $z_{met} = 10\text{m}$, $\delta_{met} = 270\text{m}$ and $\alpha_{met} = 0.14$. The user can change the met. site parameters from their default values.

- (iii) The correlation in equation (5. 34) assumes the reference velocity is the wind speed at 10m., which will be taken as the local velocity at the building, $V_{ref}(10)$.

Combining these results, the pressure coefficient representing the difference in pressure between the two openings is given by

$$\Delta c_{p,12}^{E+} = \frac{1}{C_d^2} \left[\frac{V_{ref}(10)}{V_{ref}(z_w)} \right]^2 \{0.02 + [0.346 |\Pi(\theta)| + 0.084 \Sigma(\theta)] \cdot s'\} \quad (5.41)$$

where the velocity ratio

$$\frac{V_{ref}(10)}{V_{ref}(z_w)} = \left(\frac{10}{z_w} \right)^{\alpha} \quad (5.42)$$

Thus, if we assign a pressure coefficient $+0.5\Delta c_{p,12}^{E+}$ to opening 1 and $-0.5\Delta c_{p,12}^{E+}$ to opening 2, then this will provide the necessary pressure difference to give the flow in (5.34) in a network context.

Note: the pressure coefficient $\Delta c_{p,12}^{E+}$ refers to the difference in pressure between the two openings and is defined in terms of the wind speed at window height. If this is to be combined with a background pressure coefficient for the façade it is important to ensure the two are defined using the same reference velocity.

5.2.3.8 More Than Two Openings

When the façade contains N openings, where $N > 2$, we can still apply the above model, albeit with reduced confidence, by combining them into two effective openings. An algorithm to achieve this for arbitrary N is as follows.

Let the i^{th} opening have area A_i and center coordinates (y_i, z_i) , for some local coordinate system in which y is across the façade. Since the 2-opening model does not account for vertical separation of the openings, the vertical coordinate z will not be considered further. Furthermore, the choice of origin for y does not affect the results as the combination method (see equation (5.44) below) is linear with respect to y .

The algorithm is then to absorb the smallest openings successively by combining neighboring pairs until only two are left. To combine a pair, their areas are added and the combined area placed at the center-of-gravity of the original pair. Thus if the pair consists of openings with areas A_j and A_k , with center y -coordinates y_j and y_k , respectively, then these are replaced with a single opening of area A' and position y' , where

$$A' = A_j + A_k, \quad (5.43)$$

$$y' = (y_j A_j + y_k A_k) / A' \quad (5.44)$$

Figure 5.65: Example of Façade Containing More Than 2 Openings, e.g. 4 Windows Open by Different Amounts

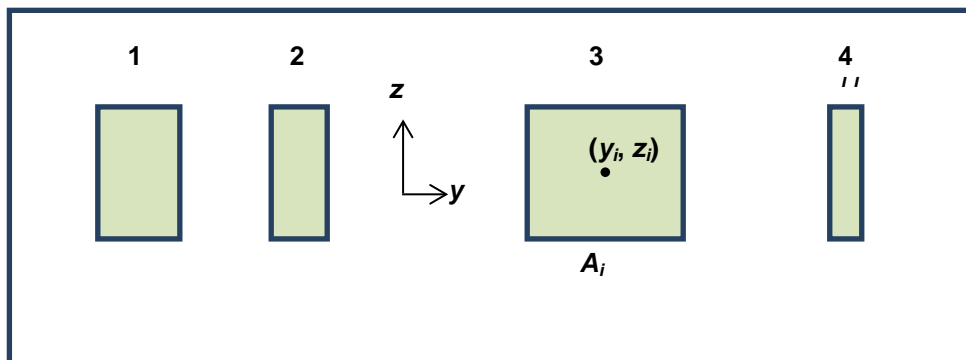

The order in which openings are combined is determined by applying the following iterative procedure to the list of openings, beginning with the original list of N :

While $N > 2$

Find opening in the list with smallest area, A_1 ;

Combine with smallest neighbor, area A_2 , to give composite according to equations (5.43) and (5.44);

Replace 1 and 2 in list by the composite;

$$N = N - 1;$$

Thus in the above simple example, 4 is combined with 3 in the first pass, then 2 is combined with 1 in a second pass. This leaves two (composite) openings, so further combination is not necessary.

The 2-aperture single-sided model shows flow rate is strongly influenced by opening separation. While the above algorithm may eliminate some of the most widely-separated openings, these should also be the smallest, and therefore unlikely to make a major contribution to the overall flow rate despite their position.

5.2.3.9 Combination of Wind and Buoyancy

Natural ventilation can be driven by wind and buoyancy. For the single opening case, predicting the combined effect of the two processes is difficult because the thermally driven two way flow in the aperture and the wind driven shear flow develop in perpendicular directions in the window plane and cannot coexist without disrupting each other. For this case the combined flow may be lower than the sum of the two composing flows. The detailed interaction between the two effects is expected to depend on window shape and needs further research that is beyond the scope of this project. For the SS two-aperture case, the coexistence of the flows is possible because both develop perpendicularly to the window. For this latter case, if we consider the interaction between the two flows as linear, the combined effect of the two flows can be estimated by adding the pressures generated by each process. Previous researcher in this area resulted in three different approaches to predict the total flow: considering only the largest of the two flows (Warren, 1978), adding the two flows (Caciolo, 2010), or calculating the total pressure (Larsen & Heiselberg, 2008; de Gids & Phaff, 1982). In summary: for the two opening case the pressure sum approach seems adequate, while for the single opening case the preferable option is not clear and further research is needed. The EnergyPlus implementation of the models developed in this section uses the pressure sum approach for the two opening case and the sum of flows for the one opening case.

5.2.3.10 Conclusions

SS2 can offer a fairly significant ventilation rate and we have made first steps to quantify this for use in naturally-ventilated rooms. We have completely characterized SS2 and extended it to SS N , for $N > 2$. We have provided algorithms that predict the ventilation over a wide range of

conditions: 2- and 4-story buildings and sheltering with low, widely-spaced blockage elements. The likely uncertainty is about 25%.

5.2.3.11 Appendix: Summary of Test Data Used in Model Development

Table 5.16 summarizes the scope of tests used in the analysis.

Table 5.16: Summary of Overall Scope of Single-Sided Tests

Feature	Options	Notes
Building	Two building shapes were used: 2-story: $W_B = 47.5\text{cm}$, $D_B = 19.3\text{cm}$, $H_B = 9.9\text{cm}$ 4-story: $W_B = 47.5\text{cm}$, $D_B = 19.3\text{cm}$, $H_B = 18.6\text{cm}$	
Environment	Instrumented building was either isolated or at the center of a 3×3 array of equal-sized blocks with same planform as building Block height: low (2-story) or high (4-story) Block separation: narrow ($\sim 0.5W_B$) or wide ($\sim W_B$)	All 5 combinations considered for closed box runs, while isolated and high/narrow only for ventilation runs
Approach flow	Suburban boundary layer, $U_{ref} \sim 10\text{m/s}$ (closed box runs) or 6.2m/s (ventilation runs), $z_{ref}=1\text{m}$. Wind direction: any value	Wind angles tested: $0^\circ, 11.25^\circ, \dots, 180^\circ$ (closed) $0^\circ, 22.5^\circ, \dots, 180^\circ$ (ventilation)
Room	Located on Floor 2 or Floor 4, with dimensions $W_{RM} = 45.9\text{cm}$, $D_{RM} = 17.7\text{cm}$, $H_{RM} = 5.0\text{cm}$	Room occupies an entire floor and was the same in all single-sided tests.
Openings	8 equally-spaced openings available across one long façade, each $2.54\text{cm} \times 2.54\text{cm}$, labeled S1 through S8.	Room contained other openings, but these are not considered further here. Beveled inserts were fitted to openings to reduce effects of wall thickness
Measured data	Static pressure: 2 or 4 pressure transducers per opening. Velocity: Hot film sensors at 6 positions around building to record flow speed near the surface. Concentration: FID sensors at 2 locations in room to measure concentration of tracer and infer ventilation rate from decay rate.	Sampling rate/duration was $1\text{kHz}/90\text{s}$ for the closed box runs and $250\text{Hz}/80\text{s}$ for the ventilation runs

5.2.4 Corner Ventilation Model

The third and final ventilation regime we consider is the corner office scenario (CR), in which the room is in one corner of the building and has openings on adjacent external walls. This is likely to be a reasonably common situation for buildings whose offices on a given floor do not

span the full depth of the building, when CV is not an option: for example, where offices are confined to the perimeter there will be four corner offices (with the remainder in between relying on SS ventilation). In the rest of this section we focus on the situation where there is a single opening on each of the two participating façades.

The fact that the openings are on different façades of the building is crucial to the understanding of CR ventilation: the sharp edges of the building result in distinct flow patterns on adjacent walls and hence quite different pressure distributions, which in turn lead to significant pressure differences between the two openings. Figure 5.66 shows an example from the CPP wind tunnel tests (January 2013, Section 5.1.3.1)

Figure 5.66: Observed Pressure Distribution Around 2-Story Isolated Building, Wind Angle 22.5°

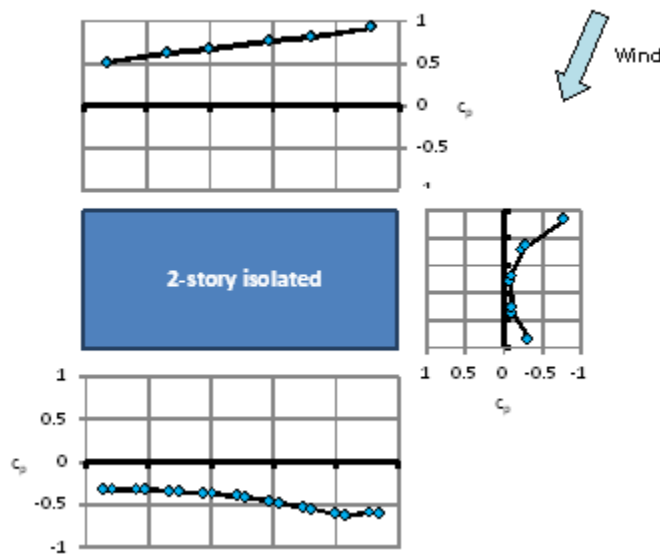

The pressure difference between two openings depends on both the ventilation regime (SS, CR, CV) and the wind direction:

- In CV, the openings are always in distinct, non-adjacent façades and therefore always benefit from disjoint profiles (except for wind directions parallel to the openings), generally resulting in a substantial pressure difference.
- In SS, the openings are by definition in the same façade, and so the pressure difference relies on variations across the façade, which are limited in magnitude
- In CR, there is a mixture of conditions (see Figure 5.67): when only one of the openings is on a windward façade this resembles CV and there will be a relatively large pressure difference; both openings are on windward façades for a third quadrant, so there will again be CV-like behavior except when the wind impinges equally on both sides (around 135° in the figure), when the pressures will balance; and finally when there are no windward openings there will be weak pressure differences and flow rate akin to SS.

These points are discussed in more detail in Section 5.2.5.

Figure 5.67: Wind Quadrants and Numbers of Windward Openings in CR

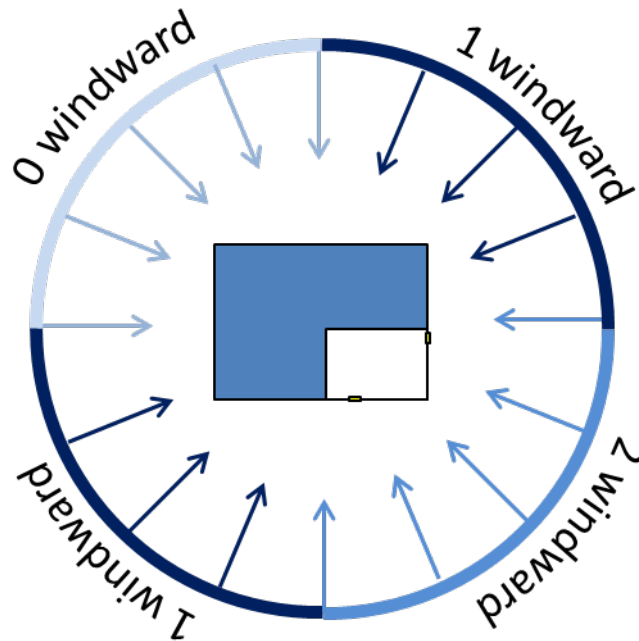

Since the pressure difference between the openings is of prime importance, it is anticipated that pressure coefficients may be used to predict the ventilation flow rate in a straightforward way. We will demonstrate that this is indeed the case through a combination of CFD and analysis of the CPP wind tunnel data. Following on from this, we will discuss the adequacy of the formula to compute (façade-averaged) pressure coefficients already included in EnergyPlus and conclude that this gives predictions of CR flow rate that are acceptable for our purposes.

Note: throughout this section we use a pressure coefficient defined with a reference velocity equal to the wind speed at building height, $U(H_B)$. This differs from the previous section on SS, in which the wind speed at equivalent 10m height was used, since here we shall employ pressure coefficients from the literature that are specifically defined in terms of $U(H_B)$. This velocity is also used in the non-dimensionalization of the flow rate, i.e. $Q' = Q/[A_{in} \cdot U(H_B)]$.

5.2.4.1 Ventilation Rate and Pressure Difference

We begin with a summary and analysis of the CPP wind tunnel CR data that are analyzed in this section.

Wind Tunnel Data

The wind tunnel tests carried out at CPP in January 2013, as described in Section 5.1.3.1, included three sets of ventilation runs with an isolated building featuring a corner office.³³ Figure 5.8 is a photo of the experimental model, and Figure 5.68 below presents a schematic of the geometry.

Figure 5.68: Building and Room Geometry for CPP Wind Tunnel CR Tests

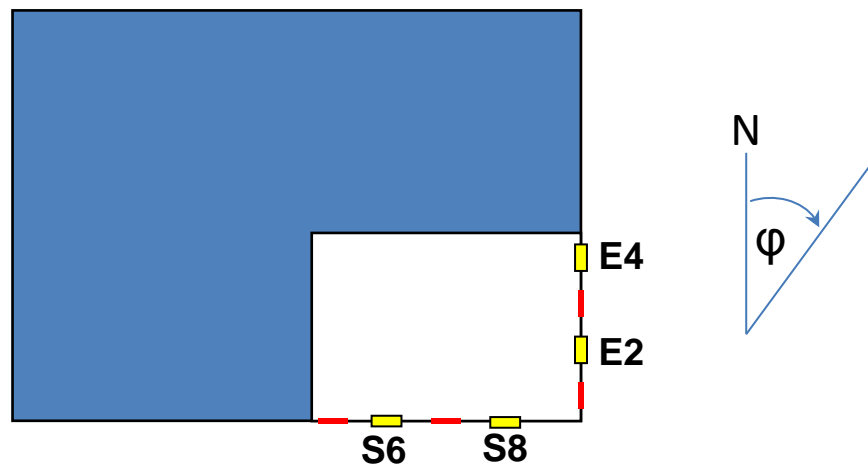

In these runs, one opening was fixed at S6, while the location of the second opening was moved progressively further round the corner office from S8 to E2 and E4, giving two sets of CR runs, denoted S6:E2 and S6:E4, plus one set of SS runs, S6:S8, for comparison. The wind angle ϕ was varied from 0° to 337.5° in 22.5° steps.

Figure 5.69(a) plots the pressure difference in the form of $\sqrt{|\Delta c_p|}$, where Δc_p is the difference in mean pressure between S6 and the second opening, $\bar{p}(S6) - \bar{p}(X)$, expressed as a pressure coefficient (see Section 5.2.3.2). Clearly the pressure difference is generally significantly greater for the two CR cases compared with the SS case except when both openings are in the building wake (wind angle $\phi = 270\text{--}360^\circ$), for which the pressure difference is comparable in all three cases, and also around $\phi = 135^\circ$, for which the two facades containing the openings will have approximately the same pressure distribution and the pressure difference is therefore small.

The non-dimensional flow rates are plotted together in Figure 5.69(b). For the two CR cases there is a clear correlation between the flow rate and pressure difference, $\sqrt{|\Delta c_p|}$, with the largest pressure differences yielding the highest flow rates. Again, note that when both openings are in the wake, and again around $\phi = 135^\circ$ all three cases have comparable, relatively small flow rates.

³³ Unlike the other building geometries discussed in Section 5.2.3 on SS ventilation, there were no closed building runs for this geometry in the CPP wind tunnel tests, so the pressure data were gathered with the apertures open, which will have some effect on data from the sensors adjacent to the openings.

Figure 5.69: Corner Building Observations of (a) Pressure Difference and (b) Flow Rate

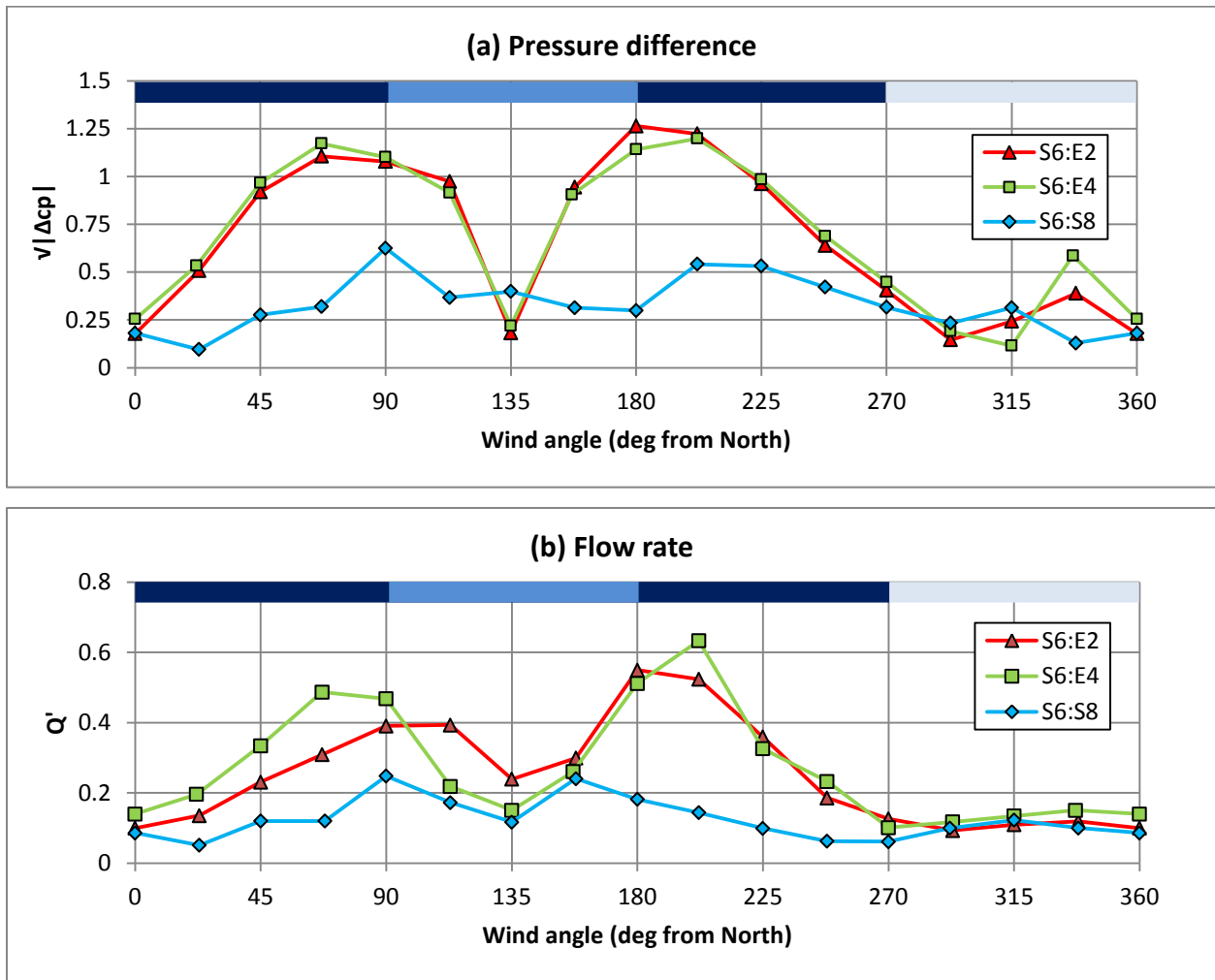

Note that the color bars above each chart correspond to the wind quadrants defined in Figure 5.67.

Simple Modeling of Flow Rate

As discussed earlier, in Section 5.2.3.7, it is straightforward to express the flow rate in terms of a mean pressure difference and show that when the two openings have the same area and discharge coefficient, C_d ,

$$Q' = C_d \sqrt{\frac{|\Delta c_p|}{2}} \quad (5.45)$$

Figure 5.70 shows the results of evaluating this formula using the observed pressure difference in each of the two CR cases and comparing with the observed flow rates. Clearly the mean pressure difference predicts the flow rate well for most wind angles, and is reasonable even

when the openings are both in the building wake. The minimum in flow rate around 135° is somewhat under-predicted.

Figure 5.70: Comparison of Observed CR Flow Rate with Predictions of Formula (5.36) Using Observed Pressure Data

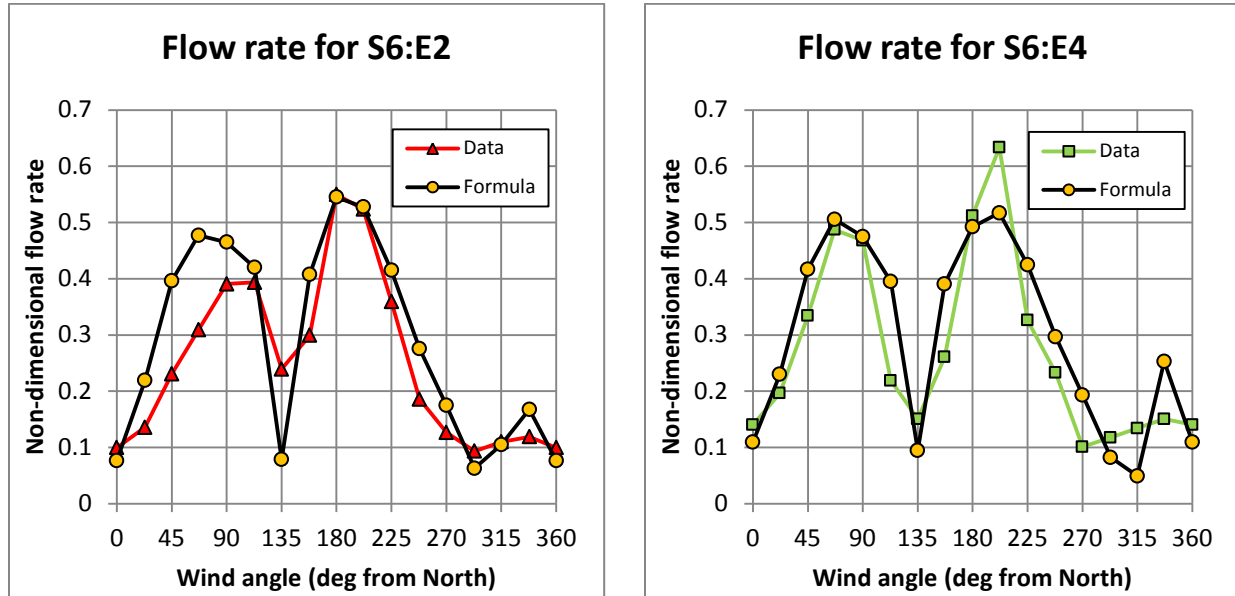

Unfortunately, this application of the formula (5.36) runs into the same difficulties as the earlier SS formula (Section 5.2.3.1), namely that it uses the observed pressure data for the specific tests, which would not generally be available. . Hence, as for the SS model, we must find an alternative route to the pressure difference coefficient, Δc_p , preferably one that is straight-forward to implement in EnergyPlus. In the next section we focus on the capability already within EnergyPlus.

5.2.4.2 Pressure Coefficient Formulae

EnergyPlus has a built-in capability to calculate wind pressure coefficients. For low-rise buildings it uses the correlation developed by Swami & Chandra (1988), who condensed published data to obtain the following correlation formula for $c_p(\theta)$, the pressure coefficient of a building façade at angle of incidence θ :

$$c_p(\theta) = c_p(0) \cdot \ln\{1.248 - 0.703 \sin(\theta/2) - 1.175 \sin^2 \theta + 0.131 \sin^3(2\theta G) + 0.769 \cos(\theta/2) + 0.07G^2 \sin^2(\theta/2) + 0.717 \cos^2(\theta/2)\} \quad (5.46)$$

In this formula, W_1 is the width of the façade of interest, W_2 is that of the adjacent façade and $G = \ln(W_1/W_2)$. The angle of incidence θ lies in the range $0 \leq \theta \leq 180^\circ$, and symmetry implies that $c_p(-\theta) = c_p(\theta)$.

Note that it requires knowledge of the pressure coefficient at normal incidence, $c_p(0)$; Swami & Chandra (1988) recommend a value of 0.6 as a suitable general-purpose value for most situations in the absence of more specific information.

Figure 5.71 shows the observed non-dimensional flow rate for both corner cases plotted against the predictions of Equation (5.36) using the EnergyPlus formula (5.46) to calculate the pressure coefficients for the South and East faces, and hence the difference Δc_p . The level of agreement is generally very similar to that obtained in Section 5.2.4.1 using the observed pressure data, although agreement for the wake wind directions is poorer. This reflects the level of fidelity that the formula (5.46) is able to achieve.

Figure 5.71: Comparison of Observed CR Flow Rate with Predictions of Formula (5.36) Using Pressure Coefficients Obtained From (5.46)

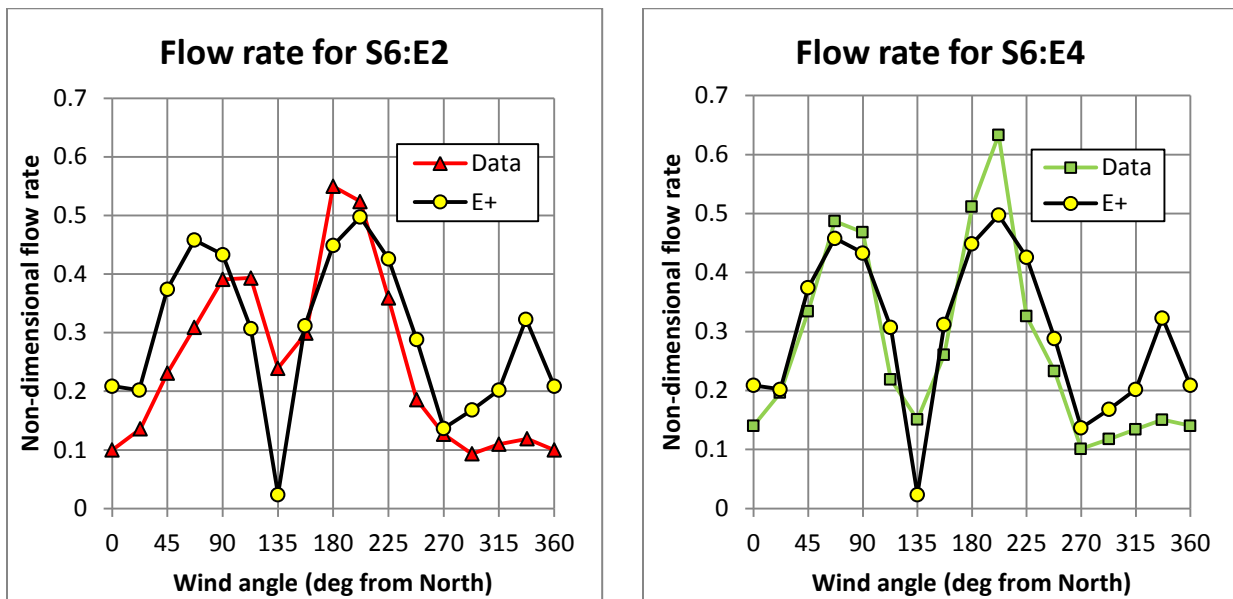

In the rest of this section, we consider the following:

- Limitations of using the façade-averaged formula (5.46) to model the pressure coefficients in this corner case
- Implementation

Limitations

- Hard-wired values of $c_p(0) = 0.6$ and $C_d = 0.61$.

The formula (5.46) requires a value for the pressure coefficient at normal incidence, $c_p(0)$, to be specified. EnergyPlus uses 0.6, the value proposed by Swami & Chandra (1988) as a representative value appropriate for most situations. To test the validity of this assumption,

Figure 5.72 shows a comparison of pressure coefficients from this formula and from CFD simulations of a closed building for angles of incidence near zero.³⁴

Figure 5.72: Assessment of Assumed Value of $c_p(0) = 0.6$

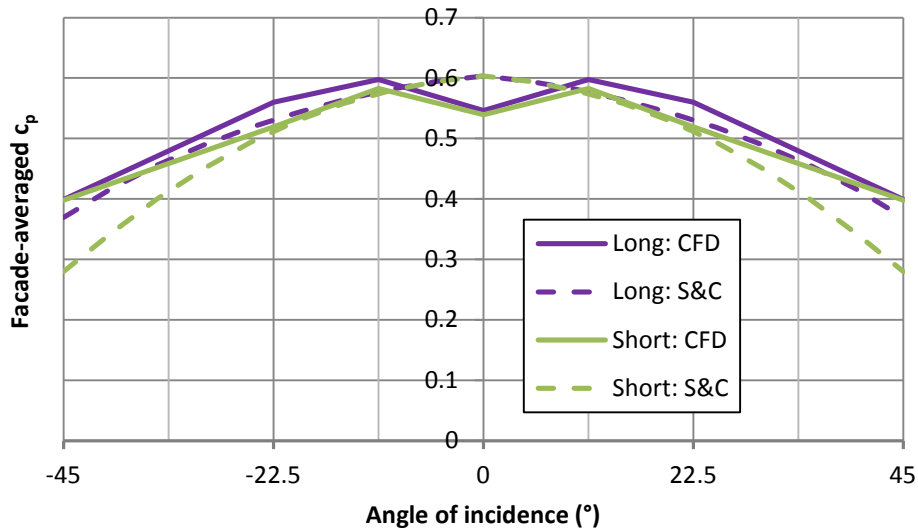

The plot compares the Swami & Chandra (1988) formula against CFD predictions for the same building aspect ratio (W (long) / W (short) = 2.5).

For a building shape relevant to the present experimental study, the figure suggests that the choice of $c_p(0) = 0.6$ is reasonable in this case – for both the long and short sides of the building, despite a significant difference in length (the aspect ratio = 2.5). This may be partly fortuitous, as for example CFD simulations of the corner building indicated a value closer to 0.4. However, this is a topic for future investigation, and, from a practical perspective, the above results indicate the default value $c_p(0) = 0.6$ is satisfactory.

The value for the discharge coefficient $C_d = 0.61$ is that for a sharp-edged orifice, appropriate to a fully open aperture. Its value can be adjusted in EnergyPlus.

³⁴ The CFD simulations in question modeled the flow around a closed building with dimensions $W_B = 5\text{m}$, $D_B = 2\text{m}$ and $H_B = 1\text{m}$, i.e. close to a scaled-up version of the CPP 2-story building (see Figure 5.7). The CFD predicted pressure coefficients across the building width that agreed well with the data, justifying further quantitative comparisons, such as the area-averaged pressure coefficients. CFD allowed façade averages to be computed and compared with those from (5.46), unlike the wind tunnel data, which are available only at a single height.

b. Departures from façade-average value.

The combination of (5.36) and (5.46) predicts the same flow rate regardless of the location of the apertures because of the use of façade-averaged pressure coefficients. The question therefore arises of whether this is a reasonable limitation.

If the pressure coefficients are known at the aperture locations these can be supplied to EnergyPlus, for example calculated by a model such as the TNO Cp Generator web-based model.³⁵

If instead (5.46) is used to calculate c_p , it is difficult to make general comments on the likely errors for arbitrary building shape. Nevertheless, Figure 5.73 illustrates the effect on the pressure coefficient of varying the aperture height. The figure shows the horizontally-averaged pressure coefficient at various non-dimensional heights $z' = z/H_B$ obtained from the CFD runs referred to in (a) above. The curves suggest the variations with height are greatest when the wind is near to normal incidence and for certain wind directions when the façade is in the wake, varying by up to $\pm 20\%$ from the façade average.

Figure 5.73: Comparison of Façade-Averaged and Horizontally-Averaged CP

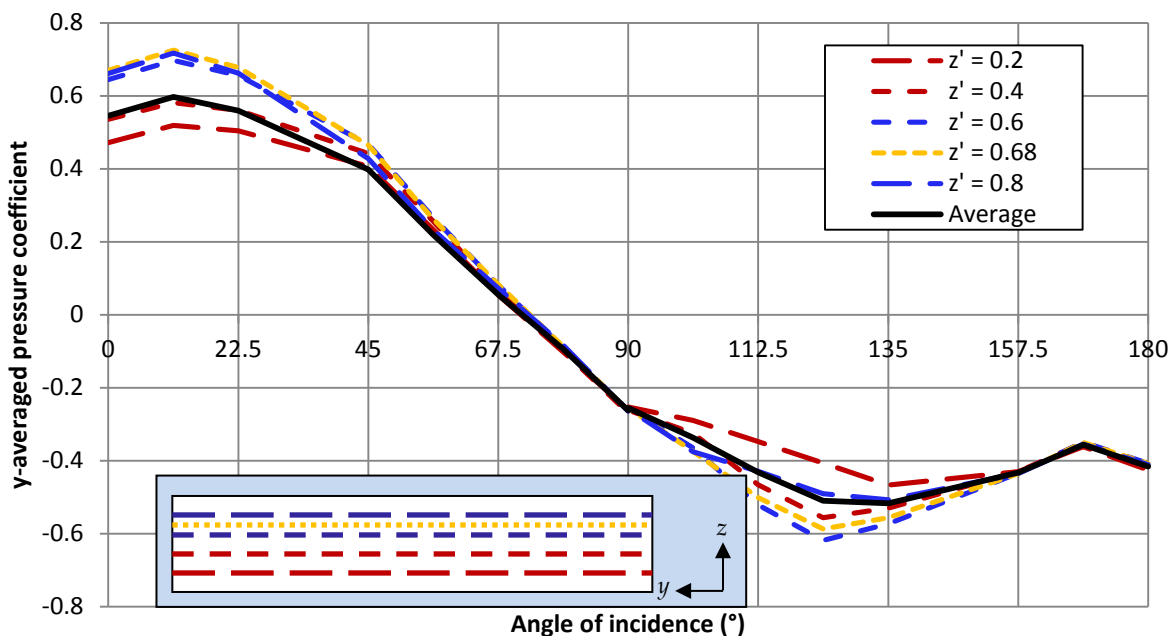

Dashed curves give c_p values averaged along the façade at a given height $z' = z/H_B$ (see inset, showing corresponding lines on façade elevation); solid curve is façade-averaged value.

³⁵ See <http://cpgen.bouw.tno.nl/Cp/> for further information. Results for Δc_p for S6:E2 and S6:E4 using Cp Generator showed better quantitative agreement than (5.46) for the wake wind angles, but less close agreement for the other angles.

c. Unsteady contribution.

The above discussion suggests that, unlike the SS2 case, the flow rate is adequately predicted using the mean pressure difference without recourse to detailed consideration of the unsteady component of the pressure difference.

Referring to Figure 5.69, the only wind direction for which there is a significant flow rate but small pressure difference is $\phi = 135^\circ$, the angle at which the two sides will experience approximately the same pressure near the corner – the flow rate does not show a corresponding drop, which is attributable to unsteady effects. A simple way to allow for this is to define a minimum flow rate Q'_{min} with a value of say 0.1, which translates into a minimum pressure difference coefficient according to

$$|\Delta c_p|_{min} = 2 \left(\frac{Q'_{min}}{C_d} \right)^2 \quad (5.47)$$

(With the previous values of $Q'_{min} = 0.1$ and $C_d = 0.61$, we obtain $|\Delta c_p|_{min} = 0.054$.)

Implementation

The forgoing discussion means that modifications to EnergyPlus are minimal since the core model (AirflowNetwork) will handle the corner case as is. Changes that will be required are:

- (a) Implement the minimum flow rate/pressure coefficient. Recall that this pressure coefficient is defined with reference velocity $U(H_B)$, so this must be reconciled with the definition in EnergyPlus, which is based on the wind speed at the local height.
- (b) Check that there is a single opening in each of the two exterior façades. If this is not the case then amalgamate them into single effective openings.

5.2.4.3 Conclusions

The discussion in this section has concluded that the flow rate for a corner office with one opening on each external façade can be satisfactorily predicted by the mean pressure difference between the two apertures and that this is adequately characterized by the pressure coefficient correlation of Swami & Chandra (1988), which is already available within EnergyPlus. Other than ensuring that the corner room is represented with two apertures and placing a lower limit on the pressure difference, the corner case can be modeled with EnergyPlus with minimal modifications.

5.2.5 Comparison of Ventilation Regimes for 2 Openings

The discussion in the previous sections makes it clear that in a situation with two openings, a prime determinant of the flow rate is the mean pressure difference between the openings. This depends strongly on one or both of the position of the openings and the wind direction; in this section we investigate this dependence for all three ventilation regimes, and give, in the context of a 2-story isolated building, a quantitative estimate of the flow rate for any combination of opening positions and wind directions. We will confirm that CR has much of the character of CV, and that in general both have significantly greater flow rates than SS.

In essence, the investigation follows these steps.

- (1) The analysis is based on the data collected in the CPP wind tunnel tests, in this instance from the 2-story isolated building runs. These tests measured pressure profiles at a fixed height above the ground along 3 sides of the test buildings for wind directions ranging over $0-180^\circ$ at intervals of 11.25° . In particular, the façade spanning the building width W_B had 17 pressure sensors, giving good spatial resolution.
- (2) For each wind direction ϕ_i , the mean pressure profile on this façade $\bar{p}(y'; \phi)$ is expressed as a function of non-dimensional distance along the façade, $y' = y/W_B$. This profile can be approximated well by a polynomial curve fit in y' (recall Section 5.2.3.6) over the range covered by the sensors ($0.057 \leq y' \leq 0.938$).
- (3) We assume that the same functions can be used to obtain the pressure on the other facades, scaled with their own length (W_B or D_B) and using an appropriately-selected wind direction.
- (4) By putting these data together, and using symmetry, a profile around the entire building (at the given height) can be obtained from 0° to 360° at 11.25° intervals.
- (5) These profiles can be used to generate mean pressure difference coefficients for any pair of points y'_1, y'_2 around the building perimeter and any of the available wind directions, $\Delta c_p(y'_1, y'_2; \phi_i)$, from which a first order estimate of the wind-driven flow rate Q' is obtained from the simple formula (5.36). In particular, the points can be on the same, adjacent or opposite façades, corresponding to SS, CR and CV, respectively.

We illustrate this process by showing the predicted non-dimensional flow rates Q' for three broadly comparable examples, one each from the three ventilation regimes, illustrated in Figure 5.74.³⁶ In each case, the openings are limited to a range of positions, each range given in terms of a local y -coordinate defined in the sense shown in the figure along its respective side. Each range covers approximately half the building side.

³⁶ This reason for this choice is so that the CR case has the same range of opening positions as the Corner building in the CPP wind tunnel tests, in which the room dimensions were approximately half the building dimensions; the SS and CV cases were then chosen to use approximately the same fractional ranges on their respective sides.

Figure 5.74: Range of Opening Positions Considered for Each Ventilation Regime

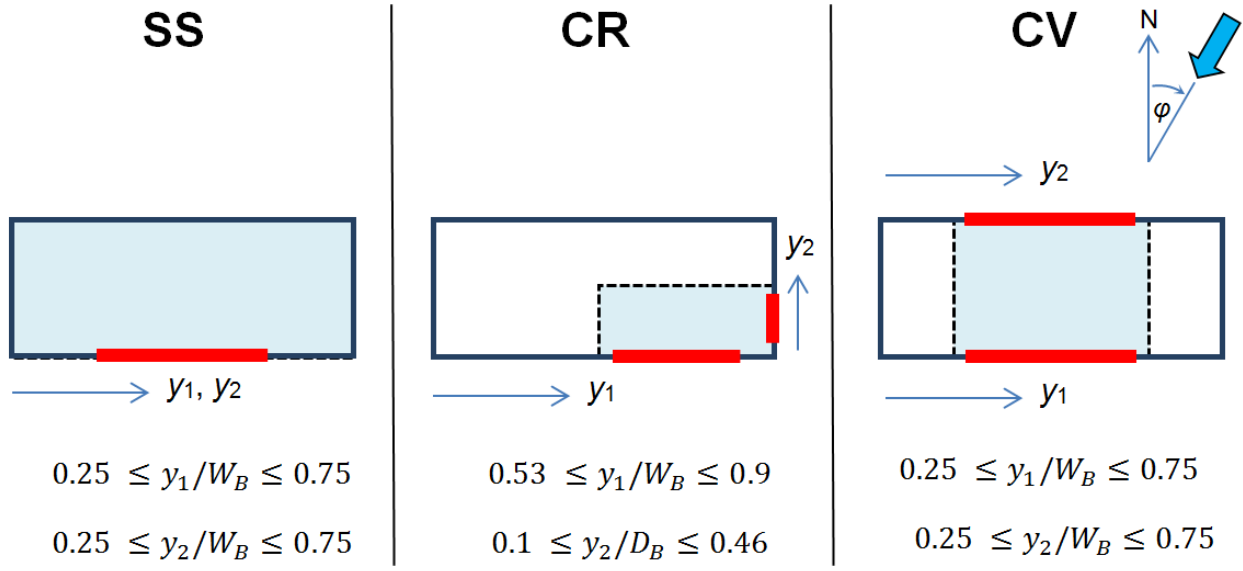

Figure 5.75: Presentation of Non-Dimensional Flow Rate as a Function of Opening Positions: Example Case of SS Configuration and Wind Direction $\phi = 45^\circ$

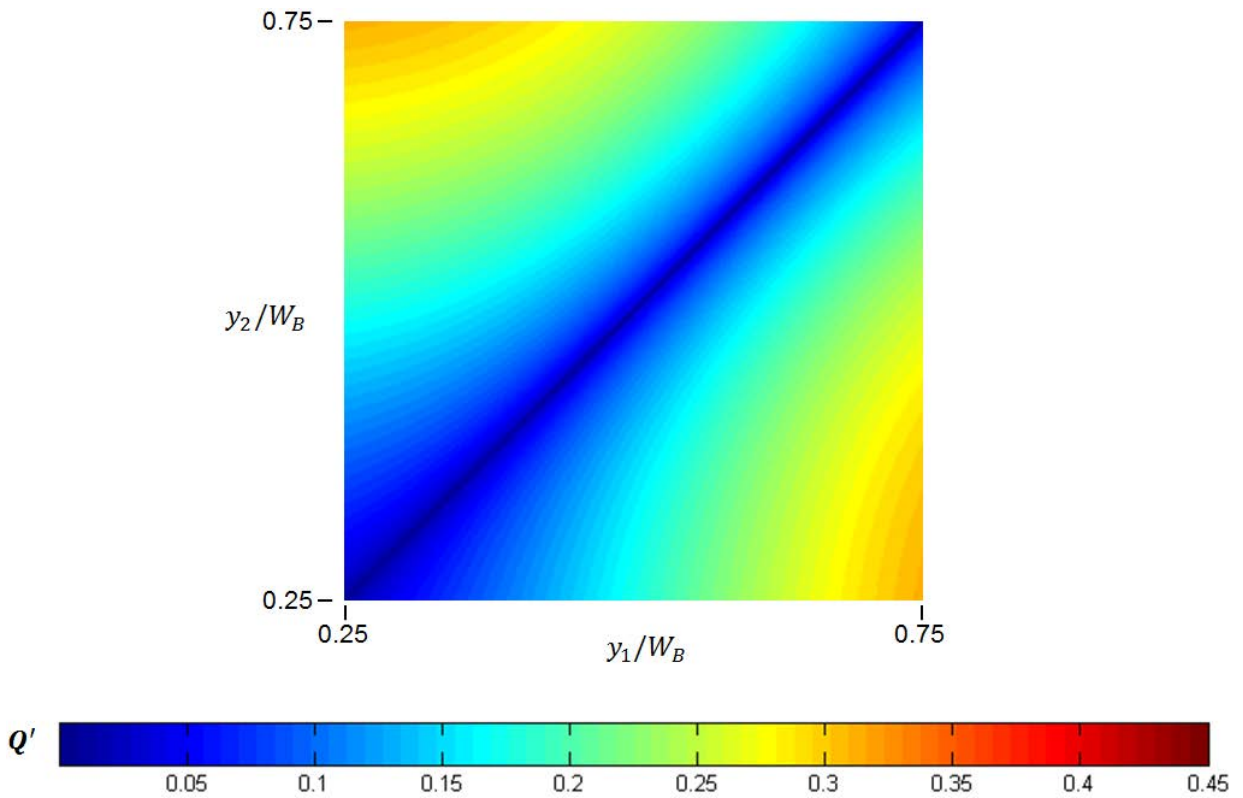

Figure 5.75 shows an example of the results for Q' as a contour plot: each combination of opening positions corresponds to a point on the plot whose color gives the value of Q' , which lies in the range $0 \leq Q' \leq 0.45$. A resolution of $\Delta y' = 0.002$ was used so that there are around 250 points in each direction. Note that along the diagonal line, $Q' = 0$ since this corresponds to the openings at the same location, $y_1 = y_2$, while the maxima at the corners of the plot occur when the openings are at opposite ends of their range.

Figure 5.76 presents the same plot as the previous figure but for all wind directions and all three ventilation regimes (left-hand column), together with the average over all wind directions (right-hand column). In the figures on the left, each plot is at a position appropriate to the wind direction giving rise to the plot. From these the intermediate nature of the CR case is clear, resembling a CV regime over the majority of wind angles, except for the quadrant opposite the corner occupied by the room, which resembles the SS case. The right-hand plots display in each case the average of all the plots around the corresponding circle. These wind-averaged flow rates also clearly align the CR case more closely with the CV case than the SS case.

Note:

- (a) The general alignment of the contours in the SS case with the diagonal is a further manifestation of the observation made in Section 5.2.3.6 that the opening separation, s , is the dominant determining factor for the SS 2-opening flow rate: points with the same separation have $s = y_1 - y_2 = c$, for constant c , and therefore $y_1 = y_2 + c$, which is a line parallel to the diagonal.
- (b) The CV case shows very little variation with opening position

We can display the averaged results in another way, as a histogram of values. Figure 5.77 shows the points sorted into 100 equal bins spanning the range $0 \leq Q' \leq 0.45$ and normalized by the total number of points in each plot (around 250^2). Again, the closer alignment of CR with CV compared to SS is evident.

The curve for each regime can also be viewed as a probability distribution: the height of the curve at a given Q' gives the probability of obtaining that value (or range for that bar) if the opening positions are chosen at random.

Various simplifications have been made that have some effect on the results include the following:

- The data used in the analysis were obtained for a single height and building shape and environment. The set of pressure profiles used as the basis of the analysis are likely to vary with all of these, but the CPP database could be used to investigate this effect.
- We have used the mean pressure difference only with no effects from the unsteady component; this can be important when the mean pressure difference is small or zero.

Figure 5.76: Variation With Wind Direction (Left) and Average Over Wind Directions (Right)

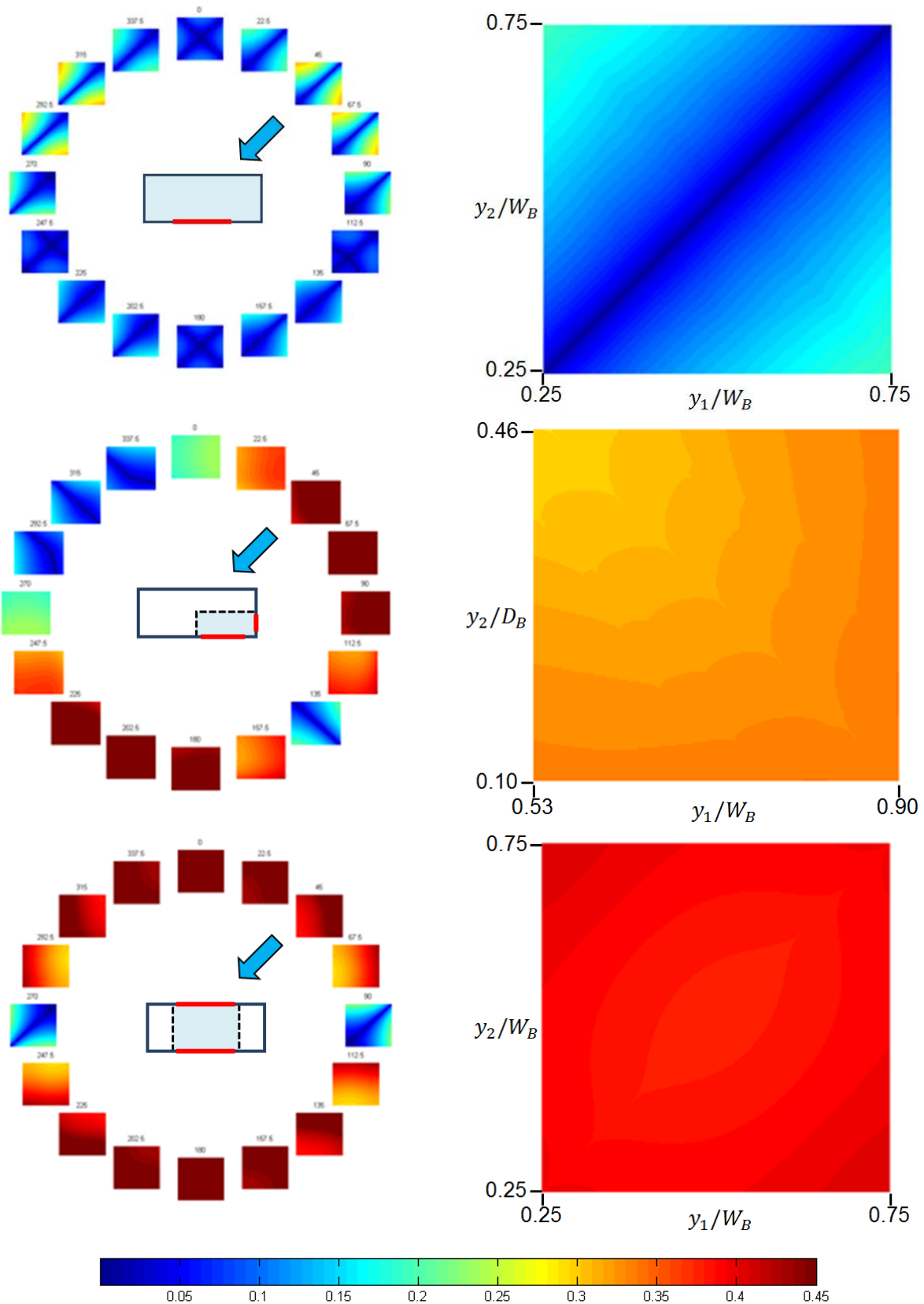
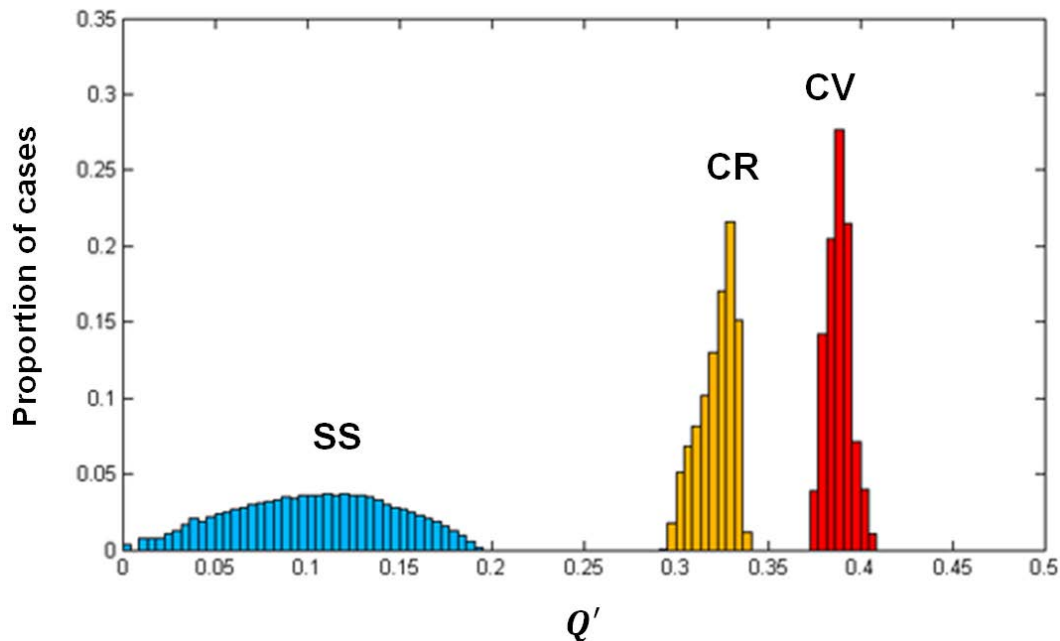

Figure 5.77: Histogram of Wind-Averaged Flow Rates for Three Ventilation Regimes, Showing Proportion of Cases with (Wind-Averaged) Flow Rate in Ranges of Values



- Wind-averaging hides the variation in flow rates for a given regime: for CR in particular there is a wide range of possible flow rates taking into account all wind angles and opening positions. Thus if we were to count up the points from all the plots on the left-hand side of Figure 5.76 for CR, say, and apportion them to the bins, rather than just performing this for the averaged values in the right-hand side plot, as we have done thus far, there will be a broadening of the 'probability curves'.

Nevertheless, subject to the above limitations of the approach, the properties of the curves in the histogram in Figure 5.77 could be used to characterize the basic set-up, in this case an isolated low-rise building with certain ranges of opening positions. For example, the mean and variance of each distribution would give 6 numbers characterizing this set-up. The same procedure could be applied to the other CPP cases investigated, e.g. building and environment combinations, and compared quantitatively, as well as differences between wind direction quadrants.

5.2.6 Conclusions

This work has led to the development of new algorithms capable of predicting wind-driven ventilation in a wide range of conditions, including

- the effects of opening locations and their impact on both the ventilation types (cross-, single-sided and corner ventilation) and the magnitude and patterns of the internal flows produced;
- the effects of wind speeds and directions on ventilation rates;

- the effects of surrounding buildings

These new algorithms are designed to be simple enough to be implemented in EnergyPlus and have been extensively tested against results in the existing literature and against the current wind tunnel and CFD results. They provide a significant improvement in both the capabilities and accuracy of natural ventilation calculations in a form that can be used in whole-building simulation codes.

5.3 EnergyPlus Implementation and EnergyPlus Training

5.3.1 EnergyPlus Implementation

In this section we give a brief overview of the implementation of the algorithms described in the previous section into EnergyPlus. The reader is referred to the EnergyPlus Engineering Reference documentation for further details of the updated features.

5.3.1.1 Cross- Ventilation Model Implementation

The cross-ventilation model contributes to the Alternative Modeling Processes part of EnergyPlus, which contains a number of RoomAir models: these are included to account for non-uniform conditions in the room, in particular, room air temperature. The cross-ventilation model is invoked by means of a RoomAirSettings:CrossVentilation object.

There are three aspects to the implementation, described in Section 5.2.1:

- (a) Single-aperture model: the previous implementation has been updated to reflect the new model with improved applicability to smaller apertures (see Section 5.2.1.5).
- (b) Multiple-aperture rooms: when there is more than one aperture on the windward side, multiple jets are modeled, one for each aperture (see Section 5.2.1.6(a)).
- (c) Wind angle effects (see Section 5.2.1.6(b)).

The implementation makes use of the following modules:

- DataRoomAir: declaration of variables
- RoomAirManager: processes data for the RoomAirSettings:CrossVentilation object in the EnergyPlus input file (.idf)
- RoomAirModelCrossVent: executes each instance of the model at each time-step

The input data read from the EnergyPlus input file for each instance of the model are:

Object: RoomAirSettings: CrossVentilation

Field: Zone Name

This field provides the name of the zone to which this object applies. A single instance of the 'UCSD Cross Ventilation Model Controls' object is needed for each zone modeled using this method.

Field: Gain Distribution Schedule Name

This field specifies the unique name of schedule defined elsewhere in the input file. The schedule values define the fractions of the convective portion of the internal gains in the jet and recirculation regions. The schedule values should be between 0 and 1. A value of 1 specifies that all the convective gains are dispersed in the jet region. Conversely a value of 0 puts all the convective gains into the recirculation region.

Field: Airflow Region Used for Thermal Comfort Evaluation

This is a required field whenever thermal comfort is predicted. It defines air temperature and mean airflow velocity that will be used in the Fanger model. Conditions must refer to one of the two regions defined in the model: jet or recirculation. Possible choices: Jet or Recirculation.

The output variables are:

Zone Average Jet Region Temperature – weighted by the inflow area of each jet

Jet Region Temperature for each window

Zone Average Jet Region Velocity – weighted by the inflow area of each jet

Jet Region Velocity for each window

Zone Average Recirculation Region Temperature

Recirculation Region Temperature for each window

Zone Average Recirculation Region Velocity

Recirculation Region Velocity for each window

Inflow Total Aperture Area – depends on the wind direction and the open fraction of each windward window

Room Length – in the direction of flow

Ratio of Recirculation Flow Rate to Inflow Flow Rate

Zone Air is Mixed (Yes/No) - 'No' if the jet model is used

Recirculations Occur In The Flow (Yes/No) – recirculation does not occur if the inflow cross sectional area is similar to the room cross sectional area (e.g. as in a typical corridor).

The implementation of the CV model was validated using a one zone, two opening EnergyPlus model that was simulated at two different orientations for 3 day periods in which both mixing and non-mixing occurred. It was verified that the changeover between mixing and non-mixing occurred according to the 1.5°C temperature rise criteria of the model. It was found that:

- (a) When the model was in mixing mode, the jet and circulation velocities were zero and the jet and circulation temperatures were equal to the mean air temperature, as expected.

- (b) When the model was in non-mixing mode, the jet temperatures were found to track the outside air temperature closely and the recirculation, outside, and zone mean air temperatures all agreed with the results of spreadsheet calculations based on the equations presented above.

5.3.1.2 Single-Sided 1-Aperture Model Implementation

As described in Section 5.2.2.2, this model was developed to extend the “Wind and Stack with Open Area” model, which is part of the Air Heat Balance Manager/Processes part of EnergyPlus. This model is applicable to simplified ventilation calculations, and is invoked using the ZoneVentilation:WindandStackOpenArea object. The model includes a wind-driven ventilation rate formula that requires the local wind speed V as input. Equations (5.19) through (5.21) define a formula for calculating V , as an alternative to a user-specified value.

The documentation for implementation of the single-sided 1-aperture model has been prepared and approved, and the implementation is in progress.

5.3.1.3 Single-Sided 2-Aperture Model Implementation

This model, which is described in Section 5.2.3, treats the air flow between two openings in the same façade and applies to the case where EnergyPlus calculates a single wind pressure coefficient for each façade, rather than using pressure coefficient distributions entered by the user, typically from wind tunnel measurements.

The model calculates the pressure coefficient difference between the two openings that would give rise to the flow generated by unsteady pressure differences caused by eddies in the wind that have scale sizes of the same order as the separation of the openings. The model also estimates the difference in the steady wind pressure coefficients at the two openings, based on the wind direction and the horizontal separation of the openings relative to the horizontal extent of the façade. Exterior wind pressure nodes whose pressure coefficients differ by the sum of these two differences are then created automatically and incorporated in the EnergyPlus airflow network model so that, in the general case, the flows in and between zones have both cross flow and single-side components.

The implementation makes use of the following module:

AirflowNetworkBalanceManager: declaration of variables, processing of data for the AirflowNetwork:Multizone:Zone object in the EnergyPlus input file (.idf)

The input data read from the EnergyPlus input file for each instance of the model are:

Object: AirflowNetwork:Multizone:Zone

Field: SingleSided Wind Pressure Coefficient Algorithm

Specifies the type of single sided wind pressure coefficient algorithm to be used for the zone. This field is optional and is only used if Wind Pressure Coefficient Type is set to SurfaceAverageCalculation. The default is Standard and the two valid choices are:

Standard: A single wind pressure coefficient is applied to all openings in the zone, as calculated using SurfaceAverageCalculation.

Advanced: EnergyPlus calculates modified wind pressure coefficients for the two openings in the zone. This model is only valid for zones with two openings, both of which are on a single façade (i.e. are coplanar). For zones with more than two openings, consider combining the openings into two. The modified wind pressure coefficients account for wind direction and turbulence effects on single sided ventilation rates.

Field: Façade Width

This is the whole building width along the direction of the facade of this zone, or W_F in Figure 5.77. This field is used in the Single Sided Wind Pressure Coefficient Algorithm. This field is optional and is only used if the Single Sided Wind Pressure Coefficient Algorithm is set to Advanced

There are no output variables specifically associated with the model; however, when the Advanced algorithm is selected, the differences between the two modified wind pressure coefficients for each wind direction are output to the EnergyPlus .eio output file.

The implementation was tested using a subset of the data used in the model development described in Section 5.2.3 and no significant deviations were observed.

The EnergyPlus implementation of the single-sided 2-aperture model was tested by running several simple cases and comparing the output with spreadsheet calculations of the model formulae. The two were found to be virtually identical, confirming correct implementation.

The documentation for implementation of the aggregation algorithm (equations (5.43) and (5.44)) for more than 2 apertures has been prepared and approved, and the implementation is in progress.

Figure 5.77: Definition of Façade Width, W_F

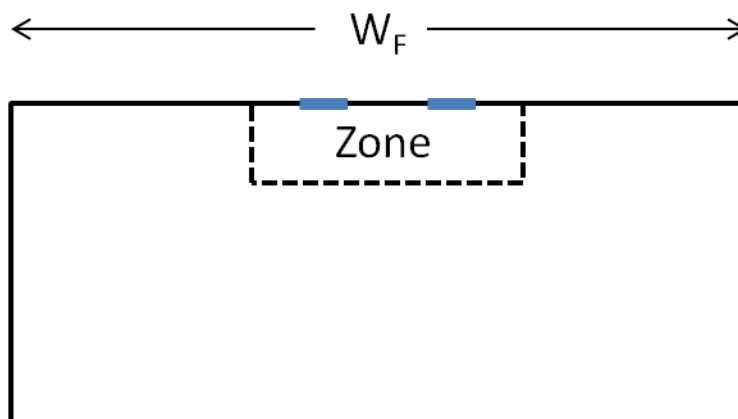

Footprint of a rectangular building showing W_F , the “Façade Width”, used by the Single Sided Wind Pressure Coefficient Algorithm.

5.3.1.4 Corner Ventilation Model Implementation

Implementation of the corner ventilation model was deferred to a possible future project due to limited resources.

5.3.2 EnergyPlus Training

The purpose of the final component of Project 3, Task 3.5, was to disseminate the results of the project through a set of training courses. A one-day session was held at each of three major urban centers in California:

- (1) San Francisco (Pacific Gas & Electric, Pacific Energy Center, 2/10/14)
- (2) Los Angeles (Southern California Edison, Irwindale, 2/12/14)
- (3) San Diego (San Diego Gas & Electric, Energy Innovation Center, 2/13/14)

The courses were presented by Guilherme Carrilho da Graça, Natural Works (**GCG**) and Spencer Dutton, LBNL (**SD**), with additional material from Phil Haves, LBNL (**PH**) and Paul Switenki, Arup (**PS**).

5.3.2.1 Program and Presentations

The overall program combined material from

- Project results
- NV design issues
- EnergyPlus simulations using NV capabilities

The EnergyPlus simulations were set up and run using the new Simergy user interface.

The program for each course was as follows. Initials in brackets indicate speaker, while *.pdf* file name refers to the file containing the presentation slides (see Section 5.3.2.2, below).³⁷

Morning Session

- a) Introduction to Simergy [**SD, PH**; *CECNV M1.pptx.pdf*]

An overview of the new EnergyPlus user interface Simergy, covering its development history, capabilities and use.

- b) Designing with NV [**GCG**; *CECNV M2.pptx.pdf*]

General introduction to NV in building design: types of NV, building suitability, modeling approaches.

³⁷ For the San Francisco course, (a) and (c) were presented by Phil Haves and Paul Switenki, respectively.

- c) Natural ventilation: barriers to implementation [**GCG, PS**; *CECNV M3.pptx.pdf*]

Based on results from Task 1.4, a discussion of the various concerns related to use of NV in buildings – climate suitability, building function, infiltration of outdoor pollutants and noise, etc – and how they can be addressed in NV design.

- d) Health Issues [**SD**; *CECNV M4-5.pptx.pdf*]

Based on results from Task 2.2, a summary of the findings to quantify the economic penalties (increased health costs associated with ozone and PM2.5 ingress) and benefits (reduction in costs associated with SBS symptoms) from use of NV.

Afternoon Session

- (a) Installation of Simergy and EnergyPlus [**GCG**]

- (b) SS NV modeling and Simergy exercise [**GCG**, *CECNV M6-8.pptx.pdf*]

- (c) Discussion of SS: the physical principles, videos of typical flows (Task 3.1 flow visualizations and Task 3.2 CFD simulations), modeling effort in this project and status in EnergyPlus.

- (d) DV NV modeling and Simergy exercise [**GCG**, *CECNV A1-2.pptx.pdf*]

- (e) Followed same format as (f).

- (f) CV NV modeling and Simergy exercise [**GCG**, *CECNV A3-4.pptx.pdf*]

- (g) Followed same format as:

Comparison of NV strategies in Simergy exercise [**GCG**, *CECNV A5.pptx.pdf*]

- (h) Harness power of Simergy to compare different design alternatives.

- (i) Natural ventilation potential for California [**SD**; *CECNV M4-5.pptx.pdf*]

Based on results of Task 1.3, a summary of the EnergyPlus modeling to estimate potential building energy savings from implementation of NV, using model buildings representative of the California building stock.

5.3.2.2 Resources

The presentations and simulation files are available, comprising the PowerPoint presentations and Simergy input files. The two main directories are as follows.

./PDF

PDF version of PowerPoint files used in presentations.

<i>CECNV A1-2.pptx.pdf</i>	DV model in EnergyPlus Simergy exercise: DV
<i>CECNV A3-4.pptx.pdf</i>	CV model in EnergyPlus, including new features Simergy exercise: CV
<i>CECNV A5.pptx.pdf</i>	Simergy exercise: Comparison of CV, low and high inertia Simergy exercise: Comparison of SS, DV and CV
<i>CECNV A6-9.pptx.pdf</i>	Simergy exercises: HVAC and hybrid systems
<i>CECNV M1.pptx.pdf</i>	Simergy overview
<i>CECNV M2.pptx.pdf</i>	NV design overview
<i>CECNV M3.pptx.pdf</i>	Barriers to NV
<i>CECNV M4-5.pptx.pdf</i>	Health and productivity impacts of NV Potential energy savings in CA through NV
<i>CECNV M6-8.pptx.pdf</i>	SS1 and SS2 models in EnergyPlus Simergy exercise: SS2

./ SIMULATION FILES

Simergy input (*.simp*) files for all the exercises.

Note: The Simergy input files were developed using Version 1.0.8d, so compatibility may be an issue if using future versions of the software.

Note: A number of additional cases, not discussed in detail in the course, are available in the resources: these concern HVAC and hybrid systems.

5.3.2.3 Participants

The registered attendees for each course were as follows (n/a = not available).

(1) San Francisco

Name	Affiliation
Paul Raftery	University of California, Berkeley
Chuck Campanella	AIA/USGBC/Passive House California
Justin Smith	Atelier Ten
Pius Kao	AEI Affiliated Engineers
Vaibhav Jain	n/a
Peter Ouzts	n/a
Salman Ilyas	Arup
Ery Djunaedy	University of Idaho
Christian Stalberg	DesignBuilder Software
Benjamin Welle	Perkins + Will
Neil Bulger	Integral Group
Chitra C.Nambiar	Architectural Energy Corporation
Casey Chatt	n/a
Aaron Wintersmith	Capital Engineering Consultants, Inc.
Stephen R. Witek	SEED Inc.
Matthew Dehghani	PAE

(2) Irwindale

Name	Affiliation
Janae Acker	Southern California Edison
Elmer Angadol	Energy Balance
Walter Hornbeck	n/a
James Hsu	Architect
Dave Intner	Southern California Edison
Andrew Lee	Southern California Edison
Thomas Lor	Southern California Edison
Marty Mirand	IHA Design, Inc.
Corey Semrow	Southern California Edison
Ramez Shehata	n/a
Chad Sisco	Southern California Edison
William Vicent	Southern California Edison
Upadi Yuliatmo	Barsocchini & Associates Designs
Steve Knickelbein	Knickelbein Builders
Long Nguyen	Southern California Edison

(3) San Diego

Name	Affiliation
Jorge Torres Coto	Empirical Engineering
Roger Yamasaki	San Diego Gas & Electric
Wayne Longdon	Green Home Services
Charlie Christenson	Brummitt Energy Associates, Inc.
Wahab Ashoor	Self-employed
Sara Motamedi	Individual
Dominique Michaud	n/a
Tim Hreha	Brummitt Energy Associates, Inc.
Alejandro Vega	Empirical Engineering
Chenfu Lin	DNV GL Energy
Fabian Posadas	DNV GL
Judy Merrick	Merrick & Associates
Brian Merrick	Merrick & Associates
Chau Vu	NAVFAC Southwest

5.3.2.4 Feedback

The following comments were received by attendees of the courses.

- Wayne Longdon, Green Home Services [San Diego] - email
'Thank you for an interesting workshop today!
I wish you much success and thank you for your continuing efforts.'
- Charlie Christenson, Brummitt Energy Associates [San Diego] - email
'Hey Spencer & Guilherme – it was great meeting you today!
Thanks for the presentation. Looking forward to getting deeper into all of this!'
- Kajal via LinkedIn
'Recently saw the CV and DV model presentation at PEC. Thank you, it was very insightful.'
- Dave Intner [Irwindale] – via LinkedIn
'Attended a good seminar yesterday at SCE's Energy Education Center about modeling Natural Ventilation within the framework of the new California Energy standards. It's encouraging to see the tools being developed to quantify the energy savings from this effective passive cooling strategy.'

5.4 Conclusions for Project 3

This project has achieved its goal of providing new modeling tools to calculate wind-driven ventilation in non-domestic buildings in California and to introduce these new tools to the state's engineering and design communities. This has been achieved by meeting the objectives set out in a series of coordinated tasks starting with gaining new understanding of the fluid dynamics, through to the development and implementation of new algorithms for wind-driven ventilation in EnergyPlus.

Wind tunnel tests (Task 3.1) over three measurement campaigns have provided the most extensive data set currently available for wind-driven ventilation. These tests span the full range of ventilation flows, cross, single-sided and corner ventilation, over all wind angles and for isolated and sheltered buildings. These data will provide further information in the future on façade pressure coefficients that will be invaluable in future development of modeling capabilities.

The results from Tasks 3.2 and 3.3 on CFD and algorithm developments show the following. In cross ventilation, room airflow patterns depend on the ratio between inflow and room cross-section area, A' . We have focused on the more common and complex case of small ratios when the flow has recirculation regions. For this case, the results confirm the possibility of characterizing the flow as a confined axisymmetric jet flow that drives the recirculation regions into a lid driven cavity flow.

The model correlation expressions predict the average indoor velocities in two distinct regions of the flow, the jet and recirculation regions, using a linear function of inflow velocity and two non-dimensional variables, namely A' and D' , the ratio of room depth to characteristic inflow diameter. Indoor velocities are proportional to $A'^{1/2}$ and inversely proportional to D' : longer rooms have lower indoor velocities (due to increased jet decay), while rooms with a larger inflow to room cross-sectional area have higher velocities for the same inflow rate. Maximum airflow rate in the recirculation region increases with the area of the room: wider rooms have larger recirculation flow rates (a useful feature to dilute the heat gains that may exist in these regions). Internal heat gains in the recirculation regions lead to large local temperature increase. In contrast, when heat is placed in front of the inflow jet region the temperature increase is approximately uniform in the whole flow volume. For the typical inflow velocity and internal sensible heat gain density that occurs in cross-ventilated buildings, buoyancy effects, outlet geometry and aperture shape factor do not have a significant impact on airflow velocities and internal temperature distribution.

The results of this study also show that rooms with multiple inflow openings can be modeled as a set of single inflow opening rooms in parallel. In these cases, interference of the adjacent recirculating flows leads to negligible change in indoor velocities. For isolated CV buildings, variations in wind direction change the inflow driving velocity in a way that compensates the decrease in static pressure that occurs for non-normal wind angles, making CV flows partially self-regulating.

With regards to single-sided ventilation the results depend on the number of apertures. For a single aperture analysis of the present wind tunnel data, consistent with historical data, shows that the ventilation scales with the local velocity at the opening. For the case of two openings the full range of ventilation flows have been characterized.

For a corner office with one opening on each external façade the ventilation can be satisfactorily predicted by the mean pressure difference between the two apertures, and that this is adequately characterized by the pressure coefficient correlation of Swami & Chandra (1988), which is already available within EnergyPlus. Other than ensuring that the corner room is represented with two apertures and placing a lower limit on the pressure difference, the corner case can be modeled with EnergyPlus with minimal modifications.

Analysis of the wind tunnel data also provided new methods for accounting for pressure coefficient variations across a façade and also new parameterizations of the effects of surrounding buildings.

This work has led to the development of new algorithms capable of predicting wind-driven ventilation in a wide range of conditions, including

- the effects of opening locations and their impact on both the ventilation types (cross-, single-sided, and corner ventilation) and the magnitude and patterns of the internal flows produced;
- the effects of wind speeds and directions on ventilation rates;

- the effects of surrounding buildings

These new algorithms are designed to be simple enough to be implemented in EnergyPlus and have been extensively tested against result in the existing literature and against the current wind tunnel and CFD results. They provide a significant improvement in both the capabilities and accuracy of natural ventilation calculations in a form that can be used in whole-building simulation codes.

As a result of this research new algorithms were successfully implemented in EnergyPlus and the new version of EnergyPlus was introduced to the California engineering and design community through specifically designed training at three locations in February 2014.

GLOSSARY

Term	Definition
AC	Air conditioning, air-conditioned
ACH	Air changes per hour
AHJ	Authority having jurisdiction
AI	Articulation index
AMS	Air movement satisfaction
ARB	California Air Resource Board
ASHRAE	American Society for Heating, Refrigeration, and Air conditioning Engineers
ASHRAE Standard 55	Specifies conditions for acceptable thermal environments
ASHRAE Standard 62.1	Specifies ventilation for acceptable indoor air quality
BSRIA	Building Services Research and Information Association
C-R	Concentration-response (function)
CAV	Constant air volume
CBC	California Building Code
CBE	Center for the Built Environment at University of California, Berkeley
CBECS	Commercial Buildings Energy Consumption Survey
CCR	California Code of Regulations
CEBC	California Existing Building Code
CEUS	California Commercial End Use Survey
CFC	California Fire Code
CFD	Computational fluid dynamics
CIBSE	Chartered Institution of Building Services Engineers
CMC	California Mechanical Code
CO ₂	Carbon Dioxide

COMFEN	Commercial Fenestration Tool
CR	Corner-case ventilation (openings on adjacent façades in a room)
CSFM	California State Fire Marshall
C-R	Concentration-Response, a function for biological action of pollutants
CV	Cross-ventilation (openings on opposite façades in a room)
CZ	Climate Zone: there are 16 defined in Title 24 for California
DOAVS	Dedicated outdoor air ventilation system
DOE	US Department of Energy
DV	Displacement ventilation (cool air introduced near floor and warm air exhausted near ceiling)
EA	Energy and atmosphere (LEED section)
EB	Existing buildings
EMS	Energy management system
EPRI	Electric Power Research Institute
EQ	Environmental quality (LEED section)
FDS	Fire Dynamics Simulator (smoke movement computer model)
FFID	Fast flame ionization detector
Fluent	CFD software, developed by ANSYS, Inc.
GIS	Geographical information system
GSA	General Services Administration
HVAC	Heating ventilation and air conditioning
IAQ	Indoor air quality
IBC	International Building Code
IEQ	Indoor environmental quality
ILFI	International Living Future Institute
IMC	International Mechanical Code
IO	Indoor to outdoor (ratio)
IOLR	Indoor-outdoor level reduction

LBNL	Lawrence Berkeley National Laboratory
LEED	Leadership in Energy and Environmental Design
LEED NC	LEED new construction
LES	Large eddy simulation (class of CFD models)
Low-E	Low-emissivity
MFC	Mass flow controller
MIT	Massachusetts Institute of Technology
MM	Mixed mode ventilation. Synonymous with <i>hybrid</i> ventilation.
MPS	Multi-pressure (data acquisition) system
NC	Noise criteria (curves)
NIST	National Institute of Standards and Technology
NPL	Neutral pressure level
NREL	National Renewable Energy Laboratory
NS	Noise satisfaction
NUREG	US Nuclear Regulatory Commission
NV	Natural ventilation, naturally ventilated
OSHA	Occupational Safety & Health Association
PAQ	Perceived air quality
PBS	Public Buildings Service
PI	Principal Investigator, the individual with ultimate project responsibility
PM	Particulate matter
PM2.5	Particles less than 2.5 micrometers in diameter
PMV/PPD	Predicted mean vote/Predicted percentage dissatisfied
PNNL	Pacific Northwest National Laboratory
RANS	Reynolds-averaged Navies-Stokes (class of CFD models)
RNG	Re-normalization group (sub-group within RANS models)
ROI	Return on investment

SATR	Supply air temperature reset, an AC control strategy
SBS	Sick building syndrome
SHGC	Solar heat gain coefficient
SS	Single-sided ventilation (one or more openings on the same façade in a room: SS1 = one opening, SS2 = two openings, etc.)
SSW	South South West: 225 degrees clockwise from true north
STC	Sound transmission class
TA	Thermal acceptability
TRNSYS	TRaNsient SYstem Simulation Program
TS	Thermal sensation
UC	University of California
UCSD	University of California, San Diego
UDF	User-defined function (function used in FLUENT post-processing)
UK	United Kingdom
UMC	Universal Mechanical Code
US	United States
USGBC	United States Green Building Council
UW	University of Washington
VAV	Variable air volume
VT	Visible-light transmittance
WFDS	Wildland-Urban Interface Fire Dynamics Simulator

REFERENCES

- Ackerly, K. (2012) Occupant Response to Window Control Signaling Systems. UC, Berkeley: Center for the Built Environment
- Aggerholm, S. (1998) *Perceived barriers to natural ventilation design of office buildings*. Building Research Establishment, Garston. 23pp.
- Arens, E., Turner, S., Zhang, H. and G. Paliaga (2009) Moving air for comfort. *ASHRAE Journal* 51(5), 18–28.
- ASHRAE (2004) ANSI/ASHRAE Standard 55-2004.
- ASHRAE (2010) ANSI/ASHRAE Addendum f to ANSI/ASHRAE Standard 55-2010.
- ASHRAE (2010) Thermal environmental conditions for human occupancy. ANSI/ASHRAE Standard 55-2010.
- ASHRAE, AIA, IESNA, USGBC and DOE (2011) Advanced energy design guide for small to medium office buildings: Achieving 50% energy savings toward a net zero energy building. ASHRAE, Inc.
- Awbi, H.B. (2013) *Ventilation of buildings*. Second edition, revised. Routledge. 536pp.
- Axley, J., Emmerich, S., Dols, S. and G. Walton (2002a) An approach to the design of natural and hybrid ventilation systems for cooling buildings. In *Proceedings of Indoor Air 2002, 9th International Conference on Indoor Air Quality and Climate in Monterey, California. June 30-July 5, 2002*, pp. 836-841. Reprinted by Building and Fire Research Laboratory, National Institute of Standards and Technology.
- Axley, J.W., Emmerich, S.J. and G.N. Walton (2002b) Modeling the performance of a naturally ventilated commercial building with a multizone coupled thermal/airflow simulation tool. *ASHRAE Transactions* **108(2)**, 1260-1275.
- Bangalee, M.Z.I., Miao, J.J., Lin, S.Y. and J.H. Yang (2013) Flow visualization, PIV measurement and CFD calculation for fluid-driven natural cross-ventilation in a scale model. *Energy and Buildings* **66**, 306-314.
- Becker, H.A., Hottel, H.C. and G.C. Williams (1963) Mixing and flow in ducted turbulent jets, *Symposium (International) on Combustion* **9(1)**, 7-20.
- Bennett, D., Apte, M., Wu, X., Trout, A., Faulkner, D., Maddalena, R. and D. Sullivan (2011) Indoor environmental quality and heating, ventilating and air conditioning survey of small and medium size commercial buildings. Field study – Appendices. California Energy Commission publication CEC-500-2011-043-APA.
- Best, R. and D.P. Demers (1982) *Investigation report on the MGM Grand Hotel fire, Las Vegas, Nevada, November 21, 1980*. National Fire Protection Association, Quincy, MA, 15 January 1982.

- Borgeson, S. and G. Brager (2011) Comfort standards and variations in exceedance for mixed-mode buildings. *Building Research & Information* **39(2)**, 118-133.
- Bowers, D.C., Ellison, J.R., Beasley, D.E. and R. S. Miller (2010) Numerical study of elevator and stairwell pressurization systems using detailed building models. In *Proceedings of the 8th International Conference on Performance-Based Codes and Fire Safety Design Methods, Lunds Universitet, Lund, Sweden, June 16-18, 2010*. Society of Fire Protection Engineers.
- Brager, G.S., Paliaga, G., de Dear, R., Olesen, B., Wen, J., Nicol, F. and M. Humphreys (2004) Operable windows, personal control, and occupant comfort. *ASHRAE Transactions* **110(2)**, 17-35.
- Brightman, H.S. (2005) *Health, comfort and productivity in United States office buildings*. PhD Thesis, Harvard School of Public Health.
- Bu, Z. and S. Kato (2011) Investigation of ventilation effectiveness for wind-driven single-sided ventilated buildings located in an urban environment. *International Journal of Ventilation* **10(1)**, 19-30.
- Burton, L.E., Girman, J.G. and S.E. Womble (2000) Airborne particulate matter within 100 randomly selected office buildings in the United States (BASE). In *Healthy Buildings 2003, Proceedings of the Sixth International Conference, Espoo, Finland, 6-10 August 2000* **1**, 157-162.
- Caciolo, M. (2010) Analyse expérimentale et simulation de la ventilation naturelle mono-façade pour le rafraîchissement des immeubles de bureau. PhD Thesis, l'École nationale supérieure des mines de Paris.
- Caciolo, M., Stabat, P. and D. Marchio (2012) Numerical simulation of single-sided ventilation using RANS and LES and comparison with full-scale experiments. *Building and Environment* **50**, 202-213.
- Carrilho da Graça, G. (2003) *Simplified models for heat transfer in rooms*. Ph.D. dissertation, University of California, San Diego, Department of Mechanical and Aerospace Engineering.
- Carrilho da Graça, G. and P.F. Linden (2003) Simplified modeling of cross-ventilation airflow. *ASHRAE Transactions* **109(1)**, 4605-4619.
- Carrilho da Graça, G., Linden, P.F. and P. Haves (2004) Design and testing of a control strategy for a large, naturally ventilated office building. *Building Serv. Eng. Res. and Technol.* **25(3)**, 223-239.
- Carrilho da Graça, G., Martins, N.R. and C.S. Horta (2012) Thermal and airflow simulation of a naturally ventilated shopping mall. *Energy and Buildings* **50**, 177-188.
- CBSC (2010) 2010 California Building Code, California Code of Regulations, Title 24, Part 2, Volumes 1 and 2. California Building Standards Commission, Sacramento, CA.

- CEC (2006) *California Commercial End-Use Survey*. Consultant Report. CEC-400-2006-005, March 2006.
- CEN (2007) Indoor environmental input parameters for design and assessment of energy performance of buildings – addressing indoor air quality, thermal environment, lighting and acoustics. European Committee for Standardization, EN 15251:2007.
- Cermak, J.E. (1971) Laboratory Simulation of the Atmospheric Boundary Layer. *AIAA Journal* **9(9)**, 1746-1754.
- Cermak, J.E. (1975) Applications of Fluid Mechanics to Wind Engineering. *J. Fluids Eng.* **97(1)**, 9-38.
- Cermak, J.E. (1976) Aerodynamics of Buildings. *Ann. Rev. Fluid Mech.* **8**, 75-106.
- Champagne, F. H., Pao, Y.H. and I. J. Wygnanski (1976) On the two-dimensional mixing region. *J. Fluid Mech.* **74(2)**, 209-250.
- Chen, Q. (1995) Comparison of different k- ϵ models for indoor air flow computations. *Numerical Heat Transfer, Part B: Fundamentals* **28(3)**, 353–369.
- Chu, C.R., Chen, R.-H. and J.-W. Chen (2011) A laboratory experiment of shear-induced natural ventilation. *Energy and Buildings* **43(10)**, 2631-2637.
- Cóstola, D., Blocken, B., Ohba, M. and J.L.M. Hensen (2010) Uncertainty in airflow rate calculations due to the use of surface-averaged pressure coefficients. *Energy and Buildings* **42(6)**, 881–888.
- Crawley, D.B., Hand, J.W., Kummert, M. and B.T. Griffith (2005) *Contrasting the capabilities of building energy performance simulation programs*. US Department of Energy report, Version 1.0, July 2005, 56pp.
- Crawley, D.B., Lawrie, L.K., Winkelmann, F.C., Buhl, W.F., Huang, Y.J., Pedersen, C.O., Strand, R.K., Liesen, R.J., Fisher, D.E., Witte, M.J. and J. Glazer (2001) EnergyPlus: creating a new-generation building energy simulation program. *Energy and Buildings* **33(4)**, 319-331.
- Cros, C.J., Morrison, G.C., Siegel, J.A. and R.L. Corsi (2012) Long-term performance of passive materials for removal of ozone from indoor air. *Indoor Air* **22(1)**, 43-53.
- Curtet, R. (1958) Confined jets and recirculation phenomena with cold air. *Combustion and Flame* **2(4)**, 383-411.
- de Dear, R.J. (1998) A global database of thermal comfort field experiments. *ASHRAE Transactions* 104(1B), 1141-1152.
- de Dear, R.J. and G.S. Brager (1998) Developing an adaptive model of thermal comfort and preference. *ASHRAE Transactions* 104(1A), 145-167.

- de Gids, W. and H. Phaff (1982) Ventilation rates and energy consumption due to open windows: a brief overview of research in the Netherlands. *Air Infiltration Review* **4(1)**, 4-5.
- DeCicco, P.R., Cresci, R.J. and W. H. Correale (1972) Fire tests, analysis and evaluation of stair pressurization and exhaust in high-rise office buildings. Polytechnic Institute of Brooklyn.
- Deru, M., Field, K., Studer, D., Benne, K., Griffith, B., Torcellini, P., Liu, B., Halverson, M., Winiarski, D., Rosenberg, M., Yazdanian, M., Huang, J. and D. Crawley (2011) U.S. Department of Energy commercial reference building models of the national building stock. NREL Technical Report NREL/TP-5500-46861, February 2011.
- Dimotakis, P.E. (1986) Two-dimensional shear-layer entrainment. *AIAA Journal* **24(11)**, 1791-1796.
- Dutton, S.M., Banks, D., Brunswick, S.L. and W.J. Fisk (2013) Health and economic implications of natural ventilation in California offices. *Building and Environment* **67**, 34-45.
- Dutton, S.M., Banks, D., Brunswick, S.L. and W.J. Fisk (2013) Health and economic implications of natural ventilation in California offices. *Building and Environment* **67**, 34-45.
- Dutton, S.M., Zhang, H., Zhai, Y., Arens, E., Smires, Y., Brunswick, S., Konis, K. and P. Haves (2012) Application of a stochastic window use model in EnergyPlus. Simbuild 2012, Fifth National Conference of IBPSA-USA, Madison, Wisconsin.
- Emmerich, S.J. and J. Crum (2005) Simulated performance of natural and hybrid ventilation systems in an office building. Report ARTI-21CR/611-40076-01, February 2005.
- Emmerich, S.J. and W.S. Dols (2003) LoopDA: A natural ventilation system design and analysis tool. In Proceedings of Building Simulation 2003, Eighth International IBPSA Conference, Eindhoven, Netherlands, August 11-14, 2003, pp. 291-298.
- Emmerich, S.J., Dols, W.S. and J.W. Axley (2001) *Natural ventilation review and plan for design and analysis tools*. National Institute of Standards and Technology report NISTIR 6781.
- Emmerich, S.J., Persily, A.K., Dols, W.S. and J.W. Axley (2003) Impact of natural ventilation strategies and design issues for California applications, including input to ASHRAE Standard 62 and California Title 24. National Institute of Standards and Technology report NISTIR 7062.
- Evola, G. and V. Popov (2006) Computational analysis of wind driven natural ventilation in buildings. *Energy and Buildings* **38(5)**, 491-501.
- Fang, L., Clausen, G. and P.O. Fanger (1998) Impact of temperature and humidity on the perception of indoor air quality during immediate and longer whole-body exposure. *Indoor Air* **8(4)**, 276-284.
- Franke, J., Hellsten, A., Schlünzen, H. and B. Carissimo (eds.) (2007) Best practice guideline for the CFD simulation of flows in the urban environment. *Report produced by COST Action*

- 732, Quality assurance and improvement of microscale meteorological models. 1 May 2007.
- Goto, T., Mitamura, T., Yoshino, H., Tamura, A. and E. Inomata (2007) Long-term field survey on thermal adaptation in office buildings in Japan. *Building and Environment* 42(12), 3944-3954.
- Haldi, F. and D. Robinson (2008) On the behaviour and adaptation of office occupants. *Building and Environment* 43(12), 2163-2177.
- Haldi, F. and D. Robinson (2009) Interactions with window openings by office occupants. *Building and Environment* 44, 2378-2395.
- Hall, J., Brajer, V. and F. Lurmann (2008) The Benefits of Meeting Federal Clean Air Standards in the South Coast and San Joaquin Air Basins. Institute for Economic and Environmental Studies at California State University Fullerton.
- Humphreys, M.A., Rijal, H.B. and J.F. Nicol (2013) Updating the adaptive relation between climate and comfort indoors; new insights and an extended database. *Building and Environment* 63, 40-55.
- Inard, C., Bouia, H. and P. Dalicieux (1996) Prediction of air temperature distribution in buildings with a zonal model. *Energy and Buildings* 24(2), 125-132.
- Indraganti, M. (2010) Using the adaptive model of thermal comfort for obtaining indoor neutral temperature: Findings from a field study in Hyderabad, India. *Building and Environment* 45(3), 519-536.
- Indraganti, M. and K.D. Rao (2010) Effect of age, gender, economic group and tenure on thermal comfort: A field study in residential buildings in hot and dry climate with seasonal variations. *Energy and Buildings* 42(3), 273-281.
- Ji, L., Tan, H., Kato, S., Bu, Z. and T. Takahashi (2011) Wind tunnel investigation on influence of fluctuating wind direction on cross natural ventilation. *Building and Environment* 46(12), 2490-2499.
- Jiang, Y., Alexander, D., Jenkins, H., Arthur, R. and Q. Chen (2003) Natural ventilation in buildings: measurement in a wind tunnel and numerical simulation with large-eddy simulation. *Journal of Wind Engineering and Industrial Aerodynamics* 91(3), 331-353.
- Kajtár, L., Herczeg, L. and E. Láng (2003) Examination of influence of CO₂ concentration by scientific methods in the laboratory. In *Healthy Buildings 2003, Proceedings of the Seventh International Conference, National University of Singapore, 7-11 December 2003*, 176-181.
- Kandakure, M.T., Patkar, V.C. and A.W. Patwardhan (2008) Characteristics of turbulent confined jets. *Chemical Engineering and Processing: Process Intensification* 47(8), 1234-1245.

- Karava, P., Stathopoulos, T. and A.K. Athienitis (2011) Airflow assessment in cross-ventilated buildings with operable façade elements. *Building and Environment* **46(1)**, 266-279.
- Karimpour, A., Kaye, N.B. and A.A. Khan (2011) CFD study of merging turbulent plane jets. *J. Hydraul. Eng.* **137(3)**, 381–385.
- Kato, S., Hasama, T. and R. Ooka (2006a) Analysis of wind-induced inflow and outflow through a single opening using large-eddy simulations. In *Proceedings of the 4th International Symposium on Computational Wind Engineering (CWE 2006), Yokohama, Japan, July 16-19, 2006*, pp. 251-254.
- Kato, S., Kono, R., Hasama, T., Ooka, R. and T. Takahashi (2006b) A wind tunnel experimental analysis of the ventilation characteristics of a room with single-sided opening in uniform flow. *International Journal of Ventilation* **5(1)**, 171-178.
- Kato, S., Murakami, S., Mochida, A., Akabayashi, S. and Y. Tominaga (1992) Velocity-pressure field of cross ventilation with open windows analyzed by wind tunnel and numerical simulation. *Journal of Wind Engineering and Industrial Aerodynamics* **44(1)**, 2575-2586.
- Kendrick, C., Martin, A. and W. Booth (1998) *Refurbishment of air conditioned buildings for natural ventilation*. BSRIA Technical Note TN 8/98. Building Services Research and Information Association. 76pp.
- Klote, J.H. (1984) Smoke control for elevators. *ASHRAE Journal* **26(4)**, 23-33.
- Klote, J.H. (1990) *Fire experiments of zoned smoke control at the Plaza Hotel in Washington, D.C.* National Institute of Standards and Technology, Report NISTIR 90-4253.
- Klote, J.H. and J.A. Milke (2002) *Principles of smoke management*. ASHRAE. 377pp.
- Konis, K.S. (2011) *Effective Daylighting: Evaluating Daylighting Performance in the San Francisco Federal Building from the Perspective of Building Occupants*. University of California, Berkeley Doctoral Dissertation.
- Kubo, H., Isoda, N. and H. Enomoto-Koshimizu (1997) Cooling effects of preferred air velocity in muggy conditions. *Building and Environment* **32(3)**, 211-218.
- Lai, J.C.S. and A. Nasr (1998) Two parallel plane jets: comparison of the performance of three turbulence models. *Proceedings of the Institution of Mechanical Engineers, Part G: Journal of Aerospace Engineering* **212(6)**, 379–391.
- Larsen, T.S. and P. Heiselberg (2008) Single-sided natural ventilation driven by wind pressure and temperature difference. *Energy and Buildings* **40(6)**, 1031–1040.
- Linden, P.F. (1999) The fluid mechanics of natural ventilation. *Ann. Rev. Fluid Mech.* **31**, 201-238.
- Liu, H., Winoto, S.H. and D.A. Shah (1997) Velocity measurements within confined turbulent jets: application to cardiovalvular regurgitation. *Annals of Biomedical Engineering* **25(6)**, 939-948.

- Liu, W., Zheng, Y., Deng, Q. and L. Yang (2012) Human thermal adaptive behaviour in naturally ventilated offices for different outdoor air temperatures: A case study in Changsha China. *Building and Environment* 50, 76-89.
- Lo, L.J., Banks, D. and A. Novoselac (2013) Combined wind tunnel and CFD analysis for indoor airflow prediction of wind-driven cross ventilation. *Building and Environment* 60, 12-23.
- Maurel, A., Ern, P., Zielinska, B.J.A. and J.E. Wesfreid (1996) Experimental study of self-sustained oscillations in a confined jet. *Physical Review E* 54(4), 3643–3651.
- McConahey, E. (2008) Mixed mode ventilation: Finding the right mix. *ASHRAE Journal* 50(9), 36-48.
- McGuire, J.H. (1967) Control of smoke in buildings. *Fire Technology* 3(3), 163-174.
- McIntyre, D.A. (1978) Preferred air speed for comfort in warm conditions. *ASHRAE Transactions* 84(2), 264-277.
- Melikov, A.K. and J. Kaczmarczyk (2012) Air movement and perceived air quality. *Building and Environment* 47, 400-409.
- Menchaca-B, M.-A. and L. Glicksman (2008) Coolvent: a multizone airflow and thermal analysis simulator for natural ventilation in buildings. In *Proceedings of SimBuild 2008, Third National Conference of IBPSA-USA, Berkeley, California, July 30 – August 1, 2008*, pp. 132-139.
- Mendell, M., Fisk, W., Deddens, J., Seavey, W., Smith, A., Hodgson, A., Daisey, J. and L. Goldman (1996) Elevated symptom prevalence associated with ventilation type in office buildings. *Epidemiology* 7, 583–589.
- Miller, R.S. and D. Beasley (2008) On smoke control by pressurization in stairwells and elevator shafts. Clemson University, Clemson, SC.
- Morton, B.R., Taylor, G. and J.S. Turner (1956) Turbulent gravitational convection from maintained and instantaneous sources. *Proc. R. Soc. Lond. A* 234, 1-23.
- Moschandreas, D.J., Zabransky, J. and D.J. Pelton (1981) Comparison of indoor and outdoor air quality. EPR EA 1733. Research Project 1309. Palo Alto CA: Electric Power Research Institute.
- NFPA (2006) NFPA 92A: Standard for smoke-control systems utilizing barriers and pressure differences. 2006 edition. National Fire Protection Association.
- NFPA (2007) NFPA 72: *National fire alarm code*. 2007 edition. National Fire Protection Association.
- Nicol, J.F. (2001) Characterising occupant behaviour in buildings: towards a stochastic model of occupant use of windows, lights, blinds, heaters and fans. In *Proceedings of the Seventh International IBPSA Conference, Rio de Janeiro, Brazil, August 13-15, 2001*, pp. 1073-1078.

- Nicol, J.F. and M.A. Humphreys (2002) Adaptive thermal comfort and sustainable thermal standards for buildings. *Energy and Buildings* **34(6)**, 563-572.
- Nielsen, P.V. (1990) Specification of a two-dimensional test case. *IEA-ECBCS Annex 20, Research Item No. 1.45*. Institut for Bygningsteknik, Aalborg Universitetscenter.
- Paciuk, M. (1990) The role of personal control of the environment in thermal comfort and satisfaction at the workplace. In Proceedings of the Twenty-First Annual Conference of the Environmental Design Research Association, Champaign-Urbana, Illinois, April 6-9, 1990, pp. 303-312.
- Pani, B.S. (1972) *Three dimensional turbulent wall jets*. Ph.D. dissertation, University of Alberta.
- Persily, A.K. 1998. Airtightness of Commercial and Institutional Buildings: Blowing Holes in the Myth of Tight Buildings. Thermal Envelopes VII/Airtightness and Airflow in Buildings-Principles.
- Persily, A.K., Ivy, E.M. 2001. Input Data for Multizone Airflow and IAQ Analysis. NISTIR 6585. National Institute of Standards and Technology.
- Pope, C.A., Burnett, R.T., Thun, M.J., Calle, E.E., Krewski, D., Ito, K. and G.D. Thurston (2002) Lung cancer, cardiopulmonary mortality, and long-term exposure to fine particulate air pollution. *JAMA* **287(9)**, 1132.
- Pope, S.B. (2000) *Turbulent flows*. Cambridge University Press. 802pp.
- Prasad, A.K. and J.R. Koseff (1989) Reynolds number and end-wall effects on a lid-driven cavity flow. *Phys. Fluids A* **1(2)**, 208-218.
- Preziosi, P., Czernichow, S., Gehanno, P. and S. Hercberg (2004) Workplace air-conditioning and health services attendance among French middle-aged women: a prospective cohort study. *Int J Epidemiology* **33**, 1120–1123.
- Raja, I.A., Nicol, J.F., McCartney, K.J. and M.A. Humphreys (2001) Thermal comfort: use of controls in naturally ventilated buildings. *Energy and Buildings* **33(3)**, 235-244.
- Ramponi, R. and B. Blocken (2012) CFD simulation of cross-ventilation for a generic isolated building: Impact of computational parameters. *Building and Environment* **53**, 34-48.
- Ricou, F.P. and D.B. Spalding (1961) Measurements of entrainment by axisymmetrical turbulent jets. *J. Fluid Mech.* **11(1)**, 21-32.
- Rohles, F., Jones, B.W. and S. Konz (1983) Ceiling fans as extenders of the summer comfort envelope. *ASHRAE Transactions* **89(1A)**, 245-263.
- Samet, J.M., Dominici, F., Curriero, F.C., Coursac, I. and S.L. Zeger (2000) Fine particulate air pollution and mortality in 20 US cities, 1987–1994. *N Engl J Med* **343(24)**, 1742–1749.
- Scheatzle, D.G., Wu, H. and J. Yellott (1989) Extending the summer comfort envelope with ceiling fans in hot, arid climates. *ASHRAE Transactions* **95(1)**, 269-280.

- Schiavon, S. and K.H. Lee (2013) Dynamic predictive clothing insulation models based on outdoor air and indoor operative temperatures. *Building and Environment* 59, 250-260.
- Sekhar, S.C., Tham, K.W. and K.W. Cheong (2003) Indoor air quality and energy performance of air-conditioned office buildings in Singapore. *Indoor Air* **13(4)**, 315–331.
- Seppänen, O. and W.J. Fisk (2002) Association of ventilation system type with SBS symptoms in office workers. *Indoor Air* **12**, 98–112.
- Seppänen, O.A. and W.J. Fisk (2004) Summary of human responses to ventilation. *Indoor Air* 14, 102-118.
- Shankar, P.N. and M.D. Deshpande (2000) Fluid mechanics in the driven cavity. *Ann. Rev. Fluid Mech.* **32**, 93-136.
- Siegel, J.A., Waring, M.S., Yu, X. and R.L. Corsi (2007) Do ion generators have a role in sustainable indoor environments? IAQ 2007. Baltimore MD: ASHRAE Healthy and Sustainable Buildings.
- Stavrakakis, G.M., Koukou, M.K., Vrachopoulos, M.Gr. and N.C. Markatos (2008) Natural cross-ventilation in buildings: Building-scale experiments, numerical simulation and thermal comfort evaluation. *Energy and Buildings* **40(9)**, 1666-1681.
- Stroup, D.W. (2003) *Literature review on enclosure of elevator lobbies*. National Institute of Standards and Technology, Report NISTIR 6973.
- Swami, M.V. and S. Chandra (1988) Correlations for pressure distribution on buildings and calculation of natural-ventilation airflow. *ASHRAE Transactions* **94(1)**, 243-266.
- Tamura, G.T. (1970) Computer analysis of smoke movement in tall buildings. *ASHRAE Transactions* **75(2)**, 81-92.
- Tamura, G.T. and A. G. Wilson (1967) Building pressures caused by chimney action and mechanical ventilation. *ASHRAE Transactions* **73(2)**, II.2.2-II.2.12.
- Thorton, B.A., Rosenberg, M.I., Richman, E.E., Wang, W., Xie, Y., Zhang J., Cho, H., Mendon, V.V., Athalye, R.A. and B. Liu (2011) *Achieving the 30% goal: Energy and cost savings analysis of ASHRAE Standard 90.1-2010*. Report PNNL-20405, Pacific Northwest National Laboratory, Richland, Washington.
- Toftum, J. (2004) Air movement—good or bad? *Indoor Air* 14, 40-45.
- Torcellini, P., Pless, S., Deru, M., Griffith, B., Long, N. and R. Judkoff (2006) *Lessons learned from case studies of six high-performance buildings*. NREL Technical Report NREL/TP-550-37542, June 2006.
- US EPA (1981) *Guideline for Fluid Modeling of Atmospheric Diffusion*, United States Environmental Protection Agency, Office of Air Quality Planning and Standards, Research Triangle Park, North Carolina. Report EPA-600/8-81-009, April 1981.

- US EPA (1991) Indoor Air Facts No. 4 (revised): Sick Building Syndrome. April 1991.
- US EPA (2011) *The Benefits and Costs of the Clean Air Act from 1990 to 2020, Final Report* U.S. Environmental Protection Agency, Office of Air and Radiation.
- US EPA. (2007) *The cost of illness handbook*. U.S. Environmental Protection Agency, Office of Pollution Prevention and Toxics.
- US EPA. The Environmental Protection Agency Air Quality System.
http://www.epa.gov/airquality/airdata/ad_data.html Accessed June 2014.
- van Hooff, T., Blocken, B. and G.J.F. van Heijst (2013) On the suitability of steady RANS CFD for forced mixing ventilation at transitional slot Reynolds numbers. *Indoor Air* **23(3)**, 236–249.
- Wakamatsu, T. (1968) Calculation of smoke movement in buildings. Research Paper No. 34, Building Research Institute, Tokyo, August 1968.
- Warren, P. R. (1978) Ventilation through openings on one wall only. In *Energy conservation in heating, cooling and ventilating buildings: heat and mass transfer techniques and alternatives*. C.J. Hoogendoorn and N.H. Afgan (eds.), Hemisphere Pub. Corp., Washington, pp. 189–206.
- Warren, P. R. (1986) The analysis of single-sided ventilation measurements. *Air Infiltration Review* **7(2)**, 3-5.
- Warren, P.R. and L.M. Parkins (1985) Single-sided ventilation through open windows. In Proceedings of the ASHRAE/DOE/BTECC Conference Thermal Performance of the Exterior Envelopes of Buildings III, Clearwater Beach, Florida, December 2-5, 1985, pp. 209-228.
- Weschler, C. (2000) Ozone in Indoor Environment: Concentration and Chemistry. *Indoor Air* **10**, 269-288.
- Weschler, C.J. (2006) Ozone's impact on public health: contributions from indoor exposures to ozone and products of ozone-initiated chemistry. *Environmental Health Perspectives* **114**, 1489–1496.
- Weschler, C.J., Shields, H.C. and D.V. Naik (1989) Indoor ozone exposures. *Journal of Air Pollution Control Association* **39**, 1562–1568.
- Weschler, C.J., Shields, H.C. and D.V. Naik (1994) The factors influencing indoor ozone levels at a commercial building in Southern California: More than a year of continuous observations. in *Tropospheric Ozone: Critical Issues in the Regulatory Process*, Pittsburgh, PA, Air and Waste Management Association. Volstal, J.J. (ed); pp. 236–252.
- Winoto, S.H., Shah, D.A., Ang, S.G. and L.P. Chua (1991) Prediction of orifice size from velocity measurements within the issuing free jets. In *General topics in fluids engineering, F.M. White and K. Kamemoto (eds)*. New York: ASME, FED-107, 47-51.

- Wu, X., Apte, M., Maddalena, R. and D.H. Bennett (2011) Volatile Organic Compounds in Small – and Medium-Sized Commercial Buildings in California. *Environ Sci and Technol* **45(20)**, 9075-9083.
- Yamanaka, T., Kotani, H., Iwamoto, K. and M. Kato (2006) Natural, wind-forced ventilation caused by turbulence in a room with a single opening. *International Journal of Ventilation* **5(1)**, 179-188.
- Zhai, J., Krarti, M. and M.-H. Johnson (2010) *Assess and implement natural and hybrid ventilation models in whole-building energy simulations*. ASHRAE TRP-1456: Department of Civil, Environmental and Architectural Engineering, University of Colorado Boulder.
- Zhai, Y., Zhang, H., Zhang, Y., Pasut, W., Arens, E. and Q. Meng (2013) Comfort under personally controlled air movement in warm and humid environments. *Building and Environment* **65**, 109-117.
- Zhai, Z.J., Johnson, M.-H. and M. Krarti (2011) Assessment of natural and hybrid ventilation models in whole-building energy simulations. *Energy and Buildings* **43(9)**, 2251-2261.
- Zhang, H., Arens, E., Fard, S.A., Huizenga, C., Paliaga, G., Brager, G. and L. Zagreus (2007) Air movement preferences observed in office buildings. *International Journal of Biometeorology* **51(5)**, 349-360.
- Zhang, H., Arens, E., Kim, D., Buchberger, E., Bauman, F. and C. Huizenga (2010) Comfort, perceived air quality, and work performance in a low-power task-ambient conditioning system. *Building and Environment* **45(1)**, 29-39.
- Zhang, H., Arens, E.A. and W. Pasut (2011) Air temperature thresholds for indoor comfort and perceived air quality. *Building Research & Information* **39(2)**, 134-144.
- Zuraimi, M.S., Tham, K.W. and S.C. Sekhar (2004) A study on the identification and quantification of sources of VOCs in 5 air-conditioned Singapore office buildings. *Building and Environment* **39(2)**, 165-77.

APPENDIX A: Barriers to Implementation: Acoustics

A.1 Scope

External noise breaking into buildings through ventilation openings is often used as an argument against natural ventilation and for supporting mechanical ventilation and air conditioning (Ghiaus & Allard, 2005). The aim of this section is to identify the extent to which this perception of external noise as a problem may be unjustified and to reduce any unnecessary impediment to the use of natural ventilation. Consideration of the feasibility of natural ventilation with regard to the external noise environment, and of the control of external noise break-in, is included.

This study relates to the acoustic design of new and renovated naturally ventilated or mixed mode office buildings and:

- Identifies legacy acoustic design standards that have been developed for mechanically ventilated buildings.
- Consolidates published research, including post occupancy surveys, to determine a basis from literature for different or new noise criteria for naturally ventilated and mixed mode buildings.
- Describes example acoustic measurements in naturally ventilated offices and compares the results with post occupancy survey data on acoustics, where available, to begin the process of validating and developing new criteria.
- Relates consideration of criteria to external noise environments from the point of view of the feasibility of different natural ventilation strategies.
- Reviews available products and components for noise control at the building envelope in natural ventilation systems.
- Proposes directions for further work.

Aspects of sustainable design that are not directly relevant to the perceived impediment that external noise poses to the use of natural ventilation are not considered. In particular:

- Standards for noise egress (e.g. mechanical equipment noise breaking out from a building) and their effects on the environment are not considered.
- Naturally ventilated and mixed mode buildings often incorporate related design elements, such as exposed concrete ceilings, which can impact the acoustic environment and post occupancy survey results. Such elements are considered only in terms of the attempt to separate the direct implications of external noise break in from the effects of other aspects of design.

- Potential improvement to the internal acoustic environment of offices by the use of sound absorbing materials is not discussed.
- The potential for masking sound systems to mitigate the negative acoustic effects of natural ventilation strategies is identified. However, consideration of the design or selection of masking sound systems is not directly relevant to the consideration of perceived impediments to natural ventilation and is not included.

Natural ventilation methodologies are not described in detail in this Section.

A description of the acoustic terminology used in this report is given in an appendix in Section A.11. Included is a description of the different aspects of the overall (ambient) noise in an office (mechanical systems noise, occupational noise and external noise breaking in).

A.2 Legacy Criteria

The interior acoustic design of office buildings is not regulated and acoustic criteria are discretionary. Internationally recognized standards provide recommended guidelines for internal background noise limits, as described in Table A.1.

Table A.1: Legacy Criteria

Country	Standard/guideline	Noise limit: open office	Noise limit: enclosed office
US	ASHRAE 2011* <i>2011 ASHRAE Handbook – HVAC Applications (Chapter 48)</i> ASHRAE	NC40 (45dBA)	NC30 (35dBA)
Australia / New Zealand	AS/NZS 2107:2000 <i>Acoustics – Recommended design sound levels and reverberation times for building interiors.</i> Standards Australia and Standards New Zealand	Satisfactory: 40dB L_{Aeq} Maximum: 45dB L_{Aeq}	Satisfactory: 35dB L_{Aeq} Maximum: 40dB L_{Aeq}
UK	BS 8233: 1999 <i>Sound insulation and noise reduction for buildings. Code of practice</i> British Standards Institution	45-50dB L_{Aeq} **	<i>Cellular Office</i> Good: 40dB L_{Aeq} Reasonable: 50dB L_{Aeq} <i>Executive Office</i> Good 35dB L_{Aeq} Reasonable 40dB L_{Aeq}

* Also included is, “Rooms with Intrusion from Outdoor Noise Sources” which gives 45dBA for both traffic noise and aircraft flyovers. Intrusive noise is addressed “for use in evaluating possible non-HVAC noise that is likely to contribute to background noise levels,” i.e., it relates to consideration of external noise break in to mechanically ventilated buildings. While the inclusion of these numbers suggests that external noise ingress should be separately considered from HVAC noise, the numbers given are essentially the same as legacy criteria for HVAC noise in open offices. This entry does not expressly relate to any particular building use and it is understood that its inclusion resulted in large part from consideration of noise affecting schools (S. Wise, private communication).³⁸ This inclusion for rooms with noise from outdoor sources does not purport to address the issue of setting criteria for external noise break in to naturally ventilated offices.

**Note that a range is given for open offices in order to prevent them from becoming too quiet to maintain reasonable acoustic privacy in a shared space, i.e. BS8233 recommends that the steady background noise in an open office should not exceed 50dB L_{Aeq} or fall below 45dB L_{Aeq} . (Maintaining a minimum noise level may require sound masking.)

These standards are roughly consistent, recommending that the background noise should not exceed 40dB L_{Aeq} to 50dB L_{Aeq} in open offices and 5dB to 10dB lower in cellular or executive offices. The standards generally assume that buildings are sealed and air conditioned and that the recommended noise limits are met by controlling the steady background noise from building systems.

³⁸ E-mail from Steve Wise (ASHRAE Committee Member) to Fiona Gillan, Arup, July 2, 2012.

Achieving these standards for control of external noise in naturally ventilated buildings in noisy urban environments is often not feasible and, hence there is a perception that natural ventilation results in unacceptably high indoor noise levels, which acts as a barrier to its implementation.

However, research indicates that criteria for acceptable external noise inside naturally ventilated offices may be higher than legacy criteria for steady mechanical systems noise in sealed, air-conditioned buildings (Field, 2008; Field & Digerness, 2008).

A.3 Revised Criteria for External Noise Break-In

A.3.1 Hypothesis

It is postulated by many researchers that internationally recognized legacy background noise criteria for building use may be too stringent for buildings with passive ventilation systems (Ghiaus & Allard, 2005).

Sensitivity to background noise in sealed air-conditioned buildings is well established (Field & Digerness, 2008). However, when natural ventilation is used, peoples' sensitivity to noise is believed to change. This change may be attributed to the following factors:

- The expectation of a low noise environment is less.
- The appreciation of non-acoustic benefits, such as reduced energy consumption and enhanced quality of the work environment, may facilitate compromise on noise levels.
- Different noise sources are known to provoke different annoyance responses (Kryter, 1985). The legacy criteria are primarily based on steady state mechanical systems noise. External noise ingress to buildings depends on the surrounding environment. When noise has a character that is more representative of the outdoor environment it is possible that it is may be considered more acceptable.
- Continuous versus time varying noise interferes differently with speech intelligibility. Statistical noise levels for a time varying signal, such as auto traffic noise, may be used to estimate the % of time that speech will be disrupted.
- Control of ventilation through operable windows or vents also allows control over external noise ingress. It is hypothesized that workers will accept higher noise levels coming through a window if they have control over when the window is open. By introducing a level of control, individual sensitivity to noise may be managed. Although this benefit is difficult to quantify, it is viewed as a positive factor in the adoption of natural ventilation (Field, 2008).
- People adapt to their environments and urban dwellers may be tolerant of urban sounds as a necessity of city life.

A.3.2 Research

A.3.2.1 Annoyance, Task Interference, and Health Effects Studies

The most significant health effects of noise are hearing loss and sleep disturbance. Sleep disturbance is not relevant to commercial buildings and noise levels in offices would normally

be below levels considered dangerous to hearing. 70dBA for the entire 24 hour period regarded as safe for hearing (Passchier-Vermeer, 1993) and noise at work regulations (based on an 8 hour day) generally apply at levels of 85dBA and above.

Beranek (1971) proposed 68dBA as max limit for office and communications situations for steady noise from all sources. In industrial situations where speech and telephone communications are important, e.g. a foreman's office or a control room, an acceptable criterion for background noise of 70dBA has been proposed (Bies & Hansen, 1996). This may be related to the effects of vocal strain, rather than to consideration of hearing conservation or good communication conditions.

However, consideration of the quality of environment, stress, annoyance and cultural expectations etc. must also be addressed.

Behavioral responses to noise are normally explained in terms of arousal theory (Bies & Hansen, 1996). Noise can be beneficial, depending on the type of task being performed. However, studies have shown that if the noise level is far in excess of that required for optimal arousal for a particular task, workers become irritable and less efficient. Noise can, therefore, have adverse effects at levels below those that could cause hearing damage. Unfortunately, the problem is complex, given varied work tasks and noise sources and varying individual responses and the research does not provide a generally applicable criterion for overall noise levels in office space.

A review of the research carried out on the health effects of noise concluded that there was no dose-effect relationship available concerning noise annoyance in the working environment. However, it noted that noise annoyance in office buildings was substantial. A few reports exist suggesting that this starts at 55dBA with 35% to 40% of workers severely annoyed at 55 to 60dBA during working hours (Passchier-Vermeer, 1993).

The research on annoyance, task interference and health effects shows that this is a complex topic and yields conflicting numbers for acceptable and desirable noise levels. It should be noted that it generally related to the overall ambient noise, including occupational noise, and not to external noise break-in alone.

A.3.2.2 Speech Intelligibility

With little concrete guidance provided by research into annoyance and reduced efficiency caused by noise, some researchers have considered disruption to speech intelligibility as a suitable basis for establishing maximum noise levels in offices.

Wilson (1992) included a discussion of whether higher background noise criteria could be suitable in naturally ventilated offices compared to mechanically ventilated offices. Based on BS 8233 and CIBSE Guidance for steady ambient noise (CIBSE, 1986), he determined that:

- Conversations at normal voice level are satisfactory over a distance of 1m at 57dBA and 2m at 51dBA.
- Phone conversations are satisfactory at 58dBA and slightly difficult at 68dBA.

Based on these considerations, the author suggested a maximum noise criterion in the range 55dB L_{Aeq} to 60dB L_{Aeq} .

Also, CIBSE (2007) suggests that telephone conversation can be carried out in reasonable comfort if the ambient level is below 60dBA.

Subjective testing in the Arup New York SoundLab (Field & Digerness, 2008) determined speech intelligibility levels with various background noise conditions. The results indicated that a “good” speech intelligibility rating could be achieved in offices with internal noise levels, from city street noise, of up to 59dBA.

A.3.2.3 Subjective Surveys Combined with Noise Measurements

Two studies that combined objective measurements of the overall noise in offices with subjective surveys are described below.

Dubiel *et al.* (1996)

This paper reports the findings of measurements and surveys in seven offices in the UK and six in Pakistan. All the offices were naturally ventilated except for one in Pakistan. Although some of the Pakistan offices had window air conditioning units or additional ducted systems these were often not working. The data collection method ensured that when a subject recorded a set of subjective responses, a set of physical measurements was made within 90 seconds. The report looks at the results of 568 such complete data sets, 258 in the UK summer, 122 for Pakistan in the summer and 188 for the UK in winter.

A seven point scale was used to describe the noise level in the subjective questionnaire, ranging from “Much too quiet” to “Much too noisy.”

The following conclusions were drawn:

- On 67% of the occasions where noise was deemed to be “Too noisy” or “Much too noisy”, the noise was described as “External” rather than “Internal” or “Internal and External”. However, the noise measurements did not distinguish between internal and external noise sources. It should be noted that the offices in the study were chosen because of reported difficulties with external noise.
- From the UK summertime data, the noise level deemed “Just right” depended on activity, as follows
 - Computer work: 49dB L_{Aeq}
 - Reading: 56dB L_{Aeq}
 - Meeting, phoning, word processing/typing: 57 -58dB L_{Aeq}
 - Talking, taking a break: 59 – 60 dB L_{Aeq}
 - Writing and other individual activities: 60-61dB L_{Aeq}

- Taking the data as a whole, or by region, it was not possible to determine a correlation between the measured noise and the subjective response. However:
 - For each office, the noise level measurements were “corrected” by subtracting from each measurement the “typical noise level” for that office. These “corrected” noise levels were found to be highly correlated to the subjective response.
 - The noise levels in each office, varying from approximately 50dBA to approximately 70dBA were generally considered to be “Just right” when they were the similar to the “typical noise level” for that office.
 - Therefore, it was concluded that the respondents had adapted to their acoustic environment.

Nicol & Wilson (2004)

The EU funded a smart controls and thermal comfort project (SCATs) to develop control algorithms for naturally ventilated and air conditioned buildings based on the theory of adaptive thermal comfort. The project included consideration of acoustics. Office surveys were carried out in 25 offices in five European countries on a monthly basis over a year. There were a total of 850 respondents. Noise was measured at each work station and the question “How do you find the background noise level at your work area at this time?” was included in the survey. Respondents could choose their answer on a 7 point scale from “Very noisy” to “Very quiet.”

Averaging all the results indicated that up to an L_{A90} of 52dB and an L_{A10} of 65dB respondents considered the noise level “Neither noisy nor quiet” and that an increasing perception of noisiness was experienced above those levels. From this it was concluded that 60dB L_{Aeq} is a tolerable noise level in European offices. Further, this level was suggested as a suitable criterion for external auto noise breaking in form the exterior. However:

- The survey included mixed mode, mechanically ventilated and air conditioned buildings as well as naturally ventilated buildings. 11 of the 25 buildings were mixed mode or naturally ventilated buildings. This meant that approximately 45% of the total building occupants were in mixed mode or mechanically ventilated offices (McCartney & Nicol, 2002).
- The noise sources during the measurements are not known. It must be assumed that the measured noise levels include noise from mechanical systems (where present), external noise break in and occupational noise (voices, telephones, office equipment etc.).

Therefore, it would not seem possible to determine responses to external noise break-in to naturally ventilated and mixed mode buildings from this data. Further, if a single noise source (external noise break-in) is allowed to reach 60dBA, it must be expected that there would be an additive effect and total noise (including that from occupational sources) may exceed 60dBA.

From review of this work, it is believed that that the research described indicates that a level somewhat less than 60dBA, perhaps 55dBA, should be set for external noise break-in, and that further research is required.

A.3.2.4 References Relating to External Noise Break-In

The studies described in the previous section related subjective responses with measurements of the overall noise levels in the offices. These noise levels may have included occupational noise, office equipment noise and, in some cases, mechanical systems noise. The references described in Table A.2 below specifically consider external noise break in.

Table A.2: References Relating to External Noise Break-in

Building Research Establishment (1974)	In 1974, the British Research Establishment published a Digest addressing the interaction between thermal control and auto traffic noise ingress. It referred to experience indicating that complaints increased markedly when auto noise is above 60dBA, internally. Based on this, consideration of suitable conditions for telephone use and criteria recommended at that time for continuous noise, the Digest argued that 55dBA during normal business hours may be taken as a reasonable standard for auto traffic noise in a two person office.
Wilson <i>et al.</i> (1993)	This paper reports the findings of a preliminary study carried out by others in a naturally ventilated office in Exeter, UK. Internal traffic noise levels in the range 51-55dB L_{Aeq} generated a significant negative response from survey respondents in an office where occupational noise levels were generally in the range 59-62dB L_{Aeq} .
Field & Digerness (2008)	Subjective testing in the Arup New York SoundLab, described in Section A.3.2.2 was carried out using Soundfield microphone recordings made 3ft outside an open office window overlooking a street in downtown New York. The results indicated that a “good” speech intelligibility rating can be achieved in offices located in downtown environments with background noise levels up to 59dBA.

A.3.2.5 International Studies

Some studies have found that response to noise varies across climates and cultures.

Table A.3: International Studies

<p>Beranek (1971)</p>	<p>Research and project experience suggested that where the climate allowed for open windows throughout most of the year, people were 5dB to 10dB more tolerant of external noise break-in compared to colder areas.</p>
<p>Dubiel <i>et al.</i> (1996)</p>	<p>This paper, described in Section A.3.2.3, reports the findings of measurements and surveys in seven offices in the UK and six in Pakistan.</p> <p>The mean sound level measured in Pakistan was 66dBA compared to 58dBA in the UK. However, The respondents in Pakistan considered their environments to be less noisy than the UK subjects.</p> <p>The noise levels in each office, varying from approximately 50dBA to approximately 70dBA were generally considered to be “just right” when they were the similar to the “typical noise level” for that office.</p> <p>Respondents in the UK saw external noise as a major constraint to opening the windows while those in Pakistan did not. This was ascribed to a high level of prevailing noise in Pakistani offices.</p> <p>It was concluded that, in addition to respondents generally adapting to their acoustic environment, cultural factors may be affecting the results when comparing UK and Pakistan.</p>
<p>Nicol & Wilson (2004)</p>	<p>Office surveys were carried out in 25 offices in five European countries on a monthly basis over a year, as described above.</p> <p>The results of the survey suggested that the noise tolerance of respondents varied by country, with the Portuguese respondents more tolerant than those in the UK, Sweden and France.</p>

A.3.2.6 Post Occupancy Surveys

Post occupancy evaluations show that acoustic concerns tend to be one of the top areas of complaint from occupants of sustainable office buildings. The Center for the Built Environment (CBE) and UC Berkeley have conducted post occupancy surveys with over 65000 total respondents in 550 buildings. In one study of 23,450 respondents from 142 buildings (Jensen *et al.*, 2005), the acoustic quality consistently received the lowest average satisfaction score out of the nine core satisfaction categories (including thermal comfort, air quality, lighting and office layout). Results indicated that dissatisfaction with speech privacy (including distraction by others and the feeling of being overheard) was much greater than dissatisfaction with noise level and was largely responsible for the low average acoustic ratings. This may be viewed on a signal to noise basis with external (auto traffic) noise as uncorrelated noise and speech as a signal with meaning that is more likely to cause distraction. Aspects of sustainable office design that affect speech privacy are included in Table A.4, for reference.

Table A.4: Office Privacy

Fewer sound absorptive surfaces in favor of more glass and concrete	Day-lighting is an important sustainable design factor. Interior glazing is used to permit daylight to penetrate deeper into buildings to benefit more workers (Field, 2008). Natural ventilation is often a part of an overall energy saving strategy that may include passive cooling systems such as radiant flooring, chilled beams or exposed thermal mass at the ceilings. Without integrated and considered design measures, this increase in sound reflecting surfaces allows sound to travel further, and be relatively louder, in the passively cooled workplace than in a conventional office space using carpet and acoustic tile ceilings (<i>ibid.</i>).
Low background noise levels due to displacement or natural ventilation	Background noise levels in office buildings using chilled beams have been reported as low as NC20 (Field, 2008). The low background noise levels reduce speech privacy and increase distraction caused by surrounding conversations. A well designed electronic sound masking system may provide beneficial mitigation.
Low partition cubicles or no cubical partitions,	This can allow sound to travel further, potentially increasing the disturbance between work stations. However, the CEC post occupancy survey found little difference between the satisfaction scores relating to acoustics between respondents in high and low cubicles. Further, the satisfaction scores for respondents in open offices, with no cubical partitions, were higher. It is believed that these results are because visual contact between workers decreases the expectation of privacy and leads to a modification in behavior, with greater visibility increasing the consideration of fellow workers as the occupants are aware of others in the space (General Services Administration, 2012).

A recent UC Berkeley study with 23000 respondents from 92 buildings in four countries (Goins *et al.*, 2012) looked specifically at building occupants’ satisfaction in relation to whether they were close to sealed or operable windows or in the interior of the office space. The results indicated that workers near windows are more satisfied than those in the interior of the office and that those near operable windows are more satisfied than those near sealed windows. It was noted that, even for workers sitting near operable windows, complaints about indoor noise sources, such as people talking, were much more prevalent than outdoor noise complaints.

This work indicates that, while acoustic improvements to naturally ventilated environments are often needed, external noise break in is generally more acceptable than the voices and activities of coworkers.

Further research to associate measured noise levels with Post Occupancy Survey data and, in particular, identifies levels of external noise break-in, would be very valuable in interpreting the subjective data.

A.3.3 Summary of Research

Table A.5: Summary of Research

<p>A.3.2.1 Annoyance, task interference and health effects studies</p>	<p>It may be possible to carry out some office tasks in levels of up to 68dBA to 70dBA. However, workers may be significantly annoyed by noise levels above 55dBA.</p>
<p>A.3.2.2 Speech intelligibility</p>	<p>To facilitate communication across short distances and allow for adequate phone use, noise levels should not exceed 55dBA to 60dBA.</p>
<p>A.3.2.3 Subjective surveys combined with noise measurements</p>	<p>External noise was reported to be more of a problem than internal noise. The noise level deemed to be “Just right” varied depending on the task being carried out. People generally felt that the noise level to which they were accustomed was “Just right” and were, therefore, seen as having adapted to their acoustic environment. 55dB L_{Aeq} may be an acceptable criterion in European offices.</p>
<p>A.3.2.4 References relating to external noise break-in</p>	<p>Early UK guidelines put forward a criterion of 55dBA for auto traffic noise inside offices. A study in a single office in the UK found a negative reaction to external noise levels of 51dB L_{Aeq} to 55dB L_{Aeq} where overall noise was in the range 59dB L_{Aeq} to 62dB L_{Aeq}. A laboratory study using city street noise as the background noise source found that good speech intelligibility for office use could be achieved with a background level of 59dBA.</p>
<p>A.3.2.5 International studies</p>	<p>Research indicates that response to noise and, hence, appropriate criteria may vary by region.</p>
<p>A.3.2.6 Post occupancy surveys</p>	<p>Acoustic concerns are one of the top areas of complaint in sustainable offices. Dissatisfaction with speech privacy is generally a much greater concern than noise level. Respondents sitting near operable windows, and therefore exposed to the most external noise, reported higher satisfaction rates than those near sealed windows or located away from windows.</p>

This research indicates that the allowable level of noise break in to naturally ventilated buildings could be set higher than the building services noise criteria for sealed mechanically ventilated buildings. While a suitable criterion cannot be conclusively determined from the research, a preponderance of the work suggests that 55dB L_{Aeq} may be appropriate.

A.3.4 Further Considerations

While the research described in Section A.3.2 and A.3.3 suggests that a criterion of 55dB L_{Aeq} for external noise break in to naturally ventilated offices, it is not clear that such a criterion would

be universally applicable. Regional and individual responses are likely to vary. The nature of the external noise environment is also a factor as different noise sources are known to provoke different annoyance responses (Kryter, 1985).

Response to noise may be related to non-acoustic factors:

- The predictability of a noise
- Attitudes to the noise or noise source, such as a belief that it is bad for health.
- Annoyance is also affected by perceptions of the necessity of a noise or how usual it is or by beliefs that a responsible authority should be able to reduce the noise (Sailer & Hassenzahl, 2000).

Annoyance is also related to the character of the noise. BS 8233 states that its criteria relate to the physical characteristics of the noise only and cannot differentiate between pleasant and unpleasant sounds. The importance of psychological factors is acknowledged but it is not regarded as practicable to consider them in the standard. However, there are technical aspects of a noise environment, in addition to the overall noise level, that are very relevant to the experienced sound quality and that can be quantified. These include frequency content, temporal variability and the presence of impulsive or tonal characteristics, discussed below.

A.3.4.1 Frequency Content

The frequency content of noise can affect how a sound is perceived, for example, rumbling or hissing. This can be accounted for by considering the noise in individual octave or third octave frequency bands. Standard criterion curves for mechanical systems noise control, such as the ASHRAE NC curves, provide criteria in octave bands. A successful criterion for external noise break in to naturally ventilated offices may need to be set out in terms of a set of curves, rather than as a single figure dBA value.

Alternative approaches have been proposed and used to set targets for external noise ingress to buildings. Often these are expressed as an allowable excess above the NC, or other criterion curve, set for sealed, air-conditioned buildings. For example, external noise ingress could be controlled to meet $L_{Aeq} \text{ (dB)} = NC + 5$. The allowable excess should be dependent on the acoustic sensitivity of the occupied space (Field, 2008).

To provide more specific frequency control, a different allowable excess could be applied for each octave band of the chosen NC or RC curve (Field, 2008; Field & Digerness, 2008). This has been commonly used to permit higher excesses of road traffic noise at low frequencies, since low frequency noise is harder to control and interferes less with speech intelligibility (Saunders, 1989).

A.3.4.2 Temporal Variability

Annoyance or disturbance in an office caused by a steady noise source (such as noise from a freeway) may be different to that caused by a time varying noise (such as noise under an airport flight path). L_{Aeq} has severe limitations as a descriptor as it takes no account of the temporal characteristics of the sound. L_{Aeq} is defined as an energy equivalent time averaged noise level

that expresses the time varying sound level for the specified period as though it were a constant sound with the same total sound energy as the time varying level. While L_{Aeq} is regarded as an index compatible with the assessment of perceived acceptance to humans of environmental and transportation noise, the choice of a noise index, or statistical noise descriptor, for setting criteria for noise break in to naturally ventilated buildings warrants further assessment (Field & Digerness, 2008).

For example, the instantaneous Sound Pressure Level has a high (perhaps 50%) probability of being higher than the L_{Aeq} at any given time. A criterion expressed as an L_{A10} would be met for 90% of the time. A criterion given in terms of L_{A1} the criterion would be met for 99% of the time. This concept could be used to set a criterion that allowed interference with speech intelligibility only for a controlled proportion of time. The L_{A90} is regarded as being representative of the background noise and may be a better index for describing masking of occupational noise, relating to acoustic privacy.

A.3.4.3 Impulsive or Tonal Characteristics

Impulsive sounds and the presence of pure tones make noise more distinguishable and typically more distracting and annoying. More stringent criteria may be required if the ambient noise had either or both of these characteristics, e.g. from industrial noise sources. Weighting factors are often applied by regulatory guidance on noise assessment. For example, CIBSE gives a 5dB penalty for an easily perceptible pure tone and a 3dB penalty for impulsive or intermittent noise (CIBSE, 1999).

A.4 Measurements

A.4.1 Aims

Measurements were made with the following aims:

- Measure overall noise levels in the offices.
- Identify external noise break-in levels and/or external noise environment.
- Consider the relationship between objective acoustic measures and post occupancy survey results and users' comments.
- Quantify room acoustic characteristics relating to privacy.
- Comment on the measurements with regard to setting appropriate criteria for external noise break-in.

A.4.2 Buildings and Measurements

Measurements have been carried out at the following buildings:

Table A.6: Buildings and Measurements

Building	Description	External noise	Room finishes	Measurements
David Brower Center, Berkeley	Four story naturally ventilated building with operable windows.	Exposed to auto traffic noise from Oxford Street to the East and Allston Street to the North. The south façade is exposed to lower noise levels and has a partial line of site to Oxford Street.	Exposed concrete ceilings and carpet floors. In Suite 400, hemp coffee bean sacks, understood to contain sound absorptive foam, have been suspended below the concrete ceiling.	Measurements were carried out in: Suite 460 Private Offices (at East façade), Suite 460 Open Office (interior away from windows), Suite 460 Large Conference Room (at North facade), Suites 400 (at South façade).
Loisos + Ubbelohde, Alameda	Office on the second story of a two story building. Natural ventilation by means of operable windows. A sliding glass door to an external balcony and stair is also often left open.	The site is away from major roads and is affected by intermittent noise from a ship repair yard.	Connected open offices with wood floors: Room 1: gypsum board ceiling at approx. 10'. Room 2: underside of the pitched roof exposed, with a height varying between approx. 10' and 17'. Finish material applied to the underside of the pitched roof, between the beams.	Measurements were made in Rooms 1 and 2.
560 Mission Street, Suite 700, San Francisco	Conventional mechanically ventilated office.	Building is in a downtown environment and has sealed windows.	Carpet floor and acoustic tile ceiling.	Measurements of room acoustics only were made for purposes of comparison.

A.4.3 Results

Details of the measurements are given in an appendix in Section A.12.

A.4.3.1 Summary of Noise Levels

Table A.7: Summary of Measured Noise Levels

Building	Space	Windows	L _{Aeq} , dB	L _{A90} , dB	Comments
David Brower Center, Berkeley	Suite 460 Private Offices	Open	50-58	42-48	Auto Traffic Dominant
		Closed	42-47	35-37	
	Suite 460 Open Office	None	49	39	Auto Traffic Audible
	Suite 460 Large Conference Room	Open	51-52	47-48	Auto Traffic Dominant
		Closed	41	34	
	Suite 400	Open	48	43	Autos 45-50dBA.
External	N/A	68	59	Façade Level.	
Loisos + Ubbelohde, Alameda	Room 1	Varies	46-50	37-45	People talking and plotters/copiers. External noise was not a subjectively significant contributor to the ambient noise in the office
	Room 2	Varies	52	38	
	External Noise	N/A	56	51	Delivery trucks, distant airplanes, general marina noise. Façade Level.

The following are noted:

- External noise breaking into the Brower Center (50dB L_{Aeq} to 58dB L_{Aeq}) is similar to that suggested as the maximum allowable in Section A.3.3, 55dB L_{Aeq}.
- Both buildings experience low background noise levels, with as low as 34dB L_{A90} in the Brower Center and 37dB L_{A90} in Loisos + Ubbelohde. This may be expected to contribute to low privacy.
- *External* noise at Loisos + Ubbelohde is comparable to the level suggested as the maximum allowable *internal* level. External noise does not normally contribute significantly to the indoor noise environment.

A.4.3.2 Privacy

As a measure of speech privacy across the open offices, the Articulation Index, AI, has been calculated from the acoustic measurements according to ASTM E1130. The following graph shows the AI for the Brower Center open office and Loisos + Ubbelohde.

The AI is a function of the way sound travels across the office, which is affected by the room acoustics and finishes, and of the ambient noise in the office.

Figure A.1: Articulation Index vs. Communication Distance

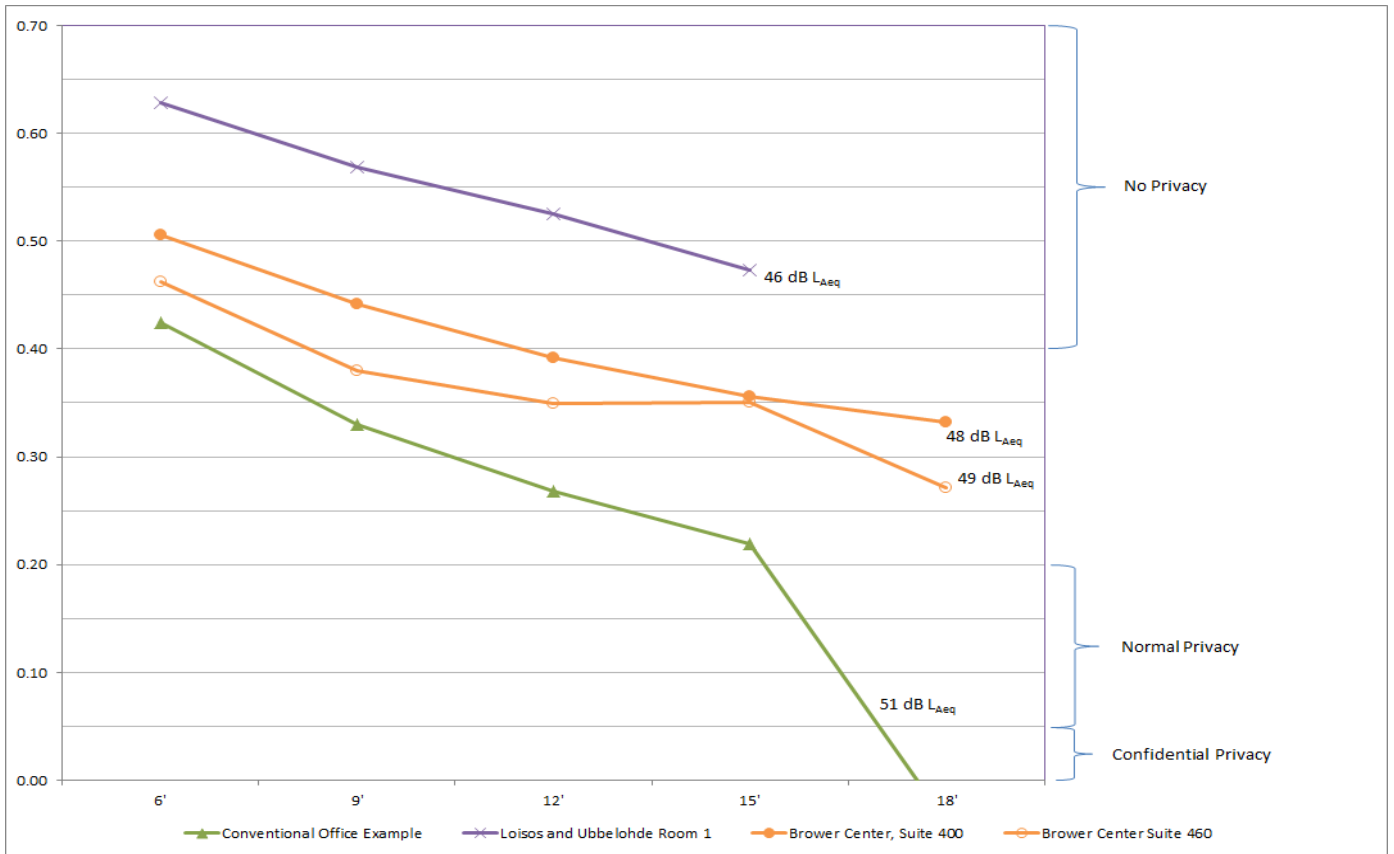

To provide a context for these AI measurements in naturally ventilated offices, AI was calculated using the measurements of the way sound travels across the office at 560 Mission Street (which has a carpet and acoustic ceiling tile) and typical occupational noise from an office providing an overall level of 51dB L_{Aeq}. (Note that actual noise levels at 560 Mission Street are much lower than typical for a conventional office and were not used.)

Relationship of AI to open office privacy has not been developed. As a guide, Normal privacy, often set as a target between cellular offices, may be taken as values between 0.05 and 0.20. Speech becomes more readily understood at AI > 0.20. Above AI=0.40, there is essentially no privacy.

The low AI values correspond with the complaints about privacy in the Post Occupancy Survey at the Brower Center. See Section A.4.4.

A.4.4 Post Occupancy Survey Results

A.4.4.1 David Brower Center

The post occupancy survey of the David Brower Center (Bauman *et al.*, 2011; F. Bauman, private communication) indicated a high level of dissatisfaction with acoustics.³⁹ The Acoustic Quality score was 18% while the General Satisfaction score was 87%. In particular:

- 58% of respondents were dissatisfied with the noise level in the work space.
- 85% of respondents were dissatisfied with the sound privacy.
- 78% of respondents found that the acoustic quality interfered with their ability to get work done.

Respondents who were dissatisfied with acoustics reported that the following noise issues contributed to the problem (Table A.8).

While outdoor traffic noise is mentioned by 31% of respondents, it is not one of the most significant noise issues. Indoor noise sources (people talking), privacy issues and “echoing” of sound are reported as problems by 1.9 to 2.8 times the number of respondents reporting that outdoor traffic noise is a problem.

Although outdoor traffic noise is the dominant source of outdoor noise, other outdoor noise is reported as a problem by 24% of respondents. This corresponds with information from discussions with tenants in the building, that occasional loud noises, such as that from garbage trucks, causes more annoyance than the general auto traffic noise.

³⁹ “David Brower Center, Occupant Survey Report, Survey Dates: 3/22/2010 to 4/2/2010”, document e-mailed from Fred Bauman, Center for the Built Environment, UC, Berkeley, to Fiona Gillan, Arup.

Table A.8: Noise Issues and the David Brower Center

Noise Issue	% of responses
People talking on the phone	86
People overhearing my conversations	86
People talking in neighboring areas	84
Excessive echoing of voices or other sounds	60
Telephones ringing	36
Outdoor traffic noise	31
Office equipment noise	29
Other outdoor noise	24
Mechanical (heating, cooling and ventilation systems) noise	7
Other	3

A.4.4.2 Loisos + Ubbelohde

Post occupancy survey work has been carried out at Loisos + Ubbelohde by the Center for the Built Environment/ UC Berkeley but the survey data has yet to be analyzed. From talking to the office occupants, external noise is an issue and approximately once a week they have to close the door and windows, for example, to conduct a telephone conference. When noise is an issue, the source is usually the intermittent industrial noise from the ship repair yard.

As stated in Section A.4.3.1, the L_{Aeq} measured *outside* the building is of the order of the suggested criterion for external noise *inside* offices and external noise is generally not a significant contributor to the internal noise. Despite the relatively quiet noise environment, external noise is still occasionally an issue due to the nature of the outdoor noise. This indicates the need to consider the type of noise source and its temporal variability and illustrates the inadequacy of a single figure criterion expressed as L_{Aeq} .

A.5 Noise Environments and Feasibility of Natural Ventilation

A.5.1 Natural Ventilation

The location and type of openings through the building envelope for air transfer will depend on the natural ventilation strategy, whether the system is wind or buoyancy driven, solar assisted, single sided or cross ventilation. A combination of strategies may be used. However, air inlets and outlets are generally either:

- At the façade, e.g. operable windows, louvers, acoustically attenuated vents, etc.
- Located at roof level, e.g. chimneys, stacks and wind towers. These are often similar to traditional Middle Eastern methods such as the Iranian wind tower (*bādġīr*).

It may be expected that the air path between an occupied space and a roof level ventilation opening will be longer than that between an occupied space and a façade opening. Operable windows, for example, open directly into the occupied space while air may be transferred via ducting, a chimney stack or a circulation area between the occupied space and the roof. Therefore, with a roof level opening, the sound attenuation inherent in the air path, and the opportunity to introduce further noise control, is greater than at the façade. On this basis, the feasibility of natural ventilation will normally be determined by the noise ingress through the façade. (An exception to this would be a system that only had openings at roof level, such as a balanced stack system.)

A.5.2 Methodology for Feasibility Assessment

Sound isolation of building facades and façade elements is described in many different ways with acoustic testing carried out to a variety of international standards and expressed using a variety of different indices. This makes it difficult to directly compare published noise data between products and regions.

In order to maintain consistency with the bulk of the published research in this area, the performance of different ventilation strategies is described in terms of the Level Difference, D , where

$$D = L_{\text{ext}} - L_{\text{int}} \quad (1)$$

- L_{ext} is the “façade level” measured at 1m to 2m from the building envelope and includes sound reflected off the façade back to the microphone. Note that the levels at 1m and at 2m are generally similar (Wilson, 1992).
- L_{int} = average Sound Pressure Level measured inside the occupied space.

D can be measured or calculated in third octave or octave frequency bands. D_w , the Weighted Level Difference, is a single figure rating used to describe the broad band noise Level Difference.

Measurement and calculation methods for Level Difference are set out in BS EN ISO 140-5:1998 and EN 12354-3:2000. In the US, ASTM E966 provides similar measurement and calculation methods and describes an Indoor Outdoor Level Reduction (IOLR), which may be defined as

$$\text{IOLR} = L_{\text{ff}} - L_{\text{int}} \text{ (dB)} \quad (2)$$

where

- L_{ff} = Free field Sound Pressure Level at 1m to 2m from the building envelope, i.e. the incident sound without the sound reflected off the façade back to the microphone.

Note that

$$L_{\text{ff}} = L_{\text{ext}} - 3 \text{ (dB)} \quad (3)$$

Therefore

$$\text{IOLR} = D - 3 \text{ (dB)} \quad (4)$$

Hence, natural ventilation with a façade providing a Level Difference of D_w may be feasible if the external noise does not exceed

$$\text{Max. Feasible } L_{\text{ext}} = \text{Criterion for External Noise Break-in} + D_w \text{ (dB)} \quad (5)$$

The sound attenuation provided by a given type of natural ventilation opening will depend on details of its implementation so generalized ranges for the Level Difference are considered.

A.5.3 Types of Natural Ventilation Openings

A.5.3.1 Operable Windows

Open windows are the simplest way to achieve natural ventilation with little pressure drop. However they provide limited protection against rain, wind, dust, insects and noise and can raise security concerns.

The noise attenuation of an open window is generally accepted to be 10dB to 15dB (Ryan *et al.*, 2011; Waters-Fuller & Lurcock, 2007; Ghiaus & Allard, 2005). A Napier University report for the Department for Environment, Food and Rural Affairs in the UK looked in detail at the sound isolation of open windows in residential buildings (Waters-Fuller & Lurcock, 2007). The report provides a review of the relevant literature and information on the effects of the frequency content of the source noise, size of the opening parts of the window and the directivity of the source relative to the window orientation and geometry.

A.5.3.2 Open Windows With Carefully-Oriented Geometry and/or Strategically-Located Sound Absorption

Researchers have suggested that “Using special methods and window designs” an increase of 3dB to 5dB may be achieved in addition to the accepted 10dB to 15dB attenuation for an open window (Ghiaus & Allard, 2005).

Waters-Fuller & Lurcock (2007) found that the sound isolation of different window opening styles, with the same open areas, varied by 4dB to 6dB. It did not, however, find a particular window style that was consistently better than the others in tests that used a variety of source and microphone locations.

Screening of window openings from the noise source, e.g. by balconies or by integrating noise screening with external sun shading structures, can be beneficial. However, the benefit is reduced where there are multiple noise sources or in semi-reverberant situations such as a street canyon where sound is reflected off surrounding buildings. Measurements in Athens found the benefit of balconies in street canyons to be between 2dB and 3dB (Ghiaus & Allard, 2005).

In a situation where the noise source is highly directional, the benefits of screening are maximized. Experience at an airport (Butera & Hewett, 2012) demonstrated that overlapping glass louvers, providing screening of the window openings, can provide a significant increase (close to 10dB) in the sound reduction through a building envelope. However, determining the geometry and angles of the louvers required careful consideration of the orientation of the façade to the noise source (flight path). This method is unlikely to be as successful where there are multiple noise sources or in a street canyon.

Small increases in the sound isolation of an open window may be possible by carefully locating sound absorption relative to the window openings such that sound entering the occupied space is attenuated by the absorption. For example a bottom hung inwardly opening window could be used in conjunction with an area of sound absorption on the ceiling soffit along the façade and above the open parts of the windows.

Based on the above, an allowance of 2dB to 5dB, compared to open windows in general, has been made for the typical benefit of this type of measure.

A.5.3.3 Integrated Façade Design

Usually, a sound attenuated air path through an integrated façade design is based on a double skin facade. A double façade is used with the openings in each layer separated such that the air path goes through some portion of the façade cavity. Compared to operable windows in a single skin façade, this provides increased protection against wind, rain and noise as well as helping with security and safety concerns. However, air may be “pre-heated” as it rises through the cavity which is of concern in hot weather and/or climates.

Other possibilities for air intake in an integrated building design include air intake paths via a raised floor.

Ford and Kerry

Early measurements by Ford and Kerry, both in a laboratory (Ford & Kerry, 1973) and in the field (Kerry & Ford, 1974), demonstrated the sound isolation provided by deep double glazing with staggered openings, a simple double skin concept. They looked at dual sliding windows with cavity depths of 25mm to 200mm. Each sliding portion was opened by 25mm to 200mm.

This led to a number of combinations and a range of sound isolation performance. The most relevant data from this work has been determined based on:

- Cavity depths of 100mm and 200mm are most similar to modern double skin facades.
- 100mm and 200mm are most likely to allow a reasonable air flow representing 3% to 8% and 7% to 15% of the total tested window area, respectively.
- The benefit of the sound absorptive foam lining to the cavity reveals was found to be 3dB to 6dB. It is expected that sound absorption should be included in the cavity of double skin facades.

For windows with these cavity depths and opening dimensions, and with sound absorptive lining, the average Sound Reduction Indices from 100Hz to 3150Hz measured in the laboratory were:

- 20dB to 22dB, both windows sliding horizontally.
- 15dB and 18dB, both windows sliding vertically. This lower performance was attributed to the shorter air path through the cavity with this configuration.

In the field, measured sound level differences between the outside and inside (similar to D in Section A.5.2) were:

- 26dB and 30dB, one window sliding horizontally and the other vertically (and with sound absorptive lining).

These field sound level differences seem unexpectedly high. The following reasons were given:

- The authors noted that these level differences were generally 1 to 3dB higher than expected based on the laboratory SRIs. This was partly due to the fact that laboratory conditions a diffuse sound field was incident on the windows while the sound incident on the windows of the house tested in the field was directional. (The noise sources were individual aircraft movements and auto pass-bys.)
- The receiving rooms were bedrooms and so the acoustic conditions were not representative of commercial buildings. Increased internal sound levels, and hence reduced sound level differences may be expected in more reverberant conditions.

Discussion and Conclusion

Project experience including a test of a full size mockup of a facade portion and field measurements of an installed double skin façade confirm that these early measurements by Ford and Kerry are of the order that may be expected for modern double skin façade strategies.

Based on the above, an estimate of $D_w = 20\text{dB}$ to 25dB has been made for the likely performance range of an acoustically successful double skin façade design in a commercial building.

A.5.3.4 Acoustically Attenuated Ventilators

A Level Difference range of $D_w 20$ to $D_w 30$ has been based on calculations using published data for currently available proprietary ventilators (Silencair). See Section A.7.2.

It should be noted that achieving the upper end of the quoted range may not always be possible, depending on the design of the building interior and on the air flow requirements.

A.5.4 Comparison for Feasibility Assessment

Table A.9 gives external noise limits for feasibility of natural ventilation based on Equation (5) using a criterion for external noise break-in to office space of $55\text{dB } L_{Aeq}$.

Table A.9: Feasibility of Natural Ventilation (Based on Noise Only)

Type of Natural Ventilation Opening (See Sections A.5.3)	Approximate Level Difference, D_w	Max. Feasible L_{ext}, dB L_{Aeq}
Operable Windows	10-15	65-70
Open windows with carefully oriented geometry and/or strategically located sound absorption	12-20	67-75
Integrated Facades Design	20-25	75-80
Acoustically Attenuated Ventilators	20-30	75-85
<i>Sealed thermal glazing with mechanical ventilation - Included for comparison</i>	≈ 30	85

A.6 Other Acoustic Issues

Natural ventilation may lead to other acoustic issues that are listed below as potentially requiring attention on projects.

Table A.10: Other Acoustic Issues

Actuator noise	When windows or vents are opened automatically based on thermostat or Building Management System controls, noise from the actuators may be heard in occupied space. Actuator noise may be noticeable and distracting as it is likely to have a tonal character as well as being intermittent. While the noise itself could be an issue, most complaints seem to arise when the environmental sensors are set to too narrow ranges and the actuators operate frequently.
Wind noise	Consideration of wind generated noise may be required at wind or solar towers or at: Openings to the wall cavity, which could behave as Helmholtz or open pipe resonators. Closely spaced repeating elements or sharp edges, which could give rise to vortex shedding.
Privacy	Dual skin facades can introduce significant privacy issues between occupied spaces if these spaces share a common façade cavity. Such situations require detailed acoustic design consideration. The routing of exhaust shafts from different occupied spaces or from different floors should be considered from the point of view of acoustic cross talk between spaces. Where air moves through a building, it may need to pass through internal sound isolating partitions. The air transfer openings or devices at these partitions must provide appropriate sound attenuation.
Changing external noise environment	Internal noise levels in a naturally ventilated building could change over time if the external noise environment changes. Such changes could result from planning changes (traffic rerouting, industrial facilities opening/closing, etc). Gradual changes in urban noise (dominated by auto traffic) are possible. Internal combustion engines vehicles could get quieter and the % of electric and hybrid vehicles on the roads will likely increase. ⁴⁰ However the benefits of such changes may be undermined by an increase in traffic due to population growth (US Department of Transportation, 2013).

A.7 Noise Control Products for Natural Ventilation Openings

A.7.1 Products

⁴⁰ See http://ec.europa.eu/enterprise/sectors/automotive/environment/noise/index_en.htm, “Noise emissions of motor vehicles”, European Commission, 2011.

Table A.11: Acoustically-Attenuated Ventilators

Product type	Description								
Silencair	<p>These are Australian products but are available in the US. See www.silenceair.com. They are intended for attenuated air transfer for natural ventilation.</p> <p>Silencair products are available for external facade applications and are designed to fit within the depth of a 240mm wall. These include:</p> <ul style="list-style-type: none"> • Silencair Brickvent (a single module) • Silencair Window Vent (25 modules grouped together) • Silencair Wall Vent (10 modules grouped together) <p>The Window Vent and Wall Vent products allow larger volumes of air to be transferred through a single unit.</p> <p>The sound attenuation is provided by a reactive, quarter wave resonator mechanism.</p>								
Background ventilators	<p>There are many of these available, mostly in the UK to meet UK residential code requirements, including those from:</p> <p>Passivent (www.passivent.com), Greenwood (www.greenwood.co.uk) Rytens (www.vents.co.uk/products.asp).</p> <p>These are through-wall ventilators, usually comprising one or more pipes with sound absorptive lining and louvers, or controllers, at each end. They are used to provide background ventilation when windows are closed in residential buildings. It is generally assumed that the possible airflow is insufficient for commercial use.</p> <p>While background ventilators are not intended for air transfer for naturally ventilated commercial buildings, they are not necessarily of a constricted or high pressure drop design. However they are relatively small and hence are likely to be impractical. For example, to transfer 300l/s at 1Pa pressure difference, the following numbers of ventilators would be required:</p> <table style="margin-left: auto; margin-right: auto;"> <tr> <td>Background Ventilator (Passivent Fresh 90)</td> <td>146</td> </tr> <tr> <td>Silencair Brickvent</td> <td>65</td> </tr> <tr> <td>Silencair Wall Vent</td> <td>7</td> </tr> <tr> <td>Silencair Window Vent</td> <td>3</td> </tr> </table> <p>Acoustic Window Slot Ventilators have not been considered as “acoustic” models do not appear to perform significantly better than standard models (McCartney & Nicol, 2002).</p>	Background Ventilator (Passivent Fresh 90)	146	Silencair Brickvent	65	Silencair Wall Vent	7	Silencair Window Vent	3
Background Ventilator (Passivent Fresh 90)	146								
Silencair Brickvent	65								
Silencair Wall Vent	7								
Silencair Window Vent	3								
Acoustic louvers	<p>These are standard noise control products available in a range of dimensions, configurations and performances, typically from 4” to 24” deep. Manufacturers include:</p> <p>IAC (www.industrialacoustics.com) Vibro-Acoustics (www.vibro-acoustics.com).</p> <p>These are metal louvers with sound absorptive material included inside the louver blades. Perforated metal on the underside of the blades exposes the sound absorption.</p> <p>Generally, these are used to reduce noise break out from mechanical equipment rooms and other noisy enclosures. They are not designed to keep rain and wind out of occupied spaces but may be used in conjunction with valves etc. as part of an</p>								

Product type	Description								
Silencair	<p>These are Australian products but are available in the US. See www.silenceair.com. They are intended for attenuated air transfer for natural ventilation.</p> <p>Silencair products are available for external facade applications and are designed to fit within the depth of a 240mm wall. These include:</p> <ul style="list-style-type: none"> • Silencair Brickvent (a single module) • Silencair Window Vent (25 modules grouped together) • Silencair Wall Vent (10 modules grouped together) <p>The Window Vent and Wall Vent products allow larger volumes of air to be transferred through a single unit.</p> <p>The sound attenuation is provided by a reactive, quarter wave resonator mechanism.</p>								
Background ventilators	<p>There are many of these available, mostly in the UK to meet UK residential code requirements, including those from:</p> <p>Passivent (www.passivent.com), Greenwood (www.greenwood.co.uk) Rytons (www.vents.co.uk/products.asp).</p> <p>These are through-wall ventilators, usually comprising one or more pipes with sound absorptive lining and louvers, or controllers, at each end. They are used to provide background ventilation when windows are closed in residential buildings. It is generally assumed that the possible airflow is insufficient for commercial use.</p> <p>While background ventilators are not intended for air transfer for naturally ventilated commercial buildings, they are not necessarily of a constricted or high pressure drop design. However they are relatively small and hence are likely to be impractical. For example, to transfer 300l/s at 1Pa pressure difference, the following numbers of ventilators would be required:</p> <table border="0" style="margin-left: 40px;"> <tr> <td>Background Ventilator (Passivent Fresh 90)</td> <td style="text-align: right;">146</td> </tr> <tr> <td>Silencair Brickvent</td> <td style="text-align: right;">65</td> </tr> <tr> <td>Silencair Wall Vent</td> <td style="text-align: right;">7</td> </tr> <tr> <td>Silencair Window Vent</td> <td style="text-align: right;">3</td> </tr> </table> <p>Acoustic Window Slot Ventilators have not been considered as “acoustic” models do not appear to perform significantly better than standard models (McCartney & Nicol, 2002).</p>	Background Ventilator (Passivent Fresh 90)	146	Silencair Brickvent	65	Silencair Wall Vent	7	Silencair Window Vent	3
Background Ventilator (Passivent Fresh 90)	146								
Silencair Brickvent	65								
Silencair Wall Vent	7								
Silencair Window Vent	3								
	<p>integrated design. They have been used over operable windows (Ghiaus & Allard, 2005) but at the cost of daylight and views. Acoustic louvers may be particularly useful in the case of indirect air intake via cool basements.</p>								
Proprietary lined duct “boot” type silencers	<p>Custom attenuators could be based on, or incorporate, proprietary lined duct boots. These are standard noise control items intended for attenuated air transfer in mechanically ventilated buildings. However, there is no obvious reason why these should not be appropriately sized for the lower pressure drops in a natural ventilation application.</p> <p>Coordination between disciplines would be required to provide a design that was suitable for external applications.</p> <p>Z-shaped silencers could fit within a partition. Larger models would require a double stud partition. U or C shaped silencers are intended to fit in a ceiling void. Location with a bulkhead is also possible, e.g. with an L-shaped silencer.</p>								

Product type	Description								
Silencair	<p>These are Australian products but are available in the US. See www.silenceair.com. They are intended for attenuated air transfer for natural ventilation.</p> <p>Silencair products are available for external facade applications and are designed to fit within the depth of a 240mm wall. These include:</p> <ul style="list-style-type: none"> • Silencair Brickvent (a single module) • Silencair Window Vent (25 modules grouped together) • Silencair Wall Vent (10 modules grouped together) <p>The Window Vent and Wall Vent products allow larger volumes of air to be transferred through a single unit.</p> <p>The sound attenuation is provided by a reactive, quarter wave resonator mechanism.</p>								
Background ventilators	<p>There are many of these available, mostly in the UK to meet UK residential code requirements, including those from:</p> <p>Passivent (www.passivent.com), Greenwood (www.greenwood.co.uk) Rytons (www.vents.co.uk/products.asp).</p> <p>These are through-wall ventilators, usually comprising one or more pipes with sound absorptive lining and louvers, or controllers, at each end. They are used to provide background ventilation when windows are closed in residential buildings. It is generally assumed that the possible airflow is insufficient for commercial use.</p> <p>While background ventilators are not intended for air transfer for naturally ventilated commercial buildings, they are not necessarily of a constricted or high pressure drop design. However they are relatively small and hence are likely to be impractical. For example, to transfer 300l/s at 1Pa pressure difference, the following numbers of ventilators would be required:</p> <table border="0" style="margin-left: 40px;"> <tr> <td>Background Ventilator (Passivent Fresh 90)</td> <td style="text-align: right;">146</td> </tr> <tr> <td>Silencair Brickvent</td> <td style="text-align: right;">65</td> </tr> <tr> <td>Silencair Wall Vent</td> <td style="text-align: right;">7</td> </tr> <tr> <td>Silencair Window Vent</td> <td style="text-align: right;">3</td> </tr> </table> <p>Acoustic Window Slot Ventilators have not been considered as “acoustic” models do not appear to perform significantly better than standard models (McCartney & Nicol, 2002).</p>	Background Ventilator (Passivent Fresh 90)	146	Silencair Brickvent	65	Silencair Wall Vent	7	Silencair Window Vent	3
Background Ventilator (Passivent Fresh 90)	146								
Silencair Brickvent	65								
Silencair Wall Vent	7								
Silencair Window Vent	3								
	<p>Products include Ruskin, Dynasonics, IAC QuietVent, Vibro Acoustics CT Cross Talk Silencers. These manufacturers produce similar products in a variety of sizes and shapes.</p>								
Attenuation of roof-level openings	<p>Subject to maintaining appropriately low pressure drops, standard mechanical noise control methods may be used in stack ducts. Sound absorptive duct lining may be suitable. The performance of such measures may be reduced by the larger size of these ducts compared to a conventional mechanical ventilation system.</p> <p>Acoustically attenuated devices are available for roof level vents. See www.monodraught.com. Monodraught wind catchers are available with 25mm and 50mm thick acoustic foam lining.</p>								

A.7.2 Acoustic Performance

Acoustic testing is carried out to a variety of international standards and expressed using a variety of different indices. This makes it difficult to directly compare published noise data between products and regions.

In defining the performance of specific components, tests are carried out under controlled conditions to allow comparison. Conversion calculations may be required between tests carried out to different standards, reported using different indices or measured under different conditions.

The sound isolation of a product is defined in terms of its transmission loss or sound reduction index, R. Note that, while the Level Difference across a façade with an open window may be in the range 10dB to 15dB, the transmission loss of the window itself will be close to zero.

A unit commonly used for ventilator sound isolation is $D_{n,e}$, defined below. (See also BS EN 20140-10:1992)

$$D_{n,e} = L_1 - L_2 + \log_{10}(nA_0/A) \text{ (dB)} \quad (6)$$

- L_1 is the average sound pressure level in the source chamber (dB)
- L_2 is the average sound pressure level in the receiving chamber (dB)
- n is the number of specimens installed
- A_0 is the reference area = 10m²
- A is the equivalent absorption area in the receiving chamber (m²)

$$A = 0.16V/T \quad (7)$$

- V is the volume of the receiving chamber (m³)
- T is the reverberation time of the receiving chamber (seconds)

$D_{n,e,w}$ is a single figure, broad band value, weighted according to BS EN ISO 717.

It should be noted that $D_{n,e,w}$ values can be misleading in that, for example, a 6" x 6" hole with an R of 0dB would have a $D_{n,e}$ of 26dB.

The Weighted Sound Reduction Index is

$$R_w = D_{n,e,w} - 10 + 10\log(\text{area}) \quad (8)$$

In order to make meaningful comparisons between different products, Equation (8) has been used to estimate R_w based on published $D_{n,e,w}$ data.

Where manufacturers list octave band values for Transmission loss, the average from 125Hz to 4kHz is given and is taken to be of the same order as the R_w .

In the Americas, the standard unit is STC (Sound Transmission Class) as described ASTM E413. It is comparable to R_w so only R_w has been used in this report.

Table A.12: Sound Reduction Data for Devices for External Air Transfer

Ventilator	Example product	$D_{n,e,w}$ (C;Ctr)	R_w
Silencair	Silencair Window Vent (25 modules) or Wall Vent (10 modules)		26
	10-0001-01 Silencair 240 or Silencair Brickvent		25
Background ventilator	Passivent, Fresh 80	50	23
	Passivent, Fresh 90	45	19
	Passivent, Fresh 99H	42	15
	Greenwood AWW39 Acoustic Wall Ventilator	39(0;-2)	11
	Greenwood MA3051 Wall ventilator	55(-1; -3)	24
	Greenwood AAB Acoustic Airbrick	46(0;-2)	21
Acoustic Louvers	IAC Model R (12" deep)		(12)
Proprietary Lined Boot	Estimated range for boots between 1'10" long and 4' long		20-31
Monodraught Wind Catchers	GRP800, 25mm acoustic foam lining	26	<i>14*</i>
	GRO1000, 25mm acoustic foam lining	24	<i>14</i>
	GRO1000, 50mm acoustic foam lining	31	<i>21</i>

Numbers in italics have been estimated according to Equation (8).

Average Transmission loss from 125Hz to 4kHz values are given in parentheses.

*This is an increase of 11dB compared to the same model with no acoustic lining.

A.7.3 Airflow Performance

To compare the air flow performance through many devices with different sizes, the volume flow rate has been divided by the overall cross section area. This gives a measure of the volume flow rate per area of the wall taken up by the device. Depending on the geometry of the ventilator, it is not a true face velocity. It has been plotted for a variety of devices on Figure A.2.

Note that:

- Data given for example proprietary lined duct “boot” type attenuators represent the maximum and minimum values in the published ranges for many different sizes of silencer.
- Volume flow rates for different devices are quoted in different pressure drop ranges making comparison difficult.

A.8 Conclusions

International legacy acoustic standards for offices are roughly consistent, recommending 40dB L_{Aeq} to 50dB L_{Aeq} in open offices and 5dB to 10dB lower in cellular or executive offices. They generally assume that buildings are sealed and air conditioned and that the recommended noise limits are met by controlling the steady background noise from building systems.

This research indicates that the allowable level of noise break in to naturally ventilated buildings can be set higher than the building services noise criteria for sealed mechanically ventilated buildings. Although inconclusive, the preponderance of the work suggests that 55dB L_{Aeq} may be appropriate.

However, it is not clear that such a criterion would be universally acceptable. Frequency content, temporal variability and the presence of impulsive or tonal characteristics of the external noise environment must be considered. Regional and individual responses are likely to vary. The research is inconclusive partly because people seem to adapt to their noise environments.

Use of natural ventilation can lead to very low internal noise levels (since there is no, or reduced, mechanical systems noise) which can exacerbate privacy problems. Masking sound can help in these situations.

Based on a criterion of 55dB L_{Aeq} , natural ventilation by means of operable windows should be feasible in external noise environments up to 65dB to 70dB L_{Aeq} . This range of external noise environment may be increased to 67dB to 85dB L_{Aeq} by the use of acoustically attenuated air transfer strategies. Increasing the acoustic attenuation generally increases the pressure drop so achieving the maximum attenuation to allow natural ventilation at the upper end of this external noise range may not always be possible.

Figure A.2: Volume Flow Rate/Overall Cross Section Area Versus Pressure Drop

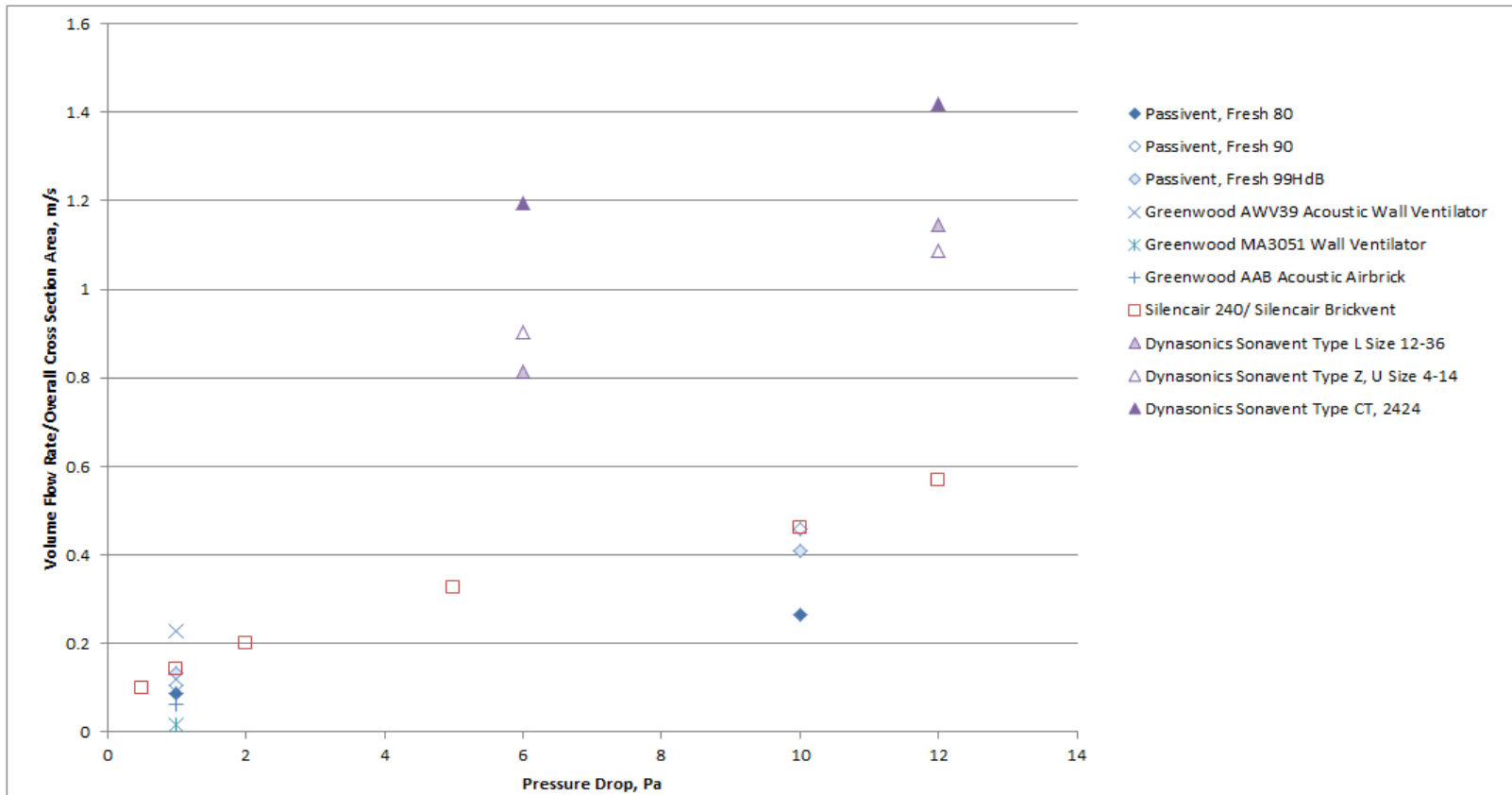

A.9 Directions for Further Work

- Carry out noise measurements in, and/or outside, many naturally ventilated, and mixed mode, office buildings for which there are existing Post Occupancy Survey data. Identify the level of external noise break in and not just the overall noise level. Since responses to noise appear to vary by region, focus on buildings in California.
- Instigate cooperative global research with acoustic consultants providing noise data from one or two naturally ventilated buildings and arranging subjective surveys to be carried out to build up an extensive database.
- Continue SoundLab investigations of the effects of external noise break-in, including a more comprehensive range of external noise sources, such as construction, freeway, aircraft and mechanical plant noise. Inclusion of typical occupational office noise in the simulations could also be considered.
- Consider the choice of noise index, or statistical noise descriptor, and the use of octave or third octave bands analysis, etc., to account for the frequency content, temporal variability and any impulsive or tonal characteristics of the external noise environment.

A.11 Acoustic Terminology

Ambient Noise Level

The overall noise level including all noise sources, near and far, associated with a given environment. In an office, this could include the mechanical systems noise, external noise breaking in from the exterior and occupational noise:

Mechanical Systems Noise

Noise generated by the operation of HVAC equipment. In an office space, this should be a steady background noise. See under “Statistical noise levels”.

External Noise

Noise generated by sources outside of the building under consideration. Perception within the building will depend on the reduction of noise achieved by the building envelope. The character and temporal variability of the noise will depend on the external noise sources.

Occupational Noise

Noise generated by activity within a building. Noise sources could include voices, footfalls, photocopiers, telephones etc. Occupational noise in a busy office will be time varying and generally louder than the mechanical systems noise.

Decibel (dB)

The ratio of sound pressures which we can hear is a ratio of $10^6:1$ (one million:one). For convenience, therefore, a logarithmic measurement scale is used. The resulting parameter is called the ‘sound pressure level’ (L_p) and the associated measurement unit is the decibel (dB). As the decibel is a logarithmic ratio, the laws of logarithmic addition and subtraction apply.

dBA

The unit used to define a weighted sound pressure level, which correlates well with the subjective response to sound. The ‘A’ weighting follows the frequency response of the human ear, which is less sensitive to low and very high frequencies than it is to those in the range 500Hz to 4kHz.

In some statistical descriptors the ‘A’ weighting forms part of a subscript, such as L_{A10} , L_{A90} , and L_{Aeq} for the ‘A’ weighted equivalent continuous noise level.

Equivalent Continuous Sound Level

An index for assessment for overall noise exposure is the equivalent continuous sound level, L_{eq} . This is a notional steady level which would, over a given period of time, deliver the same sound energy as the actual time-varying sound over the same period. Hence fluctuating levels can be described in terms of a single figure level.

Frequency

Frequency is the rate of repetition of a sound wave. The subjective equivalent in music is pitch. The unit of frequency is the hertz (Hz), which is identical to cycles per second. A 1000Hz is often denoted as 1kHz, e.g. 2kHz = 2000Hz. Human hearing ranges approximately from 20Hz to 20kHz. For design purposes the octave bands between 63Hz to 8kHz are generally used. The most commonly used frequency bands are octave bands, in which the mid frequency of each band is twice that of the band below it. For more detailed analysis, each octave band may be split into three one-third octave bands or in some cases, narrow frequency bands.

Noise Criteria (NC) Curves

Noise criteria (NC) curves were developed in the USA. The curves are commonly used to define building services noise limits. The NC value of a noise is obtained by plotting the octave band spectrum on the set of standard curves. The highest value curve which is reached by the spectrum is the NC value.

Sound Level Difference (D)

The sound insulation required between two spaces may be determined by the sound level difference needed between them. A single figure descriptor, the weighted sound level difference, D_w , is sometimes used (see BS EN ISO 717-1).

Sound Pressure Level

The sound power emitted by a source results in pressure fluctuations in the air, which are heard as sound.

The sound pressure level (L_p) is 10 times the logarithm to the base 10 of the ratio of the measured sound pressure (detected by a microphone) to the reference level of 2×10^{-5} Pa (the threshold of hearing).

Thus L_p (dB) = $10 \log_{10}(P_1/P_{ref})^2$ where P_{ref} , the lowest pressure detectable by the ear, is 0.00002 pascals (i.e. 2×10^{-5} Pa).

The threshold of hearing is 0dB, while the threshold of pain is approximately 120dB. Normal speech is approximately 60dBA or more and a change of 3dB is only just detectable. A change of 10dB is subjectively twice, or half, as loud.

Sound Reduction Index (R)

The sound reduction index (or transmission loss) of a building element is a measure of the loss of sound through the material, i.e. its attenuation properties. It is a property of the component, unlike the sound level difference which is affected by the common area between the rooms and the acoustic of the receiving room. The weighted sound reduction index, R_w , is a single figure description of sound reduction index which is defined in BS EN ISO 717-1: 1997. The R_w is calculated from measurements in an acoustic laboratory. Sound insulation ratings derived from site (which are invariably lower than the laboratory figures) are referred to as the R'_w ratings.

Statistical Noise Levels

For levels of noise that vary widely with time, for example road traffic noise, it is necessary to employ an index which allows for this variation. The L_{10} , the level exceeded for 10% of the time period under consideration, and can be used for the assessment of road traffic noise (note that L_{Aeq} is used in BS 8233 for assessing traffic noise). The L_{90} , the level exceeded for 90% of the time, has been adopted to represent the background noise level. The L_1 , the level exceeded for 1% of the time, is representative of the maximum levels recorded during the sample period. A-weighted statistical noise levels are denoted L_{A10} , dB etc. The reference time period, T, is normally included, e.g. dB $L_{A10, 5min}$ or dB $L_{A90, 8hr}$.

Typical Levels

Some typical dBA noise levels are given below:

Noise level (dBA)	Example
130	Threshold of pain
120	Jet aircraft take-off at 100m
110	Chain saw at 1m
100	Inside disco
90	Heavy lorries at 5m
80	Kerbside of busy street
70	Loud radio (in typical domestic room)
60	Office or restaurant
50	Domestic fan heater at 1m
40	Living room
30	Theatre
20	Remote countryside on still night
10	Sound insulated test chamber

A.12 Measurements

Table A.13: Measurement Details

Building	Dates and times	Measurement and analysis equipment
David Brower Center, Berkeley	Room acoustics were carried out between 7.30pm and 10pm on November 27, 2012.	Sound propagation based on ASTM E1130: Briel and Kjaer Sound Level Meter Type 2250. The calibration was checked before and after the measurements. Random incidence microphone correction and fast response. 4" powered loudspeaker with a pink noise signal.
	Internal and External noise measurements of were made between 9am and 11.15am on December 11, 2012.	Briel and Kjaer Sound Level Meter Type 2250. The calibration was checked before and after the measurements. Random incidence microphone correction and fast response.
Loisos + Ubbelohde, Alameda	Room acoustics were carried out between 3pm and 5pm on October 28, 2012.	Sound propagation based on ASTM E1130: Briel and Kjaer Sound Level Meter Type 2250. The calibration was checked before and after the measurements. 4" RCA Sound Tube SA020 Loudspeaker with a pink noise signal.
	A noise logger was left running in the office from 8.45am on October 29, 2012, until 10.30am on October 30, 2012.	Rion noise logger.
	Internal and external noise measurements of were made between 10.40am and 11am on October 30, 2012.	Briel and Kjaer Sound Level Meter Type 2250. The calibration was checked before and after the measurements.
560 Mission Street, Suite 700	Room acoustics measurements carried out between 9pm and 10pm on January 29, 2013.	Briel and Kjaer Sound Level Meter Type 2250. The calibration was checked before and after the measurements. 4" powered loudspeaker with a pink noise signal.

Table A.14: Measured Noise Levels at the Brower Center

Measurement			Measured Noise Level dBA						NC	Notes
Location/Suite #	Windows	Duration (m:ss)	L _{eq}	L _{max}	L ₁	L ₁₀	L ₉₀	L _{min}		
Oxford St sidewalk, 4' façade	n/a – exterior	5:06	68	89	76	71	59	52	64	Autos 70-73dBA, scooter 76dBA, footsteps.
460 Private Off. 1	One open	8:45	58	73	72	53	42	38	56	Auto traffic dominant 50-52dBA. High pitch phone ring 72dBA. Lower pitch phone ring 71dBA. Tonal gardening equipment 48dBA to 52dBA. Background 39-40dBA. Door slams 56dBA.
460 Private Off. 1	One open	3:06	50	68	56	52	43	39	45	
460 Private Off. 2	Two open	7:03	53	68	59	55	46	42	49	Road traffic dominant 53-58dBA. Background 55dBA. Conversation 48-49dBA. Gardening equipment. Occ. low frequency engine noise (bus or truck). Car horn.
460 Private Off. 2	Two open	4:02	55	64	63	58	48	43	51	Autos (up to 62dBA)
460 Conf. Room	Open	5:13	52	65	61	55	48	46	48	Trucks 53-59dBA. Motorbike 62dBA. Typ. auto traffic 50-56dBA. Activity in adjacent workroom 50-55dBA.
460 Conf. Room	Open	3:08	51	67	61	53	47	46	46	Loudest sound was a voice.
400 Lounge area	Two open	5:02	48	60	54	51	43	40	43	Autos 45-50dBA.
460 Private Off. 1	Closed	5:04	42	67	50	43	35	32	36	Background 35dBA. Voices 38-49dBA.
460 Private Off. 2	Closed	5:12	47	68	58	47	37	34	42	Voices 43-53dBA. Doors closing 57dBA. Printer 44dBA. Background 36dBA.
460 Conf. Room	Closed	2:04	47	60	56	50	43	42	42	Voices and washing up in adjacent work room.
460 Conf. Room	Closed	4:03	41	55	49	44	34	33	35	Door to workroom closed. Traffic audible but not obvious. Background 35dBA. Truck 50dBA.
460 Open office	None	5:05	49	75	58	48	39	36	44	Voices 40-55dBA, including phone conversations. Vehicle accelerating 51dBA. Background 38dBA. Keyboard noise, traffic thru' open windows in private office.

Figure A.3: Frequency Distribution of Noise Measured at the Brower Center

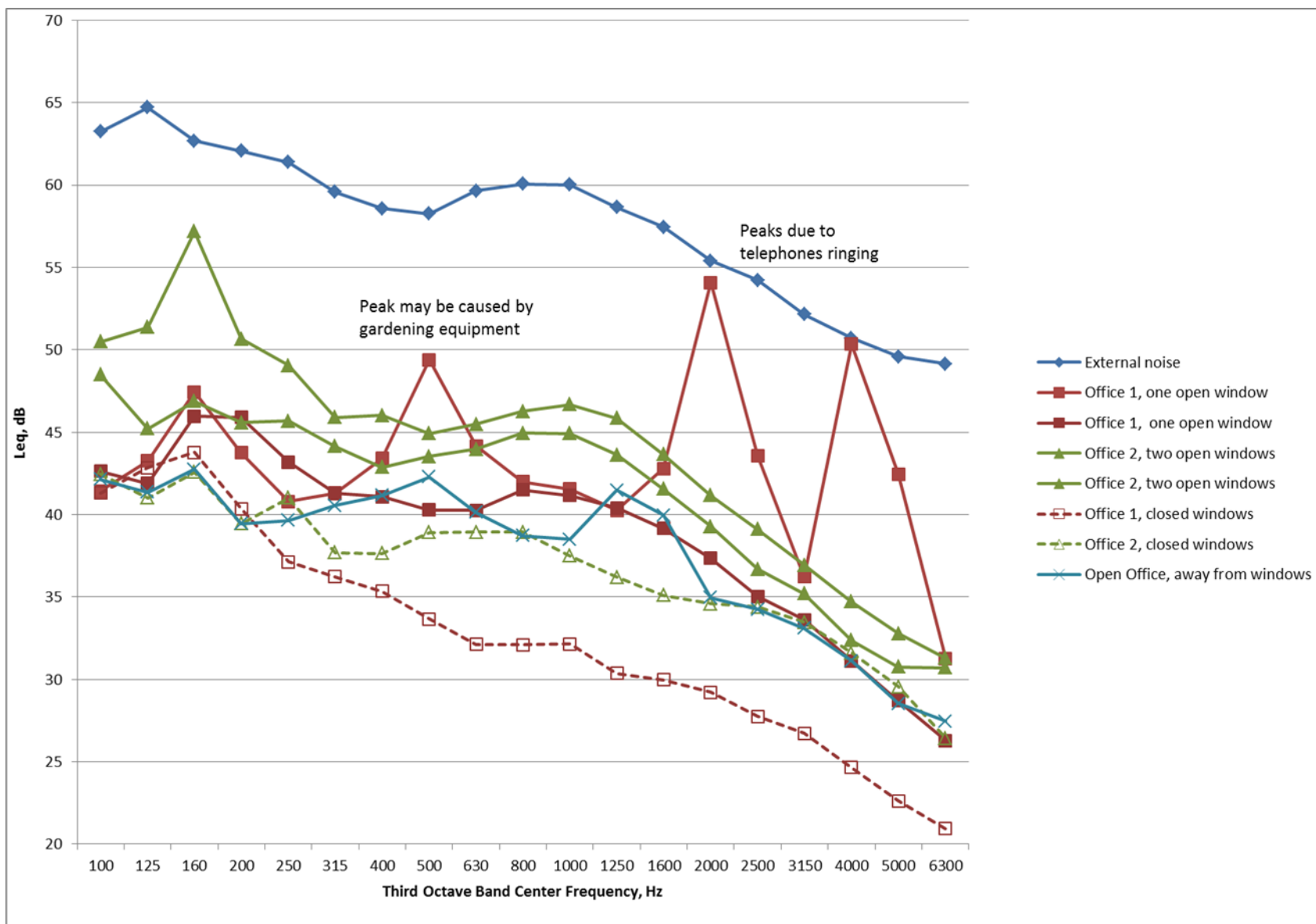
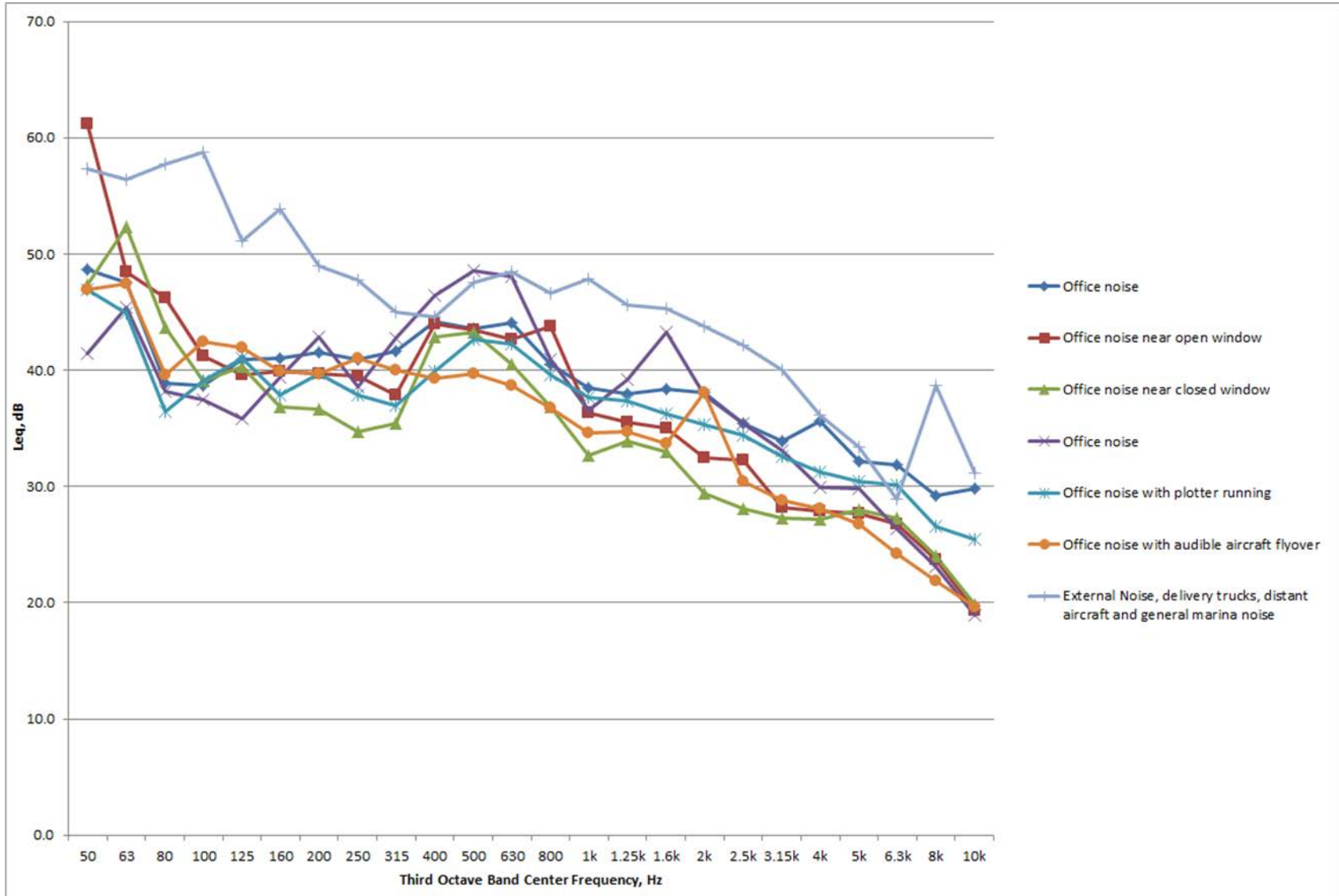

Table A.15: Measured Noise Levels at Loisos + Ubbelohde

Measurement			Measured Noise Level dBA						Notes
Location	Windows	Duration (m:s)	L _{eq}	L _{max}	L ₁	L ₁₀	L ₉₀	L _{min}	
Room 1		1:00	50	69	55	52	45	42	People talking and plotters/copiers. External noise was not a subjectively significant contributor to the ambient noise in the office.
Room 1, close to window	Open	0:31	49	63	58	51	44	42	
Room 1, close to window	Closed	0:30	46	55	54	50	41	40	
Room 2		1:00	52	67	64	55	38	34	
Room 1		1:00	49	65	59	51	41	39	Plotter running.
Room 1		1:00	46	55	54	50	40	39	Aircraft flyover audible.
Just outside door		3:00	56	72	64	59	51	48	Delivery trucks, distant airplanes, general marina noise.
Room 1		Logged through working day	46	68	55	47	37	34	Average of all the continuous 15 minute measurements made between 9am and 6pm.

Figure A.4: Frequency Distribution of Noise Measured at Loisos + Ubbelohde



APPENDIX A REFERENCES

- ASHRAE (2011) 2011 ASHRAE handbook: heating, ventilating, and air-conditioning applications.
- Bauman, F., Webster, T., Dickerhoff, D., Schiavon, S., Feng, D. and C. Basu (2011) Case study report: David Brower Center. Internal Report, Center for the Built Environment, University of California, Berkeley, April 2011.
- Beranek, L.L. (ed.) (1971) Noise and vibration control. McGraw Hill.
- Bies, D.A. and C.H. Hansen (1996) Engineering noise control: theory and practice. 2nd edition. E. & F.N. Spon. 615pp.
- British Standards Institution (1999) Sound insulation and noise reduction for buildings. Code of practice. BS 8233:1999
- Building Research Establishment (1974) Traffic noise and overheating in offices. BRE Digest 162.
- Butera, F. and K. Hewett (2012) Acoustic performance of louvred facades for Brisbane domestic airport. An integrated approach. In Proceedings of INTER-NOISE 2012, New York City, August 19-22, 2012, pp. 577-582 (Paper No. NCAD2012-1393).
- CIBSE (1986) CIBSE Guide A: Environmental design. 1986 edition. Chartered Institution of Building Services Engineers.
- CIBSE (1999) CIBSE Guide A: Environmental design. 1999 edition. Chartered Institution of Building Services Engineers.
- CIBSE (2007) CIBSE Guide A: Environmental design. 7th edition (Issue 2). Chartered Institution of Building Services Engineers.
- Dubiel, J., Wilson, M. and F. Nicol (1996) Decibels and discomfort – an investigation of noise tolerance in offices. In Proceedings of the CIBSE/ASHRAE joint national conference, Harrogate, UK, 29 September – 1 October 1996, Vol. 2, pp. 184-191.
- Field, C. (2008) Acoustic design in green buildings. ASHRAE Journal **50(9)**, 60-70.
- Field, C.D. and J. Digerness (2008) Acoustic design criteria for naturally ventilated buildings. In Proceedings of Acoustics '08, Paris, June 29-July 4, 2008, pp. 5375-5379.
- Ford, R.D. and G. Kerry (1973) The sound insulation of partially open double glazing. Applied Acoustics **6(1)**, 57-72.
- General Services Administration (2012) Sound matters: how to achieve comfort in the contemporary office. GSA Public Buildings Service, January 2012.
- Ghiaus, C. and F. Allard (eds.) (2005) Natural ventilation in the urban environment: assessment and design. Earthscan

- Goins, J., Chun, C. and H. Zhang (2012) User perspectives on outdoor noise in buildings with operable windows. In Proceedings of International Conference, The changing context of comfort in an unpredictable world, Cumberland Lodge, Windsor Great Park, UK, 12-15 April 2012. Network for Comfort and Energy Use in Buildings.
- Jensen, K.L., Arens, E. and L. Zagreus (2005) Acoustical quality in office workstations as assessed by occupancy surveys. In Proceedings of Indoor Air 2005, Beijing, China, September 4-9, 2005, pp. 2401-2405
- Kerry, G. and R.D. Ford (1974) The field performance of partially open dual glazing. *Applied Acoustics* **7(3)**, 213-227.
- Kryter, K.D. (1985) *The effects of noise on man*. 2nd edition. Academic Press. 688pp.
- McCartney, K.J. and J.F. Nicol (2002) Developing an adaptive control algorithm for Europe. *Energy and Buildings*, **34(6)**, 623-635.
- Nicol, F. and M. Wilson (2004) The effect of street dimensions and traffic density on the noise level and natural ventilation potential in urban canyons. *Energy and Buildings* **36(5)**, 423-434.
- Passchier-Vermeer, W. (1993) *Noise and health*. The Hague: Health Council of the Netherlands; publication no. A93/02E.
- Ryan, M., Lanchester, M. and S. Pugh (2011) Noise reduction through facades with open windows. In Proceedings of Acoustics 2011, Gold Coast, Australia, 2-4 November 2011, Paper No. 37.
- Sailer, U. and M. Hassenzahl (2000) Assessing noise annoyance: an improvement-oriented approach. *Ergonomics* **43(11)**, 1920-1938.
- Saunders, A.G. (1989) Noise criteria in the modern office development: How do these compare with BS 8233:1987. *Proceedings of the Institute of Acoustics* **11(11)**, 53-64.
- Standards Australia and Standards New Zealand (2000) *Australian/New Zealand Standard: Acoustics – recommended design sound levels and reverberation times for building interiors*. AS/NZS 2107:2000.
- US Department of Transportation (2013) *Minimum sound requirements for hybrid and electric vehicles: Draft environmental assessment*. National Highway Traffic Safety Administration. Docket No. NHTSA-2011-0100, January 2013.
- Waters-Fuller, T. and D. Lurcock (2007) *Sound insulation through ventilated domestic windows*. Final Report for DEFRA project NANR 116, "Open and closed window research".
- Wilson, M. (1992) A review of acoustic problems in passive solar design. In Proceedings of EuroNoise '92, Imperial College, London, 14-18 September 1999, pp. 901-908.

Wilson, M., Nicol, F. and R. Singh (1993) Measurements of background noise levels in naturally ventilated buildings, associated with thermal comfort studies: Initial results. Proceedings of Institute of Acoustics **15(8)**, 283-295.

APPENDIX B: Barriers to Implementation: Fire

B.1 Project Summary

In recent years, there has been a growing incentive for building designers to incorporate natural ventilation into their projects. Naturally ventilated buildings can be more energy efficient, have smaller carbon footprints, greater perceived occupant comfort, and can minimize issues such as sick building syndrome (Emmerich *et al.*, 2001). Energy savings can be passed onto tenants and users. Owners can also use natural ventilation for LEED credits. However, current building fire safety code language does not adequately consider an engineered approach for natural ventilation relative to fire/life safety. The prescriptive code requirements often conflict with the needs of naturally ventilated buildings.

Studies have found that energy-saving measures such as natural ventilation methods can reduce energy consumption by almost 80%. Commercial buildings use 37% of the energy produced for California and are responsible for nearly 1M tons of CO₂ emissions, so a reduction would cut substantial costs while providing a positive environmental impact (Coffey *et al.*, 2009). Coastal areas in particular are ideally suited for taking advantage of naturally ventilated buildings in California. Moderate temperatures and nearly constant breezes from offshore winds provide an ideal climate.

There are several challenges to implementing natural ventilation in new and existing buildings. New construction faces stringent regulations regarding modern considerations for health and life safety. Most existing buildings have been designed based on sealed building concepts which oppose airflow through the façade to the interior portions. For old and new buildings, the benefits of natural ventilation need to be realized in an economical manner while maintaining the level of safety that is expected in modern design.

California is one of few state governing bodies in the United States which includes “occupant life safety” smoke control provisions among its fire safety regulations. These smoke control provisions, and their potential for inconsistent interpretation, can be a significant barrier to implementing natural ventilation strategies in high rise and atrium buildings

In the regulations for safety provisions in high rise structures, Section 403.4 of the State Building Code deviates from the model IBC provisions by instead requiring “...a passive or active smoke control system or combination thereof in accordance with Section 909” (CBSC, 2010). CBC Section 909.1 states that the objective of a smoke control system is to “provide tenable conditions for the evacuation or relocation of occupants.” Although this section presents a format from which a building’s fire protection systems might be properly engineered, application and interpretation of the requirements of this code section is subject to the approval of the local authorities.

The benefits of using a smoke control system in a sealed building are easily recognized. Since a natural path for smoke removal is not readily available, mechanical ventilation is used for

mitigation. Using a smoke control system to create pressure differences across barriers or to prevent smoke migration through permanent openings, a designer does not have to consider much loss of airflow to the exterior for natural ventilation. The evacuation of occupants is protected by the system of pressurized barriers, while the floors themselves are not subject to the overpressures that drive smoke to other floors. With additional safety measures, such as fire and smoke barriers and automatic sprinkler systems, the model code provides a multifaceted approach to aid in protection of occupants.

It is recommended that Section 909 of the California Building Code change to the nationally accepted IBC smoke control provisions based on background research, empirical data, and modeling. This change would not be detrimental to the safety of occupants, but instead would require an engineering analysis to determine tenability based on language currently found in the model code.

B.1.1 Tasks

- Evaluate codes and standards that present barriers to the design and construction of new naturally ventilated building can still meet the life safety intent of the buildings or conversion of existing buildings to naturally ventilated buildings during a renovation process.
- Identify regulatory or technical barriers in new buildings.
- Identify regulatory or technical barriers in existing buildings for retrofit.
- Model typical high-rise structures to investigate performance differences between mechanical, naturally ventilated and hybrid systems consisting of a combination of mechanical and natural ventilation. This effort aims to inform potential solutions or guidance for the development of code.
- Examine the barriers to natural venting of typical mall or atrium buildings.

B.1.2 Deliverables

Prepare a natural ventilation code language report, for new and retrofit buildings and propose fire code language that addresses the barriers to naturally ventilated atria, malls, and high-rise structures.

B.2 Background Studies

Reports and experimental data show that natural ventilation may be quantitatively examined to determine effectiveness during a fire. However, little guidance is available to building stakeholders and authorities having jurisdiction (AHJs) to incorporate fire preparedness into the design process. The AHJs may include federal, state, or local building and fire authorities or any other governing body that has a stake in the design and construction of buildings.

Stakeholder viewpoints that need to be considered during the design process include building owners, insurance companies, and the eventual occupants of the building. Each will have their own set of goals for the smoke system, and their input should be considered as well. Guidance

from new studies along with the advancement of computational fluid dynamics may reveal sound engineering principles that stakeholders and AHJs can use to implement natural ventilation without compromising life safety goals.

The origin of present smoke control techniques may be found in testing and experiments from the early 1970s. A commonly referenced study that precipitated code development was conducted by the Brooklyn Polytechnic Institute in 1972 in a high-rise office building (DeCicco *et al.*, 1972). Commissioned by the New York City Fire Department, this was one of the first large-scale studies of the effectiveness of stair pressurization systems. In their report, the authors concede that varying fire protection systems, building geometries and mechanical systems should be considered when developing guidance for design.

Full-scale fire tests performed at the Plaza Hotel in Washington, D.C. in 1989 showed promise in the use of open windows during a fire event, but the evidence of this is limited to only one test. In that case, the building was not protected by automatic fire sprinklers and the mechanical ventilation system failed during the test, yet smoke did not move outside of the compartment of origin during the sprinklered test with a fire twice as large as any other in the study (Klote, 1990).

Smoke control measures for stairs and elevators were also considered as part of the overall tenability strategy for both occupant egress and emergency responders. In the 1980 MGM Grand fire in Las Vegas, most of the occupants succumbed to smoke inhalation in an area several stories above the fire due to the movement of smoke up the elevator shaft (Best & Demers, 1982). While stair systems are widely used as part of an overall egress strategy, it is noted that elevator smoke control is much more difficult to design and implement (Stroup, 2003). Reported issues include high leakage areas to the exterior, inability for stair and elevator doors to close, and a negative impact on the stairwell smoke control system (Miller & Beasley, 2008; Klote, 1984).

Today's calculation methods for smoke transport in tall buildings are based on much of the work performed in the 1960s by Tamura, Wilson, McGuire, and others (Tamura, 1970; Wakamatsu, 1968; Tamura & Wilson, 1967; McGuire, 1967). Further research and empirical correlations for use in smoke transport were developed by Quintiere, Heskestad, Klote, Milke and others (Klote, 1984; Klote & Milke, 1992) that were able to take advantage of developing interest and research funding as well as advances in computer programming and technology. These ideas and equations were incorporated into modern codes and standards such as NFPA 72 and 92 as well as the IBC (NFPA, 2007b & 2006; ICC, Inc., 2009).

B.3 Code Review

B.3.1 Approach

Some fire safety requirements found in the California Building and Fire Codes (CBC, CFC) can be potential barriers to the wide spread promulgation of naturally ventilated building design in the state. Three classes of buildings: high rises, atrium and mall buildings are required in California to be provided with smoke control systems in accordance with Section 909 of the CBC which is based on the International Building Code (IBC) with California State Fire

Marshall (CSFM) amendments. The code-required smoke control systems primarily depend on mechanical ventilation and pressurization to fulfill the goals of the smoke control systems set by the CBC.

Building code requirements for smoke control were originally based on engineering judgment and evolved as experience and testing progressed. However, options for naturally ventilated systems are not adequately addressed regarding feasibility, and lack of criteria for design and installation in the prescriptive codes prevents building owners from pursuing more energy efficient designs. By incorporating experimental data with the development of network and CFD modeling, the intent of the current codes can be met or exceeded by alternative means. Therefore, allowances for a performance-based solution should be made for these situations.

Reports and experimental data have shown that natural, passive, and hybrid ventilation may be quantitatively examined to determine effectiveness on tenability. Nevertheless, little guidance is available to building designers and authorities having jurisdiction (AHJs) to incorporate these approaches into the design process. The AHJs may include federal, state, or local building and fire authorities, insurance inspectors, or any other governing body that has a stake in the design and construction of buildings.

Table B.1 summarizes the current prescriptive code requirements.

B.3.2 Barriers to Natural Ventilation in New Buildings

The modern prescriptive smoke control method for high-rise buildings is the pressurization approach outlined in the Section 909 of the California Building Code (CBC, see CBSC, 2010). This utilizes the concept of a “pressure sandwich” created above and below the fire event floor in order to prevent the spread of smoke. When a building is opened to the environment by means of operable windows or other opening on the façade, the pressurization approach might not be feasible. Using supervised windows with motorized closers is usually cost prohibitive to accomplish the required pressure differentials. Further, other prescriptive elements such as pressurized stairwells might be affected by a reduction or elimination of mechanical ventilation (Bowers *et al.*, 2010).

Table B.1: 2009 IBC and 2010 CBC Amendments for High Rise Smoke Control Requirements

<p style="text-align: center;">2009 IBC (ICC, Inc., 2009)</p>	<p style="text-align: center;">2010 CBC Amendment (CBSC, 2010)</p>
<p>403.4.6 Smoke removal. To facilitate smoke removal in post-fire salvage and overhaul operations, buildings and structures shall be equipped with natural or mechanical ventilation for removal of products of combustion in accordance with one of the following:</p> <ol style="list-style-type: none"> 1. Easily identifiable, manually operable windows or panels shall be distributed around the perimeter of each floor at not more than 50-foot (15 240 mm) intervals. The area of operable windows or panels shall not be less than 40 square feet (3.7 m²) per 50 linear feet (15 240 mm) of perimeter. <p>Exceptions:</p> <ol style="list-style-type: none"> 1. In Group R-1 occupancies, each sleeping unit or suite having an exterior wall shall be permitted to be provided with 2 square feet (0.19 m²) of venting area in lieu of the area specified in Item 1. 2. Windows shall be permitted to be fixed provided that glazing can be cleared by fire fighters. <ol style="list-style-type: none"> 2. Mechanical air-handling equipment providing one exhaust air change every 15 minutes for the area involved. Return and exhaust air shall be moved directly to the outside without recirculation to other portions of the building. 3. Any other approved design that will produce equivalent results. 	<p>403.4.6 Smoke control.</p> <p>403.4.6.1 Smoke control system. High-rise buildings shall be provided with a passive or active smoke control system or combination thereof in accordance with Section 909.</p>

Several portions of the California Building Code allow for a performance-based approach to smoke control. Section 909.6.1 allows, for buildings that are not required to be fully sprinklered, an engineered approach to achieve pressure differences of 12.5Pa or calculated to twice the pressure effects of the design fire. However, in a naturally ventilated building, there may be little or no pressure effects when windows or doors are open.

Section 909.9 lists those aspects that need to be considered, including dynamics of the design fire, its location, and effectiveness of sprinklers. Section 909.4 requires a rational analysis to include stack effect, temperature effect of fire (through convective heat transfer), HVAC system considerations, climate effects (high and low temperatures, wind) and allows for a performance-based approach for the duration of operation, generally 20minutes or 1.5 times calculated egress times as specified in 909.4.6.

CBC 909.6 requires an engineered approach to the pressurization method based on the criteria in 909.9. Minimum design pressure differences across smoke barriers for use of this method are based on NFPA 92A, Section 5.2. In a sprinklered building, a pressure difference of 12.5 Pa is specified. This pressure difference is to be maintained under specified conditions of stack effect and wind and was developed based on full scale room fire experiments. The method for

determination of the design pressure difference is given in NFPA 92A, Section A.5.2.1, (NFPA, 2006).

B.3.3 Barriers to Natural Ventilation in Existing Buildings

In the California Existing Building Code (CEBC), buildings may utilize performance or prescriptive means for evaluating the level of life safety afforded to occupants. Smoke control is listed in Section 1301 as part of a performance-based evaluation of the building, but there are no requirements for smoke control beyond what is provided in Section 909 (CEBC, 2010). In the analysis provided, smoke control is treated as part of a holistic fire protection approach, and natural ventilation is recognized as a portion of that methodology. A key element to modifications or alterations to existing buildings is that they cannot become less safe than the existing condition per CEBC Section 601.2.

The CEBC categorizes alterations into three groups based on the amount of building space that will be modified. Level 2 and 3 alterations most nearly match those of modifying a building for natural ventilation, as those levels include work to be done on windows and doors.

Requirements for this level of change are similar to many of those found in the CBC for new structures, including required modifications for sprinklers, means of egress, and fire-resistance ratings for occupancies. However, the code does not provide guidance for existing smoke control systems, nor does it require the addition of such systems if they are not already present.

B.4 Case Studies

Two case studies were developed to address the intent of the building codes with a performance-based examination of model buildings. The building types, one tall “office building” and one “atrium/mall” were built to simulate and study the effects of fire, and, in turn, determine the extent to which we may reliably model such phenomenon. The methodology used presents one approach to a performance-based analysis for naturally ventilated scenarios.

B.4.1 Model Assumptions

Simplified atrium and high rises were chosen for model geometry. This consideration was based on architecture of buildings constructed during the 1960-1980's, which were primarily designed around a sealed façade design and relatively simple geometries. These buildings would comprise the best candidates for remodeling using a natural ventilation system.

Due to more complex designs present in modern buildings, it was not feasible to provide guidance for specific designs. Instead, the models and the input files were developed in order to provide a basic model setup and geometry with which to build upon. Existing buildings with similar geometries should also be modeled as closely as possible to actual design. Output data for future modeling of complex building designs may be extrapolated from the results found in this study for use in comparison with similar geometries.

Radiative effects of the fire were not considered in this study. It was assumed that, in both structures, the governing method of smoke transport was the convective portion of the heat released from the fire. Further, radiation takes approximately 20% of the computational time,

and the slight increase in accuracy was not considered enough to warrant the computational cost.

A few assumptions are kept constant during the modeling evolutions in order to isolate the dependent variables of interest. The temperature difference between the inside and outside of the buildings is set to a winter condition of 6.7°C (20°F) in order to induce the greatest stack effect that transports smoke upwards through leakage paths. The fire is considered sprinkler controlled, and a waterflow alarm the primary means of occupant notification for egress purposes. Interior compartmentalization is minimal, as might be expected to take advantage of cross flow of air to aid in passive cooling.

It was also assumed that the building would have pressurized smokeproof exit enclosures, so occupants would be able to depend on the staircase for evacuation and first responders would be afforded protection during their operations. However, the elevator shaft was not pressurized, as it was left so in order to examine possible smoke transport to other floors via stack effect.

B.4.1.1 Sprinklers

The fire was assumed to be located in the middle of four sprinklers to provide the most conservative activation times. The fire was explicitly modeled to stop growing upon sprinkler activation in accordance with CBC Section 909.9.4. The sprinkler inputs were modeled after those required by NFPA 13 for Light Hazard occupancies per Table 8.6.2.2.1(a) (NFPA, 2007a). The ceilings were assumed to be noncombustible and unobstructed.

Table B.2: NFPA 13 Sprinkler Spacing (NFPA, 2007a, Table 8.6.2.2.1(a))

Construction type	System type	Protection area		Maximum spacing	
		ft ²	m ²	ft ²	m ²
Noncombustible unobstructed	Hydraulically calculated	225	20.9	15	4.6

Sprinklers inputs for FDS were based on NFPA 13 requirements for Light Hazard occupancies, and are shown in Table B.3.

Table B.3: Sprinkler Inputs for FDS

Property	Value
RTI	50 (m/s) ^{1/2}
Activation temperature	70.0 °C
Flow rate	98.4 l/min
K-factor	10 (l/min)/atm ^{1/2}
Limiting O ₂ index	15%

B.4.1.2 Design Fire

Many fire protection engineers base design fires on the t-squared method developed by Heskestad as a generally acceptable approach to describe fire growth for fires that do not involve flammable liquids (DiNenno *et al.*, 2008). This fire growth is not explicitly specified in the CBC, but is inferred when designers are referenced to NFPA 92A for smoke control which recommends t-squared growth (NFPA, 2006). Further, both the CBC and the California Mechanical Code (CMC) recommend detection design per NFPA 72, which also utilizes this method to predict fire growth (CBSC, 2010; NFPA, 2007b).

The design fires for the simulations followed a fast-growing t-squared fire that would best simulate a combination of materials normally found in kiosks and office cubicles. The materials modeled into the equation included natural fibers and man-made material, which consisting of 25% each of wood, polyethylene (PE), polypropylene (PP), and PMMA as shown in Table B.4. The composition and assumptions for each substance were quantified, and then adjusted to simplify the stoichiometric properties of the resultants (DiNenno *et al.*, 2008). This fire was used as an exemplary fire throughout each model evolution. This was done to keep the smoke production consistent in order to more easily compare the model results.

Table B.4: Design Fire Parameters

Constituents	Mass* (%)	Fuel m/w (g/mol)	Density (kg/m ³)	C	H	O	Soot yield (g/g)	ΔH _c (kJ/kg)
Wood (assumed)	25.0%	87.00	500.00	3.40	6.20	2.50	0.02	12,400
Polyethylene (PE)	25.0%	28.03	1000.00	2.00	4.00	0.00	0.06	38,400
Polypropylene (PP)	25.0%	42.04	800.00	3.00	6.00	0.00	0.06	38,600
PMMA	25.0%	20.00	1190.00	1.00	1.60	0.40	0.02	24,200
Average	100%	44.34	872.50	2.35	4.46	0.73	0.039	28,400
Assumed	100%	44.34	872.50	2.5	4.5	0.75	0.039	29,000

*Average and Assumed values for Mass(%) are totals and not average values.

The design fire was modeled as a fast-growing t-squared fire that would attain a size of 1MW in 147s and then level off as seen in Figure B.1. The fire was considered controlled at the time of sprinkler activation in the models. In initial runs, this was found to be limited to approximately 141.8-152.1s after the fire ignites. The fire was later started approximately 30s into the model run in order to allow the model to resolve initial boundary conditions and essentially “settle” with respect to airflows between the building and the surroundings. This would also aid in assuming an incubation time for the fire where it might be assumed that a delayed growth of the fire in the presence of an ignition source is probable.

Figure B.1: Design Fire T-Squared Fire Growth

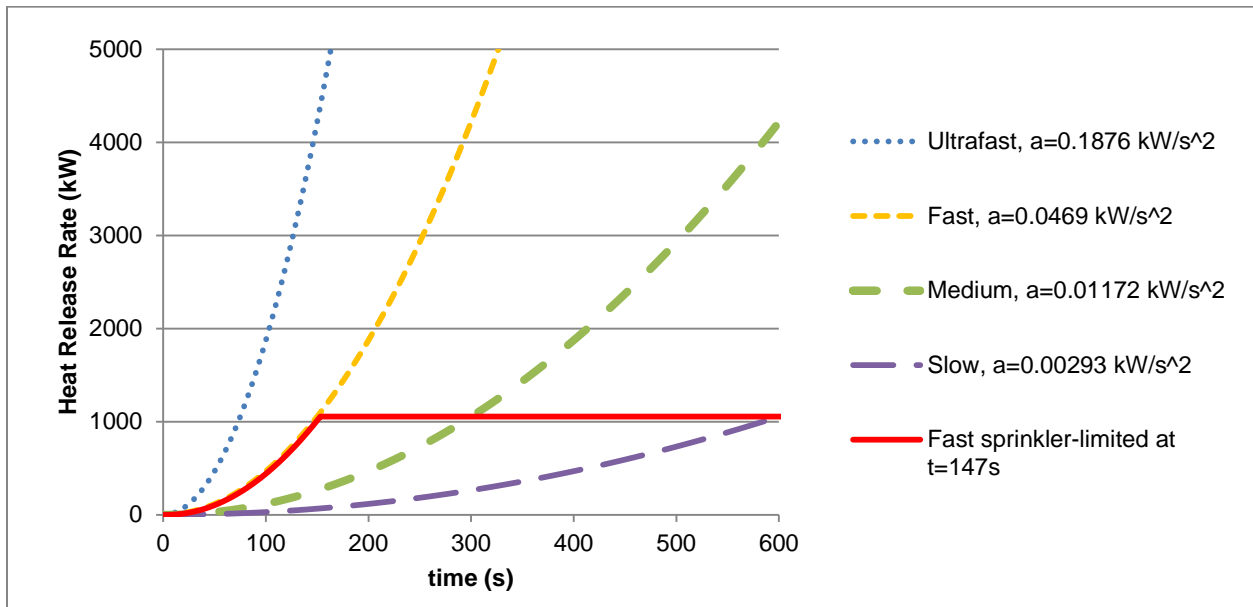

B.4.1.3 Atrium

The model assumed an atrium that is 12m wide and 40m long, with 2m wide walkways for on either side. The building itself was 30m wide. Each level is 4m high and comprised of 8 separate “occupancies” that were serviced by the walkways. Atrium heights from 15m with 3 stories up to 45m with 9 stories were examined. Figure B.2 shows the post-processed model with dimensions.

Figure B.2: Mall/atria, General Plan View

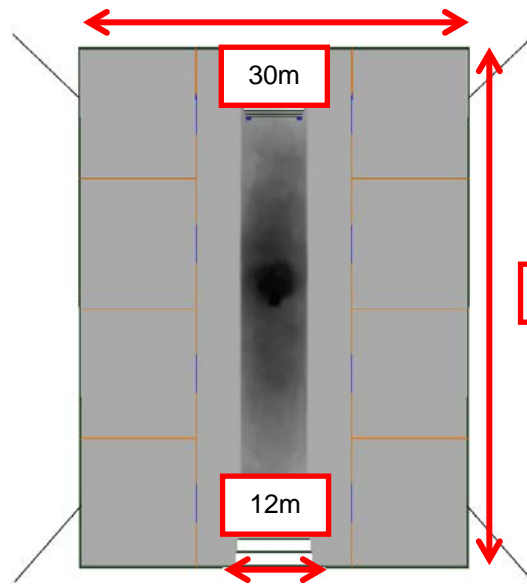
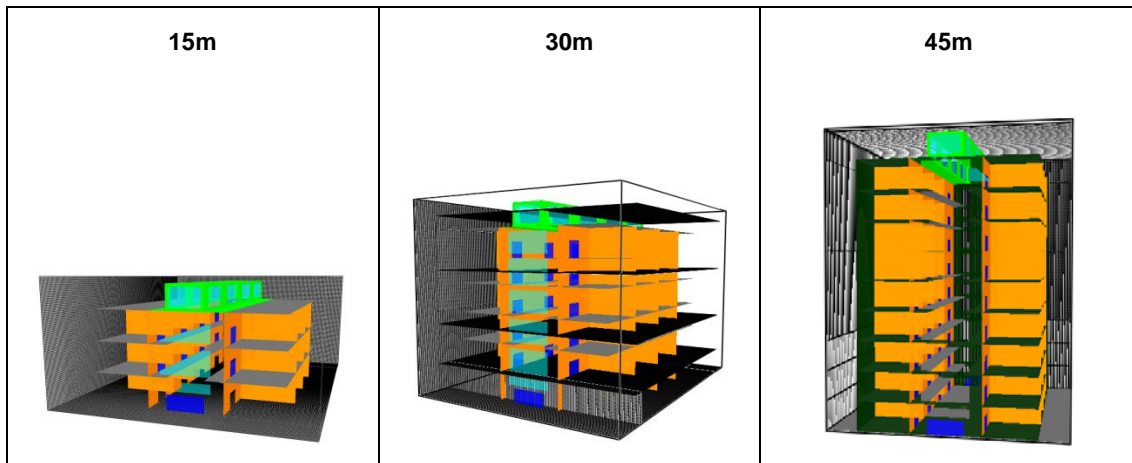
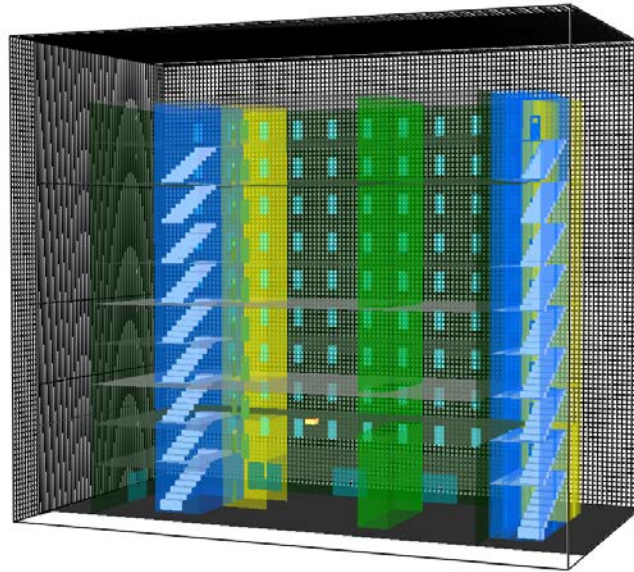

Figure B.3: Mall/Atria, Computational Domains



B.4.1.4 High rise

Figure B.4: High Rise, Perspective View



The high rise was modeled after a typical office building with offices on floors 2-10. Most floors were 20m x 40m x 4m with one interior and external stair, with the exception of the ground floor which was 5m high. It was assumed that stairway pressurization would be required in this building to provide occupants with a smokeproof enclosure which would normally be required. It was assumed that, due to the pressurization for stairs and vestibules, those egress paths would not be involved in transport of smoke to other areas. These were represented by a full obstruction which did not allow for smoke to enter into them.

The elevator shaft allowed for two elevators and was not pressurized. Although this is normally required in lieu of elevator lobbies to prevent stack effect from moving smoke to areas outside the zone of origin, this was not modeled in order to show possible effects of stack effect under varying temperatures. Further, meeting code requirements for elevator pressurization systems is difficult from a modeling standpoint (Bowers *et al.*, 2010). It was assumed that this consideration would lead to more conservative estimates of smoke transport in the high rise.

Figure B.5: High Rise, Elevation View

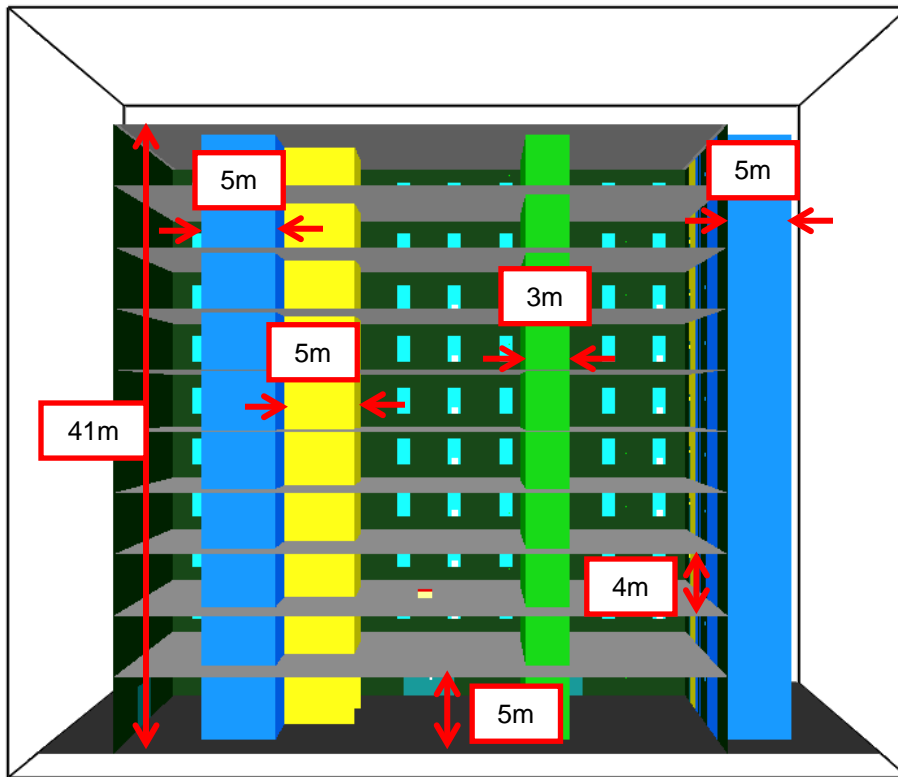
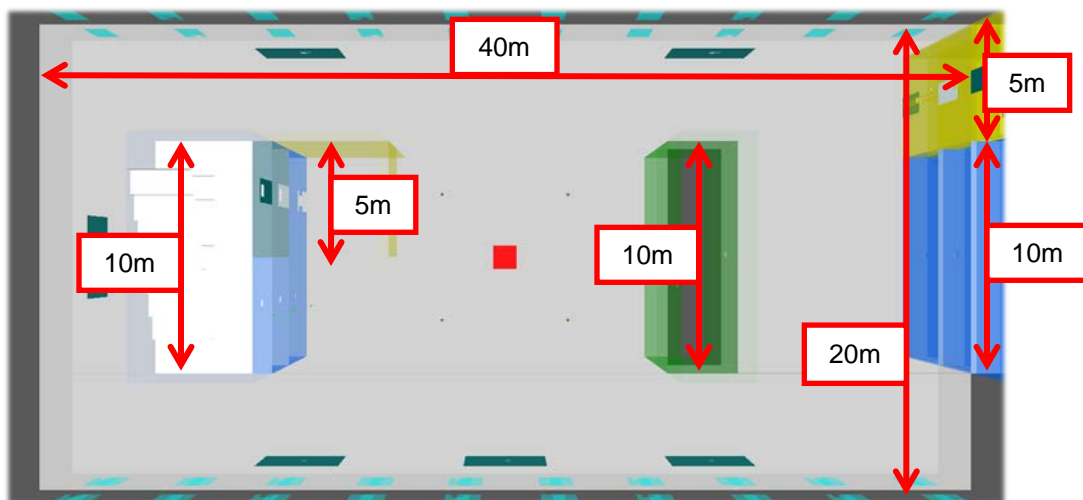

Figure B.6: High Rise, Plan View



B.4.2 Software Overview

Fire Dynamics Simulator (FDS) version 5.5.3, a program developed the National Institute of Standards and Technology (NIST), was used to model smoke movement. FDS uses a large eddy simulation (LES) model to solve low-speed Navier-Stokes equations for thermally driven flows (McGrattan *et al.*, 2010a). It has the capability to solve governing equations for fluid dynamics, combustion, and heat radiation transport in order to determine the effects of fire under several boundary conditions. Although FDS can be computationally expensive depending on the degree of accuracy desired, it was chosen because it is freely available and generally accepted for smoke modeling by many AHJs.

B.4.2.1 Sensitivity Analysis

A sensitivity analysis for the high rise and atrium models was conducted to determine the best balance of accuracy and computational time. While a finer mesh was used in some models to ensure results were not overly skewed, due to the size of the model's domain, a more coarse option was generally pursued as computational time exponentially increases with computational precision. Under certain conditions or analyses it may be recommended to use finer grid sizes to capture more detailed results.

The United States Nuclear Regulatory Commission (USNRC) and the Electric Power Research Institute (EPRI) performed a series of sensitivity analyses (USNRC & EPRI, 2007) and recommended a ratio D^*/dx of the fire characteristic diameter, D^* , to the nominal cell size of the computational domain, dx , to aid with determining mesh coarseness on a scale of 4 to 16, with 4 being most coarse and 16 the finest grid required to accurately resolve plume dynamics.

Table B.5: Cell Sizes Based on NUREG Study (USNRC & EPRI, 2007)

D^*/dx	2	4	6	8	10
dx (m)	0.479	0.240	0.160	0.120	0.096

The fire characteristic diameter D^* is given by the following equation:

$$D^* = \left(\frac{\dot{Q}}{\rho_{\infty} c_p T_{\infty} \sqrt{g}} \right)^{2/5}$$

where

\dot{Q} = fire heat release rate (1000 kW)

ρ_{∞} = density of ambient air (1.20 kg/m³)

c_p = specific heat capacity of air (1.01 kJ/kg·K)

g = acceleration due to gravity (9.81 m/s²)

T_{∞} = ambient temperature (assumed 20 °C)

With the parameter values indicated, $D^* = 0.959\text{m}$

Sprinkler activation in FDS was compared to hand calculations based on approach of Evans to determine model sensitivity of each cell size. FDS computes temperature and gas flow throughout the domain, it does not necessarily employ any particular temperature and jet velocity. Instead, it employs the method of Heskestad and Bill determine sprinkler activation based on the surrounding cell conditions.

Table B.6: Sprinkler Activation Times

dx (m)	0.125	0.200	0.250	0.500
Time (mins)	130.3-134.2	135.8-141.5	143.7-154.1	173.8-183.9

As seen in Figure B.7, averages over 10s were used to smooth fluctuations in rest of the results. The finer mesh size corresponded with approximately 9% lower temperatures than the 200mm and 250mm runs. Since the accuracy of temperature calculations in FDS5 has a tendency to under predict compartment temperatures by roughly 20%, and the results from the 200mm and 250mm tests were similar, the more computationally efficient value of 250mm was chosen for the scenarios (McGrattan *et al.*, 2010a).

Figure B.7: Sensitivity Analysis of Temperature Readings

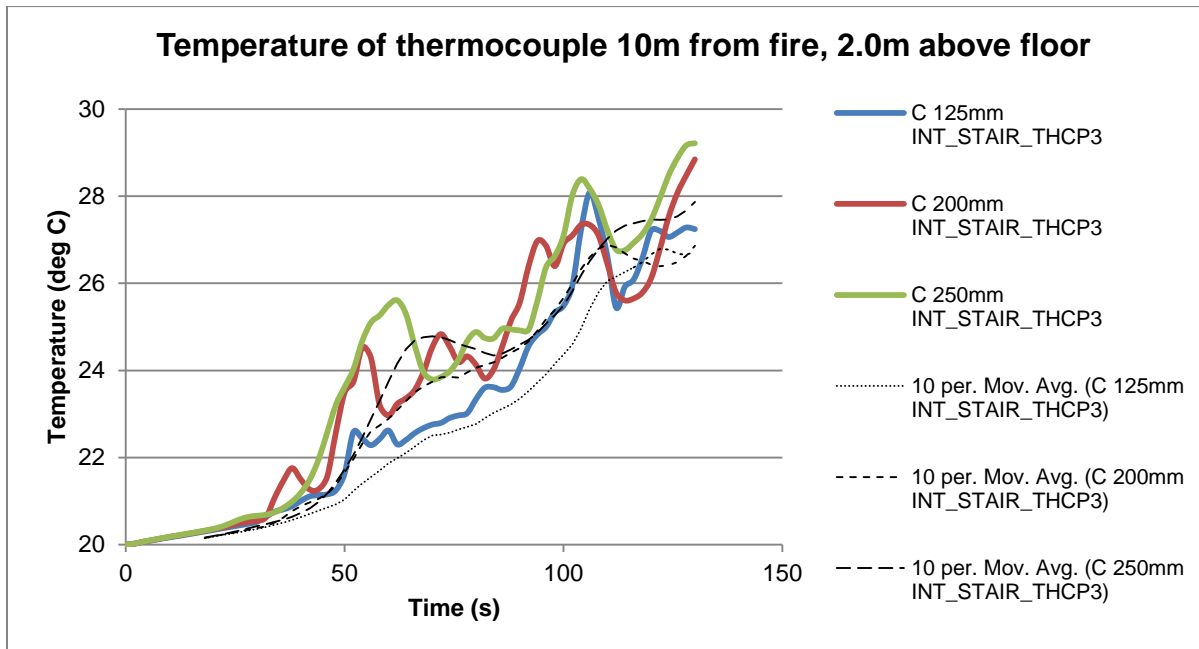

B.4.2.2 Details of Comparison Study

Smoke control in high rise buildings is commonly based on a “pressure sandwich” approach to prevent the spread of smoke to adjoining floors. This method prevents the spread of smoke through cracks and holes in the construction of the building. By creating a positive pressure difference relative to the fire floor, the movement of smoke is contained to the compartment of

origin. In naturally ventilated buildings that are open to the ambient air, a pressure difference cannot be created.

The physics involved in smoke transport for buildings are twofold: higher temperatures in the compartment of origin create higher pressures in sealed buildings, and the higher temperature difference between smoke and the ambient temperature make the smoke buoyant. If an opening in the floor deck above is present, then the smoke will rise through it due to these two forces.

However, in naturally ventilated buildings, the pressure difference of the fire floor would be expected to be negligible compared to other compartments for the same reason the “pressure sandwich” will not work. Since the floor pressure is relieved, pressure differences may be negligible, and the only force left on the smoke is the buoyancy created by the temperature difference.

Since naturally ventilated buildings are open to the ambient temperatures, this also allows for warmer air to move out of the building and be replaced by cooler air, thereby alleviating the temperature-driven buoyancy.

Leakage rates for smoke barriers are found in CBC Section 909.5. The maximum allowable leakage rates are as follows:

Table B.7: Leakage Rates From CBC, Section 909.5

Building element	Walls	Exit enclosures	All other shafts	Floors and roofs
Leakage rate (A/A_w)	0.00100	0.00035	0.00150	0.00050

One limitation of FDS5 is that leakage areas have been validated neither experimentally nor empirically (McGrattan *et al.*, 2010a). This has prevented many engineers from using this feature, as large, computationally expensive models are simply not practical to run without first validating the leakage function. Large leakage areas and use of MPI (Message Passing Interface) to break down the domain into smaller subsets, as required in this case, are not recommended by the authors of the program.

Further, little guidance for implementing leakage into a model is available beyond empirical correlations and other generally accepted physics such as using orifice and fluid flow equations based on Bernoulli’s principles. Guidance that is presented in the SFPE Handbook describes the use of both theoretical and empirical equations, but concedes that for vertical flows the equations are simply “better than nothing” (DiNenno *et al.*, 2010) Discussions in the literature by Forney and Jones (1992) and Klote and Milke (2002) demonstrate how these principles may be applied for calculations of volume flow through horizontal openings using variations of the equation (9.2) used in FDS (McGrattan *et al.*, 2010b) based on a flow coefficient of $C = 0.65$, assuming standard air density of $\rho_{\infty} = 1.20 \text{ kg/m}^3$.

$$\dot{V}_{leak} = C A_L \sin(\Delta p) \sqrt{2 \frac{|\Delta p|}{\rho_{\infty}}}$$

Figure B.8: High Rise Plan View, Floor Leakage

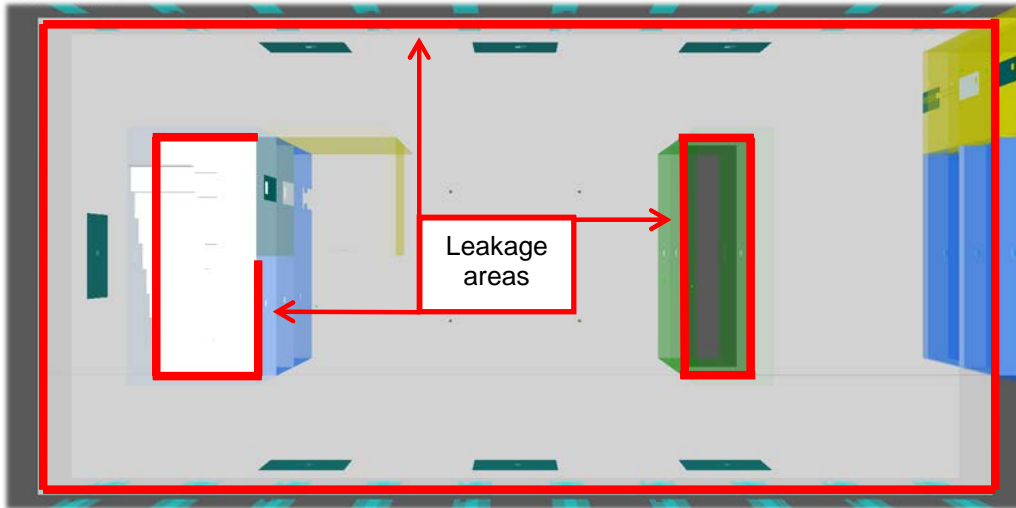

Leakage paths were assumed to be most likely located at points in the floor where construction changed or was not continuous. These points included the interface between the walls of the staircase, elevator and façade and the floor decking. Since the cells in the computational domain had a nominal size of 0.25m, the leakage areas had to be at least as wide to be captured by FDS.

Explicit leakage holes (or orifices) also had similar issues to the floor leakage areas. They represented greater leakage areas than those recommended in the CBC, so this was assumed to make the model more conservative. Leakage areas for the elevators were modeled as two holes 0.5m in depth (distance from room to interior of elevator) by 0.25m wide by 0.5m high. The only issues from this assumption arose if the holes were only one cell in the long dimension, and the model experienced numerical instabilities due to high flow rates out of the small orifices. This was resolved by use of the zone function, which was defined as the volume of each floor.

Figure B.9: High Rise Plan View, Roof Leakage

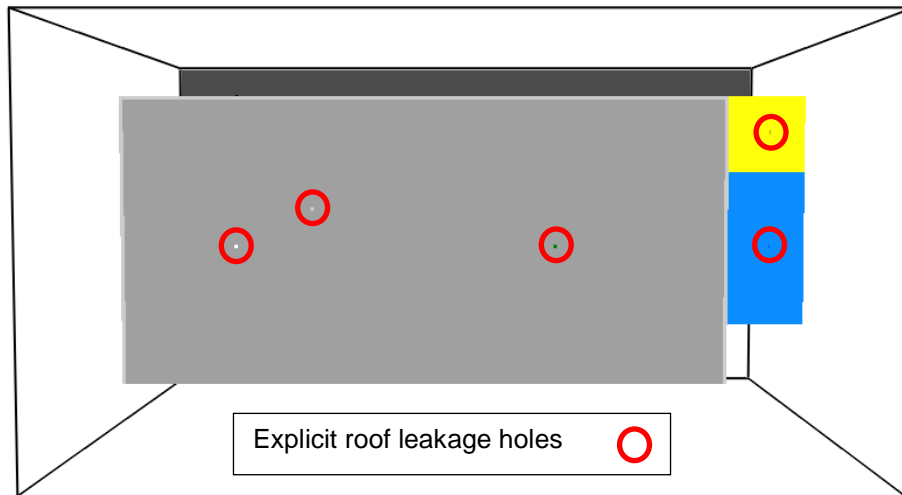
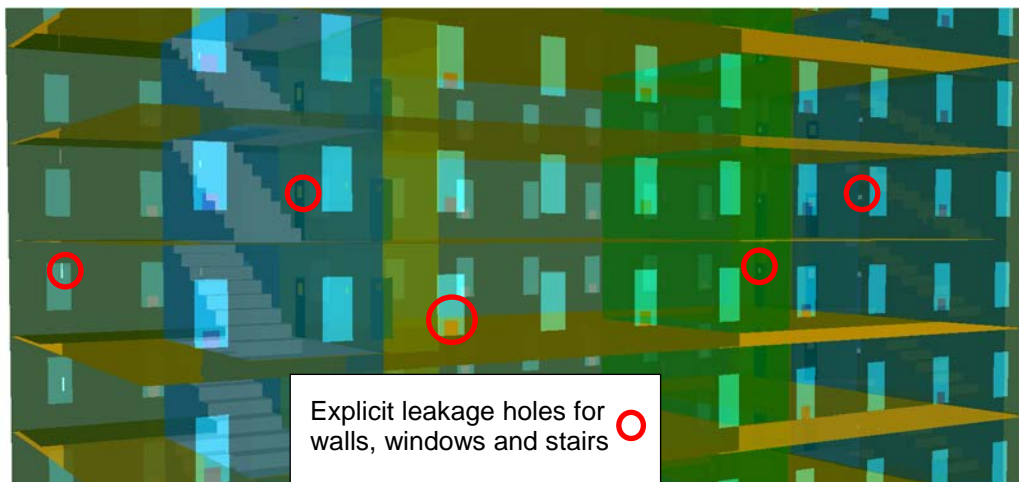
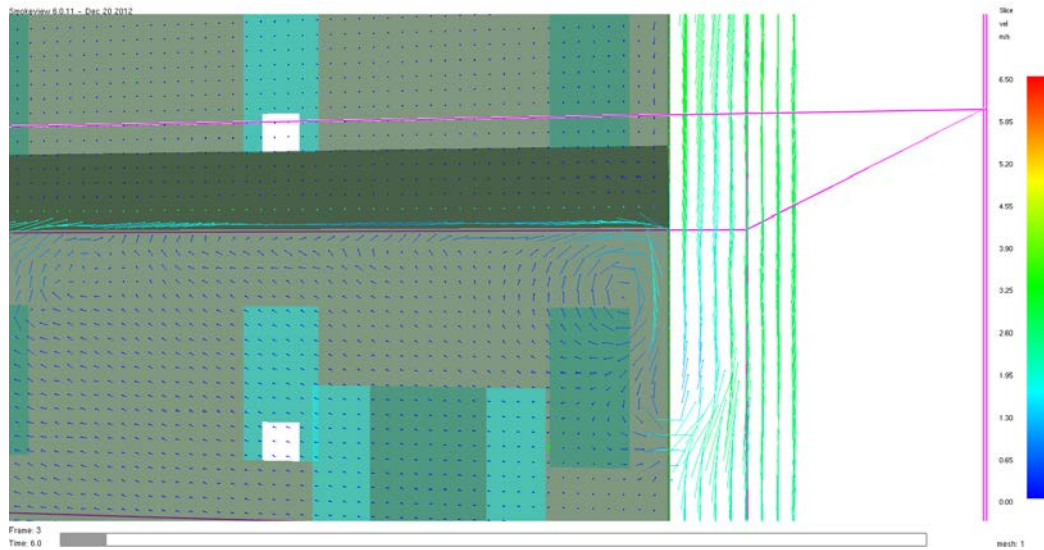

Figure B.10: High Rise Elevation View, Various Explicit Leakage Paths



Explicit leakage areas included the elevator and stair shafts, doors, walls, and windows of the high rise. All were modeled with at least two cells in the z- and x- or y-coordinate directions depending on orientation. The holes were cut one cell outside and inside the respective obstacles to which they were attached. This technique provided more leakage than recommended by codes, yet were effective in transporting the effects of fire, so it was considered a conservative modeling assumption (erring on the side of safety – more smoke transport) to provide larger leakage paths.

Figure 10: High Rise Elevation View, Leakage Vectors



Velocity vectors showed the main reason leakage is difficult at best to quantify. The ceiling jet of a fire, when approaching a wall or other boundary, will strike the boundary and then begin to flow towards the path of least resistance, or in this case towards the floor. Smoke is not immediately transported into the leakage points, but is directed along this path. Some smoke, possibly due to its elevated temperature, has buoyant forces that will direct it into the compartment above the fire. However, much of this is transported back into the plume, and it is assumed during this period that the flow entrains more air, causing some dissipation and cooling around the boundaries. However, no such guidance or experimental data is available at this time to validate these claims beyond the modeling results.

It was first assumed that any leakage or ventilation path should be at least two cells wide in any single direction of the x- y- z-coordinates depending on the orientation of the flow. A sensitivity analysis on leakage was conducted to determine if the leakage would be affected by mesh sizes of 0.125m and 0.250m. Initial temperature and visibility studies indicated that the model was more sensitive to the heat-release-rate HRR of the fire, or more specifically, the initial pressure differences between the compartments due to the effects of the fire (Figure B.11).

Figure B.11: Temperature and Visibility Sensitivity Study

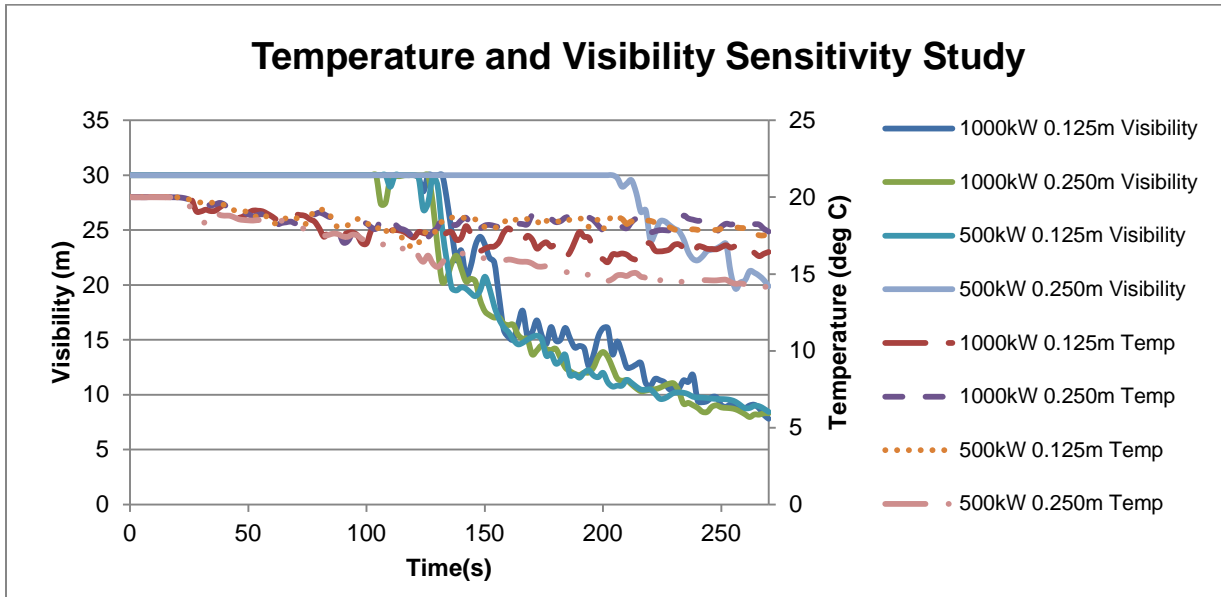

Since pressure difference was not available from experimental tests, the model information from devices in FDS was used to compare simulated to calculated flows. Integrated volume flow rates from modeling analysis of the floor slabs were compared to the calculated results (Figure B.12). It was found that the results had approximately one order of difference between them. This suggests either modeling errors, a loss of flow due to the turbulence of the plume near leakage areas around walls; or more likely, a combination of both.

Figure B.12: Comparison of Calculated and Modeled Flow Rates

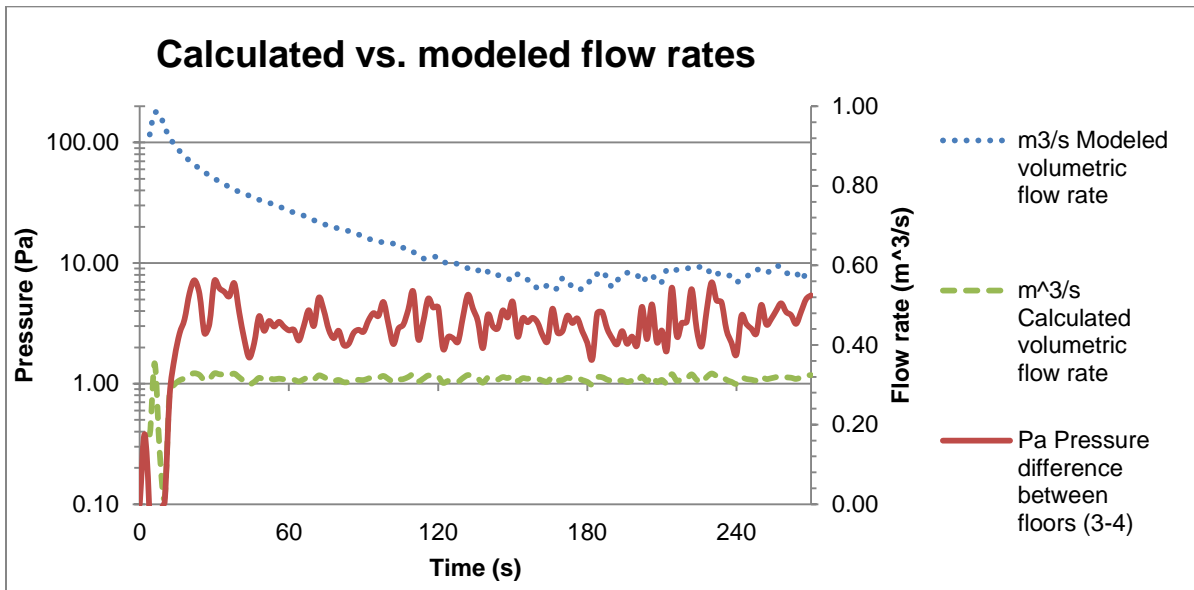

B.4.3 Occupant Egress

CBC Section 909.6 states that “maintenance of a tenable environment is not required in the smoke control zone of fire origin” (CBSC, 2010). This provision is based on the fact that use of the pressurization method would not be possible using normal methods where a positive pressure is created on the floors just above and below the fire floor.

The time required for occupants to exit the fire floor and surrounding areas was a critical factor in determining the safety level afforded by the building. The concept of ASET/RSET was used to define the time needed for each occupant to escape. ASET is defined as the available time given to occupants before they are exposed to untenable conditions, while RSET is the required time to evacuate. Fahy (2008) further characterizes this concept into four parts: time to notification, reaction time, pre-evacuation activity time, and travel or movement time.

Occupants in an office building were assumed to be alert and familiar with their surroundings. Some occupants may have had prior training from fire drills or personal experience with fire. Notification time was determined by assuming that the occupants most intimate with the fire would begin evacuation within 60s of the start of the fire. Those on the floors above and below the compartment of origin would be notified by alarms tied to the sprinkler system, which activated at approximately 180s, and begin exiting at 240s. At this point in time, the occupants in the zone above the fire floor would also begin to notice smoke in their vicinity which would aid in their recognition of the threat of fire below.

Egress based on occupant load based on CBC Section 304 for Business Group B. The area of each floor was 800m², or approximately 8,611ft². Using Table 1004.1.1, an occupant load of 100ft² per person was assigned to each floor; therefore, 87 occupants were assumed to be present on each floor.

The maximum travel distance of an occupant was assumed to be taken from the farthest point from any one exit and that they would walk along the perimeter of the compartment. The travel distance was calculated to be 20m + 40m = 60m.

Egress widths through doors and staircases were found using Section 1005.1 and the applicable minimums found in 1008.1 and 1009.1.

Table B.8: Egress Widths as per Section 1005.1

Building element	Width factor	Width required (in)	Minimum width (in)
Doors	0.2	17.4	32 (Section 1008.1)
Stairs	0.3	26.1	44 (Section 1009.1)

The limiting factor for egress typically is the exit doors, as that is generally the portion of the route with the shortest required width. Other geometries specific to a building such as arrangement of halls or cubicles, conference rooms, break rooms, etc, were not considered in the

general analysis. The speed of occupants was determined using the following equation found in several sources on egress (Gwynne & Rosenbaum, 2008):

$$S = k - akD$$

where

S = speed along line of travel

a = constant of 0.266 (when calculating speed in m/s and density in persons/m²)

k = constant for evacuation speed: 1.40 m/s for corridors, aisles, ramps, and doorways

1.00 m/s for slowest stair speed

D = population density (0.108 persons/m²)

The speed of occupants was calculated to be 1.4m/s, which is relatively high compared to reported values for observed egress speeds reported by the NFPA Fire Protection Handbook (Fahy, 2008). Therefore, a lower value of 1.0m/s was used to account for varying occupant conditions and speeds.

The time to reach the exterior stair vestibule door was approximately 60s. Flow was then calculated to determine if queuing would occur based on the maximum specific flow found, F_{sm} , of 1.30 persons/sec/m. Assuming the 0.8128m (32in) doors have a boundary layer of 0.1524m (6in), the effective width for egress is 0.6614m (26in). The flow is then found to be approximately 0.86persons/sec. It will take 87 occupants approximately 75sec to move through the door. Since this is more than the time it takes to traverse each floor, some queuing may be expected to occur and flow is controlled by this door. This is already a conservative estimate that does not include the other stair door as a possible egress path. Therefore, total exit time from the floor will be based on flow through the door.

Figure B.13: $t = 240s$, Start Time of Occupant Egress From Upper Floor

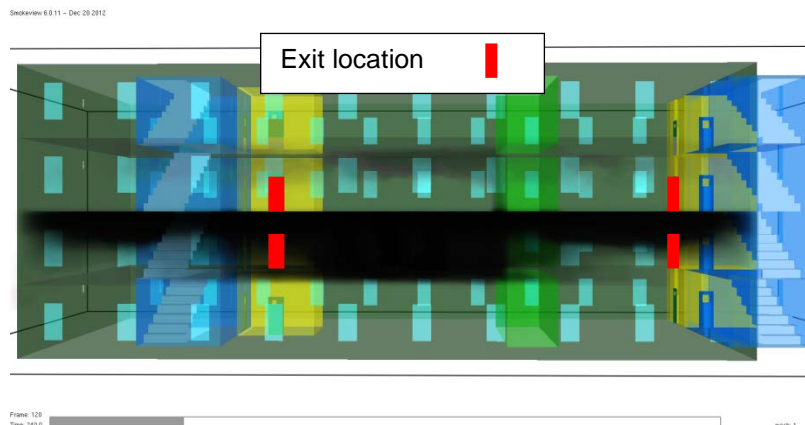

Section 403.5.4 requires smokeproof exit enclosures such as this stair to be protected by a 2-hr fire barrier or horizontal assembly per 909.20. Further protecting the occupants is a required stair pressurization system. However, this analysis pertains more to the effects of smoke on the floors of concern. More analysis for total building egress times could be performed utilizing a range of tools from first-order hydraulic calculations to any of several software packages for egress. The rest of the egress analysis will be based on the fire floors and surrounding areas.

Floor conditions were considered untenable once occupants could not see an illuminated exit sign from 10m away. Tenability is lost on the floor above the compartment of origin in approximately 784s. Although the majority of the floor is tenable, the area around the exits became untenable at this time, so it was assumed any remaining occupants could not find the door. However, even with the most conservative estimates and adding a large safety factor (3 or more), occupants had more than enough time to leave the affected floor.

Figure B.14: Loss of Tenability at T=784s on Floor Above Fire, High Rise

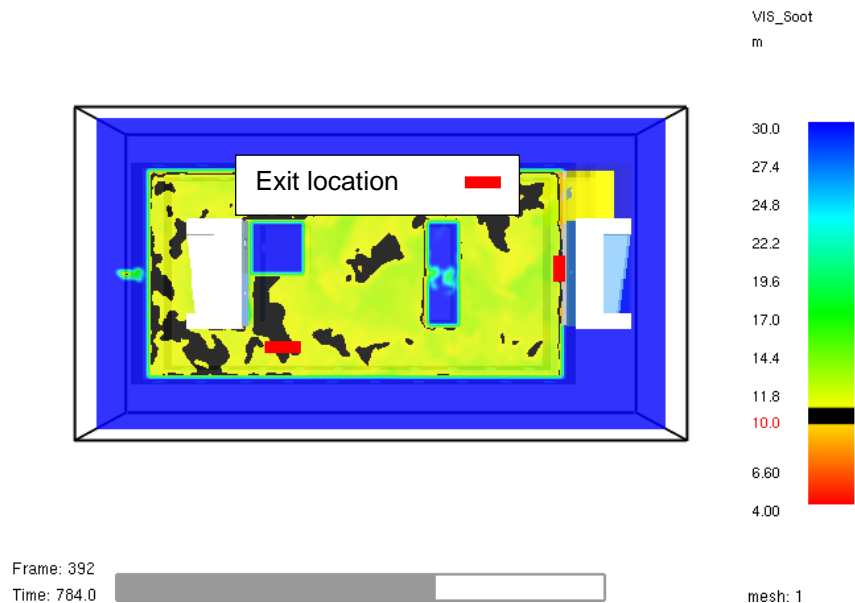

B.4.4 Smoke Control System

B.4.4.1 High Rise

CBC Section 909.6 requires a pressure difference of 0.05 inH₂O between floors to limit the smoke spread to the compartment of origin. However, in a naturally ventilated building, achieving pressure differences with operable windows or open facades would not be possible. Further, many natural ventilation concepts utilize open floor plans, solar chimneys, and other concepts that allow for air movement between floors (Wood & Salib, 2012). Therefore, the models were built to compare the difference between open and closed facades, and allowed for leakage through the floor without any form of smoke control system in place.

B.4.4.2 Atria

Atria smoke control was examined using both natural means through openings at the top of the atria and conventional smoke extraction fans. The skylight openings or fans were activated at $t=60s$. Varying types of hardware, such as beam and fixed detectors, as well as heat detection if provided, might cause varying results.

Figure B.15: Atrium Exhaust Openings

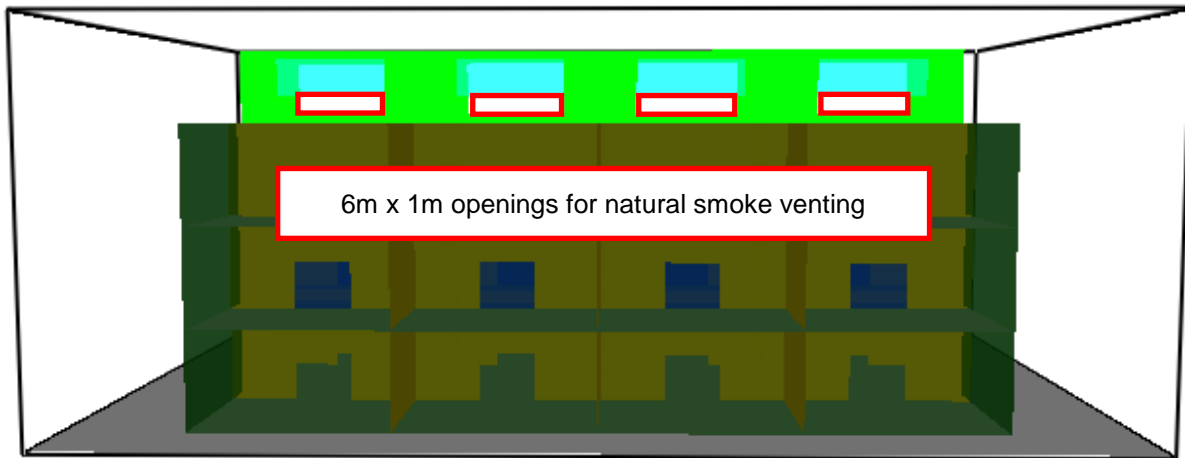
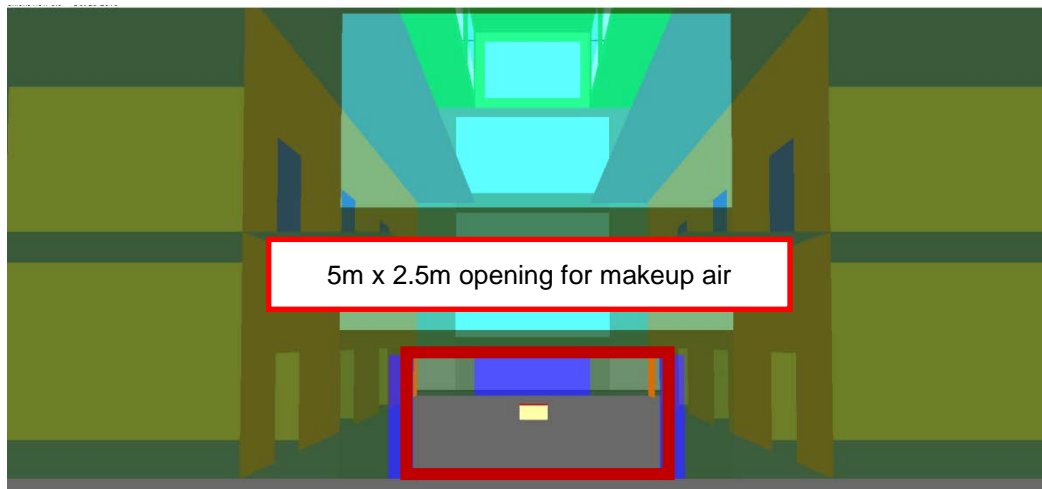

Figure B.16: Atrium Makeup Air Openings



B.4.5 Sensors and Slice Files

Multiple sensors are available in FDS for use in gathering point data, including temperature, visibility, velocity and pressure. Slice files are used to capture data in a plane or volume in order to examine these outputs in a graphical format. These files allow designers to see the data in vector format as well, which aids in visualizing movement of gases in the model. Sensors

were located outside of the interior and exterior stair vestibules and near the elevator. Each sensor was placed 2.0m above the floor to determine tenability conditions just above the heads of occupants.

Figure B.17: Location of Sensors

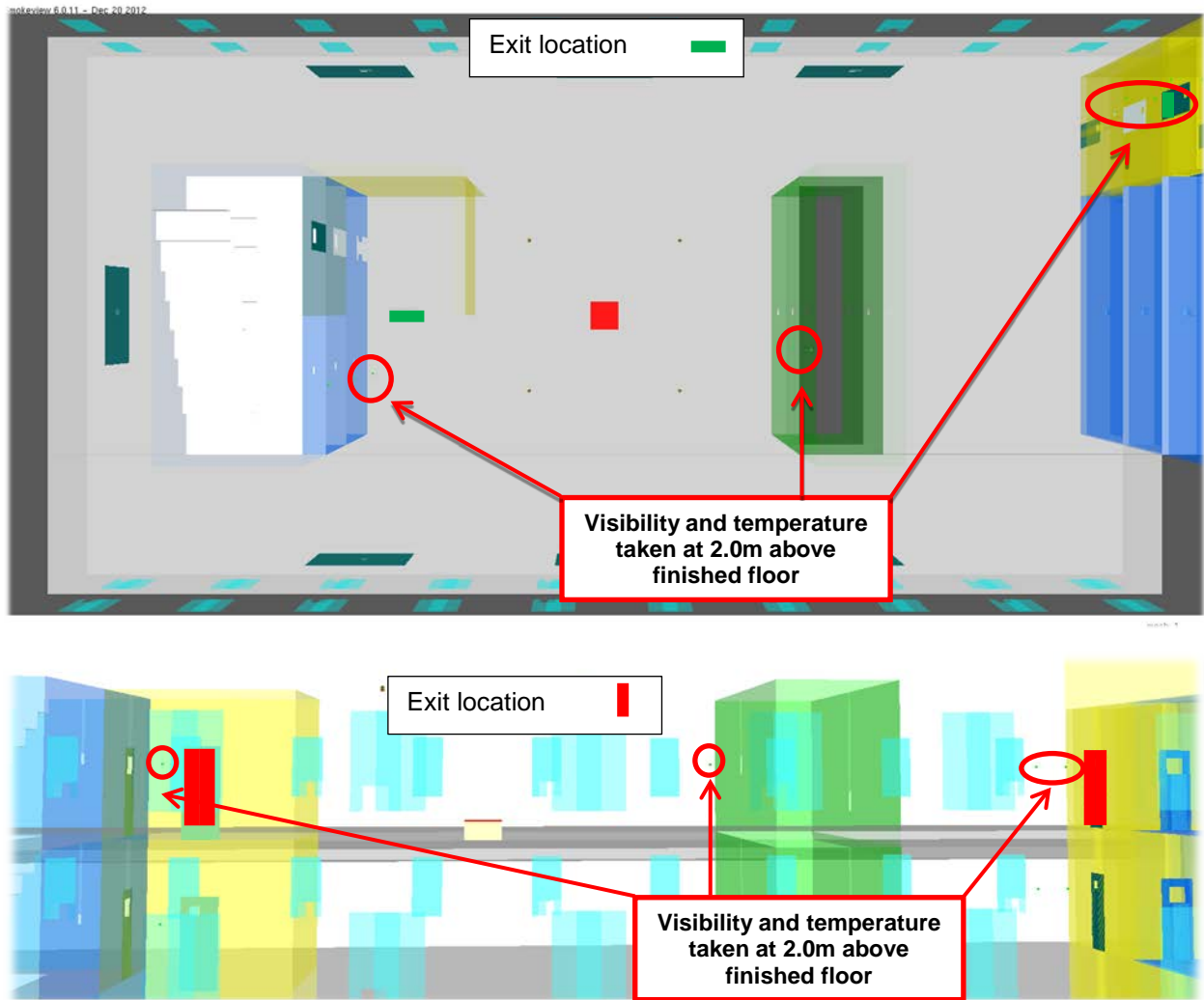

Visibility settings for FDS were based on a person’s ability to see a light-reflecting sign from a distance of 10m. The visibility S is inversely proportional to the light extinction coefficient, K

$$S = C/K$$

where K is defined as a product of the density of smoke production, density of the smoke, and smoke yield, and the non-dimensional constant, $C = 8$ or 3 , depending on whether the sign is light-emitting or light-reflecting, respectively (McGrattan *et al.*, 2010b).

Temperature was taken as a secondary means to determine tenability. In all models, untenable conditions were first met for visibility limits. Other data extracted from the models included mass production of the fire, mass and volumetric flows through the “leakage” in the fire floors (as an integral of the entire floor), and wind velocities.

B.4.6 Wind Effects

Wind has the effect of creating positive and negative areas of pressure on the windward, leeward, top and side areas of a building. These positive and negative pressures would have a greater effect on smoke control measures in naturally ventilated buildings compared to those without openings on the façade (Klote & Milke, 2002). The Wildland-Urban Interface Fire Dynamics Simulator (WFDS) is an extension of FDS used to model grassland and forest fires.⁴¹ The information obtained from experiments and exercises conducted by NIST (Barowy & Madrzykowski, 2012), together with studies of wind farms and urban environments, were used to determine the most appropriate method to simulate wind for models. The capabilities of FDS to model the effects of wind are not fully validated, so this portion of the study was limited to determining plausible profile, domain and mesh sizes.

Computer modeling of wind farms (Sathe & Bierbooms, 2007; Peña *et al.*, 2008) and urban environments (Blocken *et al.*, 2007) typically rely on a wind profile power law model. FDS uses by default a “top hat” profile to model wind. The wind profile power law model, or “atmospheric” profile in FDS, uses the following relationship to model wind speed as a function of height (McGrattan *et al.*, 2010b):

$$u = u_o \left(\frac{z}{z_o} \right)^p$$

where

u = horizontal wind velocity (m/s) at height z (m)

u_o = horizontal wind velocity (m/s) at reference height $z = z_o$ (m)

and z, z_o are vertical distances above ground level, $z = 0$.

Figure B.18: Location of Wind Velocity Monitoring Points in Computational Domain

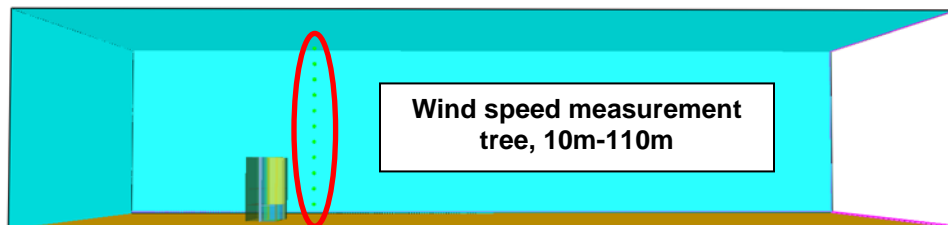

⁴¹Refer to <http://www.fs.fed.us/pnw/fera/research/wfds/> on the US Forest Service website.

In order to determine the appropriate domain size and resolution, the study first started with a computational domain of 440m x 710m by 120m, which was approximately 10 times the building height towards the leeward side, 5 times the height on the windward side, 5 times the height on each of the narrow sides and just under 3 times the model height above the building. A velocity device tree was placed in the leeward portion of the model to determine the effects of changing computational domain on the wind vortices on the rear portion of the building (Figure B.18).

The model was then reduced in size to determine what the smallest possible domain would be to still capture the flow patterns of the larger model. The domain size found to best capture the effects of wind around the building while keeping computational expense to a minimum was 240m x 330m x 120m, or roughly 5 times the height on the leeward side, 2 times the height on the windward side, 2 times the height on the narrow sides, and just under 3 times the height to the top.

Figure B.19: Sensitivity of Velocity to Cell and Domain Sizes (Side View of Vertical Section)

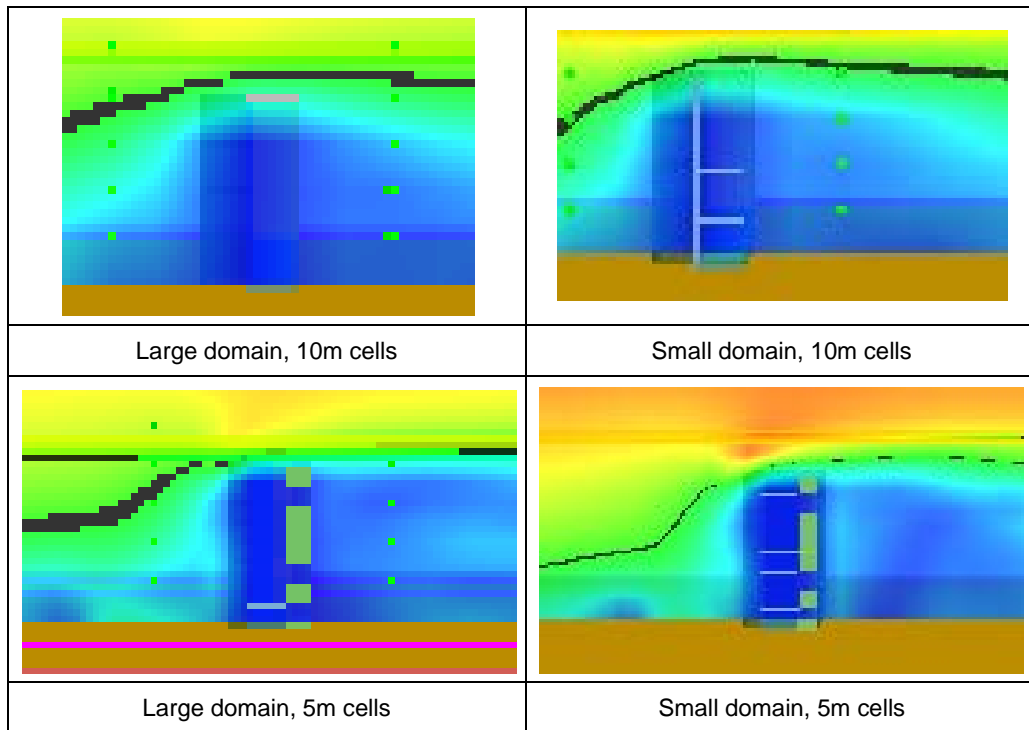

The computational domain size and shape were varied to determine the sensitivity of the model to these factors (Figure B.19 and Figure B.20). 10m and 5m cells sizes were found to have good agreement. The smallest domain did show wind speeds that were somewhat higher around the model, especially near the leeward side, but also showed better detail in turbulence around the façade of the building. In the models, the black lines represent wind speed of approximately 12.7m/s (28.4mph), which was the value desired in the modeling evolutions based on the prevailing winds in the San Francisco area (Klote & Milke, 2002), and was the velocity value used in FDS.

Figure B.20: Sensitivity of Velocity to Cell and Domain Sizes (Plan View of Horizontal Section)

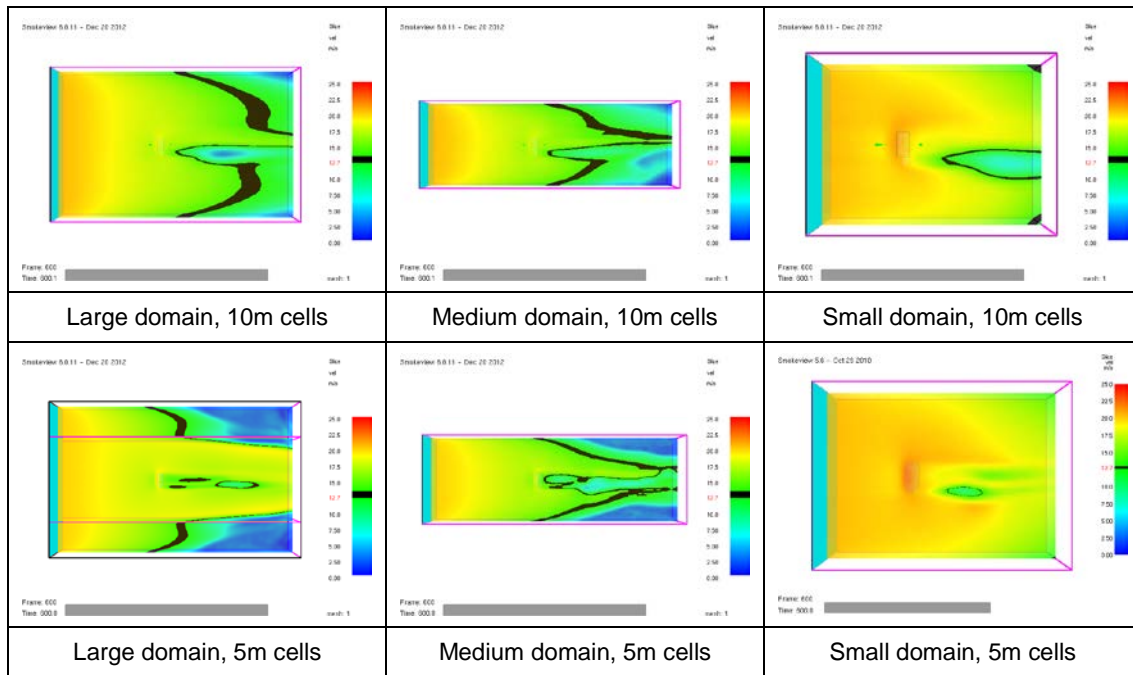

B.5 Atria Results

Small atria or those with lower ceiling heights showed little resistance to plume rise and subsequent smoke mitigation. The upper region of the atria filled with smoke early in the development of the fire. Naturally ventilated atria with operable skylights allow for tenable conditions at a higher level than in unvented ceiling areas. Models reached a quasi-steady state after approximately 400s with the exception of the 15m run which completely lost tenability soon after.

B.5.1 15m

Winter effects were mainly studied, as stack effects are greatest when the temperature outside a building is colder than the inside. In the 15m atrium, this had little effect on smoke movement out of the skylight windows. This was expected, as stack effect is generally not seen in lower structures. Tenability was found to still stay above the lower two floors after 400s.

B.5.2 30m

Overall, the 30m Atrium was relatively unaffected by the effects of smoke in the open model runs. Only floors 5 and 6 lost tenability after 400s in the open building compared to all floors above the 2nd floor in the closed model. This follows hand calculations based on the SFPE equations found in Section 4.3.

Figure B.21: Visibility for 15m Atrium, T = 400s, Open (Upper) and Closed (Lower)

Smokeview 6.0.7 - Nov 2 2012

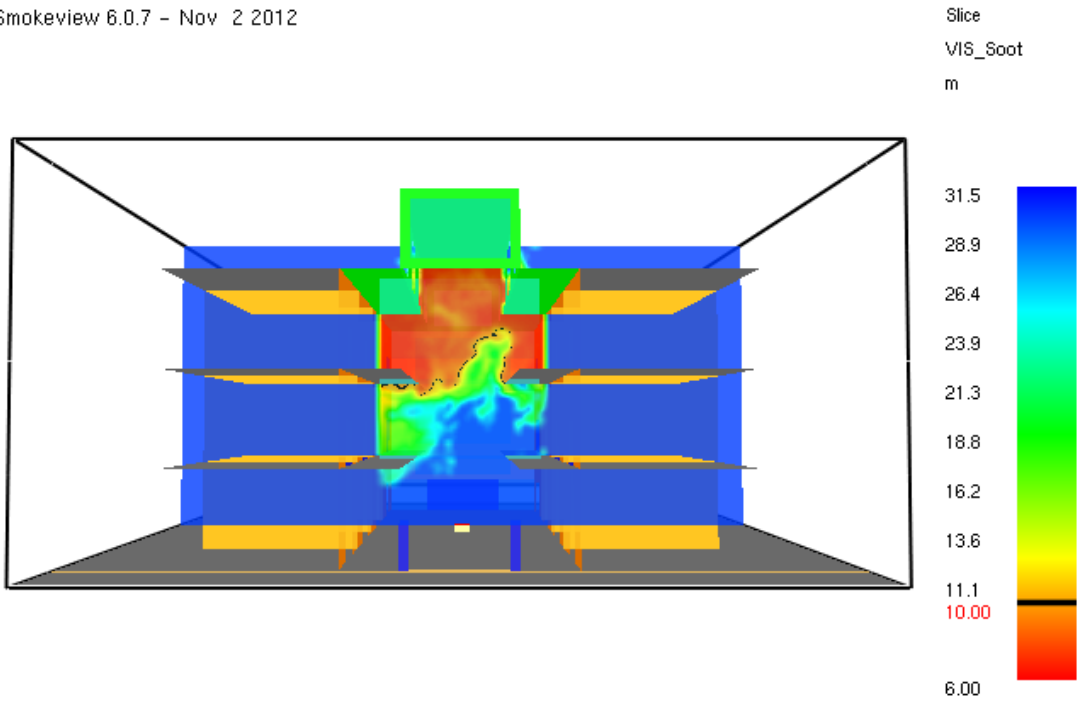

Smokeview 6.0.7 - Nov 2 2012

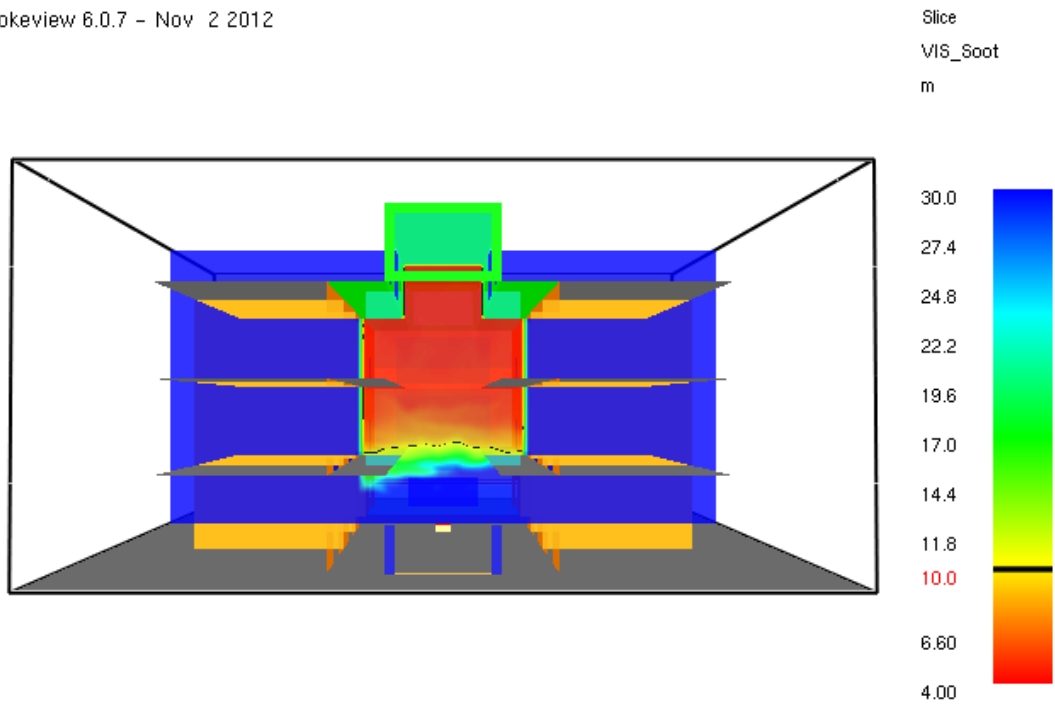
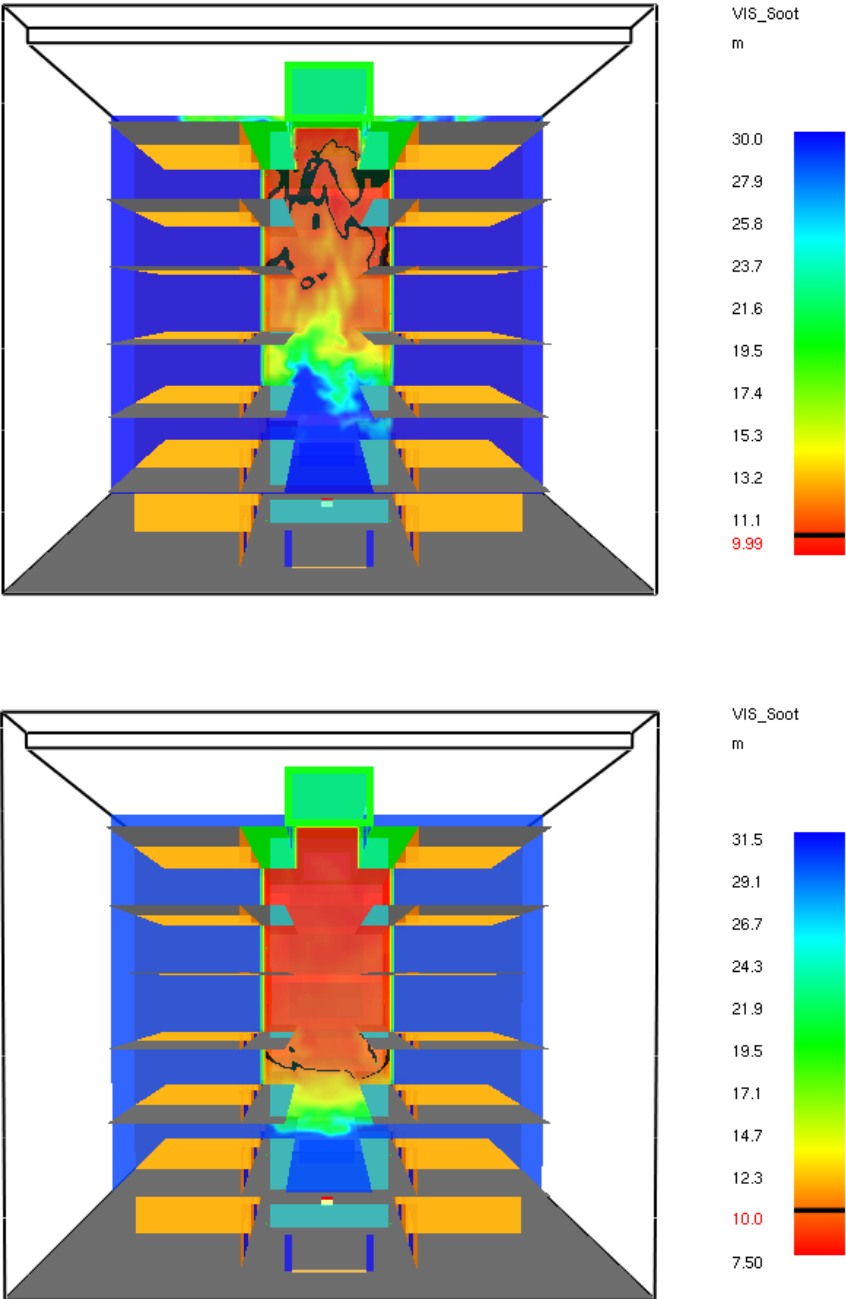

Figure B.22: Visibility for 30m Atrium, T = 400s, Open (Upper) and Closed (Lower)



B.6 High Rise Results

While tenability was lost on the fire floor within the growth period of the fire, the upper floors remained tenable throughout the evolution. In no-wind evolutions, tenability was above 10m for the first 600s. Based on egress calculations, this was more than adequate time to evacuate the

floors surrounding the fire floor and get occupants into the stairwells, which were assumed to be protected by smokeproof enclosures.

Figure B.23: Visibility for High Rise, T = 600s, Open (Upper) and Closed (Lower)

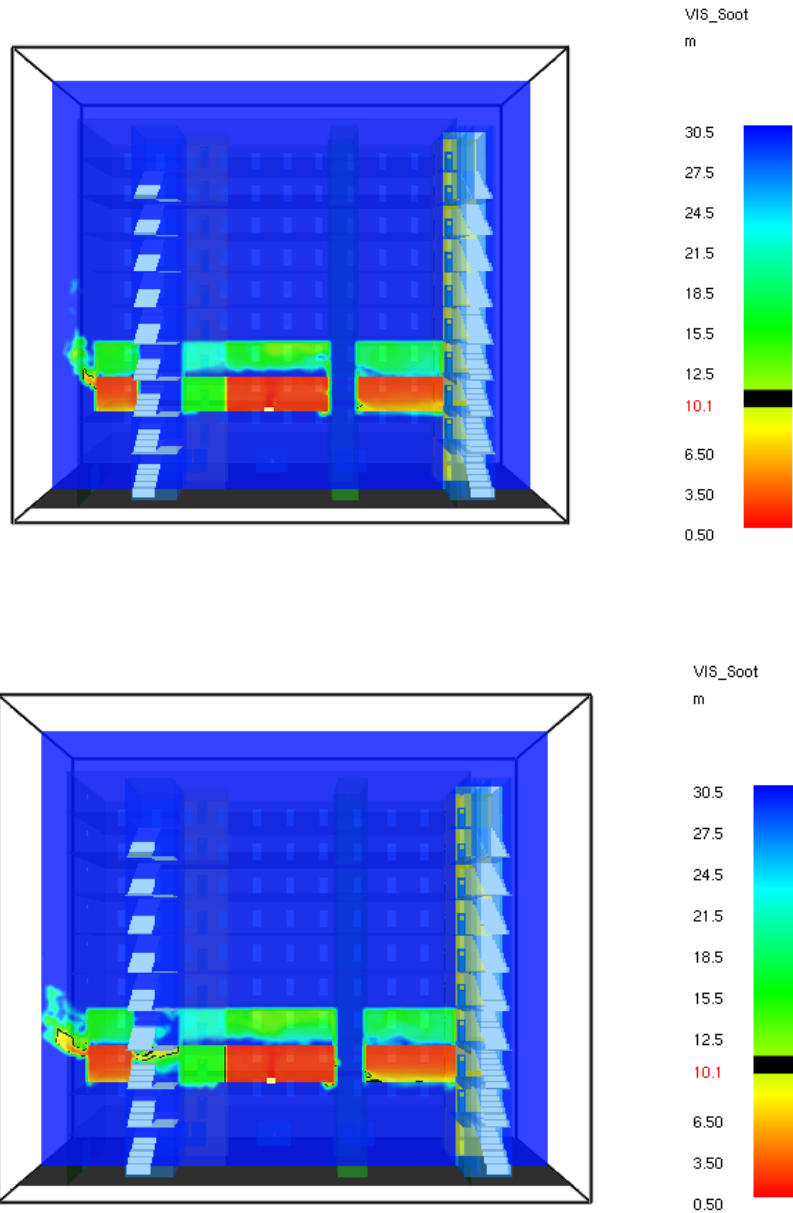

Results from wind studies of 12.7m/s (28.4mph) prevailing winds resulted in greater tenability, even on the fire floor. Smoke was seen blowing out of the leeward side of the building, lessening the amount of mass entrained within the structure.

Figure B.24: T=1200s, 12.7m/S (28.4mph) Wind, Operable Windows

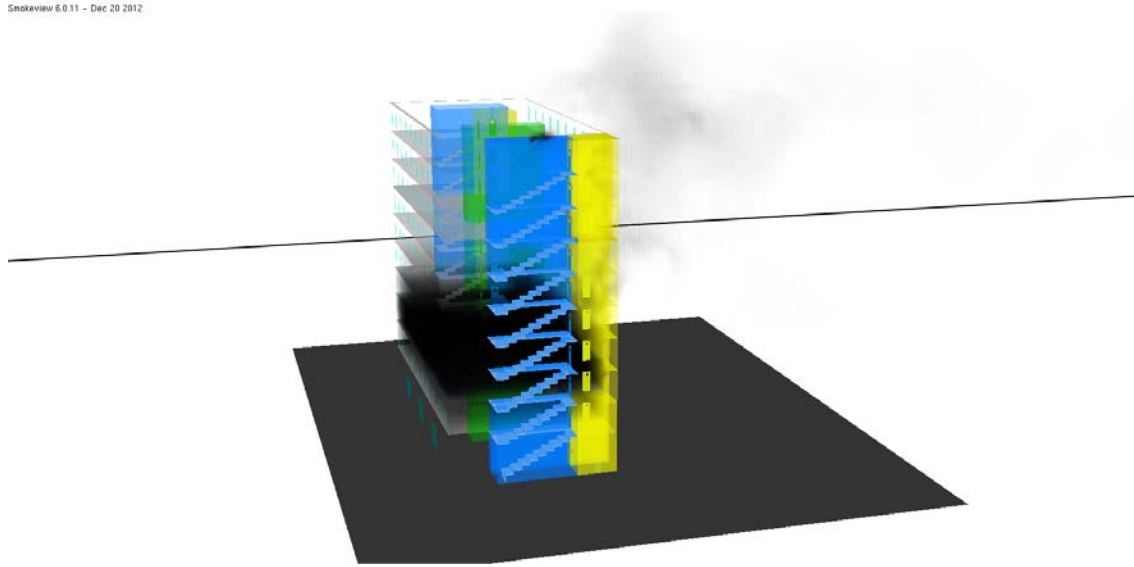

Visibility was maintained throughout the modeling evolution on the upper floors, and the fire floor did not lose tenability until after 700s. This provided even greater egress time for occupants. Results showed that the upper floors did not lose tenability past the prescriptive requirement in CBC Section 906.4 of 20min (CBSC, 2010).

Figure B.25: Visibility, Operable Windows

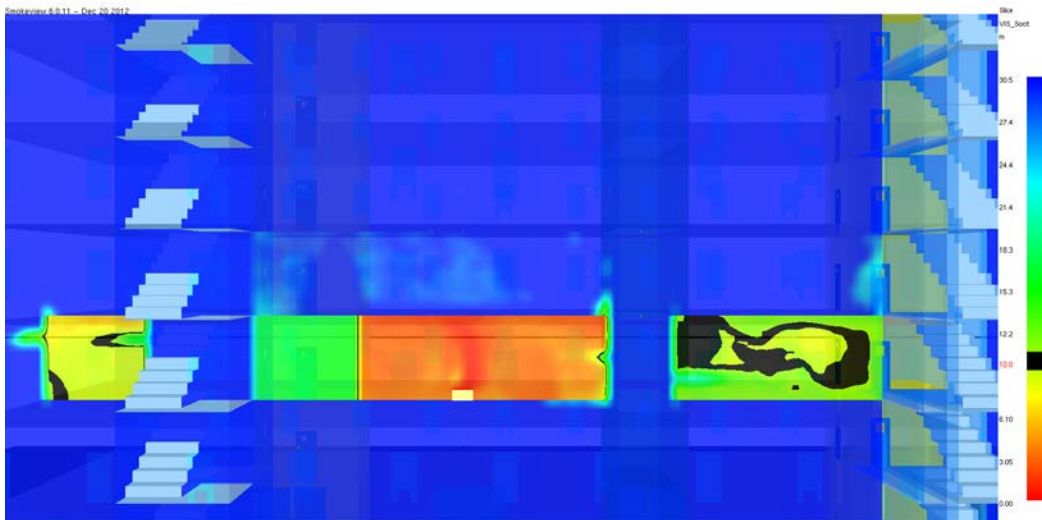

Velocity vectors of the leeward side of the building showed a tendency for wind turbulence to first turn back toward the structure in a rolling manner, then going up the façade and returning to the stream above. This rolling effect did not create enough velocity or pressure differential to

force the smoke back into the structure. Instead, it had the effect of entraining more air into the smoke and moving it away from the structure.

Figure B.26: Velocity Profile, Leeward Side

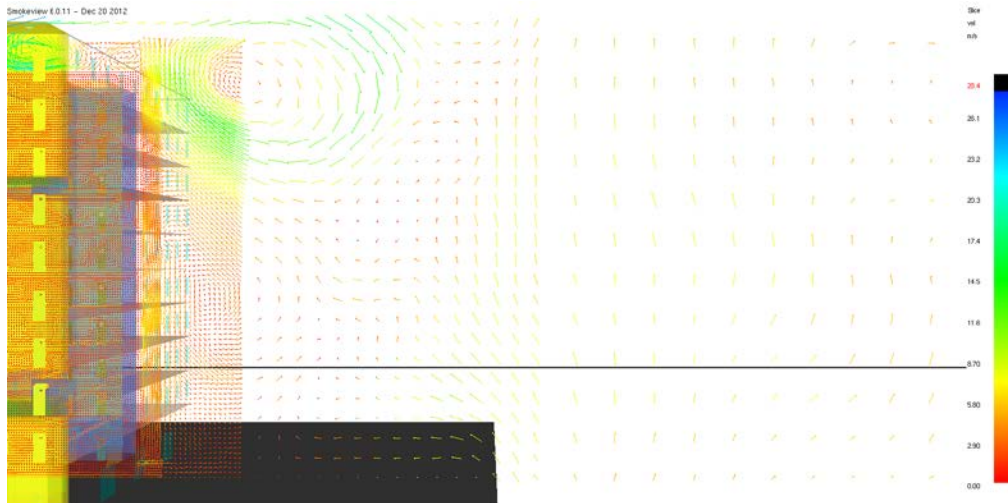

B.7 Conclusions

B.7.1 Code Modifications – New Buildings

IBC Section 403 requires smoke control systems for atria, malls and high rises. The purpose is to facilitate smoke removal in post-fire salvage and overhaul operations. The CBC Section 403 deviates from the IBC as it requires smoke control systems to provide tenable conditions for the evacuation and relocation of tenants. While this paper does not question the CBC’s focus on occupant safety, we do recommend that Section 909 be changed to reflect the nationally-accepted IBC’s approach to allowing “other approved designs that will produce equivalent results”. This change would not be detrimental to the safety of occupants, but instead would allow designs to be based on research, empirical data, and state-of-the art computational analyses. This would also be consistent with the history of code development, which has been based on engineering judgment and has evolved with increased experience, testing and improvements to computer simulation software. Such an engineered approach is allowed by other parts of the CBC.

B.7.2 Code Modifications – Retrofit of Existing Buildings

The CEBC’s Section 1301 lists smoke control as part of a Recommendations for changing the CEBC’s language are fewer, since it is already friendly performance-based evaluation of the building, but only imposes such systems on retrofits of high-rises, not atria or malls. CEBC Section 601.2 requires modifications or alterations to retain at least the safety level of the pre-retrofitted building. Although the CEBC has many requirements that are similar to the CBC’s requirements for new buildings, none provide guidance for modifying existing smoke control systems, or adding new ones where smoke control systems are not already present.

B.7.3 Modeled Case Studies

While there is room to expand the number of case studies and, the few studies this research presents indicate that modern analysis software is capable of proving whether engineered designs meet tenability requirements and provides some insight as to the potential for natural ventilation openings to be included in smoke control systems for atria, malls and high-rises.

APPENDIX B REFERENCES

- Barowy, A. and D. Madrzykowski (2012) *Simulation of the dynamics of a wind-driven fire in a ranch-style house – Texas*. National Institute of Standards and Technology, Technical Note 1729.
- Best, R. and D.P. Demers (1982) Investigation report on the MGM Grand Hotel fire, Las Vegas, Nevada, November 21, 1980. National Fire Protection Association, Quincy, MA, 15 January 1982.
- Blocken, B., Stathopoulos, T. and J. Carmeliet (2007) CFD simulation of the atmospheric boundary layer: wall function problems. *Atmospheric Environment* 41(2), 238-252.
- Bowers, D.C., Ellison, J.R., Beasley, D.E. and R. S. Miller (2010) Numerical study of elevator and stairwell pressurization systems using detailed building models. In *Proceedings of the 8th International Conference on Performance-Based Codes and Fire Safety Design Methods*, Lunds Universitet, Lund, Sweden, June 16-18, 2010. Society of Fire Protection Engineers.
- CBSC (2010) 2010 California Building Code, California Code of Regulations, Title 24, Part 2, Volumes 1 and 2. California Building Standards Commission, Sacramento, CA.
- Coffey, B., Borgeson, S., Selkowitz, S., Apte, J., Mathew, P. and P. Haves (2009) Towards a very low-energy building stock: modeling the US commercial building sector to support policy and innovation planning. *Building Research & Information* 37(5-6), 610-624.
- DeCicco, P.R., Cresci, R.J. and W. H. Correale (1972) Fire tests, analysis and evaluation of stair pressurization and exhaust in high-rise office buildings. Polytechnic Institute of Brooklyn.
- DiNunno, P.J., Drysdale, D., Beyler, C.L. and W.D. Walton, eds. (2008) *The SFPE handbook of fire protection engineering*. National Fire Protection Association.
- Emmerich, S.J., Dols, W.S. and J.W. Axley (2001) Natural ventilation review and plan for design and analysis tools. National Institute of Standards and Technology, Report NISTIR 6781.
- Fahy, R.F. (2008) Calculation methods for egress prediction. In *Fire protection handbook*, National Fire Protection Association, 2008 edition, Chapter 4.2.
- Forney, G.P. and W.W. Jones (1992) Modeling smoke movement through compartmented spaces. National Institute of Standards and Technology report, July 1992.
- Gwynne, S.M.V. and E.R. Rosenbaum (2008) Employing the hydraulic model in assessing emergency movement. In *SFPE handbook of fire protection engineering*, Chapter 3-13.
- ICC, Inc. (2009) *International Building Code*. 2009 edition. International Code Council, Inc.
- Klote, J.H. (1984) Smoke control for elevators. *ASHRAE Journal* 26(4), 23-33.

- Klote, J.H. (1990) Fire experiments of zoned smoke control at the Plaza Hotel in Washington, D.C. National Institute of Standards and Technology, Report NISTIR 90-4253.
- Klote, J.H. and J.A. Milke (1992) Design of smoke management systems. ASHRAE. 223pp.
- Klote, J.H. and J.A. Milke (2002) Principles of smoke management. ASHRAE. 377pp.
- McGrattan, K., Hostikka, S., Floyd, J. and R. McDermott (2010a) Fire Dynamics Simulator (Version 5), Technical Reference Guide. Volume 3: Validation. National Institute of Standards and Technology. Special Publication 1018-5.
- McGrattan, K., McDermott, R., Hostikka, S. and J. Floyd (2010b) Fire Dynamics Simulator (Version 5), User's Guide. National Institute of Standards and Technology. Special Publication 1019-5.
- McGuire, J.H. (1967) Control of smoke in buildings. *Fire Technology* 3(3), 163-174.
- Miller, R.S. and D. Beasley (2008) On smoke control by pressurization in stairwells and elevator shafts. Clemson University, Clemson, SC.
- NFPA (2006) NFPA 92A: Standard for smoke-control systems utilizing barriers and pressure differences. 2006 edition. National Fire Protection Association.
- NFPA (2007a) NFPA 13: Standard for the installation of sprinkler systems. 2007 edition. National Fire Protection Association.
- NFPA (2007b) NFPA 72: National fire alarm code. 2007 edition. National Fire Protection Association.
- Peña, A., Gryning, S.-E. and C. B. Hasager (2008) Measurements and modelling of the wind speed profile in the marine atmospheric boundary layer. *Boundary Layer Meteorol.* 129, 479-495.
- Sathe, A. and W. Bierbooms (2007) Influence of different wind profiles due to varying atmospheric stability on the fatigue life of wind turbines. *Journal of Physics: Conference Series* 75, 1-7.
- Stroup, D.W. (2003) Literature review on enclosure of elevator lobbies. National Institute of Standards and Technology, Report NISTIR 6973.
- Tamura, G.T. (1970) Computer analysis of smoke movement in tall buildings. *ASHRAE Transactions* 75(2), 81-92.
- Tamura, G.T. and A. G. Wilson (1967) Building pressures caused by chimney action and mechanical ventilation. *ASHRAE Transactions* 73(2), II.2.2-II.2.12.
- USNRC and EPRI (2007) Verification and validation of selected fire models for nuclear power plant applications, Volume 7: Fire Dynamics Simulator (FDS). US Nuclear Regulatory Commission, Office of Nuclear Regulatory Research (RES), Rockville, MD, and Electric Power Research Institute (EPRI), Palo Alto, CA, NUREG- 1824 and EPRI 1011999.

Wakamatsu, T. (1968) Calculation of smoke movement in buildings. Research Paper No. 34, Building Research Institute, Tokyo, August 1968.

Wood, A. and R. Salib (2012) Natural ventilation in high-rise office buildings. Routledge.

APPENDIX C: Natural Ventilation Design Guidelines

C.1 Introduction

Throughout history, humans have used wind and buoyancy-driven flows to naturally ventilate and condition their dwellings. The modern age has brought greater challenges to the use of natural ventilation, including deeper floor plans and increased sources of indoor pollutants, and with the steady increase in use of mechanical ventilation and air conditioning during the second half of the 20th century existing design skills for natural ventilation systems were lost. During the same period, user expectations and thermal comfort standards increased, creating a scenario where natural ventilation became rare in modern office buildings as designers and building owners choose the more reliable mechanical ventilation option.

In the last two decades there has been a renewed and growing interest in natural ventilation of office buildings, creating the need to update methodologies and design skills for these types of systems (Linden, 1999). The published literature includes a number of examples of successful natural ventilation designs (e.g. Zhai *et al.*, 2011; Levi & Soper, 2009; Carrilho da Graça *et al.*, 2004), but also some failures, which tend to arise from lack of experience and maturity of the designs (Carrilho da Graça *et al.*, 2012).

In the design and research community, there is a growing consensus that natural ventilation is a key component in the mix of solutions that will deliver, within the next decade, nearly zero energy buildings. Further, in California, equipping buildings with natural ventilation offers the most potential for reducing energy costs and CO₂ emissions associated with cooling.

This natural ventilation design guide discusses how to identify and implement natural ventilation in small commercial buildings (both new and retrofit). It contains a mixture of background theory and simple guidelines that can be used to answer basic design questions, such as how many operable windows are needed for a given space, and what is the optimal window arrangement for either cross ventilation or single-sided ventilation.

The target audience for this guide is building design professionals, e.g., HVAC engineers, simulation consultants, and architects with an interest in natural ventilation design, as well as utility program managers.

C.1.1 Fundamentals

Natural ventilation uses wind and temperature differentials to generate room or building air exchanges. Such exchanges of fresh air can be used to alleviate odors, remove Volatile Organic Compounds (VOC's) and other airborne contaminants, and displace carbon dioxide with oxygen for respiration. If enough heat can be removed, natural ventilation can also be a means of achieving thermal comfort.

This section gives a brief introduction to the science behind natural ventilation. Architects, mechanical engineers, and designers need to appreciate how design elements in their control,

such as opening size, opening orientation, vertical opening separation, etc., are expressed in mathematical form and how they impact the air flow rate (left side of the equations).

Note on Units

This guide uses inch-pound units in all formulae and numerical results. If the reader wishes to use SI units, then the correspondence between the two systems is given in Table C.1.⁴²

Table C.1: I-P and SI Units Compared

	I-P unit	SI unit	Conversion factor I-P to SI
Airflow rate	ft ³ /min (cfm)	m ³ /s	4.71947 × 10 ⁻⁴
Area	ft ²	m ²	0.092903
Density	lb/ft ³	kg/m ³	16.018463
Length	ft	m	0.3048
Pressure	in. of water	Pa	248.84
Speed	mph	m/s	0.447
Temperature	°F	°C	(x°F – 32) / 1.8
		K	(x°F + 459.67) / 1.8

Source: <https://www.ashrae.org/resources--publications/handbook/the-si-guide>.

C.1.1.1 Flow Through Large, Intentional Openings

Independent of driver (wind or buoyancy), flow through an opening depends on the opening area and geometry and also the pressure differential across the opening (ASHRAE, 2013).

$$Q = 776C_D A \sqrt{2\Delta p / \rho} \tag{1}$$

In this formula:

Q = airflow rate (ft³/min or cfm)

C_D = discharge coefficient for opening (–). Depends on opening geometry and airflow characteristics (turbulent or laminar flow)

A = cross-sectional area of opening (ft²)

Δp = pressure difference across opening (in. of water). For buildings, this is the difference between exterior pressure and interior space pressure.

ρ = density of air (lb/ft³). This is typically assumed to be a constant.

⁴² Note that the numerical coefficients in Equations (1)-(3) result from the choice of I-P units; if SI units are used on both sides of a given equation, the coefficient becomes equal to one.

C.1.1.2 Wind-Driven Ventilation

Wind generates pressures on building façade elements. Generally speaking, the windward sides of buildings are under a positive pressure and the other sides are under negative pressure.

Figure C.1 demonstrates this case.

Figure C.1: Wind-Driven Pressures on a Simple Volume

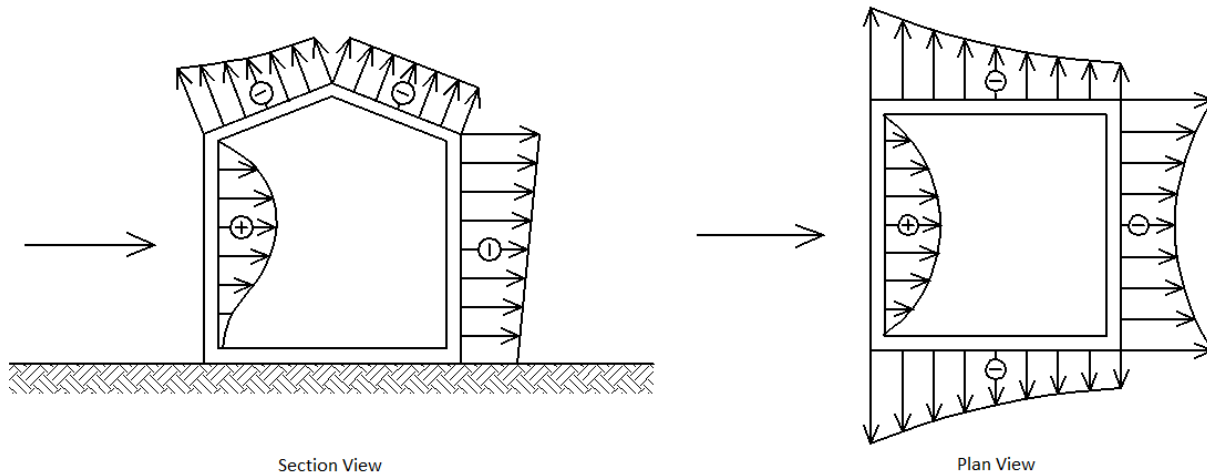

Image Credit: CIBSE BSG Seminar: Natural and Mixed-Mode Ventilation Modelling. Prof. Hazim Awbi, Technologies for Sustainable Built Environments Centre, University of Reading, UK. 5/9/2010.

The equation for flow through ventilation inlet openings by wind, (ASHRAE, 2013), is

$$Q = 88C_vAU \quad (2)$$

In this formula:

Q = airflow rate (ft³/min or cfm)

C_v = opening effectiveness (—). Value is in the range 0 to 1 (rather than 0 to 100%).

A = free area of inlet opening(s) (ft²)

U = wind speed (mph)

Airflow rate depends on opening effectiveness, opening area and wind velocity. Opening effectiveness is higher for perpendicular winds than for diagonal winds.

Strategic location and sizing of building openings can greatly influence the effectiveness of wind-driven ventilation. Figure C.2 shows two cases where inlet and outlet openings not equally sized. The figure on the left has a smaller opening on the windward side. The streamlines show that velocity in front of the inlet opening and average room velocity is relatively high, and stagnant air is seen in the windward corners. The figure on the right shows the openings flipped so that the larger opening is on the windward side. The streamlines indicate a more uniform, low velocity airflow pattern – typically a better scenario for occupants.

Figure C.2: Effect of Unequal Opening Sizes

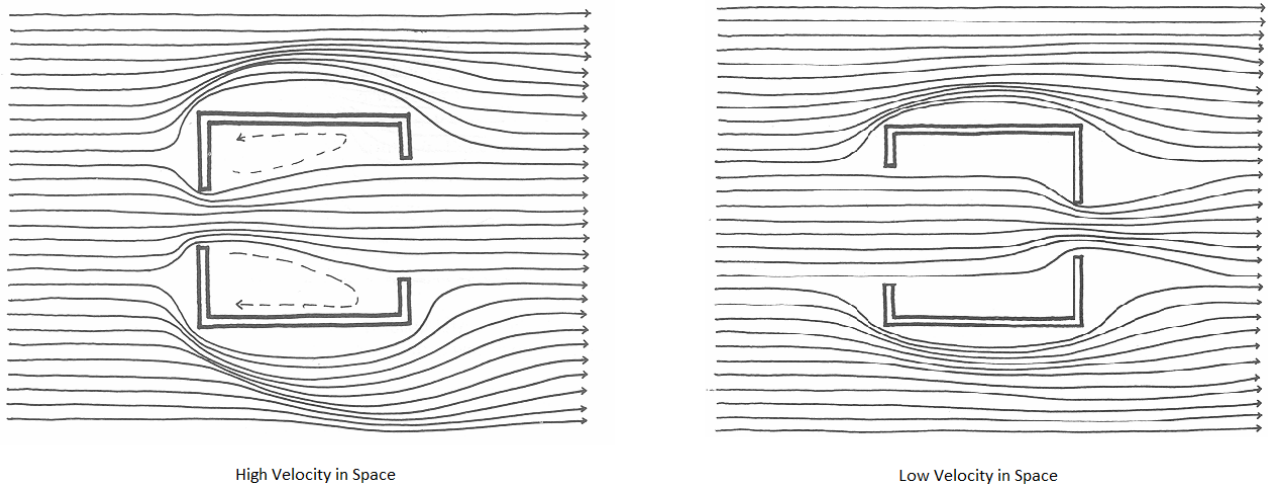

Image Credit: Mechanical and Electrical Equipment for Buildings, 8th Ed. Stein, Benjamin; Reynolds, John S. published by Wiley Hardcover, December, 1991.

Figure C.3 illustrates how building features (in this case fins) can be incorporated to encourage or discourage air flow. The first two sketches show that both positive and negative pressures can be generated in a space with only one external wall.

Figure C.3: Effect of Fins on Wind-Driven Ventilation

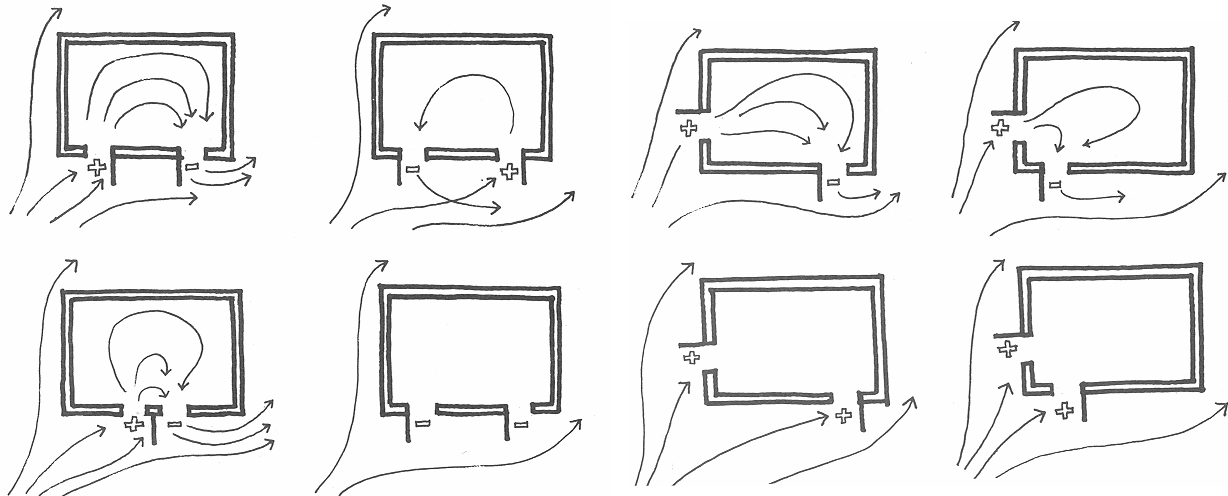
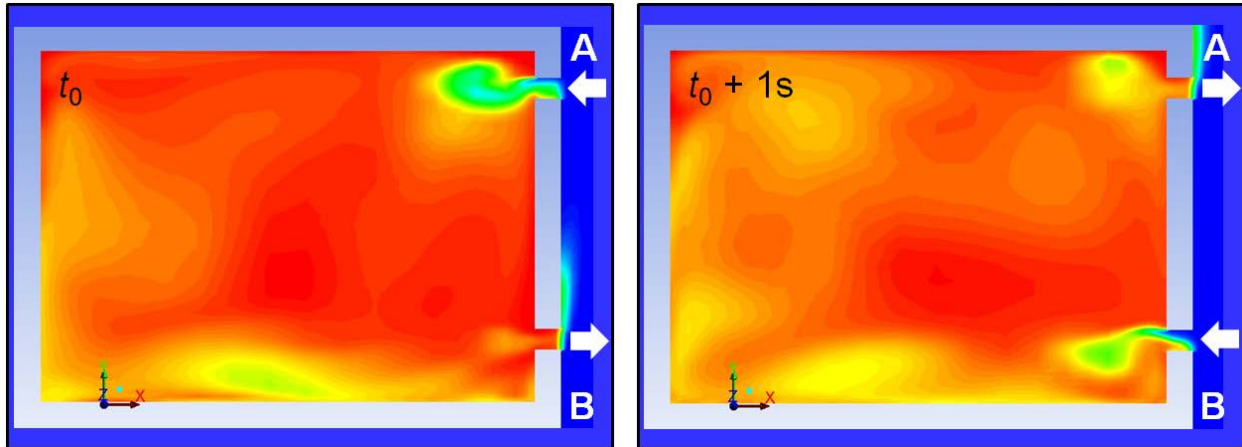

Image Credit: Mechanical and Electrical Equipment for Buildings, 8th Ed. Stein, Benjamin; Reynolds, John S. published by Wiley Hardcover, December, 1991.

Recent research has indicated that fins or other features are not necessary to generate single-sided, wind-driven ventilation. An unsteady phenomenon we will call “pulsing” can occur when a room contains more than one opening on the leeward side of a building. This is illustrated in Figure C.4, which shows output from a CFD simulation of single-sided ventilation for a room with two identical openings, A and B. The wind blows from left to right. In the left-

hand figure, at some initial time t_0 , the interaction of the wind with the building causes the pressure to be higher at A than at B, resulting in an inflow at A and outflow at B. In the right-hand figure, showing the room one second later, B now has the higher pressure and the flow direction is reversed, in a demonstration that unsteady pressure differences across one side of a building can drive single-sided, wind-driven natural ventilation.

Figure C.4: Single-Sided “Pulsing” Mode of Wind-Driven Ventilation



Two snapshots from a transient CFD simulation of a single sided ventilation flow, showing a horizontal section through the room. The wind blows from left to right, so that both openings are on the leeward side of the building (not shown). In the left-hand plot, the flow at time t_0 enters through A, while 1s later the flow enters through B.

Image Credit: Nick Daish (UC, San Diego).

C.1.1.3 Stack-Driven Ventilation

Thermally-driven (stack-driven), airflow depends on opening effectiveness, opening area, height between opening(s) and Neutral Pressure Level (NPL), and difference between indoor and outdoor temperature. The equation for airflow rate is as follows:

$$Q = 60C_D A \sqrt{2g\Delta H_{NPL} |T_i - T_o| / T_i} \quad (3)$$

In this formula:

Q = airflow rate (ft³/min or cfm)

C_D = discharge coefficient for opening (—).

A = cross-sectional area of opening (ft²)

ΔH_{NPL} = height from midpoint of lower opening to NPL (ft)

T_i = indoor air (dry bulb) temperature (°R, where °R = °F + 459.67)

T_o = outdoor air (dry bulb) temperature (°R, where °R = °F + 459.67)

and use of the modulus sign $|\dots|$ covers both cases $T_i > T_o$ and $T_i < T_o$.

This equation assumes the absence of wind pressure; minimal internal obstacles that might otherwise present resistance to airflow; and equally sized inlet and outlet openings. It can be used for non-equal openings if the smaller of the inlet/outlet openings is used for the opening area, A , and a multiplier is used.

The NPL is defined as the height at which internal and external pressures are equal. The NPL tends to fall within the middle third of tall spaces or buildings.

For situations where a single opening in an envelope accounts for at least 90% of the openings, then the NPL is assumed to be at the mid-height of that opening and flow through the opening is bi-directional. Cool air flows through the bottom in one direction and warm air flows through the top in the opposite direction. Some mixing happens within the opening and the discharge coefficient, C_D , becomes a function (only) of the indoor-outdoor temperature difference, $(T_i - T_o)$.

Buoyancy-driven ventilation can operate when no wind pressure is available and can also operate in deep plan buildings where the distance from openings in the perimeter, and the presence of partitions, make wind-driven cross ventilation impractical.

C.1.1.4 Wind and Buoyancy

Wind and buoyancy can complement each other. Torcellini *et al.* (2006) recommend designing natural ventilation systems to rely primarily on stack effect unless wind direction and speeds are reliable. This was a lesson learned in one example of a building in the UK, designed to take advantage of prevailing winds from a single direction: in the actual microclimate, the winds frequently varied in direction, resulting in a system with limited functionality.

C.1.1.5 Wind, Buoyancy and Solar Energy

The Inland Revenue building in Nottingham is home to the UK's equivalent of the IRS (Figure C.5). It incorporates natural ventilation with other passive design strategies. The stair towers are used for circulation and as chimneys. During still, sunny days the sun heats up the stairs and initiates the buoyant pull of air. The air leaving the operable chimney "hat" induces flow from the office level façade across the open office, where it picks up internal building heat gains. The third floor incorporates high ceilings to promote local buoyancy. This was necessary as the stack effect of the stair tower was not enough to pull air across the third floor. During windy days the hat and high ceiling on the third floor see negative pressure which assists with wind-driven, cross flow ventilation.

Figure C.5: Inland Revenue Building: Modes of Natural Ventilation

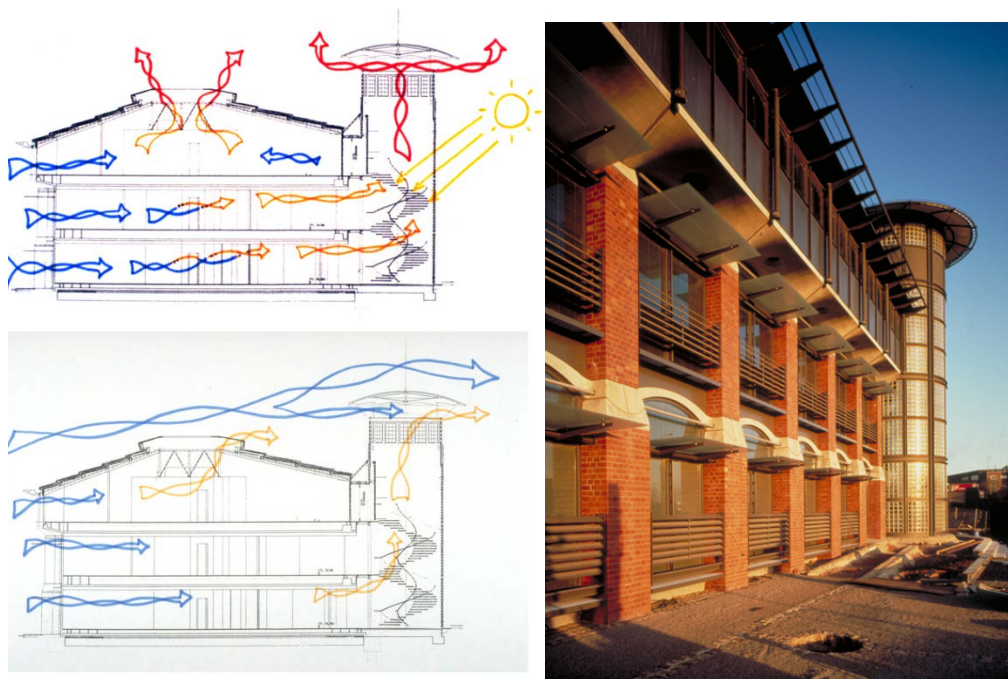

Image Credit: ARUP

The wind speed and direction is typically very variable. Openings must be controllable to cover the wide range of required ventilation rates and the wide range of wind speeds. Naturally ventilated buildings include operable façade elements that are actively configured, by the operator or through building automation systems, to optimize building energy and comfort performance.

C.1.1.6 Benefits

The benefits of natural ventilation as an alternative to mechanical ventilation have been studied and are well-documented. The primary benefit is reduced HVAC energy consumption: natural ventilation can provide energy savings by reducing the use of mechanical ventilation when outside conditions are favorable, or in certain climates, eliminate the need for mechanical cooling. Natural ventilation is also a key component in any sustainability strategy for building design.

C.1.2 Mixed Mode Systems

Often natural ventilation is insufficient to provide adequate ventilation or conditioning for 100% of occupied hours of a building. When this is the case, it may be feasible to complement the natural ventilation system with a mechanical HVAC system. Such hybrid systems are called “Mixed Mode” systems. When external conditions are favorable, the natural ventilation system operates and conserves energy. When conditions are unfavorable for natural ventilation alone, windows close and the mechanical system takes over, or windows remain open and the mechanical system augments natural ventilation. The increased first costs of this best-of-both-

worlds approach should be compared with maintenance costs and energy savings via life cycle cost analyses.

Based on interviews of professionals with commercial building natural ventilation design experience, mixed mode systems combining natural ventilation and mechanical heating are more common than (only) naturally ventilated buildings, since most climates require some heating. While mixed mode buildings are not very common in comparison to mechanically conditioned buildings, they are more common in the UK and Europe in comparison to the US. This is primarily due to a more favorable climate, higher energy costs and a cultural acceptance of higher indoor design temperatures.

There are many systems that could be combined with natural ventilation in a mixed mode fashion. Figure C.6 illustrates a traditional overhead HVAC system operating in tandem with natural ventilation. The air system could provide code minimum ventilation, heating and supplemental cooling. Figure C.7 shows a radiant (cool) slab operating in place of the overhead system. Here the slab could be used for both heating and supplemental cooling, but ventilation requirements would need to be met via either natural ventilation or a separate mechanical system.

Figure C.6: Mixed Mode System: Natural Ventilation With Overhead HVAC

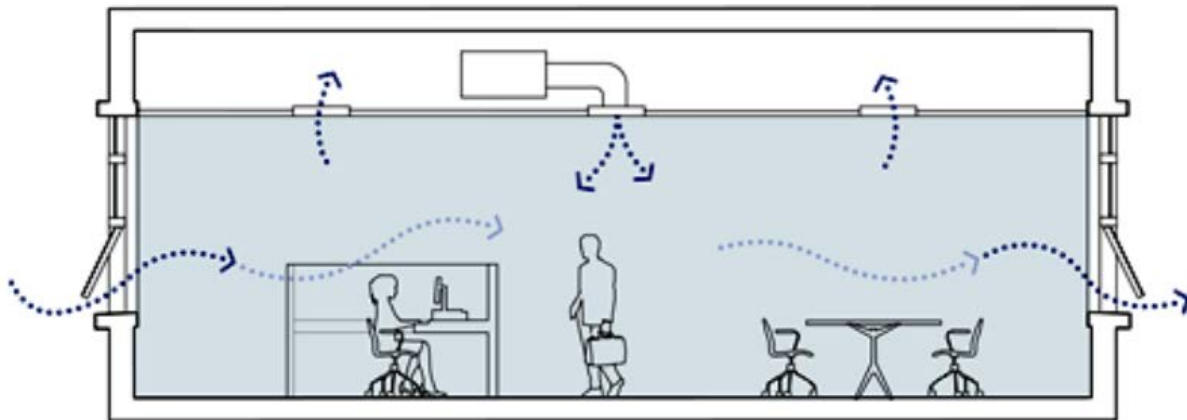

Image Credit: Center for the Built Environment (CBE). University of California, Berkeley.

Figure C.7: Radiant Slab System

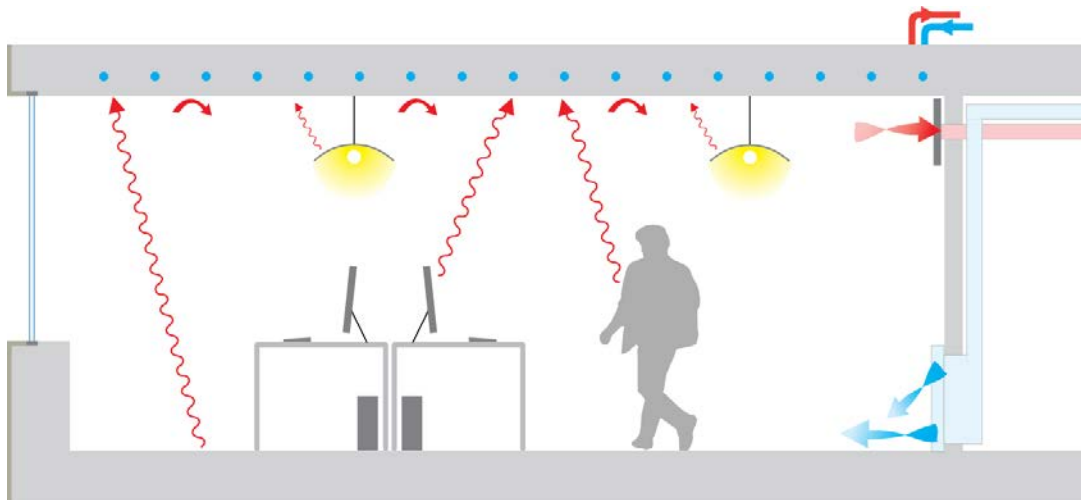

Image Credit: Center for the Built Environment (CBE). University of California, Berkeley.

C.1.3 California Specificity

Emmerich *et al.* (2001), reporting on work sponsored by the California Energy Commission, specifically addressed application of natural ventilation for commercial buildings in California. Opportunities and issues related to climate suitability, ambient air quality, and relevant codes and standards were addressed.

The report presented a ventilation cooling metric for evaluating natural ventilation potential based on climate suitability. This tool was used to evaluate the climates of ten cities in California. The study found that the majority of the coastal climates were well suited for natural ventilation, and that the hotter and more humid inland climates showed less potential. However, benefits from natural ventilation were still predicted for inland areas, especially if coupled with a hybrid mechanical system.

Although this Guide is sponsored by the California Energy Commission, it is not so site-specific to preclude application to other climates and geographical locations.

C.2 Site Considerations and Planning

C.2.1 Climate

Building location will play a large role in deciding if natural ventilation is an appropriate design alternative (Figure C.8). Natural ventilation systems are not suited for all climates, as a hot and humid climate (such as the Southeast US) or a cold climate (North US) will have a very short natural ventilation season. A temperate climate (such as along the West Coast) will have a longer window for when natural ventilation is effective. The longer the window for natural ventilation use, the more energy savings can be realized.

McConahey (2008) proposed a “top 10” checklist of factors affecting natural ventilation feasibility, which suggested climates with the following characteristics would lend themselves

to natural ventilation: (1) at least six months where the monthly maximum is less than 80°F but mean minimum is higher than 32°F; (2) “frequency of occurrence” plot psychrometric chart where more than 30% of the occupied hours fall between 60°F and 80°F but less than 70% relative humidity; (3) the diurnal temperature swing on the summer design day results in at least 8 night-time hours below 65°F for the summer design day; and (4) the outside air dew point temperature consistently below 64°F . It also suggests that exposed thermal mass be considered for climates where outside air temperatures exceed 80°F.

There are many HVAC analysis software packages that can be used to help decide upon preliminary natural ventilation feasibility. These programs include or accept weather files, which are available for many US cities.

Accessing weather data is relatively easy. NREL has Typical Mean Year (TMY3) data sets from 1020 US locations and the National Solar Radiation Data Base (NSRDB) includes solar and meteorological data for 1454 stations.⁴³

Figure C.9 is a psychrometric chart - a common tool for HVAC engineers. A single data point represents seven properties of air: dry bulb temperature, wet bulb temperature, dewpoint temperature, relative humidity, humidity ratio, enthalpy, and specific volume. This particular chart has overlays representing comfortable conditions as defined for mechanically-conditioned spaces by ASHRAE’s Standard 55. When populated with a particular location weather data, it becomes apparent which passive conditioning options may be appropriate. Locations with data falling primarily within the “natural ventilation” boundary and to the left would be good candidates for natural ventilation. If the building incorporated exposed thermal mass, then locations showing data points extending into “thermal mass” overlay might also be good candidates.

⁴³ See ASHRAE (2013), Chapter 14, *Climatic Design Information*. Data sets are available through http://rredc.nrel.gov/solar/old_data/nsrdb/1991-2005/tmy3/ and http://rredc.nrel.gov/solar/old_data/nsrdb/, respectively.

Figure C.8: US Climate Map

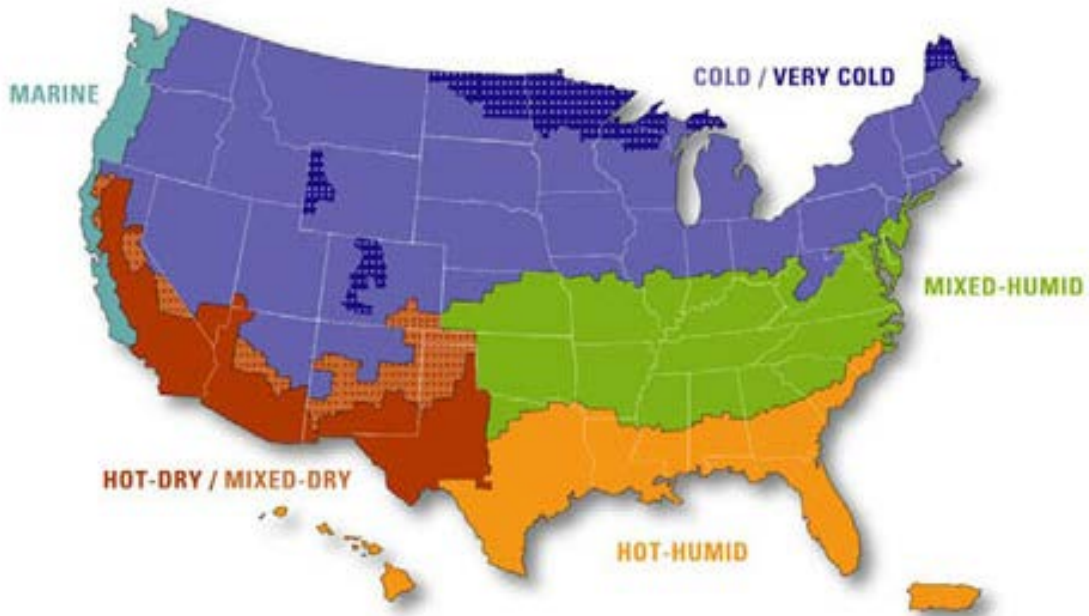

Image Credit: US Department of Energy. Energy Efficiency and Renewable Energy (via AIA, The Carbon Neutral Design Project).

Figure C.9: Psychrometric Chart for Various Passive Conditioning Measures

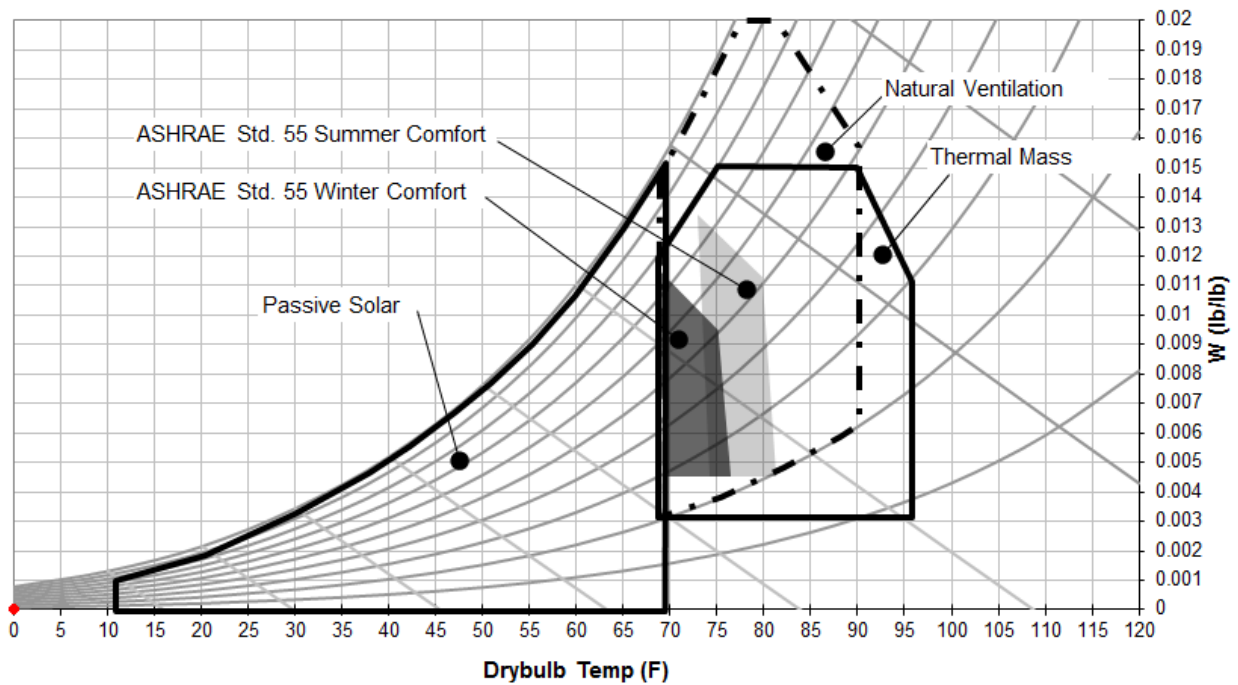

Image Credit: *Adapted from Victor Olgyay, Design with Climate: Bioclimatic Approach to Architectural Regionalism, Copyright 1963, Princeton University Press.

C.2.2 Wind

Wind speed and direction are included in weather data files and can be presented in the form of a wind rose (Figure C.10). The length of the “petals” represents the fraction of the year the wind occurs from a particular compass direction. The concentric bands within each petal represent the distribution of wind speeds for that direction, increasing in speed from the center outward. Separate wind roses can be generated to compare seasonal winds. In Figure C.10, the dominant winds are from the North-Northwest. Evenly-distributed rose petals of equal lengths with large 0-2 mph bands means that there is no prevailing wind direction and that winds are light and variable in direction throughout the year. This would not be ideal for wind-driven natural ventilation schemes.

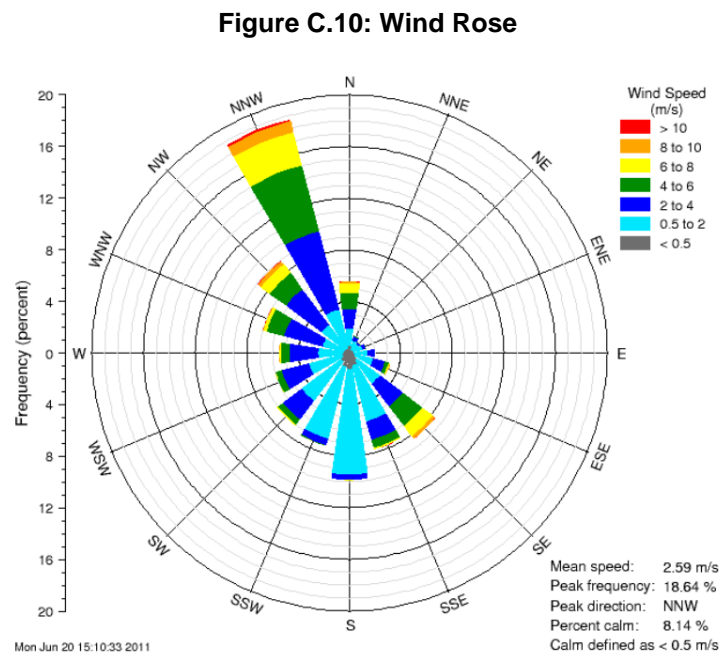

Image Credit: United States Department of the Interior. US Geological Survey (USGS) Data Grapher, Oregon Water Science Center

C.2.3 Local Topography and Microclimates

Variations in local topography can have a great influence on a site microclimate, particularly with respect to wind speed and direction, but also with respect to temperature. For example, bodies of water and organic ground cover on the windward side of a building will cool air and increase its moisture level, while large, unshaded asphalt parking lots and other man-made surfaces will increase air temperature. Hills and upwind bodies of water tend to increase wind speed, while urban surroundings and forests tend to decrease average wind speed. Despite having lower average wind speeds, urban sites tend to have a greater variation of local wind speeds due to configuration and organization of buildings, e.g. high-rise buildings tend to channel wind (Figure C.11).

Figure C.11: Computational Fluid Dynamics (CFD) Model of a Microclimate

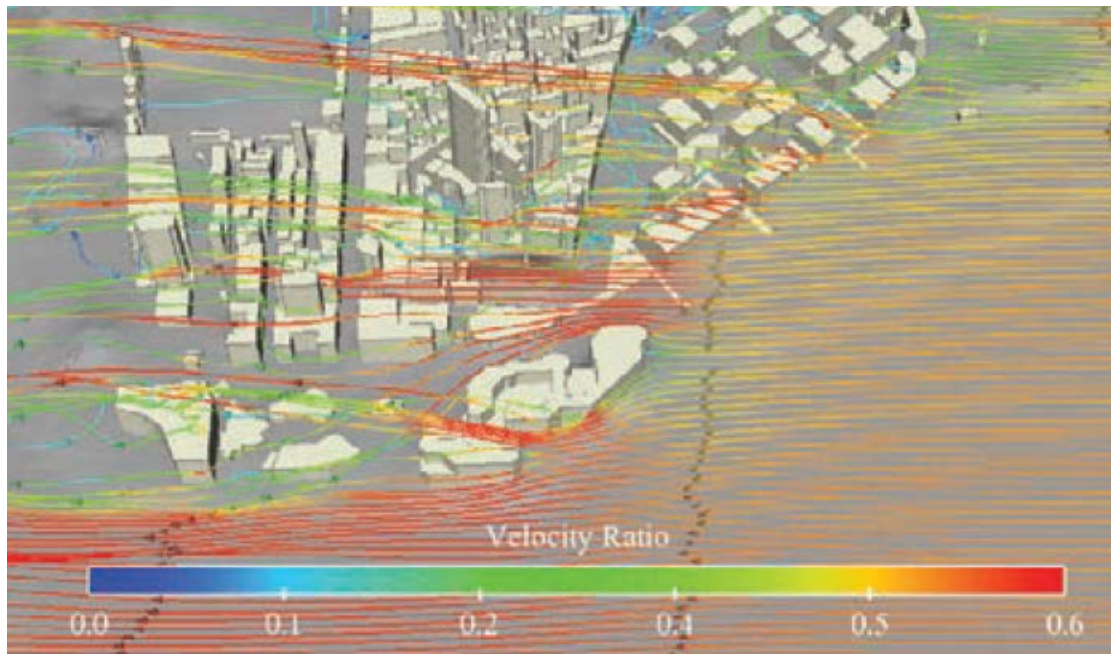

Image Credit: ARUP

When weather data are not available for a particular location, or when the nearest weather station happens to be an airport and not typical of the local topography, it may be best to install a weather station, log data and use the logged data for analysis. If this is not possible, then manipulation of the nearby weather station data would be necessary.

C.2.4 Odors and Pollutants

Natural ventilation systems do not have the ability to remove odors and pollutants like well-filtered mechanical ventilation systems, so logic suggests it might not make sense to naturally ventilate a building located next to a manufacturing plant, refinery or donut factory (unless you really like the smell of donuts).

In order to determine the healthfulness of ambient (outdoor) air quality at locations within the State of California, designers can refer to the California Air Resource Board (ARB). The ARB establishes State ambient air quality standards identifying safe outdoor pollutant levels and designates each geographical area as attainment, nonattainment, or unclassified for each pollutant. The US Environmental Protection Agency does the same on a national level. A building in a non-attainment area might not be a good candidate for natural ventilation

To determine acceptable limits of pollutants within the workspace, designers can refer to the Occupational Safety & Health Association (OSHA) and ASHRAE 62. The former regulates air quality in the workplace and the latter references the former in the context of ventilation and filtration.

In contrast with weather data, pollutant data are generalized over a region and not derived from one specific location. So a survey of the locale would be useful to determine if there are any nearby pollutant or odor sources.

Mixed mode systems incorporating natural ventilation may be viable alternatives for locations where ambient pollutant levels vary during the day, such as buildings in urban areas or next to major roadways.

C.2.5 Building Massing

Building size and form impacts both wind and buoyancy pressures and, consequently, natural ventilation flows.

C.2.5.1 Depth

Building depth influences both feasibility and type of natural ventilation used. A narrow building section can be a good candidate for either cross-flow and/or single-sided ventilation. Where the section is split by a corridor, cross flow ventilation might still work, but requires some engineering of transfer openings and/or ducts to make this possible. At the very least, a corridor-split section might be a good candidate for single-sided natural ventilation.

As the floor plate gets deeper, the potential for natural ventilation decreases. In a cross-flow mode, the cool outside air enters the building on one side, picking up heat gains as it moves across the depth. At some point before it reaches the other side of the building, the flowing air becomes uncomfortably warm. A similar scenario happens as the depth of a single-side ventilated room gets deeper. Warmer room air exits through the high level opening(s), causing cooler outside air to enter the lower opening. In a deep room, the cool air moving along the floor heats up before it can reach the inner depths of the room, rendering an area of low air exchange and high temperatures.

For single sided ventilation, CIBSE (2005) in the UK recommends a maximum depth-to-height ratio of 2.0 for rooms with a single opening and 2.5 for rooms with high and low openings separated by at least 1.5 meters (5 feet). For cross-flow ventilation CIBSE recommends not exceeding a depth-to-height ratio of 5.0. In this case, the acceptable depth for a room with a 10 foot ceiling would be less than 50 feet. An 8 foot ceiling would reduce the acceptable depth to 40 feet. These ratios were derived through real world experience and incorporated in UK-based standards and guides to provide designers with a reputable reference and basis for designing naturally ventilated buildings.

The US design and construction industry is code driven. ASHRAE Standard 62.1 is the basis of most US local mechanical codes. It limits the depth of naturally ventilated spaces to 20 feet (or 25 feet in the case of a hotel room). Table C.2 compares CIBSE, ASHRAE and California Mechanical and Energy Code recommendations and requirements.

Table C.2: Natural Ventilation – Acceptable Room Depths

Ventilation Type	CIBSE			ASHRAE	California
	General case	8 ft. ceiling height	10 ft. ceiling height		
Single-Sided	$D \leq 2.0 \times H$ if one opening. $D \leq 2.5 \times H$ if high & low level openings spaced at 1.5m (5 ft.) or more.	$D \leq 16$ ft. $D \leq 20$ ft.	$D \leq 20$ ft. $D \leq 25$ ft.	$D \leq 25$ ft. (hotel) $D \leq 20$ ft. (others)	$D \leq 20$ ft.
Cross-flow	$D \leq 5.0 \times H$	$D \leq 40$ ft.	$D \leq 50$ ft.	$D \leq (2 \times 20$ ft.), i.e. $D \leq 40$ ft.	$D \leq (2 \times 20$ ft.), i.e. $D \leq 40$ ft.

Courtyards, atria, shafts, wings or fingers can break up building depth and make natural ventilation feasible. The drawback is that these features typically lead to a larger overall footprint and present more envelope surface area. Both tend to increase building material costs.

Internal partitions pose a significant challenge to ventilating deep into the floor plate. For example, a traditional perimeter-and-core zoning scheme for many office buildings, with the private offices along the perimeter and open offices at the core tends to limit the potential naturally ventilated section to the depth of the perimeter office, typically less than fifteen feet.

C.2.5.2 Height

Taller buildings can use buoyancy to promote natural ventilation. Single sided ventilation may prove to have limited application as buildings get taller, since warmed air leaving high-level openings tends to rise up the façade and enter the low-level inlets of the floor above. This can repeat itself up the face of a building, particularly if there is no wind to dissipate the plume of warm air.

Also, high rise buildings usually require smoke control systems, which can lead to Code-based limitations on natural ventilation systems.

C.2.6 Building Orientation

It is important to orient the building to take advantage of the prevailing winds. A long, narrow floor plate orientated perpendicular to the prevailing winds will have significantly higher ventilation potential than the same one rotated 90 degrees. However, the designer will have to consider both wind and sun. The latter can be best controlled when the building long façades face north and south.

C.2.7 Climate Change

Climate change is the long-term change in the statistical distribution of weather patterns over time. Passive strategies such as natural ventilation are designed for the local climate; i.e. they

will operate successfully only within a range of specific climate conditions, such as temperatures, winds, etc. As climate change alters the ambient conditions, natural ventilation may become a less effective passive cooling strategy. Codes providing for operable window areas or determining acceptable indoor air temperatures will need to be re-evaluated against the changing ambient conditions and existing naturally ventilated buildings will need to develop adaptation strategies.

C.3 Envelope and Loads

C.3.1 Building Envelope

The building envelope allows heat transfer via convection, conduction and radiation. In commercial buildings the radiation component (solar gains) typically dominates the equation. The most effective methods of reducing solar gains and maximizing natural ventilation opportunity are to limit glazed window area, choose its location carefully, and incorporate high-performance glass and external shading.

Of course, such measures can and often do conflict with aesthetic goals. Site constraints and building orientation might not lend themselves to north and south-facing glass where sun angles can be controlled. Daylight and views are drivers for increased window area and clear glass. Shading devices cost money, are often seen as obstacles to window washing, and greatly influence the look of a building.

C.3.1.1 Glazing location

Glazing should be concentrated on the north and south sides of buildings to minimize uncontrollable solar heat gains. South facing glass can be coupled with overhangs to reduce solar gains when the sun is high in the summer and allow gains when the sun is low in the winter. Vertical fins can be incorporated to further reduce gains. North facing glass will only be exposed to direct sun around sunrise and sunset, at the height of summer. East and West glass should be minimized, although if summer night-time temperatures require heating in the morning, east facing glass can help warm the space. West facing glass is to be avoided because afternoon solar gains combine with peak daily temperatures and highest thermal mass temperatures.

C.3.1.2 Specifying Glazing

Glass with a low Solar Heat Gain Coefficient (SHGC) will help minimize solar gain. The SHGC represents the fraction of incident solar radiation that is allowed through the glazing system as heat. In Figure C.12, three types of double-paned (or “insulating”) glass are depicted. The image on the left represents clear glass with a SHGC of 0.70 and visible-light transmittance (VT) of 0.79. The middle image incorporates a tinted outside pane: its SHGC and VT are lower (0.50 and 0.48, respectively), which means less solar gain and less light. The right image depicts a clear system with a low-emissivity (Low-E) coating on the inside of the outer pane, which reflects heat gain, but allows light to pass, resulting in an SHGC of 0.27 and a VT of 0.69. Low-E glasses are typically a good compromise between limiting solar gains and maximizing views and daylight but, depending on the situation, may not be enough to permit natural ventilation.

C.3.1.3 Switchable Windows

Switchable windows have electrochromic or gasochromic window coatings that can be changed in response to the incident sun or other, non-environmental driver. These “smart” windows do not yet have a large market primarily due to cost and aesthetics, but both parameters are improving with research.

Figure C.12: Impact of Solar Heat Gain Coefficient

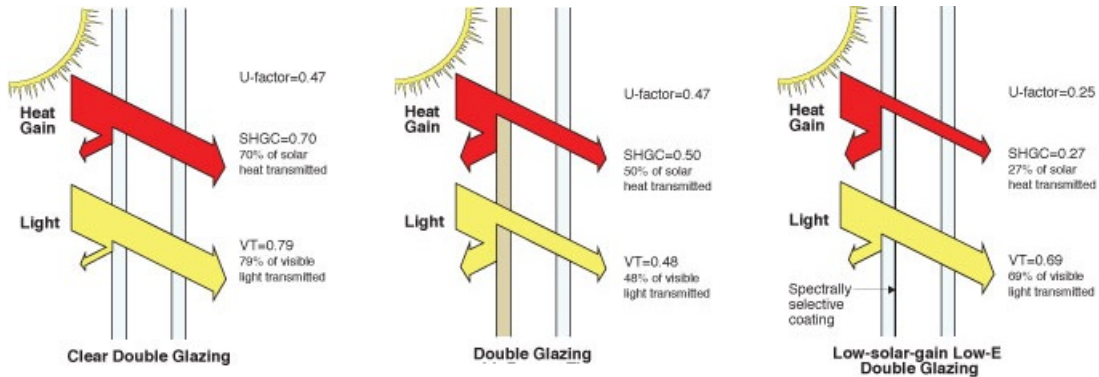

Image Credit: Copyright © 2011 Regents of the University of Minnesota, Twin Cities Campus, College of Design, Center for Sustainable Building Research. All rights reserved. <http://www.commercialwindows.org/dynamic.php>

C.3.1.4 Double-Skin Facades

By adding a second skin to the façade, an air space is created. Assuming both skins have operable windows or openings, these openings can be adjusted to either trap or release heat from the air space. On a sunny day, low and high windows on the exterior skin could be opened to dissipate heat and allow for natural ventilation. On a cold winter day, openings in both skins would be closed (or minimized if the only source of ventilation) to trap heat from the indoors and/or sun. Like natural ventilation, design and engineering of such a system can be more complicated than a typical building envelope. It can also represent a significant first cost and maintenance issues.

C.3.2 Internal Heat Gains

Heat gains generated by people and objects within the building are considered “internal” gains, and add to envelope heat gains and losses (Figure C.13). A big part of the internal gains occurs at the façade. Reducing the heat gains through the façade requires that the glazing is reduced, or in the right areas, and that shading is provided and often the architect / owner has not incorporated these into the building aesthetics. McConahey (2008) suggests the limit of total internal heat loads be minimized to less than 2 W/ft².

Figure C.13: Modes of Heat Transfer

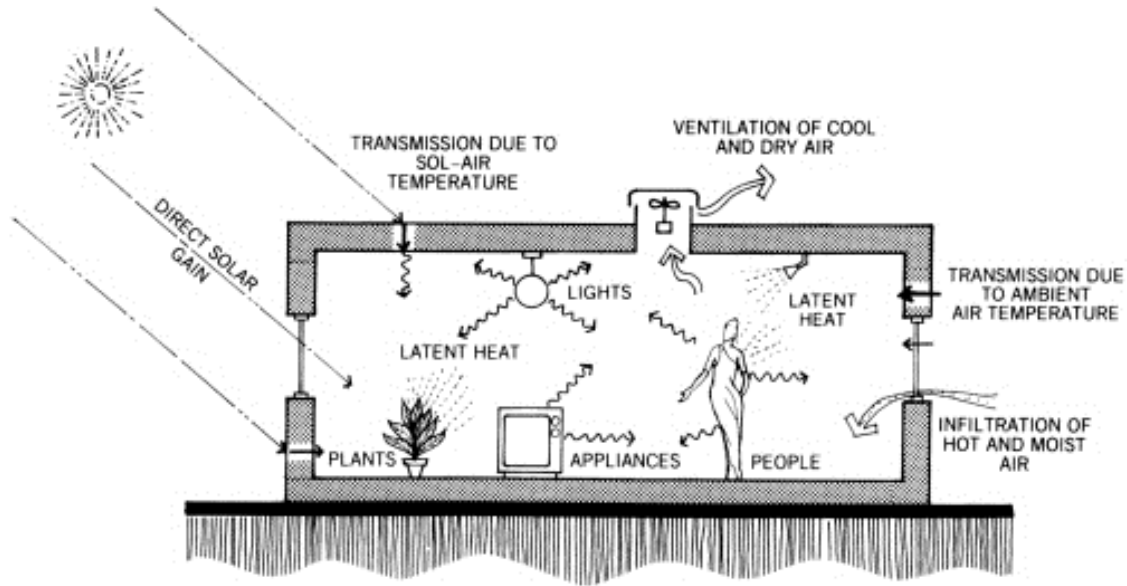

Image Credit: Mechanical and Electrical Equipment for Buildings, 8th Ed. Stein, Benjamin; Reynolds, John S. published by Wiley Hardcover, December, 1991.

C.3.3 Openings

NREL recommends that supply and relief openings be separated from the fenestration and utilize typical HVAC control dampers in lieu of motorized or manual windows. The recommendation of separation considers the negative impacts that enlarged frames for operable windows and their associated screens have on daylighting. The recommendation for control dampers derives from the improved ability for interface with the mechanical controls system and their observed increased robustness over motorized window actuators (Torcellini *et al.*, 2006).

C.4 Analysis and Available Tools

Mechanically ventilated and conditioned spaces are decoupled from the uncontrolled exterior environment via sealed façades. Engineers are able to easily prescribe mechanical HVAC systems to condition the interior spaces, and as long as the HVAC systems meet the design cooling, heating and ventilation parameters, variations in the exterior environment do not affect the comfort and health of building occupants.

Conversely, naturally ventilated buildings remove the controlled separation between outside and inside; adding a number of new variables to consider during design.

The decreased level of control and additional design variables make natural ventilation systems inherently more difficult to design. Special analysis tools are required to size and locate window openings, account for stack and wind effects, assure occupants are comfortable, generate optimal control sequences and determine energy savings and life cycle costs.

C.4.1 Analysis

Static pressures over the entire building envelope combine with windward dynamic pressures and indoor (space) pressure coefficients to drive natural ventilation. Wind pressure distribution data over simple building shapes are available in many publications; the dynamic pressure on the windward side of buildings is dependent on the building porosity (ratio of area of wall openings to area of walls); and indoor pressure coefficients influence the route and velocity of air within the building. To illustrate the impact of wind direction and window opening locations on indoor flow, a cross-ventilated space with perpendicular (normal) angle of wind incidence leads to an interior pressure coefficient of around 0.6, but a wind with an off-normal angle of incidence, or an internal breeze paths incorporating a sharp turn can lead to a coefficient of around 0.2 (Aynsley, 2007).

For complex building shapes or buildings taller than five stories, three dimensional wind tunnel tests or CFD studies should be performed to estimate interior wind velocities and optimize window placement. The designer should study the breeze patterns for all prevailing wind directions and associated wind speeds, noting the frequencies at which the various combinations occur. Window sizes and location should be adjusted accordingly to achieve optimal performance.

Currently, no one tool is able to provide all of the necessary information to properly evaluate a natural ventilation system from start to finish. Instead a selection of tools is used; each for a given purpose. The design community, comprised of researchers, software developers, equipment manufacturers, professional societies such as ASHRAE, and design professionals themselves have developed a number of tools to aid in the optimization of natural ventilation systems. These tools vary greatly in complexity; from hand calculation methods to computer models that solve simultaneous differential equations and display the results in graphical form. The level of user skill and expertise required to use each tool varies with complexity. Furthermore, tools are case-specific based on the level of design completion. Selecting the correct tool can depend on many factors:

- How much detailed information is known about the variables; can general assumptions be used?
- How much time is available to complete the analysis?
- What are the key aspects that must be considered in the analysis so that the results maintain a necessary level of accuracy?
- Who is performing the analysis?

The ultimate goal is to efficiently analyze the key aspects in enough detail to produce results that are sufficient to inform design decisions.

Tools used to design naturally ventilated buildings can be organized into the following categories based on the design aspect for which they are used:

- Feasibility Assessment Tools: Help in determining whether the building is a good candidate for natural ventilation
- Design & Analysis Tools: Help predict how the natural ventilation system will perform from a ventilation and thermal comfort perspective
- Whole Building Energy Simulation Tools: Predict how much energy the naturally ventilated building will save over a mechanically-ventilated building

The following sections describe tools available to help evaluate feasibility, performance, and energy savings of natural ventilation systems. Capabilities and weaknesses are identified.

C.4.2 Feasibility Assessment Tools

Natural ventilation will not work for every commercial building. An evaluation must take place early on to assess natural ventilation feasibility. From the conceptual stage of design, factors such as the building's form, orientation, location/climate, envelope, and anticipated internal loads must be evaluated to determine if natural ventilation can adequately maintain indoor thermal comfort and indoor air quality requirements.

C.4.2.1 Climate Suitability Tool

The Climate Suitability Tool, proposed in Emmerich *et al.* (2001) and released in May 2011 by NIST, evaluates whether a local climate is suitable for natural ventilation or a hybrid (mixed mode) system.⁴⁴

Climate Suitability Tool is free, web-based software that uses a single-zone model of natural ventilation heat transfer in commercial buildings.⁴⁵ The following information about the building is specified by the user: internal heat gains, area, minimum ventilation rates, limiting outdoor dew point temperature, ceiling height, cooling set point, heating set point and times for when night cooling calculations should be expected to operate. A standard weather file is then selected that describes the local climate. The tool can read weather files in the TMY2, TMY3, and EPW formats. Links to libraries of these files for different geographical locations are provided, but any location can be used so long as the user can obtain a supported weather file.

Once the appropriate weather file and building information has been specified by the user, the program uses an algorithm that analyses the hourly weather data and user specified set points to determine the percentage of time when natural ventilation is effective. The program also considers adaptive set points that vary the thermal comfort acceptability criteria based on ASHRAE Standard 55 Thermal Environmental Conditions for Human Occupancy.

The Climate Suitability Tool presents results for both *direct cooling* and *night cooling* potential. *Direct cooling* is defined as, "the cooling of building interiors by replacing or diluting warm indoor air with cooler outdoor air when conditions are favorable". *Night cooling* is defined as, "indirectly cooling building interiors by pre-cooling thermally massive components of the

⁴⁴ See http://www.nist.gov/public_affairs/tech-beat/tb20110524.cfm.

⁴⁵ See <http://www.bfrl.nist.gov/IAQanalysis/software/CSTdesc.htm>.

building fabric or a thermal storage system with cool night-time outdoor air". For the direct cooling analysis, the tool tells the user how much ventilation is required to sufficiently cool the space and the percentage of hours that natural ventilation can be effective. It also provides the percentage of hours that natural ventilation alone will result in a space that is potentially too cold, too hot, or too humid. For the night cooling analysis, the tool tells the user the average internal gain that may be offset from pre-charging the thermal mass the night before. It also tells the user the number of days that night cooling is required and how effective it is in meeting the cooling demands of the following day.

Key environmental design considerations not accounted for in the Climate Suitability Tool include solar gain at the façade and wind direction (building orientation is not specified in the inputs). A follow-up paper from NIST seems to suggest that solar gains can be accounted for by adding them to the internal loads input. This assumes that the solar load is distributed evenly across the floor plate, which seems potentially problematic for all cases. Also, the orientation of the building is not specified. As this tool is only intended to assess the potential of a particular climate, it is assumed that the tool is calculating the wind pressure coefficients for the optimum case where the building is oriented to take full advantage of available prevailing winds.

C.4.2.2 CoolVent

CoolVent (Menchaca-B. & Glicksman, 2008) was developed by MIT as a simple natural ventilation tool to assist architects at the early design stages. It couples multi-zone airflow and thermal analysis to predict zone temperatures and airflow rates. To simplify user inputs, and to save the user time, it utilizes four pre-defined building types: single-sided ventilation, cross ventilation, central atrium ventilation, and side atrium ventilation. The user is then able to specify parameters including:

- Building type and orientation
- Occupancy heat loads and initial temperature
- Terrain information
- Weather conditions (TMY2 data for ten pre-defined cities only)
- Building Dimensions
- Glazing properties and opening dimensions
- Thermal mass description
- Window control strategies

Once set up, the simulation takes less than a minute to run. The simulation provides zone temperatures and airflows. These are presented to the user in three formats: visualization, data plots, or text file.

The CoolVent team acknowledges the importance of adding the following features to the CoolVent program in future work, and the MIT-based website seems to indicate stratification has recently been incorporated:

- Air stratification within zones
- Closed plan configurations
- Internal radiative heat transfer
- Solar heat loads through roof openings
- Use of thermal mass for night cooling
- Differentiation in openings of different floors (e.g. entry doors)
- Energy consumption information for buildings modeled with natural ventilation; and a comparison against those without natural ventilation
- Usability tests of the software's interface to ensure adoption of the software by the design community.

C.4.3 Design & Analysis Tools

Chapter 13, *Indoor Environmental Modeling*, of ASHRAE (2013) presents two common indoor environmental modeling methods: computational fluid dynamics (CFD) and multi-zone network airflow modeling. ASHRAE provides the mathematical background, practical modeling advice, model validation, and application examples for both methods. Both methods have strengths and weaknesses.

CFD models are *microscopic* in nature, meaning that detailed information concerning air flow and contaminant concentrations within a single space can be obtained. This level of detail can offer valuable information when analyzing spaces where effects such as stratification may need to be well understood (e.g. atria spaces). CFD models are also commonly used to analyze individual building components. Some examples of major CFD software packages include: CFX, STAR-CCM+, and ANSYS FLUENT.

Multi-zone models on the other hand are *macroscopic* in nature. A zone may represent a single space or even multiple spaces. In macroscopic models, air temperature, pressure, and contaminant concentrations are averaged and described by a single node in the air flow network. This simplified approach offers limited information as compared with CFD models, but requires much less detailed information, time to setup and computer simulation time. CONTAM and EnergyPlus are examples of major software packages that provide multi-zone airflow analysis.

One of the major concerns with the accuracy of multi-zone airflow network models is their heavy dependence on flow coefficients, e.g. the wind profile exponent, the pressure coefficient, and the discharge coefficient as required by EnergyPlus (Zhai *et al.*, 2010). Establishing wind pressure profiles has been described as the “magic” of modeling natural ventilation. Some software tools, such as IES <VE>, contain libraries of flow coefficients to help users to make assumptions. Other models, such as EnergyPlus and CONTAM require the user to manually enter these relatively ambiguous coefficients that may be difficult to establish in early design phases where limited information is known about the building.

A further simplified approach to the multi-zone model is the single-zone model where airflow between zones is not considered. This method can save user setup time as considerably less input information is required. This can be a benefit at early stages of design, but has limitations as the natural ventilation system becomes more complicated and a more complex model is required to accurately analyze the system. The Climate Suitability Tool (Section 4.2.1) is an example of a simplified tool that is based on a single zone model. In this tool, the entire building is considered as a single zone with no internal separations.

The majority of tools used to design and analyze natural ventilation systems use the multi-zone model approach. This approach allows designers to evaluate a number of options in enough detail and in a relatively short period of time, as compared to using a single zone model or CFD software, respectively. The COMIS and CONTAM airflow network models are identified to be the most commonly-used tools for natural ventilation design, with similar models incorporated into ESP-r and EnergyPlus. All of these tools use similar versions of the same model (Zhai *et al.*, 2010).

CONTAM and EnergyPlus are the leading software being developed in the US for natural and mixed mode ventilation design and analysis. The open nature of these programs facilitates interaction with other tools. Two examples of software that have been integrated with CONTAM and EnergyPlus are LoopDA and COMFEN, respectively.

C.4.3.1 Loop Design and Analysis (LoopDA)

LoopDA is a software tool, proposed in Emmerich *et al.* (2001), and developed by NIST, that implements the Loop Equation Design Method of sizing openings in naturally ventilated buildings.⁴⁶ This tool has been integrated into the multi-zone airflow model, CONTAM.

The Loop Equation Design Method consists of eight steps:

1. LoopDA provides a SketchPad interface that enables the user to draw a schematic representation of the global geometry and multi-zone topology of the building and to draw the natural ventilation flow loops through the relevant airflow paths of the building.
2. The SketchPad provides the ambient pressure node and keeps track of the pressure nodes associated with each of the airflow paths that the user identifies on the SketchPad. The direction in which the user draws the loops establishes the intended direction of natural ventilation airflow for the purposes of design.
3. LoopDA provides for the establishment of design conditions by allowing the user full control in setting ambient conditions of temperature, wind speed and direction. It also enables the user to set the design temperatures of all airflow paths and automatically calculates the air densities of each. The program also provides a means to input the wind pressure coefficient of all exterior openings.

⁴⁶ See <http://www.bfrl.nist.gov/IAQanalysis/software/LOOPDAdesc.htm>.

4. LoopDA provides a means for the user to define the first-order design criteria for each airflow path to be sized; however, it is up to the user to select the design criteria and to ensure continuity is not violated in the event that an opening serves multiple flow loops.
5. Once the user has established the geometry, design conditions, and criteria, and drawn the flow/pressure loops, LoopDA will form the forward loop equations for each loop by traversing the loop in the established direction and accounting for pressure changes due to the pressure/flow relationships of the various flow components, wind and stack effects.
6. LoopDA calculates the minimum feasible sizes of each un-sized flow component in a loop by evaluating asymptotic limits of the loop equation for the design conditions.
7. LoopDA provides the ability to export loop information to a spreadsheet template (provided with the program) that displays all the data associated with a given loop, generates asymptotic plots and thus provides a means to view relationships between the flow components of a loop. This aids the application of design constraints, selection of component sizes and documentation of the steps in designing the natural ventilation airflow paths.
8. Having sized the natural ventilation airflow, the user can then utilize LoopDA to analyze the building performance under varying conditions. LoopDA implements the established multi-zone building simulation capabilities of CONTAMW 2.0. The user performs analysis to investigate the effects of unintentional air infiltration, non-design weather conditions, and forced-flow elements to simulate mixed mode ventilation systems.

LoopDA can account for both wind and stack effects to help designers to size flow components, evaluate the natural ventilation system performance under varying conditions, and evaluate hybrid ventilation systems. One complexity of this tool is the requirement of user-supplied wind pressure coefficients for all of the exterior openings. These may be difficult to establish, especially early in design.

Once the natural ventilation system airflow strategy has been defined using LoopDA, CONTAM can be linked to the thermal analysis tool TRNSYS to complete coupled thermal and airflow analysis. This dynamic model can then be analyzed to evaluate annual energy savings due to the implementation of natural ventilation. This linking process is discussed further in Section 4.4, below.

C.4.3.2 COMFEN

The Commercial Fenestration (COMFEN) tool was developed by Lawrence Berkeley National Laboratory (LBNL) to help designers quickly assess different façade options.⁴⁷ COMFEN allows users to compare up to four multiple façade types at once and to quantify their impacts on energy consumption, peak energy demand, and thermal and visual comfort. The program contains libraries of different geographic locations, glazing systems, and shading control schemes. The simulation calculates solar loads on the space as a result of the façade

⁴⁷ See <http://windows.lbl.gov/software/comfen/comfen.html>.

construction. This information helps designers minimize unwanted solar gain through the façade, a key design feature for successful natural ventilation systems (McConahey, 2008). The most recent release of COMFEN (2013) includes the ability to simulate single-zone, single-sided natural ventilation via EnergyPlus version 7.2.

C.4.4 Whole Building Energy Simulation Tools

There are few sources for comparing energy analysis programs, but one written in 2005 compares the features and capabilities of twenty (20) of the major building energy simulation programs. As of press time, 18 of the 20 programs were still listed on the US Department of Energy's Building Energy Software Tools Directory (Crawley *et al.* 2005).⁴⁸ One of the matrices provided in the report classifies the ability of the twenty programs to handle infiltration, ventilation, room air and multi-zone airflow. Of the modeling capabilities evaluated, the following are directly related to modeling natural ventilation systems:

- Automatic Calculation of Wind Pressure Coefficients
- Natural Ventilation
- Hybrid Natural and Mechanical Ventilation
- Window Opening for Natural Ventilation Controllable
- Multi-zone Airflow (via Pressure Network Model)
- At the time of the report only two programs, TAS and IES <VE>, both popularly used in Europe, were rated as having these capabilities available and in common use.

C.4.4.1 Building Energy Software Tools Directory

With new developments being made constantly, it can be challenging to keep current with the latest software and modeling programs. The Building Energy Software Tools Directory is maintained by the US Department of Energy and provides an extensive, searchable list of available software tools for evaluating building systems and energy use.⁴⁹

This directory provides information on 410 building software tools for evaluating energy efficiency, renewable energy, and sustainability in buildings. The energy tools listed in this directory include databases, spreadsheets, component and systems analyses, and whole-building energy performance simulation programs. A short description is provided for each tool along with other information including expertise required, users, audience, input, output, computer platforms, programming language, strengths, weaknesses, technical contact, and availability.

⁴⁸ Original report available at http://sbi.dk/download/bsim/contrasting_the_capabilities_of_building_energy_performance_simulation_programs_v1.0.pdf, and in abbreviated form in *Building and Environment* **43(4)**, 661-673 (April, 2008).

⁴⁹ See http://apps1.eere.energy.gov/buildings/tools_directory/.

C.4.4.2 EnergyPlus

EnergyPlus is a next generation building energy simulation program that combines the most popular features and capabilities of BLAST and DOE-2. This simulation engine is capable of producing accurate, detailed simulations and has been extensively tested. Its input and output files allow for third party interface development. The previous text format of the software inputs was considered its major weakness, and a user-friendly third party graphical user interface is now available.

EnergyPlus has the ability to model both single zone and multi-zone airflow networks. It uses a pressure model similar to CONTAM and has the ability to model two nodes per zone for evaluating wind-driven cross ventilation and underfloor air distribution systems, as well as three nodes per zone for evaluating mechanical displacement ventilation systems. This development helps model the stratification inherent to such systems. Mixed mode simulation is possible but is currently limited to constant volume mechanical systems. Controls can be added to system components such as windows and the hybrid ventilation system. The detailed simulation software is powerful, but requires a significant amount of user input. Some examples of detailed capabilities that require special user attention are thermal comfort schedules, flow coefficients at openings, and hybrid ventilation control.⁵⁰

EnergyPlus has been found to perform excellently for a building with simple geometry and control scheme.⁵¹ A recent EnergyPlus validation study for a naturally ventilated free running building (Mateus *et al.*, 2014) concluded that the average error for air and radiative temperature prediction is 1.4°C. In most natural ventilation systems room air is only partially mixed, as a result of several projects funded by the CEC during the last decade, EnergyPlus has the capability to model unmixed flow patterns found in natural ventilation, namely:

- Displacement Ventilation (DV) systems, where the predominant air movement is vertical, due to heating by internal sources, typically with low momentum fluxes and small horizontal movements across the room.
- Cross-Ventilation (CV) systems, where the airflow maintains a significant portion of its inflow momentum as it moves across the room.

Other currently available fully mixed room heat transfer models use a single modeling point to characterize indoor air temperature in the room (Crawley *et al.*, 2005). Fully mixed room models, while simple to integrate in energy analysis software, are precise only when the flow is mixed.

C.4.4.3 TRNSYS

TRaNsient SYstem Simulation Program (TRNSYS) is an energy simulation program that uses a modular approach and is flexible to use. TRNSYS can be linked to CONTAM or COMIS to form

⁵⁰ Examples presented by Michael J. Witte at the ASHRAE Energy Modeling Conference: Tools for Designing High Performance Buildings, Atlanta, GA, April 4-6, 2011.

⁵¹ See <http://apps1.eere.energy.gov/buildings/energyplus/>.

a tool that can perform both thermal and air flow analysis. This link allows the two software packages to communicate dynamically. For example, a control sequence to open and close windows for specific conditions in TRNSYS will also feed into CONTAM to modify the airflow calculation for that particular time. Key strengths of TRNSYS include extensive documentation to help guide the user, its openness to interface with other software packages, including the CFD program FLUENT, and a user-friendly graphical interface that allows for drag-and-drop components to create input files and a plugin for Google SketchUp™. Weaknesses include the amount of detailed information about the building and system that the user is required to enter into the TRNSYS interface.

C.4.4.4 IES <VE>

The design and simulation tool IES is commonly used in the UK for conducting whole building energy performance evaluations and it is becoming more popular in the US. It has built-in functions for performing natural ventilation overheating calculations as required by UK building regulations for verifying system performance.

IES has two tools built into it for analyzing natural ventilation: MacroFlo (multi-zone bulk airflow model) and MicroFlo CFD. MacroFlo has the ability to model cross ventilation, single sided, and stack driven natural ventilation. It also has the ability to develop control strategies based on simple algebraic equations to determine when to operate the natural ventilation system (e.g. if the outside air temperature is greater than x , open the windows). MacroFlo can be run for a full annual simulation to complete an energy performance evaluation.

C.4.4.5 Trane TRACE™ 700

Trane TRACE™ 700 is commonly used to perform building energy simulations in the US, but the software does not explicitly model natural ventilation.

C.5 Barriers to Implementation

Barriers to natural ventilation arise for each and every design parameter. By identifying the issues that can prevent or restrict the use of natural ventilation, building designers and owners will be better prepared to address and resolve these issues. Some barriers will be more behavior-dependent, such as the acceptance of higher indoor air temperatures with naturally ventilated systems, and their resolution will require US building occupants to adapt their comfort zone.

The barriers described in the following sections can prevent or restrict the application of natural or mixed mode ventilation in commercial buildings and should be considered throughout the design phase for any new building or existing building retrofit.

C.5.1 Climate

Natural and mixed mode ventilation systems are not suited for all climates. A hot and humid climate will have a very short natural ventilation season. A temperate climate will have a longer window in which natural ventilation is effective. The longer the window for natural ventilation use, the more energy savings can be realized (see Section 2.1).

C.5.2 Cost

Cost estimates for naturally ventilated and mixed mode systems are no more complicated than mechanical systems since window hardware and controls represent commonly available materials and associated labor hours.

The typical HVAC system budget is based on a traditional mechanical system. So, for mixed mode systems, adding operable building elements and controls represents a first cost, and likely a maintenance cost premium. Unless accompanied by significant energy savings over a reasonable time period, the premiums may be unattractive to owners with short-term financial goals. Operable windows and controls are often a target of “value engineering”.

This is not to say that speculative developers will not consider mixed mode systems. Tenant pressure and expedited permit reviews in some jurisdictions have been driving developers to build green buildings, so-called in part due to their energy efficiency.

The energy market will also have something to say about mixed mode systems. At press time, the availability of North American natural gas, and the low cost of extracting it via the new (and controversial) “fracking” technique, has flattened the once increasingly sloping line of fossil fuel costs. Without other drivers this trend may at least delay the push toward naturally ventilated and mixed mode buildings.

C.5.3 Industry Inefficiencies, Low Fees, Silos and Design Risk

Delivery of a naturally ventilated (or mixed mode) building requires a design team that understands how natural ventilation works and has the skills and technology to detail such a building. It also requires an owner-occupier who wants a low-energy and/or sustainable building, is willing to pay a premium for design and construction processes, and is willing to explore non-traditional approaches to occupant comfort.

The above situation rarely occurs. Design teams may not have a great depth of natural ventilation experience or advanced analysis programs, and the owner might have only short-term financial goals or be limited by budgetary issues. If the owner does express an interest in a high degree of energy efficiency, they may not fully understand the degree to which they may need to change their usual way of thinking about comfort and consider less familiar systems and technologies.

Generally, traditional industry inefficiencies conflict with natural ventilation design approaches. For example, architects and their engineers and consultants often compete for projects at their own cost. A winning design might be more of an architectural design than an integrated, engineered design. It might appease the client’s desires for form and function but might not lend itself to application of natural ventilation. Going forward, to conserve fees, secure work, and reduce legal risks, the design team might instead focus on traditional HVAC systems.

Traditional design fees and construction budgets also work against implementation of natural ventilation and mixed mode systems. For example, an architect who wins a competition might be driven by the owner to offer fees as traditional “percent of construction costs”, which are

likely biased towards mechanically conditioned buildings. Or, to assure their own profit, architects might drive down engineer and consultant fees. Both examples short-change the effort required to analyze and design the building. Often times if the engineers or consultants insist on an allowance for such fees, they run the risk of losing the work to a lower-bidding rival.

Design team members working in “silos” represent another inefficiency that minimizes natural ventilation potential. An architect may generate the building form and facade without first seeking input from the mechanical engineer. The mechanical engineer may locate operable windows in a location to which a late arriving acoustical consultant might object. Successful design and implementation of natural ventilation systems requires early input from a number of these parties, and it is best they get together early and often during the design process. When this doesn’t happen the owner often suffers since the end product does not operate as intended.

Even if a perfect combination of owner and design team exists (where fees and time allows proper analysis of natural ventilation), the design team may be faced with so many complicated scenarios to analyze that they become afraid to pursue natural ventilation due to perceived design risk. If their design doesn’t work, they will be called to site to resolve the situation and, if the situation cannot be resolved, they will be sued by the owner. There is significantly less financial risk associated with mechanically ventilated buildings: one can usually always add more capacity to make a mechanical system work. This is not necessarily the case with natural ventilation systems.

Fee structures for design and liability of natural ventilation design in relation to lack of calculation rules, standards, and guidelines causes problems for the use of natural ventilation (Aggerholm, 1998).

C.5.4 Aesthetics and Solar Gains

There are various degrees to which natural ventilation mechanisms can impact building aesthetics. On a larger scale, narrow floor plans, atria and solar chimneys can impact the overall shape and massing of a building. On the smaller scale, trickle vents, windows and other operable building openings impact the look of the façade, from both inside and out.

Also related to façade design are external shading devices and parameters like window-to-wall ratio and glazing shading coefficient. Minimizing solar gains through manipulation of these features and parameters helps promote natural ventilation but can work against natural daylighting goals. It also impacts the look of a building. Tradeoffs are usually made.

In general, getting early project team agreement on these strategies, features and parameters is a critical step towards establishing a feasible approach to natural ventilation.

C.5.5 Comfort Expectations

In the UK, where mixed mode systems are more common, standards allow for indoor design temperatures beyond those typically used in the US. ASHRAE Standard 55 includes a broader range of acceptable indoor design temperatures for naturally ventilated spaces based on anticipated activity level, clothing, outdoor air temperatures and field observations.

From the dawn of air conditioning, US-based building owners or occupants gradually have become reticent to accept a higher range of interior design temperatures or percentage of hours outside of a comfortable range. Similarly, building owners and operators in the US may be unwilling to accept this higher temperature range as it could result in hot service calls due to occupants not being used to the slightly higher space temperatures. In order for natural ventilation systems to be more commonly accepted, building occupants and owners will need more exposure to mixed mode systems that are properly designed and that are operating correctly.

C.5.6 Codes, Standards and Authorities Having Jurisdiction

Building codes establish the minimum acceptable safety levels that building designers must comply with during design and construction. They are provided to protect the public health and safety and are often considered law when adopted by the State, Local Municipality or other Authorities Having Jurisdiction (AHJ). Codes vary by region, City, State and/or Country and are influenced by many factors, including energy use, available resources, local climatic conditions, seismic activity, etc. Building codes are typically separated by discipline, and the portions related to natural ventilation typically fall under the mechanical code sections.

Restrictions in the use of natural ventilation in office buildings imposed by national building regulations, codes, norms and standards are relatively limited, but problems can be caused by fire division requirements in the national Building Regulations, and by guidelines about the need for mechanical ventilation in certain instances e.g. large offices, assembly rooms and canteens (S. Taylor, private communication).⁵²

C.5.6.1 US Mechanical Codes

The International Building Code (IBC) is the most adopted building code in the US. It is a consolidation of the three legacy, regional codes: the BOCA National Building Code by the Building Officials Code Administrators International (BOCA), the Uniform Building Code (UBC) by the International Conference of Building Officials (ICBO), and the Standard Building Code (SBC) by the Southern Building Code Congress International (SBCCI). The first edition of the IBC was published in 1997.

Chapter 4 of the IBC's mechanical volume (IMC) addresses ventilation and provides requirements for both natural and mechanical ventilation. Under natural ventilation, the minimum required area of openable window is based on building floor area being ventilated. The minimum openable area to the outdoors shall be 4 percent of the floor area being ventilated. Adjoining spaces without direct access to the outdoors must be provided with an unobstructed opening to an exterior space, sized at 8 percent of the floor area of the interior space, but not less than 25 square feet. Operable openings shall be readily accessible to building occupants whenever the space is occupied.

⁵² Email from Steve Taylor to Ed Arens, Bud Offerman, Gwelen Paliaga and William W. Nazaroff, November 9, 2011.

C.5.6.2 California Mechanical and Energy Codes

For reasons this document does not dive into, California has based their mechanical code (CMC) on the Universal Mechanical Code (UMC), published by the International Association of Plumbing and Mechanical Officials (IAPMO). The UMC includes the same natural and mechanical ventilation requirements as the IMC but further requires that naturally ventilated spaces are located within twenty-five (25) feet of operable wall or roof openings to the outdoors.

The California Mechanical Code (CMC) and California Energy Code (California Code of Regulations, Title 24) have historically allowed natural ventilation when prescriptive requirements were met, but only as a supplement to a mechanical ventilation system. Prescriptive requirements include ventilation opening area in relation to room floor area, distance of occupants to opening operators and depth of room. The Code-listed depth limit of 20 feet is based on typical classroom depth, apparently since classrooms historically have been naturally ventilated (S. Taylor, private communication).⁵³

The 2010 version of the CMC was based on the 2009 Universal Mechanical Code (UMC) and the first version that allowed elimination of the mechanical system in cases where a prescriptively compliant system existed or where an “engineered” natural ventilation system was approved by the local authority. The 2013 version of the CMC (based on the 2012 version of the UMC) amended this prescriptive case to require a means of maintaining the opening in the open position during occupied hours.

C.5.6.3 US Standards

The American Society for Heating Refrigeration and Air conditioning Engineers (ASHRAE) Standard 62.1, Ventilation for Acceptable Indoor Air Quality, specifies the minimum ventilation rates and indoor air quality that will be acceptable to human occupants and minimize the potential for adverse health effects but does not address thermal comfort. ASHRAE 62.1 prescriptive requirements for natural ventilation systems are similar to those of the CMC, except that a 25 foot maximum room depth is allowed for hotel rooms and the minimum opening area percentage is 4 percent of floor area as referenced by two major regional US building codes (BOCA and SBCCI) for many years. The 5 percent referenced by CMC originates from the UMC. The current version of ASHRAE 62.1 (2010) reads similar to the 2013 CMC but adds a third instance where mechanical ventilation can be eliminated: when the zone in question is not heated or cooled.

ASHRAE’s Standard 55, Thermal Environmental Conditions for Human Occupancy, identifies the factors of thermal comfort and the process for developing comfort criteria. It considers combinations of different personal and environmental factors that will result in thermal environmental conditions acceptable to at least 80% of the occupants. Personal factors include clothing and activity level, and environmental factors include humidity, temperature, thermal radiation and air speed, but these are all assumed to be at steady state conditions.

⁵³ *Ibid.*

It is very rare to encounter steady state conditions in real buildings. In naturally ventilated buildings occupants can better adapt to a higher temperature or larger range of acceptable temperatures by having access to operable window controls and by being able to react to the changing conditions.

For this reason Standard 55 recommends an adaptive comfort model be used for naturally ventilated spaces (Figure C.14). A broader range of acceptable indoor air temperatures, based on monthly outdoor temperatures, is derived from field experiments that demonstrate different thermal responses for naturally ventilated spaces compared with mechanically cooled spaces due to different thermal experiences, occupant perception, local control, and accessibility.

Figure C.14: Adaptive Comfort Chart

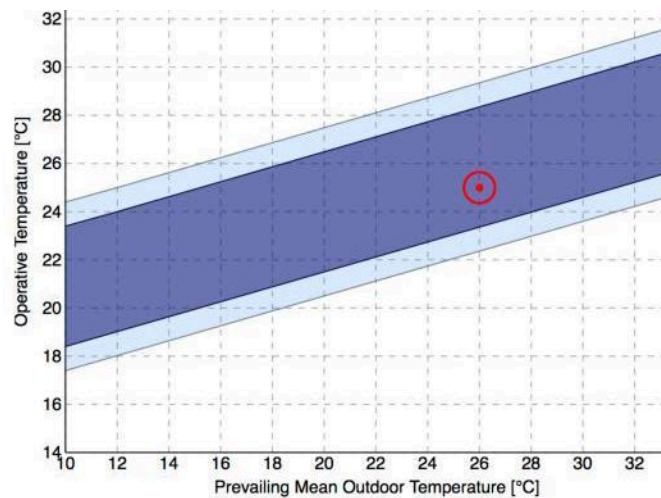

Image Credit: CBE Thermal Comfort Tool for ASHRAE 55 (cbe.berkeley.edu/comforttool), Center for the Built Environment, University of California, Berkeley. May, 2013.

C.5.6.4 International Codes and References

In Australia, Part F4 of the Building Code of Australia, Light and Ventilation, provides the requirements for natural light and natural ventilation. The prescriptive requirements are similar to the IMC requirements for minimum openable area based on floor area being ventilated. The total minimum opening or openable size shall not be less than 5% of the floor area of the room required to be ventilated. For ventilation borrowed from adjoining rooms, the window, opening, door or other device has a ventilating area of not less than 10% of the floor area of the room to be ventilated, measured not more than 3.6 m (11.8 ft.) above the floor and the adjoining room has a window, opening, door or other device with a ventilating area of not less than 10% of the combined floor areas of both rooms

The Australian and American codes are similar, as they provide prescriptive requirements for façade openings, while in the UK, application manuals provide design recommendations, best practices and requirements of operating hours not to exceed specific temperatures.

C.5.6.5 US Building and Fire Codes

High rise buildings, atria and malls are subject to code-required smoke control systems. Openings within natural ventilation systems need to be equipped with automatic operators listed by an independent product safety certification agency. These operators close to prevent smoke/fire transfer and/or may open to allow make up air for smoke ventilation.

Adjacency of neighboring buildings can trigger code requirements for rated exterior walls. Glass within these walls often needs to be fire-rated. Fire rated glass can be limited in size and configuration, further impacting the aesthetics and operation of the openable façade elements.

Smoke control strategies for high-rise buildings typically require maintenance of pressure differences between building spaces and/or floors. Operable windows tend to complicate the smoke control system design and controls, since breakdowns can lead to a compromised system. In such cases, life safety issues are often prioritized above aesthetic and energy goals.

The availability of natural ventilation intakes that are UL listed for fire/smoke control can be a potential barrier. Many of these products are imported into the US and may not have the necessary testing required by or familiar to the local authorities. Also related to imported products, motors for imported mechanically controlled dampers are not always available in US voltages.

C.5.6.6 Authorities Having Jurisdiction (AHJ's)

Authorities Having Jurisdiction (AHJ's) are typically representatives of a governmental agency or sub-agency which regulates the construction process. In most cases, this is the municipality in which the building is located. AHJ's may also include the fire chief, fire marshal, chief of a fire prevention bureau (or labor department or health department), building official, electrical inspector, or other individual having statutory authority. AHJ's come in all shapes and sizes but, more importantly, come with their own experiences, opinions, level of knowledge and personalities. Even if a designer is sure they have met the intent of the Code, an AHJ may have a differing opinion. In the case of California's Mechanical Code, natural ventilation of a space wider than 20 feet may not be acceptable, even if an engineer can prove it through rational analysis.

C.5.7 Building Function

Building function may not be conducive to natural ventilation. For example, museum environments requiring tight temperature and humidity control may not tolerate the wider bounds of environmental conditions generated by natural ventilation. Occupants of recording studios might close windows to eliminate ambient noise. Certain laboratories and healthcare facilities have stringent air quality standards that require filtering of all outdoor air. Also, banks and some governmental facilities might see operable windows as a security risk.

C.5.8 Complicated Analysis

Energy, comfort, and airflow need to be analyzed together as part of a natural ventilation design. Currently no one tool or modeling software can provide all three, especially for complex building geometries. The additional analysis effort required for natural ventilation and lack of confidence in validating the modeling system outputs is often a deterrent for designers and

owners. For California specifically, any robust natural ventilation modeling tool that can address energy, comfort, and airflow requires State approval for demonstrating compliance with the Energy Code.

C.5.9 Maintenance, Controls, and Operation

Building occupants may be resistive to passive systems that require active user adjustment, as they are not used to seeing these type of systems installed in commercial applications throughout the United States. Without the proper education or understanding on how the mixed mode systems work there is a risk of increased energy usage due to operator error at the occupant level. For example, if occupant controlled windows are left open during the peak cold conditions, excessive amounts of supplemental heating may be wasted.

C.5.10 Product Availability

A 1998 survey of building industry professionals and governmental decision makers identified a need for new components regarding windows and vents with better air flow and draught performance, better controllability and better design (Aggerholm, 1998).

Interfaces between operable windows and mechanical controls systems are commonplace. Actuators are prone to failure and can limit the operation of the natural ventilation system (Torcellini *et al.*, 2006).

Building industry professionals believe mechanical ventilation systems offer several advantages compared to natural ventilation with regard to cooling effectiveness, draught minimization, ability to remove odors and pollutants, ability to prevent ingress of odors and pollutants, insulation against external noise and central controllability. Nevertheless they expect naturally ventilated offices to result in lower installation costs, lower operational and maintenance costs and higher end-user satisfaction, particularly in cellular offices where the highest individual controllability is expected. On average, building professionals, especially architects, expect an increase in the future use of natural ventilation in office buildings (Aggerholm, 1998).

C.6 Selecting NV Strategies and Opening Locations

This guide focuses on the use of natural ventilation (NV) in existing low-rise office buildings. For this type of building, single sided (SS) and cross-ventilation (CV) are the preferred strategies. Exceptionally, in some building geometries, buoyancy-driven displacement ventilation systems (DV) can also be implemented. Further, when the wind velocity is low, any natural ventilation system is driven by thermal effects. For this reason this section will also discuss thermally driven NV systems.

In California, from the code compliance perspective, natural ventilation is currently governed by mandatory requirements that mean it can only be implemented for spaces that are within 20 ft. (6m) of the façade and are served by openings with a total opening area that is at least 5% of the floor area of the compartment. For spaces that are further away from the façade, or have lower available operable window areas, designers would have to demonstrate code compliance using software simulation tools such as EnergyPlus in a so-called performance-based approach;

however, this approach is not available at present. This section therefore focuses on cases that satisfy the current mandatory compliance requirements.

When faced with the challenge of implementing an NV strategy, designers must:

1. Select the appropriate strategy (SS, CV or DV)
2. Define the size and position of the ventilation openings
3. Estimate typical natural ventilation airflow rates
4. Evaluate possible energy savings and fine-tune the design

This chapter provides basic guidelines for implementation of NV systems in existing low-rise office buildings, assisting the designer in Steps 1-3. Step 4 requires a software simulation tool and, ideally, should be performed even for design configurations based on the mandatory rules.

C.6.1 Selecting the Appropriate NV Strategy

The selection of the appropriate NV strategy is typically done on a room-by-room basis and tends to be dictated by the building geometry. Figure C.15 through Figure C.17 (see next page) show the three NV strategies that are considered. Early design phase selection of the best NV strategy can be based on the following simple, room geometry based, rules:

- If the room is less than 20 f.t (6m) deep and has access to a single façade: single sided ventilation (SS, Figure C.16)
- If the room has access to two façades and the room depth does not exceed 40 ft: cross-ventilation (CV, Figure C.15)
- If the room has access to a façade and the roof: displacement ventilation (DV, Figure C.17).
- If the room has access to two adjacent façades: corner-ventilation (CR, not illustrated, but it will be shown in the next sections to be a hybrid of SS and CV).

Figure C.15: Cross-Ventilation (CV)

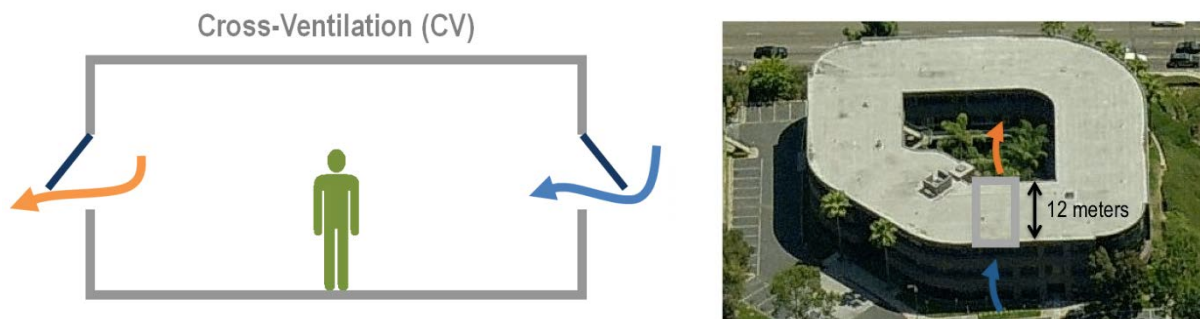

CV is driven by wind and relies on air movement across the room. CV requires access to two façades that are subject to different wind generated pressures.

Image Credit (right side): Google Earth.

Figure C.16: Single-Sided Ventilation (SS)

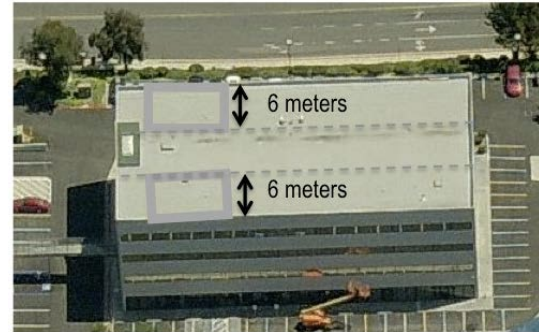
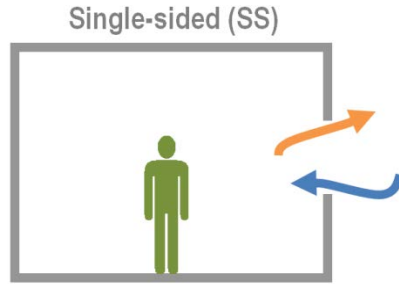

Single sided ventilation is driven by wind or buoyancy and relies on air movement near the opening.

Image Credit (right side): Google Earth.

Figure C.17: Displacement Ventilation (DV)

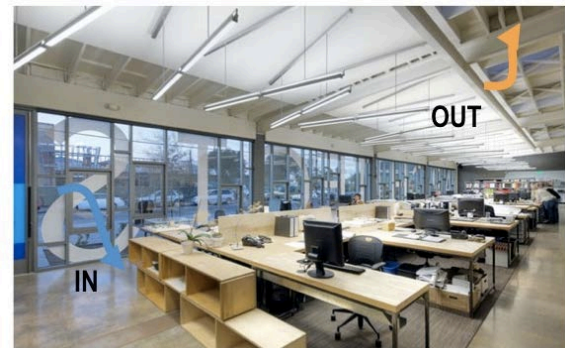
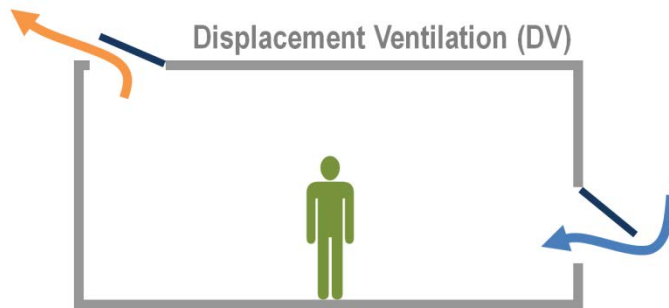

Displacement ventilation is driven by buoyancy and promotes a stratified environment in the room (colder air near the floor and warmer air exhausted near the ceiling).

Image Credit (right side): HGW architects (San Diego, CA).

According to code, any building floor area that is more than 20 ft. from a façade cannot be naturally ventilated.

When the room geometry is flexible and allows for different systems the choice may be based on the following characteristics of the three available systems:

- *Stability of flow rate:* when properly designed, DV, can provide the most constant flow rates because the mechanism driving the flow is the internally-generated heat (which always exists when the office needs ventilation).
- *Requirement of high flow rates:* CV has the potential to generate the largest flow rates, and consequently the highest heat removal rates.
- *Simplicity of use and control:* due to the capability to operate with a single window, SS ventilation systems are the simplest NV option.

The main pitfalls in these NV systems are the following:

- When designing DV systems the exhaust opening geometry must always be subject to negative or negligible wind generated pressure (to avoid conflict between buoyancy and wind generated forces).
- CV systems can generate large flow rates but tend to be difficult to control and can generate excessive indoor velocity.
- SS systems can provide adequate levels of fresh air but have a limited capability to deal with heat gains, particularly the large loads generated in an unshaded sun-exposed façade.

C.6.2 Comparison of Airflow Rates For Different NV Strategies

The airflow rate that a given ventilation strategy will provide depends on the building geometry and materials, internal gains, surrounding wind and thermal environment. As discussed above, a detailed prediction of hourly flow rates requires dynamic thermal and airflow simulation.

This section provides a simple first-order comparison of the flow rates generated by different NV strategies. Figure C.18 presents area-normalized flow rates for different NV strategies, obtained from a large set of wind tunnel simulations with variable wind.

The estimates presented in Figure C.18 are normalized: the vertical axis has no dimensions. As an example of using these results in a practical estimate, consider a CV case in which the inflow area, $A_{in} = 10 \text{ ft}^2$ (with equal outflow area), and a wind at building height $U(H_B) = 15 \text{ ft/s}$. Taking the value of the flow coefficient on the horizontal axis as 0.4 (the approximate average value for the red CV bars in Figure C.17), we have the following flow rate value:

$$Q \approx 0.4 \times 10 \times 15 = 60 \text{ ft}^3/\text{s} = 3600 \text{ cfm}$$

For the case of single sided ventilation the multiplying constant is 0.08 for rooms with a single aperture and 0.12 for rooms with more than one aperture – in contrast with the value of 0.4 used for CV flows. The inflow area is always one half of the total window area: so, for an SS1 case with a 10 ft^2 window the inflow area, A_{inv} is 5 ft^2 , while for a single-sided case with two 10 ft^2 windows A_{in} is 10 ft^2 .

Figure C.18: Comparison of Ventilation Strategies

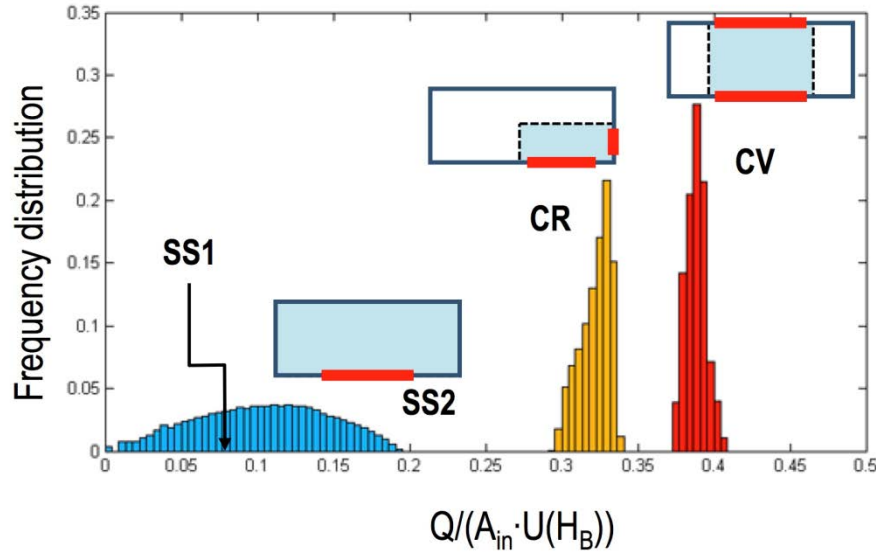

Area normalized flow rates for different NV strategies, obtained from a large set of wind tunnel simulations. SS1: single-sided ventilation with one window per room. SS2: single-sided ventilation with two windows per room. CR: corner room ventilation. CV: cross ventilation.

Image credit: Nick Daish (UC, San Diego) using data provided by Dave Banks (CPP Wind Engineering).

Analysis of Figure C.18 reveals the following approximate relations in the typical magnitude of the flows generated by the different NV systems (when normalized by window area):

- CV is four times stronger than SS: $CV \approx 4 \times SS$
- On average, for the same total window area, SS single-window flow rates are similar to multiple-window values (compare the SS1 value and the median of the SS2 range in Figure C.18)
- In some geometries that will be discussed in the next section, SS2 can generate significantly larger flow rates compared to SS1 (twice as large)
- Corner ventilation can generate flows that are closer to CV than SS.

To compare the flow of thermally-driven systems (thermally driven SS flow and DV), we use an SS1 case as reference. Using the aperture equation based simple methodology for thermally driven flows, defined in CIBSE (2005), and considering equal total window areas, an external wind of 15 ft/s and an internal temperature that is 9°F higher than outside, we obtain the following relative magnitudes:

- A DV flow with a 7.5 ft difference in height between the centers of the windows generates the same flow rate as an SS1 system.
- For these conditions, comparing wind driven SS1 with thermally driven SS1 we conclude that the thermal flow is 40% smaller.

C.6.3 Urban Versus Suburban Wind Environment

In addition to the uncertainty and variability of wind conditions, designers of NV systems in urban environments are faced with sheltering by adjacent buildings. Figure C.19 presents area-normalized flow-rates for different NV strategies (SS1 and CV) under variable surrounding building conditions.

Analysis of Figure C.19 reveals the following effects of surrounding buildings:

- SS systems (left-hand plots) are not significantly affected by sheltering by surrounding buildings (a reassuring characteristic when designing in urban environments).
- In the stronger sheltering scenarios, 2-story building surrounded by 4-story buildings, CV “becomes” SS. In these cases the wind never flows across the building and tends to be parallel to the façade (the driving mechanism for SS flow).

Figure C.19: Urban Sheltering Effects

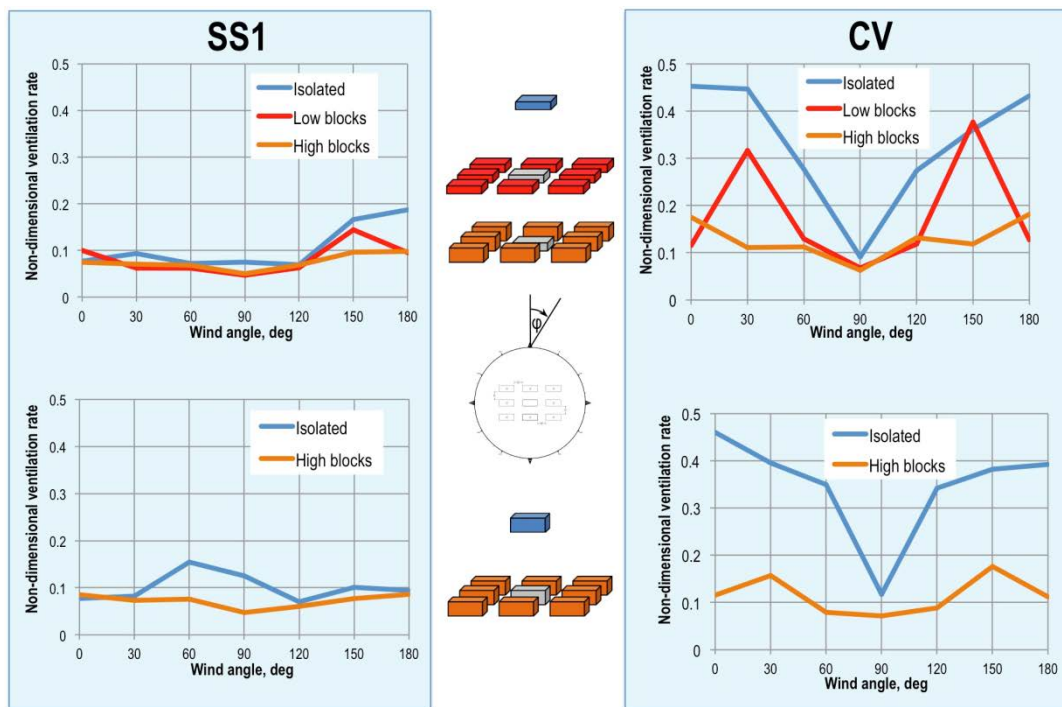

Area-normalized flow rates for SS1 and CV NV strategies, obtained from a large set of wind tunnel simulations.

Image credit: Nick Daish (UC, San Diego) using data provided by Dave Banks (CPP Wind Engineering).

C.6.4 Size and Position of Ventilation Openings

As discussed above, at present the mandatory compliance requirements place restrictions on maximum room size and openable window area. The solutions presented in this section therefore cover SS rooms that are up to 20 ft. deep and CV rooms that are up to 40 ft. deep.

Considering a scenario where the NV strategy has already been selected, and the designer must define the openings for a given small office building, typical design questions would include:

- What is the preferred window type?
- What is the adequate opening area and window height?
- What is the maximum distance between the windows?

The results presented in the previous sections showed that there is a minimum common denominator for the two most common NV strategies (SS and CV):

- For certain wind angles or in sheltered conditions CV resembles SS.
- When there is no wind all systems are buoyancy driven.

In CV systems, unobstructed openings, such as a sash window, are likely to generate draft complaints; further, unobstructed windows allow for more noise ingress into the work space. Although all window types can be used in NV systems, the most versatile and functional window geometry is a tilt and turn window (bottom hung, inward opening). In this type of window the tilt position allows for NV airflow while reducing draft and outside noise induced discomfort (since both the airflow and sound waves are partially deflected towards the ceiling). The tilt mode should allow for different positions so the user can fine-tune the opening area. The proposed tilt and turn window meets the requirements: the turn, fully open, position can be sized to meet code minimum (5% of floor area) and the tilt position can be used on a daily basis where the wind and occupancy conditions allow for smaller opening areas (typically 1-2% of room floor area).

Therefore, since SS buoyancy-driven flow rates are lower than the corresponding wind-driven flow rates, all NV systems should be designed with variable opening area, including: a larger area for no-wind conditions where buoyancy driven flow must be used to exhaust internal heat gains and a smaller adjustable area to be used when there is wind (the most common scenario). Existing experimental research on optimal window geometry confirms these recommendations (Heiselberg *et al.*, 2001): bottom hung tilt and turn window is the best configuration on a single-sided ventilation strategy during summer. During winter the bottom hung window configuration is the best choice as it avoids direct air supply to the occupied zone.

In addition the windows should have a portion of the opening area above 6 ft. (1.8m) to exhaust heat accumulated near the ceiling of the room. Also, to avoid regions with low air movement along the façade, windows should not be more than 15 ft. (4.5m) apart, center to center.

Figure C.20 proposes a design methodology for rooms up to 20 ft. depth (or 40 ft. for CV). The approach is based on two window configurations, (a) and (b), that meet code and adjustability requirements. The double window configuration, (b), is more flexible and should be the preferred choice. The single window configuration, (a), is a simpler alternative that meets the requirements. The proposed design treats larger open space rooms as sets of small offices that use one of the two base window solutions ((c)-(f)).

Figure C.20: Proposed Window Area Positions for SS and CV Systems

(a)

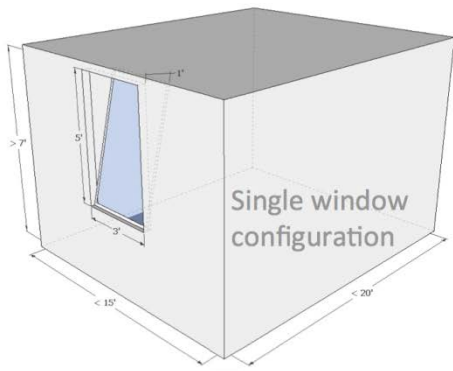

(b)

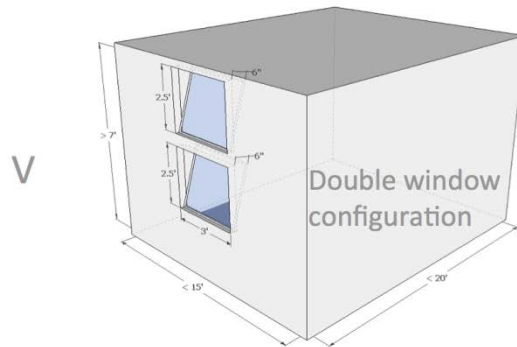

V

(c)

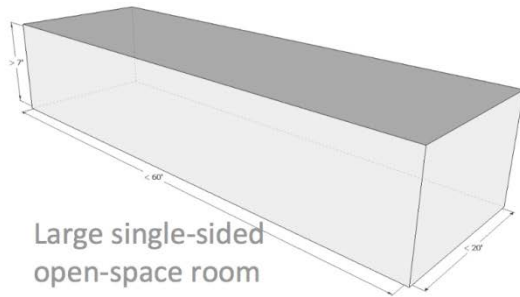

=

(d)



(e)

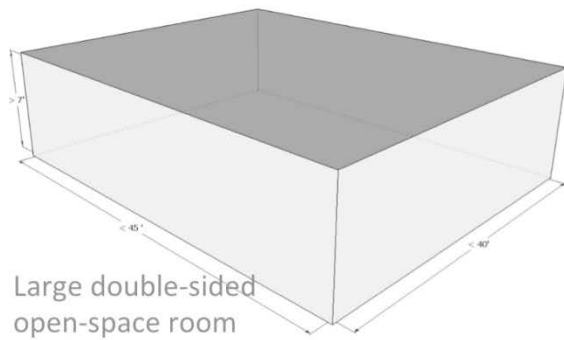

=

(f)

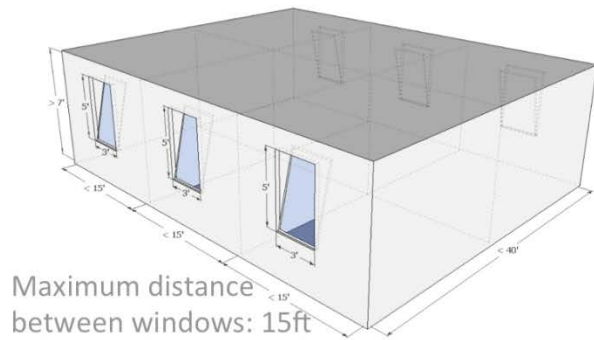

C.7 Other Resources

C.7.1 CIBSE Application Manuals

In the UK, two application manuals produced by the Chartered Institution of Building Services Engineers (CIBSE) are relevant for natural ventilation and mixed mode ventilation systems: AM 10 and AM 13.

The CIBSE Applications Manual AM10, *Natural Ventilation for Non Domestic Buildings*, establishes a not-to-exceed temperature of 82°F (28°C) for more than 1% annual occupied hours, based on an ideal summer design temperature of 25±3°C (77±5°F). Unlike the IMC, there is no minimum openable window area requirement; rather the application manual provides design guidance and strategies to meet the maximum overheating hours requirement. Compliance is documented through energy modeling software that has the ability to perform the calculation methodology described in AM10 to simulate the window openings, overheating, etc.

The United States Green Building Council's (USGBC) Leadership in Energy and Environmental Design (LEED) rating system references CIBSE Applications Manual AM10

The CIBSE Applications Manual AM13, *Mixed Mode Ventilation*, provides guidance for combined natural and mechanical ventilation systems used in the UK. This application manual describes the advantage and disadvantages of mixed mode ventilation and provides recommendations on zoning and control strategies and provides recommendations on modeling techniques and thermal comfort issues.

C.7.2 BSRIA Documents

The Building Services Research and Information Association (BSRIA) is a non-profit test, instruments, research and consultancy organization, providing specialist services in construction and building services and producing industry-recognized best practice guidance.

BSRIA employs 180 people at their headquarters in the UK, and at regionally-based construction compliance offices throughout the UK; at offices in China, North America, Germany, France and Spain; and have Associates in Northern Ireland, Japan, Brazil and Australia.

BSRIA's publications website lists several guides on natural ventilation-related issues.

C.7.2.1 Making Natural Ventilation Work (General Note GN 7/2000)

Notes the operational, environmental and cost benefits provided by natural ventilation for non-domestic buildings, but points out that the increased implementation of natural ventilation is threatened by poor management and operation in the use of natural ventilation strategies. Provides information to help building managers and occupants address these issues and optimize their natural ventilation systems.

The guidance is based on discussions with facilities managers and building services engineers as well as BSRIA's own experience and published material. It presents case studies illustrating particular points, and supplies details of natural ventilation-related products in appendices.

C.7.2.2 Wind-Driven Natural Ventilation Systems (BG 2/2005)

This publication provides guidance on the design and application of wind-driven natural ventilation systems. Topics covered are: how wind-driven ventilation works; performance factors; siting and installation; meteorological data; automatic controls; test method; designing and sizing methodology; worked examples; commissioning; and computer modeling. The publication also includes eight case studies demonstrating the use of wind-driven natural ventilation systems.

C.7.2.3 Control of Natural Ventilation (TN 11/95)

Provides guidance on the application of building management system controls to natural ventilation. Explains how the provision of automatic control of air inlet vents with inaccessible air outlet vents results in improved ventilation rates, particularly in the summer, thus enhancing the environment in which people live and work. In addition, automatic controls offer the opportunity for night cooling, thus helping to ameliorate daytime heat gains. Presents a number of generic control strategies for natural ventilation, mixed mode ventilation and night cooling. Describes procedures for commissioning and fine tuning buildings using these strategies, together with appropriate control set points. Reinforces the guidance with the results of monitoring carried out in three naturally ventilated buildings. Concludes with details of the control strategies of eight further building case studies. Presents a cost analysis of the use of the different ventilation types.

C.7.2.4 Refurbishment of Air-Conditioned Buildings for Natural Ventilation (TN 8/98)

States it has been demonstrated in a number of case study buildings that it is possible to maintain a comfortable environment when refurbishing without resorting to full mechanical ventilation or cooling. Presents guidance for refurbishing air conditioned buildings to use natural ventilation, where consideration is being given to the removal of mechanical ventilation and/or mechanical cooling plant. States the guidance is also particularly appropriate where conventional naturally ventilated buildings are to be upgraded to incorporate passive cooling techniques. Does not preclude the use of mechanical ventilation as part of a mixed mode solution. Section headings are - Initial assessment, Reducing heat gains, Noise attenuation, Ventilation design, Natural ventilation strategies for deeper plan spaces, Using the thermal capacity of the building fabric, Mixed mode or hybrid buildings, Operational guidance, Case studies.

C.7.3 Leading Research

C.7.3.1 International Research Centers

A comprehensive literature review on the current state of natural ventilation research was conducted by Dr. John Zhai at the University of Colorado, at Boulder (Zhai *et al.*, 2010). This study found that the following research centers were highly active in hybrid and natural ventilation research:

- Aalborg University, Hybrid Ventilation Center - Denmark
- De Montfort University, Institute of Energy and Sustainable Development – UK
- Fraunhofer Institute for Solar Energy Systems – Germany

- Harbin Inst. of Technology, Inst. of Indoor Env. Science and Engineering – China
- University of Nottingham, Institute of Building Technology - UK
- Lawrence Berkeley National Laboratory – US
- Massachusetts Inst. of Technology, Building Technology Program - US
- National Institute of Standards and Technology - US
- National Renewable Energy Laboratory - US
- National University of Singapore, Department of Buildings – Singapore
- Osaka University - Japan
- Université de La Rochelle, LEPTAB – France
- University of Athens – Greece
- University of Cambridge, Department of Applied Mathematics and Theoretical Physics – UK
- University of Cambridge, BP Institute for Multiphase Flow – UK
- University of Hong Kong – Hong Kong

C.7.3.2 US Research Centers

An early review of the work being done by US research centers on natural and hybrid ventilation revealed a common theme – natural ventilation of commercial buildings is not common practice in this country and there are a number of barriers to its acceptance. Therefore, this section focuses on the work being done in the US specifically to overcome these issues.

The **Lawrence Berkeley National Laboratory** (LBNL) is developing tools that will allow designers to accurately simulate building energy performance. Current tools being developed include: EnergyPlus, Modelica, Building Controls Virtual Test Bed, and GenOpt®. (EnergyPlus and COMFEN are described elsewhere within this Guide.)

Modelica is a non-proprietary, object-oriented, equation-based language to conveniently model complex physical and control systems. The Modelica Buildings Library is being developed to allow designers to quickly and easily model building energy control systems. The library contains models that include multi-zone airflow and contaminant transport that could prove to be helpful for designers evaluating natural ventilation systems.⁵⁴

The Building Controls Virtual Test Bed software links multiple simulation tools, such as EnergyPlus and Modelica for co-simulation. It also has the ability to tie simulation tools to Building Automation Systems to facilitate the development of new control algorithms and the verification of controls sequences within the BAS to improve the commissioning process.

⁵⁴ See <http://simulationresearch.lbl.gov/modelica>.

GenOpt® is an optimization tool that aims to reduce the amount of time required to determine optimal design parameters. It is written in Java to remain platform independent. It can be linked to analysis tools such as EnergyPlus, Modelica, TRNSYS, and others to run optimization and parametric studies.

The **National Renewable Energy Laboratory** (NREL) is also continuing to develop the EnergyPlus simulation software. The primary focus is on evaluating building controls strategies and algorithms that can be modeled in the EnergyPlus framework.⁵⁵

Currently, NREL is leading the implementation of energy management system (EMS) style controls into the EnergyPlus core engine. This project will exercise new EnergyPlus modeling capabilities to analyze the controls and algorithms within and between the various technology option sets.

At the **Center for the Built Environment** (CBE), the Building Envelope Systems research area is currently working on a number of projects that address potential barriers to natural ventilation systems. Much of this work is geared toward better understanding impacts to occupant comfort caused by factors such as façade and perimeter zone performance, and occupant access to operable windows. Additional work is being done to develop design recommendations for mixed mode systems that use operable windows.⁵⁶

⁵⁵ See <http://www.nrel.gov/>.

⁵⁶ See <http://www.cbe.berkeley.edu/>.

APPENDIX C REFERENCES

- Aggerholm, S. (1998) *Perceived barriers to natural ventilation design of office buildings*. Building Research Establishment, Garston. 23pp.
- ASHRAE (2013) 2013 ASHRAE Handbook – Fundamentals.
- Aynsley, R. (2007) Natural ventilation in passive design. Environment Design Guide Tec 2, revised version, May 2007.
- Carrilho da Graça, G., Linden, P.F. and P. Haves (2004) Design and testing of a control strategy for a large, naturally ventilated office building. *Building Serv. Eng. Res. and Technol.* **25(3)**, 223-239.
- Carrilho da Graça, G., Martins, N.R. and C.S. Horta (2012) Thermal and airflow simulation of a naturally ventilated shopping mall. *Energy and Buildings* **50**, 177-188.
- CIBSE (2005) *AM 10 Natural Ventilation in Non-Domestic Buildings*. The Chartered Institution of Building Services Engineers, London, UK. 70pp.
- Crawley, D.B., Hand, J.W., Kummert, M. and B.T. Griffith (2005) Contrasting the capabilities of building energy performance simulation programs. US Department of Energy, University of Strathclyde, and University of Wisconsin. July 2005.
- Emmerich, S.J., Dols, W.S. and J.W. Axley (2001) Natural Ventilation Review and Plan for Design and Analysis Tools. National Institute of Standards and Technology, Report NISTIR 6781.
- Heiselberg, P., Svidt, K. and P.V. Nielsen (2001) Characteristics of airflow from open windows. *Building and Environment* **36(7)**, 859-869.
- Levi, M. and J. Soper (2009) Case study: New San Francisco Federal Building. *Presentation at 17th Annual National Conference on Building Commissioning (NCBC), Seattle, WA, June 3-5, 2009.*
- Linden, P.F. (1999) The fluid mechanics of natural ventilation. *Ann. Rev. Fluid Mech.* **31**, 201-238.
- Mateus, N.M., Pinto, A. and G. Carrilho da Graça (2014) Validation of EnergyPlus thermal simulation of a double skin naturally and mechanically ventilated test cell. *Energy and Buildings* **75**, 511-522.
- McConahey, E. (2008) Mixed mode ventilation: Finding the right mix. *ASHRAE Journal* 50(9), 36-48.
- Menchaca-B., M.-A. and L. Glicksman (2008) Coolvent: a multizone airflow and thermal analysis simulator for natural ventilation in buildings. In *Proceedings of SimBuild 2008, Third National Conference of IBPSA-USA, Berkeley, California, July 30 – August 1, 2008*, pp. 132-139.

Torcellini, P., Pless, S., Deru, M., Griffith, B., Long, N. and R. Judkoff (2006) Lessons learned from case studies of six high-performance buildings. NREL Technical Report NREL/TP-550-37542, June 2006.

Zhai, Z., Johnson, M.-H. and M. Krarti (2011) Assessment of natural and hybrid ventilation models in whole-building energy simulations. *Energy and Buildings* **43(9)**, 2251-2261.