

Lawrence Berkeley National Laboratory

Lawrence Berkeley National Laboratory

Title

Extraction of niobium and tantalum isotopes using organophosphorus compounds - Part I -
Extraction of 'carrier-free' metal concentrations from HCl solutions

Permalink

<https://escholarship.org/uc/item/4hn3h9hh>

Author

Gates, Jacklyn

Publication Date

2009-03-01

Peer reviewed

**Extraction of niobium and tantalum isotopes using
organophosphorus compounds – Part I – Extraction of
‘carrier-free’ metal concentrations from HCl solutions**

By J. M. Gates^{1,2,*}, R. Sudowe^{1,3}, L. Stavsetra¹, M. N. Ali², M. G. Calvert^{1,2},
I. Dragojević^{1,2}, P. A. Ellison^{1,2}, M. A. Garcia^{1,2}, N. Gharibyan^{2,3}, K. E. Gregorich¹,
S. L. Nelson^{1,2}, S. H. Neumann⁴, T. Parsons-Moss¹ and H. Nitsche^{1,2}

¹ *Nuclear Science Division, Lawrence Berkeley National Laboratory, Berkeley, CA 94720, USA*

² *Department of Chemistry, University of California, Berkeley, Berkeley, CA 94720, USA*

³ *Present Address: Department of Health Physics, University of Nevada, Las Vegas, Las Vegas, NV 89154*

⁴ *Department of Applied Sciences and Technology, Aachen University of Applied Sciences, D-52428 Jülich,
Germany*

LEGAL DISCLAIMER

This document was prepared as an account of work sponsored by the United States Government. While this document is believed to contain correct information, neither the United States Government nor any agency thereof, nor The Regents of the University of California, nor any of their employees, makes any warranty, express or implied, or assumes any legal responsibility for the accuracy, completeness, or usefulness of any information, apparatus, product, or process disclosed, or represents that its use would not infringe privately owned rights. Reference herein to any specific commercial product, process, or service by its trade name, trademark, manufacturer, or otherwise, does not necessarily constitute or imply its endorsement, recommendation, or favoring by the United States Government or any agency thereof, or The Regents of the University of California. The views and opinions of authors expressed herein do not necessarily state or reflect those of the United States Government or any agency thereof or The Regents of the University of California.

Abstract

The extraction of niobium (Nb) and tantalum (Ta) from hydrochloric acid media by bis(2-ethylhexyl) hydrogen phosphate (HDEHP) and bis(2-ethylhexyl) hydrogen phosphite (BEHP) was studied. The goal of the experiments is to find a system that demonstrates selectivity between the members of group five of the Periodic Table and is also suitable for the study of dubnium (Db, $Z = 105$). Experiments were performed at the trace level (10^{-16} M Nb or Ta) using hydrochloric acid with concentrations ranging from 1 – 11 M and short-lived isotopes of Nb and Ta produced in nuclear reactions. When HDEHP was used as the extractant, the Nb extraction yield decreased with increasing acid concentrations above 6 M, while the amount of Ta extracted remained over 75% for all acid concentrations studied. Tantalum was found to be extracted by BEHP at acid concentrations above 6 M, while niobium was not significantly extracted. The data obtained are used as the basis to discuss the speciation of Nb and Ta under the conditions studied and to evaluate possible extraction mechanisms.

1. Introduction

The chemistry of the group 5 elements [niobium (Nb), tantalum (Ta) and dubnium (Db, $Z=105$)] at very low concentrations in aqueous solutions media is of interest to understand the roles that hydrolysis and relativistic effects play in the complex formation of these elements. For example, Nb and Ta form chlorocomplexes of the same type, MCl_6^- , in the absence of water. With the addition of water, the elements begin to hydrolyze in dissimilar ways [1, 2], leading to differences in complex formation and in

extraction behavior. Understanding these differences is hindered not only by the plethora of species formed, but also by the tendency of Nb and Ta to form polynuclear complexes when macroscopic amounts of the metal are present.

Based upon previous experiments [3-8], Pershina has postulated that, in hydrochloric acid (HCl), the change from cationic to anionic species occurs between 5 and 7 M HCl for Nb and between 6 and 8 M HCl for Ta (See Fig. 1 in [2]). Well-defined chemical systems that probe the region where the complexes formed by the group 5 elements change from cationic to anionic can be used to study and evaluate complex formation of the group 5 transactinide element, Db. It is predicted [9], that relativistic effects in the transactinide elements ($Z \geq 104$) will lead to deviations from chemical trends established by the lighter homologues in a periodic table group, as these effects increase with Z^2 of elements. To test for deviations, it is necessary to compare the chemical behavior of the transactinide elements to that of the lighter homologues in the group.

Previous transactinide experiments with the chloride, bromide and fluoride complexes of Db (see [10] for a summary) have shown that Db is a member of group 5 and exhibits chemical behavior that is more similar to Nb and protactinium (Pa) than to Ta. However, the experiments were usually performed in mixed acid media and/or under conditions under which equilibrium was not assured, making interpretation of the results difficult. It is preferable to concentrate on chemical systems that demonstrate selectivity between the members of one group of the periodic table, yield information regarding complex formation and reach equilibrium within a known time.

Systems that are suitable for studying transactinide elements must fulfill three main requirements. First, transactinide elements are produced solely through the use of nuclear reactions, typically with cross sections on the order of nano- to picobarns. For dubnium, this yields only a few atoms per hour, requiring one atom-at-a-time chemistry as the dubnium atom will only interact with atoms of its surroundings and not with other dubnium atoms. To obtain reproducible results, it is necessary to choose systems in which the dubnium atom undergoes the same chemical reaction multiple times. Liquid-liquid extraction is an example of such a system and has been used successfully to study transactinides [11]. Second, in addition to the few transactinide atoms of interest, a large excess of un-reacted beam, fission fragments and transfer products from reactions with the target or target backing are also created in the nuclear reactions. To investigate differences in chemistry between the transactinide and its lighter homologues, the use of a physical preseparator to separate the element of interest from the transfer products and un-reacted beam is advantageous prior to the chemistry set-up. After physical preseparation, chemistry is no longer required to separate the group of interest from the rest of the periodic table. Third, ^{262}Db , with a half-life of 34 s, is the longest lived isotope of dubnium that has been confirmed in independent experiments. It is therefore mandatory for the system to reach equilibrium within 10 seconds, to ensure that chemistry is completed before a majority of the dubnium atoms have decayed.

In this paper, we report on the liquid-liquid extraction of cyclotron-produced isotopes of Nb and Ta from hydrochloric acid media by bis(2-ethylhexyl) hydrogen phosphate (HDEHP) and bis(2-ethylhexyl) hydrogen phosphite (BEHP) as a function of mixing time and acid concentration. Figure 1 shows the chemical structures of HDEHP

and BEHP. In organic media, HDEHP predominantly acts as a cationic complex extractor. The ligand also has a tendency to form dimers of the following type in organic media [12]:



In contrast, BEHP extracts neutral complexes and exists as a monomer in organic solutions.

Extractions with HDEHP and BEHP have been previously investigated using a variety of solvents and macroscopic quantities of Ta and tracer quantities of Nb [13-15]. However, to best replicate conditions under which dubnium will be studied, it is necessary to use 'carrier-free' trace level amounts ($\leq 10^{-16}$ M) of Nb and Ta, formed in these nuclear reactions, to avoid the formation of polymeric species that is often seen in the elements. On-line studies using short-lived accelerator-produced Nb and Ta were performed at Lawrence Berkeley National Laboratory LBNL to best replicate the experimental conditions present during a transactinide experiment.

2. Experimental

2.1. Materials

Bis(2-ethylhexyl) hydrogen phosphate (97%) and bis(2-ethylhexyl) hydrogen phosphite (96%) were purchased from Aldrich Chemical Company and used as received. Chloroform (ACS reagent, $\geq 99.8\%$) was obtained from Sigma-Aldrich, Inc. The hydrochloric acid (puriss.) used for the preparation of solutions was obtained from Fluka Chemika and assayed at 37%.

2.2. Production and pre-separation of short-lived Nb and Ta isotopes

On-line experiments were performed at the 88-Inch Cyclotron at Lawrence Berkeley National Laboratory (LBNL). Short lived ^{170}Ta ($T_{1/2} = 6.76$ m) was produced in the $^{124}\text{Sn}(^{51}\text{V},5n)$ reaction. The $^{74}\text{Se}(^{18}\text{O},p3n)$ reaction was used for the production of $^{88\text{g}}\text{Nb}$ ($T_{1/2} = 14.5$ m). Beam energies at the center of the target were 215.0 MeV for $^{51}\text{V}^{11+}$ and 68.9 MeV for $^{18}\text{O}^{4+}$, in the laboratory frame.

The ^{51}V or ^{18}O beam passed through a $(40\text{-}45)$ $\mu\text{g}/\text{cm}^2$ carbon vacuum window at the entrance to the Berkeley Gas-filled Separator (BGS) and a negligible amount of helium gas before entering the target. For the production of $^{88\text{g}}\text{Nb}$, a target of $384\text{-}\mu\text{g}/\text{cm}^2$ ^{74}Se , deposited on $40\text{-}\mu\text{g}/\text{cm}^2$ C and covered with $5\text{-}\mu\text{g}/\text{cm}^2$ Au, was used. The typical beam intensity of the $^{18}\text{O}^{4+}$ projectiles was 75 particle·nA. A 20-mm diameter self-supporting $586\text{-}\mu\text{g}/\text{cm}^2$ ^{124}Sn target was used for the production of ^{170}Ta , with typical $^{51}\text{V}^{11+}$ beam intensities of 25 particle·nA. Figure 2 contains a schematic of the experimental setup. The Nb and Ta evaporation residues (EVRs) recoiling out of the target were separated in the BGS from the beam and most unwanted reaction products based upon their differing magnetic rigidities in the 66-Pa He of the BGS [16, 17]. The magnetic rigidity for the Nb and Ta EVRs were estimated as previously described [18] and experimentally determined to be 0.95 and 1.59 T·m, respectively. After traveling through the BGS, the recoiling atoms were slowed down by passing through a 3.3- μm Mylar window at the entrance to the 40 mm-deep Recoil Transfer Chamber (RTC) [19, 20]. The EVRs were then thermalized in approximately 1.3 bar of helium gas in the RTC. Due to the larger momentum of the ^{51}V beam, the Ta EVRs have a larger kinetic energy than the Nb EVRs. To account for this the Ta EVRs were degraded by passing

through an additional 6.0- μm thick Mylar foil prior the RTC window, to ensure that they were thermalized in the RTC.

2.3. On-line extraction Experiments

Helium gas at flow rates of 1.6 - 1.8 L/min was seeded with potassium chloride aerosols prior to entering the RTC. The aerosol particles were produced in an oven at a temperature of 650 °C. After thermalization in the RTC, the EVRs were captured on the aerosols and transported through a 2-mm i.d. and ~20 meter long stainless steel capillary to the chemistry setup. The transport efficiency of the gas-jet system was determined to be ~70% in separate experiments [21].

The aerosol particles containing the EVRs were deposited on small platinum foils at the exit of the gas-jet capillary. The aerosols were allowed to collect for 10 minutes and then the collected KCl was dissolved in 100 μL of hydrochloric acid (HCl). The solution was then transferred to a centrifuge cone containing an additional 3900 μL of the same acid solution. The amount of Nb and Ta transferred into the 4000 μL aqueous phase from the aerosol residue was determined to be $\sim 10^{-18}$ moles, giving a metal concentration of 10^{-16} M in the aqueous phase prior to mixing. An equal volume of 0.01 M HDEHP or 0.01 M BEHP in chloroform was added to the aqueous solution and the two phases were mixed for up to 90 s using a vortex mixer. The samples were centrifuged for 20 seconds and a 3 mL aliquot of each phase was removed for assay.

To minimize the effect of variations in sample geometry and detector efficiency, both aliquots were assayed using the same HPGe γ -ray detector. The first sample measured was usually the aliquot containing the smaller fraction of Nb or Ta to minimize statistical error due to decay. Each aliquot was counted for 4 minutes with a 15 seconds

interval allotted for changing the samples. Due to the short half-lives of the nuclides, the data obtained from the second aliquot measured had to be corrected for decay. Five parallel experiments were performed for each acid concentration or mixing time. Extraction yields were determined using:

$$E(\%) = \frac{[\text{Me}]_{\text{org}}}{[\text{Me}]_{\text{org}} + [\text{Me}]_{\text{aq}}} \times 100 \quad (2)$$

where E(%) is the percentage of the metal ions in the organic phase. Relative metal concentrations in each phase were determined by the γ -ray radioactivity in each sample. Final values for the extraction yield at each set of conditions were determined by taking a weighted mean of the values for the five samples. The error was determined from the statistical counting uncertainty using standard error propagation techniques and the results are reported at the one sigma level.

To determine the role that adsorption to the surface of the vial played, the yield of Nb and Ta for each trial was normalized based upon the integrated beam current. The yield values were then corrected for the volume of the aliquot that was counted and the decay of the isotopes during chemistry and measurement of the two samples. These values were compared to a series of trials in which the aerosol was dissolved directly into 3.0 mL of aqueous phase and subsequently counted, without chemistry being performed. The amount Nb or Ta observed in each sample comprised $\geq 95\%$ of the expected activity.

3. Results and Discussion

3.1. Extraction Kinetics

Extraction yields as a function of phase contact time (mixing time) were studied for both of the systems. Mixing times of 10 – 60 s were used for the investigation of Nb, while Ta was studied over times ranging from 10 – 90 s. The results of the kinetics

experiments are shown in Figures 3 and 4 for the HDEHP system, and in Figures 5 and 6 for the BEHP system.

Equilibrium in the HDEHP system was not observed for Ta at any acid concentration up to the maximum 90 s mixing time (See Fig. 4). The amount of time needed for equilibrium to be reached in the Nb-HDEHP systems depended upon the acid concentration used (See Fig. 3). At 1 – 6 M HCl equilibrium was reached within 30 s, whereas equilibrium was reached within 20 s at 9 M HCl and 10 s at 11 M HCl.

Equilibrium times of <10 s were observed at all acid concentrations when the extraction of Nb with BEHP studied (See Fig. 5). For Ta-BEHP, the amount of time needed to reach equilibrium was dependent upon the acid concentration (See Fig. 6). Equilibrium was reached within 40 s at 1, 3 and 6 M HCl, and not observed within 90 s at HCl concentrations of 11 and 9 M.

Based on these results, a mixing time of 60 s was chosen for experiments with Nb, ensuring equilibrium regardless of acid concentration. A mixing time of 90 s was chosen for the tantalum experiments, as the short half-life of ^{170}Ta prevented mixing for longer times.

3.2. Niobium

The extraction of Nb into 0.01 M HDEHP or 0.01 M BEHP in chloroform was studied over a range of 1-11 M HCl. The results of these experiments are shown in Figure 7. Low extraction yields of Nb by BEHP were observed. The highest yields of $(15\pm 1)\%$ and $(10\pm 1)\%$ were observed at 11 and 1 M HCl, respectively, while 6 M HCl had the lowest yield of $(2.6\pm 0.3)\%$. For the extractions with HDEHP, the observed yield was greater than 90% for the three lower acid concentrations investigated (1, 3, and 6 M

HCl). When the acid concentration was increased above 6 M HCl, the yields decreased to (55±2)% at 9 M HCl and (15±1)% at 11 M HCl. The results from the HDEHP extractions are in agreement with those shown by Kimura when Nb was extracted from HCl solutions into 50% HDEHP in toluene [14]. However, Das *et. al* observed that the Nb extraction yield increased from 18.6 to 32.2 % as the HCl concentration was increased from 0.8 to 5.6 N when using an organic phase of 0.01 M HDEHP in carbon tetrachloride [13]. Both studies were performed using tracer levels of ⁹⁵Nb.

Experiments with macroscopic amounts of Nb have determined that the Nb species change from polymeric cationic complexes based on Nb(OH)₂Cl₂⁺ and NbOCl₂⁺ at low HCl concentrations to neutral complexes like Nb(OH)₂Cl₃ around 3 – 6 M HCl [3]. At 6 – 9 M HCl, the predominant species in solution is Nb(OH)₂Cl₄⁻ [4, 22] and is replaced by NbOCl₄⁻, NbOCl₅²⁻ and NbCl₆⁻ above 11 M HCl [6]. Campderrós *et. al* suggest the formation of cationic HNbOCl₃⁺ complexes if the H⁺ concentration is raised above 8 M HCl [23]. From what is known about Nb complex formation, HDEHP and BEHP, the following general mechanisms for the extraction of Nb by HDEHP and BEHP can be postulated:

1. Ionic association of HDEHP dimers with cationic complexes at low HCl concentrations:

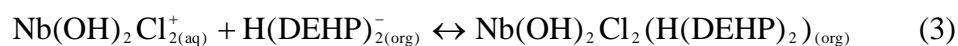

2. Adduct formation of neutral complexes and HDEHP dimers or BEHP at 3 - 6 M HCl:

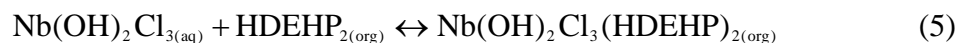



3. Ionic association of HDEHP dimers with cationic complexes at high HCl concentrations:



Based upon our data, we can determine which mechanisms contribute to the total extraction. As BEHP only extracted small quantities of Nb, we conclude that $\text{Nb(OH)}_2\text{Cl}_{3(\text{aq})}$ is either not present in large amounts, or is not extractable through adduct formation with BEHP and HDEHP, thus eqs. (5) and (6) do not significantly contribute to the extraction. We also observed a decreasing extraction yield above 6 M HCl, suggesting that cationic Nb species are not present in solution, and by extension, that eq. (7) does not contribute significantly to the extraction. Thus, eqs. (3) and (4) present the dominant extraction mechanisms.

3.3. Tantalum

Tantalum was extracted into solutions of 0.01 M HDEHP or 0.01 M BEHP in chloroform from 1-11 M HCl. The results are shown in Figure 7. For the extractions with BEHP, the yield decreased from 1 to 3 M HCl and began increasing after the HCl concentration was raised above 6 M. A maximum extraction of $(68 \pm 2)\%$ was observed for 11 M HCl and a minimum of $(11 \pm 1)\%$ at 3 and 6 M HCl. Over the whole acid concentration range studied, the extraction of Ta by HDEHP remained above 78%. A similar extraction pattern by HDEHP was seen from solutions of up to 1 M HCl in experiments by Kimura [14], however extraction yields were below those observed in this work. Das also investigated the extraction of Ta by 0.01 M HDEHP in carbon tetrachloride and observed a decreasing extraction yield when the HCl concentration was

raised above 1.6 N HCl [13]. Both of these experiments were performed using ^{182}Ta , produced in the neutron irradiation of ^{181}Ta , and contain significant amounts of carrier. Differences between the experiments presented in [13, 14] and those presented in this work are likely due to formation of different Ta complexes. When Ta is present in solution in macroscopic amounts, the formation of polynuclear species in the form of $(\text{TaO}_{>1}\text{Cl}_{<3}\text{nCl})_x$ hinders its extraction [24]. In this work, the Ta concentration was $\sim 10^{-16}$ M, preventing the formation of polynuclear species. In addition, the kinetics of forming complexes with O and OH^- are slow. As such, on-line produced Ta may have fewer of these complexes than off-line tracer solutions.

The data from the HDEHP and BEHP extractions in Fig. 7 show that Nb and Ta have similar chemical behavior at ≤ 6 M HCl. This indicates that Nb and Ta form similar complexes at ≤ 6 M HCl, leading to the conclusion that Ta *may be* forming complexes cationic such as $\text{Ta}(\text{OH})_2\text{Cl}_2^+$ and TaOCl_2^+ . In addition, Campderrós *et. al* have suggested that $\text{Ta}(\text{OH})\text{Cl}_4$ exists at low HCl concentrations and can be extracted by tributyl phosphate [23], a neutral complex exchanger similar to BEHP. Based on these assumptions, the following mechanisms can be *tentatively* postulated for extractions at ≤ 6 M HCl:

1. Ionic association of HDEHP with cationic complexes:

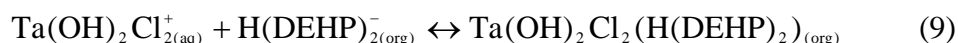

2. Adduct formation with BEHP at low HCl concentrations:

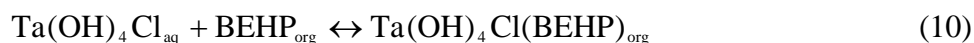

At high acid concentrations, anionic Ta complexes should be the dominant species in solution. Electrodialysis experiments have shown that Ta begins to form anionic species at acid concentrations approximately 1 M higher than those seen for Nb [25, 26]. This would suggest the formation of $\text{Ta}(\text{OH})_2\text{Cl}_4^-$ at >6 M HCl, TaOCl_4^- at > 8 M HCl and TaCl_6^- above 12 M HCl [2]. We observed high extraction of Ta by both HDEHP and BEHP at acid concentrations from 9 - 11 M, indicating that HDEHP and BEHP either neutral complexes or that the formation of cationic species becomes favorable again with increasing hydrogen ion concentration. If Ta has the tendency to form cationic complexes analogous to those observed by Nb at high hydrogen ion concentrations, such as HTaOCl_3^+ , then the high extraction yields *may be* explained by ionic association of HDEHP and BEHP with cationic complexes:



4. Conclusion

The extraction of group 5 elements, Nb and Ta, from acid media by 0.01 M HDEHP and 0.01 M BEHP was investigated as a function of HCl concentration and phase mixing time in this work. Different behaviors for Nb and Ta were observed when comparing extraction yield as a function of mixing time, as well as a function of HCl concentration. By increasing the HCl concentration, it was possible to observe the decrease in the formation of cationic species for Nb. For Ta the existence of highly extractable species was observed up to 11 M HCl, where the formation of anionic Ta species should dominate. The higher acid concentrations provide suitable separation of Nb and Ta for both of the systems investigated. It is also possible to use the higher acid

concentrations to investigate the kinetics of dubnium and determine its similarity to Nb or Ta.

Acknowledgements

The authors gratefully acknowledge the staff of the 88-inch cyclotron at Lawrence Berkeley National Laboratory for providing the ^{51}V and ^{18}O beams. Financial support was provided by the Director, Office of High Energy and Nuclear Physics, Nuclear Physics Division of the U.S. Department of Energy, under contract DE-AC02-05CH11231.

5. References

- [1] Pershina, V.: *Radiochim. Acta* **80**, 65 (1998).
- [2] Pershina, V.: *Radiochim. Acta* **80**, 75 (1998).
- [3] Kim, J. I., Lagally, H., Born, H.-J.: *Anal. Chim. Acta* **64**, 29 (1973).
- [4] Kanzelmeyer, J. H., Ryan, J., Freund, H.: *J. Am. Chem. Soc.* **78**, 3020 (1956).
- [5] Davies, J. E. D., Long, D. A.: *J. Chem. Soc.*, 2560 (1968).
- [6] Sabatini, A., Bertini, I.: *Inorg. Chem.* **5**, 204 (1966).
- [7] Nabivanets, B. I.: *Rus. J. Inorg. Chem.* **7**, 1428 (1962).
- [8] Nabivanets, B. I.: *Rus. J. Inorg. Chem.* **9**, 590 (1964).
- [9] Pershina, V.: *Chem. Rev.* **96**, 1977 (1996).
- [10] Schädel, M.: *Angew. Chem. Intl. Ed.* **45**, 368 (2006).
- [11] Schädel, M., *The chemistry of the superheavy elements* (Kluwer Academic Publishers, Dordrecht, The Netherlands, 2003).
- [12] Peppard, D. F., Ferraro, J. R., Mason, G. W.: *Journal of Inorganic and Nuclear Chemistry* **7**, 231 (1958).
- [13] Das, N. R., Nandi, B., Bhattacharyya, S. N.: *J. Radioanal. Chem.* **62**, 53 (1981).
- [14] Kimura, K.: *Bulletin Chem. Soc. Japan* **33**, 1038 (1960).
- [15] Kimura, K.: *Bulletin Chem. Soc. Japan* **34**, 63 (1961).
- [16] Gregorich, K. E., Ninov, V.: *J. Nucl. Radiochem. Sci.* **1**, 1 (2000).
- [17] Ninov, V., Gregorich, K., McGrath, C. A., in *ENAM 98: Exotic Nuclei and Atomic Masses*, edited by B. M. Sherrill, D. J. Morrissey and C. N. Davids (American Institute of Physics, Woodbury, New York, 1998), p. 704.
- [18] Gregorich, K. E., Loveland, W., Peterson, D., Zielinski, P. M., Nelson, S. L., Chung, Y. H., Düllmann, C. E., Folden III, C. M., Aleklett, K., Eichler, R., Hoffman, D. C., Omtvedt, J. P., Pang, G. K., Schwantes, J. M., Soverna, S., Sprunger, P., Sudowe, R., Wilson, R. E., Nitsche, H.: *Phys. Rev. C* **72**, 014605 (2005).

- [19] Kirbach, U. W., Folden III, C. M., Ginter, T. N., Gregorich, K. E., Lee, D. M., Ninov, V., Omtvedt, J. P., Patin, J. B., Seward, N. K., Strellis, D. A.: Nucl. Instrum. Methods A **484**, 587 (2002).
- [20] Kirbach, U. W., Gregorich, K., Ninov, V., Lee, D. M., Patin, J. B., Shaughnessy, D. A., Strellis, D. A., Wilk, P. A., Hoffman, D. C., Nitsche, H.: Lawrence Berkeley National Laboratory Annual Report; (1999).
- [21] Düllmann, C. E., Folden III, C. M., Gregorich, K. E., Hoffman, D. C., Leitner, D., Pang, G. K., Sudowe, R., Zielinski, P. M., Nitsche, H.: Nucl. Instrum. Methods A **551**, 528 (2005).
- [22] Kanzelmeyer, J. H., Freund, H.: Anal. Chem. **25**, 1807 (1953).
- [23] Campderros, M. E., Marchese, J.: J. Membr. Sci. **164**, 205 (2000).
- [24] Schäfer, H.: Angewandte Chemie **71**, 152 (1959).
- [25] Nabivanets, B. I.: Rus. J. Inorg. Chem. **9**, 590 (1964).
- [26] Nabivantes, B. I.: Rus. J. Inorg. Chem. **7**, 1428 (1962).

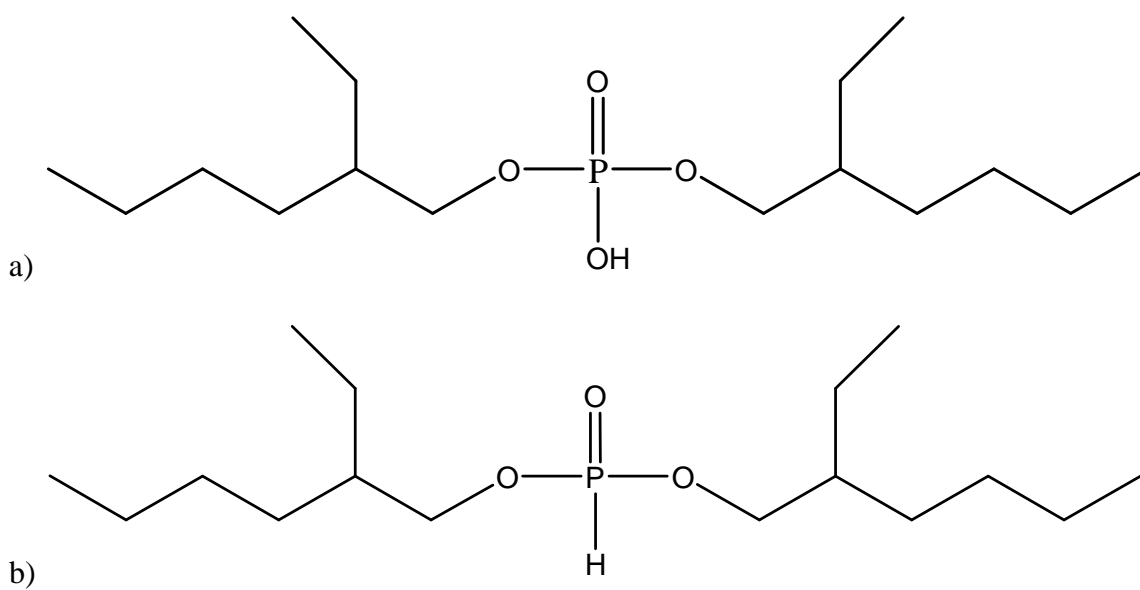

Figure 1: Chemical structure of a) bis(2-ethylhexyl) hydrogen phosphate (HDEHP) and b) bis(2-ethylhexyl) hydrogen phosphite (BEHP).

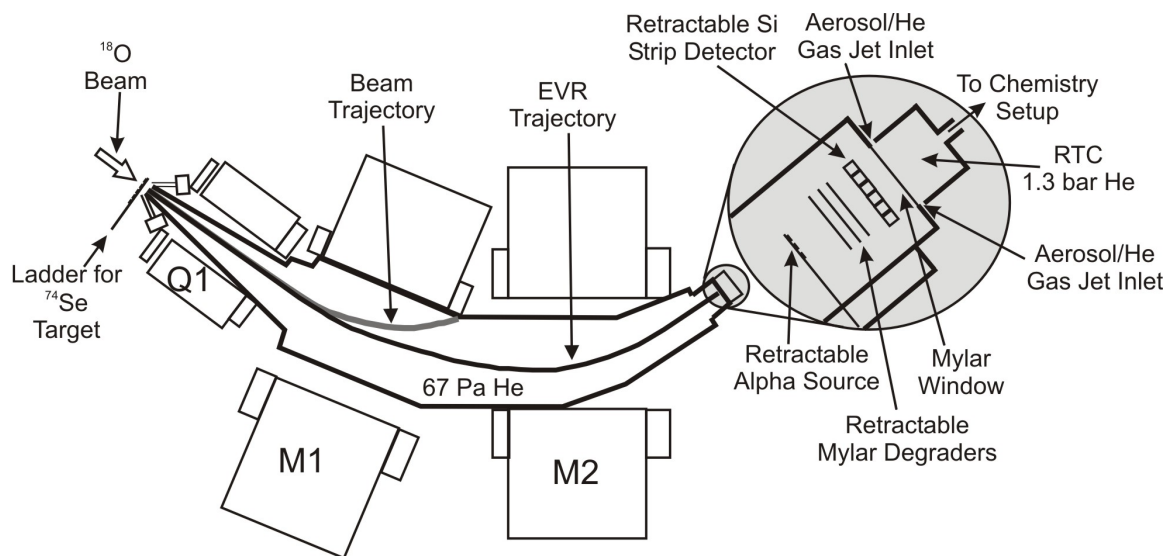

Figure 2: Schematic of the BGS at LBNL in the configuration required for chemistry experiments with pre-separation. Modified from [21]. The quadrupole (Q1), gradient field dipole (M1) and flat field dipole (M2) magnets used for separation of the EVR's from the beam and unwanted reaction products are labeled.

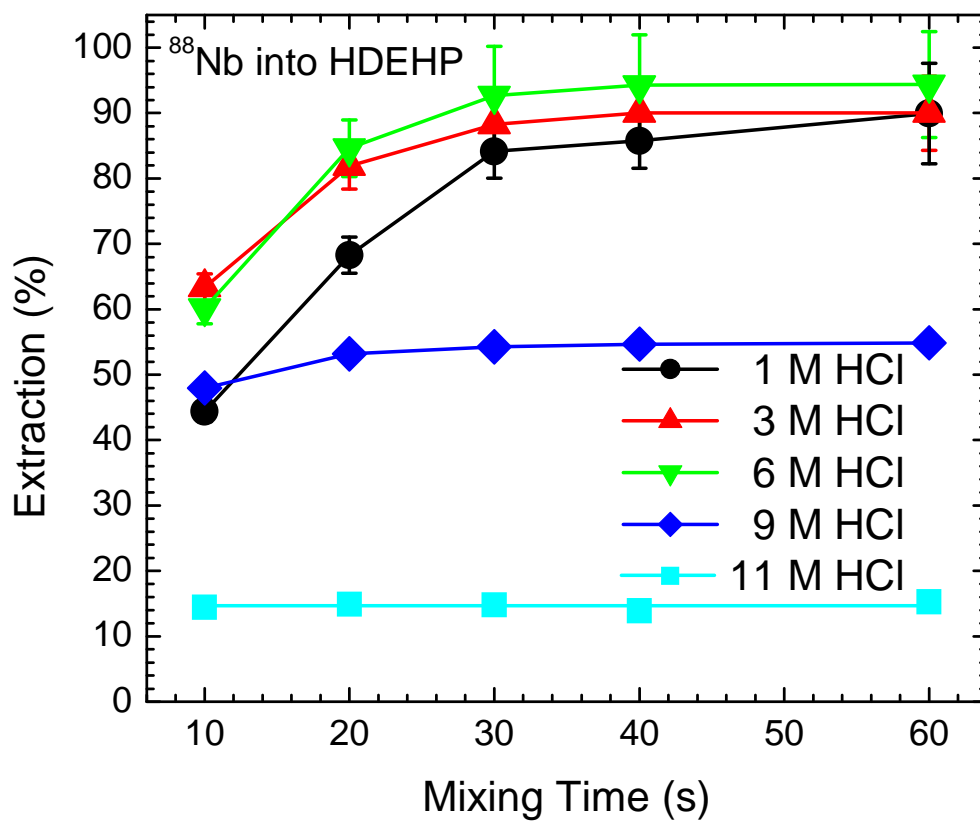

Figure 3: Extraction of niobium from 1 (●), 3 (▲), 6 (▼), 9 (◆) and 11 (■) M HCl by 0.01 M HDEHP in CHCl_3 as a function of mixing time. Error bars are shown when larger than the symbol.

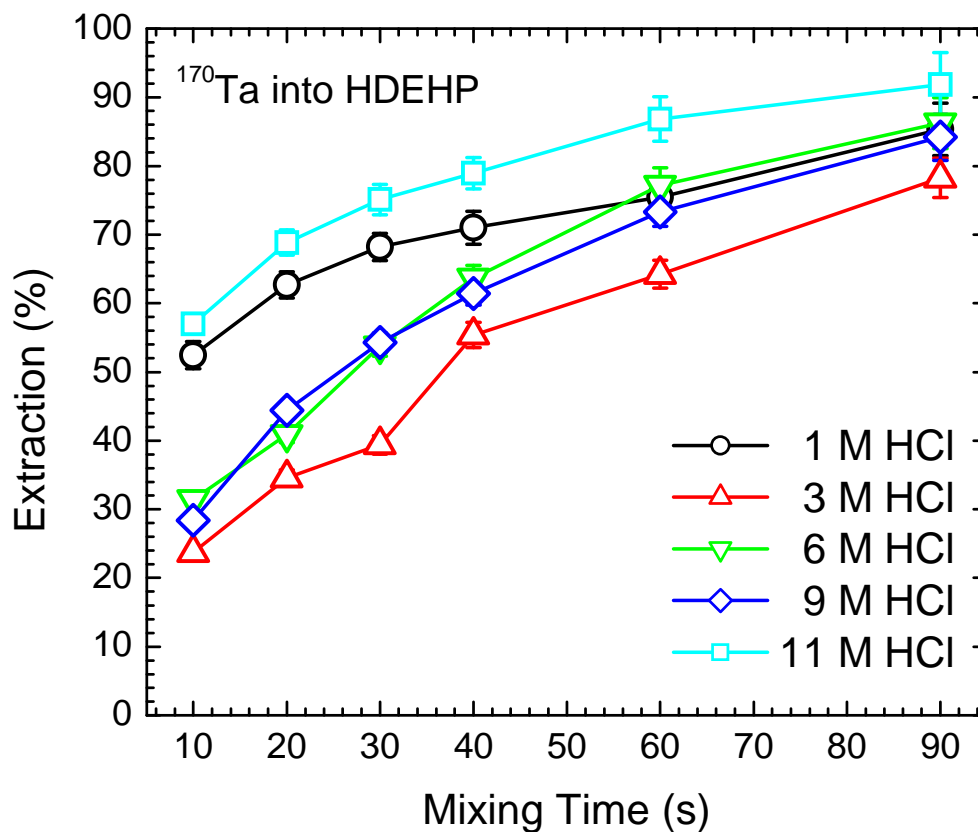

Figure 4: Extraction of tantalum from solutions of 1 (○), 3 (△), 6 (▽), 9 (◇) and 11 (□) M HCl by 0.01 M HDEHP in CHCl₃ as a function of mixing time. Error bars are shown when larger than the symbols.

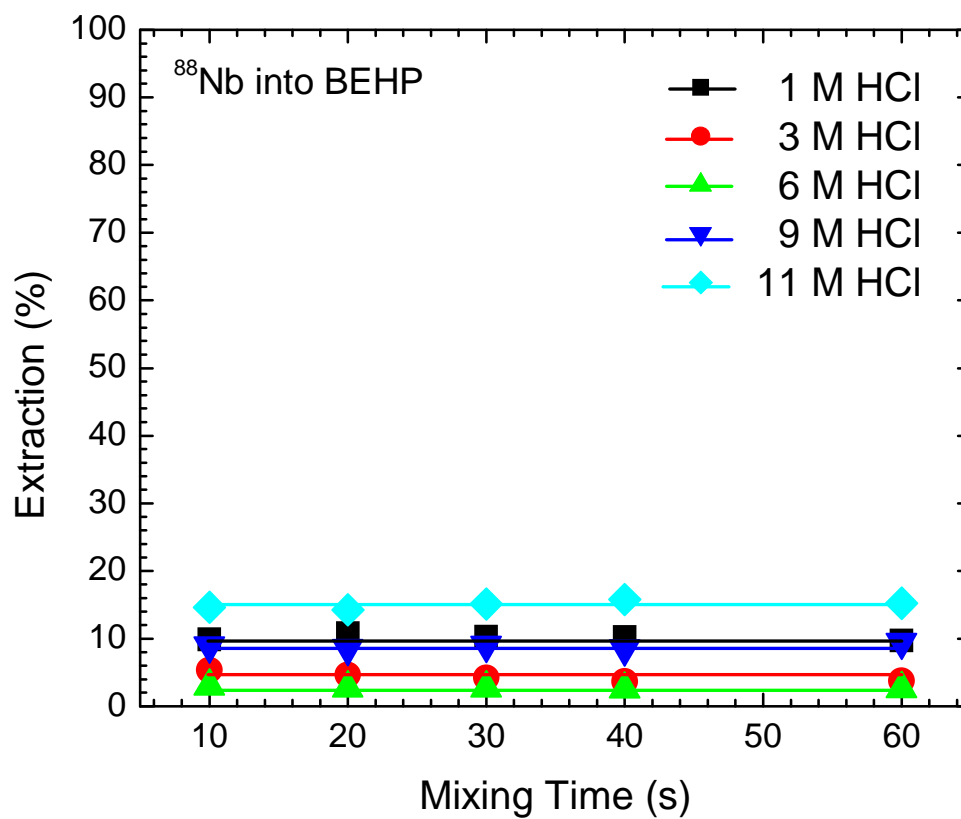

Figure 5: Extraction of niobium from 1 (●), 3 (▲), 6 (▼), 9 (◆) and 11 (◊) M HCl by 0.01 M BEHP in CHCl_3 as a function of mixing time. Error bars are smaller than the symbols.

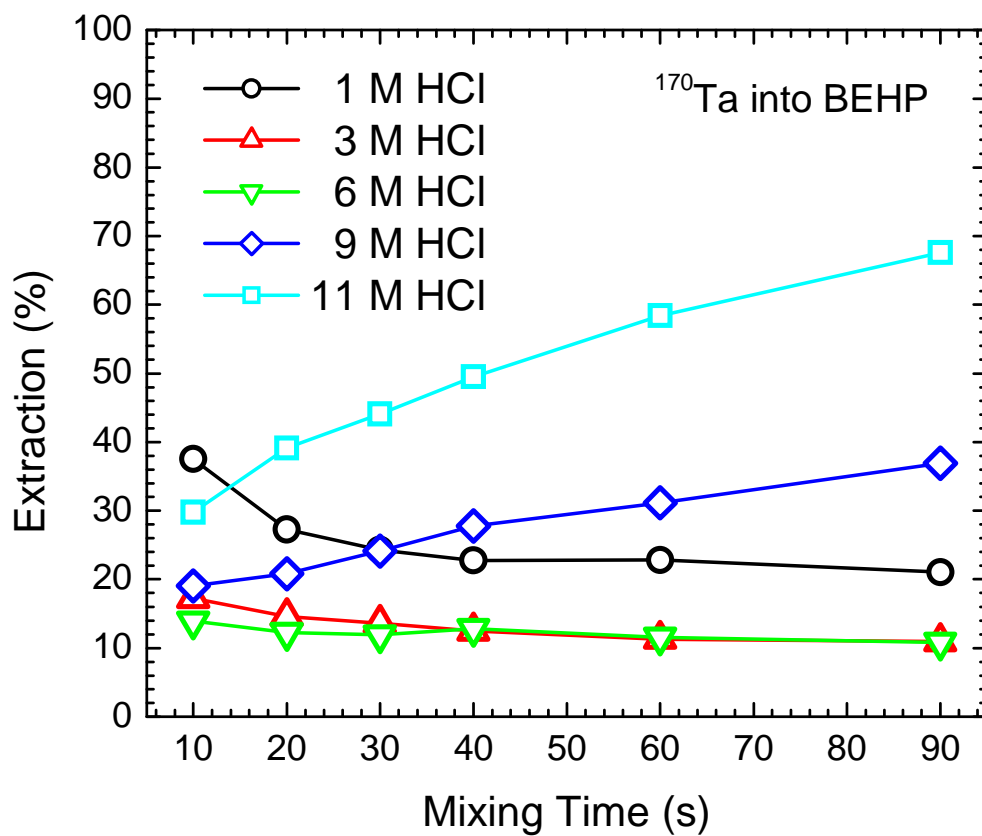

Figure 6: Extraction of tantalum from solutions of 1 (○), 3 (△), 6 (▽), 9 (◇) and 11 (□) M HCl by 0.01 M BEHP in CHCl₃ as a function of mixing time. Error bars are smaller than the symbols.

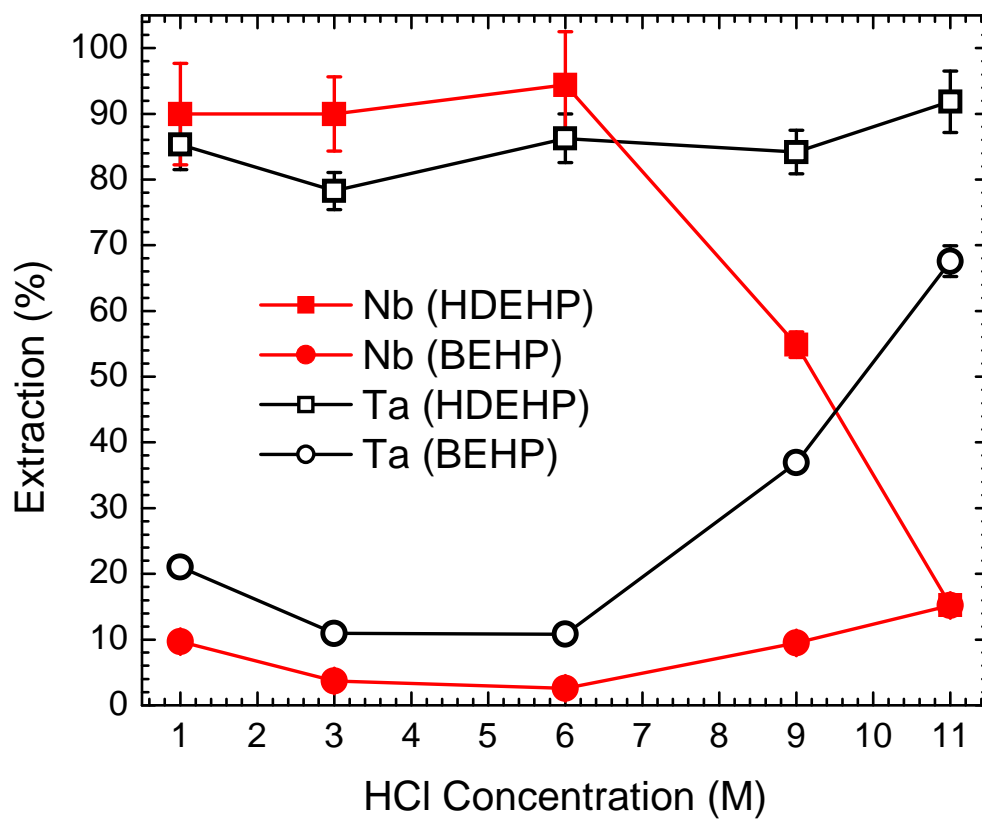

Figure 7: Comparison of extraction yields for niobium (■,●, after 60 s mixing) and tantalum (□,○, after 90 s mixing). The organic phase was 0.01 M HDEHP (■,□) and 0.01 M BEHP (●,○) in CHCl_3 . The aqueous phase consisted of 1 - 11 M HCl. Error bars are shown when larger than the symbols.