

Lawrence Berkeley National Laboratory

Lawrence Berkeley National Laboratory

Title

WINDOW 6.2/THERM 6.2 Research Version User Manual

Permalink

<https://escholarship.org/uc/item/4rx784fq>

Author

Mitchell, Robin

Publication Date

2008-08-18

Program Description

A PC Program

WINDOW 6.2 / THERM 6.2 Research Version User Manual



For Analyzing Window Thermal Performance

Windows & Daylighting Group
Building Technologies Program
Environmental Energy Technologies Department
Lawrence Berkeley National Laboratory
Berkeley, CA 94720 USA

© Regents of the University of California

This work was supported by the Assistant Secretary for Energy Efficiency and Renewable Energy, Office of Building Technology, State and Community Programs, Office of Building Research and Standards of the U.S. Department of Energy under Contract No. DE-AC02-05CH11231.

WINDOW 6.2/ THERM 6.2 Research Version User Manual

Robin Mitchell, Christian Kohler, Joe Klems, Mike Rubin, and Dariush Arasteh
Windows and Daylighting Group
Building Technologies Department
Environmental Energy Technologies Division
Lawrence Berkeley National Laboratory
Berkeley, California 94720
<http://windows.lbl.gov/software/software.html>

Charlie Huizenga and Tiefeng Yu
Center for Environmental Design Research
University of California
Berkeley, California

Dragan Curcija
Carli, Inc
Amherst, Massachusetts

January 2008

© Regents of the University of California

This work was supported by the Assistant Secretary for Energy Efficiency and Renewable Energy, Office of Building Technology, State and Community Programs, Office of Building Systems of the U.S. Department of Energy under Contract No. DE-AC02-05CH11231.

DISCLAIMER

This document was prepared as an account of work sponsored by the United States Government. While this document is believed to contain correct information, neither the United States Government nor any agency thereof, nor The Regents of the University of California, nor any of their employees, makes any warranty, express or implied, or assumes any legal responsibility for the accuracy, completeness, or usefulness of any information, apparatus, product, or process disclosed, or represents that its use would not infringe privately owned rights. Reference herein to any specific commercial product, process, or service by its trade name, trademark, manufacturer, or otherwise, does not necessarily constitute or imply its endorsement, recommendation, or favoring by the United States Government or any agency thereof, or The Regents of the University of California. The views and opinions of authors expressed herein do not necessarily state or reflect those of the United States Government or any agency thereof, or The Regents of the University of California.

Ernest Orlando Lawrence Berkeley National Laboratory
is an equal opportunity employer.

Contents

1. Introduction	1-1
1.1. Overview.....	1-1
1.2. Complex Glazing Features for WINDOW 6.....	1-2
1.2.1. Overview of Changes from WINDOW 5.....	1-2
1.3. Complex Glazing Features for THERM 6.....	1-2
1.3.2. Overview of Changes from THERM 6.....	1-2
2. Quick Start	2-1
2.1. Make a Venetian Blind.....	2-1
2.2. Make the Glazing System with the Venetian Blind.....	2-5
2.3. Glazing System Results.....	2-8
2.3.1. Results at Normal Incidence.....	2-8
2.3.2. Results for Multiple Incident Angles.....	2-8
2.4. Import the Glazing System into THERM.....	2-11
2.5. Import the THERM files into the WINDOW Frame Library.....	2-16
2.6. Create a Window.....	2-17
3. Installation	3-1
3.1. System Requirements.....	3-1
3.2. Installation Procedures for WINDOW.....	3-1
3.2.1. Before Installing WINDOW.....	3-1
3.2.2. Installing WINDOW.....	3-1
3.3. Installation Problems.....	3-10
3.3.1. Not enough disk space.....	3-10
3.3.2. Previous Version Detected.....	3-10
3.4. Uninstalling WINDOW.....	3-11
3.5. Installation Procedures for THERM.....	3-15
3.5.3. Before Installing THERM.....	3-15
3.5.4. Installing THERM.....	3-15
4. WINDOW 6 Detailed Description	4-1
4.1. Preferences.....	4-2
4.2. Shading Layer Library.....	4-8
4.2.1. Shading Layer Library List View.....	4-9
4.2.2. Shading Layer Library Detailed View.....	4-10
4.3. Shade Material Library.....	4-22
4.3.1. Shade Material Library List View.....	4-22
4.3.2. Shade Material Library Detailed View.....	4-24
4.4. Glass Library.....	4-31
4.5. Glazing System Library.....	4-32
4.5.1. Glazing System Library List View.....	4-32
4.5.2. Glazing System Library Detailed View.....	4-33

4.6. Calculation Results	4-42
4.7. Whole Window Results	4-48

5. THERM 6 Detailed Description 5-1

5.1. WINDOW 6 Databases with Shading Devices	5-1
5.2. Importing WINDOW 6 Glazing Systems with Interior or Exterior Shading Devices	5-3
5.2.1. Insert the Glazing System	5-3
5.2.2. Define the Boundary Conditions	5-5
5.3. Importing WINDOW 6 Glazing Systems with an Integral Shading Device	5-9
5.3.1. Insert the Glazing System	5-9
5.3.2. Define the Boundary Conditions	5-11
5.4. Import the THERM 6 Files into the WINDOW 6 Frame Library	5-11

6. Technical Reference 6-1

6.1. Complex Calculation Methodology Overview	6-1
6.1.1. Matrix Method Calculation Engine	6-1
6.1.2. Venetian Blind Algorithms	6-1
6.1.3. Angular Coordinates (Basis)	6-3
6.1.4. Woven Shade Algorithms	6-5
6.2. ISO 9050 Wavelength Set	6-5
6.3. W6 BTDF Output File Documentation	6-6
6.3.1. W6 Full-Basis (145 angles)	6-7
6.1.2. W6 Half-Basis (73 angles)	6-10
6.1.2. W6 Quarter-Basis (41 angles)	6-12
6.4. Documentation for LBNL BSDF XML spec	6-14
6.4. Standards Files used in WINDOW 6	6-21
6.4.1. W5_NFRC_2003.std	6-21

1. Introduction

1.1. Overview

WINDOW 6 and THERM 6 Research Versions are software programs developed at Lawrence Berkeley National Laboratory (LBNL) for use by manufacturers, engineers, educators, students, architects, and others to determine the thermal and solar optical properties of glazing and window systems.

WINDOW 6 and THERM 6 are significant updates to LBNL's WINDOW 5 and THERM 5 computer program because of the added capability to model complex glazing systems, such as windows with shading systems, in particular venetian blinds. Besides a specific model for venetian blinds and diffusing layers, WINDOW 6 also includes the generic ability to model any complex layer if the Transmittance and Reflectance are known as a function of incoming and outgoing angles.

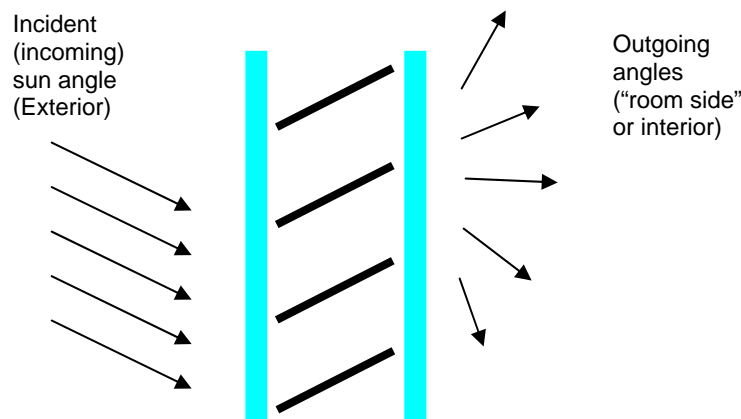

Figure 1-1. Example of the WINDOW 6 modeling capability for venetian blinds.

The algorithms used in these versions of the programs to determine the properties of windows with shading layers are relatively new and should be considered as informative but not definitive.

As such, for windows with shading layers, the results are intended for research purposes only. Pending further validation efforts, results for windows with shading layers should not be used for NFRC certified calculations of design decisions in real buildings.

For further information go to the LBNL website: <http://windows.lbl.gov/software>

All calculations for products without shading layers are identical to those from WINDOW 5.2.

WINDOW 6 Research Version includes all of the WINDOW 5 capabilities with the addition of shading algorithms from ISO15099 which are incorporated into the program, as well as an extension of those algorithms with the matrix calculation method.

THERM 6 Research Version includes all of the THERM 5 capabilities with the addition of being able to import and model WINDOW 6 glazing systems with shading devices. Those THERM 6 files with shading devices can then be imported into the WINDOW 6 Frame Library and whole windows with shading devices can then be modeled in WINDOW 6.

1.2. Complex Glazing Features for WINDOW 6

1.2.1. Overview of Changes from WINDOW 5

The following list describes changes to the WINDOW 6 Research version, which allows the modeling of complex glazing systems, such as venetian blinds, roller shades, and diffusing glass layers. Some of the more complicated changes are described in detail after this brief list.

Program Settings:

- Preferences:
 - A Matrix Calculation method option has been added for the complex glazing system calculations.

Shading Layer Library:

- A Shading Layer Library has been added to define shading systems, such as venetian blinds and diffusing layers, which can then be added as layers in the Glazing System Library.

Glass Library

- It is now possible to define a diffusing layer in the Glass Library, for use in the definition of complex glazing systems.

Glazing System Library

- In the “Layers” section of the Glazing System definition, it is now possible to specify either a glass layer or a shading layer.

Frame Library

- The Frame Library can read THERM 6 files that have WINDOW 6 glazing systems with shading devices.

Window Library

- Whole windows can be defined using glazing systems and THERM 6 files with shading devices.

Calculation Results

- WINDOW 6 displays normal incidence results in the Glazing System Library for glazing systems with shading devices.
- In addition, the program now produces detailed angular calculations for complex glazing systems, which can be viewed with an Excel spreadsheet called “MatrixReader.xls”, which is included in the installation of WINDOW 6.

1.3. Complex Glazing Features for THERM 6

1.3.2. Overview of Changes from THERM 6

THERM 6 can read databases made in WINDOW 6, and interpret the shading device layers.

2. Quick Start

This section explains how to construct and calculate a glazing system with a venetian blind in WINDOW, import the glazing system with the blind into a THERM file, and then reimport the calculated THERM file back into WINDOW.

2.1. Make a Venetian Blind

To make a complex glazing layer, in this case a venetian blind, go to the **Shading Layer Library**, either by:

- clicking on the **Shading Layer Toolbar** button



OR

- going to the **Library** menu and selecting the **Shading Layer** choice.

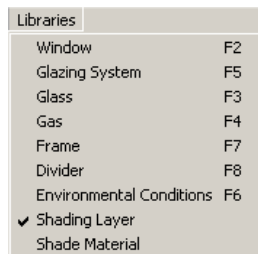

Figure 2-1. Select the Shading Layer choice from the Library menu.

The Shading Layer Library List View will be displayed, as shown below.

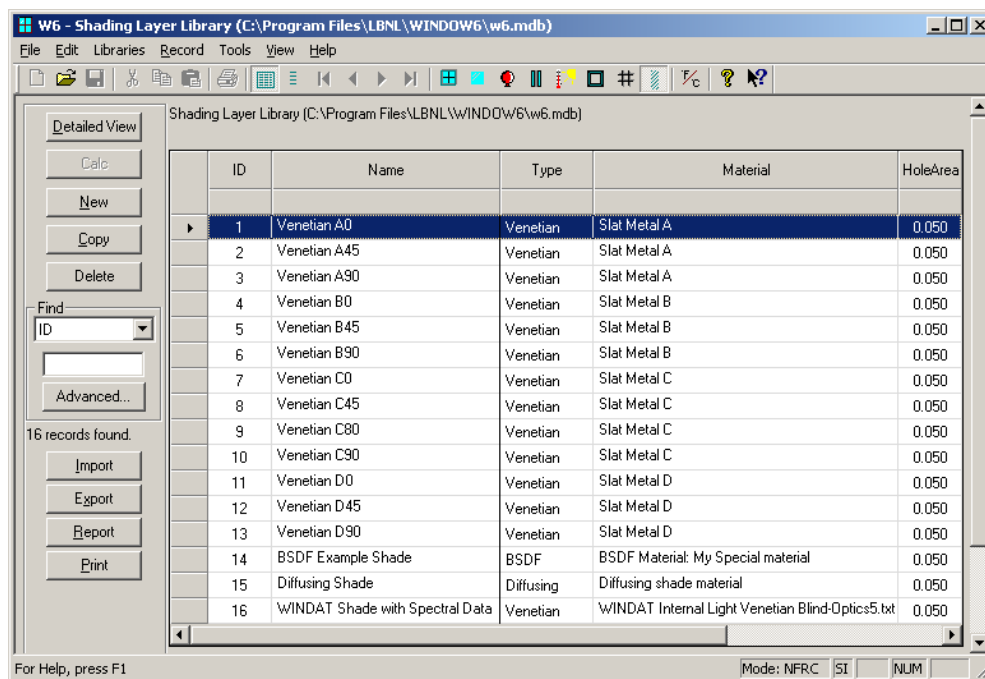

Figure 2-2. The Shading Layer Library Detail View.

To make a new shading layer in the library, follow the steps below:

- Click the **New** button
- The program will display the “Adding a Record” dialog box, and default the record ID to the next sequential number. This number can be changed if desired.

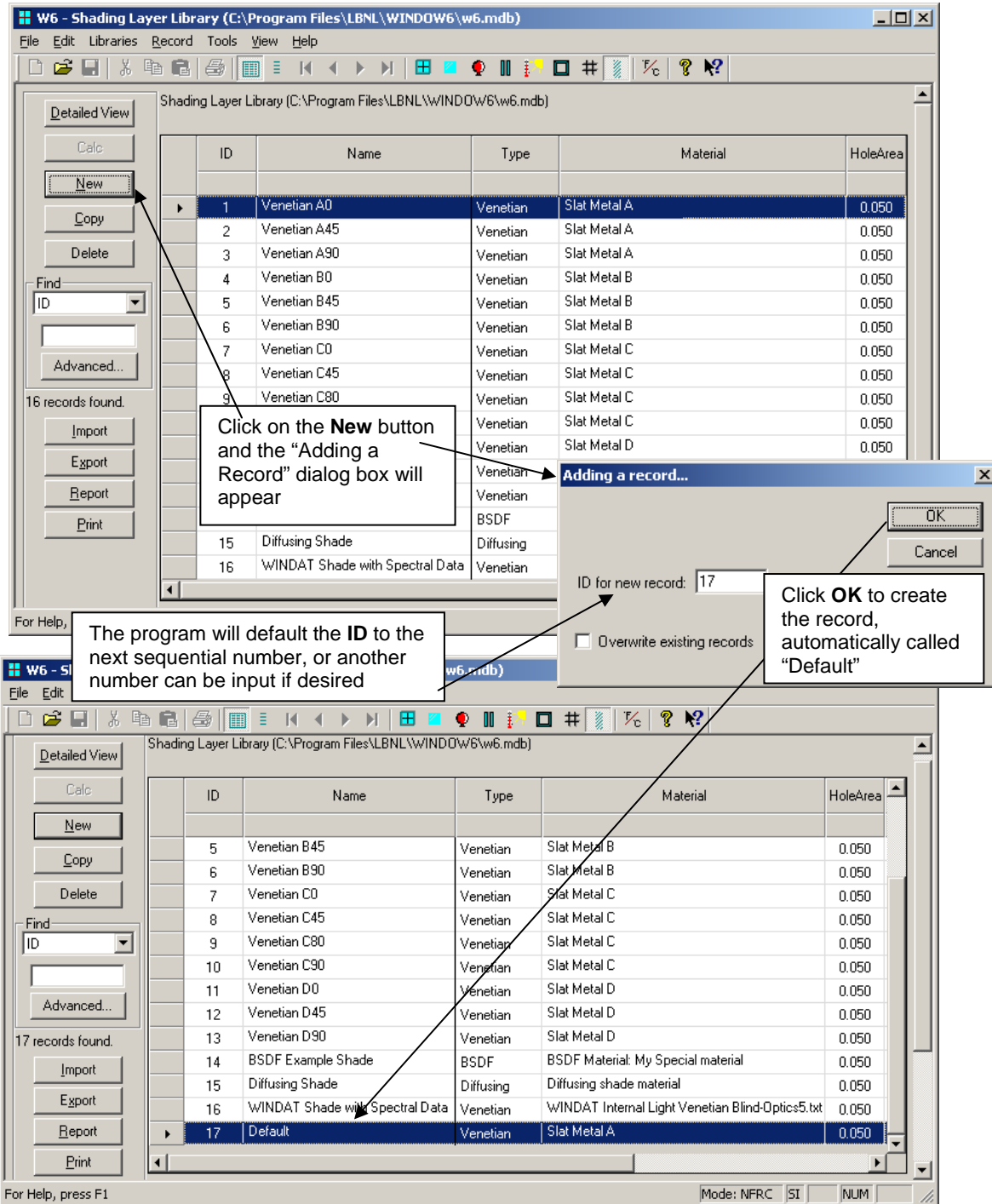

Figure 2-3. Use New to create a new Shading Layer record.

- While still in List View, with the new record highlighted, either double click on the record or click on the **Detailed View** button to show the detailed view of the record
- In the Shading Layer Library Detailed View, shown below, edit the appropriate fields (for more details about the individual input values in this library, see the Detailed Description section of this document).
 - Change the **Name** from “Default” to something appropriate to what is being defined (in this example “Venetian blind, horizontal, - 45 degree tilt”).

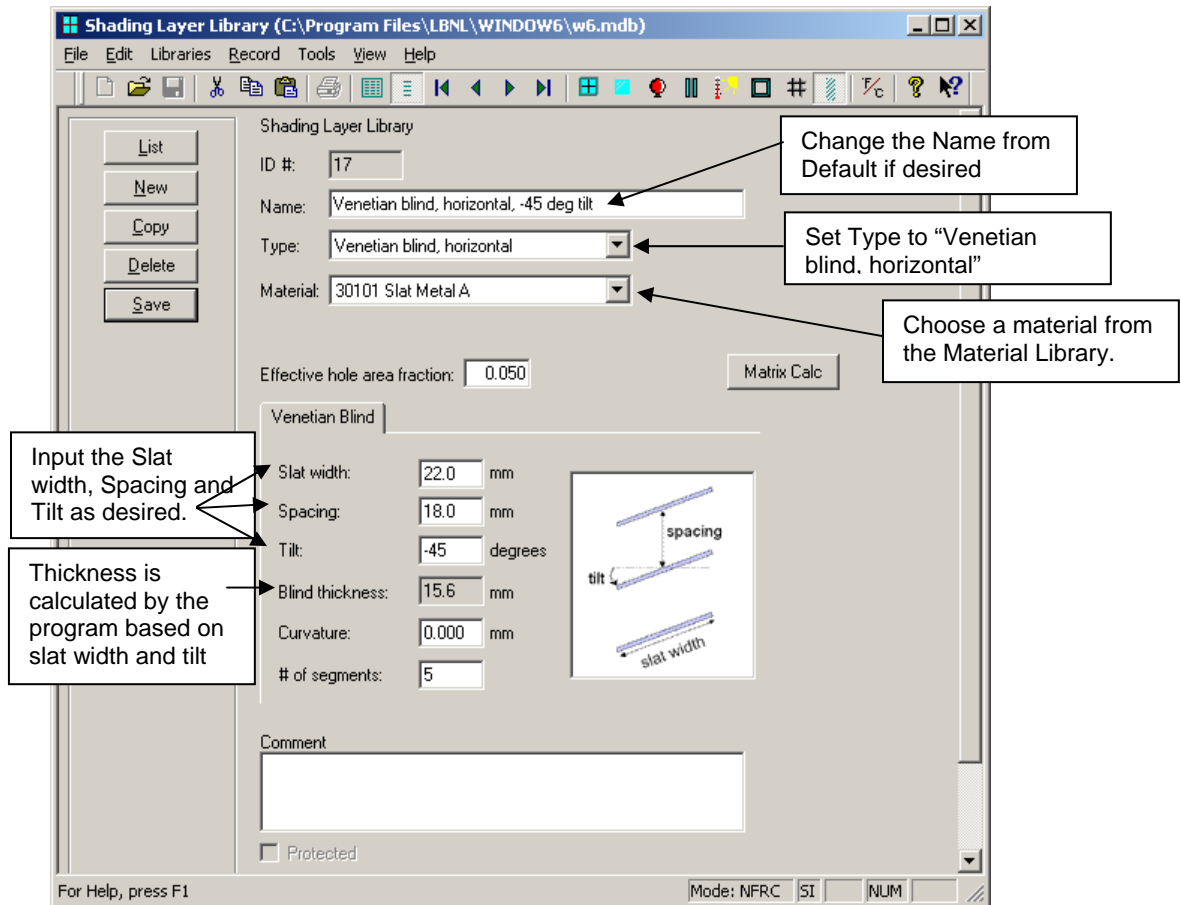

Figure 2-4. Use New to create a new Shading Layer record.

- Set the **Type** to “Venetian blind, horizontal” if it isn’t already (this will cause the **Venetian Blind** tab to be displayed in the lower section of the library).
- Set the **Material** to a value from the pull-down list. This pull-down list reflects the entries in the Shading Material Library. The program comes with a few sample sets (see the Detailed Description section in this document for a more detailed explanation of the Shading Material Library). In the sample library supplied with the program, record # **30100** is a venetian blind material with spectral data imported from the WIS program.
- Leave the **Effective hole area fraction** set at the default value of 0.050.

- Under the **Venetian Blind** tab, input the appropriate values for the blind being defined, for **Slat width**, **Spacing**, **Tilt**, **Curvature** and **# of segments**. For simplicity, in this example, the **Curvature** is set to 0 and therefore the **# of segments** field (the number of segments which will define the curve) is irrelevant. The **Blind Thickness** field is calculated automatically based on the **Tilt** value.

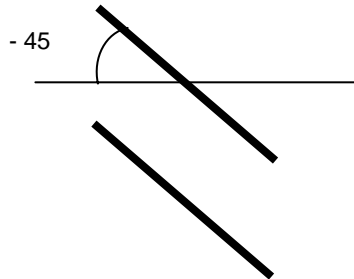

Figure 2-5. Venetian blinds at a - 45 degree tilt.

- Click on the **List View** button and click on the **Yes** button to **Save** the changes to the record.

The new venetian blind shading layer is now defined.

2.2. Make the Glazing System with an Interior Venetian Blind

To add the venetian blind to a glazing system, go to the Glazing System Library, either by:

- clicking on the Glazing System Toolbar button



OR

- going to the Library menu and selecting the Glazing System choice.

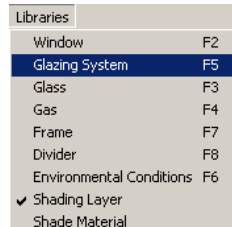

Figure 2-6. Select the Glazing System choice from the Library menu.

In this example, the glazing system to be defined is a double clear IG with a venetian blind on the inside of the glazing system.

To define this glazing system, do the following (starting from the Glazing System Library Detailed View):

- Click the **New** button to define a new glazing system, set the **ID** as appropriate, and begin editing the system
- Change the **Name** field from “default” to something appropriate for the glazing system.
- Change the **# Layers** field to “3”
- In this example, the venetian blind will be on the inside of the glazing system, so click on the arrow to the left of the “Glass 3” layer, and change the layer to a “Shade” layer
- For the now defined “Shade 3” layer, click on the double arrows to the right to view the records in the Shading Layer Library.
- Highlight the venetian blind defined in the previous step, and either double click on the highlighted line or click on the **Select** button -- that venetian blind will now be selected for “Shade Layer 3”.
- Define the glass layers as desired. If the glass layers and gap widths match the example below, this glazing system will fit inside the sample frame in THERM.

Click on the arrow to change the Glass 3 layer to a Shade layer.

Click on the double arrow to select the shade from the Shading Layer Library

Gap 2 represents the distance of the inner edge of the blind from the inner pane of glass

These values are not needed for the Scalar model, so can be left set at 0

	ID	Name	Mode	Thick	Flip	Tsol	RsolT	Rsol2	Tvis	Rvis1	Rvis2	Tir	E1	E2	Cond	Dtop (mm)	Dbot (mm)	Dright (mm)	Dleft (mm)	Comment
Glass 1	9803	CLEAR5.LOF	#	4.7	<input type="checkbox"/>	0.796	0.074	0.074	0.888	0.082	0.082	0.000	0.840	0.840	1.000					
Gap 1	1	Air		16.5	<input type="checkbox"/>															
Glass 2	9803	CLEAR5.LOF	#	4.7	<input type="checkbox"/>	0.796	0.074	0.074	0.888	0.082	0.082	0.000	0.840	0.840	1.000					
Gap 2	1	Air		12.7	<input type="checkbox"/>															
Shade 3	17	Venetian blind, horizonta		15.6	<input type="checkbox"/>							0.000	0.900	0.900	160.000	0.0		0.0	0.0	

Figure 2-7. Add three layers and define the venetian blind as “Shade Layer 3”.

To calculate the results for the glazing system with the integral venetian blind, do the following:

- Go to **File/Preferences**, and check the settings for “Matrix calculation options” and “Venetian blind calculation methods” as follows (these are the default settings in the program, so they should be correctly set and not require changes):
- Set **Spectral data** to “Condensed spectral data” to save calculation time
- Verify that **Number of visible bands** is set to “5” (the program default)
- Verify that **Number of IR bands** is set to “10” (the program default)
- If detailed angular results are to be viewed in the MatrixReader.xls spreadsheet, in the **Generate full spectrally-averaged matrix for** section, check both the “Solar band” and the “Visible band”. This will add a bit of calculation time, but it is not too extreme (several seconds, not minutes).
- Set **Angular basis** to “W6 quarter-size” to save calculation time
- Under **Venetian blind calculation methods**, set **Solar/Visible range** and **FIR range** to “Uniform Diffuse”

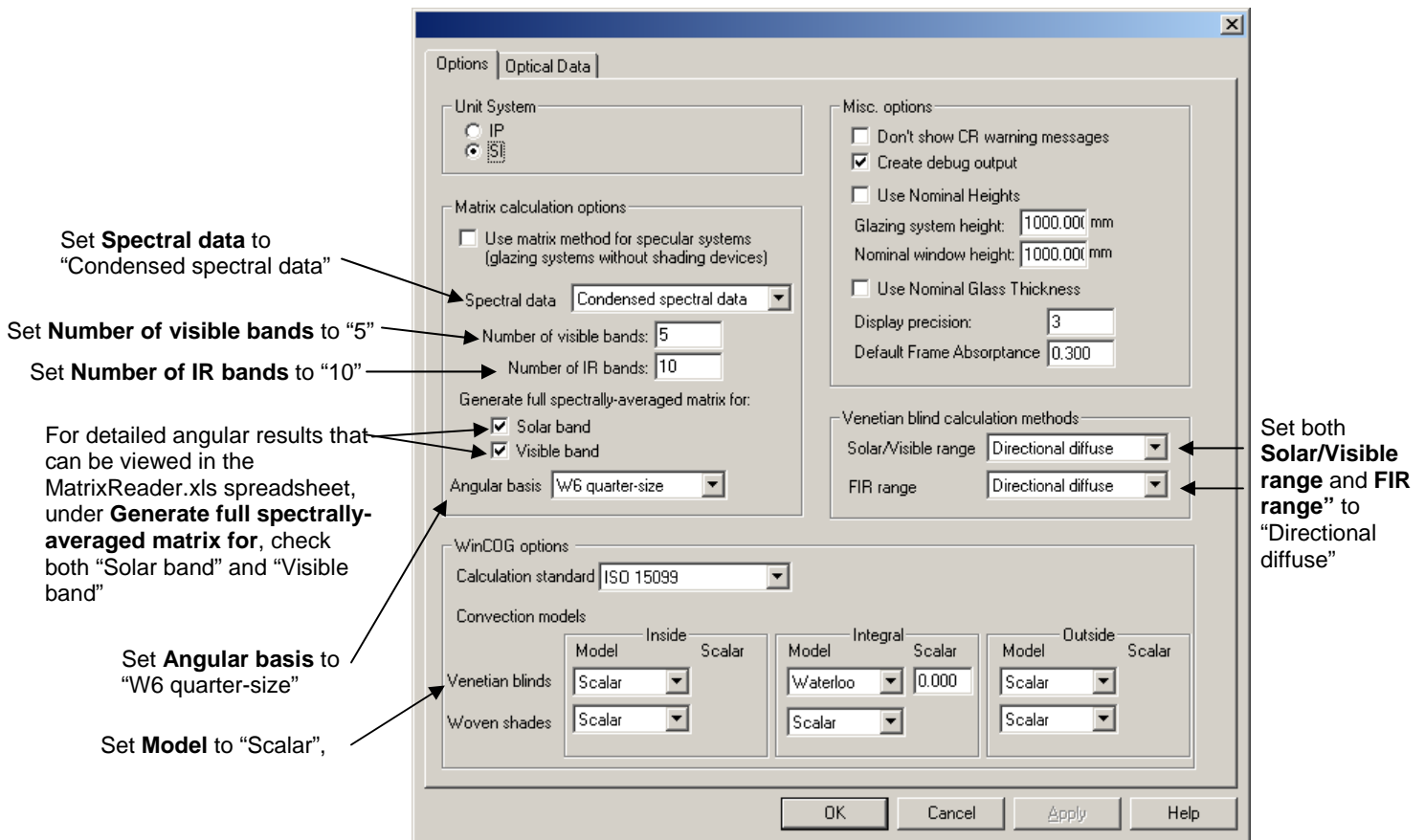

Figure 2-8. Make sure the settings in File/Preferences are correct.

- In the **Glazing System Library Detailed View**, click on the **Calc** button. A dialog box will be displayed showing the calculation steps.

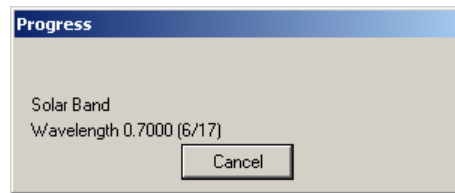

Figure 2-9. A dialog box with the calculation steps will appear during the calculation.

If the venetian blind material did not have spectral data, which is most likely the case, the program will display the usual warning about not having spectral data for all the layers in the glazing system.

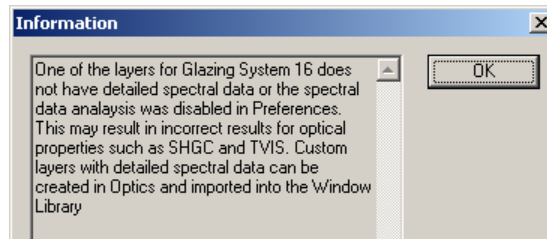

Figure 2-10. A dialog box with a message about the lack of spectral data for one of the layers in the glazing system, in this case the shading layer.

The program will display the results of the glazing system with the shading device in the normal tabs at the bottom of the glazing system. For glazing systems with shading layers, the optical properties are calculated at normal incidence for the incoming angle, and hemispherically integrated for all the outgoing angles. The thermal results are based on the ISO 15099 algorithms for shading systems.

The screenshot shows the 'Glazing System Library' software interface. The main window displays the details for a glazing system with ID #16, named 'Double Clear Interior Venetian, 45 deg'. The system consists of 3 layers: two glass layers (CLEAR5.LOF) and one shading layer (Venetian blind, horizont). The overall thickness is 54.154 mm. The interface includes a table of layer properties and a summary table of results.

ID	Name	Mode	Thick	Flip	Tsol	Rsol1	Rsol2	Tvis	Rvis1	Rvis2	Tir	E1	E2	Cond	Dtop (mm)	Dbot (mm)	Dright (mm)	Dleft (mm)	Comme
Glass 1	9803 CLEAR5.LOF	#	4.7	<input type="checkbox"/>	0.796	0.074	0.074	0.888	0.082	0.082	0.000	0.840	0.840	1.000					
Gap 1	1 Air		16.5	<input type="checkbox"/>															
Glass 2	9803 CLEAR5.LOF	#	4.7	<input type="checkbox"/>	0.796	0.074	0.074	0.888	0.082	0.082	0.000	0.840	0.840	1.000					
Gap 2	1 Air		12.7	<input type="checkbox"/>															
Shade 3	17 Venetian blind, horizont		15.6	<input type="checkbox"/>							0.000	0.900	0.900	160.000	0.0	0.0	0.0	0.0	

Ufactor	SC	SHGC	Rel. Ht. Gain	Tvis	Keff	Gap 1 Keff	Gap 2 Keff
W/m2K			W/m2		W/m-K	W/m-K	W/m-K
2.400	0.574	0.499	380	0.245	0.1572	0.0855	0.1124

Figure 2-11. The glazing system results

Now that results have been calculated for the glazing system, it can be imported into THERM to calculate the frames, as discussed in the next section.

2.3. Glazing System Results

2.3.1. Results at Normal Incidence

For a glazing system with a shading device, the optical properties presented for complex glazing systems are calculated at normal incidence for the incoming angle (horizontal to the glazing system) and hemispherically integrated on the outgoing side. This is what is displayed in the “Center of Glass Results” tab in the lower section of the Glazing System Library for SC, SHGC, Tvis as well as the results in the Optical Data tab in that same section. The thermal results (U-value) are calculated using the ISO 15099 thermal models for shading systems.

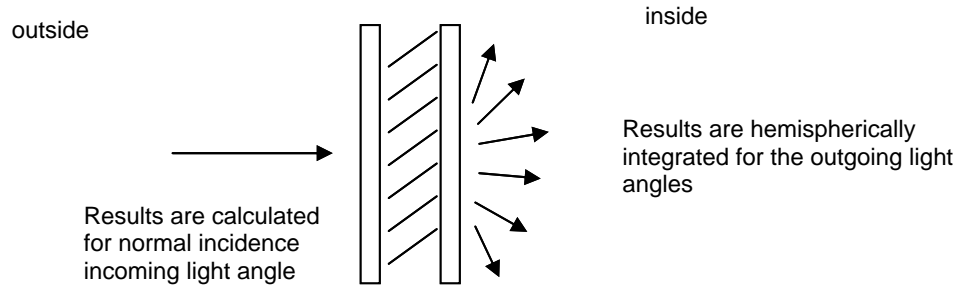

Figure 2-12. The results in the Glazing System Library are calculated at normal incidence for incoming light and hemispherically integrated for the outgoing light angles.

2.3.2. Results for Multiple Incident Angles

The results of the detailed angular calculation by the “matrix calculation engine” result in a very large number of results, depending on the basis used in the calculation. The WINDOW “standard basis” (set in File/Preferences) is 145 incoming angles of light and 145 outgoing angles of light through the whole glazing system.

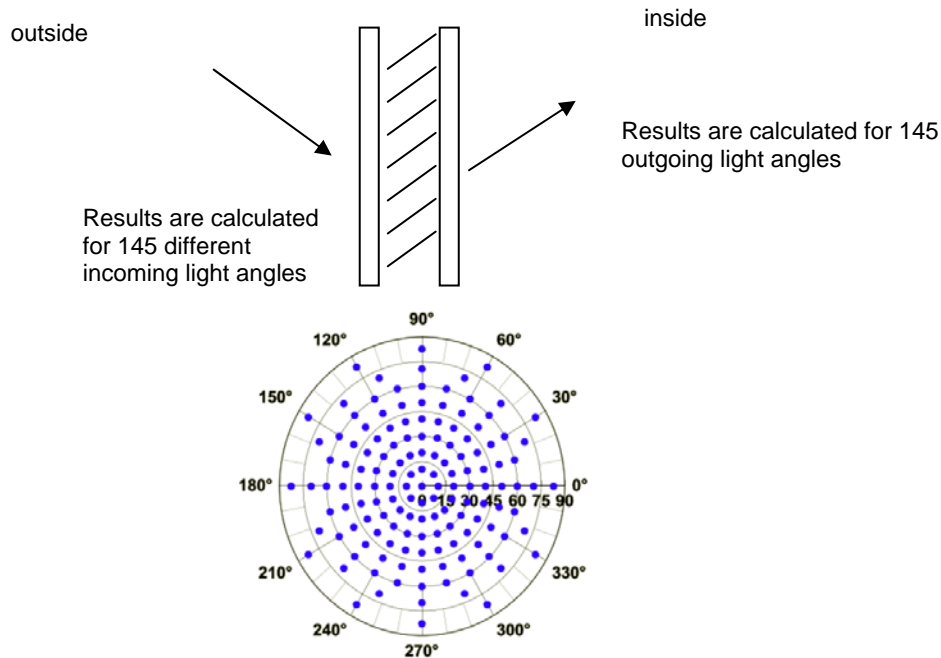

Figure 2-13. The full set of results that WINDOW can calculate are for 145 incoming angles which result in values for 145 outgoing angles. This complete set of results (21,015 values) can be read by the MatrixReader spreadsheet for viewing.

WINDOW writes these results to a CSV (comma separated text) file that can be read by a spreadsheet. Included in the WINDOW installation is an Excel spreadsheet, called **W6MatrixReader.xls**, that reads this CSV file and displays the results in a few different ways. This spreadsheet is a way to prototype the possible results display modes, and we are very interested in feedback about how users would be interested in seeing these results.

The results file that the spreadsheet reads is given the name of the glazing system (there are several other intermediate CSV files that are generated, but they do not contain the final results) and is written into the WINDOW working directory. One of the sample glazing systems in the default database (that is included in the WINDOW installation) is called "Venetian - 40 degrees", and once a matrix calculation is completed on that glazing system, the WINDOW working directory will contain a file called "Venetian - 40 degrees.csv". Open the W6MatrixReader.xls file and when it has opened, click on the Load Matrix button.

When you click the Load Matrix button, a standard Open File dialog box will appear. There are several CSV files that WINDOW writes, but you need to select the one that has the same name as the glazing system just calculated, in this case "Venetian - 40 degrees.csv". results displayed.

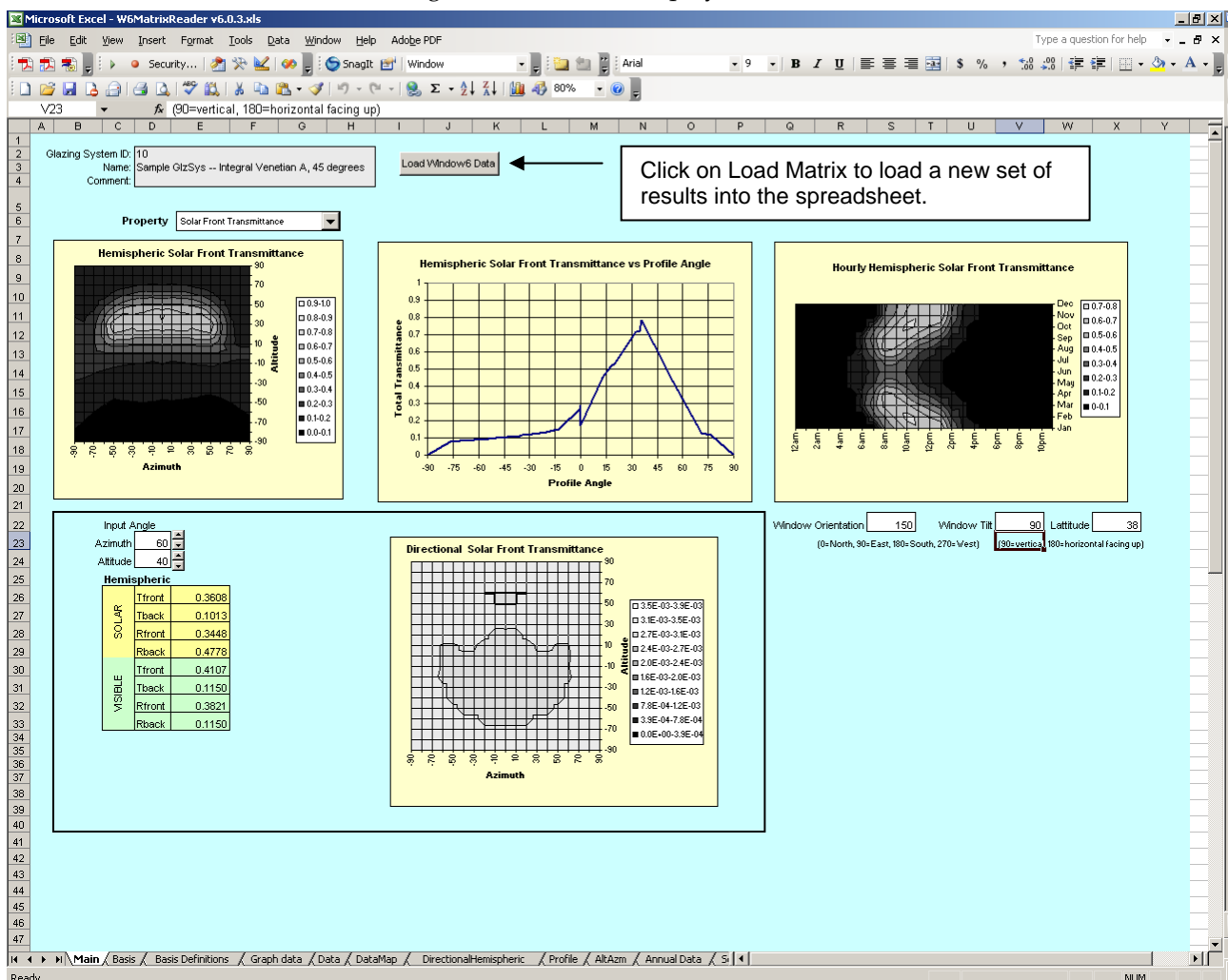

Figure 2-14. Open W6MatrixReader.xls and click the Load Matrix button to load results.

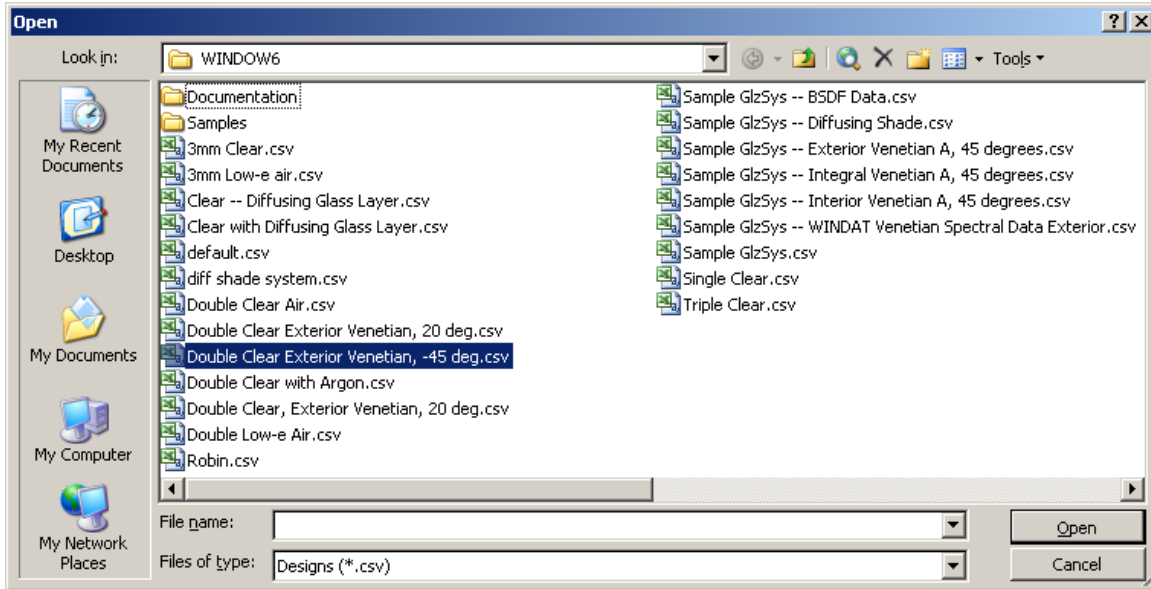

Figure 2-15. Open the CSV file that has the same name as the glazing system modeled.

This file will be loaded into the spreadsheet and the results will be displayed as shown below.

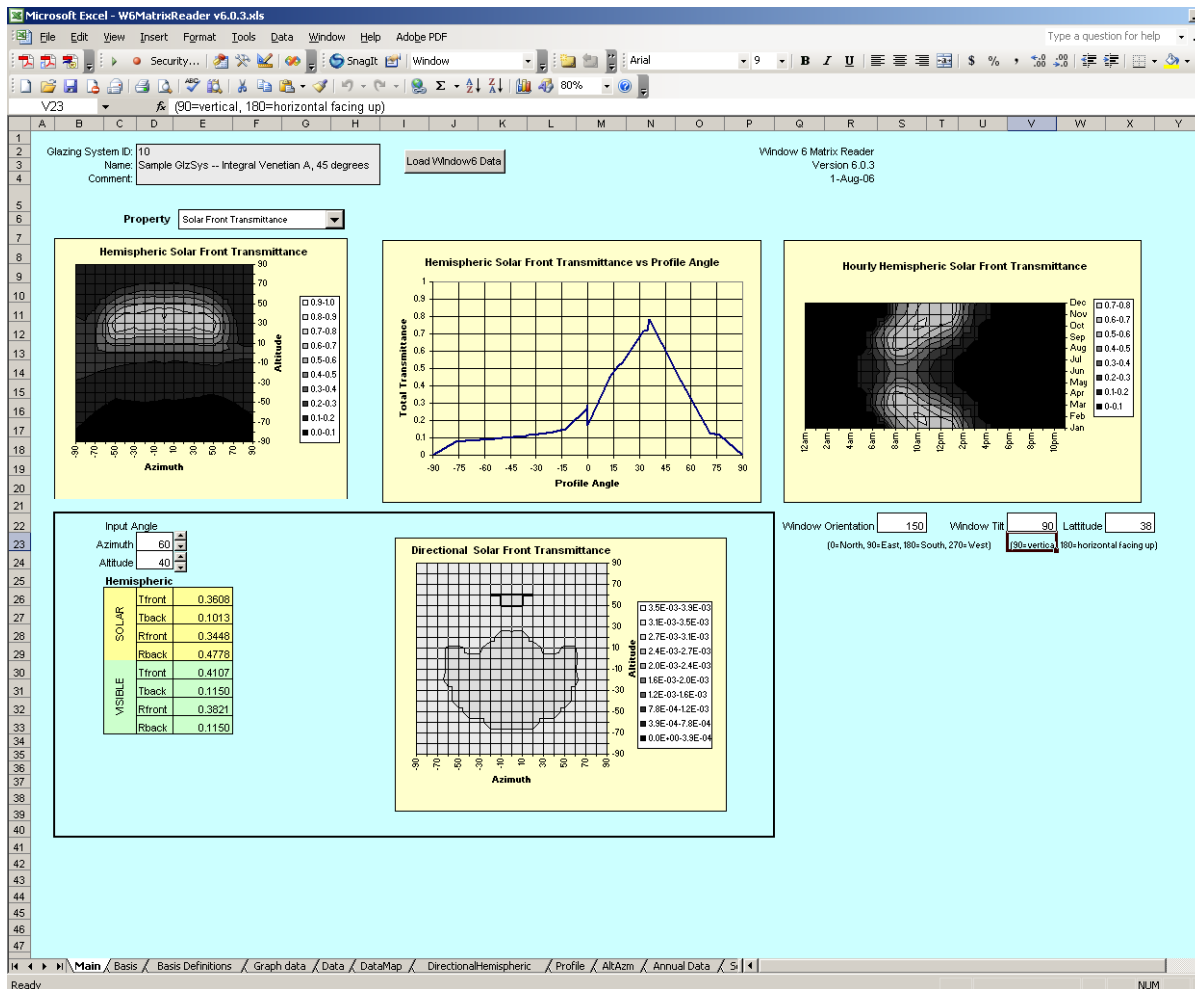

Figure 2-16. The W6MatrixReader will display the results from the opened file.

2.4. Import the Glazing System into THERM

THERM can interpret WINDOW glazing systems with shading devices. THERM will display the shading device as a representative rectangle that is part of the glazing system.

The steps for importing a glazing system into THERM from a WINDOW 5 database are as follows:

- Start the THERM program, and open the file in the WINDOW Samples directory called “sample-sill-NoGlazing.thm”.
- Go to the **Libraries** menu, and click on the **Glazing Systems** option

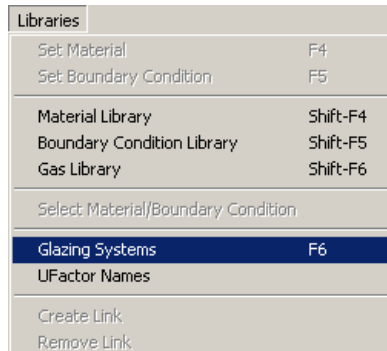

Figure 2-17. In THERM, go to the Libraries menu, Glazing Systems option to import the WINDOW glazing system.

- The **Glazing Systems** dialog box will appear.
- Use the **Browse** button to select the correct WINDOW database, in this case “W6.mdb”, and select the appropriate glazing system from the pulldown list, in this case #16, “Double Clear Exterior Venetian, -45 deg” and click the **Import** button.

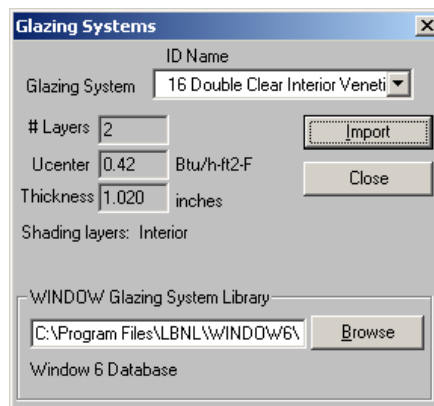

Figure 2-18. The Glazing System dialog box for importing a WINDOW glazing system into THERM.

- The **Insert Glazing System** dialog box will appear. All the normal input values should be applied, and in addition, there are two new fields, **Site line to interior shade edge** and **Site line to exterior shade edge**. In this case, the venetian blind is an exterior blind, so input a value for **Site line to exterior shade edge**, such as 6 mm.

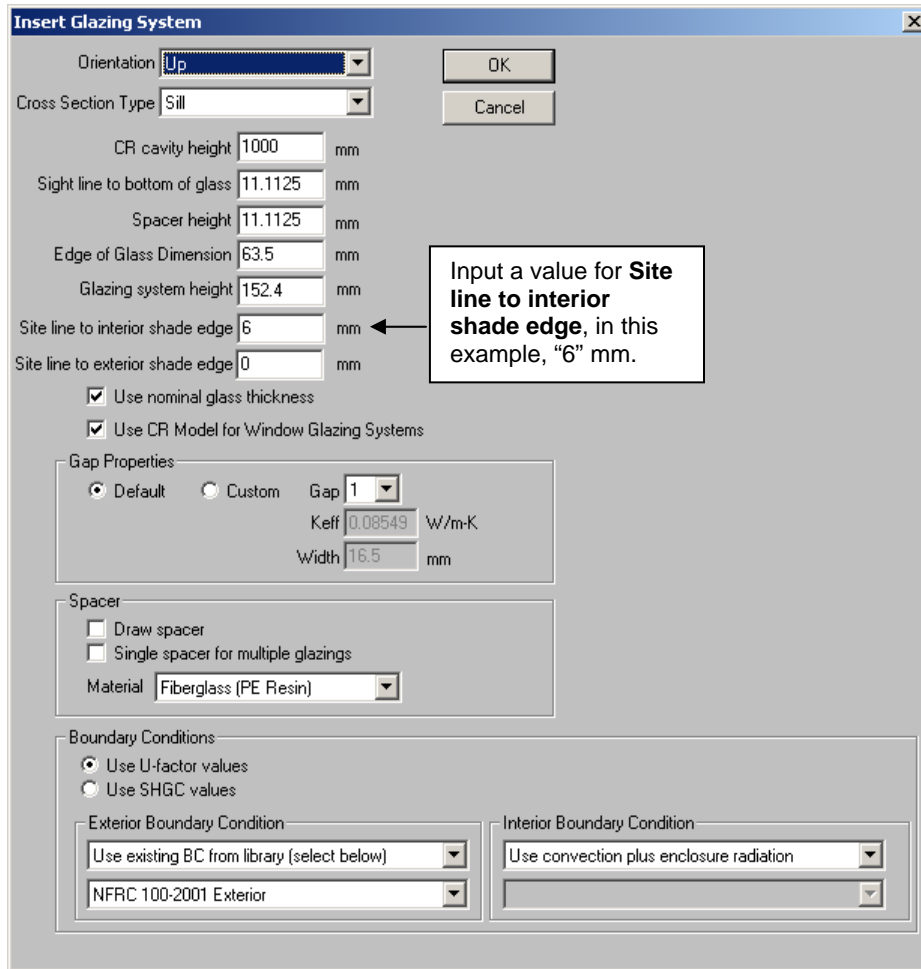

Figure 2-19. The Insert Glazing System dialog box which specifies input parameters about the glazing system.

- The glazing system will be imported into the THERM file, with a hatched rectangle on the outside of the glazing system to represent the exterior venetian blind. The hatch marks are not intended to show the angle or spacing of the venetian blind. The bottom of the blind is the specified distance from the sight line, in this case, 6 mm.

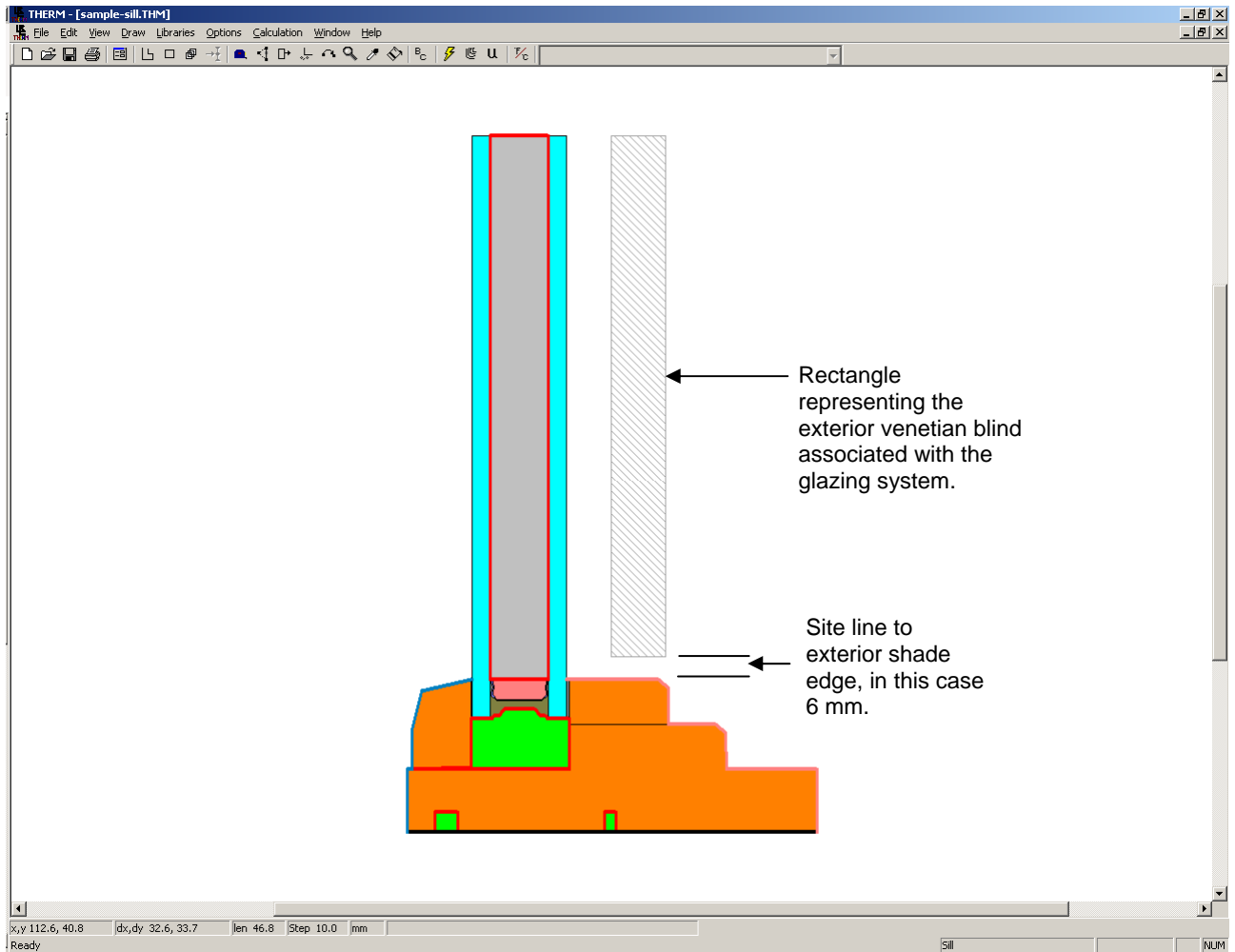

Figure 2-20. The THERM file with the glazing system and venetian blind imported.

- Because there is a 6 mm segment of the glazing system that does not have the venetian blind on the interior, that segment of the boundary conditions will be defined separately. Therefore it is necessary to insert a point on the glazing system which will then generate a separate segment in the boundary conditions.

- In **Options/Preferences, Drawing Options** tab, check the “Allow Editing of IG polygons”.
- Click on the exterior glass layer and insert a point 6 mm up from the sight line.

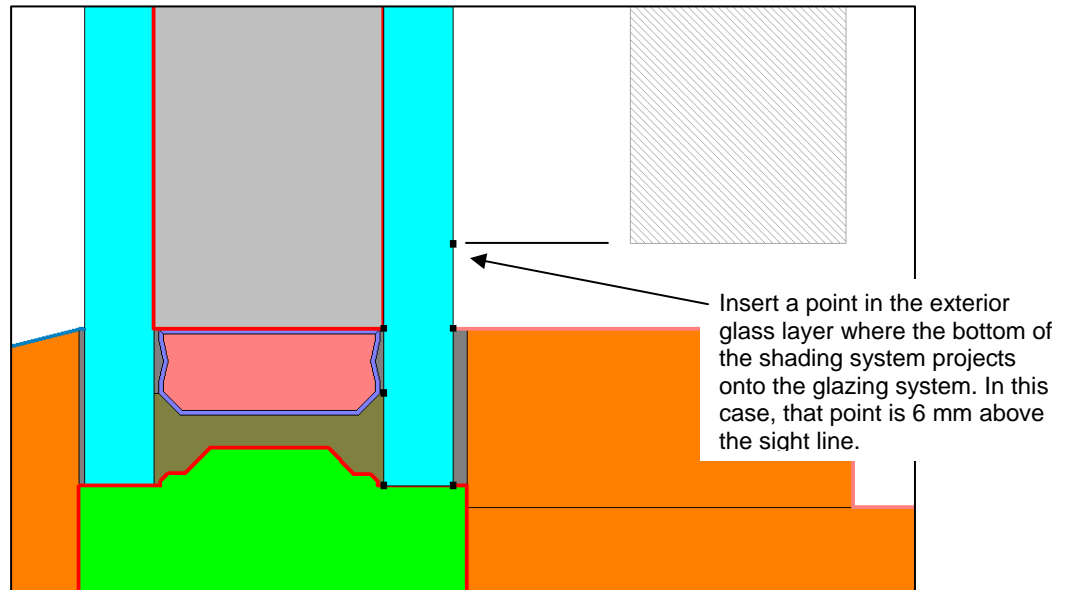

Figure 2-21. Insert a point in the glass layer where the bottom of the venetian blind intersects the glass.

- Generate the Boundary Conditions
- In THERM, the **Boundary Condition Type** dialog box has an additional input at the bottom, to specify a **Shading system modifier**, which comes with the glazing system from WINDOW. In general, the program should default this modifier to the glazing system that has the shading device. If not, the glazing system with the shading device can be selected from the pulldown list. In this example, the glazing system is “Glazing System ID: 16”. This boundary condition should be applied to the exterior glass layer where the venetian blind is next to it, but not to the 6 mm below the venetian blind and the sight line, which should have **Shading system modifier** set to “None”.

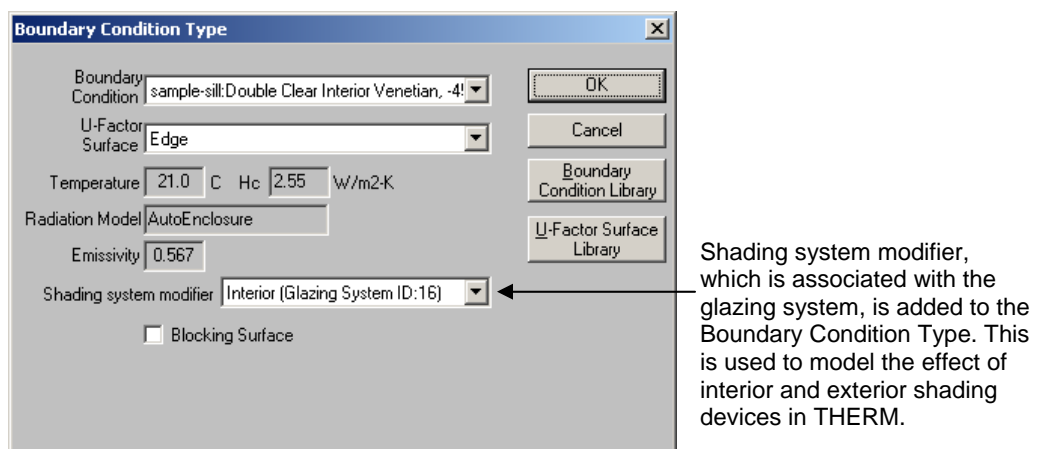

Figure 2-22. Set the **Shading system modifier** to the glazing system with the shading device.

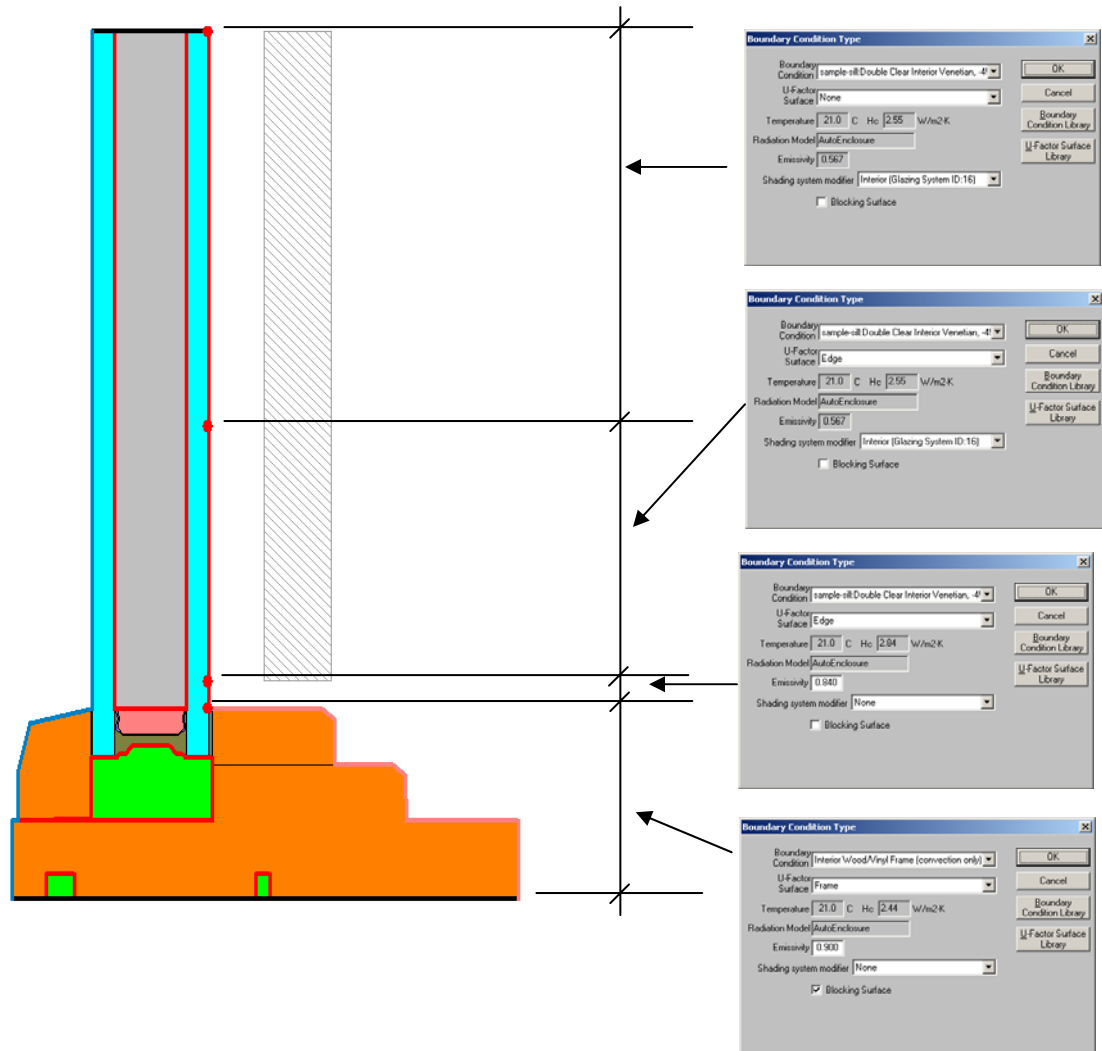

Figure 2-23. Set the *Shading system modifier* appropriately for each boundary condition segment.

- Save the file, simulate it, and then make similar files for the head and jambs.

2.5. Import the THERM files into the WINDOW Frame Library

When all the frame cross sections have been modeled, they can be imported into the WINDOW Frame Library in the normal fashion. The figure below shows the THERM sample frames included in the default W6.mdb file, imported into the WINDOW Frame Library.

Frame Library (C:\Program Files\LBNL\WINDOW6\w6.mdb)

ID	Name	Source	Type	Frame Uvalue W/m2-K	Edge Uvalue W/m2-K	Edge Correlation	Glazing Thickness mm	Pfd mm	Abs	Color
1	Al w/break	ASHRAE	N/A	5.680	N/A	Class1	N/A	57.2	0.90	Blue
2	Al flush	ASHRAE	N/A	3.970	N/A	Class1	N/A	57.2	0.90	Blue
3	Wood	ASHRAE	N/A	2.270	N/A	Class1	N/A	69.8	0.90	Blue
4	Vinyl	ASHRAE	N/A	1.700	N/A	Class1	N/A	69.8	0.90	Red
5	sample-sill.THM	Therm	Sill	2.019	2.452	N/A	25.9	42.9	0.50	Teal
6	sample-jamb.THM	Therm	Sill	2.018	2.452	N/A	25.9	42.9	0.50	Teal
7	sample-head.THM	Therm	Sill	2.257	3.000	N/A	25.9	42.9	0.50	Teal
8	sample-head-InteriorVentianA-45.THM	Therm	Head	2.081	2.085	N/A	25.9	42.9	0.30	Teal
9	sample-jamb-InteriorVentianA-45.THM	Therm	Sill	2.075	2.081	N/A	25.9	42.9	0.30	Teal
10	sample-sill-InteriorVentianA-45.THM	Therm	Sill	2.076	2.081	N/A	25.9	42.9	0.30	Teal
11	sample-head-IntegralVentianA-45.THM	Therm	Sill	2.036	2.867	N/A	25.9	42.9	0.30	Teal
12	sample-jamb-IntegralVentianA-45.THM	Therm	Sill	2.049	2.871	N/A	25.9	42.9	0.30	Teal
13	sample-sill-IntegralVentianA-45.THM	Therm	Sill	2.049	2.871	N/A	25.9	42.9	0.30	Teal
14	sample-head-exteriorVentianA-45.THM	Therm	Sill	2.021	2.242	N/A	25.9	42.9	0.30	Teal
15	sample-jamb-ExteriorVentianA-45.THM	Therm	Sill	2.014	2.238	N/A	25.9	42.9	0.30	Teal
16	sample-sill-ExteriorVentianA-45.THM	Therm	Sill	2.015	2.238	N/A	25.9	42.9	0.30	Teal
17	sample-sill-InteriorVenetion_45.THM	Therm	Sill	2.057	2.821	N/A	26.5	42.9	0.30	Teal

For Help, press F1

Mode: NFRC SI NUM

Figure 2-24. Import the THERM files into the WINDOW Frame Library.

2.6. Create a Window

The steps to create a whole window with a shading system is the same as creating a normal window.

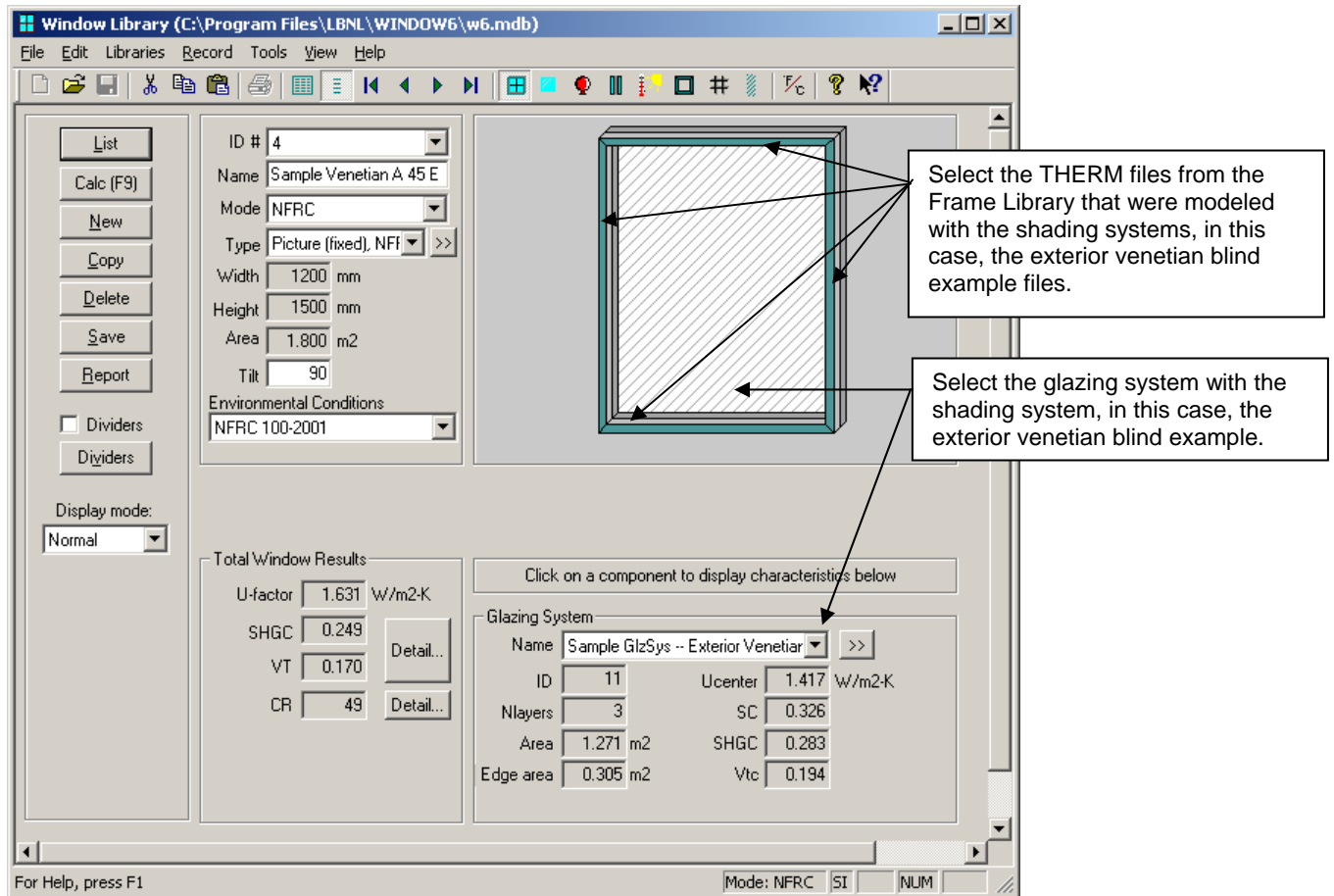

Figure 2-25. To create a whole window in WINDOW, go to the Window Library and reference the glazing system and frame cross sections that have the shading systems associated with them.

3. Installation

This section explains how to install WINDOW and THERM. Note that WINDOW 6.2 and THERM 6.2 can be installed on the same computer as WINDOW 5.2 and THERM 5.2, and they will not interfere with each other.

3.1. System Requirements

WINDOW and THERM require the following minimum computer requirements:

- Pentium class or better.
- At least 32 MB of random access memory (RAM). For optimal operation, 64 MB or more of RAM is preferable.
- Microsoft Windows Vista™, Windows XP™, Windows 2000™, Windows 98™, Windows ME™, or Windows NT™. (The program WILL NOT run with Windows 3.1™, Windows NT 3.51™ or Windows 95™).
- Hard disk drive with at least 100 MB of available disk space
- Printer supported by Microsoft Windows (serial, parallel, or shared over a network).

3.2. Installation Procedures for WINDOW

3.2.1. Before Installing WINDOW

Close all programs before installing WINDOW and uninstall any previous versions of the WINDOW program before starting the installation of this version. However, WINDOW 5 can remain installed – both versions can be installed on the same machine and will not interfere with each other.

In order to install the program with the Microsoft NT (4.0), 2000, and XP, **you must be Administrator** on your machine. To check if you are Administrator, do the following:

- Go to Start, Settings, Control Panel, Users and Passwords.
- Find the current username (yours) and look in the group column. It should say: “Administrators”
- If the current username does NOT say “Administrators”, contact your IP department to become Administrator, or to have someone with Administrator privileges install the program on the machine.

3.2.2. Installing WINDOW

Put the program installation CD in the appropriate drive or copy the installation file to the computer hard drive.

Run:

```
WINDOW0setup.exe
```

An **InstallShield Wizard** window will appear saying that the installation program preparing the installation. Wait for this window to disappear, and then proceed to the next step. To cancel the installation, click in the **Cancel** button.

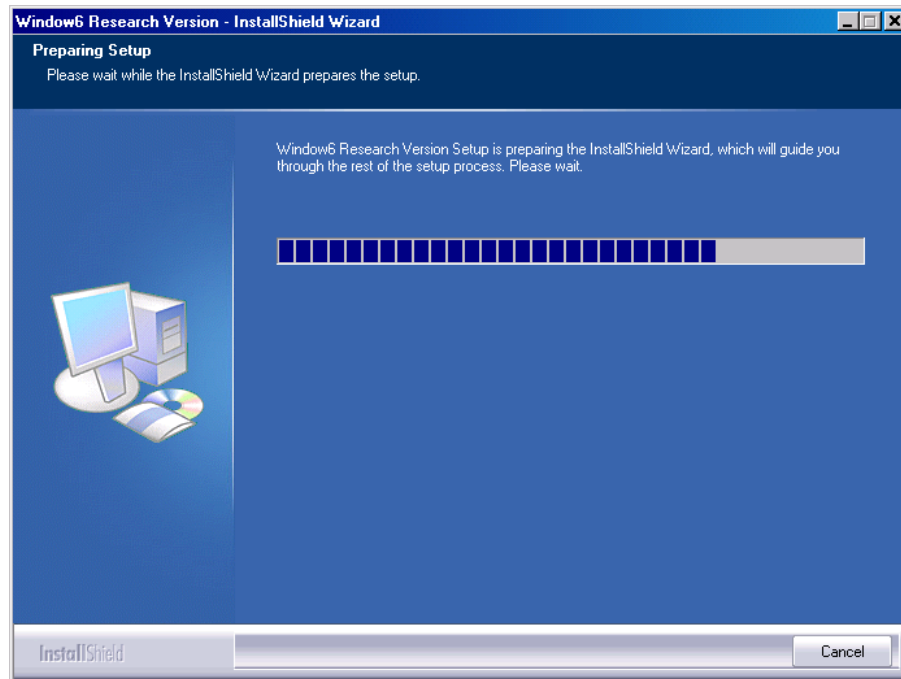

Figure 3-1. The InstallShield Wizard window.

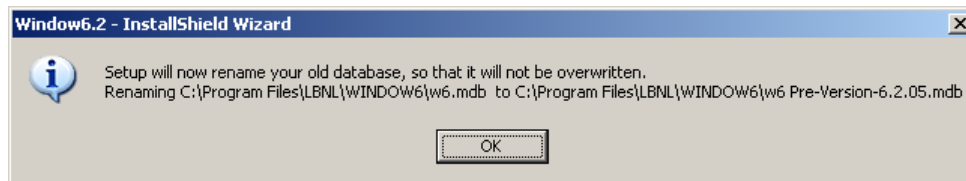

Figure 3-2. Under some circumstances the program may look for and try to rename an older database.

The WINDOW Welcome window will appear. Click the **Next** button to proceed, or cancel the installation by clicking on the **Cancel** button.

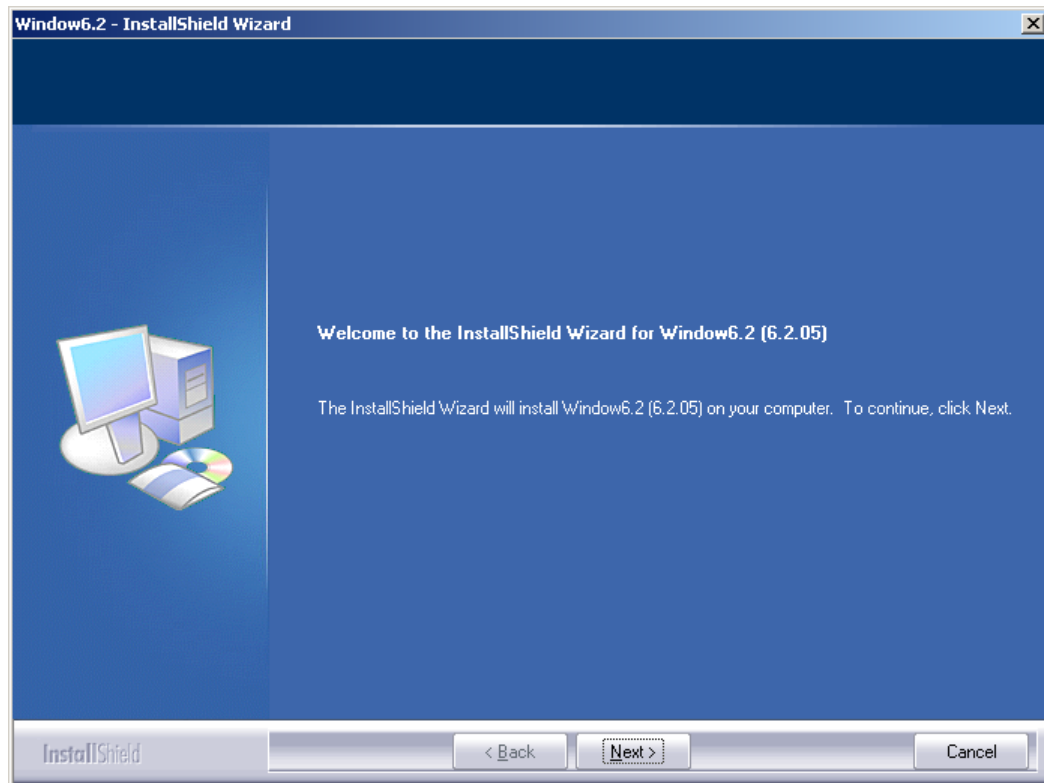

Figure 3-3. The Welcome window.

The **License Agreement** window will appear. After reading and agreeing to the terms of the license, click on **Yes** button to proceed with the installation. Click the **Back** button to go to the previous screen, or cancel the installation by clicking on the **No** button.

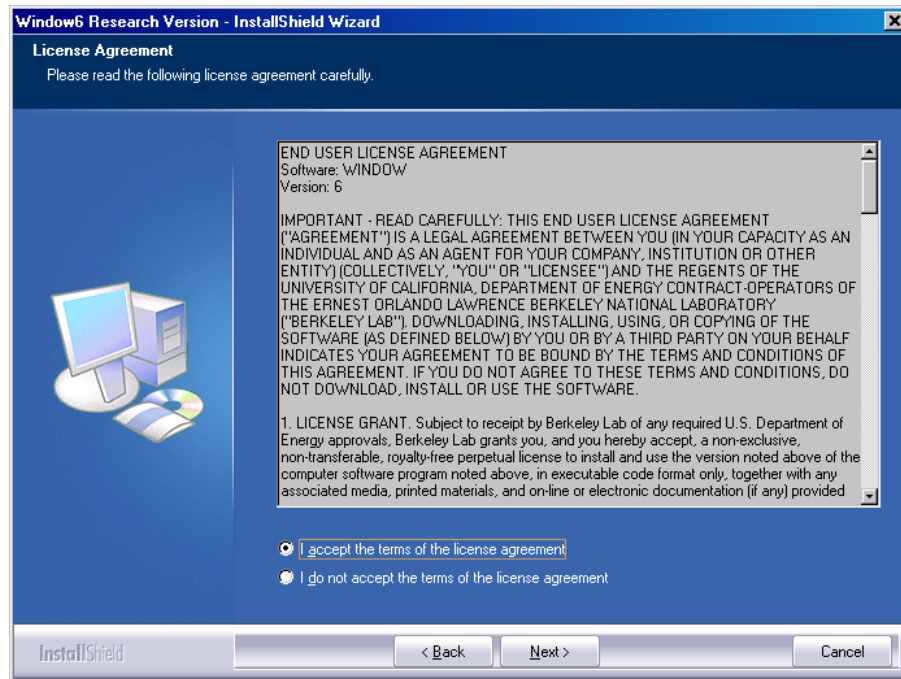

Figure 3-4. The License Agreement window.

The **Customer Information** window will appear. Type the appropriate information into the fields, and click the **Next** button to proceed, or cancel the installation by clicking on the **Cancel** button.

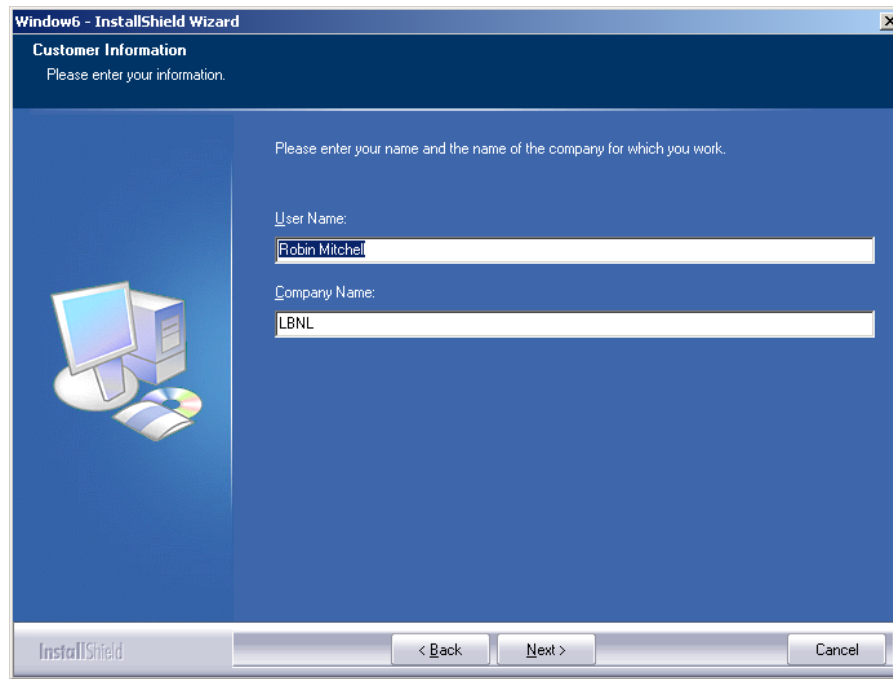

Figure 3-5. The Customer Information window.

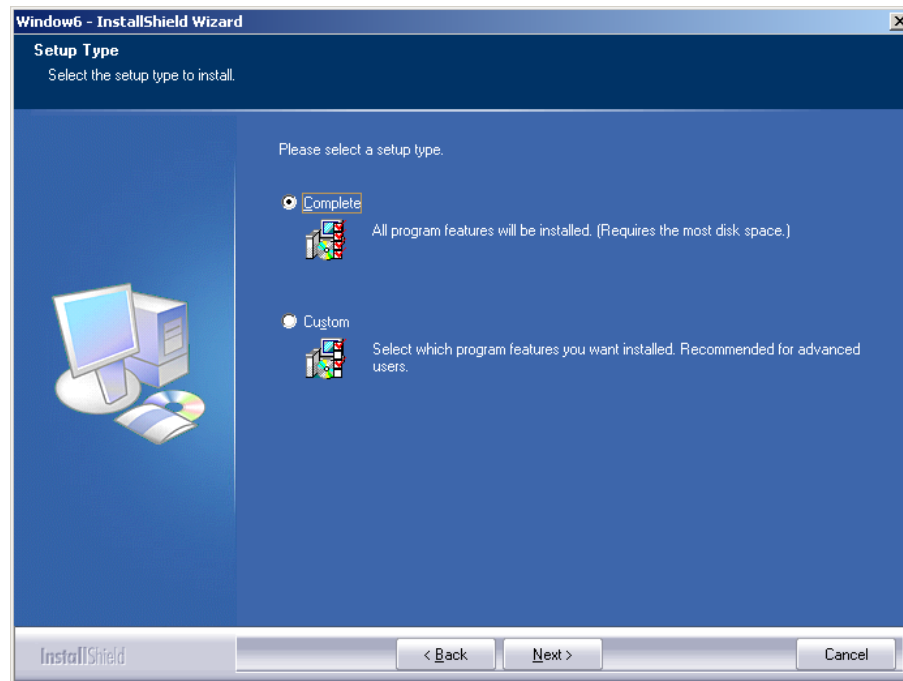

Figure 3-6. The WINDOW Setup Type window – choose Complete Installation.

- Complete Installation

If the “Complete Installation” option is chosen (it is the default choice), the program will automatically be installed in C:\Program Files\LBNL\WINDOW. NOTE: It is important to keep this directory structure in order for the WINDOW installation to be compatible with the WINDOW 5 installation, which can exist concurrently with WINDOW (WINDOW 5 does not need to be uninstalled).

- Custom Installation

The Complete Installation choice is recommended in order to use the default paths for the program location. However, if Custom Installation is chosen, the installation will provide a screen where the installation location can be changed from the default. Extreme caution is advised if this structure is changed.

The **Choose Destination Location** window will appear. The default folder for the program is C:\Program Files\LBNL\WINDOW, and this can be changed by clicking the “Change” button. . . Click the **Next** button to proceed. Cancel the installation by clicking on the **Cancel** button.

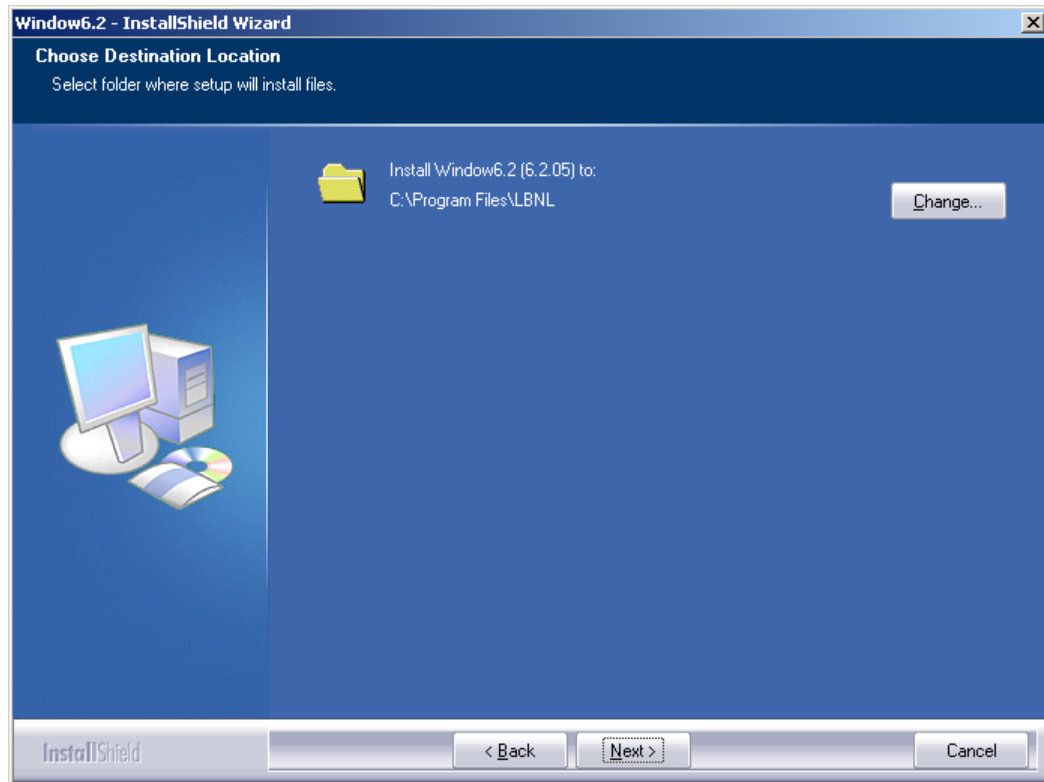

Figure 3-7. The WINDOW Destination Folder window.

The Change Folder window will appear, and a new path for the program location can be specified.

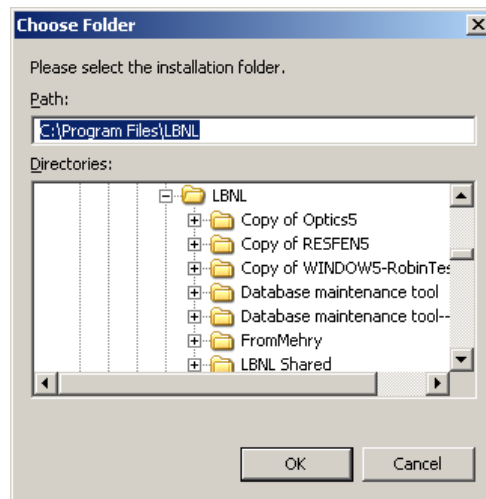
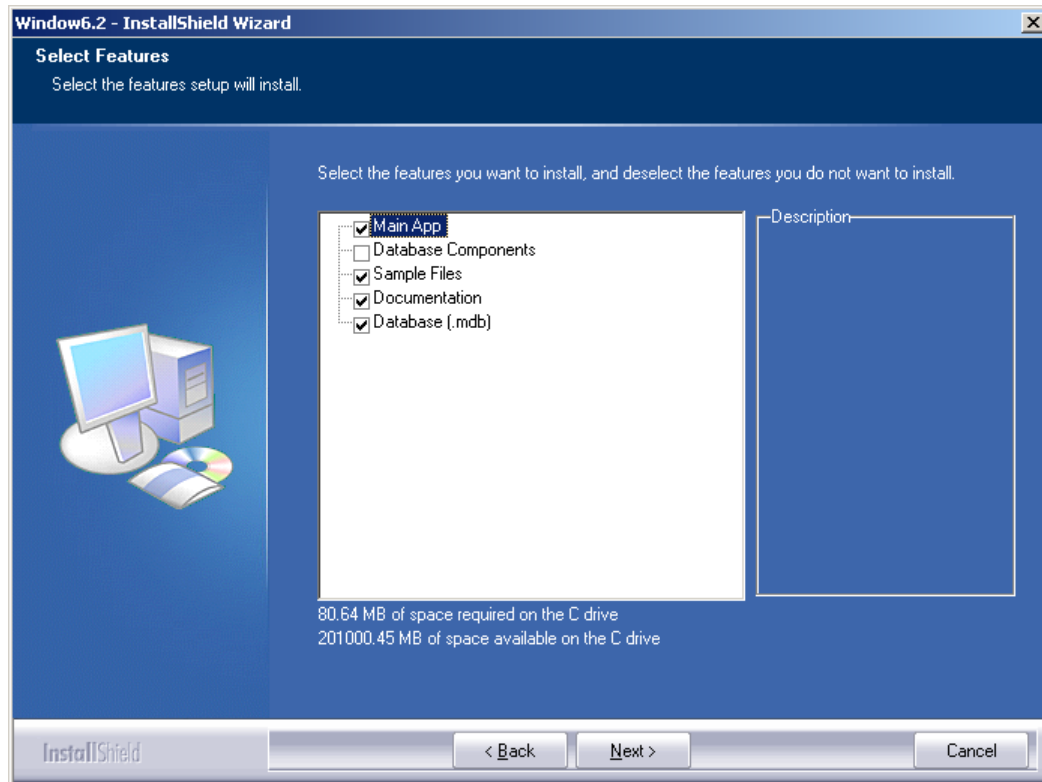
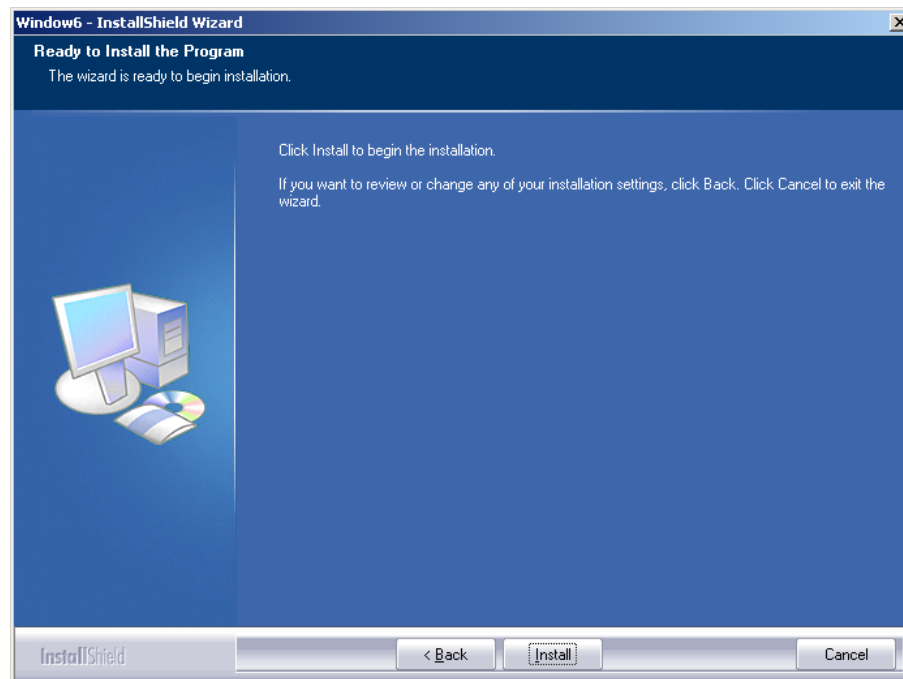

Figure 3-8. The selected installation settings are displayed in the Start Copying Files window.



When the Complete or Custom installation settings have been specified, the “Ready to Install the Program” window will appear. Click “Install” to begin the installation, “Back” to return to the previous installation window, or “Cancel” to stop the installation.



The installation program will install WINDOW, and show a bar with the completion status in the **Setup Status** window. The installation can be cancelled by clicking on the **Cancel** button.

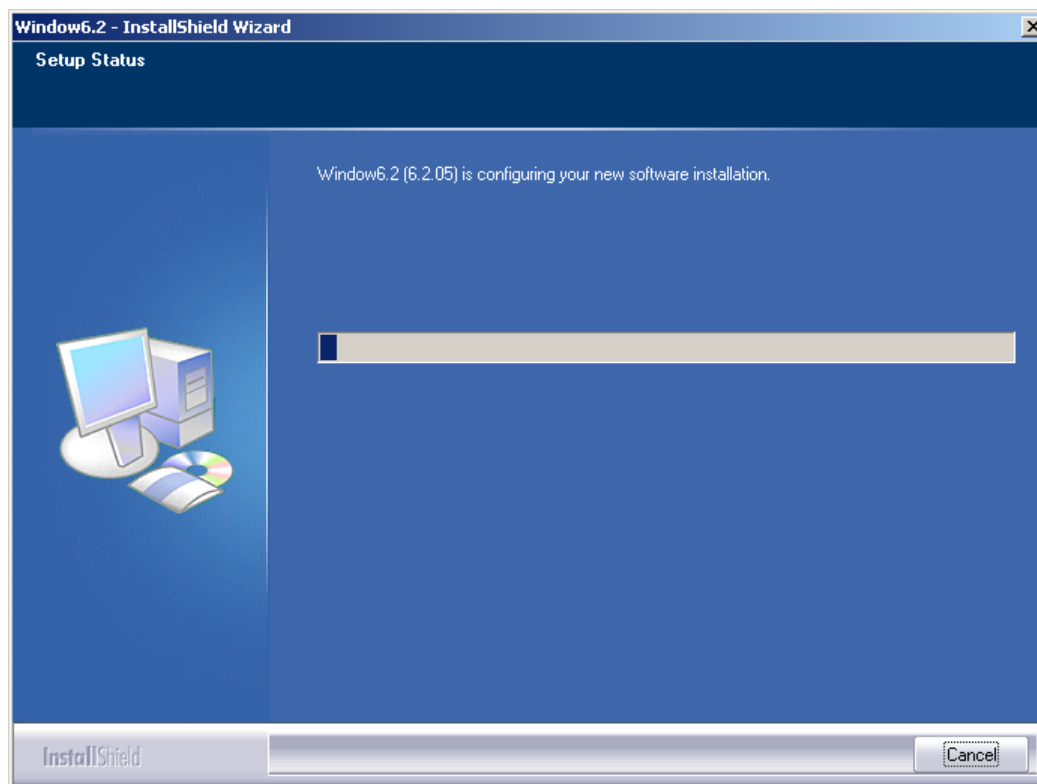

Figure 3-9. WINDOW is being installed.

When the installation is complete, the **Installation Wizard Complete** window will appear. Click on the **Finish** button to finalize the installation.

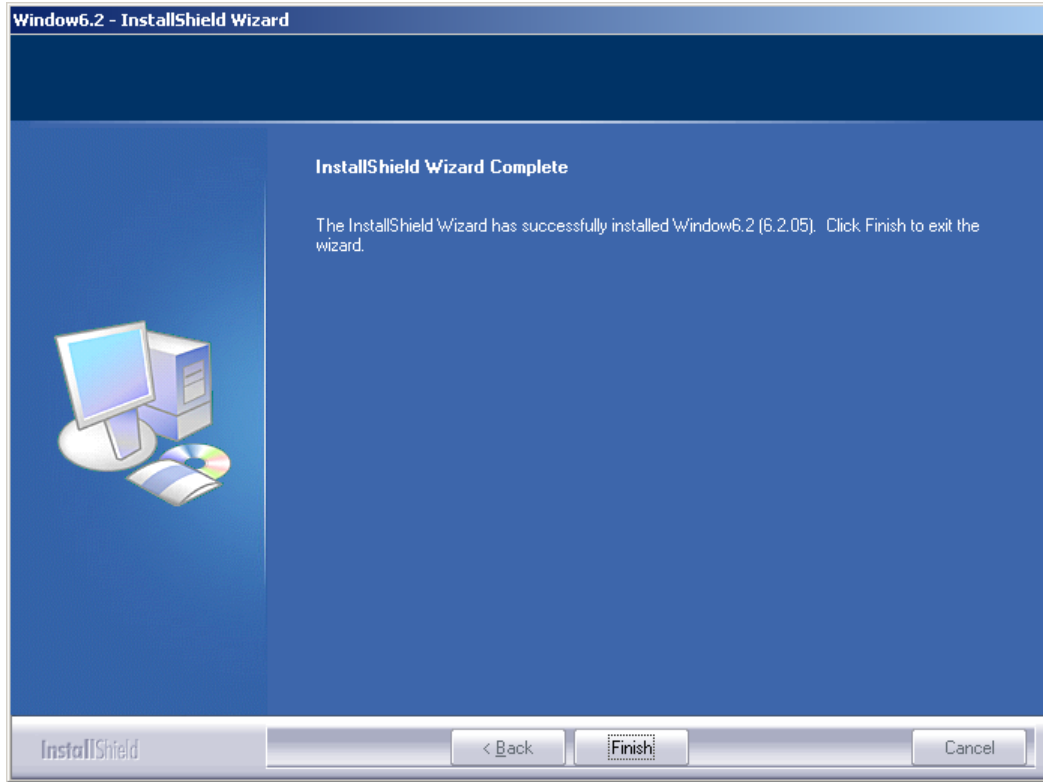

Figure 3-10. Click on the Finish button to complete the installation.

The program can be started from the Start button, Programs, LBNL Software, WINDOW Research Version, as shown below.

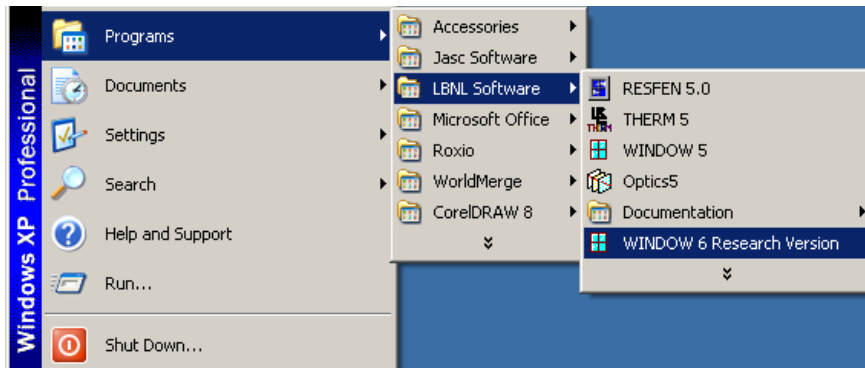

Figure 3-11. Start the program from the Start button.

3.3. Installation Problems

This section discusses problems that may be encountered during installation.

3.3.1. Not enough disk space

If the installation program detects that there is not enough disk space, a screen showing how much is needed will appear.

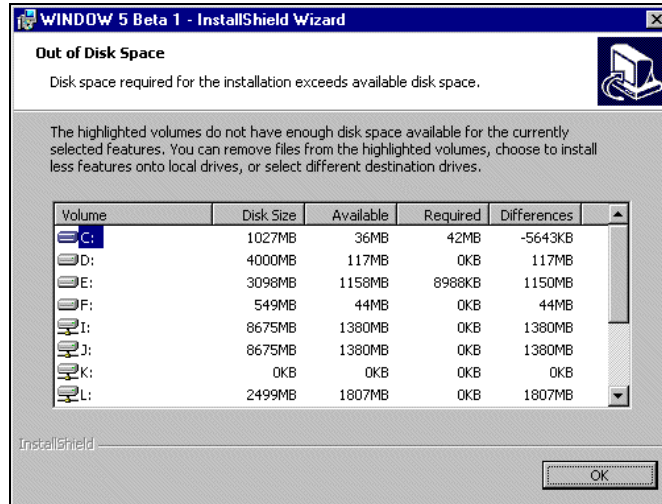

Figure 3-12. Window showing necessary disk space for WINDOW installation

3.3.2. Previous Version Detected

The installation will detect if WINDOW has been previously installed and will update it without requiring that it be uninstalled before the new installation can proceed (see Section 3.4, "Uninstalling WINDOW").

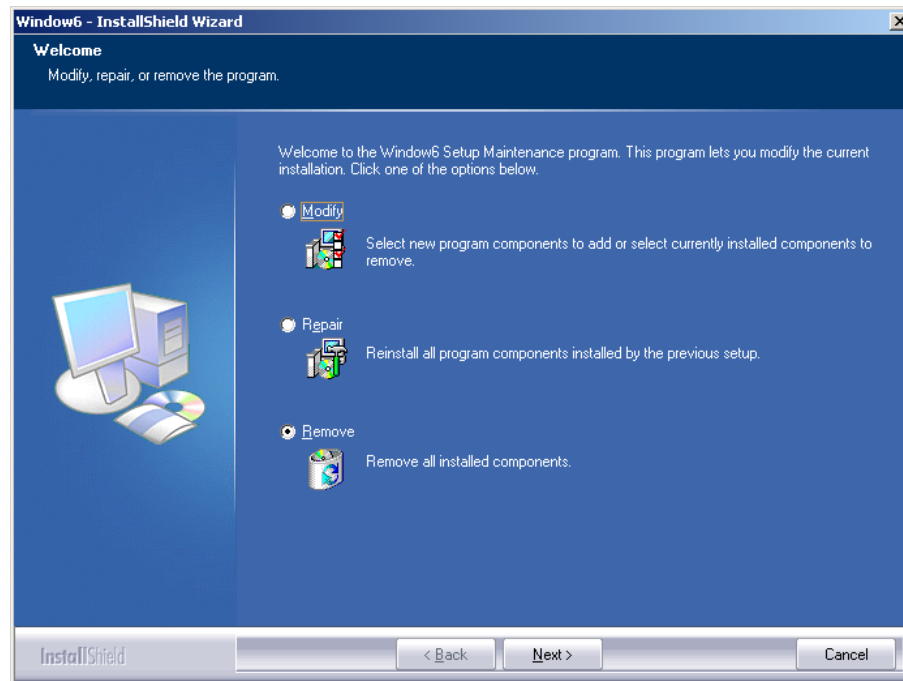

Figure 3-13. Remove the previous version before installing a newer version.

3.4. Uninstalling WINDOW

To uninstall WINDOW, either run the original installation setup.exe which will display the **Program Maintenance** window (Figure 3-11) and click on the **Remove** option, or open the Microsoft Windows™ Control Panel.

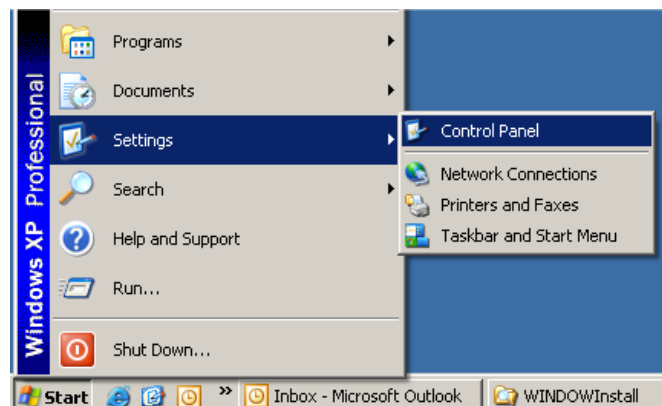

Figure 3-14. To uninstall WINDOW, run Control Panel

Click on the **Add/Remove Programs** icon in the Microsoft Windows™ Control Panel.

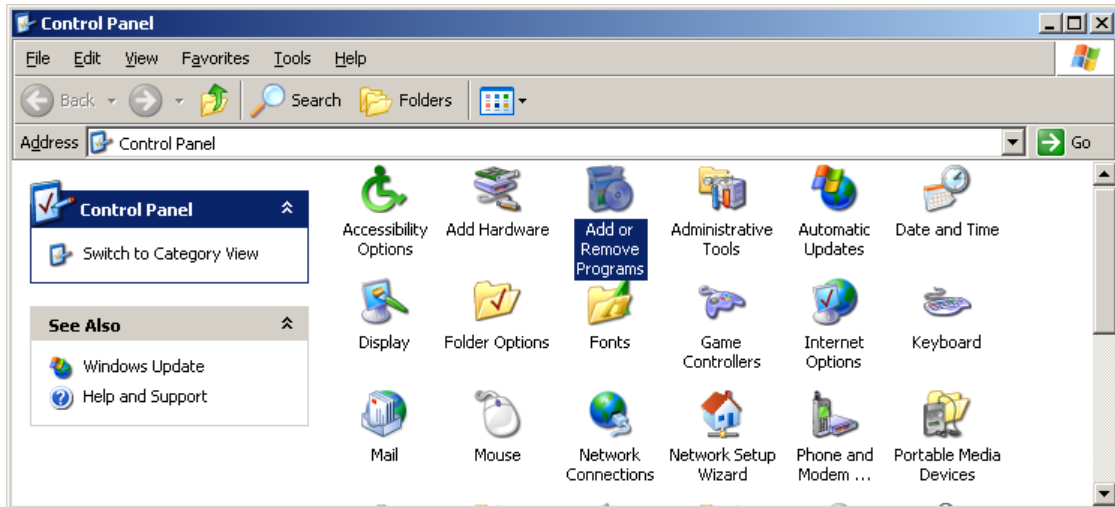

Figure 3-15. Click on the Add/Remove Programs icon.

In the **Add/Remove Programs Properties** dialog box, under the **Install/Uninstall** tab, select the **WINDOW 5 Beta 1** program, and click the **Add/Remove** button.

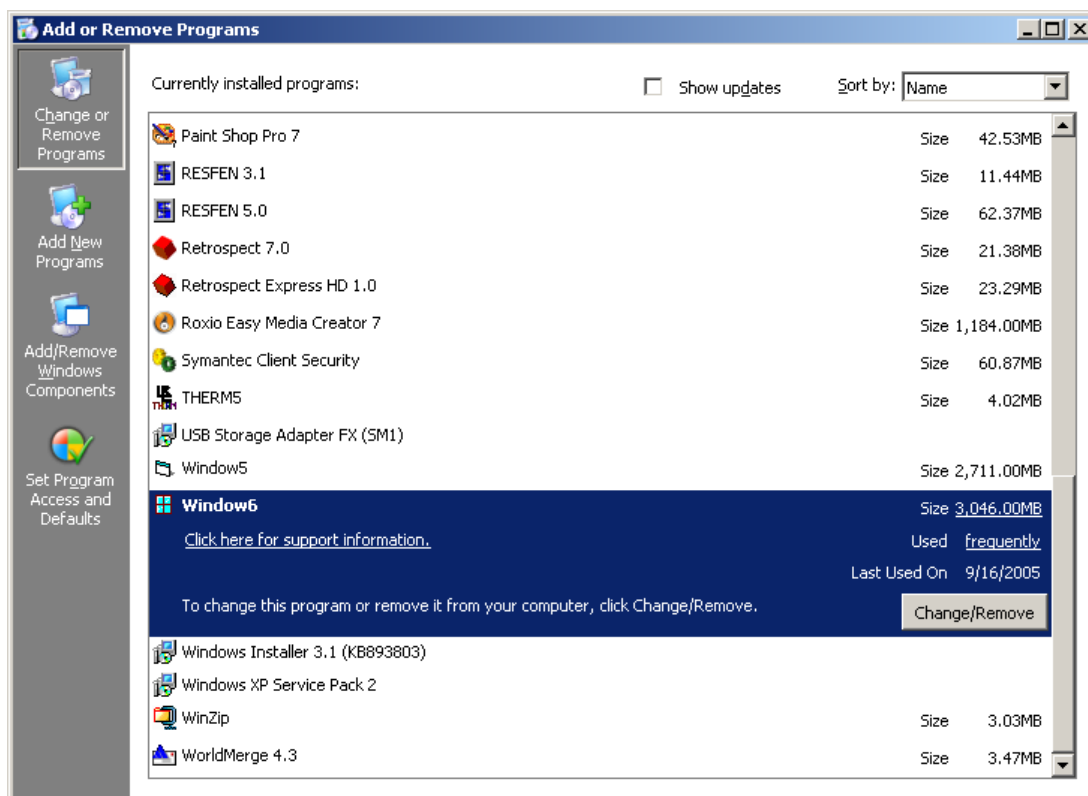

Figure 3-16. Select the WINDOW 5 Beta 1 program and click the Add/Remove button

The **Welcome** window will appear. Click the **Remove** radio button, and then the **Next** button to proceed, or click the **Back** button to go back to the previous step. To cancel the program removal click on the **Cancel** button.

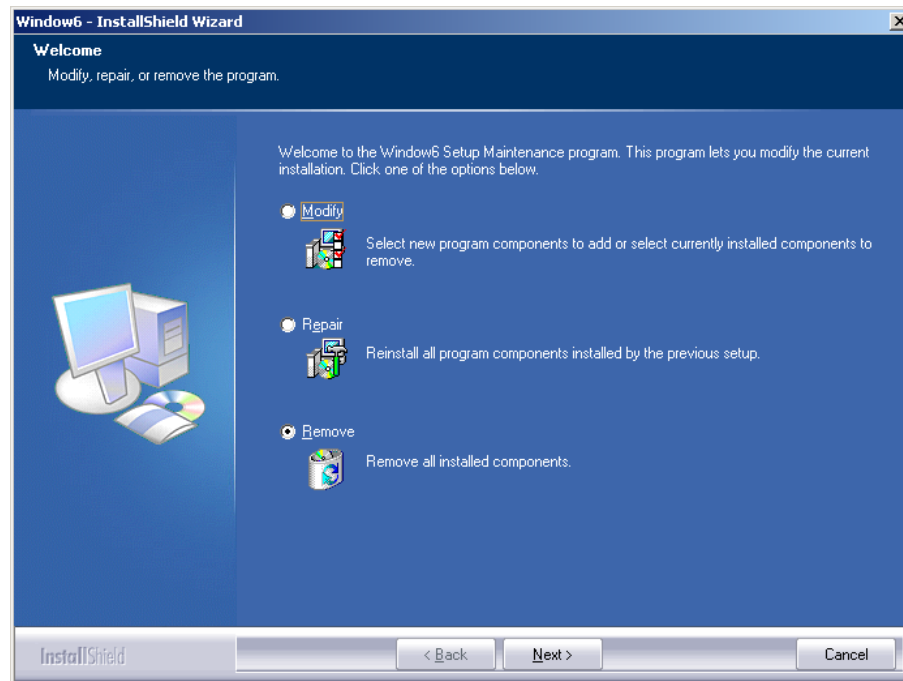

Figure 3-17. Click on the Remove radio button, and then click on the Next button.

The **Confirm File Deletion** window will appear to verify that you want to remove the program. Click the **OK** button to remove the program, or click the **Cancel** button to cancel the program removal.

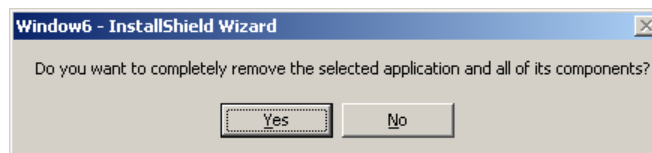

Figure 3-18. Click on the OK button to confirm the removal of the program.

The **Setup Status** window will appear to show the progress of the program removal. To cancel the program removal click on the **Cancel** button.

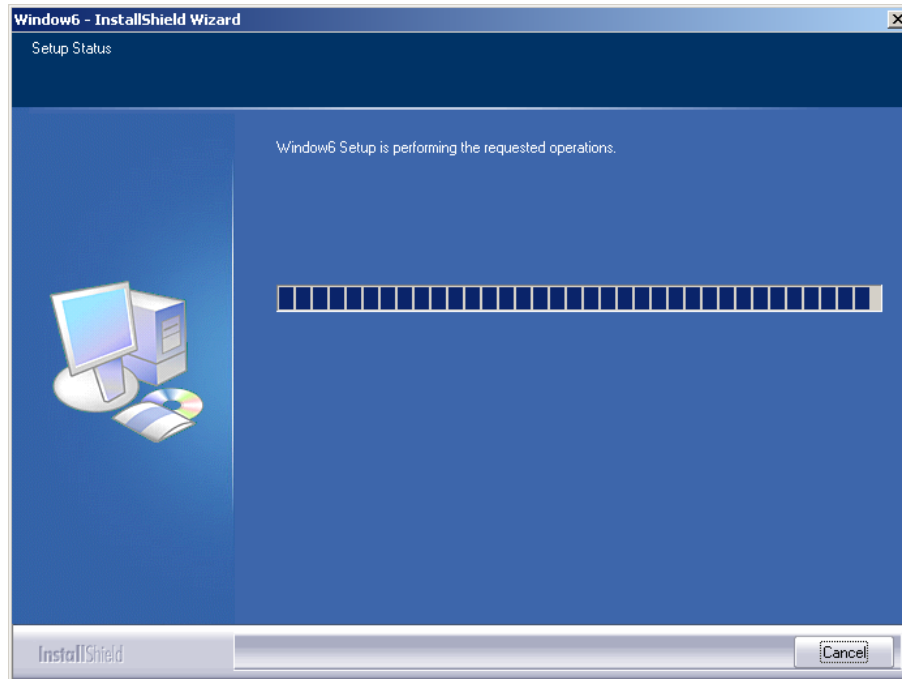

Figure 3-19. The progress of the program removal is displayed in the Uninstalling WINDOW 5 Beta 1 window.

When the removal is complete the **InstallShield Wizard Completed** window will appear. Click the **Finish** button to complete the procedure.

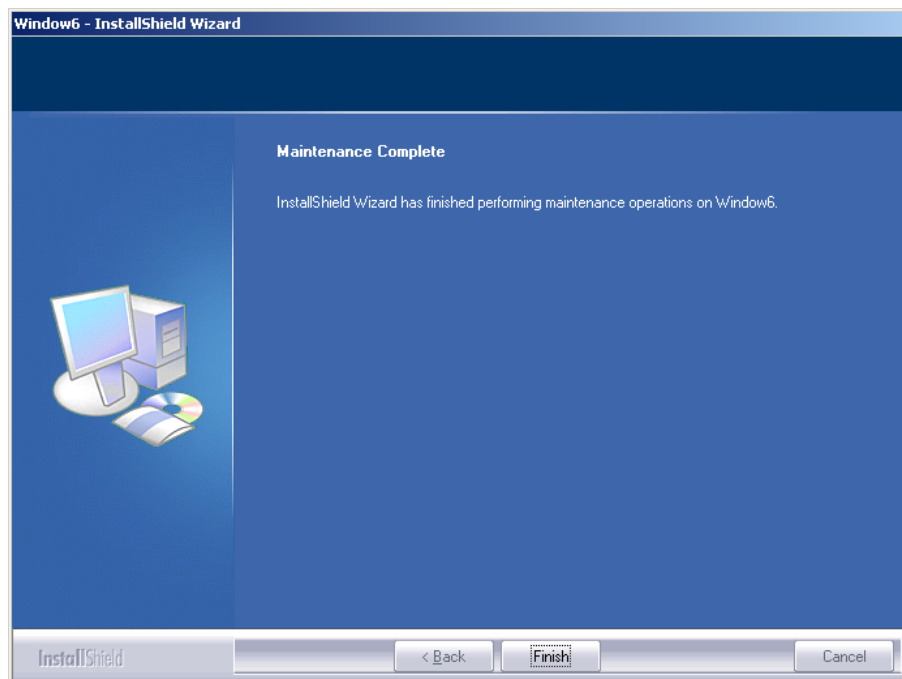

Figure 3-20. Click the Finish button to complete the program removal.

3.5. Installation Procedures for THERM

3.5.3. Before Installing THERM

Close all programs before installing THERM and uninstall any previous versions of the THERM program before starting the installation of this version. However, THERM 5 can remain installed – both versions can be installed on the same machine and will not interfere with each other.

In order to install the program with the Microsoft NT (4.0), 2000, and XP, **you must be Administrator** on your machine. To check if you are Administrator, do the following:

- Go to Start, Settings, Control Panel, Users and Passwords.
- Find the current username (yours) and look in the group column. It should say: “**Administrators**”
- If the current username does NOT say “Administrators”, contact your IP department to become Administrator, or to have someone with Administrator privileges install the program on the machine.

3.5.4. Installing THERM

Put the program installation CD in the appropriate drive or copy the installation file to the computer hard drive.

Run:

THERM0setup.exe

An **InstallShield Wizard** window will appear saying that the installation program preparing the installation. Wait for this window to disappear, and then proceed to the next step. To cancel the installation, click in the **Cancel** button.

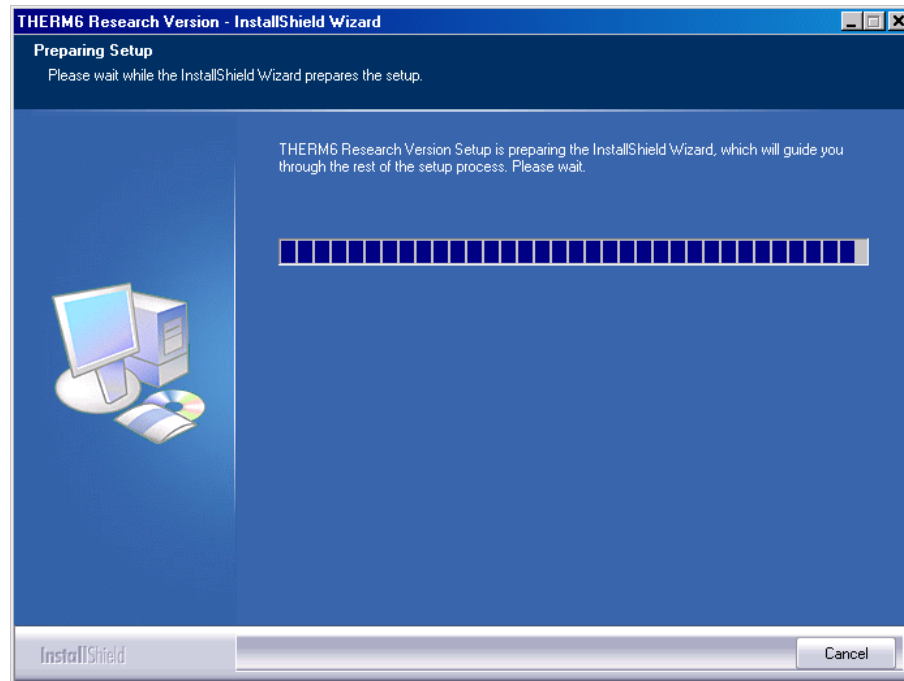

Figure 3-21. The InstallShield Wizard THERM.

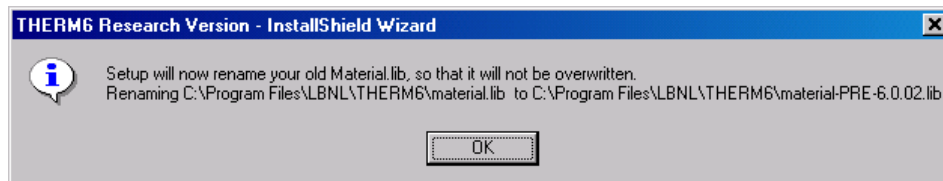

Figure 3-22. Under some circumstances the program may look for and try to rename older libraries.

The THERM Welcome window will appear. Click the **Next** button to proceed, or cancel the installation by clicking on the **Cancel** button.

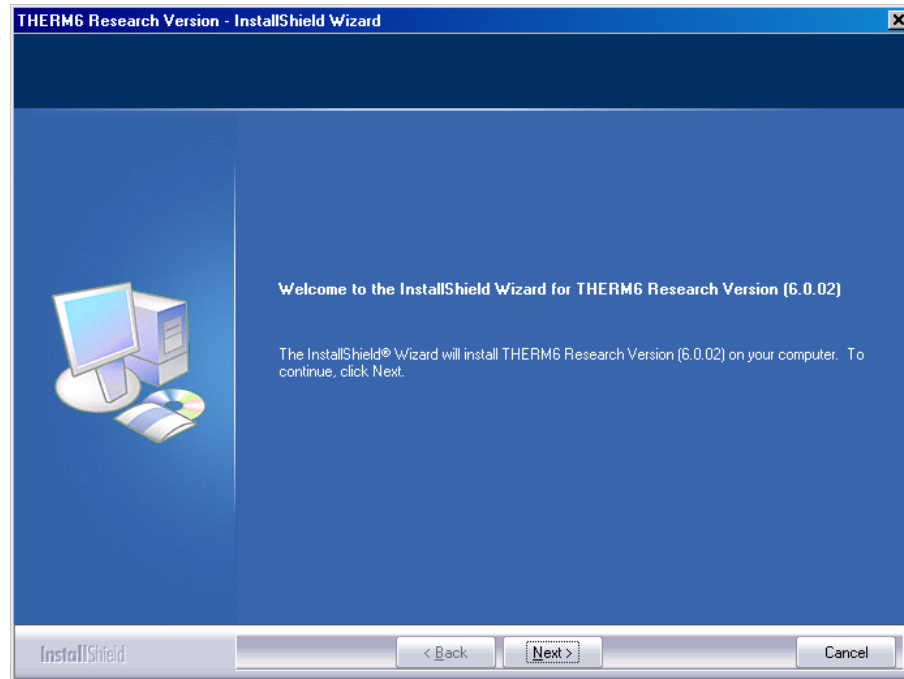

Figure 3-23. The Welcome window.

The **License Agreement** window will appear. After reading and agreeing to the terms of the license, click on **Yes** button to proceed with the installation. Click the **Back** button to go to the previous screen, or cancel the installation by clicking on the **No** button.

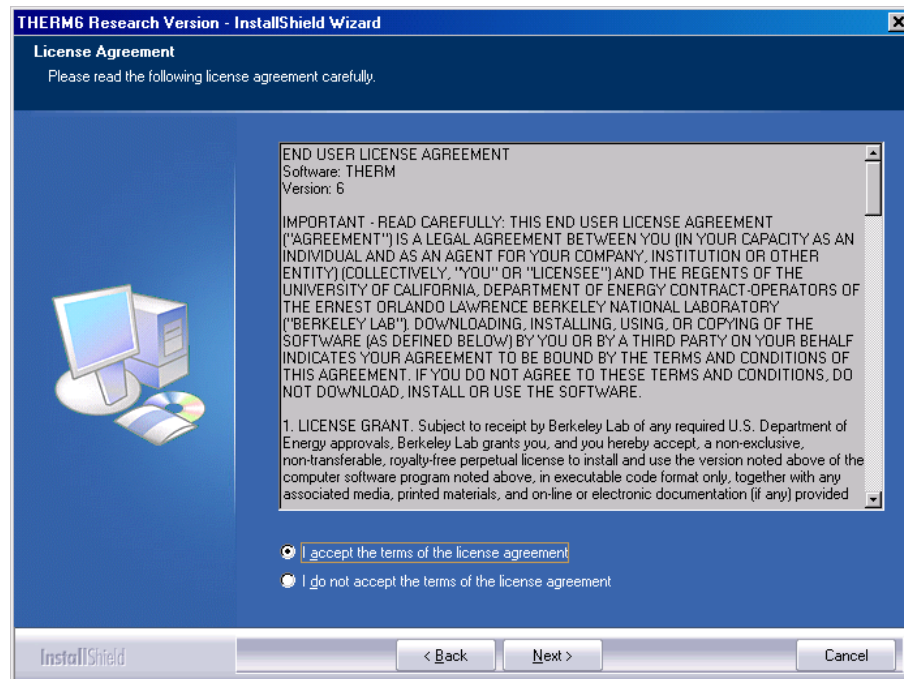

Figure 3-24. The License Agreement window.

The Setup Type window will appear with the installation choices.

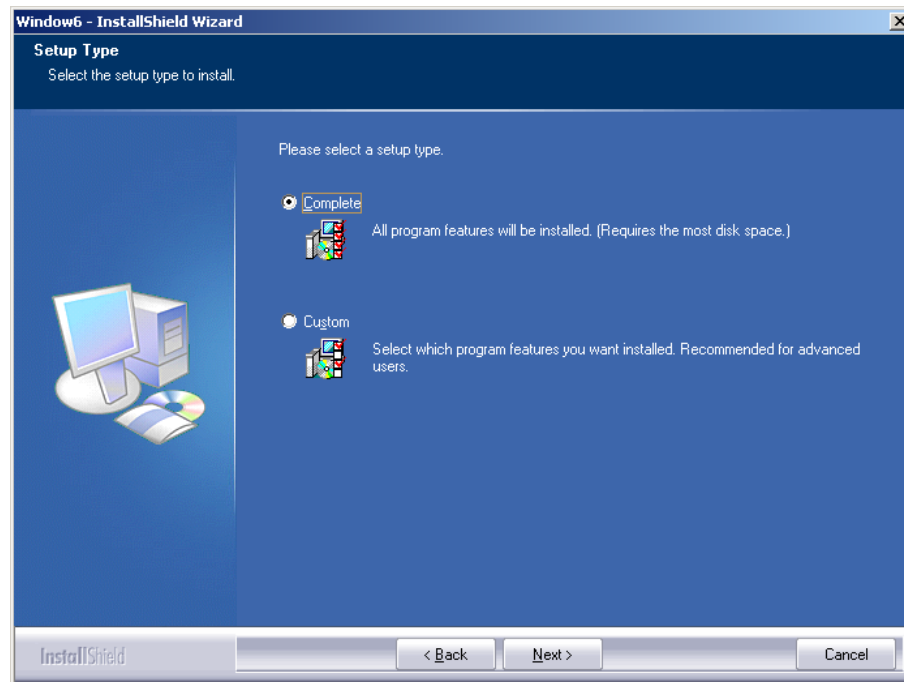

Figure 3-25. The Setup Type window.

- Complete Installation

If the “Complete Installation” option is chosen (it is the default choice), the program will automatically be installed in C:\Program Files\LBNL\THERM. NOTE: It is important to keep this directory structure in order for the THERM installation to be compatible with the Optics5 installation.

- Custom Installation

The Complete Installation choice is recommended in order to use the default paths for the program location. However, if Custom Installation is chosen, the installation will provide a screen where the installation location can be changed from the default. Extreme caution is advised if this structure is changed.

The **Choose Destination Location** window will appear. The default folder for the program is C:\Program Files\LBNL\THERM, and this can be changed by clicking the “Change” button. Click the **Next** button to proceed. Cancel the installation by clicking on the **Cancel** button.

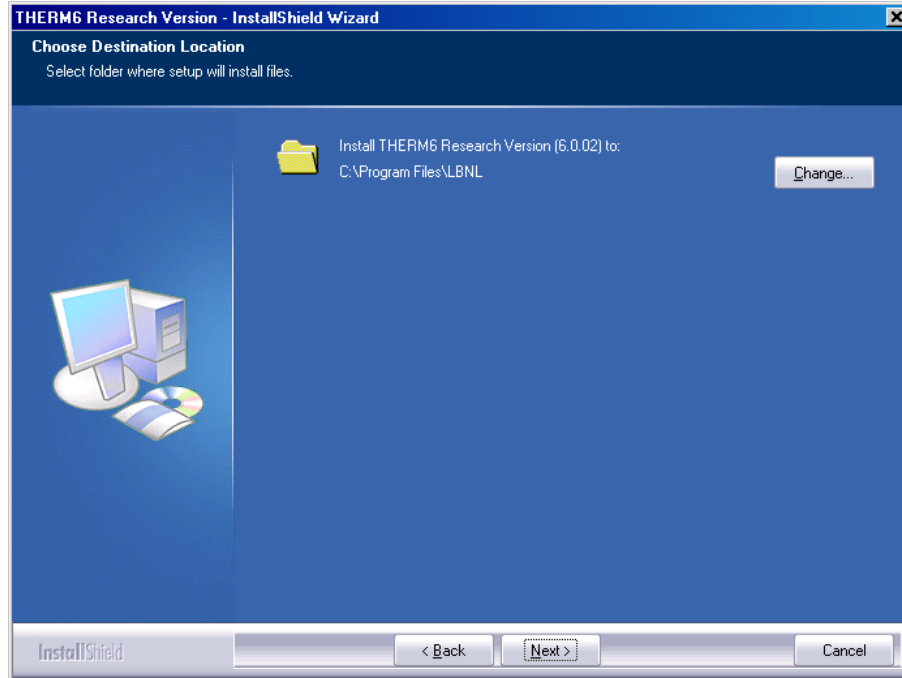

Figure 3-26. The THERM Destination Folder window.

The Change Folder window will appear, and a new path for the program location can be specified.

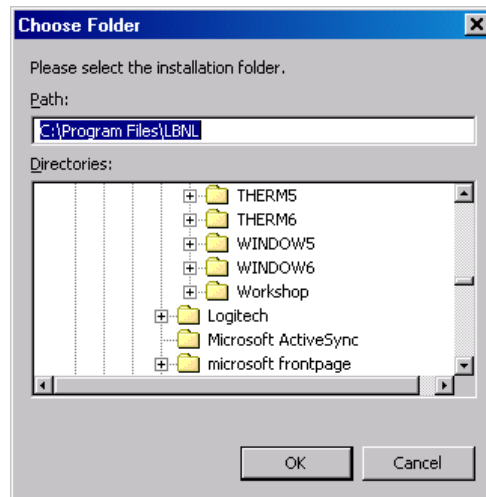
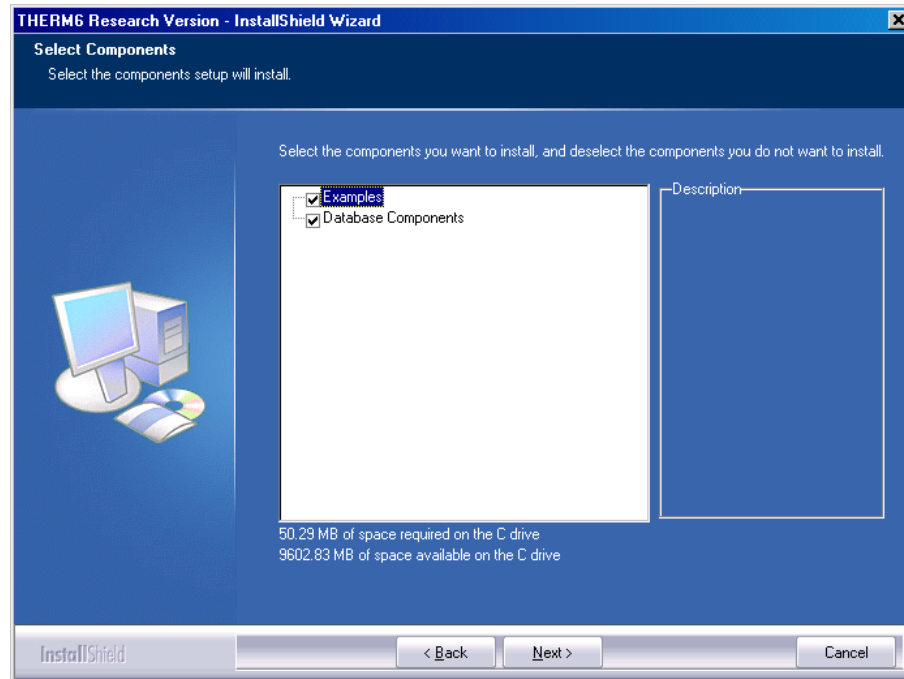
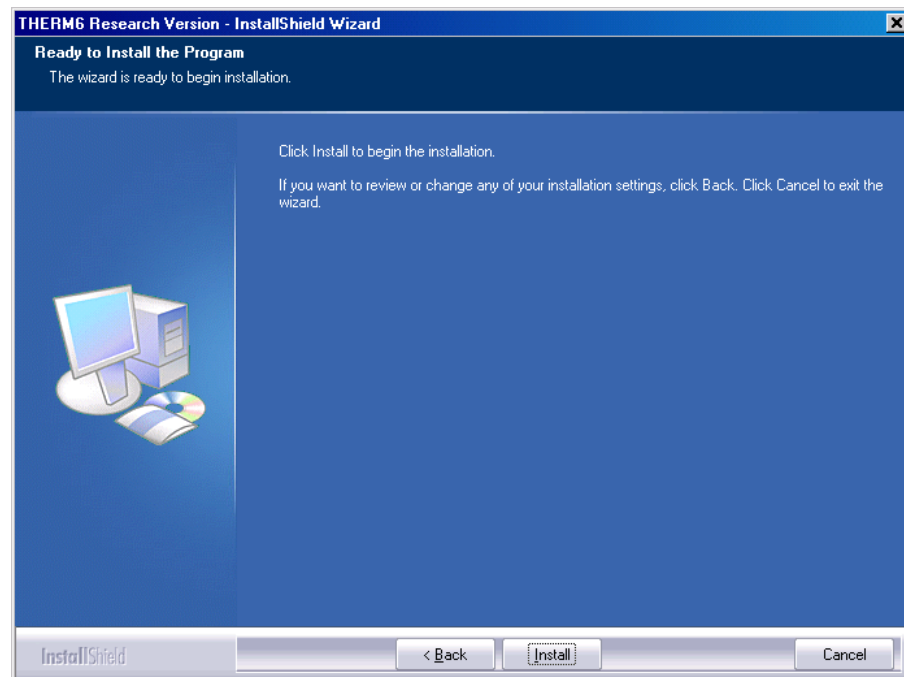

Figure 3-27. The selected installation settings are displayed in the Start Copying Files window.

The Select Components window will appear, and all the components should be checked, then click the Next button.



When the Complete or Custom installation settings have been specified, the “Ready to Install the Program” window will appear. Click “Install” to begin the installation, “Back” to return to the previous installation window, or “Cancel” to stop the installation.



The installation program will install THERM, and show a bar with the completion status in the **Setup Status** window. The installation can be cancelled by clicking on the **Cancel** button.

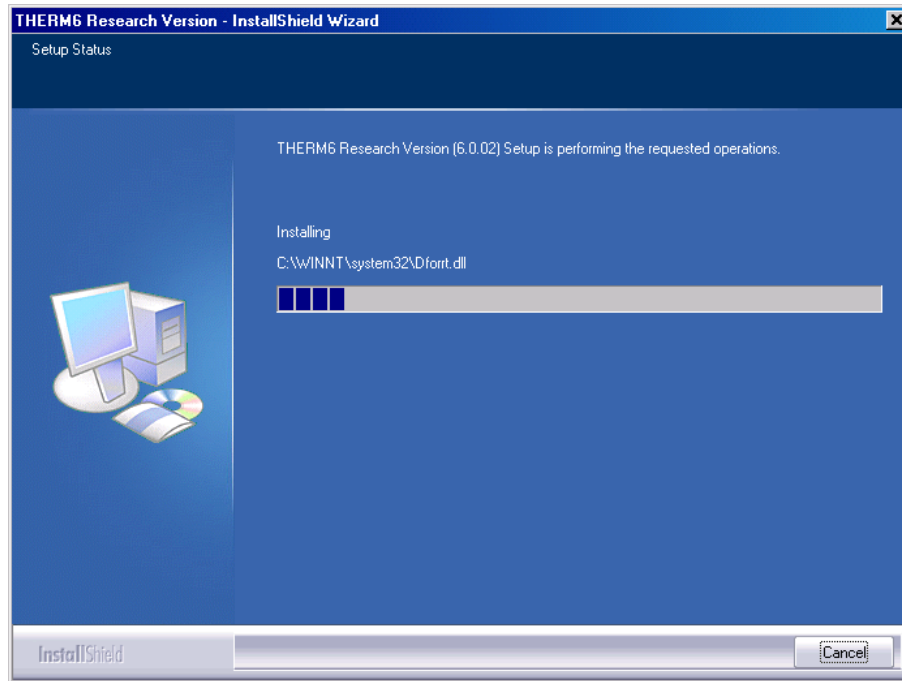

Figure 3-28. THERM is being installed.

When the installation is complete, the **Installation Wizard Complete** window will appear. Click on the **Finish** button to finalize the installation.

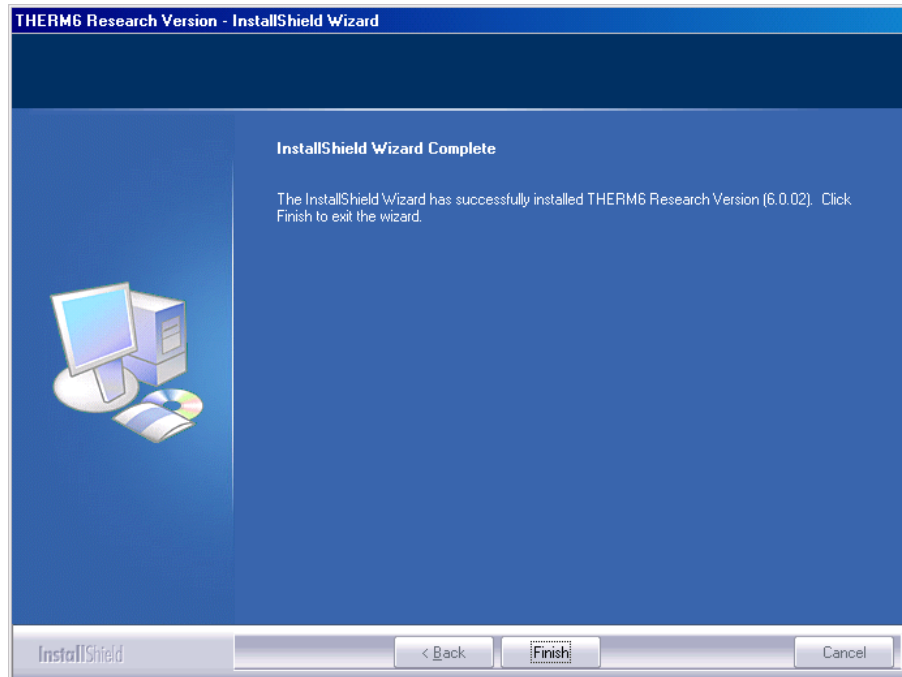

Figure 3-29. Click on the Finish button to complete the installation.

The program can be started from the Start button, Programs, LBNL Software, THERM, as shown below.

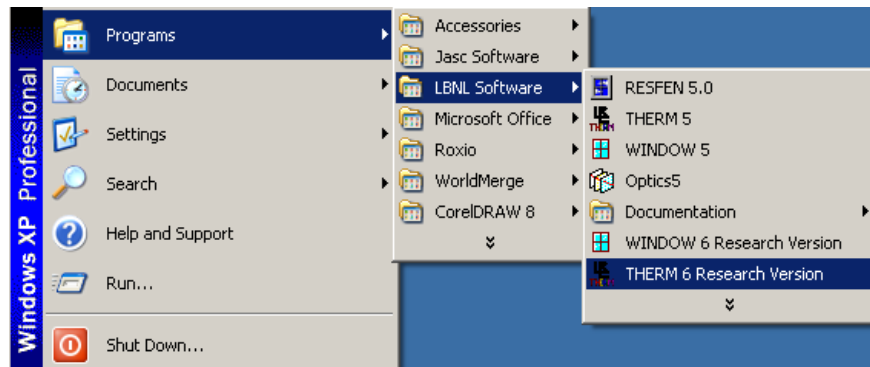

Figure 3-30. Start the program from the Start button.

4. WINDOW 6 Detailed Description

This section documents in detail each part of the program that has changed from WINDOW 5.2 in order to model complex glazing systems. Refer to the WINDOW 5 documentation for details of program features that have not changed. A summary of the changes include:

- Added options in Preferences for complex glazing calculations
- Shading Layer Library added
- Shade Material Library added
- Shading layer added as an option in the Glazing System Library

4. 1. Preferences

The **File/Preferences** menu brings up a dialog box with two tabs. Under the **Options** tabs, two new sections have been added with settings for complex glazing calculations:

- Matrix calculation options
- Venetian blind calculation methods
- WinCOG Options

New settings for complex glazing calculations.

The settings shown here are the standard default settings that pertain to calculations for glazing systems with and without shades.

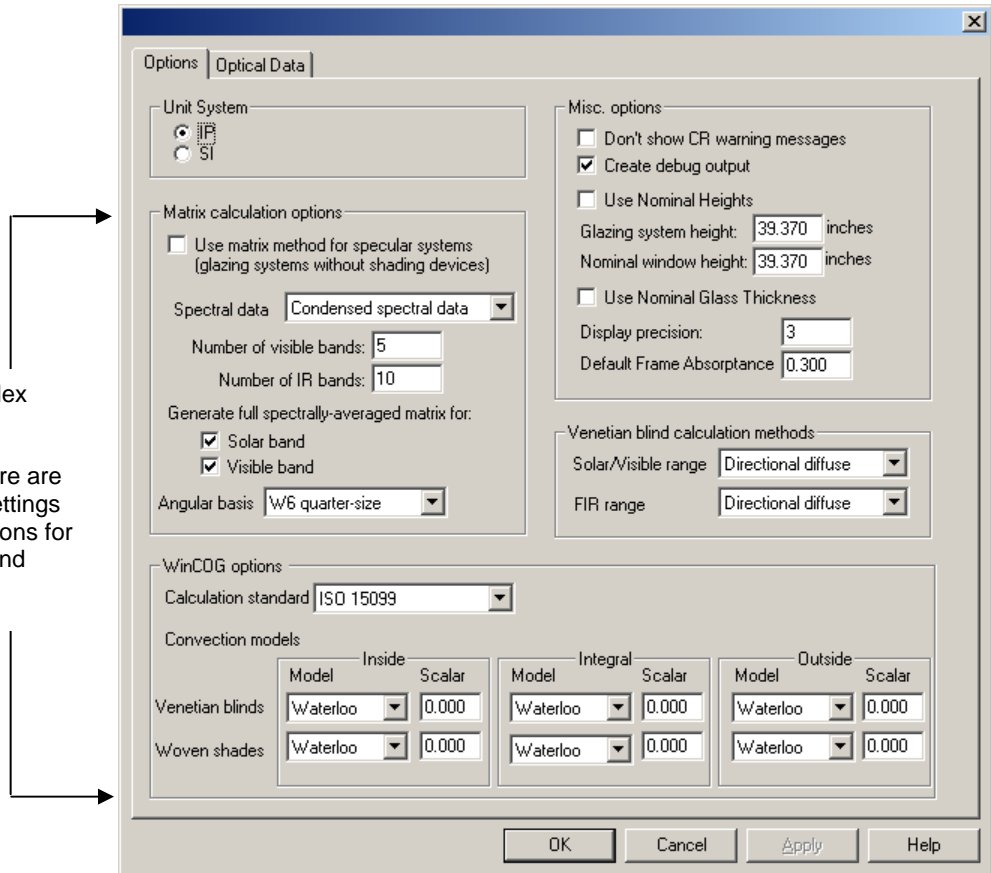

Figure 4-1. There is a new section with many input choices for complex glazing calculations in the Preferences dialog box.

Matrix Calculation Options

The options in this section control the calculation of the optical properties of complex glazing systems such as fritted glass, venetian blinds and roller shades.

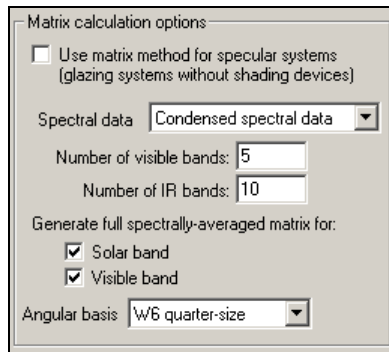

Figure 4-2. Matrix calculation options which control the optical properties calculations .

*Use matrix
Method for
specular systems*

Checking this box will cause the program to use the matrix calculation engine, usually run only for complex glazing systems, for glazing systems without shading devices. Not usually used in normal calculations. If this box is checked, the program will use the spectral data pulldown choices. Also, the results may be different from WINDOW5, which does not use the matrix method for calculations of systems without shading devices. **Default:** Unchecked.

Spectral data

This pulldown list allows several different options for the type of spectral data to use in the matrix method calculations. These choices **ONLY** effect calculations using the matrix calculation method, ie, for complex glazing systems. These choices do not apply to calculations that do not use the matrix calculation method, such as glazing systems without shading systems (unless the “Use matrix method for specular systems is checked, in which case this choice will be used for glazing systems without shading devices). **Default:** Condensed spectral data.

The choices are:

- **Full spectral data:** Selecting full spectral data for a matrix calculation means that the program will use the full set of spectral data for each glass layer and shading layers if available. This choice can result in long calculation times for shading layers. Use this choice to ensure accurate results for the Color Properties tab (although the color tab is currently disabled for complex glazings).
- **ISO 9050 wavelength set:** This is a reduced set of spectral data wavelengths that will be used to select the spectral data values for the glass layers and shading layers if available. This wavelength set is documented in the technical appendix of this manual. Use this choice to ensure accurate results for the Color Properties tab (although the color tab is currently disabled for complex glazings).
- **Condensed spectral data:** This selection allows values to be input in the following two input boxes for “Number of visible bands” and “Number of IR bands”. This is a temporary feature which allows quick results. In the future, a “smart condensing” option will be implemented to replace this.

*Number of
visible bands*

If the “**Condensed spectral data**” choice is selected in the “**Spectral Data**” pulldown list, this input box can be edited. Input the value for the number of wavelengths to be used in the visible band, which is defined as wavelengths of 380 nanometers to 780 nanometers. The wavelengths are sampled evenly across the range. **Range:** 5 to 500. **Default:** 5

*Number of
IR bands*

If the “**Condensed spectral data**” choice is selected in the “**Spectral Data**” pulldown list, this input box can be edited. Input the value for the number of wavelengths to be used in the “near” infrared (IR) band, which is defined as wavelengths of 780 nanometers to 2500 nanometers. The wavelengths are sampled evenly across the range. **Range:** 5 to 500. **Default:** 10.

Generate full Spectrally-averaged Matrix for

*Solar band
Visible band*

When these boxes are NOT checked, WINDOW6 will display the resulting optical properties of complex glazing systems at normal incidence for the incoming angle (horizontal to the glazing system) and hemispherically integrated on the outgoing side. This is what is displayed in the “Center of Glass Results” tab in the lower section of the Glazing System Library for SC, SHGC, Tvis as well as the results in the Optical Data tab in that same section.

The two check boxes in this section will cause the program to generate results for all the angles in the basis used for the calculation (145 incoming and 145 outgoing angles for the WINDOW 6 Full Basis, for example), rather than just the normal incidence hemispherically integrated results. The full matrix of results is needed for the matrix reader to give complete results. Checking these boxes will add somewhat to calculation time, but it is not significant. **Default:** unchecked.

Angular basis

The choices in this pulldown list define the set of angles used by the matrix method calculation. There are currently three choices in the pulldown list:

- **W6 standard basis:** 145 incoming and 145 outgoing angles
- **W6 half-size:** 73 incoming and outgoing angles
- **W6 quarter-size:** 41 incoming and outgoing angles

The number of angles that the matrix calculation engine calculates makes a significant impact on calculation speed, which is why the smaller basis choices have been included. The impact on the results of the number of angles used in the calculations will depend on the properties of the shading device, for example the angle of venetian blind slats. The matrix reader can display results from any of these basis choices, as long as the “Generate full Spectrally-averaged Matrix for” checkboxes (defined above) are checked. **Default:** W6 quarter-size.

Venetian blind calculation methods

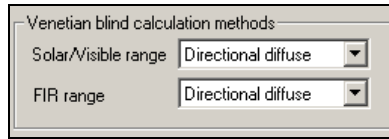

Figure 4-3. Matrix calculation options which control the optical properties calculations.

Solar/Visible range

This pulldown for the calculation methods for venetian blinds in the solar (which includes near IR) / visible range has the following choices. **Default:** Directional diffuse.

- **Uniform diffuse:** uniform diffuse means that a uniform distribution of radiance across all outgoing directions for a given incident direction.
- **Directional diffuse:** directional diffuse means that there is a “beam” incident radiation source that produces diffuse transmitted and reflected radiance. This method takes into account individual contributions – radiosities of all parts (segments) of both slat surfaces which are visible at a certain outgoing direction. This approach provides better angular distribution of the diffuse radiation.

FIR range

This pulldown for the calculation methods for venetian blinds in the solar/visible range has the following choices. **Default:** Directional diffuse.

- **Uniform diffuse:** uniform diffuse means that a uniform distribution of radiance across all outgoing directions for a given incident direction.
- **Directional diffuse:** directional diffuse means that there is a “beam” incident radiation source that produces diffuse transmitted and reflected radiance. This method takes into account individual contributions – radiosities of all parts (segments) of both slat surfaces which are visible at a certain outgoing direction. This approach provides better angular distribution of the diffuse radiation.
- **ISO 15099:** This model is as described in 7.3.2.7 in ISO 15099

WinCOG Options

The options in this section of the Preferences dialog box control the options for the thermal calculations for complex glazing systems, such as venetian blinds and roller shades.

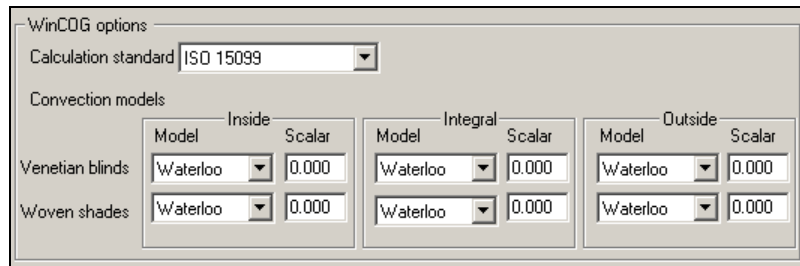

Figure 4-4. The WinCOG options control the thermal calculations for complex glazings .

Calculation Standard

This is the standard that WINDOW will use to calculate the thermal properties of the glazing system

- **ISO 15099:** The thermal model for shading systems as described is ISO 15099 (International Organization for Standards).
- **EN673:** The thermal model for shading systems as described is EN673 (the European Standard).

Convection Models

This section of the Preferences dialog box allows specification of the thermal convection models for different shading devices (such as venetian blinds and roller shades) depending on their position relative to the window.

The three possible positions are:

- **Inside:** This position indicates that the shading device (such as venetian blind or roller shade) is on the inside of the whole window product.

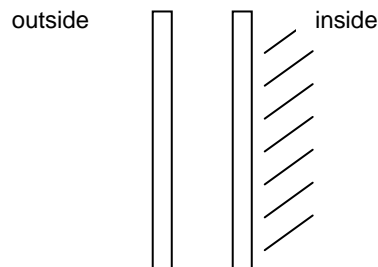

- **Integral:** This position indicates that the shading device (such as venetian blind or roller shade) is between layers of glass in the window assembly.

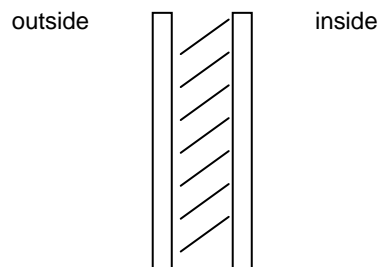

- **Outside:** This position indicates that the shading device (such as venetian blind or roller shade) is on the outside surface of the whole window product.

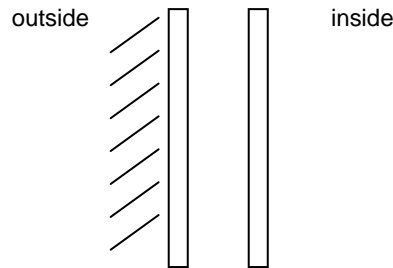

Model and Scalar

For each type of shading system (venetian blind or roller shade) and position, there are two input values that must be selected. These are the thermal model, and any "scalar" or multiplier value associated with that model.

Model and Scalar

- **If Model = ISO 15099:** The "ISO 15099" is an implementation of the venetian blind model in ISO 15099. The "Scalar" column is blank -- instead of entering a scalar value here, there is a value for "Effective hole area fraction" in the **Shading Layer Library**. This model can be used for venetian blinds and roller shades in all three positions (Inside, Integral and Outside).

	Inside		Integral		Outside	
	Model	Scalar	Model	Scalar	Model	Scalar
Venetian blinds	ISO 15099		ISO 15099		ISO 15099	
Woven shades	ISO 15099		ISO 15099		ISO 15099	

- **If Model = Waterloo:** The "Waterloo" model choice is an implementation of the University of Waterloo methodology for modeling venetian blinds between glass. The "Scalar" input value will become visible and should be set to the fraction of the gap between the glass layers that the blind will occupy. The program will then take the difference between this fraction, and divide it equally to represent the distance between the blind and the glass on each side of the blind. **Default:** 0.70 (this means that the width of the blind slats represent 70% of the gap space between the blinds, and therefore there will be 15% of the gap space on either side of the venetian blind).

Integral	
Model	Scalar
Waterloo	0.700
ISO 15099	

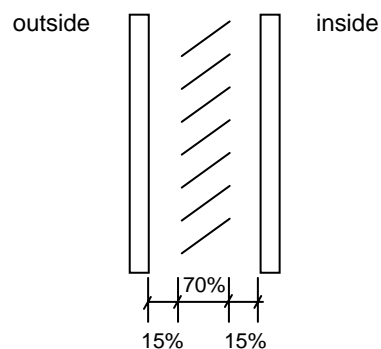

This model is only appropriate for venetian blinds between two glass layers, not for

venetian blinds on the inside or the outside of a glazing system. It is not appropriate for a roller shade in any position.

- **If Model = Scalar:** The “Scalar” model is an impenetation of a model developed at LBNL, which represents a two-state model for the convective effect of the shade on the adjacent glazing system. The “Scalar” input value will not be visible with this option.

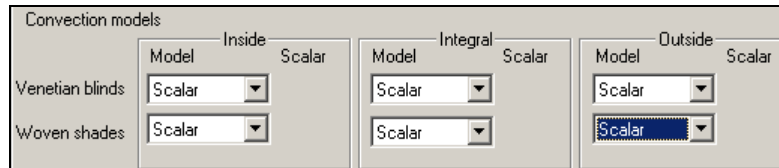

This model can be used for venetian blinds and roller shades in any position on the glazing system (Inside, Integral or Outside). If the Model is set to “Scalar” in Preferences, then an input value for “Convective opacity” will appear in the Shading Layer Library.

In the Shading Layer Library, if the “Convective opacity” is set to 0, there is no effect on convection from the shade, i.e. air can flow freely through it (as if the shade wasn’t there). If the “Convective opacity” is set to 1.0, the shading system acts as a perfectly sealed layer, so that no air can flow through the shading system. For example, for system with a single glass layer and a shading system, if “Convective opacity” = 1.0, the thermal model treats this system as if it were a double layer sealed glazing system. If the “Convective opacity” = 0, the thermal model treats this system as if the shade wasn’t there for convection.

LBNL recommends setting the “Convective opacity” to 0 for most shading devices.

4.2. Shading Layer Library

A Shading Layer Library has been added to the WINDOW6 Libraries.

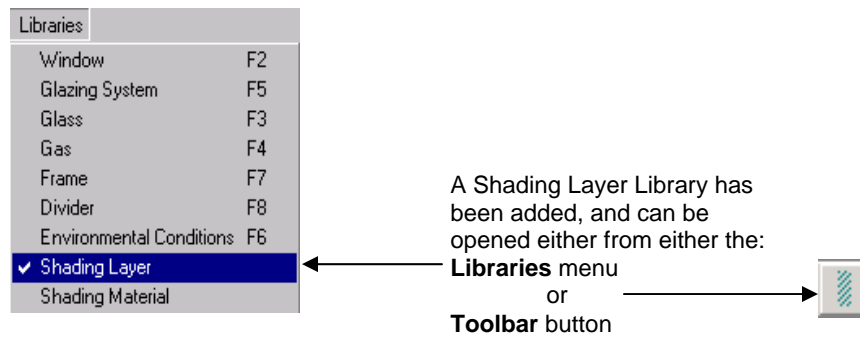

Figure 4-5. The Shading Layer library has been added to the Libraries menu.

The following can be modeled using the Shading Layer Library:

- Horizontal Venetian Blinds
- Diffusing Materials
- Woven Shades
- Fritted Glass

4.2.1. Shading Layer Library List View

The Shading Layer Library List View shows the records in the library. There are several example records in the WINDOW 6 database (W6.mdb) that is included in the installation. These records include venetian blind examples from ISO 15099 (“Venetian A0” to “Venetian D90” with the slat angle and slat material incorporated into the name of the Shading Layer), as well as an example of a BSDF file, a diffusing layer being defined for the shading layer, and a venetian blind with spectral data (the WINDAT example).

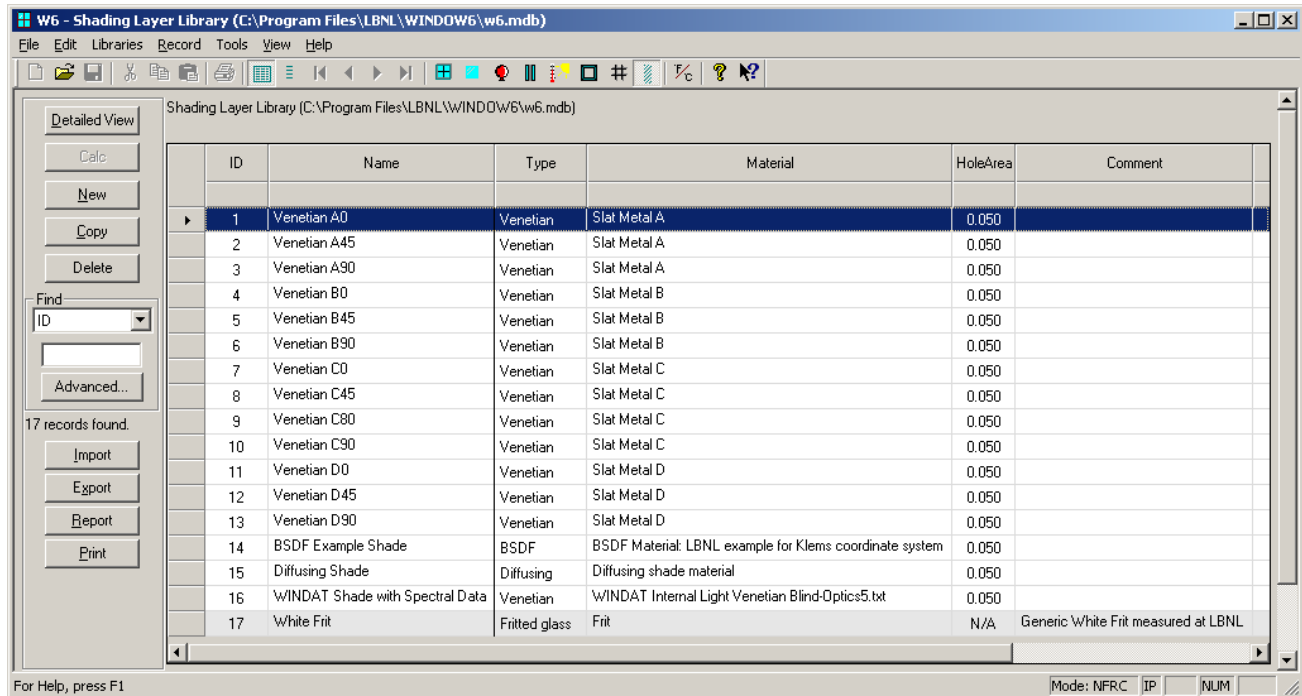

Figure 4-6. The Shading Layer Library List View.

Buttons

The buttons on the left hand side of the List View have the following functions:

- Detailed View* goes to the detailed view of the record, where the input values can be edited.
- New* Used to make a new record, based on a default record.
- Copy* Used to copy an existing record (including name and all associated input values) into a new record.
- Delete* Used to delete the highlighted record(s).
- Find* Used to find a record based on the field selected from the pulldown list, and a value typed into the input box.
- Advanced* Used to access a more advanced method of searching the list
- Import* Currently disabled.
- Export* Used to export records from the Shading Layer Library to either another WINDOW 6 database or to a comma-separated text file.
- Report* Used to create a report containing a summary of the records in the List View.
- Print* Used to print a report which contains a list of all the records in the library.

4.2.2. Shading Layer Library Detailed View

The Shading Layer library currently allows the definition of three types of shading devices, which can be selected from the Type pull-down list:

- Venetian blind, horizontal
- Homogeneous diffusing shade
- Shade with BTDF data
- Woven Shade
- Fritted glass

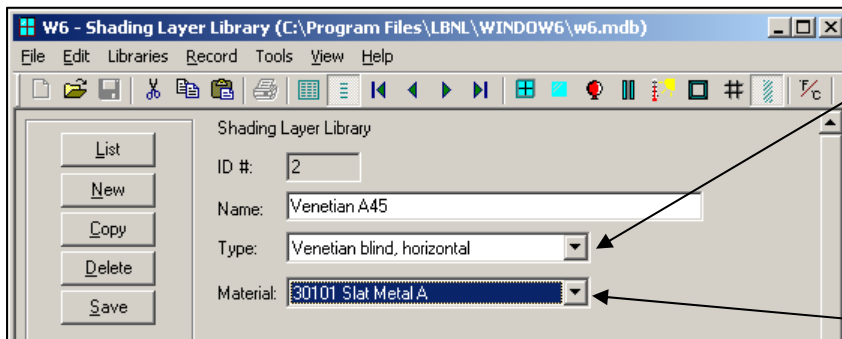

The **Types** pull-down menu includes the following choices:

- Venetian blind, horizontal
- Homogeneous diffusing shade
- Shade with BTDF data

The **Material** pull-down list shows all the records in the **Shade Material Library**.

Figure 4-7. The Shading Layer Library Detailed View for Horizontal Venetian Blinds.

The **Shading Layer Library** screen changes depending on the choice for the **Type** field. The values for the upper half of the screen are as follows:

Buttons

<i>List View</i>	Goes to the list view of the record, where the records in the library are displayed.
<i>New</i>	Used to make a new record, based on a default record.
<i>Copy</i>	Used to copy an existing record (including name and all associated input values) into a new record.
<i>Delete</i>	Used to delete the highlighted record(s).
<i>Save</i>	<i>Not currently implemented.</i> Save a record either using the Record/Save menu choice, or clicking on List, at which point the program will ask if the record should be saved.

Shading Layer Library Input

<i>ID</i>	The unique ID associated with each Shading Layer record.
<i>Name</i>	The name of the Shading Layer .
<i>Type</i>	Type of Shading Layer , from the following list: <ul style="list-style-type: none"> ■ Venetian blind, horizontal: Use this for the classic horizontal slat Venetian blind. ■ Homogeneous diffusing shade: Use this choice for any perfectly diffusing layer that does not have an open weave construction ■ Shade with BSDF data: Use this for any shading layer that has bi-directional scattering distribution function (BSDF) data from either modeling (such as with a ray tracing method) or measurements. ■ Woven Shade: Use this for any shading device that is made of a woven material, including cloth, plastic, or metal.

- **Fritted Glass:**

Material This is a pull-down list that shows the records in the **Shade Material Library**. The record chosen will determine the optical and thermal properties of the material.

The rest of the input values in this library are dependent on the **Type** selected above, and are discussed individually in the following section.

Effective hole Area fraction The effective hole area is a parameter which defines the openness area of a shading layer and is used in the WINDOW 6 heat transfer algorithms (from ISO 15099) to quantify convective heat transfer through the shading layer. Determining this parameter and understanding its impact on shading layer heat transfer is a topic under study. **Default:** At this point, a default value of 0.5 is recommended for all shading layers.

Effective Opacity If the “Convective Opacity” is set to 0, there is no effect on convection from the shade, i.e, air can flow freely through it (as if the shade wasn’t there). If the “Convective Opacity” is set to 1.0, the shading system acts as a perfectly sealed layer, so that no air can flow through the shading system. For example, for system with a single glass layer and a shading system, if “Convective Opacity” = 1.0, the thermal model treats this system as if it were a double layer sealed glazing system. If the “Convective Opacity” = 0, the thermal model treats this system as if the shade wasn’t there for convection. **Default:** LBNL recommends setting the “Convective Opacity” to 0 for most shading devices.

Matrix calc This button can be used to generate a file containing the results of a matrix engine calculation for this layer. The program will ask for a filename and location to save the file to. The file will be a CSV (comma separated text) file that can be imported into a spreadsheet program.

4.2.2.1. Venetian Blind, Horizontal

There are several examples of venetian blinds in the W6.mdb file that is included in the WINDOW 6 installation set. These examples are from ISO 15099, and include 4 different materials (see the **Shade Material Library** section for a description), at several different angles. At this time, each different slat angle must be modeled as a separate record in the **Shading Layer Library**. So for example, there are three entries for venetian blinds made of **Slat Material "A"** (an opaque white material), one for each slat tilt of 0° (horizontal), 45°, and 90° (closed).

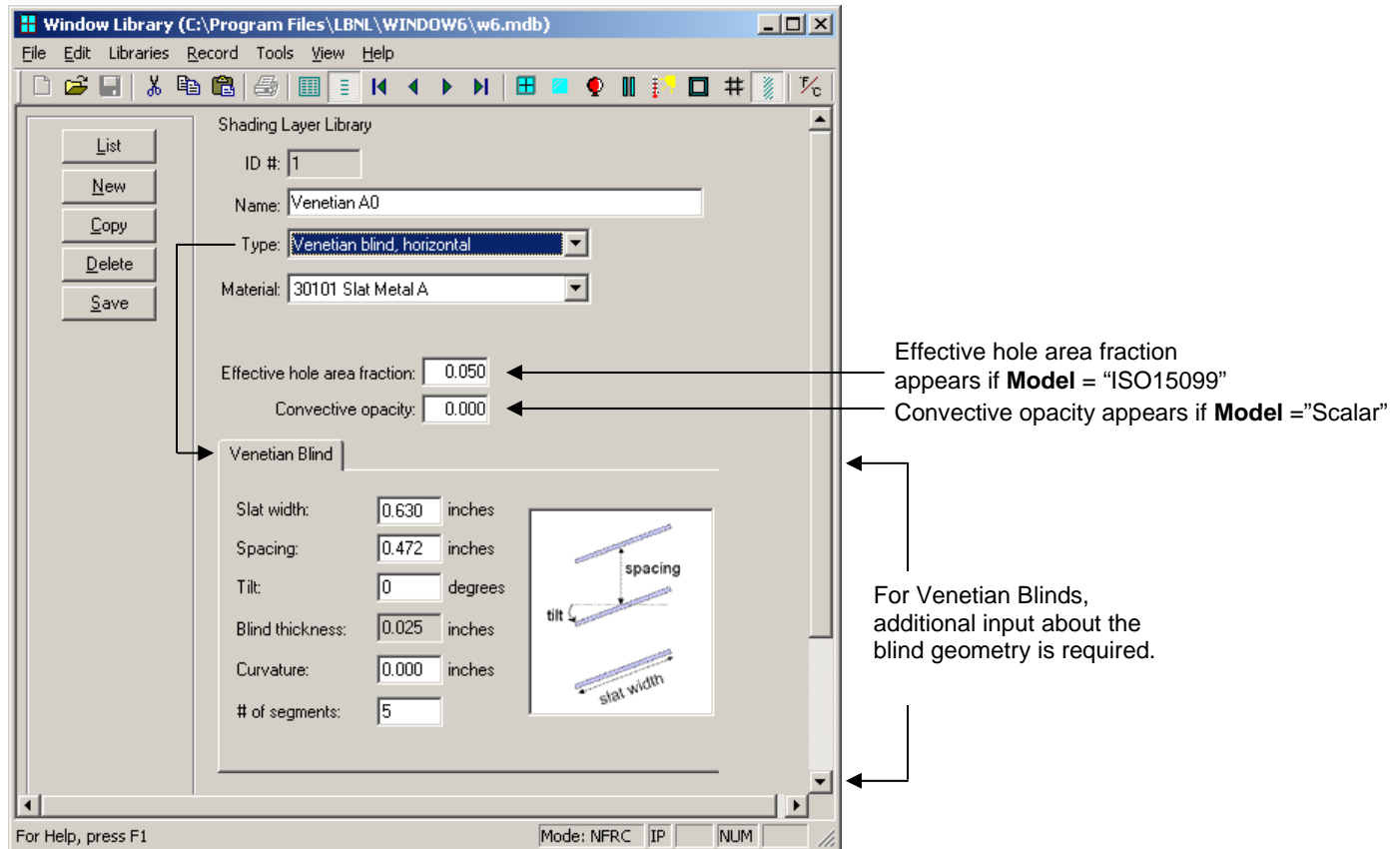

Figure 4-8. The geometry definition for a horizontal Venetian blind.

Input dependent on WinCOG Model set in Preferences

The input values that appear above the Venetian Blind tab will depend on the WinCOG model specified in the Preferences dialog box (accessed from File/Preferences).

- **If Model = ISO 15099:** An input box for “Effective hole area fraction” will appear
- **If Model = Waterloo:** This area will be blank
- **If Model = Scalar:** An input box for “Convective opacity” will appear

If the “Convective opacity” is set to 0, there is no effect on convection from the shade, i.e, air can flow freely through it (as if the shade wasn’t there). If the “Convective opacity” is set to 1.0, the shading system acts as a perfectly sealed layer, so that no air can flow through the shading system. For example, for system with a single glass layer and a shading system, if “Convective opacity” = 1.0, the thermal

model treats this system as if it were a double layer sealed glazing system. If the “Convective opacity” = 0, the thermal model treats this system as if the shade wasn’t there for convection.

LBNL recommends setting the “Convective opacity” to 0 for most shading devices.

Venetian Blind Tab (for defining venetian blind geometry)

<i>Slat width</i>	Width of the slat. Units: millimeters (SI), inches (IP).
<i>Spacing</i>	Spacing of the slats. Units: millimeters (SI), inches (IP).
<i>Tilt</i>	Tilt of the slat. A different record must be created in the Shading Layer Library for every tilt that is to be modeled. Units: degrees from horizontal, can be either positive or negative. <ul style="list-style-type: none"> ▪ 0 = slats are horizontal ▪ 90 = slats are vertical (blinds closed) ▪ 45 = slats are tilted down at the outside, up at the inside ▪ -45 = slats are tilted up at the outside, and down at the inside

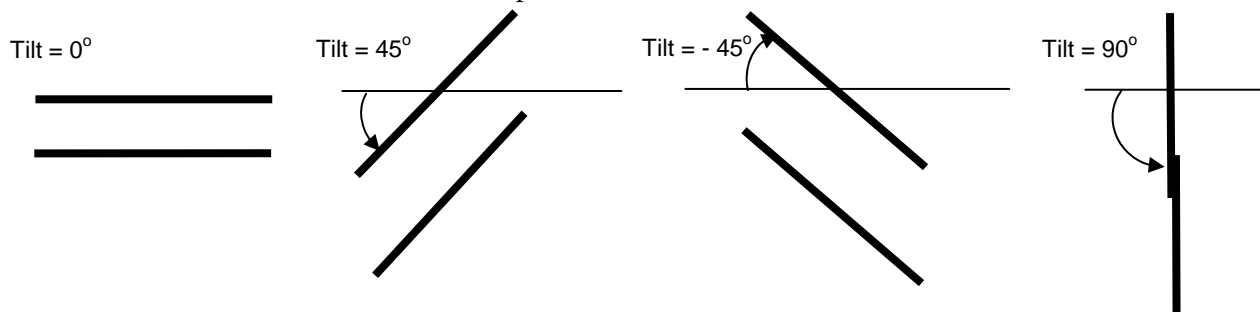

<i>Blind thickness</i>	this thickness is calculated by the program based on the input for Slat width and Tilt. Units: millimeters (SI), inches (IP).
<i>Curvature</i>	The interior radius of the curvature of the venetian blind slat. Units: millimeters (SI), inches (IP).
<i># of segments</i>	if the slat is curved, the program will determine that curve by dividing it into an equal number of segments. The number of segments to determine that curve is entered here.
<i>Comment</i>	Comment about the Shading Layer, optional input.

4.2.2.2. Homogeneous Diffusing Shade:

For shading layer of Type “Homogeneous diffusing shade”, no geometry needs to be defined. It is just necessary to reference the appropriate material in the Shade Material library, which should represent a perfectly Lambertian diffusing material.

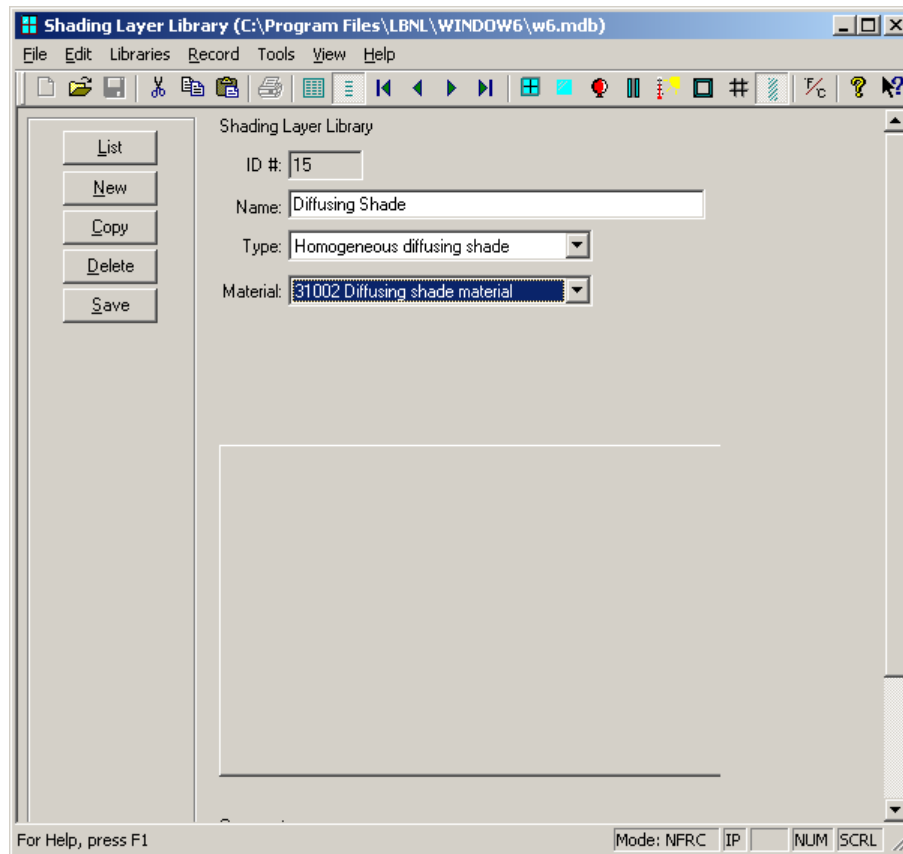

Figure 4-9. Homogeneous diffusing blinds do not have a geometric definition, just a reference to the Shade Material Library.

Homogeneous Diffusing Shade Input

<i>Type</i>	Set type to Homogeneous diffusing shade
<i>Material</i>	Set MATERIAL to a records in the Shade Material Library that is defined for a homogeneous perfectly diffusing shade.

4.2.2.3. Shade with BSDF Data

WINDOW 6 can read a bi-directional scattering distribution function (BSDF) data file (generated, for example, with a ray-tracing program) that has been put into the XML file format as defined in the Technical Reference section of this manual.

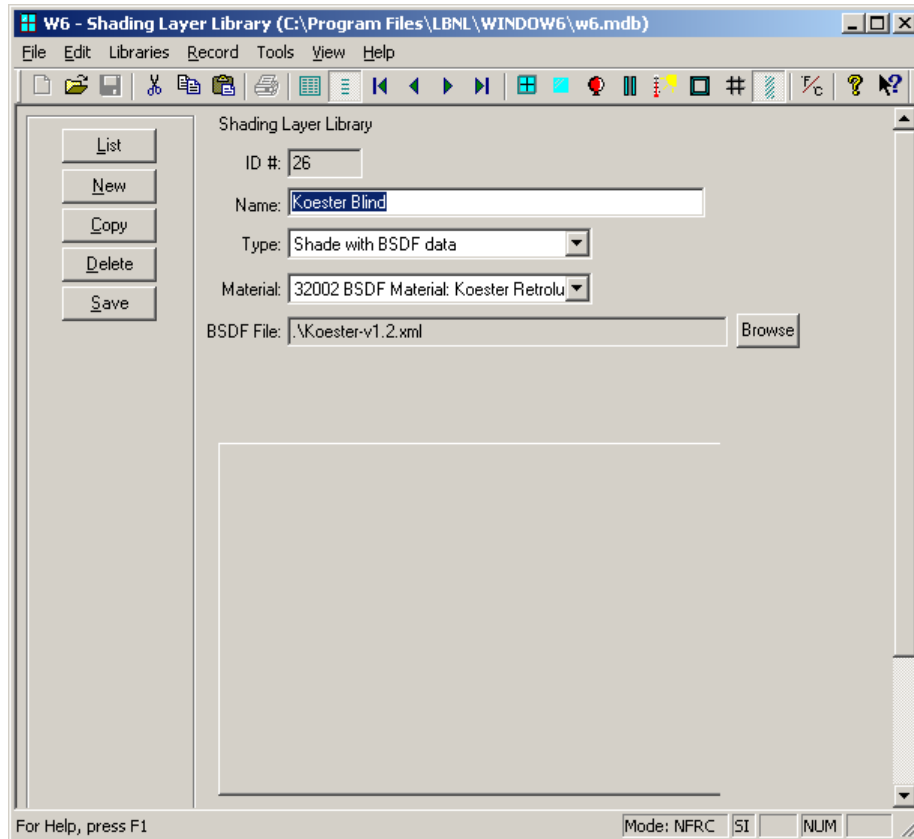

Figure 4-10. The Shading Layer Library for Shade with BSDF data.

BSDF Input

- Type* Set type to **Shade with BSDF data**
- Material* When the BSDF file is referenced, the program will automatically create an entry in the Shade Material Library and will then automatically display the name of that material in this pulldown list. The name of the Material comes from data in the header of the BSDF XML file .
- BSDF File* The **BSDF file** field will appear if **Type** = "Shade with BSDF data". Use the **Browse** button to specify the BSDF file, which must be in the XML format as defined in the Technical Reference section of this manual.
- At this time, the BSDF data file cannot have a complete set of spectral data. There should be just one set of data which represents the visible band and another that represents the near infrared (IR). See the Release Notes for more details.

4.2.2.4. Woven Shade

The woven shade model is based on defining the optical and geometric properties of the thread weave in a the fabric of a woven shade.

In the **Material Library**, the reflectance of the thread is defined, and then in the **Shading Layer Library**, the geometry of the weave is defined.

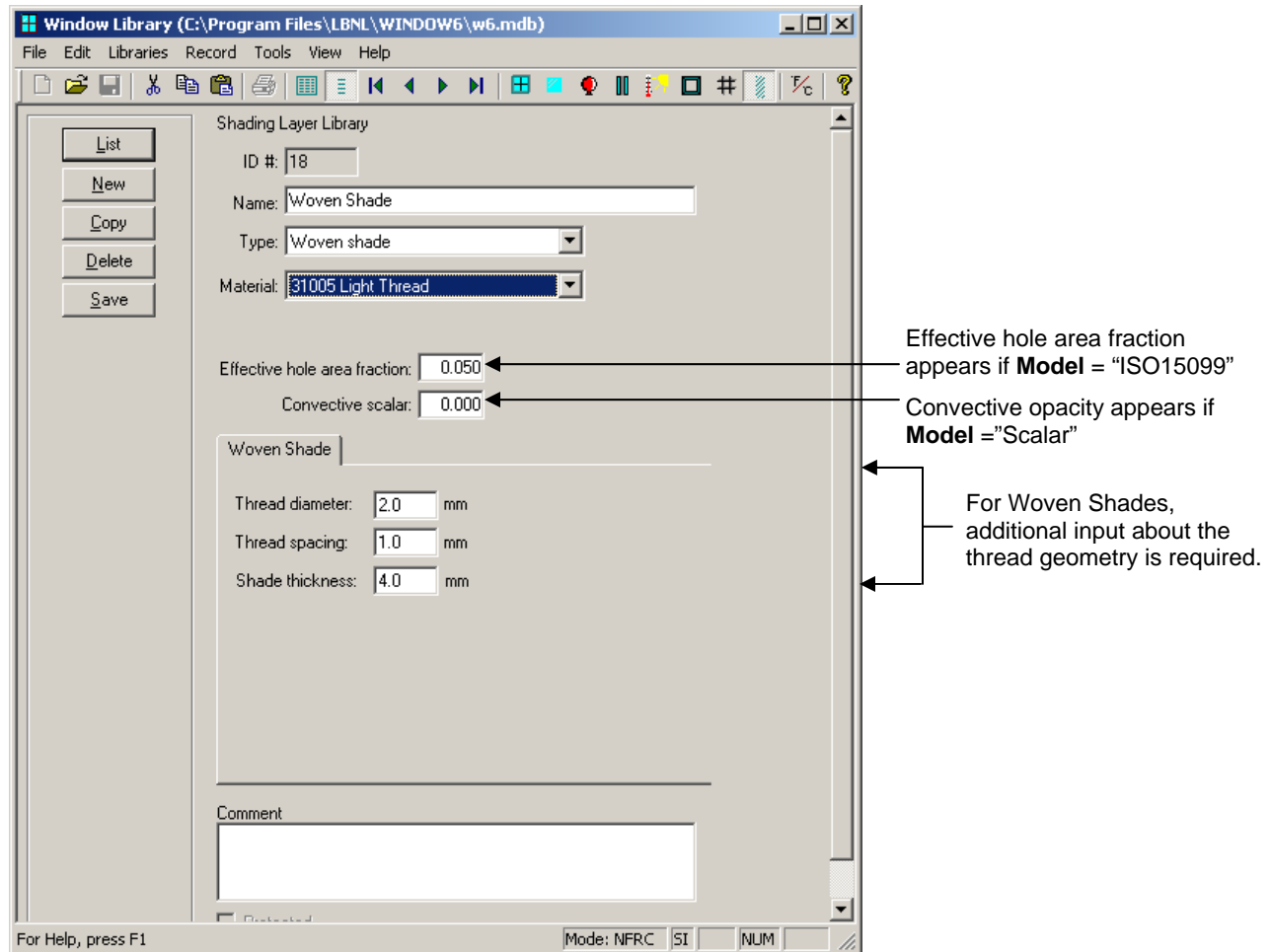

Figure 4-11. The Shading Layer Library for Woven Shade.

Woven Shade Input

<i>Type</i>	Set type to Woven Shade
<i>Material</i>	Select a material from the pulldown list which represents the reflectance of the thread. This material must be defined in the Material List before it will be available in this pulldown list.
<i>Effective hole area fraction</i>	If the WinCOG Model = "ISO 15099" in Preferences, this input will appear. Set this value to 0.
<i>Convective Opacity</i>	If the WinCOG Model = "Scalar:" in Preferences, this input will appear. Set this value to 0.

Woven Shade Geometry

- Thread diameter* This value is the diameter of an individual thread in the fabric of the woven shade.
- Thread spacing* This value is the spacing between threads in the weave of the fabric of the woven shade.
- Shade thickness* This value is the thickness of the fabric of the woven shade.

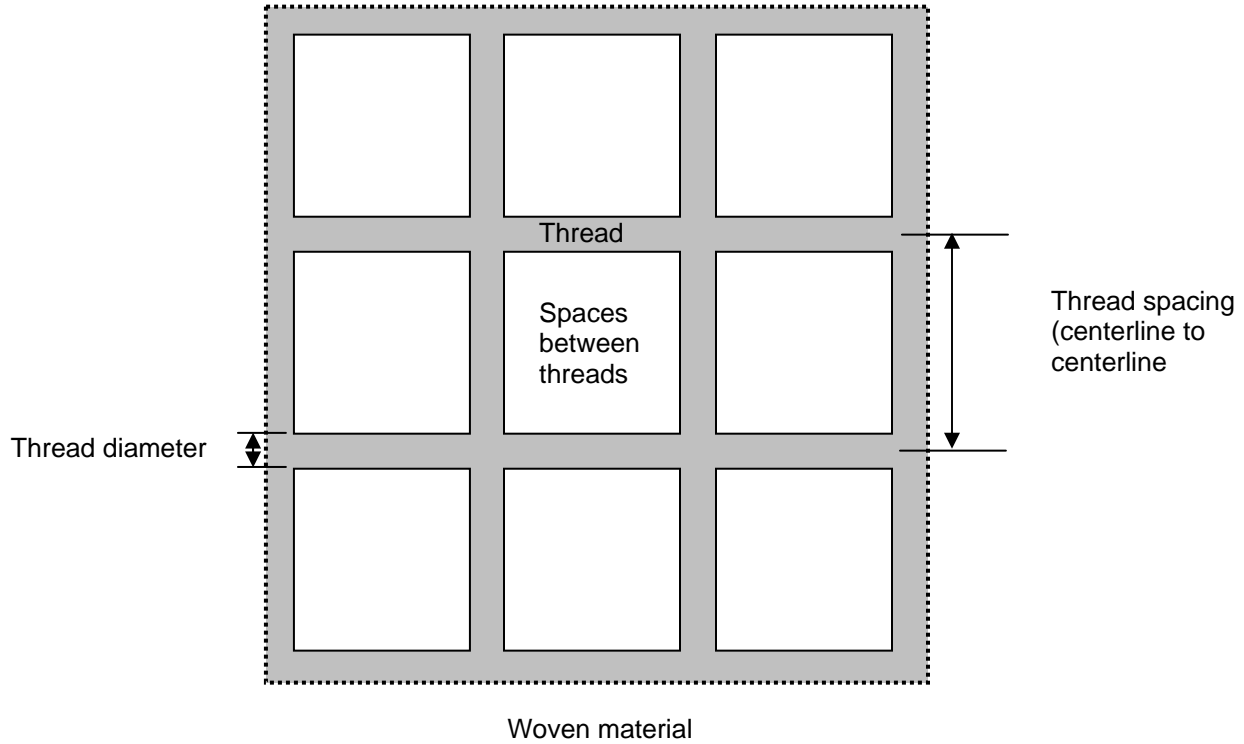
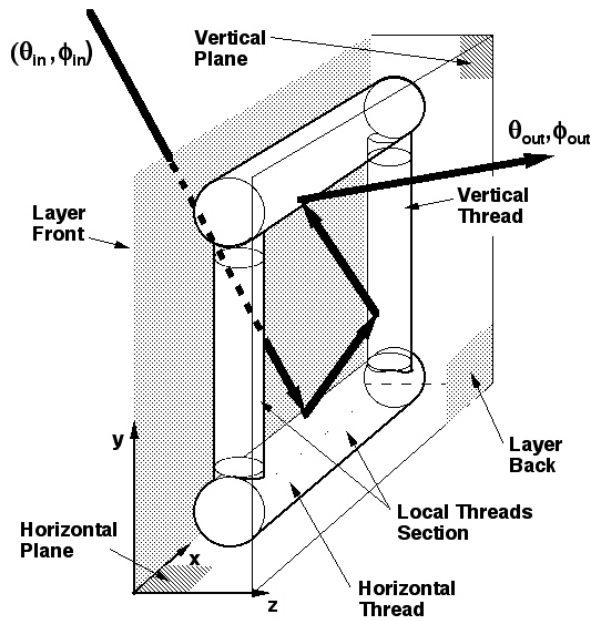

Figure 4-12. Woven shade geometry definitions.



Local Thread Model in a Woven Layer

Figure 4-13. Woven shade modeling technique.

4.2.2.5. Fritted Glass

Fritted glass can be modeled by defining a fritted glass layer in the Shading Layer Library.

The properties of the fritted glass must be measured in a spectrophotometer, with 100% frit coverage on a substrate. The substrate used to measure the frit is specified when defining the fritted glass in WINDOW in the Shading Layer Library. The percentage of frit coverage is input, and WINDOW will calculate the optical properties of the frit percentage specified.

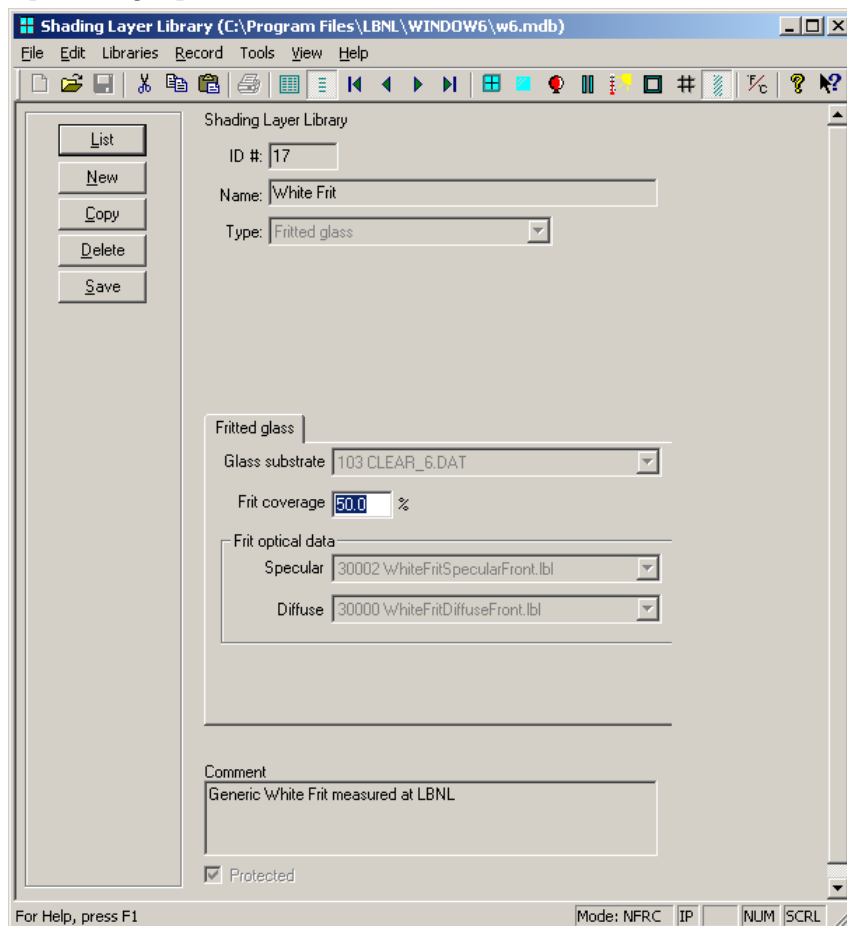

Figure 4-14. The Shading Layer Library for Fritted Glass.

Type Set **Type** to “Fritted Glass”
Material Not used by the program

Fritted Glass Input

Glass Substrate This pulldown list shows all the records in the Glass Library. Select the glass layer that was used as the substrate when the frit was measured. This substrate should not be changed from the measured substrate – if it is, the calculated results from WINDOW will not be valid.

Frit Coverage The percent of the substrate that is covered in the frit. The original measurement to obtain the optical properties of the frit is based on 100% frit coverage, and with that information, WINDOW can recalculate the optical properties of the frit at any frit coverage specified.

Frit Optical data

Specular

Reference to the layer in the **Glass Library** that represents the specular measurement of the glass

Diffuse

Reference to the layer in the **Glass Library** that represents the diffuse measurement of the glass.

ID	Name	ProductName	Manufacturer	Source	Mode	Color	Thickness	Tsol	Rsol1	Rsol2	Tvis	Rvis1	Rvis2	Tir	emis1	emis2	
9932	SolarE3.LOF	Pilkington Solar E1	Pilkington North	IGDB v15.0	#		inches	0.1260	0.459	0.117	0.077	0.601	0.092	0.075	0.000	0.166	0.840
9933	SolarE4.LOF	Pilkington Solar E1	Pilkington North	IGDB v15.0	#		0.1540	0.450	0.117	0.076	0.599	0.092	0.075	0.000	0.166	0.840	
9934	SolarE5.LOF	Pilkington Solar E1	Pilkington North	IGDB v15.0	#		0.1850	0.442	0.116	0.075	0.597	0.092	0.075	0.000	0.166	0.840	
9935	SolarE6.LOF	Pilkington Solar E1	Pilkington North	IGDB v15.0	#		0.2330	0.438	0.117	0.072	0.593	0.093	0.076	0.000	0.166	0.840	
9936	SolarE8.LOF	Pilkington Solar E1	Pilkington North	IGDB v15.0	#		0.3110	0.419	0.116	0.069	0.593	0.092	0.076	0.000	0.166	0.840	
9940	Activ2.lof	Activ1 on Clear	Pilkington North	IGDB v14.6	#		0.0880	0.818	0.123	0.119	0.842	0.149	0.147	0.000	0.833	0.840	
9941	Activ3.lof	Activ1 on Clear	Pilkington North	IGDB v14.6	#		0.1180	0.801	0.122	0.117	0.838	0.149	0.146	0.000	0.833	0.840	
9942	Activ4.lof	Activ1 on Clear	Pilkington North	IGDB v14.6	#		0.1540	0.786	0.120	0.115	0.835	0.148	0.146	0.000	0.833	0.840	
9943	Activ5.lof	Activ1 on Clear	Pilkington North	IGDB v14.6	#		0.1850	0.769	0.118	0.112	0.835	0.145	0.143	0.000	0.833	0.840	
9944	Activ6.lof	Activ1 on Clear	Pilkington North	IGDB v14.6	#		0.2220	0.747	0.120	0.112	0.825	0.151	0.147	0.000	0.833	0.840	
9988	MIROPN6.LOF	Miropanel T.M.	Pilkington North	IGDB v15.0	#		0.2320	0.261	0.317	0.101	0.109	0.681	0.160	0.000	0.846	0.840	
9990	Sec9lam.lof	Solar E1 laminate	Pilkington North	IGDB v12.1	#		0.3340	0.413	0.063	0.121	0.583	0.074	0.099	0.000	0.840	0.152	
30000	WhiteFritDiffuseFront.lbl	White Frit Diffuse (front)	LBNL	IGDB User vUser			0.2362	0.250	0.364	0.209	0.251	0.481	0.308	0.000	0.840	0.840	
30002	WhiteFritSpecularFront.lbl	White Frit Specular (front)	LBNL	IGDB User vUser			0.2362	0.044	0.030	0.050	0.067	0.026	0.049	0.000	0.840	0.840	

Glass Library
 ID #: 30000 Thickness: 0.236 inches
 Name: WhiteFritDiffuseFront.lbl
 Product: White Frit Diffuse (front)
 Manufacturer: LBNL

Solar
 Trans. Front (Tsol): 0.250
 Trans. Back (Tsol2): 0.261
 Reflect. Front (Rsol1): 0.364
 Reflect. Back (Rsol2): 0.209

Visible
 Trans. Front (Tvis): 0.251
 Trans. Back (Tvis2): 0.263
 Reflect. Front (Rvis1): 0.481
 Reflect. Back (Rvis2): 0.308

IR
 Trans (Tir): 0.000
 Emis., Front (Emis1): 0.840
 Emis., Back (Emis2): 0.840

Conductivity: 0.578 Btu/h-ft-F
 Color:
 Diffusing

Comment:
 Protected

Glass Library
 ID #: 30002 Thickness: 0.236 inches
 Name: WhiteFritSpecularFront.lbl
 Product: White Frit Specular (front)
 Manufacturer: LBNL

Solar
 Trans. Front (Tsol): 0.044
 Trans. Back (Tsol2): 0.031
 Reflect. Front (Rsol1): 0.030
 Reflect. Back (Rsol2): 0.050

Visible
 Trans. Front (Tvis): 0.067
 Trans. Back (Tvis2): 0.049
 Reflect. Front (Rvis1): 0.026
 Reflect. Back (Rvis2): 0.049

IR
 Trans (Tir): 0.000
 Emis., Front (Emis1): 0.840
 Emis., Back (Emis2): 0.840

Conductivity: 0.578 Btu/h-ft-F
 Color:
 Diffusing

Comment:
 Protected

4.2.2.6. Shade with Spectral Data for a Venetian Blind

One of the examples in the example W6.mdb file shipped with WINDOW 6, is for a shading layer that represents a venetian blind with spectral data. The spectral data was exported from the WIS program, which is discussed in more detail in the Shade Material Library examples.

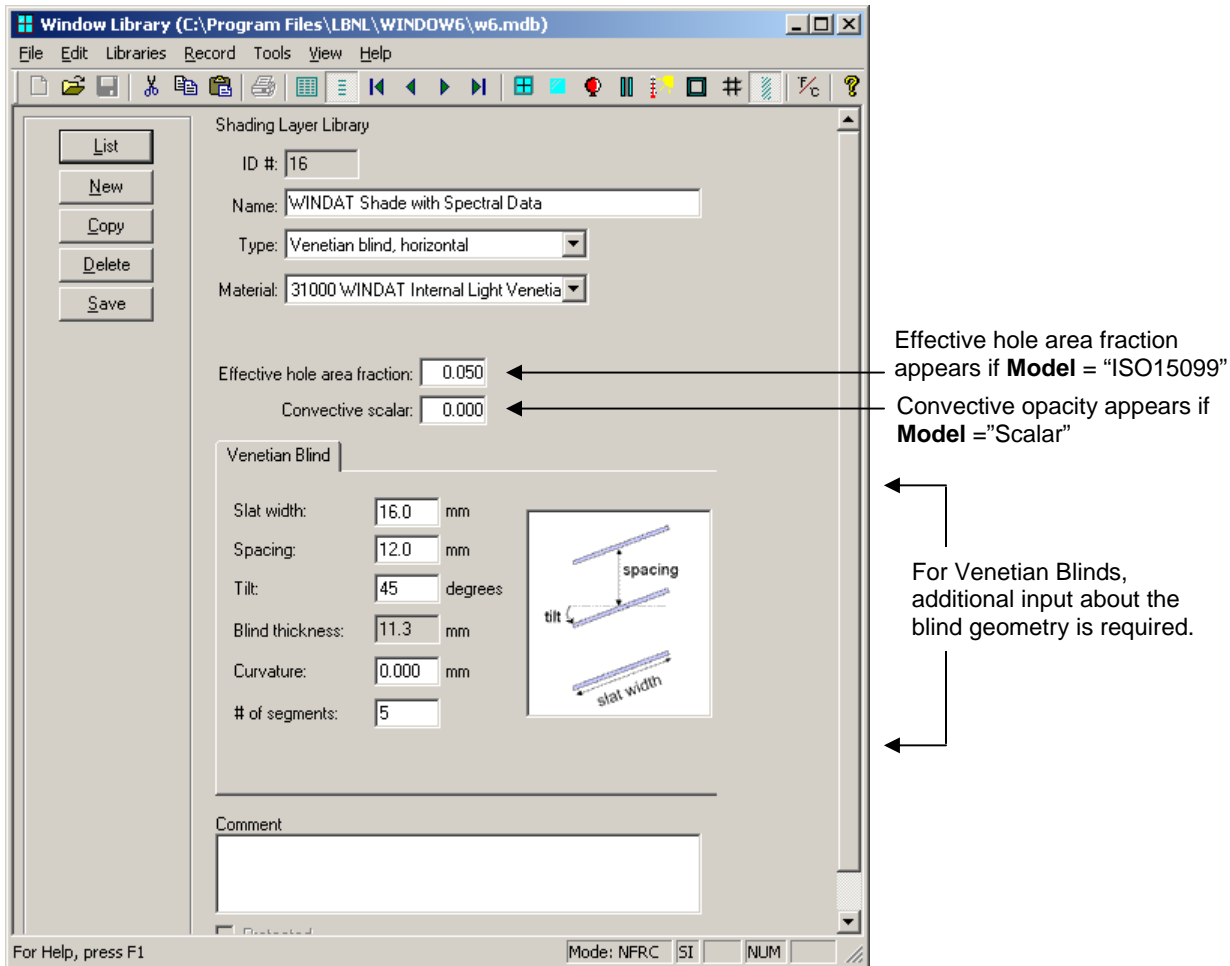

Figure 4-15. The Shading Layer Library for Shade with BSDF data.

Spectral Data Input

- Type* Set type to **Venetian blind, horizontal**, because the spectral data in the shade material is from measurements of a venetian blind.
- Material* In this example, the **Material** field references the record in the Shade Material Library that contains the spectral data for the venetian blind. (See the Shade Material Library example later in this section for more details about this example material).
- BSDF File* The **BSDF file** field will appear if **Type** = "Shade with BSDF data". Use the **Browse** button to specify the BSDF file, which must be in the XML format as defined in the Technical Reference section of this manual.
- At this time, the BSDF data file cannot have a complete set of spectral data. There should be just one set of data which represents the visible band and another that represents the near infrared (IR). See the Release Notes for more details.

Venetian Blind Tab (for defining venetian blind geometry)

<i>Slat width</i>	Width of the slat. Units: millimeters (SI), inches (IP).
<i>Spacing</i>	Spacing of the slats. Units: millimeters (SI), inches (IP).
<i>Tilt</i>	Tilt of the slat. A different record must be created in the Shading Layer Library for every tilt that is to be modeled. This will probably be streamlined in future versions of the program. Units: degrees from horizontal.
<i>Blind thickenss</i>	this thickness is calculated by the program based on the input for Slat width and Tilt. Units: millimeters (SI), inches (IP).
<i>Curvature</i>	The interior radius of the curvature of the venetian blind slat. Units: millimeters (SI), inches (IP).
<i># of segments</i>	if the slat is curved, the program will determine that curve by dividing it into an equal number of segments. The number of segments to determine that curve is entered here.
<i>Comment</i>	Comment about the Shading Layer, optional input.

4.3. Shade Material Library

The **Shade Material Library** is where the optical and thermal properties are defined for shading device materials, which are then referenced from the **Shading Layer Library**.

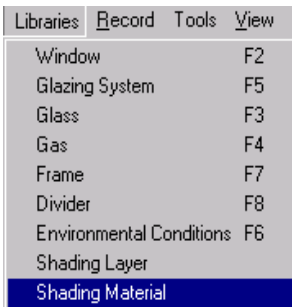

A **Shade Material Library** has been added, and can be opened from the Libraries menu. There is currently not a **Toolbar** button for this library

Figure 4-16. The Shade Material Library has been added.

4.3.1. Shade Material Library List View

The **Shade Material Library List View** shows the records in the library.

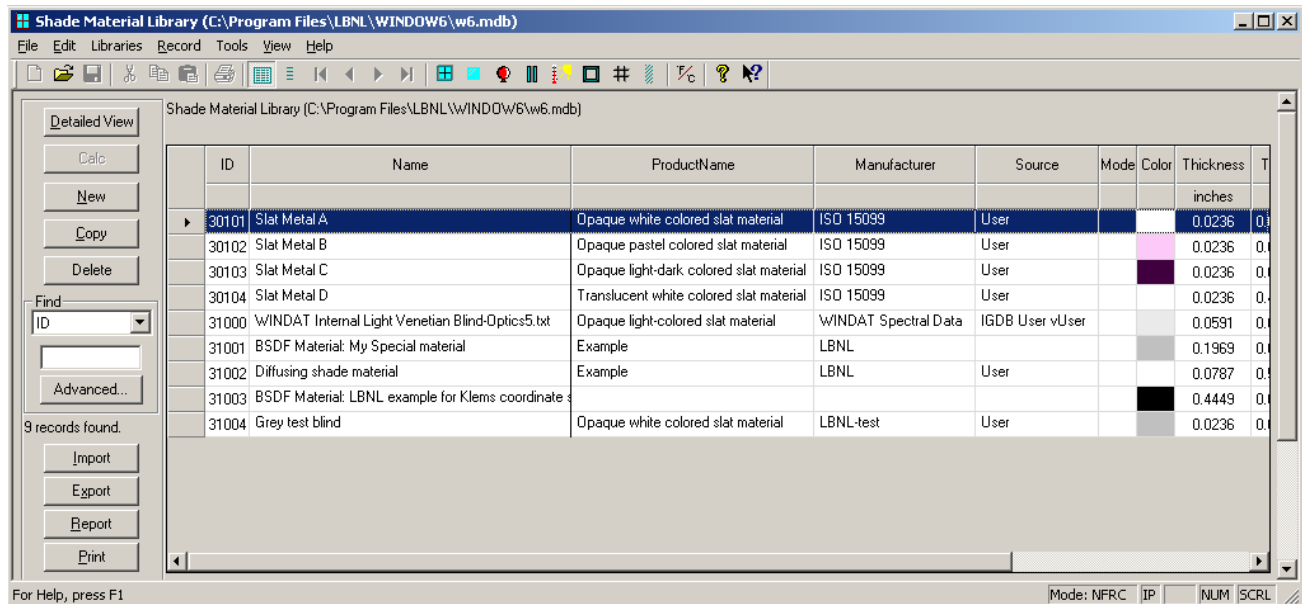

Figure 4-17. The Shade Material Layer Library List View.

Example Records

There are several example records in the W6.mdb file that is part of the WINDOW 6 installation, which are:

- **Slat Metal A:** A material from the ISO 15099 examples that represents the slats of an opaque white-colored metal slat material for a venetian blind.
- **Slat Metal B:** A material from the ISO 15099 examples that represents the slats of an opaque pastel-colored metal slat material for a venetian blind.
- **Slat Metal C:** A material from the ISO 15099 examples that represents the slats of a venetian blind material that are light on one side and dark on the other.
- **Slat Metal D:** A material from the ISO 15099 examples that represents the slats of a translucent white-colored metal slat material for a venetian blind.

- **WINDAT Internal Light Venetian Blind:** A spectral data file of a light venetian blind exported from the WINDAT program, imported as a text file into Optics5, saved into an Optics5 User Database, and then imported into the Shade Material Library.
- **BSDF Material:**
- **Diffusing Shade Material:** An example of a diffusing shade material that does not have spectral data, only averaged optical properties data.
- **Thread Material:** In order to define the thread material for a woven shade, input the properties of the thread into the Material Library. The **Thickness** input on this screen is not used as the thread thickness – this value is defined in the Shading Layer Library.
- **Grey Test Blind:**

Buttons

The buttons on the left hand side of the List View have the following functions:

<i>Detailed View</i>	goes to the detailed view of the record, where the input values can be edited.
<i>New</i>	Used to make a new record, based on a default record.
<i>Copy</i>	Used to copy an existing record (including name and all associated input values) into a new record.
<i>Delete</i>	Used to delete the highlighted record(s).
<i>Find</i>	Used to find a record based on the field selected from the pulldown list, and a value typed into the input box.
<i>Advanced</i>	Used to access a more advanced method of searching the list
<i>Import</i>	Use to import spectral data for the material if it is available. The data must have been imported into the Optics5 program as a text file, saved into the Optics5 user database, and then imported using the choice of "Optics User Database" on the import dialog box.
<i>Export</i>	Used to export records to either another WINDOW 6 database or to a comma-separated text file.
<i>Report</i>	Used to create a report containing a summary of the records in the List View.
<i>Print</i>	Used to print a report which contains a list of all the records in the library.

Column Headings

See the description in the **Shade Material Library Detailed View** section for definitions for most of the column headings. Listed here are columns not included in that description.

<i>Source</i>	Source of the optical data. Current options are: <ul style="list-style-type: none"> ■ Optics: Indicates that the data was imported from the Optics5 database. These records will have the spectral data information from the Optics5 database. ■ User: Indicates that the data was created when the user copied an existing record into a new record. User defined records will not have associated spectral data values.
<i>Mode</i>	An identifier to determine if the layer is approved by NFRC. Only records with "#" in this field can be used for NFRC simulations. This field is currently not relevant, but may be used in the future if complex glazings are approved for use with NFRC certified simulations.

4.3.2. Shade Material Library Detailed View

The **Shade Material Library Detailed View** is where the thermal and optical detailed properties for a material can be entered.

Figure 4-18. The Shade Material Layer Library Detailed View.

The properties of the slat or other shade material are defined in detail in this library, based on spectrophotometric measurements. If spectral data was imported into this library for a material, the values in the **Shade Material Detailed View** are spectrally averaged properties calculated by the program, in the same manner as for glass layers with spectral data.

NOTE: If there is not spectral data for the shade material, WINDOW 6 cannot calculate the UV results (displayed in the Glazing System Library Optical Data tab, UV section), such as Tdw-K, Tdw-ISO, Tuv.

Shade Material Input

The optical properties defined for each Shade Material entry are listed below:

- | | |
|------------------|---|
| <i>ID</i> | The unique ID associated with this record. For records whose Source is "IGDB User", this ID is assigned in the Optics5 User Database. For records whose Source is "User", this ID is assigned automatically by WINDOW but can be overwritten by the user as long as it is unique. |
| <i>Thickness</i> | The thickness of the Shade Material. Units: mm (SI); inches (IP). |
| <i>Name</i> | The name of the shade material. If the record was imported from the Optics5 User Database, this name will automatically come from that database. |

<i>Product</i>	A text field that can be used to specify the product name. If the record was imported from the Optics5 User Database, this name will automatically come from that database.
<i>Manufacturer</i>	The name of the shade material manufacturer. If the record was imported from the Optics5 User Database, this name will automatically come from that database.

Solar

<i>Trans (Tsol)</i>	Solar transmittance of the shade material.
<i>Reflect., Front (Rsol1)</i>	Solar reflectance of the shade material, exterior-facing side.
<i>Reflect., Back (Rsol2)</i>	Solar reflectance of the shade material, interior-facing side.

Visible

<i>Trans (Tvis)</i>	Visible transmittance of the shade material.
<i>Reflect., Front (Rvis1)</i>	Visible reflectance of the shade material, exterior-facing side.
<i>Reflect., Back (Rvis2)</i>	Visible reflectance of the shade material, interior-facing side.

IR

<i>Trans (Tir)</i>	Thermal infrared (longwave) transmittance of the shade material.
<i>Emis., Front emis1</i>	Infrared (longwave) emittance of the shade material, exterior-facing side
<i>Emis., Back emis2</i>	Infrared (longwave) emittance of the shade material, interior-facing side
<i>Conductivity</i>	Conductance of shade material. Units: W/m-K (SI); Btu/h-ft-°F (IP)
<i>Color</i>	A graphic representation of the color of the shade material.
<i>Diffusing</i>	All entries in the Shade Material Library are considered to be IR diffusing layers.
<i>Comment</i>	Text box for entry of comments.

Spectral Data for Shade Materials

If spectral data is available for Shade Materials (as in the WINDAT example below), it must be imported into the Optics5 program, saved into an Optics5 User Database. Once in an Optics5 User Database, it can be imported into the Shade Material Library, as discussed below.

Steps for importing spectral data from an Optics5 User Database:

- From the **List View** of the **Shade Material Library**, click on the **Import** button.
- In the **Import** dialog box, set **Format** to “IGDB or Optics User Database” and click **OK**. (The Optics User Database that the program will open is set in the File / Preferences menu, Optical Data tab).
- A dialog box showing the records in the Optics User Database will display. Select the desired records and click the **Select** button.
- The selected records will be added to the **Shade Material Library**.

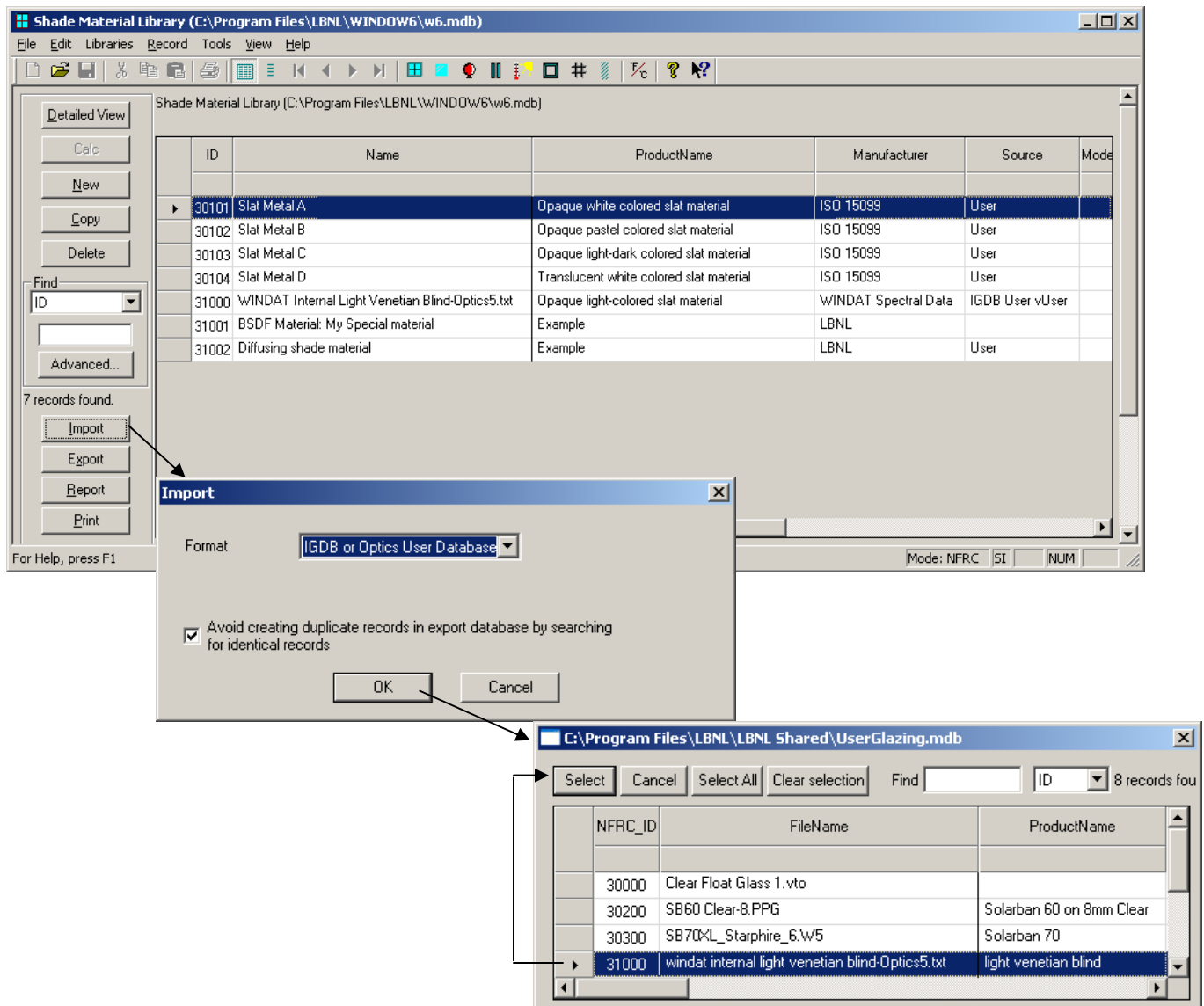

Figure 4-19. Importing spectral data into the Shade Material Library.

In the **Detailed View**, the optical properties displayed are spectrally averaged values calculated from the spectral data.

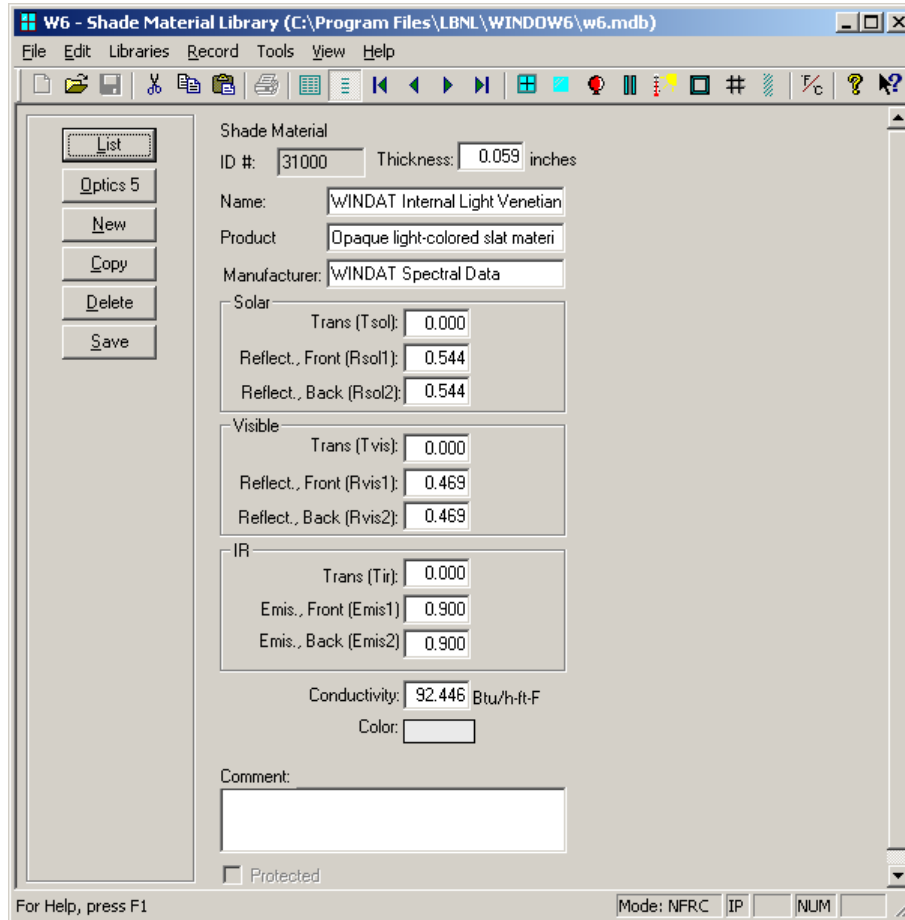

Figure 4-20. The Detailed View of the Shade Material Library displays the average values for optical properties calculated from the imported spectral data..

BSDF Data for Shade Materials

BSDF data is referenced from the **Shading Layer Library**, but at this time, a record corresponding to that BSDF data also needs to be made in the **Shade Material Library**. This is needed in order to define values for Tir and Front and Back emissivities, because WINDOW 6 is not reading that part of the XML file header.

BSDF data can be generated using a ray tracing program, a modeling program, or measurements.

In the example W6.mdb file that is included in the WINDOW 6 installation, there is an example BSDF file that is referenced from the Shade Layer Library (see that section of this manual for more details) and also an entry for that same BSDF file in the Shade Material Library, as shown below.

Only the IR (infrared) properties need to be entered into this record.

Figure 4-21. The Shade Material Layer Library Detailed View of a record that is used with a BSDF file referenced in the Shade Layer Library.

Diffusing Shade Materials

This material is defined for Lambertian perfectly diffusing materials referenced in the **Shade Layer Library**. The W6.mdb included in the WINDOW6 installation includes an example of this type of data, as shown below.

The screenshot displays the 'W6 - Shade Material Library' application window. The title bar indicates the file path: 'C:\Program Files\LBNL\WINDOW6\w6.mdb'. The interface includes a menu bar (File, Edit, Libraries, Record, Tools, View, Help) and a toolbar with various icons. On the left side, there is a vertical panel with buttons for 'List', 'Optics 5', 'New', 'Copy', 'Delete', and 'Save'. The main area is titled 'Shade Material' and contains the following fields:

- ID #: 31002
- Thickness: 0.079 inches
- Name: Diffusing shade material
- Product: Example
- Manufacturer: LBNL
- Solar** properties:
 - Trans (Tsol): 0.500
 - Reflect., Front (Rsol1): 0.300
 - Reflect., Back (Rsol2): 0.300
- Visible** properties:
 - Trans (Tvis): 0.400
 - Reflect., Front (Rvis1): 0.200
 - Reflect., Back (Rvis2): 0.200
- IR** properties:
 - Trans (Tir): 0.000
 - Emis., Front (Emis1): 0.840
 - Emis., Back (Emis2): 0.840
- Conductivity: 0.520 Btu/h-ft-F
- Color: (empty color selection box)
- Comment: (empty text area)
- Protected

At the bottom of the window, there is a status bar with the text 'For Help, press F1' and 'Mode: NFRC IP NUM'.

Figure 4-22. The Shade Material Layer Library Detailed View of a record that is defined for a diffusing layer in the Shade Layer Library.

Woven Shade Material

The Material Library is used to define the thread properties for a woven shade material. All the values should be defined. However, the **Thickness** input in this screen is not used for either the thread diameter or the shade thickness – these are both defined in the Shading Layer Library. If a **Thickness** value is entered in the Material Library for a material used in a woven shade, that thickness is ignored by the program.

The screenshot shows the 'Shade Material Library' window with the following data:

Property	Value
ID #	31003
Thickness	0.6 mm
Name	Light Thread
Product	Light Thread
Manufacturer	
Solar	
Trans (Tsol)	0.000
Reflect., Front (Rsol1)	0.700
Reflect., Back (Rsol2)	0.700
Visible	
Trans (Tvis)	0.000
Reflect., Front (Rvis1)	0.700
Reflect., Back (Rvis2)	0.700
IR	
Trans (Tir)	0.000
Emis., Front (Emis1)	0.900
Emis., Back (Emis2)	0.900
Conductivity	0.127 W/m-K
Color	
Comment	
Protected	<input type="checkbox"/>

Buttons on the left: List, Optics 5, New, Copy, Delete, Save.

Footer: For Help, press F1 | Mode: NFRC | SI | NUM

Figure 4-23. The Shade Material Layer Library Detailed View of a record that is defined for a woven shade in the Shade Layer Library.

4.4. Glass Library

The Glass Library now allows diffusing layers to be defined, by checking the Diffusing box in the detailed view. Defining a perfectly diffusing glass layer differs from defining a perfectly diffusing Shade Material in that the diffusing glass layer will be treated thermally as a piece of glass, as part of an IG, or with single glazing.

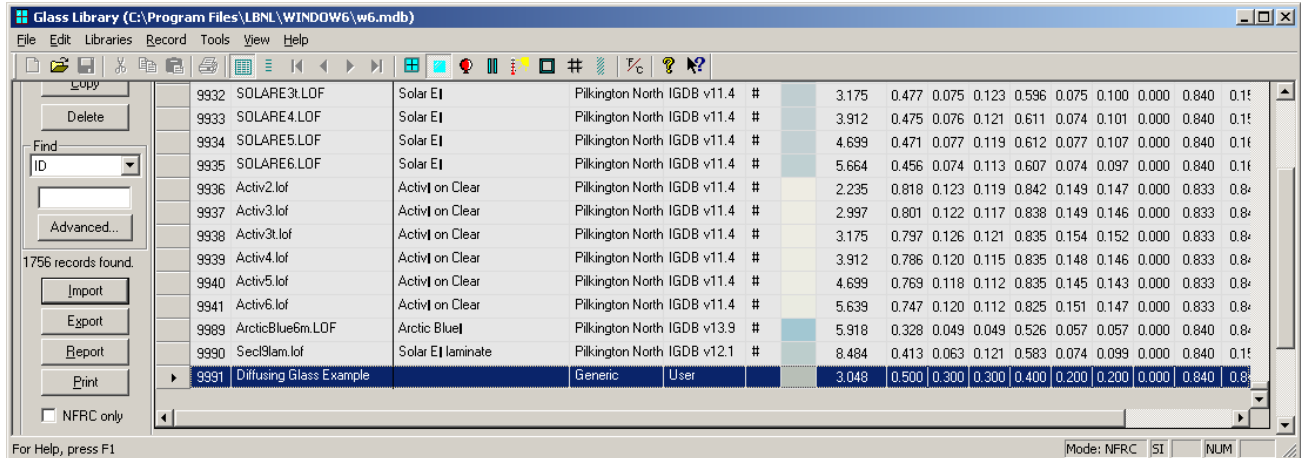

Figure 4-24. Glass Library allows diffusing layers.

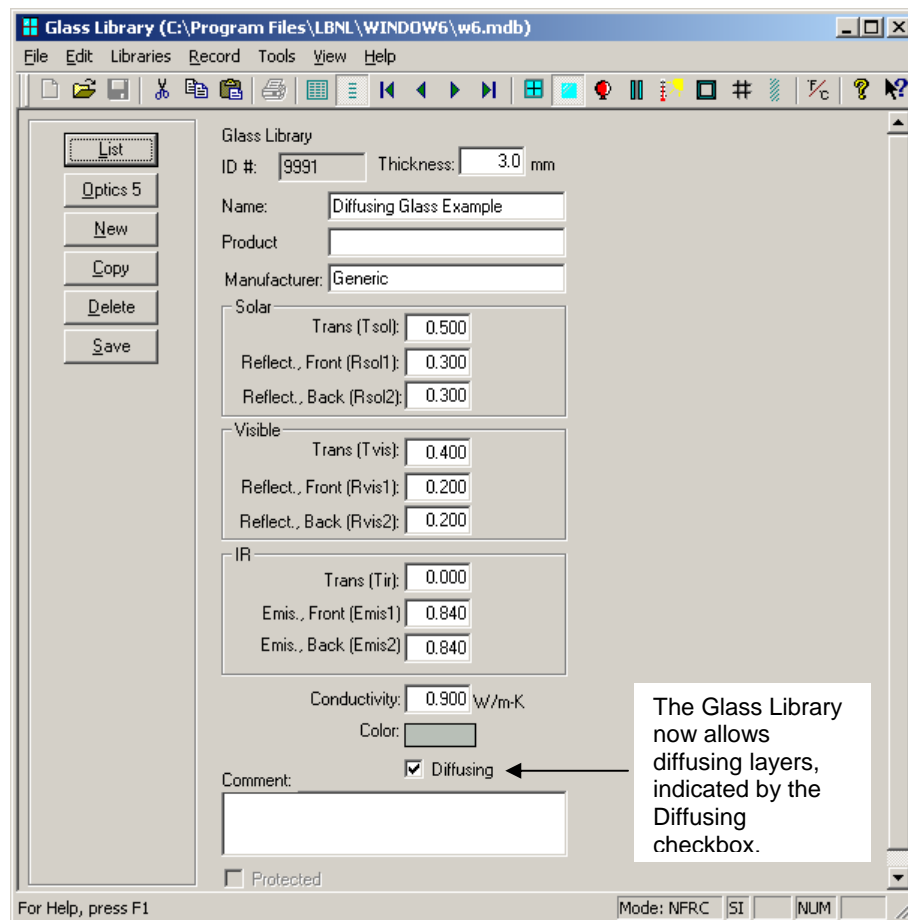

Figure 4-25. Glass Library Detailed View for Diffusing Layers.

4.5. Glazing System Library

The Glazing System Library is where the shading systems are added to the glazing system. There are three example glazing systems with venetian blinds (interior, integral to the IG, and exterior) all at 45°, as well as a glazing system examples for BSDF files and diffusing layers.

4.5.1. Glazing System Library List View

The Glazing System Library List View shows the records in the library.

ID	Name	# of Layers	Mode	Tilt	Environmental Conditions	Keff	Overall Thickness	Uval	SHGC	SC	Tvis	RHG	Tdw-ISO
						Btu/h-ft-F	inches	Btu/h-ft-F				Btu/h-ft2	
1	Single Clear	1	#	90	NFRC 100-2001	N/A	0.120	1.041	0.860	0.989	0.899	211.0	0.842
2	Double Clear Air	2	#	90	NFRC 100-2001	0.037	0.922	0.476	0.704	0.809	0.786	168.8	0.690
3	Double Low-e Air	2	#	90	NFRC 100-2001	0.017	0.850	0.292	0.470	0.540	0.696	111.8	0.548
4	Double Clear with Argon	2	#	90	NFRC 100-2001	0.035	0.740	0.454	0.764	0.878	0.814	182.3	0.738
5	Triple Clear	3	#	90	NFRC 100-2001	0.046	1.675	0.307	0.617	0.709	0.703	146.6	0.601
6	3mm Low-e air	2	#	90	NFRC 100-2001	0.030	1.000	0.314	0.500	0.574	0.721	117.9	0.549
7	3mm Clear	2	#	90	NFRC 100-2001	0.029	1.021	0.341	0.686	0.788	0.741	161.8	0.635
8	Sample GlzSys	2	#	90	NFRC 100-2001	0.029	1.021	0.341	0.686	0.788	0.741	161.8	0.635
9	Sample GlzSys - Interior Venetian A, 45 degrees	3	#	90	NFRC 100-2001	0.055	1.966	0.301	0.376	0.432	0.224	90.1	-1.000
10	Sample GlzSys - Integral Venetian A, 45 degrees	3	#	90	NFRC 100-2001	0.053	1.021	0.490	0.292	0.336	0.210	74.1	-1.000
11	Sample GlzSys - Exterior Venetian A, 45 degrees	3	#	90	NFRC 100-2001	0.049	1.966	0.253	0.196	0.225	0.193	48.5	-1.000
12	Sample GlzSys - WINDAT Venetian Spectral Data	3	#	90	NFRC 100-2001	0.055	1.966	0.282	0.140	0.161	0.112	36.0	-1.000
13	Sample GlzSys - BSDF Data	3	#	90	NFRC 100-2001	0.035	1.717	0.235	0.357	0.411	0.350	85.6	-1.000
14	Sample GlzSys - Diffusing Shade	3	#	90	NFRC 100-2001	0.038	1.336	0.295	0.314	0.361	0.279	76.7	-1.000
15	Clear - Diffusing Glass Layer	2	#	90	NFRC 100-2001	0.025	0.476	0.557	0.419	0.481	0.348	104.3	-1.000

Figure 4-26. The Glazing System Layer Library List View.

The buttons on the left hand side of the List View have the following functions:

- Detailed View* Goes to the detailed view of the record, where the input values can be edited.
- New* Used to make a new record, based on a default record.
- Copy* Used to copy an existing record (including name and all associated input values) into a new record.
- Delete* Used to delete the highlighted record(s).
- Find* Used to find a record based on the field selected from the pulldown list, and a value typed into the input box.
- Advanced* Used to access a more advanced method of searching the list
- Import* Used to import Glazing System Library records from another WINDOW 6 database.
- Export* Used to export Glazing System records to either another WINDOW 6 database, a comma separated "CSV" file, or a WINDOW 4.1 file. (Keep in mind that WINDOW 4.1 will not be able to interpret a file with a glazing system that has a shading device).
- Report* Used to create a report containing a summary of the records in the List View or in the Detailed View.
- Print* Used to print a report which contains a list of all the records in the library.

4.5.2. Glazing System Library Detailed View

The Glazing System now allows two different types of layers, which are accessed using the pulldown arrow to the left of the layer definition:

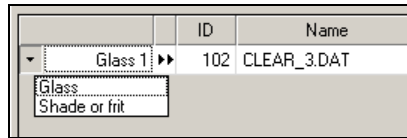

- **Glass:** when this option is selected, the double arrows to the right of the label will open a view into the Glass Library, where a glass layer can be selected.
- **Shade or Frit:** when this option is selected, the double arrows to the right of the label will open a view into the Shading Layer Library, where a shade layer can be selected.

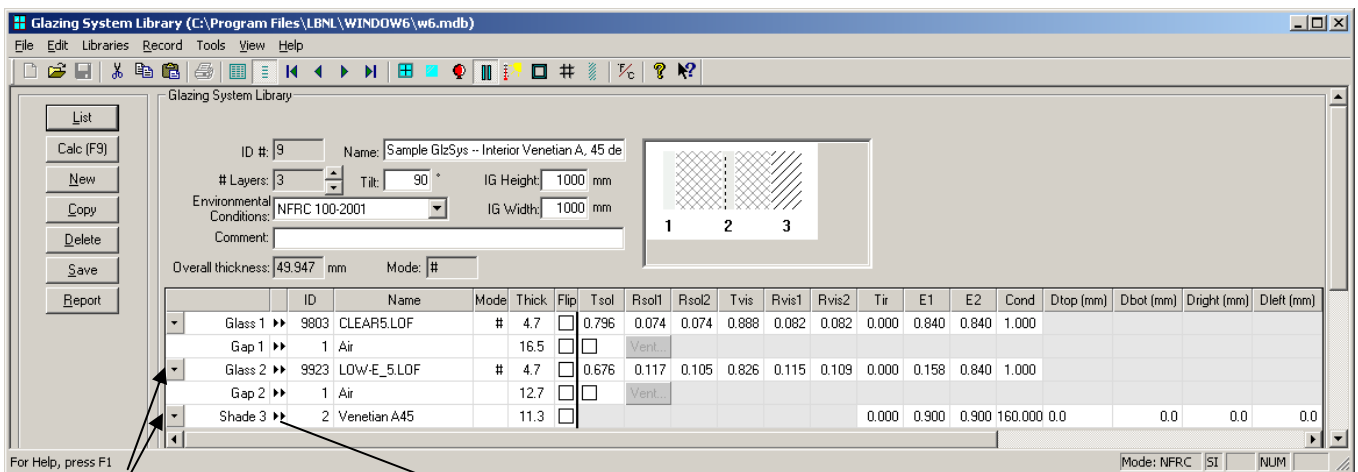

Specify either "Glass" or "Shade or Frit" for the layer type.

Click on double arrow to see the records in the Shading Layer Library

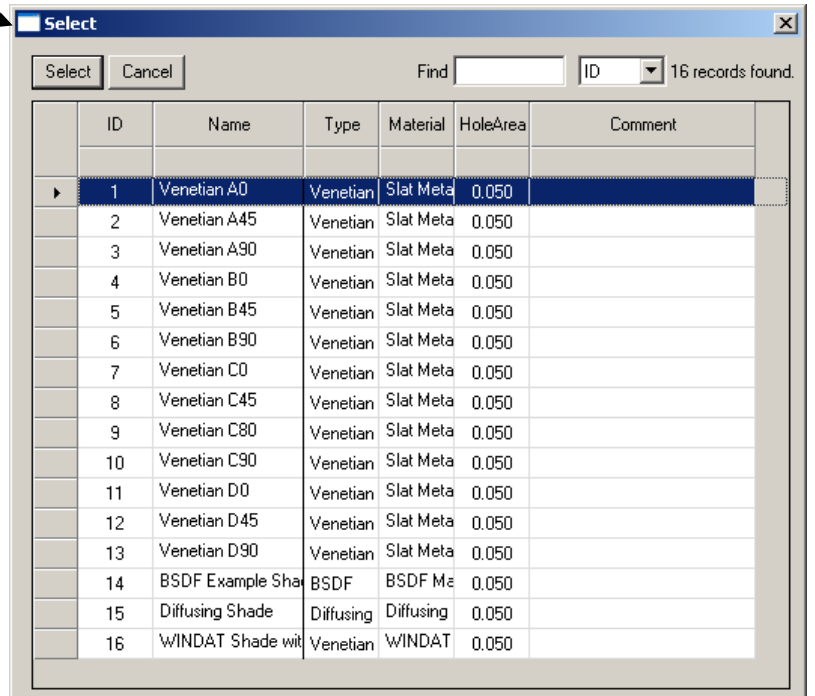
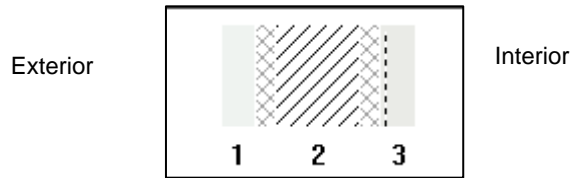

Figure 4-27. Specify the shading layer in the glazing system

Glazing System Outside to Inside Convention

The layers in the Glazing System Library are displayed from outside to inside, left to right. So Layer 1 is the layer next to the exterior boundary conditions during the calculation



Exterior layer

	ID	Name	Mode	Thick	Flip	Tsol	Rsol1	Rsol2	Tvis	Rvis1	Rvis2	Tir	E1	E2	Cond
▼ Glass 1 ▶▶	9803	CLEAR5.LOF	#	4.7	<input type="checkbox"/>	0.796	0.074	0.074	0.888	0.082	0.082	0.000	0.840	0.840	1.000
Gap 1 ▶▶	1	Air		2.6	<input type="checkbox"/>										
▼ Shade 2 ▶▶	2	Venetian.A45		11.3	<input type="checkbox"/>							0.000	0.900	0.900	160.000
Gap 2 ▶▶	1	Air		2.6	<input type="checkbox"/>										
▼ Glass 3 ▶▶	9923	LOW-E_5.LOF	#	4.7	<input type="checkbox"/>	0.676	0.117	0.105	0.826	0.115	0.109	0.000	0.158	0.840	1.000

Interior layer

4.5.2.1. Glazing System with Venetian Blind Shading System

Glazing systems can have shading systems in three positions with respect to the glass layers:

- **Interior shading system:** this is a shading system that is on the interior or “room” side of the glazing system
- **Integral shading system:** this is a shading layer that is between the glass layers in a glazing system, i.e., inside the IG
- **Exterior shading system:** this is a shading layer that is on the “exterior” side of the glazing system.

The following is a discussion of modeling venetian blinds in these three positions.

Interior Venetian Blind

An interior venetian blind is defined as being on the “room” or warm side of the glazing system. For this type of venetian blind, the following must be defined:

- **Slat Material Properties:** defined in the Shade Material Library
- **Slat geometry:** defined in the Shading Layer Library
- **Slat relationship to glazing system:** defined in the Glazing System Library. Input required is:
 - Distance from the interior glass layer to the venetian blind (Gap 2 in the diagram below)
 - Distance from the frame to the top (Dtop), bottom (Dbot), left (Dleft) and right (Dright) of the venetian blind. *These distances are NOT used to place the shading device in the THERM file.*

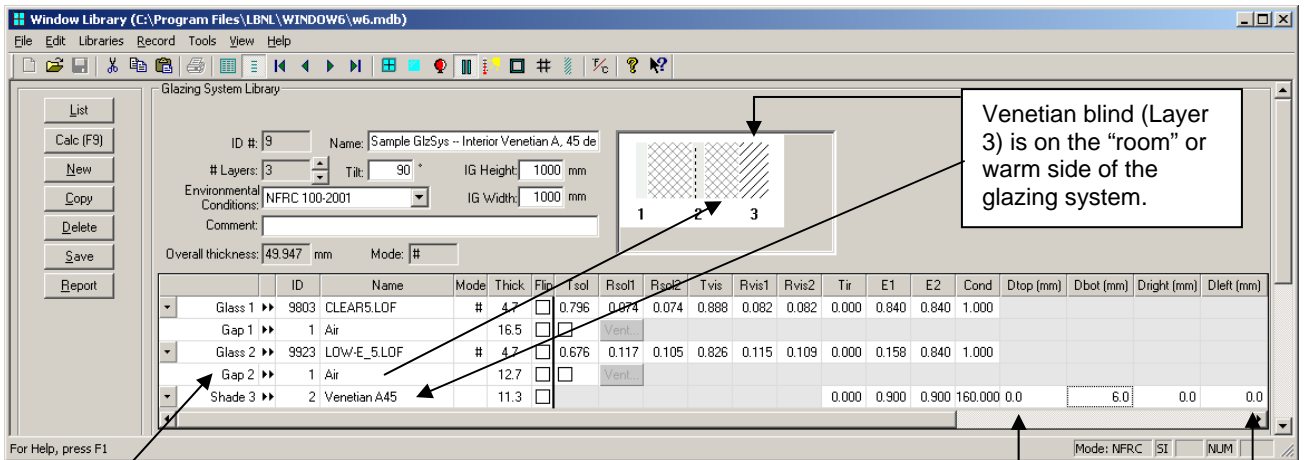

Gap 2 represents the distance from the interior glass layer (Layer 2) to the venetian blind (Layer 3).

Dtop, Dbot, Dright, Dleft define the venetian blind relative to the glazing area for interior and exterior venetian blinds.

Figure 4-28. Define a glazing system with an interior venetian blind.

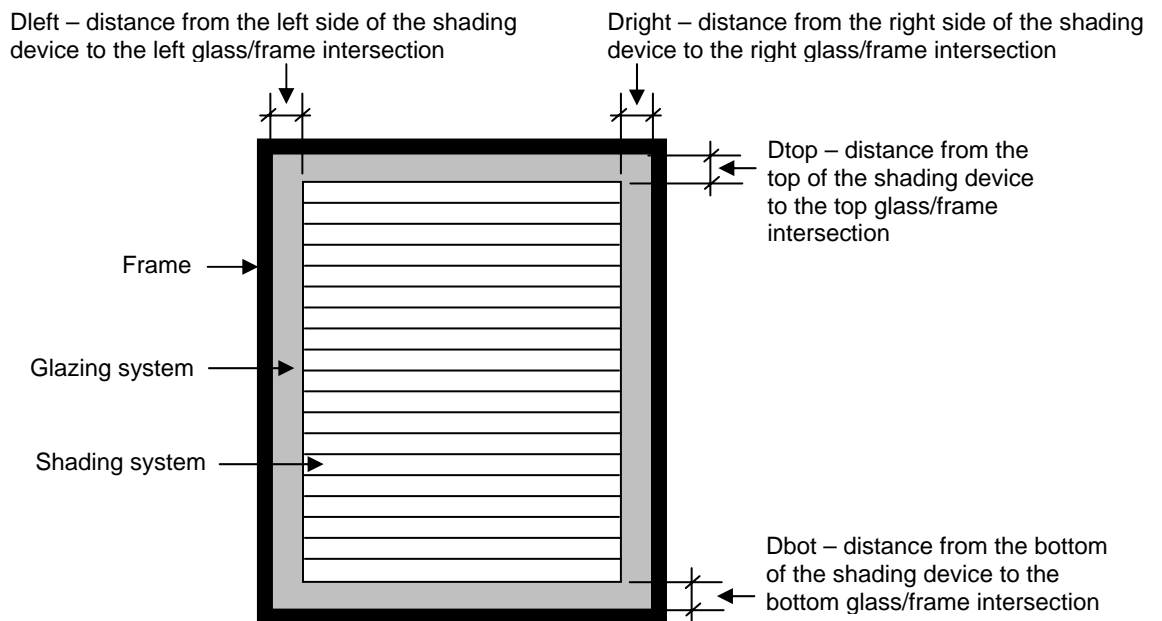
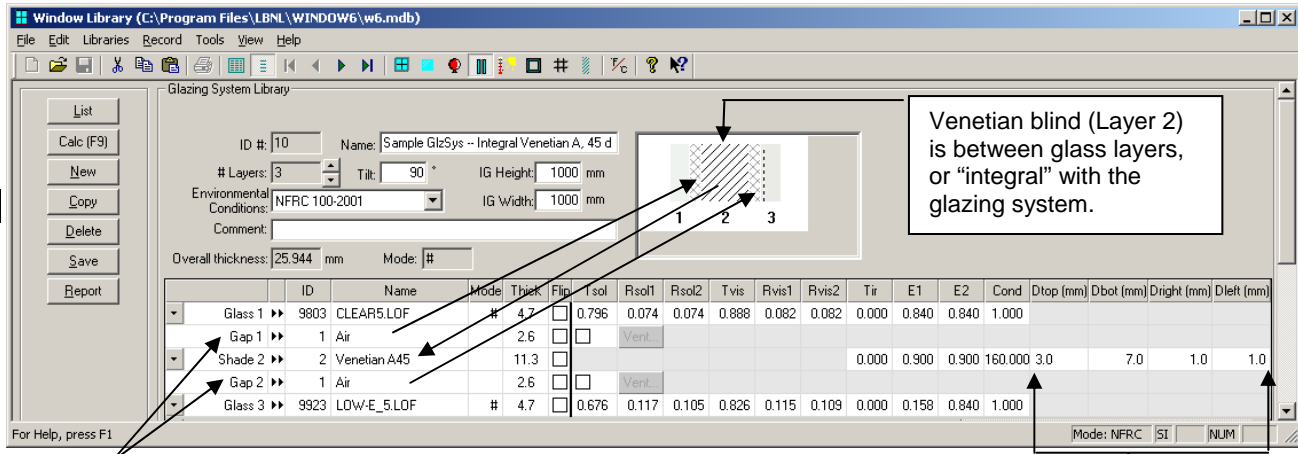

Figure 4-29. Define a Dtop, Dbot, Dleft and Dright for an interior venetian blind.

Integral Venetian Blind

An integral venetian blind is defined as being between two glass layers in a glazing system. For this type of venetian blind, the following must be defined:

- **Slat Material Properties:** defined in the Shade Material Library
- **Slat geometry:** defined in the Shading Layer Library
- **Slat relationship to glazing system:** defined in the Glazing System Library. Input required is:
 - Distance from the venetian blind to the interior surfaces of the enclosing glass layers
 - Distance from the *spacer* to the top (Dtop), bottom (Dbot), left (Dleft) and right (Dright) of the venetian blind. *These distances ARE used to place the shading device in the THERM file.*



Gaps 1 and 2 define the distance of the venetian blind from the interior surfaces of the enclosing glass layers.

Dtop, Dbot, Dright, Dleft define the venetian blind relative to the *spacer line* for integral venetian blinds.

Figure 4-30. Define a glazing system with an integral venetian blind

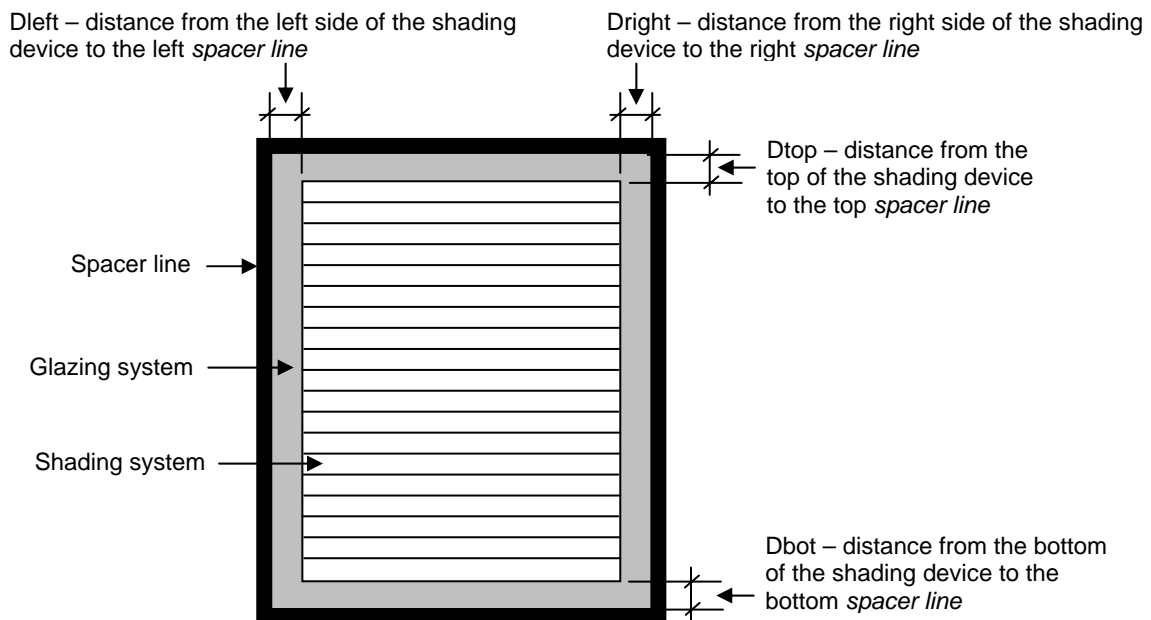
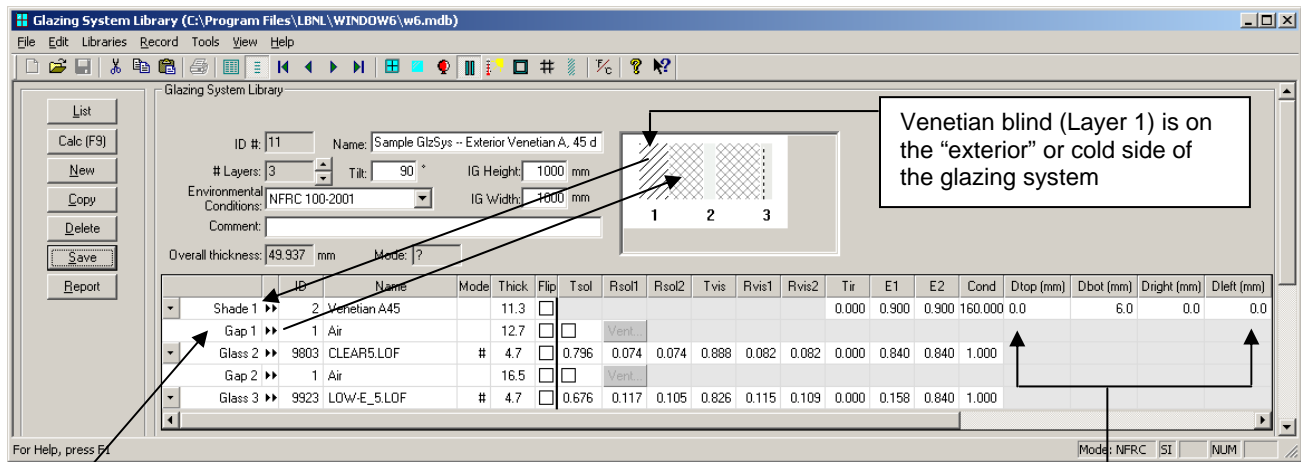

Figure 4-31. Define a glazing system with an integral venetian blind.

Exterior Venetian Blind

An exterior venetian blind is defined as being on the “exterior” or cold side of the glazing system. For this type of venetian blind, the following must be defined:

- **Slat Material Properties:** defined in the Shade Material Library
- **Slat geometry:** defined in the Shading Layer Library
- **Slat relationship to glazing system:** defined in the Glazing System Library. Input required is:
 - Distance from the exterior glass layer to the venetian blind (Gap 1 in the diagram below)
 - Distance from the frame to the top (Dtop), bottom (Dbot), left (Dleft) and right (Dright) of the venetian blind. *These distances are NOT used to place the shading device in the THERM file.*



Gap 1 represents the distance from the interior glass layer (Layer 2) to the venetian blind (Layer 3).

Dtop, Dbot, Dright, Dleft define the venetian blind relative to the glazing area for interior and exterior venetian blinds.

Figure 4-32. Define a glazing system with an exterior venetian blind

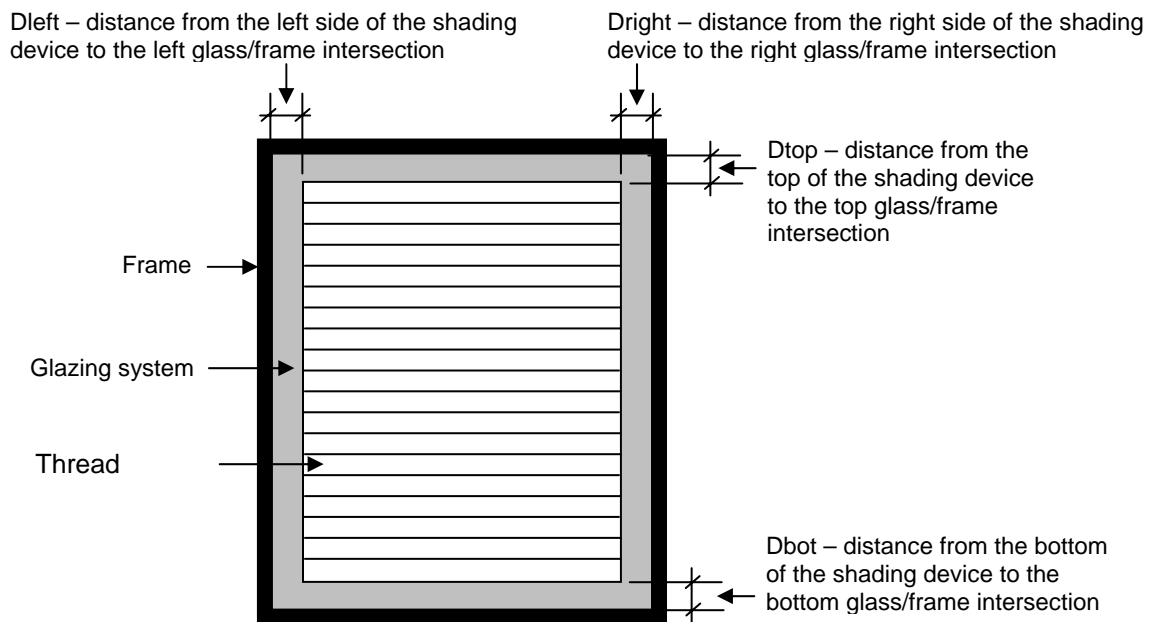

Figure 4-33. Define a Dtop, Dbot, Dleft and Dright defined for an exterior venetian blind.

4.5.2.2. Glazing System with Shading Layer that has Spectral Data for Shade Material (WINDAT Example)

If spectral data has been imported into the Shade Material Library and used in the Shading Layer Library, that shading layer can be used in a glazing system, and the spectral data will be included in the calculation. The example below shows the glazing system from the sample database (W6.mdb) which has a Shading Layer with spectral data defined as an exterior shading device (Layer 1). (However, this shading device could be used in any layer in the glazing system). Dtop, Dbot, Dright and Dleft are defined in the normal manner.

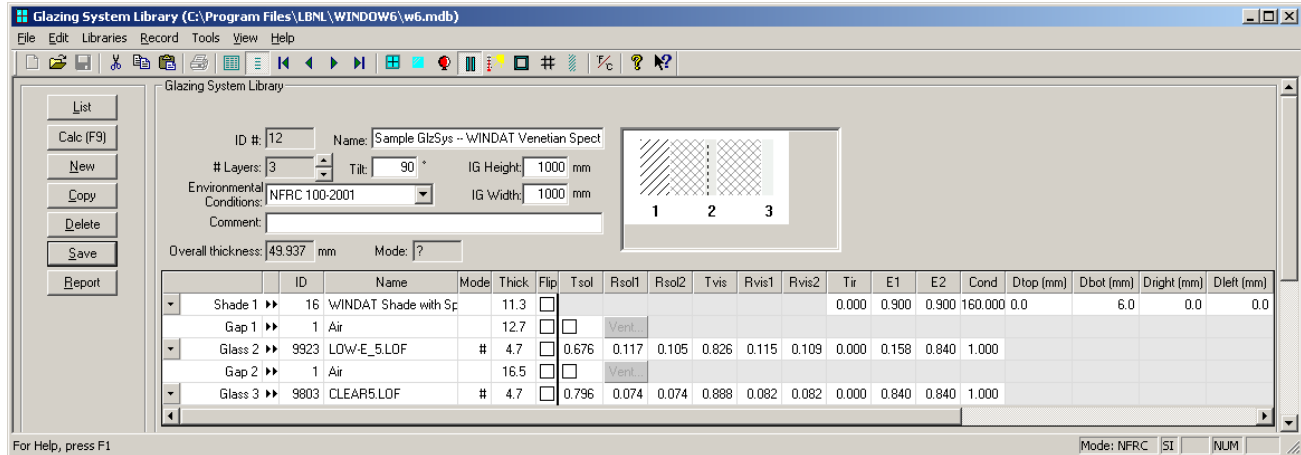

Figure 4-34. Define a glazing system with a shading layer that has spectral data

4.5.2.3. Glazing System with Shading Layer that has BSDF file reference

If a BSDF file has been used in the Shading Layer Library, that shading layer can be used in a glazing system, and the BSDF data will be used in the calculation. The example below shows the glazing system from the sample database (W6.mdb) which has a Shading Layer defined with BSDF data as an exterior shading device (Layer 1). (However, this shading device could be used in any layer in the glazing system). Dtop, Dbot, Dright and Dleft are defined in the normal manner.

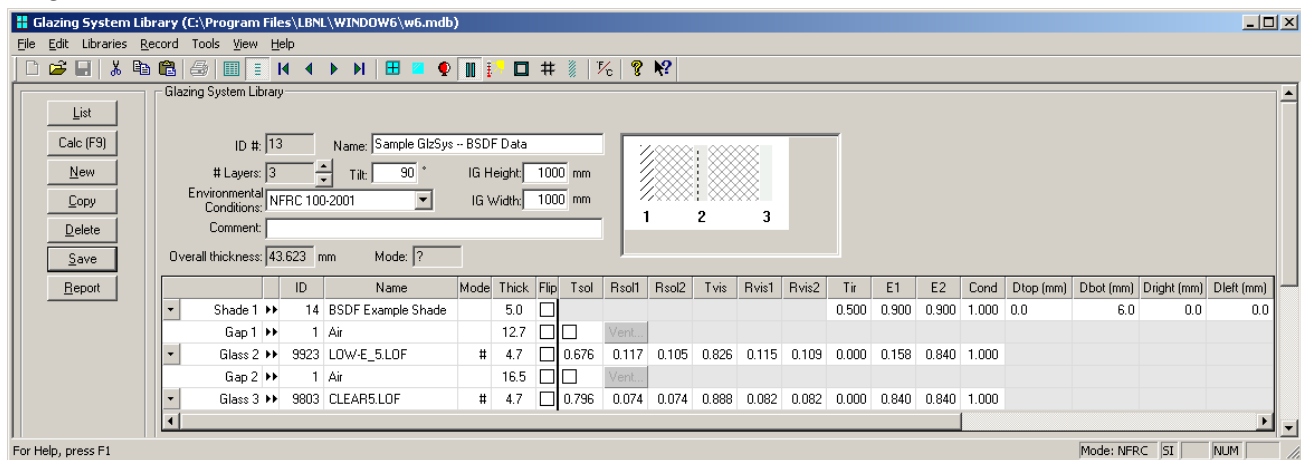

Figure 4-35. Define a glazing system with a shading layer that has a BSDF file reference.

4.5.2.4. Glazing System with Diffusing Shade Layer

If a diffusing shade material has been defined in the Shade Material Library and used in the Shading Layer Library, that diffuse shading layer can be used in a glazing system. The example below shows the glazing system from the sample database (W6.mdb) which has a diffusing shading layer used as an exterior shading device (Layer 1). (However, this shading device could be used in any layer in the glazing system). Dtop, Dbot, Dright and Dleft are defined in the normal manner.

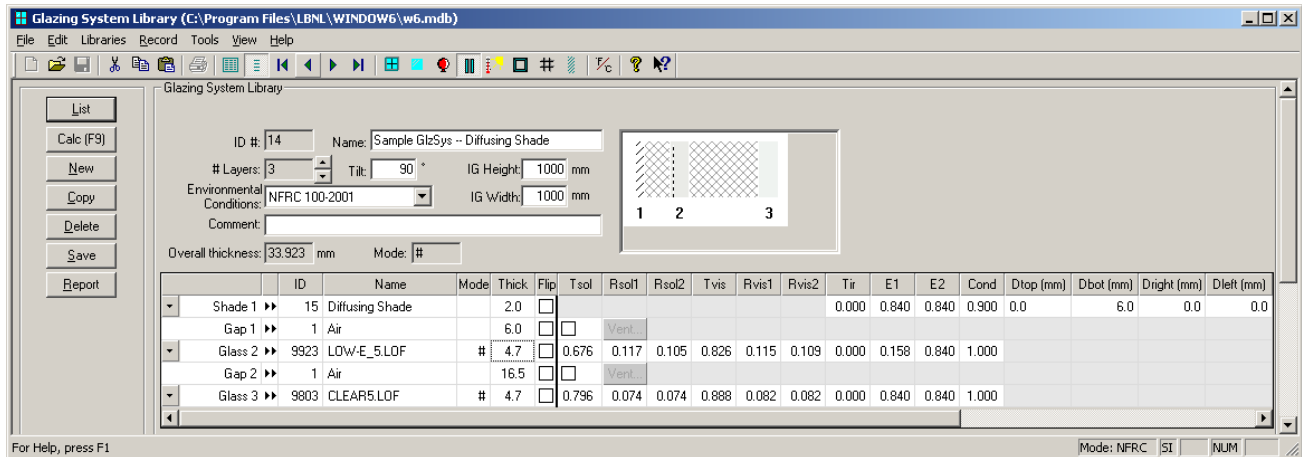

Figure 4-36. Define a glazing system with a shading layer that has a diffusing material

4.5.2.5. Glazing System with Diffusing Layer from the Glass Library

A glass layer that has been defined as “diffusing” in the Glass Library can be used as a layer in the glazing system. The example below shows the glazing system from the sample database (W6.mdb) which has a diffusing glass layer used on the exterior (Layer 1) of a two layer glazing system. (However, this glass layer could be used as any layer in the glazing system). Dtop, Dbot, Dright and Dleft are not defined in this case, because the layer is defined as a glass layer.

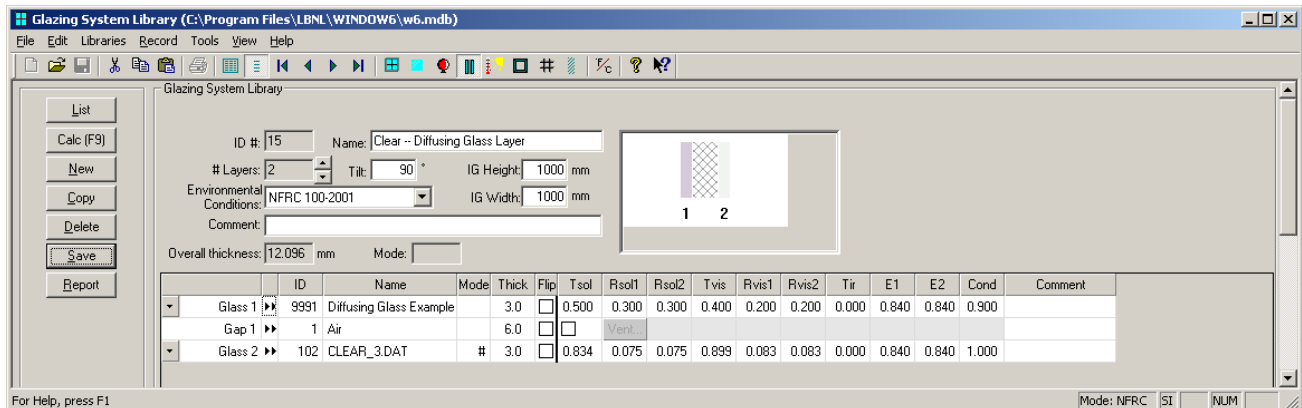

Figure 4-37. Define a glazing system with a diffusing layer from the Glass Library

4.5.2.6. Glazing System with Woven Shade Layer

To define a woven shade, the following must be defined:

- **Thread Material Properties:** defined in the Shade Material Library
- **Woven fabric geometry:** defined in the Shading Layer Library
- **Shade relationship to glazing system:** defined in the Glazing System Library. Input required is:
 - Distance from the glass layer to the woven shade

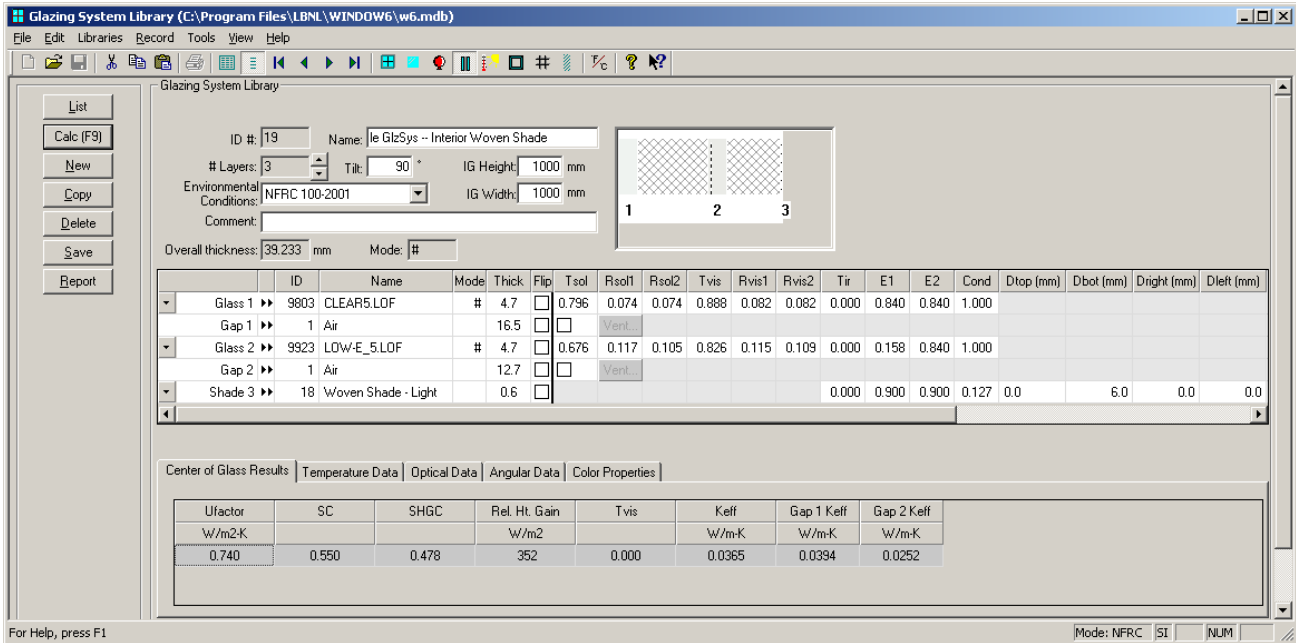

Figure 4-38. Define a glazing system with a diffusing layer from the Glass Library

4.5.2.7. Glazing System with Fritted Glass Layer

An interior venetian blind is defined as being on the “room” or warm side of the glazing system. For this type of venetian blind, the following must be defined:

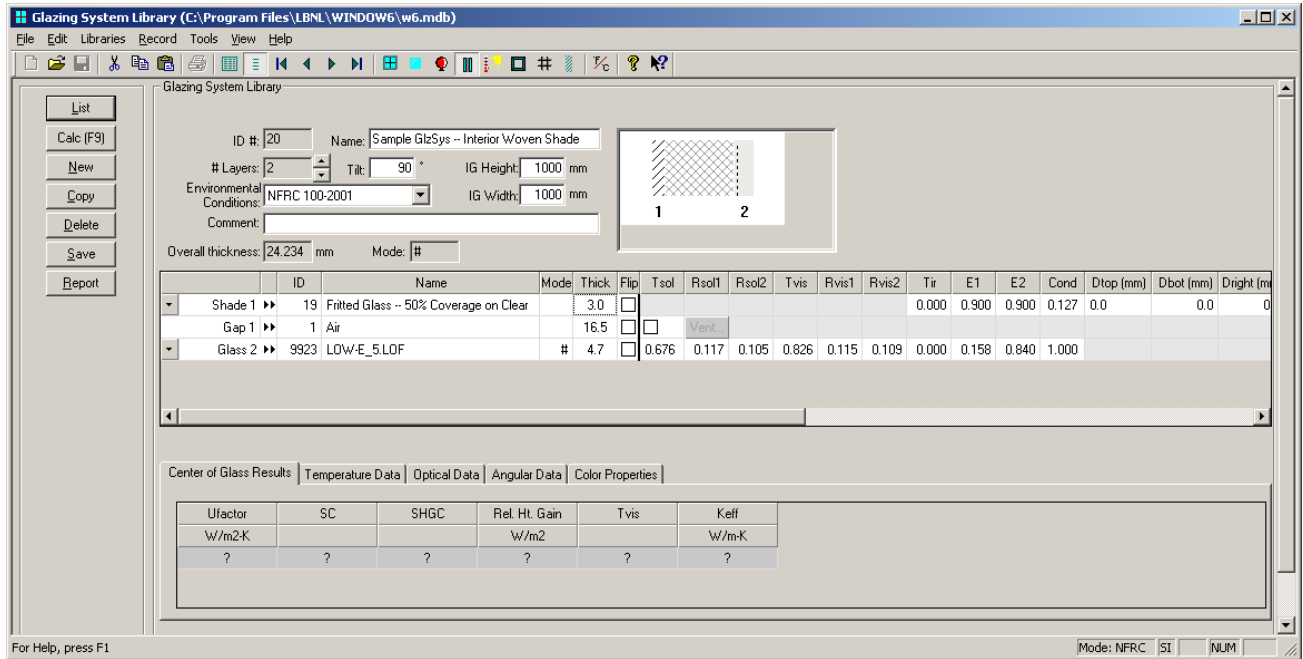

Figure 4-39. Define a glazing system with a diffusing layer from the Glass Library

4.6. Calculation Results

WINDOW 6 produces two different sets of results for the glazing system (not the whole window):

- **Results calculated at normal incidence:** these are the results displayed in the Glazing System Library results section (see the discussion below in Section 4.6.1)
- **Results calculated for many incoming and outgoing angles:** these are the results displayed in the Matrix Reader (see the discussion below in Section 4.6.2)

4.6.1. Glazing System Results

For a glazing system with a shading device, the optical properties of complex glazing systems are calculated at normal incidence for the incoming angle (horizontal to the glazing system) and hemispherically integrated on the outgoing side. This is what is displayed in the “Center of Glass Results” tab in the lower section of the **Glazing System Library** for SC, SHGC, Tvis as well as the results in the **Optical Data** tab in that same section. The thermal results (U-value) are calculated using the ISO 15099 method for shading systems, Section 7.4.2.2.

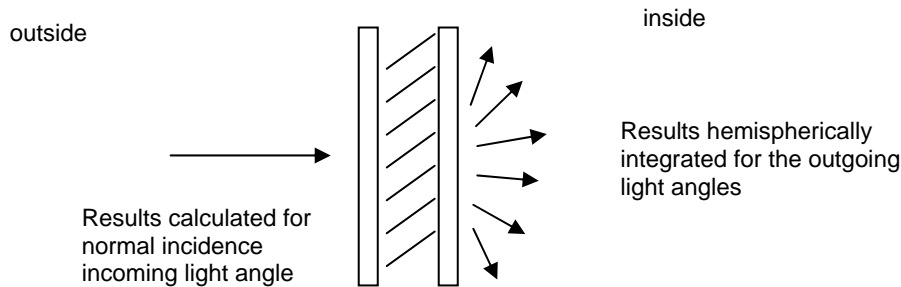

Figure 4-40. The results in the Glazing System Library are calculated at normal incidence for incoming light and hemispherically integrated for the outgoing light angles.

The **Temperature Data** and **Optical Data** tabs have results, but at this time the **Angular Data** and **Color Properties** tags to not have results.

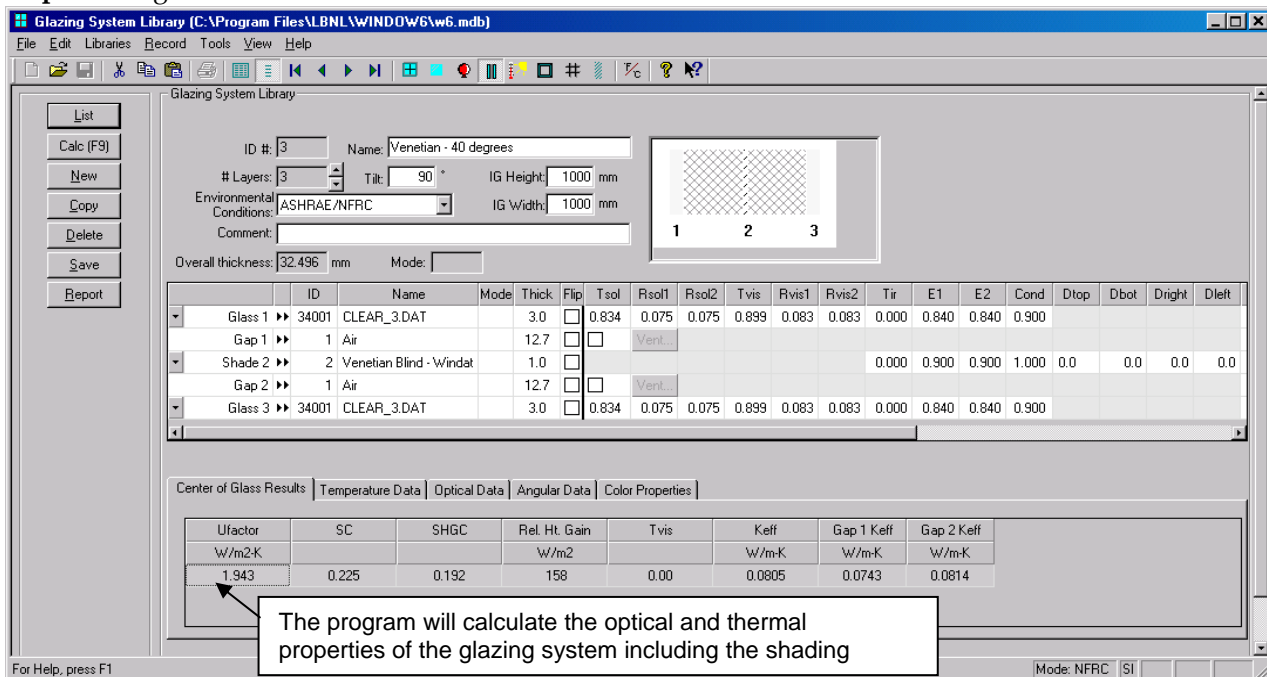

Figure 4-41. The program will display glazing system results including the shading system.

4.6.2. Matrix Calculation Results

If the “Generate full spectrally-averaged matrix for Solar Band and Visible Band” checkboxes are checked in Preferences, WINDOW 6 will generate results for glazing systems with shading devices that include results at all the incoming and outgoing angles defined in the basis.

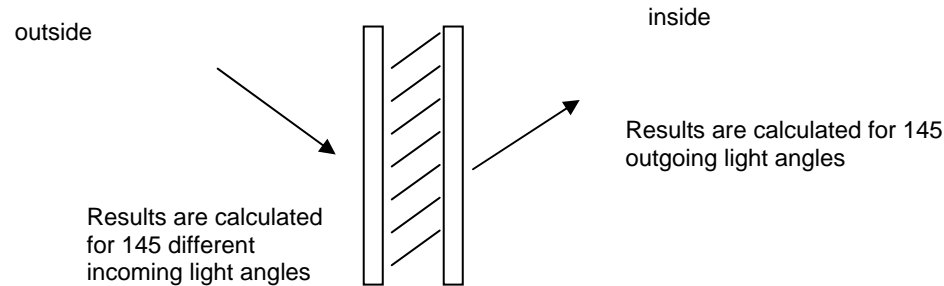

Figure 4-42. The full set of results that WINDOW 6 can calculate are for 145 incoming angles which result in values for 145 outgoing angles. This complete set of results (21,015 values) can be read by the MatrixReader spreadsheet for viewing.

The files containing these results are CSV (comma separated value) text file and are created for every calculated glazing system, and have the name of the glazing system with a CSV extension. The files are located in the program working directory (the default directory being C:\Program Files\LBNL\WINDOW6). The contents of these files can be displayed in the “MatrixReader.xls” spreadsheet provided with the program (and explained in detail later in this section).

To view the detailed angular results in the CSV files, do the following:

- Open the W6MatrixReader.xls spreadsheet with the Microsoft Excel program
- Click on the Load Matrix button, open the file with the desired glazing system name (such as “Venetian - 90 degrees.csv”)

The data will be displayed as shown below.

The results shown below are from a glazing system constructed of a double glazed IG (clear 3 mm glass) with a Venetian blind between the panes, with the blind slat tilt set to 40 degrees.

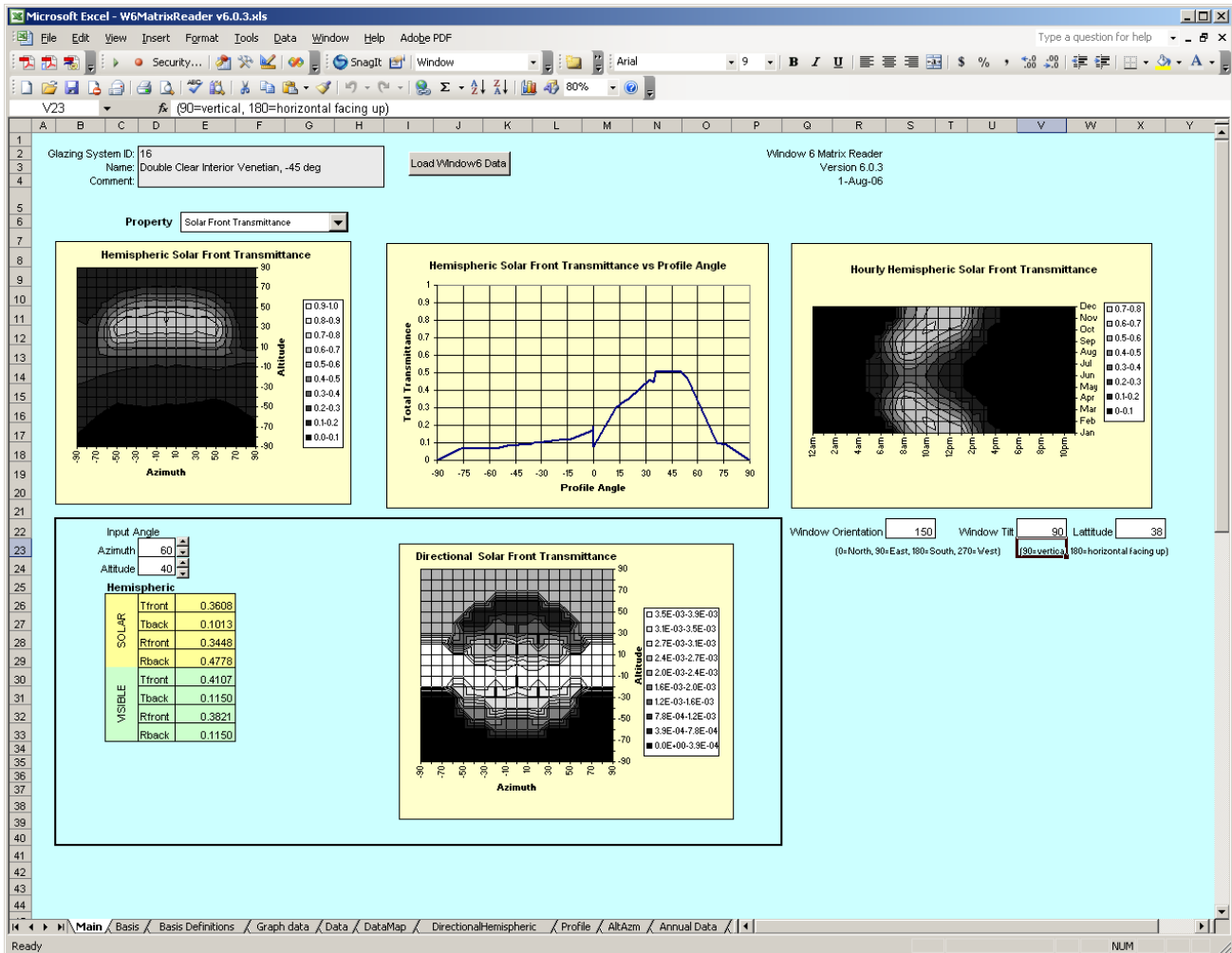

Figure 4-43. The results displayed by the W6MatrixReader.xls file.

Each section of the results spreadsheet is explained in the following section.

4.6.3. Tabular Results

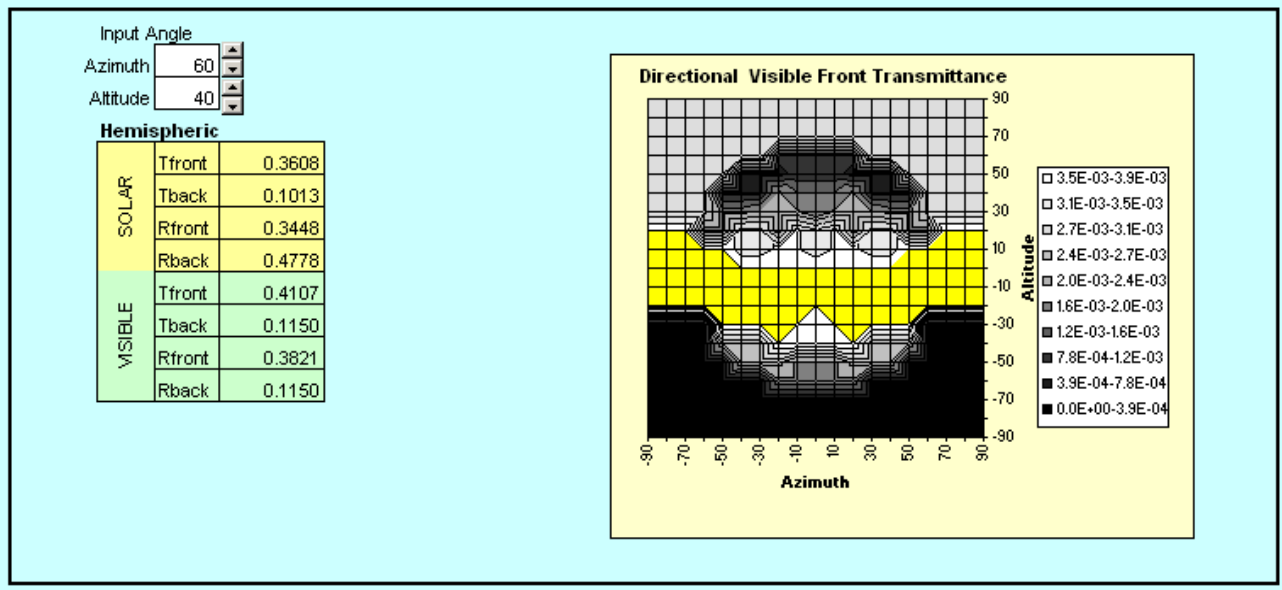

Figure 4-44. The tabular results from the complex glazing calculation.

The combination of Azimuth and Altitude represents an angle of a ray of light relative to the glazing system.

The pull-down list listing the front and back transmittance and reflectance for solar and visible wavelengths controls the display of the “polar” graphs. “Front” represents what is being reflected or transmitted into the room. “Back” represents what is being reflected or transmitted on the outside. (Back transmittance is not a very useful piece of data).

Hemispheric

This represents the all the solar radiation, both direct and diffuse, that is either reflected or transmitted for the front and the back of the glazing system.

4.6.4. Hemispheric Visible Front Transmittance

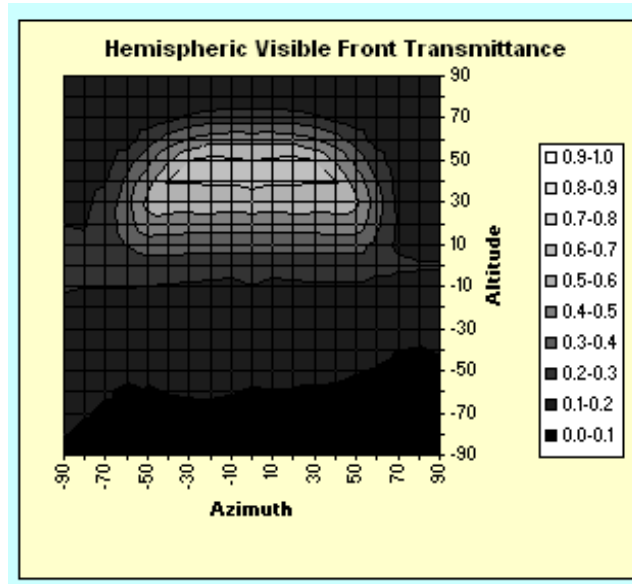

Figure 4-45. The visible front transmittance results from the complex glazing calculation.

4.6.5. Solar Front Transmittance vs Profile Angle

The spreadsheet translates the incoming thetas and phis into profile angles, and this graph plots hemispheric transmittance or reflectance for front or back, against the profile angle.

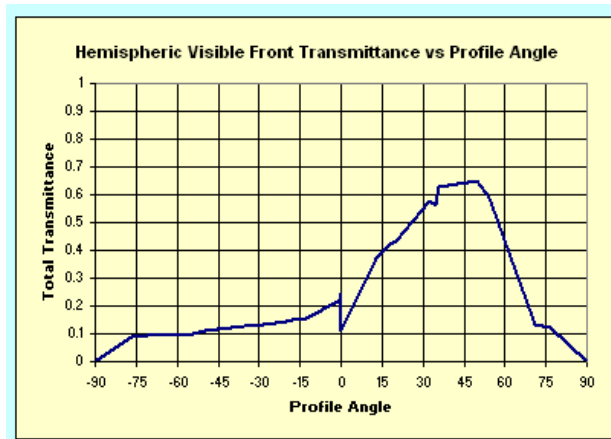

Figure 4-46. The solar front transmittance plotted against the profile angle of the system from the complex glazing calculation.

4.6.6. Hourly Hemispheric Visible Front Transmittance

The spreadsheet calculates a combination of altitude and azimuth values for each hour of the day and day of the year for the sun position of a given latitude (in this case Latitude of 38 degrees), against hemispheric transmittance or reflectance for front or back.

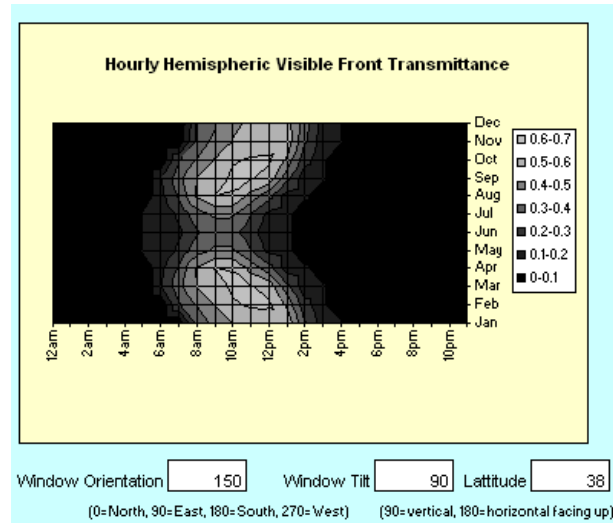

Figure 4-47. The hourly solar front transmittance for each hour of the day over each month of the year.

4.7. Whole Window Results

THERM 6 can read WINDOW 6 glazing systems that contain shading devices, and model them appropriately (see the next section of this manual for a detailed description of THERM 6). When these THERM 6 files with shading devices have been calculated, they can be imported into the THERM 6 Frame library, and then a whole window can be constructed using the glazing system associated with the THERM 6 files, in the normal fashion.

ID	Name	Source	Type	Frame Uvalue W/m2-K	Edge Uvalue W/m2-K	Edge Correlation	Glazing Thickness mm	Pfd mm	Abs	Color
1	Al w/break	ASHRAE	N/A	5.680	N/A	Class1	N/A	57.2	0.90	Blue
2	Al flush	ASHRAE	N/A	3.970	N/A	Class1	N/A	57.2	0.90	Light Blue
3	Wood	ASHRAE	N/A	2.270	N/A	Class1	N/A	69.8	0.90	Dark Blue
4	Vinyl	ASHRAE	N/A	1.700	N/A	Class1	N/A	69.8	0.90	Red
5	sample-sill.THM	Therm	Sill	2.019	2.452	N/A	25.9	42.9	0.50	Teal
6	sample-jamb.THM	Therm	Sill	2.018	2.452	N/A	25.9	42.9	0.50	Teal
7	sample-head.THM	Therm	Sill	2.257	3.000	N/A	25.9	42.9	0.50	Teal
8	sample-head-Interior/VentianA-45.THM	Therm	Head	2.081	2.085	N/A	25.9	42.9	0.30	Teal
9	sample-jamb-Interior/VentianA-45.THM	Therm	Sill	2.075	2.081	N/A	25.9	42.9	0.30	Teal
10	sample-sill-Interior/VentianA-45.THM	Therm	Sill	2.076	2.081	N/A	25.9	42.9	0.30	Teal
11	sample-head-Integral/VentianA-45.THM	Therm	Sill	2.036	2.867	N/A	25.9	42.9	0.30	Teal
12	sample-jamb-Integral/VentianA-45.THM	Therm	Sill	2.049	2.871	N/A	25.9	42.9	0.30	Teal
13	sample-sill-Integral/VentianA-45.THM	Therm	Sill	2.049	2.871	N/A	25.9	42.9	0.30	Teal
14	sample-head-exterior/VentianA-45.THM	Therm	Sill	2.021	2.242	N/A	25.9	42.9	0.30	Teal
15	sample-jamb-Exterior/VentianA-45.THM	Therm	Sill	2.014	2.238	N/A	25.9	42.9	0.30	Teal
16	sample-sill-Exterior/VentianA-45.THM	Therm	Sill	2.015	2.238	N/A	25.9	42.9	0.30	Teal

Window Library (C:\Program Files\LBNL\WINDOW6\w6.mdb)

ID # 3
 Name: Sample Venetian A 45 In
 Mode: NFRC
 Type: Picture (fixed), NFI >>
 Width: 1200 mm
 Height: 1500 mm
 Area: 1.800 m2
 Tilt: 90
 Environmental Conditions: NFRC 100-2001

Total Window Results:
 U-factor: 2.677 W/m2-K
 SHGC: 0.297
 VT: 0.186
 CR: 47

Frame:
 Name: sample-sill-Integral/VentianA-45.TH >>
 ID: 13 Uedge: 2.871 W/m2-K
 Source: 2 Edge area: 0.067 m2
 Ufactor: 2.049 W/m2-K PFD: 42.9
 Area: 0.050 m2 Abs: 0.300

THERM 6 files modeled with glazing systems defined with shading devices are imported into the WINDOW 6 Frame Library

In the Window Library, reference the glazing system with the shading device

In the Window Library, reference the THERM files from the Frame Library that were modeled with the shading device.

Figure 4-48. The hourly visible back transmittance for each hour of the day over each month of the year.

5. THERM 6 Detailed Description

This section documents in detail each section of the program that has changed from the THERM 5 version. Refer to the THERM 5 documentation for details of program features that have not changed.

5.1. WINDOW 6 Databases with Shading Devices

THERM 6 can read WINDOW 6 databases and interpret the glazing systems that have shading devices. The program will import the shading device and draw a rectangle to represent the shading device.

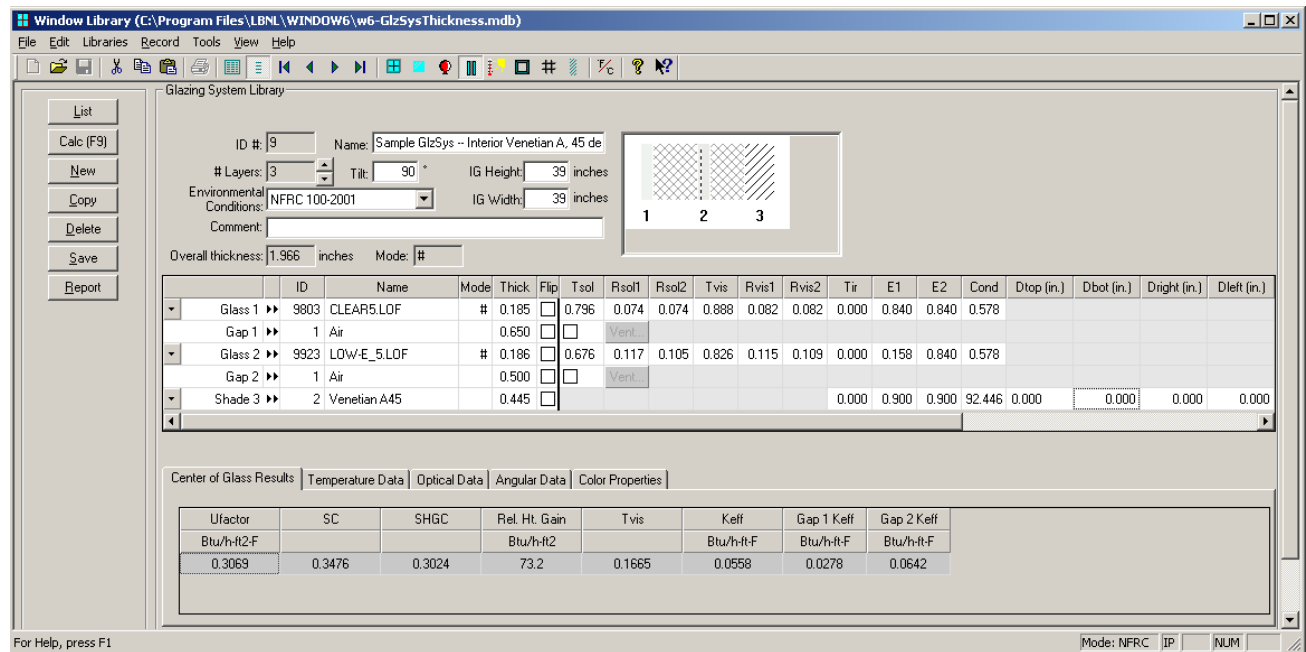

Figure 5-1. A WINDOW 6 glazing system defined with an interior shading system, in this case a venetian blind.

Shading devices are modeled in THERM 6 in slightly different ways, depending on the type of shading devices:

- Exterior and Interior Shading Devices:** The shading systems are displayed in the program as a layer associated with the glazing system, located in the proper position relative to the glazing system and the frame, and of the correct thickness. However, the layer is not editable and not actually modeled as a layer. The thermal impact of the shading systems are modeled by applying a “shading system modifier” (derived automatically from the WINDOW 6 glazing system results) to the boundary condition of the boundaries next to the shading devices.
- Integral Shading Devices:** these are modeled as an additional “layer” with some algorithm modifications.

THERM displays the shading devices associated with the imported glazing systems as shown below. The hatched rectangles representing the exterior and interior shading devices are for reference, and cannot be edited.

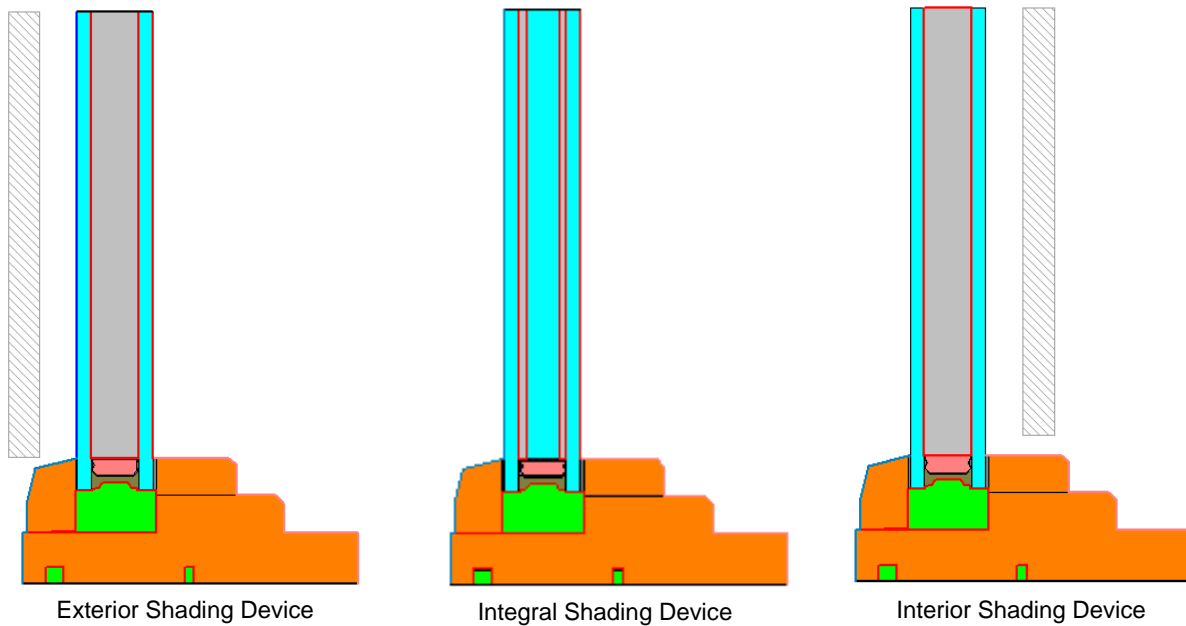

Figure 5-2. Three types of shading systems imported with the WINDOW 6 glazing system into THERM: exterior shade, integral shade (between glass layers), and interior shade.

5.2. Importing WINDOW 6 Glazing Systems with Interior or Exterior Shading Devices

Importing WINDOW 6 glazing systems into THERM 6 differs slightly for each type of shading device, interior, exterior and integral. Interior and exterior are similar to each other in their modeling procedure, and integral (a shading device between glass layers) is quite different. The following section describes each in detail.

After a shading device has been defined in the WINDOW 6 glazing system, it can be imported into THERM 6. This procedure is identical to importing a glazing system without a shading device.

5.2.1. Insert the Glazing System

The steps are briefly listed below, and described in detail in the sections for each shading device type:

- Draw the frame elements
- Go to the **Libraries** menu and select **Glazing Systems**
- From the Glazing Systems dialog box, select the desired WINDOW 6 database and the Glazing System from that database
- Set the appropriate values in the Insert Glazing System dialog box

The screenshot shows the 'Insert Glazing System' dialog box with the following fields and options:

- Orientation: Up
- Cross Section Type: Sill
- CR cavity height: 39.3701 inches
- Site line to bottom of glass: 0.4375 inches
- Spacer height: 0.4375 inches
- Edge of Glass Dimension: 2.5 inches
- Glazing system height: 6 inches
- Site line to interior shade edge: 0 inches
- Site line to exterior shade edge: 0.25 inches
- Use nominal glass thickness
- Use CR Model for Window Glazing Systems
- Gap Properties:
 - Default (selected) / Custom
 - Gap: 1
 - Keff: 0.02660 Btu/h-ft-F
 - Width: 0.65 inches
- Spacer:
 - Draw spacer
 - Single spacer for multiple glazings
 - Material: [dropdown]
- Boundary Conditions:
 - Use U-factor values (selected) / Use SHGC values
 - Exterior Boundary Condition: Use convection plus blackbody radiation
 - Interior Boundary Condition: Use convection plus enclosure radiation
 - Interior (20 tilt) Aluminum Frame (convection only)

A callout box points to the 'Site line to interior shade edge' and 'Site line to exterior shade edge' fields, stating: 'Two new fields: Site line to interior shade edge, Site line to exterior shade edge'.

Figure 5-3. Input the correct values into the Insert Glazing System dialog box.

There are two new fields in the **Insert Glazing System** dialog box for shading devices:

- **Site line to interior shade edge:** Input this value if the shading device is on the room side of the glazing system. This value is input on this screen, and NOT taken from the WINDOW 6 shading device input of Dbot or Dtop. This value can be negative if the edge of the shading device is below the sight line.
- **Site line to exterior shade edge:** Input this value if the shading device is on the outside (exterior) of the glazing system. This value is input on this screen, and NOT taken from the WINDOW 6 shading device input of Dbot or Dtop. This value can be negative if the edge of the shading device is below the sight line.

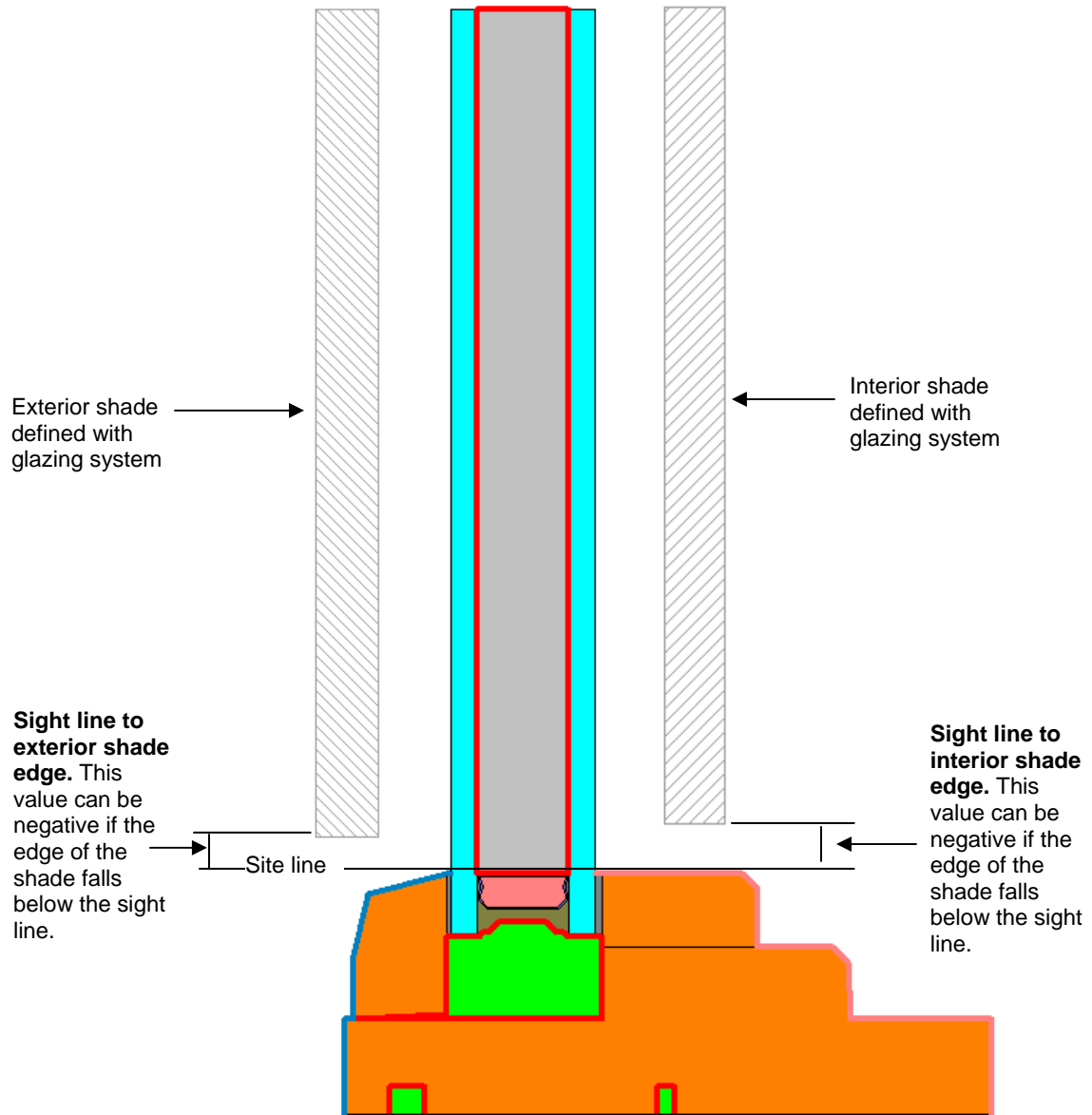

Figure 5-4. Input the distance from the sight line to the edge of the shading device for either an interior or exterior shading device.

- The glazing system will be imported and the shading device displayed as a hatched rectangle.

5.2.2. Define the Boundary Conditions

The boundary conditions for interior and exterior shading systems require applying a “shading system modifier” to the boundary segments that are next to a shading system. These modifiers come into THERM 6 automatically when the glazing system is imported, so most of the time the program should automatically apply these to the glazing system. The only time it is necessary to change the defaults is if the shading system is above or below the sight line of the frame. For those cases, the boundary segments must be broken into sections that are next to the shading system and those that are not, for a given boundary condition type.

This is explained in detail below for an exterior shading system, but the same principles would apply to an interior shading system.

- When the glazing system has been inserted and the frame is complete, generate the boundary conditions in the normal fashion.
- The **Boundary Condition Type** dialog box has a new input value “Shading system modifier” which will have choices for glazing systems that have shading systems associated with them, with the glazing system ID, as well as a “None” choice for boundary conditions without shading systems next to them.
- If the **Dbot**, **Dtop**, **Drigh** and **Dleft** values are zero, then the default boundary conditions assigned by THERM 6 for the glazing system will be correct

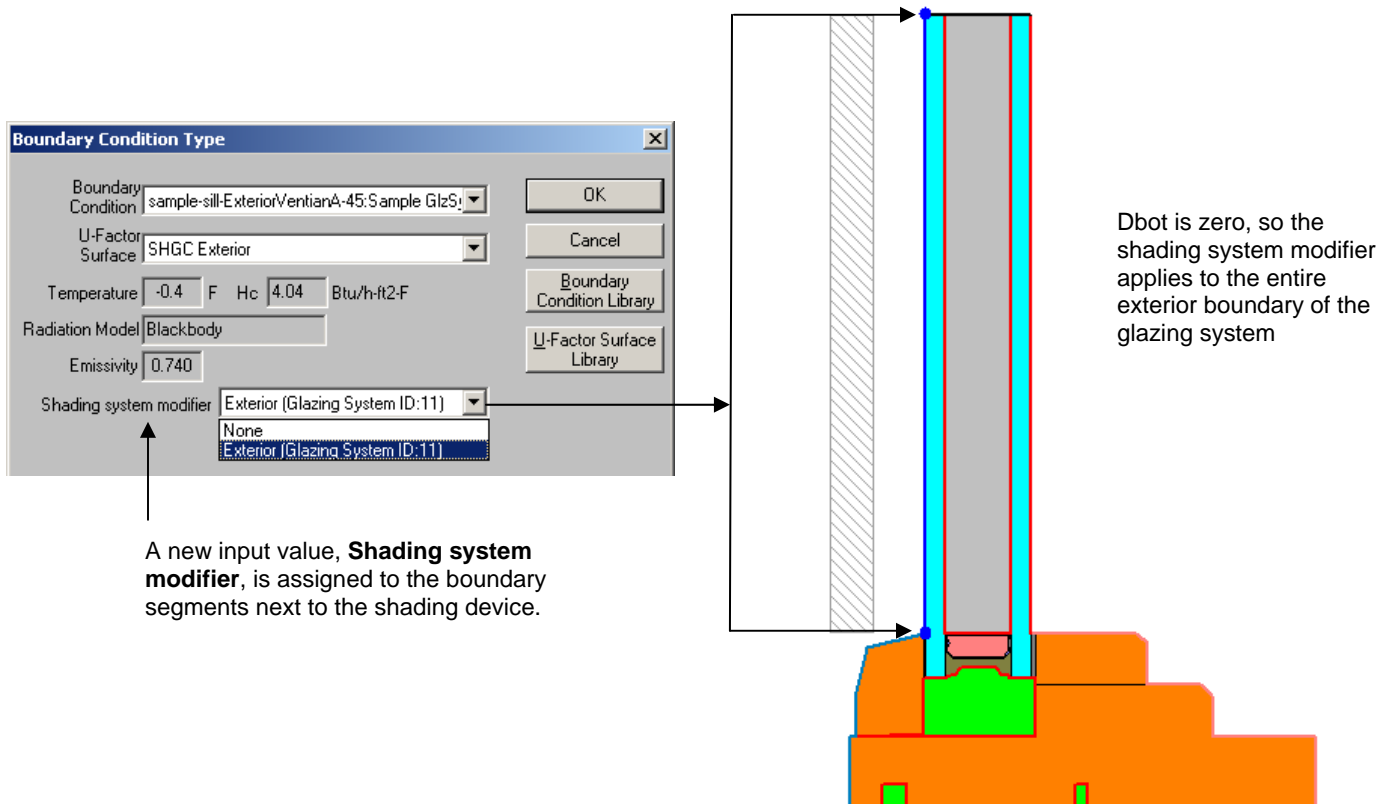

Figure 5-5. Assign the shading modifier to the boundary segments next to the shading device.

- If the **Dbot**, **Dtop**, **Drigh** and **Dleft** values are not zero (they can be positive or negative), then the boundary segments next to the shading device must be broken into multiple segments at the point where the projection of the shading device would intersect the boundary segment. Then different **Shading system modifier** values can be assigned to each segment.

- In the figure below, the exterior shading device edge is above the sight line, so some of the glazing system should have a boundary condition with the **Shading system modifier** set to “None”. Therefore, it is necessary to insert a point on the outer glass layer surface before assigning the boundary conditions. To do this, first go to **Options/Preferences, Drawing Options** tab, and check the “Allow Editing of IG polygons”.
- Click on the exterior glass layer and insert a point 6 mm up from the sight line.

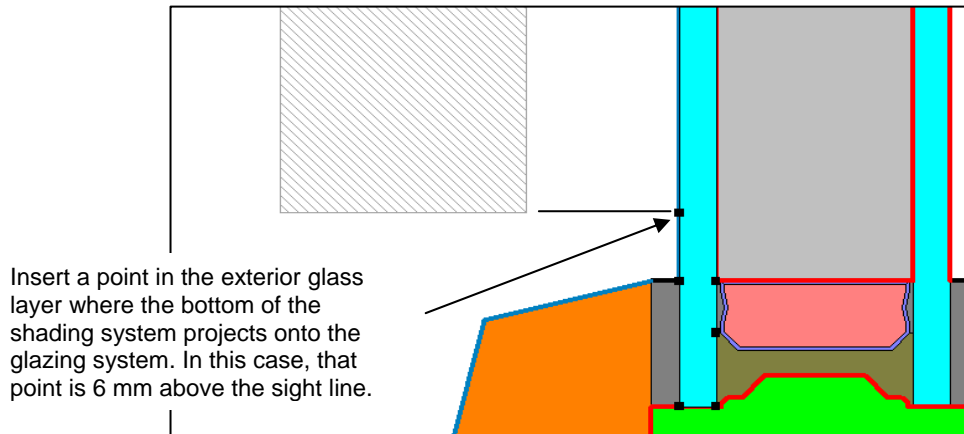

Figure 5-6. Insert a point in the glass layer where the bottom of the venetian blind intersects the glass.

Then generate the boundary conditions and assign the **Shading system modifiers** appropriately.

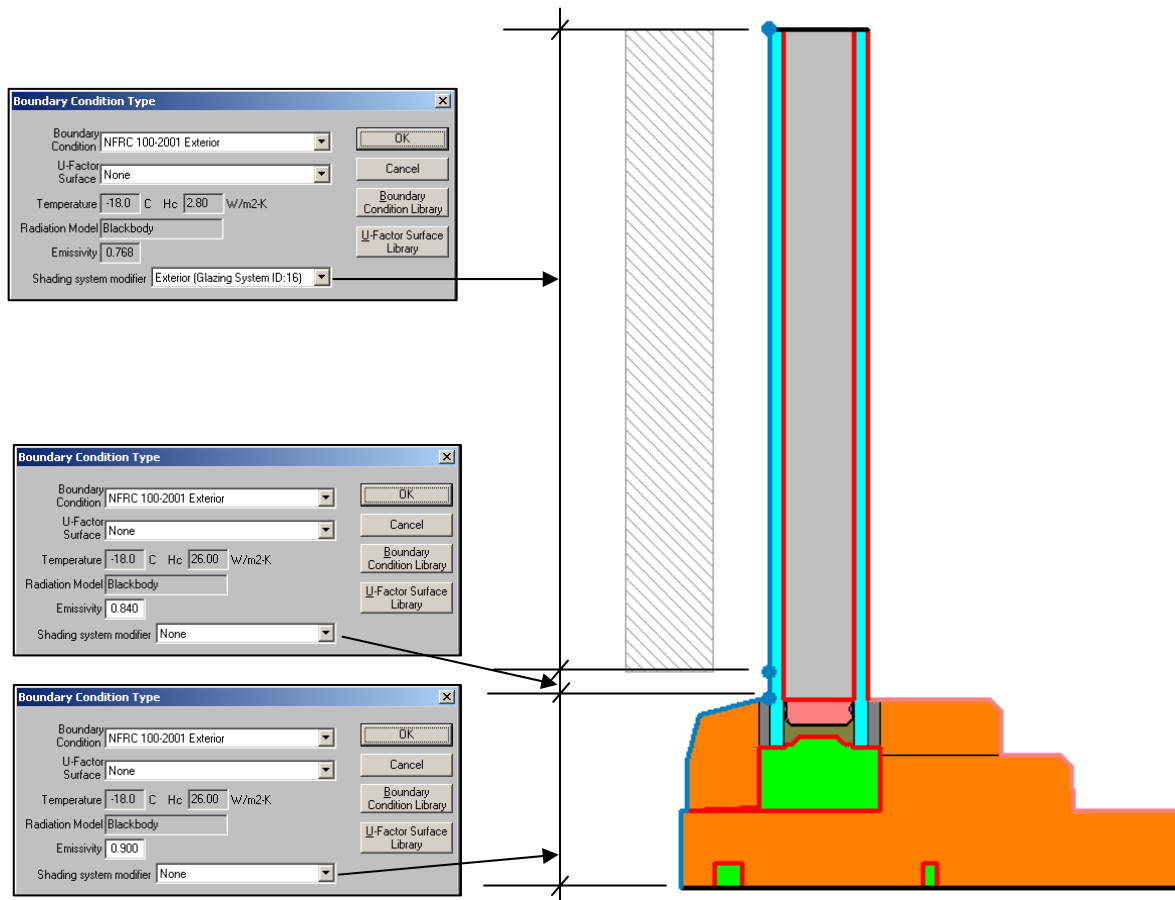

Figure 5-7. Set the **Shading system modifier** appropriately for each boundary condition segment.

- If the D_{bot} , D_{top} , D_{right} or D_{left} values are negative, the shading device will extend below the sight line and the appropriate frame boundary segments would need to have the **Shading system modifiers** applied.

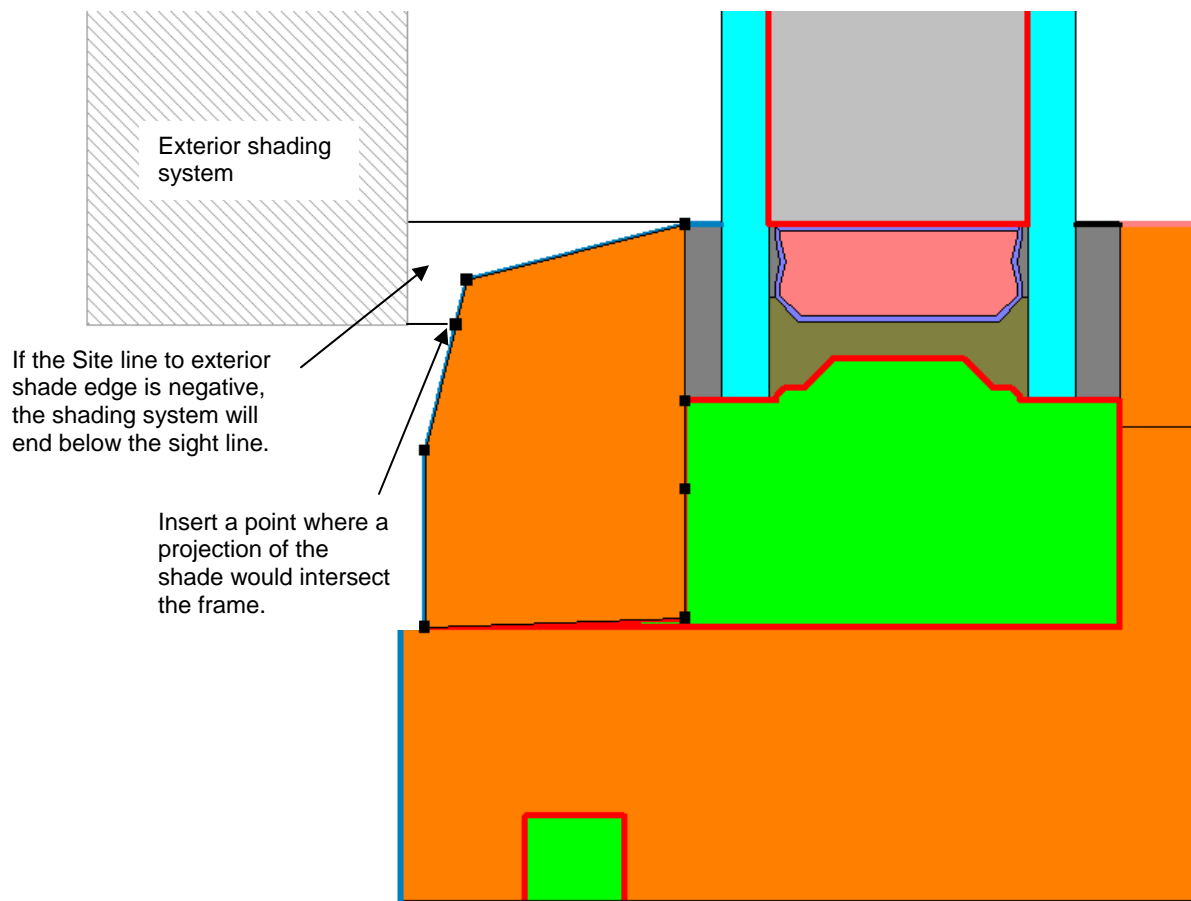

Figure 5-8. Insert a point in the frame where the projection of the shading system intersects it.

- Generate the boundary conditions and assign the shading system modifier to the glazing system and the section of the frame next to the shading system.

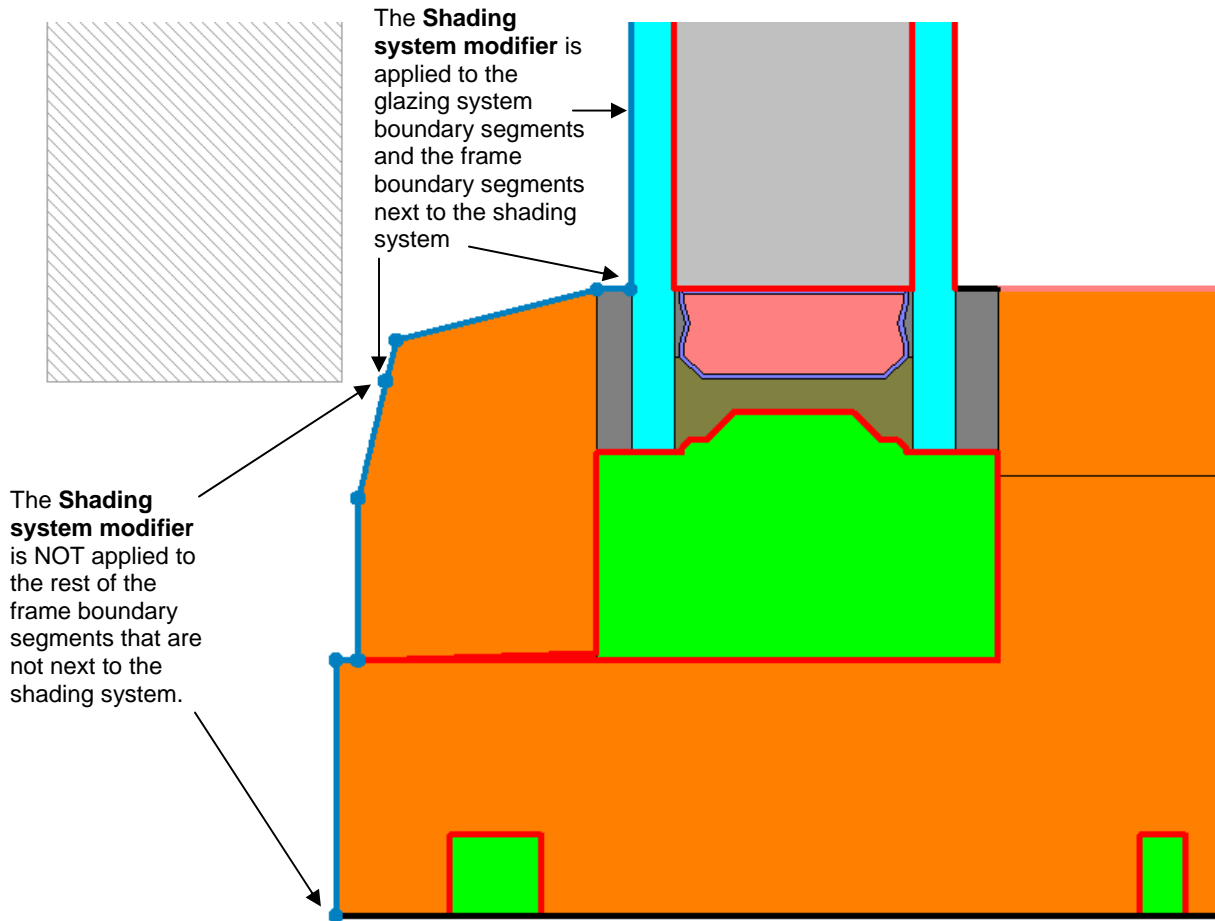

Figure 5-9. Assign the Shading system modifier to all boundary segments next to the shading system.

5.3. Importing WINDOW 6 Glazing Systems with an Integral Shading Device

After an integral shading device has been defined in a WINDOW 6 glazing system, it can be imported into THERM 6. This procedure is identical to importing a glazing system without a shading device.

5.3.1. Insert the Glazing System

The steps are briefly listed below, and described in detail in the sections for each shading device type:

- Draw the frame elements
- Go to the **Libraries** menu and select **Glazing Systems**
- From the **Glazing Systems** dialog box, select the desired WINDOW database and Glazing System from that database
- Set the appropriate values in the **Insert Glazing System** dialog box. The two fields used for interior and exterior shading systems (**Site line to interior shade edge** and **Site line to exterior shade edge** do not apply to integral shading systems).

The screenshot shows the 'Insert Glazing System' dialog box with the following settings:

- Orientation: Up
- Cross Section Type: Sill
- CR cavity height: 39.3701 inches
- Sight line to bottom of glass: 0.4375 inches
- Spacer height: 0.4375 inches
- Edge of Glass Dimension: 2.5 inches
- Glazing system height: 6 inches
- Site line to interior shade edge: 0 inches
- Site line to exterior shade edge: 0.25 inches
- Use nominal glass thickness
- Use CR Model for Window Glazing Systems
- Gap Properties:
 - Default (selected), Custom
 - Gap: 1
 - Keff: 0.02660 Btu/h-ft-F
 - Width: 0.65 inches
- Spacer:
 - Draw spacer
 - Single spacer for multiple glazings
 - Material: [Empty]
- Boundary Conditions:
 - Use U-factor values
 - Use SHGC values
 - Exterior Boundary Condition: Use convection plus blackbody radiation
 - Interior Boundary Condition: Use convection plus enclosure radiation

Figure 5-10. Input the correct values into the Insert Glazing System dialog box.

- For integral shading devices, THERM uses the the following values from the WINDOW 6 glazing system definition to determine the distance of the venetian blind from the spacer:
 - Dtop for head
 - Dbot (for sill)
 - The average of Dright and Dleft for jambs

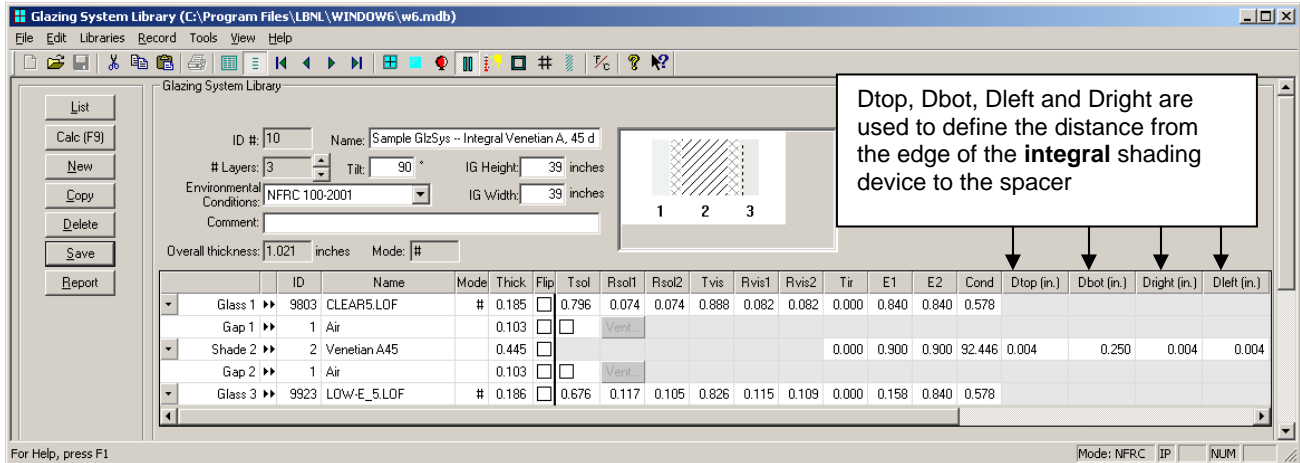

Figure 5-11. The distance from the edge of the shading device to the spacer is defined by Dtop, Dbot, Dright or Dleft (depending on the type of cross section) for an integral shading device.

- The glazing system will be imported and the integral shading device will be displayed as a set of layers, representing the gaps on either side of the shading device as well as the shading device itself.

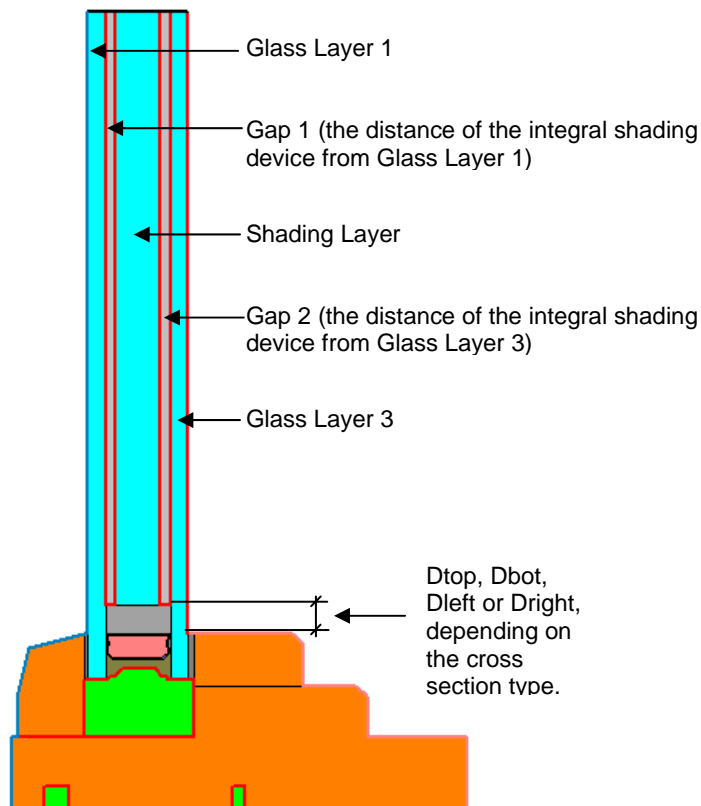

Figure 5-12. THERM will automatically import the glazing system with the shading system edge the specified distance from the spacer, based on Dtop, Dbot, Dleft or Dright.

5.3.2. Define the Boundary Conditions

- For a glazing system with an integral shading device, boundary conditions in THERM 6 are defined in the normal way, and the Shading system modifiers are set to “None” on all boundary segments.

5.4. Import the THERM 6 Files into the WINDOW 6 Frame Library

When all the frame cross sections have been modeled in THERM 6 with shading devices, the files can be imported into the WINDOW 6 Frame Library and used to create a whole window with a shading system, using the normal procedures.

6. Technical Reference

This section documents in detail each section of the program that has changed from the WINDOW 5 version. Refer to the WINDOW 5 documentation for details of program features that have not changed.

6.1. Complex Calculation Methodology Overview

The calculation methodologies in WINDOW 6 for complex glazings are a combination of several procedures, depending on the type of glazing system.

- Matrix Method Calculation Engine
- Angular Basis:
- Venetian Blind Algorithms

6.1.1. Matrix Method Calculation Engine

The properties of system containing layers are built up computationally from the measured layer properties using a transmission/multiple-reflection calculation. The calculation produces the total directional-hemispherical transmittance of the fenestration system and the layer by layer absorptances. This is a mathematical method for deriving the overall system transmittance matrix of a set of layers including all the effects of multiple interreflections between layers, from the optical properties of the individual layers.

6.1.2. Venetian Blind Algorithms

The calculation of thermal and optical properties for venetian blinds are based on ISO 15099. The venetian blind is assumed to be a layer in a glazing system, which has similar characteristics to other layers in the glazing system, ie, heat is exchanged between layers by convection, conduction and radiation, and the layer absorbs, reflects and transmits solar radiation. However, venetian blinds in particular, because they are composed of slats, can be partly transmitting of solar radiation as well as thermal (long wave) radiation. The venetian blind is also permeable by air, either through the blind, or around the perimeter.

WINDOW 6 calculates the solar (defined as including the ultraviolet, visible and near infra-red wavelengths) properties (transmittance and reflectance for both the front and back of the blind) for a set of incident (incoming) and outgoing radiation angles (defined by the angular basis, as described below). The results of these calculations are matrices of numbers -- Bi-Directional Transmittance Distribution Functions (BTDF) for front and back transmittance, and Bi-Directional Reflectance Distribution Functions (BRDF) for front and back reflectance. These calculations are done for discrete wavelengths whose spacing depends on the quality of the spectral data available.

These matrices are then used in the calculation of the overall glazing system solar optical properties using the matrix method calculation engine, described above. The venetian blind is treated as a layer in the glazing system, with both specular and diffuse transmission and reflection properties, as opposed to the "simple" transparent (glass) layers, which are assumed to have purely specular properties.

The far infra-red (FIR) properties of the venetian blind (transmittance, and emissivity at the front and back of the blind) are also calculated in a single band representing the entire far infra-red range from 2.5 micrometers to 50 micrometers (μm)

Information needed to model venetian blinds include:

- **Slat Geometry:** This information includes width of the slat, distance between slats, slat tilt angle, radius of slat curvature and number of slat segments in the curvature.
- **Slat Optical Properties:** This information includes solar properties (front reflectance, back reflectance, transmittance) and far infra-red properties (front emissivity, back emissivity and Transmittance)
- **Angle Coordinates (Basis):** the angle definitions as defined by the basis. This includes defining all the incoming and outgoing angles (which must be the same for each layer in the glazing system).

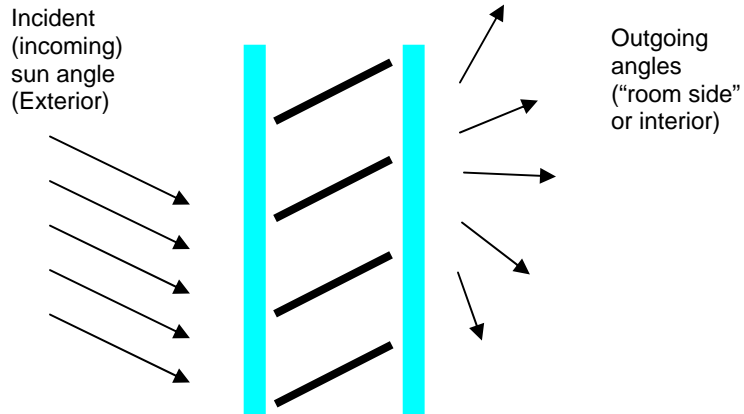

Figure 6-1. Incoming and outgoing light angles are modeled based on the angular "basis" specified.

6.1.3. Angular Coordinates (Basis)

To determine the angular basis for the calculations, a hemisphere is divided into patches.

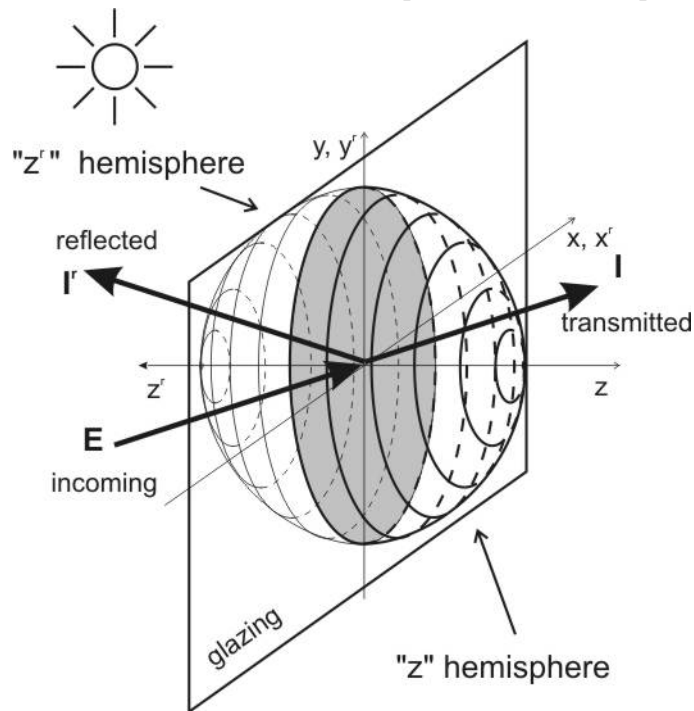

Figure 6-2. Two hemispheres are defined for the incoming and outgoing (or transmitted) angles, each with their corresponding coordinate systems.

The basis are the angles for the center of each patch, so that the basis defines the center and size of the patch. By default in WINDOW 6, the incoming and outgoing angles have to be the same. There are three basis defined for WINDOW 6 (specified in File/Preferences):

- W6 Standard Basis: the full 145 incoming and 145 outgoing angles
- W6 Half-size: 73 incoming and outgoing angles
- W6 Quarter-size: 41 incoming and outgoing angles.

The angles are defined as pairs of Theta and Phi, as shown in the following diagram.

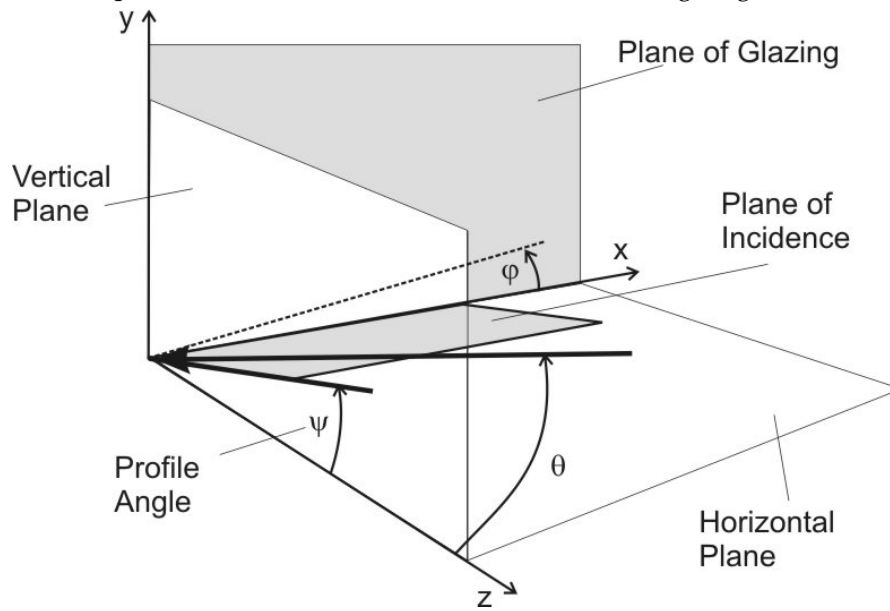

Figure 6-3. The angles are defined by pairs of Theta and Phi.

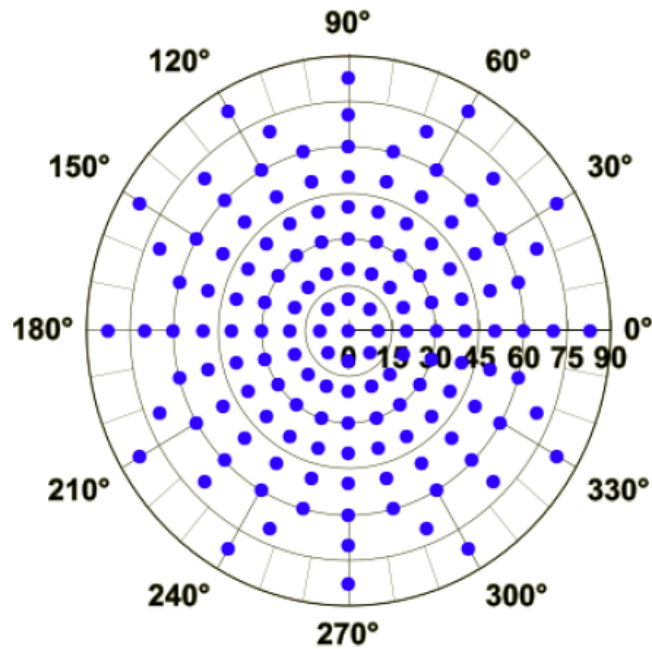

Figure 6-4. The "W6 Standard Basis, which consists of 145 angles.

6.1.4. Woven Shade Algorithms

6.2. ISO 9050 Wavelength Set

Name: iso 9050.wvl

Description: wavelength set from iso9050:2003 very similar to optics.wvl, by Christian Nov 2005

Wavelength Units: Microns

0.300	0.480	0.76	2	22
0.305	0.490	0.77	2.05	23
0.31	0.500	0.78	2.1	24
0.315	0.510	0.79	2.15	25
0.32	0.520	0.8	2.2	26
0.325	0.530	0.85	2.25	27
0.330	0.540	0.9	2.3	28
0.335	0.550	0.95	2.35	29
0.340	0.56	1	2.4	30
0.345	0.57	1.05	2.45	31
0.350	0.58	1.1	2.5	32
0.355	0.59	1.15	5	33
0.36	0.6	1.2	6	34
0.365	0.61	1.25	7	35
0.37	0.62	1.3	8	36
0.375	0.63	1.35	9	37
0.38	0.64	1.4	10	38
0.385	0.65	1.45	11	39
0.39	0.66	1.5	12	40
0.395	0.67	1.55	13	
0.4	0.68	1.6	14	
0.41	0.69	1.65	15	
0.42	0.7	1.7	16	
0.43	0.71	1.75	17	
0.44	0.72	1.8	18	
0.45	0.73	1.85	19	
0.46	0.74	1.9	20	
0.47	0.75	1.95	21	

Figure 6-5. The Shading Layer library has been added to the Libraries menu.

6.3. W6 BTDF Output File Documentation

The W6 BTDF output file supports 3 different basis definitions:

- 0 = W6 Full-Basis
- 1 = W6 Half-Basis
- 2 = W6 Quarter-Basis

The basis definitions are described in the following sections

The data written with phi varying most rapidly. The first phi is 0° and phis are distributed evenly, so that nPhis=4 would mean 0°, 90°, 180°, 270°. Tables are provided at the end of this document with the full definition of each basis.

The file is a CSV text file with the following format:

Line 1:

GlazingSystemID, GlazingSystemName, NglazingLayers, BasisID, Comment

Line 2:

"Solar Tf"

Line 3 to Line 3+(nAngles-1)

Tfsol(in1, out1), Tfsol (in2, out1), Tfsol (in3, out1)... Tfsol (inN, out1)
Tfsol (in1, out2), Tfsol (in2, out2), Tfsol (in3, out2)... Tfsol (inN, out2)
 ...
Tfsol (in1, outN), Tfsol (in2, outN), Tfsol (in3, outN)... Tfsol (inN, outN)

"Solar Tb"

Tbsol(in1, out1), Tbsol (in2, out1), Tbsol (in3, out1)... Tbsol (inN, out1)
Tbsol (in1, out2), Tbsol (in2, out2), Tbsol (in3, out2)... Tbsol (inN, out2)
 ...
Tbsol (in1, outN), Tbsol (in2, outN), Tbsol (in3, outN)... Tbsol (inN, outN)

"Solar Rf"

Rfsol(in1, out1), Rfsol (in2, out1), Rfsol (in3, out1)... Rfsol (inN, out1)
Rfsol (in1, out2), Rfsol (in2, out2), Rfsol (in3, out2)... Rfsol (inN, out2)
 ...
Rfsol (in1, outN), Rfsol (in2, outN), Rfsol (in3, outN)... Rfsol (inN, outN)

"Solar Rb"

Rbsol(in1, out1), Rbsol (in2, out1), Rbsol (in3, out1)... Rbsol (inN, out1)
Rbsol (in1, out2), Rbsol (in2, out2), Rbsol (in3, out2)... Rbsol (inN, out2)
 ...
Rbsol (in1, outN), Rbsol (in2, outN), Rbsol (in3, outN)... Rbsol (inN, outN)

Repeats for:

Tfvis
Tbvis
Rfvis
Rbvi

6.3.1. W6 Full-Basis (145 angles)

Theta	bound	nPhis
0	5	1
10	15	8
20	25	16
30	35	20
40	45	24
50	55	24
60	65	24
70	75	16
82.5	90	12

Angle indices for W6 Full Basis

n	Theta	Phi
1	0	0
2	10	0
3	10	45
4	10	90
5	10	135
6	10	180
7	10	225
8	10	270
9	10	315
10	20	0
11	20	22.5
12	20	45
13	20	67.5
14	20	90
15	20	112.5
16	20	135
17	20	157.5
18	20	180
19	20	202.5
20	20	225
21	20	247.5
22	20	270
23	20	292.5
24	20	315
25	20	337.5
26	30	0
27	30	18
28	30	36
29	30	54
30	30	72
31	30	90
32	30	108
33	30	126
34	30	144

35	30	162
n	Theta	Phi
36	30	180
37	30	198
38	30	216
39	30	234
40	30	252
41	30	270
42	30	288
43	30	306
44	30	324
45	30	342
46	40	0
47	40	15
48	40	30
49	40	45
50	40	60
51	40	75
52	40	90
53	40	105
54	40	120
55	40	135
56	40	150
57	40	165
58	40	180
59	40	195
60	40	210
61	40	225
62	40	240
63	40	255
64	40	270
65	40	285
66	40	300
67	40	315
68	40	330
69	40	345
70	50	0
n	Theta	Phi
71	50	15
72	50	30
73	50	45
74	50	60
75	50	75
76	50	90
77	50	105
78	50	120
79	50	135

80	50	150
81	50	165
82	50	180
83	50	195
84	50	210
85	50	225
86	50	240
87	50	255
88	50	270
89	50	285
90	50	300
91	50	315
92	50	330
93	50	345
94	60	0
95	60	15
96	60	30
97	60	45
98	60	60
99	60	75
100	60	90
101	60	105
102	60	120
103	60	135
104	60	150
105	60	165
n	Theta	Phi
106	60	180
107	60	195
108	60	210
109	60	225
110	60	240
111	60	255
112	60	270
113	60	285
114	60	300
115	60	315
116	60	330
117	60	345
118	70	0
119	70	22.5
120	70	45
121	70	67.5
122	70	90
123	70	112.5
124	70	135
125	70	157.5

126	70	180
127	70	202.5
128	70	225
129	70	247.5
130	70	270
131	70	292.5
132	70	315
133	70	337.5
134	82.5	0
135	82.5	30
136	82.5	60
137	82.5	90
138	82.5	120
139	82.5	150
140	82.5	180
141	82.5	210
142	82.5	240
143	82.5	270
144	82.5	300
145	82.5	330

6.3.2. W6 Half-Basis (73 angles)

Theta	bound	nPhis
0	6.5	1
13	19.5	8
26	32.5	12
39	46.5	16
54	61.5	20
69	76.5	12
83.25	90	4

Angle indices for W6 Half Basis

n	Theta	Phi
1	0	0
2	13	0
3	13	45
4	13	90
5	13	135
6	13	180
7	13	225
8	13	270
9	13	315
10	26	0
11	26	30
12	26	60
13	26	90
14	26	120
15	26	150
16	26	180

17	26	210
18	26	240
19	26	270
20	26	300
21	26	330
22	39	0
23	39	22.5
24	39	45
25	39	67.5
26	39	90
27	39	112.5
28	39	135
29	39	157.5
30	39	180
31	39	202.5
32	39	225
33	39	247.5
34	39	270
35	39	292.5
36	39	315
37	39	337.5
38	54	0
39	54	18
n	Theta	Phi
40	54	36
41	54	54
42	54	72
43	54	90
44	54	108
45	54	126
46	54	144
47	54	162
48	54	180
49	54	198
50	54	216
51	54	234
52	54	252
53	54	270
54	54	288
55	54	306
56	54	324
57	54	342
58	69	0
59	69	30
60	69	60
61	69	90
62	69	120
63	69	150
64	69	180
65	69	210
66	69	240
67	69	270

68	69	300
69	69	330
70	83.25	0
71	83.25	90
72	83.25	180
73	83.25	270

6.3.3. W6 Quarter-Basis (41 angles)

Theta	bound	nPhis
0	9	1
18	27	8
36	46	12
56	66	12
78	90	8

Angle indices for W6 Quarter Basis

n	Theta	Phi
1	0	0
2	18	0
3	18	45
4	18	90
5	18	135
6	18	180
7	18	225
8	18	270
9	18	315
10	36	0
11	36	30
12	36	60
13	36	90
14	36	120
15	36	150
16	36	180
17	36	210
18	36	240
19	36	270
20	36	300
21	36	330
22	56	0
23	56	30
24	56	60
25	56	90
26	56	120
27	56	150
28	56	180
29	56	210
30	56	240

31	56	270
32	56	300
33	56	330
34	78	0
35	78	45
36	78	90
37	78	135
38	78	180
39	78	225
40	78	270
41	78	315

6.4. Documentation for LBNL BSDF XML file

Contact LBNL (WINDOWHelp@lbl.gov) to obtain the latest documentation for the BSDF XML file.

6.5. Standards Files used in WINDOW 6

WINDOW 6 references the W5_NFRC_2003.std file for definitions of calculation standards. This file is found in the "LBNL Standards" sub-directory where the WINDOW 6 program is installed (the default being c:\Program Files\LBNL\LBNL Standards).

6.5.1. W5_NFRC_2003.std

Below is a listing from the W5_NFRC_2003.std file listing the standard assumptions used in WINDOW 6 for optical properties calculations.

Standard Description : Consistent with NFRC 300-2003 - default for WINDOW5
Standard Provides Methods: SOLAR, PHOTOPIC, COLOR_TRISTIMX, COLOR_TRISTIMY,
COLOR_TRISTIMZ, THERMAL IR, TUV, SPF, TDW, TKR

Name : SOLAR
Description : NFRC 300-2003 Solar
Source Spectrum : ASTM E891 Table 1 Direct AM1_5.ssp
Detector Spectrum : None
Wavelength Set : Source
Integration Rule : Trapezoidal
Minimum Wavelength : 0.3
Maximum Wavelength : 2.5

Name : PHOTOPIC
Description : NFRC 300-2003 Photopic
Source Spectrum : CIE Illuminant D65 lnm.ssp
Detector Spectrum : ASTM E308 1931 Y.dsp
Wavelength Set : Color 5nm.wvl
Integration Rule : Trapezoidal
Minimum Wavelength : 0.38
Maximum Wavelength : 0.78

Name : COLOR_TRISTIMX
Description : ASTM E308 Color - not in NFRC 300-2003
Source Spectrum : CIE Illuminant D65 lnm.ssp
Detector Spectrum : ASTM E308 1964 X.dsp
Wavelength Set : Color 5nm.wvl
Integration Rule : Trapezoidal (Normalized, k=1.0)
Minimum Wavelength : 0.38
Maximum Wavelength : 0.78

Name : COLOR_TRISTIMY
Description : ASTM E308 Color - not in NFRC 300-2003
Source Spectrum : CIE Illuminant D65 lnm.ssp
Detector Spectrum : ASTM E308 1964 Y.dsp
Wavelength Set : Color 5nm.wvl
Integration Rule : Trapezoidal (Normalized, k=1.0)
Minimum Wavelength : 0.38
Maximum Wavelength : 0.78

Name : COLOR_TRISTIMZ
Description : ASTM E308 Color - not in NFRC 300-2003
Source Spectrum : CIE Illuminant D65 1nm.ssp
Detector Spectrum : ASTM E308 1964 Z.dsp
Wavelength Set : Color 5nm.wvl
Integration Rule : Trapezoidal (Normalized, k=1.0)
Minimum Wavelength : 0.38
Maximum Wavelength : 0.78

Name : THERMAL IR
Description : Thermal Infrared average - not in NFRC 300-2003
Source Spectrum : Blackbody (T=300.0K)
Detector Spectrum : None
Wavelength Set : Data
Integration Rule : Trapezoidal
Minimum Wavelength : 5.0
Maximum Wavelength : Wavelength set

Name : TUV
Description : Unweighted UV average - not in NFRC 300-2003
Source Spectrum : ASTM E891 Table 1 Direct AM1_5.ssp
Detector Spectrum : None
Wavelength Set : Source
Integration Rule : Trapezoidal
Minimum Wavelength : 0.31
Maximum Wavelength : 0.38

Name : SPF
Description : Skin Protection Factor - not in NFRC 300-2003
Source Spectrum : Sayre UV Source.ssp
Detector Spectrum : CIE SPF McKinlay UV.dsp
Wavelength Set : Source
Integration Rule : Trapezoidal
Minimum Wavelength : 0.28
Maximum Wavelength : 0.4

Name : TDW
Description : NFRC 300-2003 UV Damage Weighted Transmittance based on CIE 89/3
Source Spectrum : ASTM E891 Table 1 Direct AM1_5.ssp
Detector Spectrum : UV Action (a=3.6, b=12.0)
Wavelength Set : Source
Integration Rule : Trapezoidal
Minimum Wavelength : 0.3
Maximum Wavelength : 0.7

Name : TKR
Description : Old-style Krochmann damage weighted average - not in NFRC 300-2003
Source Spectrum : ASTM E891 Table 1 Direct AM1_5.ssp
Detector Spectrum : Krochmann
Wavelength Set : Source
Integration Rule : Trapezoidal
Minimum Wavelength : 0.3
Maximum Wavelength : 0.5

