

# Lawrence Berkeley National Laboratory

## Lawrence Berkeley National Laboratory

**Title**

2.1E Supplement

**Permalink**

<https://escholarship.org/uc/item/5zf527gg>

**Author**

Winkelmann, F.C.

**Publication Date**

1993-11-01

Peer reviewed

RECEIVED  
MAY 16 1994  
OSTI

# DOE-2

## SUPPLEMENT

### Version 2.1E

F.C. Winkelmann, B.E. Birdsall, W.F. Buhl,  
 K.L. Ellington, A.E. Erdem  
 Energy and Environment Division  
 Lawrence Berkeley Laboratory  
 University of California  
 Berkeley, CA 94720  
 and  
 J.J. Hirsch and S. Gates  
 Hirsch & Associates  
 Camarillo, CA 93012

November 1993

#### DISCLAIMER

This report was prepared as an account of work sponsored by an agency of the United States Government. Neither the United States Government nor any agency thereof, nor any of their employees, makes any warranty, express or implied, or assumes any legal liability or responsibility for the accuracy, completeness, or usefulness of any information, apparatus, product, or process disclosed, or represents that its use would not infringe privately owned rights. Reference herein to any specific commercial product, process, or service by trade name, trademark, manufacturer, or otherwise does not necessarily constitute or imply its endorsement, recommendation, or favoring by the United States Government or any agency thereof. The views and opinions of authors expressed herein do not necessarily state or reflect those of the United States Government or any agency thereof.

The Government reserves for itself and others acting on its behalf a royalty free, nonexclusive, irrevocable, world-wide license for governmental purposes to publish, distribute, translate, duplicate, exhibit, and perform any such data copyrighted by the contractor.

(c) 1993. Regents of the University of California, Lawrence Berkeley Laboratory. This work was supported by the Assistant Secretary for Energy Efficiency and Renewable Energy, Office of Building Technologies, Building Systems and Materials Division of the U. S. Department of Energy, under Contract No. DE-AC03-76SF00098. Support for Version 2.1E was also provided by Southern California Edison Company, Pacific Gas and Electric Company, Gas Research Institute (via ElectroCom GARD, Ltd.), Electric Power Research Institute, Pacific Northwest Laboratory, and the IEA Solar Heating and Cooling Programme. Lawrence Berkeley Laboratory is an Equal Opportunity Employer.

# MASTER

SE

# TABLE OF CONTENTS

---

ACKNOWLEDGEMENT .....	11
INTRODUCTION .....	12
MAKING DOE-2.1D INPUTS COMPATIBLE WITH DOE-2.1E .....	13
HEATING AND COOLING LOAD DIFFERENCES BETWEEN DOE-2.1D AND DOE-2.1E .....	14
MISCELLANEOUS PROGRAM CHANGES IN VERSIONS 2.1D AND 2.1E .....	16
 <b>BUILDING DESCRIPTION LANGUAGE</b>	
INPUT FUNCTIONS IN LOADS AND SYSTEMS .....	1. 3
Introduction .....	1. 3
Commands and Keywords for Input Functions .....	1. 4
Hourly Report Variables .....	1. 10
Tabs .....	1. 10
Valid FORTRAN Statements and Operations .....	1. 11
Reading From and Writing To Files .....	1. 13
Loads Input Function Examples .....	1. 14
Systems Input Function Examples .....	1. 25
HOURLY REPORT FREQUENCIES AND SUMMARIES .....	1. 29
SAVING FILES OF HOURLY OUTPUT FOR POST PROCESSING .....	1. 30
SHARING HOURLY REPORT DATA AMONG PROGRAM MODULES .....	1. 33
METRIC OPTION .....	1. 35
Introduction .....	1. 35
Units Table (Excerpt from LOADS Report LV-M) .....	1. 36
Invoking the Metric Option .....	1. 37
Materials and Construction Library .....	1. 37
Basic Units .....	1. 38
Keyword Synonyms for the Metric Option .....	1. 38
Keyword Limits in the Metric Option .....	1. 38
DAY-SCHEDULES in the Metric Option .....	1. 39
DAY-RESET-SCHEDULES in the Metric Option .....	1. 40
Residential Infiltration in Metric Input .....	1. 40
Reporting Fuel Use in Metric Units .....	1. 40
Exceptions .....	1. 41
Weather Files .....	1. 41
INPUT MACROS AND GENERAL LIBRARY FEATURES .....	1. 42
Input Macros .....	1. 42
Listing Format .....	1. 54

## **DISCLAIMER**

**Portions of this document may be illegible in electronic image products. Images are produced from the best available original document.**

Library Example.....	1. 55
<b>LOADS</b>	
<b>SUNSPACES .....</b>	<b>2. 4</b>
Overview .....	2. 4
Sunspace-Related Keywords in LOADS .....	2. 6
Interior Windows.....	2. 8
Interior Doors.....	2. 9
Sunspace-Related Keywords in SYSTEMS.....	2. 15
<b>SUNSPACE MODELING GUIDELINES.....</b>	<b>2. 18</b>
Control of Air Flow .....	2. 18
Reducing Conductive Heat Loss from Sunspace Exterior Glazing .....	2. 20
Positioning of Sunspace Surfaces.....	2. 21
Massive Interior Walls.....	2. 21
Solar Radiation Absorbed by Interior Walls .....	2. 22
Interior Solar Radiation.....	2. 22
Automatic Sizing of Systems Serving Conditioned Sunspaces .....	2. 23
Description of Window Treatment and Performance .....	2. 24
Use of Multipliers .....	2. 26
Translucent Glazing .....	2. 27
Moisture from Plants and Trees .....	2. 28
Baffles and Louvers.....	2. 28
Atrium as Return Air Plenum.....	2. 28
Heating, Cooling, and Venting of Residential Sunspaces.....	2. 30
Use of Custom Weighting Factors for Sunspaces.....	2. 30
Hourly Report Variables for Sunspace Analysis .....	2. 30
Sunspace-Related Error, Caution, and Warning Messages.....	2. 31
<b>WINDOW MANAGEMENT AND SOLAR RADIATION.....</b>	<b>2. 35</b>
Window Management.....	2. 35
Conditional Shading-Device Control.....	2. 35
<b>DAYLIGHTING .....</b>	<b>2. 37</b>
Overview .....	2. 37
Guidelines for Daylighting Modeling.....	2. 38
Use of Window and Exterior Wall Multipliers.....	2. 39
Weather Files .....	2. 39
Thermal Zoning .....	2. 39
Surface Orientation .....	2. 40
Multiple Lighting Zones.....	2. 40
Translucent Glazing .....	2. 41
Fins, Overhangs, and Other Shading Surfaces .....	2. 42
Skylights with Light Wells .....	2. 43
Domed Skylights.....	2. 44
Window Management.....	2. 45
Multiple Skylights .....	2. 46
Limitations of the Daylighting Calculation .....	2. 50
Daylighting Commands and Keywords .....	2. 52
Daylighting Input Examples for SPACE-CONDITIONS .....	2. 58
Example of Window Shading Device Assignment .....	2. 63

Daylighting Verification and Summary Reports .....	2. 64
Monthly Average Atmospheric Moisture for U.S. Cities .....	2. 65
Monthly Average Atmospheric Turbidity for U.S. Cities .....	2. 67
<b>TROMBE WALLS</b> .....	2. 70
General Rules .....	2. 70
Warning .....	2. 70
Reporting .....	2. 73
<b>FIXED SHADES, FINS AND OVERHANGS, SHADE-SCHEDULE and SELF SHADES</b> .....	2. 74
Fixed Shades .....	2. 74
Overhangs and Fins .....	2. 77
Shade Schedule .....	2. 79
Self Shading .....	2. 79
<b>AUTOMATIC CALCULATION OF THE SHADING OF DIFFUSE SOLAR RADIATION</b> .....	2. 80
Introduction .....	2. 80
<b>DISTRIBUTION OF HEAT FROM LIGHTS</b> .....	2. 81
Introduction .....	2. 81
<b>THE SHERMAN-GRIMSRUD INFILTRATION METHOD</b> .....	2. 86
<b>TERRAIN AND HEIGHT MODIFICATION TO WIND SPEED</b> .....	2. 88
<b>FLOOR MULTIPLIERS AND INTERIOR WALL TYPES</b> .....	2. 91
<b>IMPROVED EXTERIOR INFRARED RADIATION LOSS CALCULATION</b> .....	2. 97
Discussion .....	2. 97
<b>IMPROVED OUTSIDE AIR FILM CONDUCTANCE CALCULATION</b> .....	2. 98
Discussion .....	2. 98
OUTSIDE-EMISS Keyword .....	2. 98
<b>WINDOW LIBRARY</b> .....	2. 99
Introduction .....	2. 99
Comparison of Methods for Specifying Window Properties .....	2.100
Index to the Window Library .....	2.101
Printing Window Library Entries .....	2.113
Creating Custom Windows .....	2.113
Using Shading Devices with Windows from the Window Library .....	2.113
Edge-of-Glass Effects .....	2.114
Improved Glass Conduction Calculation .....	2.115
<b>WINDOW FRAMES</b> .....	2.116
Introduction .....	2.116
<b>SWITCHABLE GLAZING</b> .....	2.119
Introduction .....	2.119
Electrochromic Switchable Glazings .....	2.123
Switchable Glazing Examples .....	2.126

## SYSTEMS

<b>ENERGY END USES AND METERS</b> .....	3. 4
Metering and Reporting of Energy End Uses.....	3. 4
Electrical and Fuel Meters in LOADS.....	3. 8
Electrical and Fuel Meters in SYSTEMS .....	3. 8
Specifying Meters in SYSTEMS .....	3. 8
Building Resources in SYSTEMS .....	3. 13
<b>POWERED INDUCTION UNIT (PIU)</b> .....	3. 16
Introduction .....	3. 16
Input for PIU .....	3. 18
<b>PACKAGED VARIABLE VOLUME, VARIABLE TEMPERATURE SYSTEM (PVVT)</b> .....	3. 22
Introduction .....	3. 22
<b>RESIDENTIAL VARIABLE VOLUME, VARIABLE TEMPERATURE SYSTEM (RESVVT)</b> .....	3. 23
Overview .....	3. 23
Input for RESVVT.....	3. 24
SYSTEM-EQUIPMENT Curve Defaults .....	3. 25
<b>AIR SOURCE HEAT PUMP ENHANCEMENTS</b> .....	3. 26
Introduction .....	3. 26
Report Changes for the Air/Air Heat Pump Simulation.....	3. 28
<b>WATER LOOP HEAT PUMP SYSTEM (HP) ENHANCEMENTS</b> .....	3. 29
Introduction .....	3. 29
Description of All Air/Air Heat Pump Keywords .....	3. 33
<b>VARIABLE SPEED ELECTRIC HEAT PUMP</b> .....	3. 43
Introduction .....	3. 43
Input .....	3. 44
Electric Heat Pump Heat Recovery .....	3. 46
Fans.....	3. 47
Notes:.....	3. 47
<b>GAS HEAT PUMPS</b> .....	3. 48
Introduction .....	3. 48
Description of Gas Heat Pump Systems .....	3. 48
How to Specify a Gas Heat Pump.....	3. 49
Supplemental Heating for the Gas Heat Pump.....	3. 51
Gas Heat Pump Electrical Consumption.....	3. 52
Gas Heat Pump Waste Heat Recovery .....	3. 53
Gas Heat Pump Examples.....	3. 55
<b>MISCELLANEOUS CHANGES TO SOME SYSTEM KEYWORDS</b> ....	3. 56
<b>DOMESTIC HOT WATER HEATER AND TANK MODEL IN SYSTEMS</b> .....	3. 57
Introduction .....	3. 57
Default Sizing.....	3. 59
Waste Heat Use.....	3. 59
Simulation Strategy.....	3. 60
Curves.....	3. 61

SERVICE HOT WATER HEAT PUMPS .....	3. 62
Hourly Report Variables .....	3. 63
EVAPORATIVE COOLING .....	3. 64
Introduction .....	3. 64
Stand Alone Evaporative Cooler .....	3. 64
Add-On Evaporative Cooling .....	3. 66
Residential Direct Evaporative Cooler .....	3. 70
PACKAGED TOTAL-GAS SOLID-DESICCANT SYSTEM (PTGSD) .....	3. 72
Introduction .....	3. 72
ADD-ON (INTEGRATED) DESICCANT COOLING .....	3. 76
Introduction .....	3. 76
Control of Integrated Desiccant Cooling Units .....	3. 78
Control of Solid Desiccant Unit .....	3. 80
WATER COOLED CONDENSER OPTION FOR PACKAGED UNITS PSZ, PVAVS AND PVVT .....	3. 83
Introduction .....	3. 83
Example Input .....	3. 93
EVAPORATIVE PRECOOLER FOR AIR-COOLED DIRECT- EXPANSION UNITS .....	3. 95
Introduction .....	3. 95
OUTSIDE AIR ECONOMIZER CONTROL .....	3. 97
Examples .....	3.100
OPTIMUM FAN START .....	3.101
Rules .....	3.101
Cautions .....	3.102
HEAT RECOVERY FROM REFRIGERATED CASE WORK .....	3.103
Introduction .....	3.103
Example .....	3.109
Reporting .....	3.111
NIGHT VENTILATION .....	3.112
Report Modification .....	3.114
BASEBOARD HEATING IN PLENUMS .....	3.115
ENHANCED MOISTURE BALANCE CALCULATION .....	3.116
VARIOUS CONTROL ENHANCEMENTS .....	3.118
Control of Air Flow Rate to Zones .....	3.119
MIN-CFM-SCH AND OTHER SCHEDULE USES .....	3.121
ENHANCEMENTS TO THE RESIDENTIAL NATURAL VENTILATION ALGORITHM .....	3.122
Discussion .....	3.122
DESIGN-DAY ROUTINES .....	3.124
Introduction .....	3.124
Investigating Design Alternatives using DESIGN-DAY .....	3.126
IMPROVEMENTS TO THE COOLING COIL MODEL .....	3.128



<b>SYSTEM SIZING .....</b>	<b>3.130</b>
Introduction .....	3.130
Step by Step Design Procedure for SYSTEMS .....	3.130
Consequences of User Inputs.....	3.134
How Sizing Routines and Run Period Simulations Differ .....	3.136
<b>INDEPENDENT COOLING AND HEATING SIZING RATIOS.....</b>	<b>3.138</b>
<b>ADDITIONS TO SYSTEMS REPORT SS-J.....</b>	<b>3.139</b>
DESIGN-DAY Systems Report .....	3.139
<b>USER-DEFINED CURVE-FIT BOUNDARIES.....</b>	<b>3.140</b>
<b>SYSTEM-EQUIPMENT DEFAULT CURVES.....</b>	<b>3.141</b>
<b>PLANT</b>	
<b>ENERGY METERS IN PLANT.....</b>	<b>4. 3</b>
Introduction .....	4. 3
Example: Gas Cooling Rate.....	4. 4
<b>GAS FIRED ABSORPTION CHILLER .....</b>	<b>4. 8</b>
Introduction .....	4. 8
<b>ENGINE DRIVEN COMPRESSION CHILLER.....</b>	<b>4. 11</b>
Introduction .....	4. 11
<b>ICE AND EUTECTIC THERMAL ENERGY STORAGE.....</b>	<b>4. 15</b>
Introduction .....	4. 15
Hourly Reports.....	4. 22
Examples of Thermal Energy Storage .....	4. 22
Discussion.....	4. 32
User-Specified Sizing.....	4. 32
Automatic Sizing.....	4. 33
Pumping.....	4. 35
Curves.....	4. 36
Other parameters.....	4. 36
Seven-day cycle.....	4. 36
<b>IMPROVED COOLING TOWER MODEL.....</b>	<b>4. 37</b>
Discussion.....	4. 37
<b>REVISED CIRCULATION PUMP SIMULATIONS.....</b>	<b>4. 45</b>
Introduction .....	4. 45
<b>PLANT EQUIPMENT OPERATING MODES.....</b>	<b>4. 47</b>
Introduction .....	4. 47
Note on the Default Operation of Chillers.....	4. 49
Examples of Plant Equipment Operating Modes.....	4. 51
<b>ELECTRICAL GENERATOR SIMULATIONS .....</b>	<b>4. 54</b>
Introduction .....	4. 54
Gas Turbine.....	4. 56
Steam Turbine .....	4. 57
<b>PLANT OPERATING STRATEGIES .....</b>	<b>4. 59</b>
Introduction .....	4. 59
Input Descriptions for Typical Plant Configurations.....	4. 61

PLANT Reports.....	4. 80
EQUIPMENT-QUAD Default Curves.....	4. 81
<b>ECONOMICS</b>	
<b>UTILITY RATE ENHANCEMENTS</b> .....	5. 2
Introduction .....	5. 2
Sequence of Operation .....	5. 3
Discussion of UTILITY-RATE Command.....	5. 3
Discussion of RATCHET Command .....	5. 3
Discussion of BLOCK-CHARGE Command.....	5. 4
<b>ECONOMICS Commands and Keywords Related to Utility Rates</b> .....	5. 6
UTILITY-RATE Command .....	5. 6
Cogeneration .....	5. 15
BLOCK-CHARGE Command.....	5. 16
Yearly, Seasonal, and Time of Use BLOCK-CHARGES.....	5. 20
RATCHET Command .....	5. 27
Use of Ratchets.....	5. 29
Examples.....	5. 30
<b>APPENDIX A</b>	
Hourly-Report Variable List.....	A. 1
<b>APPENDIX B</b>	
Input Functions — LOADS and SYSTEMS Flowcharts .....	B. 1
LOADS Flowcharts.....	B. 2
SYSTEMS Flowcharts.....	B. 21
<b>APPENDIX C</b>	
<b>Verification and Summary Reports for LOADS, SYSTEMS, PLANT,     and ECONOMICS</b>	
<b>LOADS Verification Reports</b> .....	C. 1
LV-A -- General Project and Building Input .....	C. 2
LV-B -- Summary of Spaces Occurring in the Project .....	C. 3
LV-C -- Details of Space .....	C. 4
LV-D -- Details of Exterior Surfaces in the Project.....	C. 8
LV-E -- Details of Underground Surfaces in the Project.....	C. 10
LV-F -- Details of Interior Surfaces in the Project .....	C. 11
LV-G -- Details of Schedules Occurring in the Project.....	C. 12
LV-H -- Details of Windows Occurring in the Project .....	C. 15
LV-I -- Details of Constructions Occurring in the Project .....	C. 16
LV-J -- Details of Building Shades in the Project .....	C. 17
LV-K -- Weighting Factor Summary .....	C. 18
LV-L -- Daylight Factor Summary .....	C. 20
LV-M -- DOE-2 English/Metric Conversion Table.....	C. 26
<b>LOADS Summary Reports</b>	
LS-A -- Space Peak Loads Summary .....	C. 28
LS-B -- Space Peak Load Components .....	C. 30

LS-C -- Building Peak Load Components.....	C. 32
LS-D -- Building Monthly Loads Summary .....	C. 34
LS-E -- Space Monthly Load Components in MBtu .....	C. 36
LS-F -- Building Monthly Load Components in MBtu .....	C. 40
LS-G -- Space Daylighting Summary .....	C. 42
LS-H -- Percent Lighting Energy Reduction By Daylight, <space> .....	C. 44
LS-I -- Percent Lighting Energy Reduction By Daylight, Building .....	C. 46
LS-J -- Daylight Illuminance Frequency of Occurrence .....	C. 48
LS-K -- Space Input Fuels Summary .....	C. 50
LS-L -- Management and Solar Summary For Space .....	C. 52
Hourly Reports.....	C. 54
Hourly Report Plot .....	C. 56
<b>SYSTEMS Verification Reports</b>	
SV-A -- Systems Design Parameters .....	C. 58
SV-A -- Systems Design Parameters (Refrigerated Equipment in <space>)	C. 62
SV-B -- Zone Fan Data For <system> .....	C. 64
<b>SYSTEMS Summary Reports: Overview.....</b>	
SS-A -- System Monthly Loads Summary .....	C. 66
SS-B -- System Monthly Loads Summary .....	C. 68
SS-C -- System Monthly Load Hours .....	C. 70
■ SS-D -- Plant Monthly Loads Summary .....	C. 72
SS-E -- Plant Monthly Load Hours .....	C. 76
SS-F -- Zone Demand Summary .....	C. 78
SS-G -- Zone Loads Summary .....	C. 80
SS-H -- System Monthly Loads Summary .....	C. 82
SS-I -- System Monthly Sensible-Latent Summary .....	C. 84
■ SS-J -- System Peak Heating and Cooling Days .....	C. 86
SS-K -- Space Temperature Summary .....	C. 88
SS-L -- Fan Electric Energy For <system> .....	C. 92
SS-M -- Fan Electric Energy For Plant .....	C. 96
SS-N -- Relative Humidity Scatter Plot.....	C. 98
SS-O -- Temperature Scatter Plot .....	C.100
■ SS-P -- (for SYSTEM) Load, Energy, and Part Load Heating .....	C.102
(for SYSTEM) Load, Energy, and Part Load Cooling	
■ SS-P -- (for PLANT-ASSIGNMENT).....	C.104
Load, Energy, and Part Load Pump Operation	
Load, Energy, and Part Load Boiler	
Load, Energy, and Part Load Cooling Tower	
Load, Energy, and Part Load Water-Side Econo	
Load, Energy, and Part Load DHW Tank	
■ SS-Q -- Heat Pump Cooling and Heating Summary for	
[u-name of SYSTEM or PLANT-ASSIGNMENT].....	C.108
■ SUPL -- System Supplemental Evaporative or Desiccant Cooling .....	C.116
REFG -- Refrigeration Equipment Summary.....	C.121
	C.123
<b>PLANT Verification Reports</b>	
PV-A -- Equipment Sizes .....	C.125
PV-B -- Cost Reference Data (used for default costs) .....	C.126
PV-C -- Equipment Costs .....	C.127
PV-E -- Equipment Load Ratios .....	C.128

PV-G -- Equipment Quadratics .....	C.129
<b>PLANT Summary Reports</b>	
PS-A -- Plant Energy Utilization Summary .....	C.131
PS-B -- Monthly Peak and Total Energy Use .....	C.135
PS-C -- Equipment Part Load Operation .....	C.137
PS-D -- Plant Loads Satisfied .....	C.139
PS-E -- Monthly Energy End Use Summary .....	C.143
PS-F -- Energy Resource Peak Breakdown By End Use .....	C.145
PS-G -- Electrical Load Scatter Plot.....	C.149
PS-H -- Equipment Use Statistics.....	C.151
PS-I -- Equipment Life-Cycle Costs.....	C.153
BEPS -- Building Energy Performance Summary .....	C.155
■ BEPU -- Building Energy Performance Summary (Utility Units).....	C.157
<b>ECONOMICS Verification Reports</b>	
EV-A -- Life-Cycle Costing Parameters and Building Component Cost Input Data .....	C.159
<b>ECONOMICS Summary Reports</b>	
ES-A -- Annual Energy and Operations Costs and Savings.....	C.163
ES-B -- Life-Cycle Building and Plant Non-Energy Costs .....	C.165
ES-C -- Energy Savings, Investment Statistics, and Overall Life-Cycle Costs .....	C.167
ES-D -- Energy Cost Summary.....	C.169
ES-E -- Summary of Utility Rate .....	C.171
ES-F -- Block Charges and Ratchet Summary .....	C.175
 <b>APPENDIX D</b>	
WINDOW-4 Glass Layer Library .....	D. 1
 <b>APPENDIX E</b>	
DOE-2 Window Library (Sample Entry).....	E. 1
 <b>APPENDIX F</b>	
Alphabetical List of Commands and Keywords .....	F. 1

## Acknowledgment

In addition to the U.S. Department of Energy, major support for the 2.1E version of DOE-2 was provided by Southern California Edison Company (SCE), Pacific Gas and Electric Company (PG&E), Electric Power Research Institute (EPRI), Gas Research Institute (GRI) [via ElectroCom GARD, Ltd.], Pacific Northwest Laboratory, and the International Energy Agency Solar Heating and Cooling Programme. We thank Gregg Ander of SCE and Michael Wommack of PG&E for initiating the enhancements in DOE-2.1E. The desiccant cooling, engine-driven chiller, and gas-fired absorption chiller models in DOE-2.1D and the integrated desiccant cooling models in DOE-2.1E were developed in collaboration with Robert Henninger of ElectroCom GARD, Ltd., and Douglas Kosar of GRI. The gas heat pump model, PVVT model, and ECONOMICS enhancements in DOE-2.1E were developed in collaboration with Robert Henninger of ElectroCom GARD, Ltd. and Neil Leslie of GRI.

Jeff Hirsch and Steve Gates of Hirsch & Associates, Camarillo, CA, were responsible for development, implementation, and documentation of the following new features in DOE-2.1E: enhancements to the water loop heat pump system, water-cooled condenser option for packaged units, electric and fuel meters, PVVT system, gas heat pumps, and upgraded utility rate structures in ECONOMICS.

The new Window Library and the implementation of the WINDOW-4 heat transfer calculations in DOE-2.1E are the result of a collaboration with D.K. Arasteh, M.S. Reilly, and W.L. Carroll of the LBL Building Technologies Program. The electrochromic glazing entries in the Window Library were prepared by M.D. Rubin, D.L. Hopkins, and E.U. Finlayson of the LBL Building Technologies Program.

Steven D. Gates was the principal consultant for the Plant Cogeneration and the Refrigerated Case Work algorithms in 2.1C.

We also wish to express our appreciation for the work done by Alain Lahellec, Claudine Dangvu, and Robert Franchisseur of the RAMSES Group, University of Paris-South in Orsay, France, on the metrification of DOE-2.1B.

## Introduction

This publication updates the DOE-2 *Supplement* from version 2.1D to version 2.1E. The *Supplement* is a companion volume to the *Reference Manual (2.1A)*. It contains detailed discussions and instructions for using the features and enhancements introduced into the 2.1B, 2.1C, 2.1D, and 2.1E versions of the program. It assumes a working knowledge of the *Reference Manual (2.1A)*, and is not intended for stand-alone use by new users of the program.

Appendix A to this volume is an updated listing of all the DOE-2 hourly report variables. This new listing replaces the three individual lists found in the *Reference Manual (2.1A)* under the HOURLY-REPORT command at the end of LOADS, SYSTEMS, and PLANT.

Appendix C is an updated description of the DOE-2 verification and summary reports. It replaces Chapter VII, Reports, in the *Reference Manual (2.1A)*.

In addition to the *Reference Manual (2.1A)* and this *Supplement (2.1E)*, there are six other DOE-2 manuals that provide information on how to use the program.\*

- |   |   |
|---|---|
| <i>DOE-2 Basics (2.1E)</i>  | is an introduction to using DOE-2.  |
| <i>BDL Summary (2.1E)</i>   | contains an integrated listing of all of the DOE-2 commands and keywords together with their abbreviations, defaults, minimums, and maximums.   |
| <i>Alphabetical List of Commands and Keywords in DOE-2 (2.1E)</i> | gives the page numbers in all the DOE-2 manuals where commands and keywords are described. The list is Appendix F of this manual; also, it is reprinted yearly, with updates and corrections, in the summer issue of the <i>User News**</i> . |
| <i>Sample Run Book (2.1E)</i>                                     | contains input and output examples for a variety of buildings.  |
| <i>Engineers Manual (2.1A)</i>                                    | describes the equations and algorithms used in the DOE-2 calculations.  |
| <i>DOE-2 User News**</i>  | contains articles on building performance modeling, new program features, bug fixes, and documentation ordering information; it also has a directory of DOE-2 related software and services. Issued quarterly.                                |

---

\* DOE-2 program manuals are available from the National Technical Information Service (NTIS), 5285 Port Royal Road, Springfield, VA 22161. Phone (703)487-4650 or Fax (703)321-8547 for prices.

\*\*To be put on the *DOE-2 User News* mailing list, or for more information on obtaining DOE-2 and its documentation, please contact the Simulation Research Group, MS: 90-3147, Lawrence Berkeley Laboratory, Berkeley, CA 94720; Ph: 510-486-5711, Fx: 510-486-4089 or -5172.

## MAKING DOE-2.1D INPUTS COMPATIBLE WITH DOE-2.1E

The 2.1E version is not totally upwardly compatible with 2.1D. This means that in most cases you will get one or more error messages when you run a 2.1D input file with 2.1E. Usually the message will indicate the nature of the incompatibility.

The required input modifications are described in this manual in the "Miscellaneous Changes in 2.1E" sections or in the following BDL, LOADS, SYSTEMS, PLANT, and ECONOMICS sections. The most common modifications you will need to make are:

1. Remove the BUILDING-RESOURCE command from your LOADS input. Building resource quantities in 2.1E are specified with the new keywords INT-FUEL-BTU/HR, etc., in the PLANT-ASSIGNMENT command in SYSTEMS. See "Building Resources in SYSTEMS", p. 3.13ff.
2. Revise your utility rate input in ECONOMICS. The 2.1D ENERGY-COST, CHARGE-ASSIGNMENT and COST-PARAMETERS commands have been replaced in 2.1E with the UTILITY-RATE, BLOCK-CHARGE and RATCHET commands. See "ECONOMICS", p. 5.1ff. In making this transition it will help if you compare the Economics inputs in the 2.1D and 2.1E sample runs.
3. In metric inputs only, the keywords VALUES, TEMP, or RADT are now required in schedule commands depending on whether the schedule values are ratios, temperatures, or radiation quantities. See "Metric Option", p. 1.35ff.
4. In the SYSTEM command, the allowed values of the keywords HEAT-SOURCE, ZONE-HEAT-SOURCE, PREHEAT-SOURCE, and BASEBOARD-SOURCE are now the codewords HOT-WATER, ELECTRIC, FURNACE, GAS-HYDRONIC, HEAT-PUMP, and GAS-HEAT-PUMP. The 2.1D codewords GAS-FURNACE and OIL-FURNACE are no longer used. See "Metering and Reporting of Energy End Uses" on p. 3.4, "Electrical and Fuel Meters in SYSTEMS" on p. 3.8, and "Specifying Meters in SYSTEMS", p. 3.8.
5. The PLANT-PARAMETERS keywords BOILER-FUEL, DHW-HEATER-FUEL, and FURNACE-FUEL have been replaced with the FUEL-METER keyword in PLANT-EQUIPMENT. See "Energy Meters in PLANT", p. 4.3.
6. HOURLY-DATA-SAVE = YES in the LOADS-, SYSTEMS-, and PLANT-REPORT commands (which produced binary files of hourly report output) has been replaced with HOURLY-DATA-SAVE = BINARY. The files that were written, CECDT*n*.BIN, CECPRO.FMT, and CECHR*n*.BIN, have been replaced with HRPLDS*n*.BIN, HRPSYS*n*.BIN, and HRPPLT*n*.BIN. See "Saving Files of Hourly Output for Post Processing", p.1.30.

## HEATING AND COOLING LOAD DIFFERENCES BETWEEN DOE-2.1D AND DOE-2.1E

You will notice a significant difference in loads calculated by 2.1E vs. 2.1D. The heating loads will be 10%-20% lower (depending on building type and climate) and the cooling loads will be 10%-20% higher. The change in loads is due to the following improvements:

- a. A new correlation between outside air film conductance and wind speed gives air film conductances that are two to three times lower than in previous versions of DOE-2. This increases the inward-flowing fraction of solar radiation absorbed by walls, roofs and windows and reduces conduction through windows. See "Improved Outside Air Film Conductance Calculations", p.2.98.
- b. A revision to the calculation of exterior infrared radiation loss to the sky decreases heat loss from windows and walls relative to 2.1D values. See "Improved Exterior Infrared Radiation Loss Calculation", p.2.97.
- c. The wind speed used to calculate outside air film conductance and wind-speed-dependent infiltration is now the weather file wind speed *with corrections for terrain effects, weather station height above ground level, and SPACE height above ground level*. This correction generally gives wind speeds at the building site that are lower than those at the weather station. This results in lower outside air film conductance and lower infiltration rates, both of which tend to decrease heating loads and increase cooling loads. In earlier versions this wind speed correction was applied only to the Sherman-Grimsrud infiltration method. For more details, see "Terrain and Height Modification to Wind Speed", p.2.88.

As evidence that the above improvements are giving accurate loads calculations, Figure A shows that DOE-2.1E predictions are in excellent agreement with measurements of inside air temperature and insolation for three unconditioned test cells. These results are from a recent International Energy Agency study in which the predictions of 25 simulation programs, including DOE-2, were compared with hourly measurements.\* The DOE-2.1E temperatures in Figure A are up to 2°C higher than the corresponding DOE-2.1D values (not shown). This is due primarily to the reduced outside air film conductance in 2.1E.

---

\* "Empirical Validation in International Energy Agency Annex 21/Task 12: Final Report", IEA Report No. IEA21RN372/93, U.K. Building Research Establishment and DeMontfort University (Leicester), August 1993. This was a "blind" validation, i.e., the participants did not know what the measured results were when the simulations were done, so it was impossible to adjust a program's input to match the measurements. The DOE-2 numbers in Figure A are from the public release version of DOE-2.1E (Version 001). This validation study also considered comparisons with measurements on *heated* test cells. DOE-2.1E underpredicted the heating energy for these cells because DOE-2 does not accurately model the electric radiators that were used (the radiators, which are 60% radiative and 40% convective, were modeled as baseboards, which are 100% convective in DOE-2).



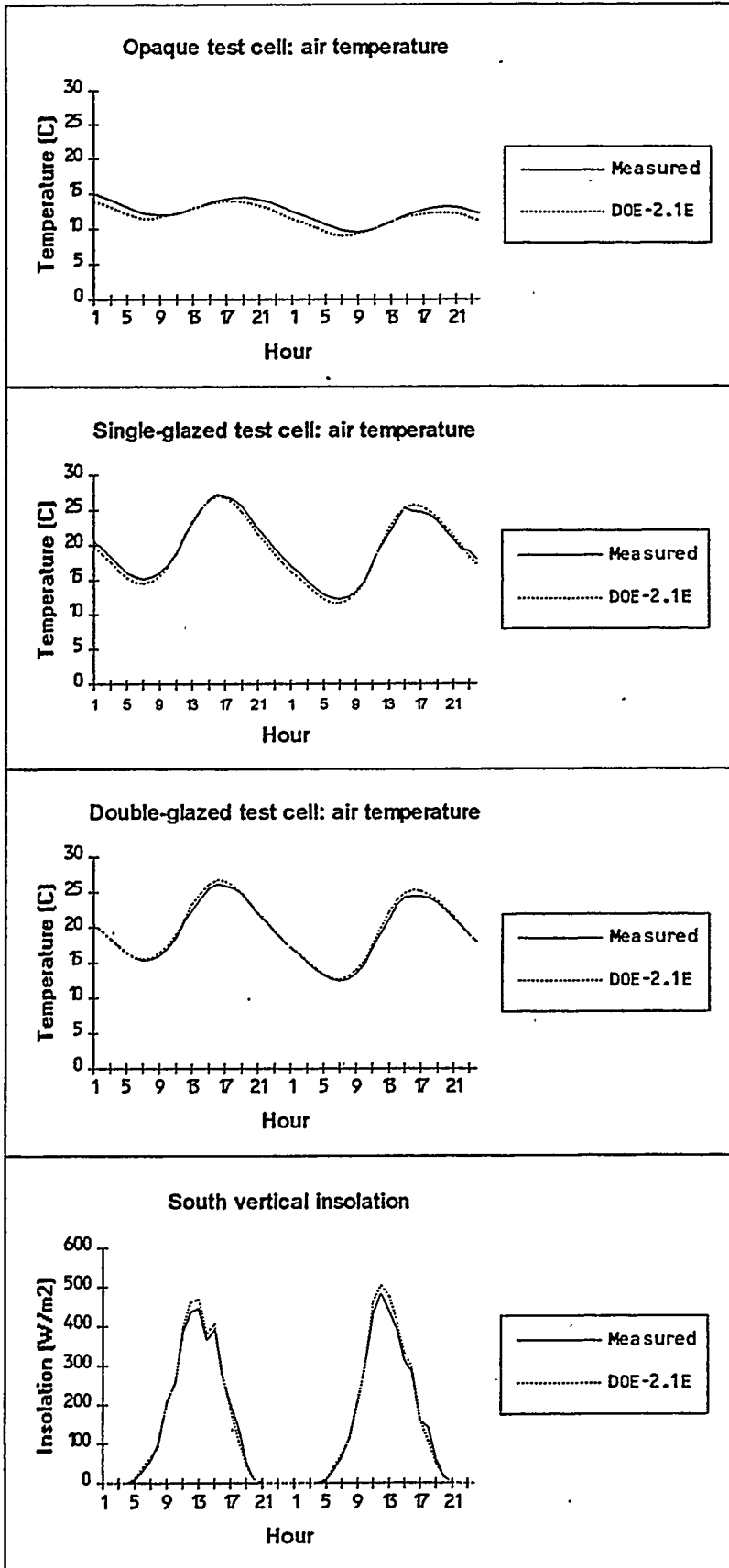

**Figure A:**

Comparison of DOE-2.1E predictions with IEA Annex 21 measurements of inside air temperature in three unconditioned test cells located in England: (1) opaque test cell with no windows, (2) test cell with a south-facing single-glazed window, and (3) test cell with a south-facing double-glazed window. Also shown is the solar radiation intensity (direct plus diffuse) on the south face of the test cells. The cells, which are identical except for the glazing, are 1.5m (width) x 2.4m (depth) x 2.3m (height) and all have insulated wood-frame construction, unconditioned roof space (attic), bare concrete floor above an unconditioned crawl space, zero infiltration, and shading by adjacent structures. In the two-day period shown (May 24-25) the outside temperature varied from 4°C (39°F) to 15°C (59°F) and the wind speed varied from 1.5 m/s (3.4 mph) to 5 m/s (11.4 mph).

## MISCELLANEOUS PROGRAM CHANGES IN VERSIONS 2.1D and 2.1E

*This section summarizes a number of minor changes that have been made in DOE-2 in versions 2.1D and 2.1E. The major changes and additions are described in the remainder of this Supplement.*

### Miscellaneous Changes to BDL in 2.1E

A change was made to the BDL macro processor so that when there are `##if` statements inside a `##def ... ##enddef` block, the `##if` statements become part of the macro definition. They are executed only when the macro is being expanded. In DOE-2.1D the `##if` statements were executed whenever they were encountered in the input.

### Miscellaneous Changes to BDL in 2.1D

- (1) The default for ABORT is now ERRORS instead of CAUTIONS.
- (2) The default for DIAGNOSTIC is now WARNINGS instead of COMMENTS.
- (3) DOE-2 now accepts "tabs" input using your editor. In past versions, the program would give an error message whenever it encountered a tab.
- (4) DOE-2 now accepts both lower and upper case letters in all commands, keywords, values, and symbols. Previously, only upper case letters were permitted. However, as before, *code-words* must still be only upper case. DOE-2 will also accept lower and upper case letters in u-names but will treat the form in which they are entered as unique. For example, a u-name entered as "Zone-1" would not be recognized if it was later referenced as "ZONE-1".

\$ Use of mixed upper and lower case letters \$

Light-1 = schedule through dec 31 (all) (1,24)(.5) ..

Storeroom = SPACE-CONDITIONS \$ u-names and commands can  
\$ be mixed upper and lower case

lighting-schedule = Light-1 \$ u-names must agree  
\$ exactly. LIGHT-1 or  
\$ light-1, e.g., would not  
\$ be recognized here

inf-method = AIR-CHANGE \$ code-words *must* be  
\$ all upper case;  
\$ "air-change" would not  
\$ be recognized

.  
.  
.

## Miscellaneous Changes to LOADS in 2.1E

(1) *The BUILDING-RESOURCE Command*

This command has been removed from LOADS. Building resource quantities, including domestic hot water, are now specified with new keywords in the SYSTEMS PLANT-ASSIGNMENT command (see "Energy End Uses and Meters: Building Resources in SYSTEMS" in the SYSTEMS section of this manual).

(2) *Updated Sample Runs*

The Sample Run inputs in the *Sample Run Book (2.1E)* and on the release tape have been updated to make them more consistent with current practice. Changes include decreasing the lighting watts/ft<sup>2</sup>, increasing the equipment (plug loads) watts/ft<sup>2</sup>, replacing single with double glazing, and increasing the outside air ventilation rate. In addition, some mispositioned surfaces have been corrected.

(3) *Number of LOADS Commands*

The numbers of LOADS commands allowed have been increased as follows:

CONSTRUCTION	: from 32 to 64	SCHEDULE	: from 60 to 100
DAY-SCHEDULE	: from 80 to 300	SPACE	: from 64 to 128
EXTERIOR-WALL	: from 128 to 300	SPACE-CONDITIONS	: from 32 to 50
INTERIOR-WALL	: from 128 to 512	WEEK-SCHEDULE	: from 60 to 200
LAYERS	: from 16 to 64	WINDOW	: from 128 to 200

(4) When PEOPLE-HEAT-GAIN is input in SPACE-CONDITIONS, the program calculates the split between sensible and latent components using a fixed air temperature of 75°F. Previously, this split was calculated at the user-input LOADS calculation temperature.

(5) *The "Warm-Up Period"*

Two changes have been made to the way the "warm-up period" is handled (during the warm-up period, DOE-2 repeats the calculation of the first day of each run period to determine starting values for the simulation). First, all weather variables (outside drybulb, outside wetbulb, etc.) have been "smoothed" around midnight to avoid a discontinuity at midnight. Second, the warm-up period has been increased from 3 days to 7 days to give better starting values for high-mass buildings. These changes were made for LOADS, SYSTEMS, and PLANT.

(6) *OUTSIDE-EMISS Keyword*

A new keyword, OUTSIDE-EMISS, has been introduced in the CONSTRUCTION command. OUTSIDE-EMISS allows you to change the outside surface IR emissivity of EXTERIOR-WALLS and ROOFS. The default is 0.9.

(7) *Daylighting Calculation*

The daylighting calculation was changed so that, for all weather files, exterior illuminance is obtained from irradiance using luminous efficacy. Previously, this was done only for solar weather files (such as TMY and WYEC), i.e., those with measured irradiance. For non-solar weather files (such as TRY), the irradiance and illuminance quantities were calculated separately and, therefore, were not necessarily consistent. Now, the exterior illuminance and irradiance quantities are consistent for both solar and non-solar weather files. [It is still strongly recommended, however, that solar weather files be used for daylighting simulation because they give a more accurate determination of daylight availability.]

(8) *Hourly Reports*

The hourly reports in all program modules incorporate several new features. The REPORT-BLOCK has a new VARIABLE-TYPE = END-USE for the end-uses and meters (see "Energy End Uses and Meters", p.3.4). In each HOURLY-REPORT, the OPTION keyword allows individual reports to be directed to the print file, or output to either a binary or formatted file for interpretation by the user's own programs. (See "Saving Files of Hourly Output for Post Processing", p.1.30). In addition, hourly report data from LOADS can be merged with data in SYSTEMS or PLANT, and hourly report data from SYSTEMS can be merged with data in PLANT. (See "Sharing Hourly Report Data Among Program Modules", p.1.33).

(9) *Fix to Dependence on LOADS Calculation Temperature*

A problem in DOE-2.1D, in which zone temperatures and extraction rates in SYSTEMS were found to be sensitive to the choice of LOADS calculation temperature, has been fixed in 2.1E. As a result, DOE-2.1E now gives a better calculation of temperatures, especially in unconditioned spaces, like attics and plenums beneath roof surfaces, that can undergo large temperature swings.

(10) *Fix to Heat Conduction Through Quick Interior Surfaces*

A bug in DOE-2.1D in which some of the heat conducted through a quick interior surface was lost (i.e., did not appear in the adjacent space) has been fixed. This was only a problem for spaces with Custom Weighting Factors. It was not a problem for delayed interior walls or for spaces with precalculated (ASHRAE) weighting factors.

(11) *Holidays*

The designated holidays are now as follows:

Official National Holidays of the United States	
New Years Day	DEC 31 if a Friday JAN 1 (unless on Saturday or Sunday) JAN 2 if a Monday
Martin Luther King's Birthday	Third Monday in JAN
Presidents Day	Third Monday in FEB
Memorial Day	Last Monday in MAY
Independence Day	JUL 3 if a Friday JUL 4 (unless on Saturday or Sunday) JUL 5 if a Monday
Labor Day	First Monday in SEP
Columbus Day	Second Monday in OCT
Veterans Day	NOV 10 if a Friday NOV 11 (unless on Saturday or Sunday) NOV 12 if a Monday
Thanksgiving	Fourth Thursday in NOV
Christmas	DEC 24 if a Friday DEC 25 (unless on Saturday or Sunday) DEC 26 if a Monday

DOE-2 can calculate holiday loads using different schedules than for normal weekdays. The above holidays will be in effect if HOLIDAY=YES (the default) in the BUILDING-LOCATION command. If HOLIDAY=NO these days are treated as normal weekdays. You can change the holidays to correspond to those in other countries by using the new ALT-HOLIDAYS command. See the *BDL Summary (2.1E)*, p.8.

## Miscellaneous Changes to LOADS in 2.1D

- (1) The number of RUN-PERIODS allowed has been increased from 12 to 15.
- (2) The start and stop dates that the program uses for daylight savings in the U.S. will now be determined by the year of the RUN-PERIOD. For years prior to 1987, the start date will be the last Sunday in April and the end date will be the last Sunday in October. For 1987 and later, the start date will be the first Sunday in April and the end date will remain the last Sunday in October.
- (3) Under SPACE-CONDITIONS we have added a new keyword, AREA/PERSON, which eliminates calculating the NUMBER-OF-PEOPLE for each space.
- (4) The definitions of LOADS hourly report variables #15 and #17 for VARIABLE-TYPE=u-name of WINDOW have changed. The new definitions are as follows:

Variable #15 *Heat gain by solar radiation through window*, is the sum of solar radiation transmitted through the window plus solar radiation absorbed in the window and conducted into the space.

Variable #17 *Conduction heat gain through window*, is  $UA\Delta T$  conduction only — i.e. conduction due to the inside/outside temperature difference across the window. Formerly, window heat gain due to solar radiation absorbed in the window and conducted into the space as included in this variable rather than in variable #15.

This change has **not** been made to the glass loads given in the Summary Reports (LS-B, LS-C, LS-E and LS-F); in these reports, as before, "Glass Conduction" includes solar absorbed in the glass and conducted into the space, and "Glass Solar" is transmitted solar only.

- (5) The inputs for internal heat gains allowed for UNCONDITIONED and PLENUM spaces need to be clarified:

All SPACE-CONDITIONS keywords are allowed in *both* UNCONDITIONED and PLENUM spaces.

See "Miscellaneous Changes to SYSTEMS in 2.1D" for SYSTEMS keywords that are applicable to UNCONDITIONED and PLENUM zones.

## Miscellaneous Changes to SYSTEMS in 2.1E

(1) *Rounding of Air Flows Removed*

Rounding of air flows calculated by DOE-2 to the nearest 10 CFM has been removed. This change is most noticeable on the SV-A verification report for outside ventilation air when input using the keyword OA-CFM/PER, and also for the reported calculated values of supply and return CFMs at the zone and system levels.

(2) *Number of SYSTEMS Commands*

The number of SYSTEMS commands allowed have been increased as follows:

DAY-RESET-SCH	: from 60 to 300	SYSTEM-FANS	: from 20 to 50
DAY-SCHEDULE	: from 80 to 300	SYSTEM-FLUID	: from 20 to 50
RESET-SCHEDULE	: from 40 to 100	SYSTEM-TERMINAL	: from 20 to 50
SCHEDULE	: from 60 to 100	WEEK-SCHEDULE	: from 60 to 200
SYSTEM	: from 40 to 100	ZONE	: from 64 to 128
SYSTEM-AIR	: from 20 to 50	ZONE-AIR	: from 20 to 50
SYSTEM-CONTROL	: from 20 to 50	ZONE-CONTROL	: from 20 to 50
SYSTEM-EQUIPMENT	: from 20 to 50	ZONE-FANS	: from 20 to 50

(3) *OUTSIDE-FAN-ELEC replaces OUTSIDE-FAN-KW*

The OUTSIDE-FAN-KW keyword has been replaced with OUTSIDE-FAN-ELEC. The new keyword has the same meaning: it provides the electric consumption of the condenser fan (or unit) when it is operational. The value is specified as watts of electric consumption per BTU of cooling system output at ARI conditions (value specified or calculated for COOLING-CAPACITY) where as the old keyword was simply the kW of the fan.

(4) *For SYSTEM-TYPEs PMZS, PVAVS, and PVVT*

The default for MIN-HGB-RATIO has been changed from 0.25 to 0.0. This is to allow a default simulation of compressor(s) that have been equipped with "hot gas bypass" or a similar feature that allows the compressor to continue to run, rather than cycle, at low loading points. This simulation causes the compressor power to be held at the PLR=.25 point on the curve COOL-EIR-FPLR all hours the load on the unit is less than 25% of the operating capacity. This is done in situations where stable space temperature control is desired. The values of MIN-UNLOAD-RATIO and MIN-HGB-RATIO should be adjusted to agree with the arrangement of equipment that is installed (or contemplated) in the building.

## Miscellaneous Changes to SYSTEMS in 2.1D

- (1) The keywords in SYSTEMS that apply to UNCONDITIONED and PLENUM zones are as follows:

Keyword	UNCONDITIONED	PLENUM
BASEBOARD-CTRL	NO	YES
BASEBOARD-RATING	NO	YES
COOL-TEMP-SCH	NO	YES
DESIGN-COOL-T	YES	YES
DESIGN-HEAT-T	YES	YES
EXHAUST-CFM	NO	YES
HEAT-TEMP-SCH	NO	YES
MULTIPLIER	YES	YES
SIZING-OPTION	YES	YES
THROTTLING-RANGE	NO	YES
ZONE-FAN-CFM	NO	YES
Residential Ventilation Keywords	YES	YES

- (2) *Peak Integrated Cooling Load*

Report SS-J now shows the *peak integrated cooling load for a 24-hour period* as well as the day of the year that it occurs (which may not be the same day as the peak one-hour cooling load). This 24-hour integrated value should be of help in sizing thermal energy storage systems. One word of caution, however: the user should still look to see if there are hours of "loads not met", and if there are, increase the capacity of the system until they are minimized.

- (3) *Change in SIZING-OPTION Default*

The default for SIZING-OPTION for ALL system types is now NON-COINCIDENT. The reason for this change is the substantial reduction in lighting levels and better window treatment that most designers use today. When automatic sizing is done in DOE-2 SYSTEMS, the low peak sensible loads cause air flows that are so low that DOE-2 reports many hours of "loads not met". Most inexperienced users cannot understand why DOE-2 gives these unexpected results, and the problem is only exacerbated when using SIZING-OPTION = COINCIDENT. If the number of hours with "loads not met" is still too high with SIZING-OPTION = NON-COINCIDENT, the user should increase air-side system capacity by setting SIZING-RATIO greater than 1.0.

- (4) *RETURN-AIR-PATH Defaults*

The default RETURN-AIR-PATH = DIRECT for system types SZRH, MZS, TPIU, FPIU, HVSYS, and PZS remains as before. However, all systems that normally pick up heat gain from return air light fixtures now default to RETURN-AIR-PATH = DUCT.



## Miscellaneous Changes to PLANT in 2.1E

### (1) *Component-Based Ice-on-Coil Model Removed*

The CBS/ICE component-based ice-on-coil thermal energy storage model has been removed from the 2.1E PLANT program. It has been replaced by a new model that simulates ice-on-coil and other types of cool storage systems. See "Ice and Eutectic Thermal Energy Storage", p.4.15.

CBS/ICE is now available as a stand-alone program called ICICLE, which can be obtained from the Center for Energy Studies, University of Texas at Austin, Balcones Research Center, 10100 Burnet Road, Austin, TX 78758.

## Miscellaneous Changes to PLANT in 2.1D

### (1) *Energy Cost Calculation moved to ECONOMICS*

The DOE-2.1C version of PLANT was substantially upgraded to include (1) the allocation of loads to electrical generators and chillers for cogeneration, (2) simpler functional forms for the input/output relationships of these generators, and (3) variable-speed, optionally-sized pumps. The calculation of energy costs has been shifted from PLANT to ECONOMICS so that income from the sale of electricity produced by on-site generators is now possible. The PLANT routine now creates a file of 8760 hours of energy use and ECONOMICS reads this file to calculate energy costs that involve time-of-day and ratcheted demand charges. See, p.5.1, "Expanded Treatment of Energy Costs".

### (2) *Control of Electrical Generators*

The DOE-2.1C options for the control of electrical generators are an extension of the work described in the documentation of DOE-2.1B. The keywords and techniques for invoking the 2.1B options (i.e. ELEC-GEN-MODE and the use of negative NUMBERS in a LOAD-ASSIGNMENT) have been eliminated.

## Miscellaneous Changes to ECONOMICS in 2.1E

The energy cost calculation (ECONOMICS) subprogram in 2.1E has been completely revised to handle a wider range of utility rate structures. The rate structure input in 2.1E differs from earlier versions of the program, including 2.1D. Therefore, you will have to redo your old inputs to make them compatible with 2.1E. See the ECONOMICS section starting on p.5.1.

## Miscellaneous Changes to REPORTS in 2.1E

### (1) *Report Revisions*

The following revisions to existing reports have been made (see Appendix C):

- LV-H now reports window frame area and U-value.
- SS-J now reports numerous designer's check figures. The changes are described in "Additions to Systems Report SS-J", p.3.139.  
The results of DESIGN-DAY sizing in SYSTEMS is now summarized in report SS-J, System Peak Heating and Cooling Days (DESIGN-DAY). See "Additions to Systems Report SS-J", p.3.139.
- SS-D now reports the integrated daily cooling load that results from either a weather tape run or a DESIGN-DAY run.
- PV-A now reports both COOL-STORE-RATE and COOL-SUPPLY-RATE when the program calculates these numbers in the thermal energy storage automatic sizing routines.
- PS-B now reports energy use by meter (up to five different electricity meters and five different fuel meters).
- PS-C now reports the calculated energy use of the cooling tower fan and of the condenser water pump. When an air cooled condenser is simulated only the fan energy is reported. PS-C now reports electrical consumption in kWh rather than Btu.
- PS-D now reports electrical consumption in kWh rather than Btu.

### (2) *New Reports*

The following new reports are generated (see Appendix C):

- SS-P "Load, Energy, and Part-Load Heating and Cooling" for PSZ, PVAVS, RESYS and PTAC systems.
- SS-Q "Heat Pump Cooling and Heating Summary" for PSZ, PVAVS, RESYS and PTAC systems.
- SUPL "System Supplemental Evaporative or Desiccant Cooling"

PS-E "Monthly Energy End Use Summary"  
PS-F "Energy Resource Peak Breakdown by End Use"  
BEPU "Building Energy Performance Summary (Utility Units)"

(3) *Revised ECONOMICS Reports*

ECONOMICS reports ES-D, ES-E and ES-F have been replaced with the following new reports (see Appendix C):

ES-D: "Energy Cost Summary" summarizes the yearly energy consumption and cost for each UTILITY-RATE.

ES-E: "Summary of Utility-Rate <u-name>" summarizes the key costs by month for each utility rate.

ES-F: "Block Charges and Ratchet Summary for <u-name>" summarizes, for each UTILITY-RATE, the monthly costs associated with each BLOCK-CHARGE, and the monthly RATCHET values.

(4) *Suppressing ZONE Reports in SYSTEMS*

It is possible in 2.1E to suppress ZONE reports if desired. The input is done in SYSTEMS at each individual ZONE input using the keyword REPORT=YES (which is the default) or NO which suppresses all reports for that ZONE.

References to past versions of DOE-2, e.g. DOE-2.1D, apply to that version and all later versions, unless otherwise stated. Where such specific references are made, it is to indicate to the user the program version in which a new feature first appeared.

# BUILDING DESCRIPTION LANGUAGE

## Table of Contents

---

<b>INPUT FUNCTIONS IN LOADS AND SYSTEMS</b> .....	1.3
Introduction .....	1.3
Commands and Keywords for Input Functions.....	1.4
Hourly Report Variables.....	1.10
Tabs .....	1.10
Valid FORTRAN Statements and Operations .....	1.11
Reading From and Writing To Files.....	1.13
Loads Input Function Examples.....	1.14
1: Print Solar Radiation and Surface Temperature.....	1.14
2: Hypothetical Ventilation System.....	1.15
3: Outside Film Heat Transfer Coefficient .....	1.16
4: Using Measured Daylight Factors .....	1.17
5: Looping Logic .....	1.19
6: Variable Shading Coefficient .....	1.21
7: Reading Measured Schedule Values from a File.....	1.23
Systems Input Function Examples .....	1.25
1: Cold-Deck Supply Air Temperature Reset.....	1.25
2: Drybulb Economizer .....	1.27
3: Enthalpy Economizer .....	1.28
<b>HOURLY REPORT FREQUENCIES AND SUMMARIES</b> .....	1.29
<b>SAVING FILES OF HOURLY OUTPUT FOR POSTPROCESSING..</b>	1.30
<b>SHARING HOURLY REPORT DATA AMONG</b> <b>  PROGRAM MODULES</b> .....	1.33
<b>METRIC OPTION</b> .....	1.35
Introduction .....	1.35
Units Table (Excerpt from LOADS Report LV-M).....	1.36
Invoking the Metric Option .....	1.37
Materials and Construction Library .....	1.37
Basic Units.....	1.38
Keyword Synonyms for the Metric Option.....	1.38
Keyword Limits in the Metric Option.....	1.38
DAY-SCHEDULES in the Metric Option .....	1.39
DAY-RESET-SCHEDULES in the Metric Option .....	1.40
Residential Infiltration in Metric Input .....	1.40
Reporting Fuel Use in Metric Units.....	1.40
Exceptions.....	1.41
Weather Files .....	1.41
<b>INPUT MACROS AND GENERAL LIBRARY FEATURES</b> .....	1.42
Input Macros.....	1.42

Incorporating External Files.....	1.42
Selectively Accepting or Skipping Lines of Input.....	1.44
Defining Blocks of Input.....	1.46
Arithmetic Operations.....	1.49
Macro Debugging and Listing Control.....	1.50
<b>Listing Format</b> .....	1.54
<b>Library Example</b> .....	1.55
DOE-2 Input and "include" Files.....	1.55
DOE-2 Output File.....	1.62

# INPUT FUNCTIONS IN LOADS AND SYSTEMS

## Introduction

The Input Function feature (also called "functional values" feature) allows you to modify DOE-2 LOADS or SYSTEMS calculations without recompiling the program.

**This feature is entirely optional; because it requires familiarity with the internal calculations in DOE-2, it should not be attempted by the beginning user.**

There are three types of applications of Input Functions:

- 1) Calculation of variables that influence the program results, thus allowing you to modify or replace the algorithms used by the program without recompiling the program.
- 2) Calculation of variables for reporting or debugging purposes.
- 3) Reading in data files for use in the simulation.

Input Functions are input as small, FORTRAN-like routines that are included in your regular building description. You specify the values to be calculated and where in the hourly simulation they are to be used.

To use Input Functions, you must have access to the LOADS and SYSTEMS simulation variables, their definitions, and the locations of the final calculation of their values. To assist you in using Input Functions, we give flowcharts in Appendix B that show the calculational sequence and looping structure of LOADS and SYSTEMS. Note that not all of the LOADS and SYSTEMS subroutines are accessible. For the exact location of function access points, consult the Compiler Listing, described below, and look for CALLs to subroutine FINTL in LOADS and subroutine FINTS in SYSTEMS. To determine the location and method of calculation of accessible variables, the flowcharts should be used in conjunction with

- 1) the *LOADS and SYSTEMS Global Variables Listings*, which list and define the DOE-2 internal variables that are accessible to functions,
- 2) the *Cross-Reference Listing of LOADS and SYSTEMS Global Variables*, which shows where in each subroutine a variable is used or set,
- 3) the *Compiler Listing of Subroutines That Contain Function Access Points*, to determine the location and method of calculation of accessible variables, and
- 4) the *Subroutine Call Tree*, which shows the Subroutines called by each routine.

These four listings are available as print files on the program tape; they reside on File 28, LDSDOC.SRC, and File 29, SYSDOC.SRC. Print out these files if you plan to use Input Functions. *These tools are essential to the use of the feature; if you do not fully understand the calculation sequence in DOE-2, it is very easy to enter functions that change the DOE-2 results in unexpected ways.* See also the LOADS and SYSTEMS sections of the *Engineers Manual (2.1A)* for detailed algorithm descriptions.

Functions are referenced within the hourly loop of the program and, therefore, will be calculated each hour of the input run period.

### Commands and Keywords for Input Functions

The commands and keywords associated with functional values are described below. The input sequence (for a function that modifies a window calculation in LOADS) looks like:

INPUT LOADS ..

:

W-1 = WINDOW

:

FUNCTION=(*\*NONE\**,*\*FNW-1\**) .. *Invoke function calculation for this window*

:

END ..

:

FUNCTION NAME=*FNW-1* ..

ASSIGN

*assign variable names*

..

CALCULATE ..

*FORTRAN-like routine*

END-FUNCTION ..

COMPUTE LOADS ..

Before reading the following descriptions it will be helpful to briefly review the LOADS and SYSTEMS input function examples at the end of this section. Additional examples can be found in the *Sample Run Book (2.1E)* in the Medical Building and Daylighting sample runs.

### FUNCTION

FUNCTION tells LOADS or SYSTEMS that the data to follow specify the characteristics of a function. Allowable number of FUNCTIONS is 100. Note: FUNCTIONS must be specified after the END command and before the COMPUTE LOADS or COMPUTE SYSTEMS command.

NAME specifies a unique user-assigned name for the function (up to 16 alphanumeric characters).

FUNCTION is also used as a *keyword* in LOADS for the BUILDING-LOCATION, SPACE, EXTERIOR-WALL, DOOR, WINDOW, and UNDERGROUND-WALL commands, and in SYSTEMS for the ZONE, SYSTEM and PLANT-ASSIGNMENT commands:



BUILDING-LOCATION, SPACE, EXTERIOR-WALL, DOOR, WINDOW,  
UNDERGROUND-WALL, ZONE, SYSTEM, PLANT-ASSIGNMENT

FUNCTION

takes two arguments: \*u-name1\* and \*u-name2\*. Assigning u-name1 means that the calculation of the function with NAME = u-name1 will be done *before* the execution of the subroutine associated with the function (see LOADS, Example 3, p.1.16). Assigning u-name2 means that the calculation of the function with NAME = u-name2 will be done *after* the subroutine's execution (see LOADS, Example 1, p.1.14). If both u-names are assigned, the function with u-name1 will be calculated before, and the function with u-name2 will be calculated after the subroutine's execution (see LOADS, Example 6, p.1.21). If only one argument is specified; the other must be entered as \*NONE\*. The FUNCTION keyword can be used at most *once* in each command.

Examples:

FUNCTION = (\*SPXX\*,\*NONE\*),  
FUNCTION = (\*NONE\*,\*FNEW2\*),  
FUNCTION = (\*FNEW1\*,\*FNEW2\*).

There are four optional keywords for special-use functions in LOADS:

BUILDING-LOCATION

DAYL-FUNCTION

is the special function executed in LOADS subroutine DEXTIL. This subroutine determines the hourly exterior horizontal illuminance for the daylighting simulation.

SPACE

DAYL-ILLUM-FN

is the special function executed in LOADS subroutine DINTIL. This subroutine determines the hourly daylight illuminance and glare index at each reference point in a space (see LOADS Example 4, p.1.17).

DAYL-LTCTRL-FN

is the special function executed in LOADS subroutine DLTSYS. This subroutine determines the electric lighting reduction in response to daylight illuminance at each reference point in a space (see the Daylighting Example in the *Sample Run Book (2.1E)*).

WINDOW

WINDOW-SPEC-FN

is the special function used in LOADS subroutines CALWIN, DCOF, DINTIL, and DREFLT. This function is used to alter variables involved in the daylighting calculation.

WINDOW-SPEC-FN takes only *one* u-name, surrounded by asterisks, but without parentheses.

For example: WINDOW-SPEC-FN = \*WINFN-1\*

The following command allows functions to be executed in user-specified subroutines in the SYSTEMS program:

### SUBR-FUNCTIONS

tells SYSTEMS in which subroutines a function calculation is to be performed.

The SUBR-FUNCTIONS command has the following keywords:

BERNOU-1	DOUBLE-1	HVUNIT-1Z	SUM-3Z
CFMINF-0	EBAL-0	HVUNIT-2	SUM-4Z
CFMINF-1	EBAL-1	HVUNIT-3	SUM-5
CONCHN	ECONO-1	INDUC-0	SZCI-0
DAYCLS-1	ECONO-2	INDUC-1Z	SZCI-1Z
DAYCLS-2	ECONO-3	INDUC-2	SZCI-2
DAYCLS-3	ECONO-4	OPSTRT	TDVPIU-0
DAYCLS-4	FANPWR	PANEL-0Z	TDVPIU-1
DAYCLS-5	FCOIL-0	PANEL-1	TEMDEV-0
DAYCLS-6	FCOIL-1Z	PIU-0	TEMDEV-1
DDSF-0	FCOIL-2Z	PIU-1	TEMDEV-2
DDSF-1	FCOIL-3	PTAC-0	TEMDEV-3
DESFO-0	FTDEV	PTAC-1Z	TSOLVE-0
DESFO-1	FNSYS1-1	PTAC-2	TSOLVE-1
DESIGN	FNSYS1-2Z	RESYS-0	UNITH-0
DESIND-0	FNSYS1-3Z	RESYS-1Z	UNITH-1Z
DESIND-1	FNSYS1-4Z	RESYS-2Z	UNITH-2Z
DESPIU-0	FNSYS1-5	RESYS-3Z	UNITH-3
DESPIU-1	FURNAC	RESYS-4Z	UNITV-0
DKTEMP-0	HE	RESYS-5	UNITV-1Z
DKTEMP-1	HOURIN	SDSF-0	UNITV-2
DKTEMP-2	HPUNIT	SDSF-1	VARVOL-0
DKTEMP-3	HTPUMP-0Z	SSBASB	VARVOL-1Z
DOETRM-0	HTPUMP-1Z	SSFCOR	VARVOL-2
DOETRM-1	HTPUMP-2	SUM-1	VARVOL-3
DOUBLE-0	HVUNIT-0	SUM-2Z	

These keywords are named after SYSTEMS subroutines. They take only *one* u-name (that of a function) surrounded by asterisks, but without parentheses.  
 Example: RESYS-1Z = \*RESFN-1\*

**Example:**

```
INPUT SYSTEMS ..
.
.
SUBR-FUNCTIONS  FCOIL-0  =  *FN0*
                 FCOIL-1Z =  *FN1*
                 FCOIL-3  =  *FN3* ..
.
.
END ..

FUNCTION  NAME  =  FN0
.
.
END-FUNCTION ..
FUNCTION  NAME  =  FN1
.
.
END-FUNCTION ..
FUNCTION  NAME  =  FN3
.
.
END-FUNCTION ..
COMPUTE SYSTEMS ..
```

**ASSIGN**

Variables used within the function are declared through the use of the ASSIGN command. These assignments are made through the definition of (a) *local variable names* (1- to 7-character names chosen by the user) or (b) *table variable names*.

(a) A *local variable name* may be one of the following:

(1) a simulation variable from the Global Variables Listing, which contains variables used in the DOE-2 LOADS and SYSTEMS programs. For example, in ASSIGN WS=WNDSPD, WS is the local variable name chosen by the user and WNDSPD is the simulation variable, selected from the Global Variables Listing, corresponding to windspeed. Note that your local variable name can be the same as the global variable name; e.g., ASSIGN .WNDSPD=WNDSPD is allowed

The simulation variables have English units even in runs with metric input. The units are shown in the Global Variables Listing. Your function can be done in metric units but, in your function, you will have to (1) convert any simulation variables you use from English to metric, and (2) convert function results from metric back to English. For an example of this, see LOADS Example 3, p.1.16.

(2) a numeric value. For example, ASSIGN WS=12.0. Exponential notation can be used for small numbers; example: ASSIGN SIGMA=0.1714E-8.

- (3) a previously defined PARAMETER name that is set equal to a numeric constant. Example:

```
PARAMETER SPEED=12.0 ..
```

```
·  
·
```

```
ASSIGN WS = SPEED ..
```

```
·  
·
```

- (4) a macro expansion that results in a numeric constant. Example:

```
##set1 Altitude 567
```

```
·  
BUILDING-LOCATION Altitude=Altitude[ ]
```

```
·  
·  
ASSIGN ALT=Altitude[ ] ..
```

```
·  
·
```

- (5) the quantity "SCHEDULE-NAME (u-name of a previously defined schedule)". In this case, for the date and hour in question, the schedule value will be used within the function. This overwrites the value in the original SCHEDULE for that hour for the rest of the run. For example,

```
PEOP1 = SCHEDULE (.....) ..
```

```
·  
·
```

```
SOUTH = SPACE PEOPLE-SCHEDULE = PEOP1  
FUNCTION = (*SPXX*,*NONE*)
```

```
·  
·
```

```
·  
· ..  
END ..
```

```
FUNCTION NAME = SPXX ..
```

```
ASSIGN Y = SCHEDULE-NAME(PEOP1) ..
```

```
·  
·
```

- (6) the quantity SCHEDULE (global variable name), where "global variable name" is the pointer name (found in the Global Variables Listing) that corresponds to a previously defined SCHEDULE. The schedule value for the hour in question will be used (without overwriting the original value). Changing the example above, the input would be:

```
ASSIGN Y = SCHEDULE(KZPPL) ..
```

- (7) a previously-defined PARAMETER name that is set equal to the u-name of a schedule. The schedule value for the hour in question will be used. For example,

```

PARAMETER   VTMULT = TVIS-SCH-1  ..
           .
           .
TVIS-SCH-1  =   SCHEDULE   THRU DEC 31 (ALL)(1,24)(.35)  ..
           .
           .
WINDOW      VIS-TRANS-SCH = TVIS-SCH-1
           FUNCTION = (*WINXX*,*NONE*)
           .
           .
END  ..

FUNCTION   NAME = WINXX  ..
ASSIGN    Y = SCHEDULE-NAME(VTMULT)  ..

```

- (b) A *table variable name* takes values associated with the piecewise linear interpolation of curves defined through the keyword TABLE (see the following example).

TABLE                      This keyword specifies x-y pairs of data points which define a curve that is to be piecewise linearly interpolated to enable the calculation of y-values, given x-values in the function. The x-values should be in increasing order. There is no limit on the number of pairs which define the curve. Also, each TABLE keyword should have its own ASSIGN command. Mixing of TABLE and the other ASSIGN forms is not permitted. The x-y arguments can be defined through the use of the DOE-2 PARAMETER technique if desired.

In the CALCULATE section of a FUNCTION, the utility routine PWL returns the y-value of the piecewise linear curve given the x-value and the table variable name, as shown in the following example. Here, the table variable name is "TAB1".

```

FUNCTION   NAME = FN-1  ..
ASSIGN    X1 = simulation variable from Global Variables Listing  ..
ASSIGN    TAB1 = TABLE (0.,10) (.2,20) (.4,30)
           (.6,36) (.8,38) (1.0,40)  ..
           .
           .
CALCULATE ..
           Y1 = PWL(TAB1,X1)
           .
           .
           END
END-FUNCTION  ..

```

-----+-----1-----+-----2-----+-----3-----+-----4-----+-----5-----+-----6-----+

In this function, the value of Y1 is determined from the value of X1 by linear interpolation between the points (0.,10), (.2,20), etc., defined by TABLE. For example, if  $X1 = 0.1$ , then  $Y1 = 15$ . (If X1 is outside the range of x-values in TABLE, PWL linearly extrapolates to get the corresponding Y1 value.) See LOADS Example 4, p.1.17, for another example of using TABLE.

## CALCULATE

The CALCULATE command informs LOADS or SYSTEMS that the following statements, which are written in a pseudo-FORTRAN language, are to be used to define the function. The valid FORTRAN declarative and executable statements and operations are given in Table 1.1. Also presented is a subprogram called PWL that performs the piecewise linear interpolation discussed above under the TABLE keyword.

All statements following the CALCULATE command must begin in or after column 7, except for statement numbers which begin in column 1. Column 6 is used to designate the continuation of a statement, as in standard FORTRAN. The executable statement END terminates the CALCULATE section and must be present. (Note that this is *not* the same as the "END .." command that terminates LOADS, SYSTEMS, PLANT and ECONOMICS input.)

Variables used in the FUNCTION are all classified as real; other types do not exist. Integers may be used, but they will be treated as real.

## END-FUNCTION

This command informs the LOADS or SYSTEMS program that the function definition is complete.

### **Hourly Report Variables**

From the Compiler Listing you can determine whether a function that changes the value of an hourly report variable makes this change before or after DOE-2 places the variable in the hourly report array for printing each hour. *Only if your function changes the hourly report variable before it is put in the printing array will your change be reflected in the hourly report.* See Appendix A, "Hourly Report Variable Listing", for the FORTRAN name of the hourly report variables.

Note that by using PRINT or WRITE statements you can print out the values of variables directly from your function, thus bypassing the hourly reports. See LOADS Example 1, p.1.14. It is always a good idea to print out key variables in this way to be sure that your function is performing the way you expect.

### **Tabs**

Tabs should **not** be used in DOE-2 functions, otherwise an error message will result.

## Valid FORTRAN Statements and Operations

---

*Arithmetic Operators*            +, -, /, \*, \*\*, =, (, )

---

*Logical Operators*            OR, AND, NOT, EQ, NE, GT, GE, LT, LE

---

<i>Executable Statements</i>	CONTINUE	GO TO	RETURN
	END	IF	REWIND
	ENDFILE	PRINT	STOP <sup>(2)</sup>
		READ <sup>(1)</sup>	WRITE <sup>(3)</sup>

(1) unformatted or formatted

(2) For debugging only; program stops execution without printing reports

(3) unformatted or formatted

---

<i>Declarative Statements</i>	FORMAT	SUBROUTINE
-------------------------------	--------	------------

---

<i>Standard Functions</i>	ABS ( x )	AMIN ( x1, x2 )	EXP ( x )
	ALOG ( x )	AMOD ( x1, x2 )	INT ( x )
	ALOG10 ( x )	ATAN ( x )	SIN ( x )
	AMAX ( x1, x2 )	COS ( x )	SQRT ( x )

---

### *Library Functions*

ACCESS ( ixaa )            :    ACCESS( ixaa ) returns the value of AA(ixaa) from the program's blank common array.

GET( v, i )                :    GET returns the value of v(i), where v is assigned to a global variable that is dimensioned.

GETAA ( naa )             :    IX = GETAA( NAA ) gets a block of memory ( of NAA words ) in the program's main blank common array ( the AA, or IA array ) for exclusive use by functions, and IX is set to the value pointing to the beginning of the block. Any value can be stored inside this block by using

XX = STORE( XX, IX+ccc )

or

XX = ISTORE( XX, IX+ccc )

and may be retrieved by using

XX = ACCESS( IX+ccc )

or

XX = IACCESS( IX+ccc )

where  $0 \leq ccc \leq N-1$ .

GETI( v, i )	:	Like GET(), however the global variable is an integer.
H ( dbt, humrat, press )	:	returns specific enthalpy (Btu/lb) of air as a function of drybulb temperature (F), humidity ratio (lb-water/lb-air), pressure (in-Hg).
IACCESS ( ixia )	:	like ACCESS but returns IA(ixia).
ISTORE ( val, ixia )	:	X = ISTORE( X, IXIA ) will convert the value of X into integer and then store it at IA(ixia) in the program's blank common array.
PUT( x, v, i )	:	X = PUT( X, V, I ) will store the value of X into V(I), where V is assigned to a global variable that is dimensioned.
PUTI( x, v, i )	:	PUTI is like PUT(), however the global variable is an integer.
PWL ( table, x )	:	Piecewise linear interpolation function.
RAND ( 0 )	:	RAND( 0 ) returns a random number in the range [0,1].
RHFUNC ( dbt, humrat, press )	:	returns relative humidity (%) as a function of drybulb temperature (F), humidity ratio (lb-water/lb-air), and pressure (in-Hg)
STORE ( val, ixaa )	:	X = STORE( X, IXIA ) will store the value of X at AA(ixaa) in the program's blank common array.
V ( dbt, humrat )	:	returns specific volume of air (lb/cuft) as a function of drybulb temperature (F), humidity and humidity ratio (lb-water/lb-air).
WBFS ( dbt, humrat, press )	:	returns wetbulb temperature (F) as a function of drybulb temperature (F), humidity ratio (lb-water/lb-air), and pressure (in-Hg).
WFUNC ( dbt, RelHum, press )	:	returns humidity ratio (lb-water/lb-air) as a function of drybulb temperature (F), relative humidity (%), and pressure (in-Hg).

---

**Note : the following library function is available only in SYSTEMS functions.**

CVAL ( MC , x, y )	:	evaluates the curve stored in the curve block pointed to by MC; x and y are the independent variables of the curve.
--------------------	---	---

---



## Reading From and Writing To Files

FORTRAN I/O statements can be used inside functions to read values from files, or to write files for special reports and debugging. Both binary I/O and formatted I/O are supported.

The following FORTRAN I/O statements can be used:

PRINT <format number>, var1, var2, ...

This writes to the OUTPUT file.

WRITE( <unit number>, <format number> ) var1, var2, ...

Writes to FORTRAN unit number, using formatted I/O.

WRITE( <unit number> ) var1, var2, ...

Same as previous but uses unformatted I/O.

READ( <unit number>, <format number> ) var1, var2, ...

Reads from FORTRAN unit number, using formatted I/O.

READ( <unit number> ) var1, var2, ...

Same as previous but uses unformatted I/O.

REWIND <unit number>

Rewinds FORTRAN unit number.

ENDFILE <unit number>

Terminates write to FORTRAN unit number.

<unit number> is the integer FORTRAN unit number within the range acceptable by the operating system and/or compiler. However, 1 through 40 are reserved by DOE-2 and, therefore, should NOT be used by user functions.

<format number> corresponds to the statement number of the FORMAT statement that is inside the function. Note that the FORMAT statement must not contain Ixx edit descriptors (e.g., I10) since all variables inside functions are REAL.

Because the DOE-2 functions do not support the OPEN statement, the filename corresponding to the unit number is assigned by the operating system and/or compiler. For example, "READ(50) X,Y" will read from the file named "fort.50" in UNIX systems, or "FOR050.DAT" in VAX-VMS systems. (Check your system or compiler manual to determine the naming convention.) Correspondingly, "WRITE(60) U,V" will write to "fort.60" in UNIX or "FOR060.DAT" in VAX-VMS. As a result, you will have to change the command file that runs DOE-2 so that (1) it copies your input file to a file named "fort.50" in the directory in which DOE-2 is running (assuming a UNIX system), and (2) it saves the output file by copying "fort.60" to a file named by you.

For an example of using Input Functions to read files, see LOADS Example 7: Reading Measured Schedule Values from Files, p.1.23.

## LOADS Input Function Examples

### LOADS Example 1: Print Solar Radiation and Surface Temperature.

This function prints out the incident solar radiation and outside surface temperature of an exterior wall.

EW1 = EXTERIOR-WALL

```
      .                               Applicable
      .                               Exterior Wall
      .
```

FUNCTION = (\*NONE\*, \*FNEW1\*) ..

```
 .
 .
 .
```

END ..

FUNCTION NAME = FNEW1 ..

ASSIGN

```
    QI = SOLI
    TO = T    ..
```

CALCULATE ..

(Note: Begin the FUNCTION statements in column 7 or later)

```
    PRINT 100, QI, TO
100  FORMAT(1H ,2F12.3)
    END                               (required)
```

END-FUNCTION ..

COMPUTE LOADS ..

-----+-----1-----+-----2-----+-----3-----+-----4-----+-----5-----+-----6-----+

## LOADS Example 2: Hypothetical Ventilation System

This function models a hypothetical ventilation system in which the infiltration airflow through a window is adjusted each hour to cancel the solar and conduction heat gain through the window.

```
WINDOW-1 = WINDOW
          .
          .
          .
          FUNCTION = (*NONE*, *FNWIN1*) ..
          .
          .
          .
          END ..
          FUNCTION NAME = FNWIN1 ..
          ASSIGN
            TO = DBTR $outside drybulb temperature (R)
            TS = TZONER $zone temperature (R)
            PR = PATM $atmospheric pressure
            QS = QSOLG $solar gain through window
            QC = QCON $heat conduction through window
            CI = CFMW .. $window infiltration, CFM
          CALCULATE ..
          C Add solar gain and conductance through window
            X = QS + QC
          C If solar plus conduction gain is less than or equal to zero,
          C or outside warmer than inside, don't alter infiltration
            IF (X .LE. 0.0) GO TO 80
            IF (TO .GE. TS) GO TO 80
          C Calculate infiltration CFM
            DEN = PR/(.754*TZONER)
            CI = X/(14.4*DEN*(TO-TS))
          80 CONTINUE
            END
          END-FUNCTION ..
          COMPUTE LOADS ..
```

Applicable  
Window

-----+-----1-----+-----2-----+-----3-----+-----4-----+-----5-----+-----6-----+

Note that CI has been assigned to CFMW, which is the internal DOE-2 program variable that represents the infiltration CFM through a window. Through this assignment, the value of CI calculated by the function becomes the new value for CFMW.

**LOADS Example 3: Outside Film Heat Transfer Coefficient**

This function redefines the outside film heat transfer coefficient using the "Kimura Algorithms" (Kimura, *Scientific Basis of Air Conditioning*, 1977, p.85ff)

EW-2 = EXTERIOR-WALL

Applicable  
Exterior Wall

```

      .
      .
      .
      FUNCTION = (*FNEW2*, *NONE*) ..
      .
      .
      .
      END ..
      FUNCTION NAME = FNEW2 ..
      ASSIGN
          WS = WNDSPD $ wind speed
          WD = WNDDRR $ wind direction
          WA = XSAZM $ surface azimuth
          FU = FILMU $ air film conductance ..
      CALCULATE ..
          RWD = WA + 3.1415 - WD
          IF(RWD .GT. 3.1415) RWD = 6.283 - RWD
      C Convert global windspeed from knots to M/S
          VV = .553*WS
      C Get windspeed at wall surface
          IF(RWD .LT. 1.5708 .AND. VV .GT. 2.) VC = .25*VV
          IF(RWD .LT. 1.5708 .AND. VV .LE. 2.) VC = .5
          IF(RWD .GE. 1.5708) VC = .3 + .05*VV
      C Convert back to knots
          VC = 1.808*VC
      C Combined convective plus radiative air film conductance
      C for roughness = 3 (see Engineers Manual (2.1A), p.III.59)
          FU = 1.90 + .38*VC
      END
      END-FUNCTION ..
      COMPUTE LOADS ..
      -----1-----2-----3-----4-----5-----6-----+
```

### LOADS Example 4: Using Measured Daylight Factors

This function calculates daylight levels in a space using coefficients obtained by the user from physical scale model measurements of the ratio of interior to exterior illuminance. In the function, the coefficients are multiplied by the hourly total exterior illuminance from sun and sky to give the interior daylight illuminance. The measured coefficients for solar altitudes of 0, 10, 30, 50, and 70 degrees are entered using TABLE.

- Note 1. This function assumes there are no movable shading devices on the windows which would alter the interior illuminance depending on whether the shades were open or closed.
- Note 2. This function does not re-calculate glare, so that the glare levels reported by the program should be ignored.
- Note 3. This function is illustrative only; the coefficients in an actual case could also depend on other factors, such as solar azimuth, cloud cover, etc.

```
SPACE1 = SPACE
.
.                                     Applicable
.                                     Space
DAYLIGHTING = YES
.
.   other daylighting-related keywords
.
DAYL-ILLUM-FN = (*NONE*, *MODEL-DATA-FN*) ..
.
.
END ..
FUNCTION   NAME = MODEL-DATA-FN ..
ASSIGN
  RDNCC    = RDNCC                $ DIRECT NORMAL SOLAR RADIATION, $
                                     $ BTUH/SF $
  BSCC     = BSCC                $ SKY DIFFUSE SOLAR RADIATION $
                                     $ ON HORIZONTAL, BTUH/SF $
  RAYCOS3  = RAYCOS3             $ SINE OF SOLAR ALTITUDE $
  PHSUND   = PHSUND             $ SOLAR ALTITUDE IN DEGREES $
  ILLUM    = DAYLIGHT-ILLUM1    $ DAYLIGHT ILLUMINANCE AT REF PT 1 $
                                     $ FOOTCANDLES (REF PT 2 NOT USED) $ ..
ASSIGN
  TAB1 = TABLE (0,0)(10,.005)(30,.007)(50,.0085) (70,.01)(90,.01) ..
CALCULATE ..
```

C Exterior horizontal illuminance from direct sun in footcandles  
C (=Lumens/SF). Assumes that the luminous efficacy of direct  
C solar radiation = 100 Lumens/Watt = 29.3 Lumens/Btuh)  
IDIRH = RDNCC \* RAYCOS3 \* 29.3

C Exterior horizontal illuminance from sky.  
C (Assumes that the luminous efficacy of diffuse solar  
C radiation = 125 Lumens/Watt = 36.6 Lumens/Btuh.)  
IDIFH = BSCC \* 36.6

C Total exterior illuminance  
ITOTH = IDIRH + IDIFH

C Interior daylight illuminance for current solar altitude  
ILLUM = PWL (TAB1,PHSUND) \* ITOTH  
END

END-FUNCTION ..  
CCOMPUTE LOADS ..

-----+-----1-----+-----2-----+-----3-----+-----4-----+-----5-----+-----6-----+

**LOADS Example 5: Looping Logic**  
 This function demonstrates looping logic.

```

SPACE1 = SPACE
      .
      .
      .
      FUNCTION = (*NONE*, *SP-FN-TEST-1*), ..
      .
      .
      .
END ..

FUNCTION NAME = SP-FN-TEST-1 ..

ASSIGN
  DAY = IDAY      MZ = MZ
  HR  = IHR      MZEXT = MZEXT
  LMX = LMX      NEXTS = NEXTS
  LMWI = LMWI    QZTOT = QZTOT
  MON = IMO      S = SCHEDULE(SCHED-1)
  MWI = MWI      WIAREA = WIAREA
  MX  = MX       XSQCOMP = XSQCOMP
  MXWIN = MXWIN  YR = IYR
                   ZAREA = ZFLRAR ..

CALCULATE ..

      PRINT 1
1      FORMAT(21H TEST OF SP-FN-TEST-1)
      PRINT 2, YR, MON, DAY, HR, S
2      FORMAT(1X, 4F10.1, F8.2)
      PRINT 3, ZAREA, QZTOT
3      FORMAT(10X, 6HZAREA=, F6.1, 5X, 6HQZTOT=, F8.1)

C Initialize EXTERIOR-WALL pointer and counter.
  MX=MZEXT
  NX=0

C Loop through EXTERIOR-WALLS.
100  NX=NX+1

C Increment EXTERIOR-WALL count and exit
C EXTERIOR-WALL loop if finished
  IF(NX .GT. NEXTS)GO TO 900
  PRINT 4, NX, XSQCOMP
4    FORMAT(30X, 3HNX=, F3.0, 8HXSQCOMP=, F10.1)

```

```

C Initialize window pointer and counter.
      MWI=MXWIN
      NW=0

C Increment window counter and exit window loop if finished
200      NW=NW+1
          IF(NW .GT. NWIN) GO TO 400
          PRINT 5, NW, WIAREA
5          FORMAT( 40X, 3HNW=, F3.0, 3X, 7HWIAREA=, F10.1)

C Increment window pointer to get next window
      MWI=MWI+LMWI
      GO TO 200
400      CONTINUE

C Increment EXTERIOR-WALL pointer to get next EXTERIOR-WALL.
      MX=MX+LMX
      GO TO 100
900      CONTINUE

C Stop simulation at hour 9.
      IF(HR .EQ. 9) STOP
      END

```

```

END-FUNCTION ..
COMPUTE LOADS ..

```

```

-----+-----1-----+-----2-----+-----3-----+-----4-----+-----5-----+-----6-----+

```



### LOADS Example 6: Variable Shading Coefficient

This function is used to vary the shading coefficient of a window depending on the value, RTOT, of the total (direct plus diffuse) solar radiation incident on the window. If  $RTOT \leq 10$  Btuh/ft<sup>2</sup>, the window is "clear" (shading coefficient = 0.8). As RTOT increases from 10 to 100 Btuh/ft<sup>2</sup>, the window darkens, reaching a shading coefficient of 0.2 at 100 Btuh/ft<sup>2</sup>. For  $RTOT > 100$  Btuh/ft<sup>2</sup>, the shading coefficient remains at 0.2.

```
WINDOW-1 = WINDOW
      .
      .
      .
      FUNCTION = (*WSCSGC*, *PRINTQ*) ..
      .
      .
      .
      END ..
      FUNCTION NAME = WSCSGC ..
      ASSIGN
          RTOT      = RTOT
          SHACO     = GSHACO ..
      CALCULATE ..
      C Calculate shading coefficient
          SHACO = -0.00667*RTOT + 0.8667
          IF (RTOT.LE.10.) SHACO=0.8
          IF (RTOT.GE.100.) SHACO=0.2
          END
      END-FUNCTION ..
      FUNCTION NAME = PRINTQ ..
      ASSIGN
          HR      = ISCHR
          IPRDFL  = IPRDFL
          SHACO   = GSHACO
          RTOT    = RTOT ..
      CALCULATE ..
      C PRINTQ is used at the end of the subroutine's execution;
      C its purpose in this example is to verify values generated
      C by WSCSGC. Don't print any values until building start-up
      C is complete. IPRDFL is a counter used for building start-up.
      C When the building has cycled through three days, IPRDFL goes
      C to 0 (zero). Print values between the hours of 6 and 21 only.
          IF (IPRDFL.GT.0.)RETURN
          IF ((HR.LT.6.) .OR. (HR.GT.21.))RETURN
```

```
C Standard FORTRAN print statement
  PRINT 20,HR,RTOT,SHACO
20  FORMAT(1X,3HHR=F3.0,3X,5HRTOT=F8.2,3X,6HSHACO=F8.3/)
  END
```

```
END-FUNCTION ..
```

```
CCOMPUTE LOADS ..
```

```
-----+-----1-----+-----2-----+-----3-----+-----4-----+-----5-----+-----6-----+
```

### LOADS Example 7: Reading Measured Schedule Values from a File

In applications where you want to reconcile the measured performance of a building with the DOE-2 simulation, it may be desirable to input measured profiles (such as for lighting) rather than try to replicate these profiles using the SCHEDULE command capabilities in DOE-2. This might be the case, for example, if the actual lighting profile is so variable that it cannot accurately be represented by a series of different DAY-SCHEDULES and WEEK-SCHEDULES.

The following example shows how to use input functions to read in 8760 hours of measured space lighting power and equipment power values into the LOADS simulation. The input function puts these values into the lighting schedule and equipment schedule, respectively, for the space.

To do this, we define "place-holder" schedules whose hourly values will be altered by the input function. We then refer to these schedules in the SPACE command.

Values are read at the beginning of every hour of the simulation using a building-level "before" function.

Example

-----

\$ Use Input Functions to Read Lighting and Equipment Profiles  
from a File \$

INPUT LOADS ..

·  
·

BUILDING-LOCATION

·  
·  
FUNCTION = (\*READER\*, \*NONE\*) ..

\$ the schedule values

·  
·  
LIGHT-SC-1 = SCHEDULE THRU DEC 31 (ALL) (1,24)(0) ..

EQUIP-SC-1 = SCHEDULE THRU DEC 31 (ALL) (1,24)(0) ..

·  
·

SP-1 = SPACE

·  
·  
LIGHTING-KW = 1.0 LIGHTING-SCHEDULE = LIGHT-SC-1

EQUIPMENT-KW = 1.0 EQUIP-SCHEDULE = EQUIP-SC-1 ..

\$ In above, LIGHTING-KW and EQUIPMENT-KW are set to 1.0 since  
\$ the schedule values that are read in will contain the actual  
\$ KW's. Alternatively, LIGHTING-KW and EQUIPMENT-KW could be  
\$ actual peak KW values, and the schedule values could be fractions

END ..

\$ The following function reads measured lighting and equipment  
 \$ power values every hour from FORTRAN unit 50. This unit gets  
 \$ assigned a default filename by the operating system (e.g.,  
 \$ fort.50 in SunOS, FOR050.DAT in VAX/VMS). Thus, for example,  
 \$ if you are running VAX/VMS, your command file that runs DOE-2  
 \$ BDL and simulation should copy the data file (that you want  
 \$ the function to read) to FOR050.DAT The file that is read  
 \$ contains 8760 lines of measured data. Each line contains  
 \$ lighting power (kW) in columns 1-10 and equipment power (kW)  
 \$ in columns 11-20.

FUNCTION NAME = READER ..

ASSIGN LS = SCHEDULE-NAME( LIGHT-SC-1 )  
 ES = SCHEDULE-NAME( EQUIP-SC-1 )  
 IHR = IHR \$ hour number  
 IDAY = IDAY \$ day number  
 IMON = IMON ..

CALCULATE ..

C-- We need to rewind the data file at the end of the warm-up  
 C-- period so that when the DOE-2 simulation begins we are at  
 C-- the beginning of the data file. We know we are at the end  
 C-- of the warm-up since at this time IHR and IMON will have  
 C-- been reset to 1.

```

      IF( IHR + IDAY + IMON .EQ. 3 ) REWIND 50
      READ( 50, 1 ) LS, ES
1     FORMAT( 2F10.1 )
      END

```

END-FUNCTION ..

COMPUTE LOADS ..

## SYSTEMS Input Function Examples

### SYSTEMS Example 1: Cold-Deck Supply Air Temperature Reset

In this example the return air temperature is used to reset the cold-deck supply air temperature to the reheat coils in a Reheat Fan System. Here, TRLAST is the last-hour value of the return air temperature, TR, which is stored by the function "SFN1".

```

INPUT SYSTEMS ..
.
.
SUBR-FUNCTIONS  DKTEMP-3=*DKTEMPF* .. $ modifying subroutine DKTEMP at
                                     $ function access point DKTEMP-3
.
.
FS-SYS= SYSTEM  SYSTEM-TYPE=RHFS
.
FUNCTION=( *NONE*, *SFN1* ) .. $ systems-after-function SFN1
                                $ is used to save the value
                                $ of TR to be used next hour
                                $ by the function DKTEMPF
.
.
END ..

FUNCTION NAME=DKTEMPF ..
$
$ This function resets the cold-deck temperature according to the
$ return air temperature. The reset characteristic obeys the
$ following piecewise linear (PWL) relationship between TC and TR:
$
$
$   TC ^
$   |
$   70 +-----|
$   |           |
$   60 +         |
$   |           |
$   50 +         |-----
$   |           |
$   +-----+-----+----->
$   60  70  80  TR (deg F)
$
ASSIGN  IHR=IHR  IDAY=IDAY  IMO=IMO  INILZE=INILZE ..
ASSIGN  TR=TR    $ return air temp $
        TC=TC    $ cold-deck temp $
ASSIGN  TRLAST = F-SYS-VARI .. $ where last-hour TR value is stored $
ASSIGN  TCTR=TABLE (0,70) (70,70) (80,50) (100,50) .. $for the PWL function $
                                                $ of TC vs TR $

CALCULATE ..

```

```

c--if TRLAST not available, do nothing
    IF ( TRLAST .EQ. 0. ) RETURN
c--compute cold-deck temperature
    TC = FWL ( TCTR, TRLAST )
c
c--the following four lines can be un-commented to get debug print
c    IF ( INILZE .LT. 4 ) RETURN { if initialization cycle, don't print }
c    IF ( (IDAY .NE. 7) .OR. (IMO .NE. 7) ) RETURN { print only one day =JUL 7 }
c    PRINT 1, IMO, IDAY, IHR, TC, TR
c    1 FORMAT(' DKTEMPF -- IMO, IDAY, IHR=', 3f3.0, ' TC=', f7.2, ' TR=', f7.2)
    END

```

END-FUNCTION ..

FUNCTION NAME=SFN1 ..

\$ This function stores the value of the return air temperature (TR)

\$ so that the function 'DKTEMPF' can use it next hour.

ASSIGN TR=TR \$ return air temp \$

ASSIGN TRLAST = F-SYS-VARI .. \$ where the last-hour TR value is stored \$

CALCULATE ..

c--store return air temperature

TRLAST=TR

END

END-FUNCTION ..

CCOMPUTE SYSTEMS ..

STOP ..

-----+-----1-----+-----2-----+-----3-----+-----4-----+-----5-----+-----6-----+

## SYSTEMS Example 2: Drybulb Economizer

A drybulb economizer is modeled that sets the outside air fraction to minimum if the outside air temperature exceeds the return air temperature.

INPUT SYSTEMS ..

```
SUBR-FUNCTIONS ECONO-2=*econoFN* .. $ to modify subroutine ECONO at
$ function access point ECONO-2
```

END ..

```
FUNCTION NAME=econoFN* ..
  ASSIGN IHR=IHR IDAY=IDAY IMO=IMO INILZE=INILZE
         PO = PO $ outside-air fraction $
         TR = TR $ return-air temperature $
         PCMXXX = PCMXXX $ min outside-air-fraction $
         TAPPXX = TAPPXX $ requested mixed-air temp $
         DBS = DBT $ outside drybulb temperature $$
         ECONOLT = DRYBULB-LIMIT $ from BDL input $
         ECONOLL = ECONO-LOW-LIMIT $ from BDL input $
         MAXOA = MAX-OA-FRACTION $ from BDL input $
  ..
```

CALCULATE ..

```
c--first compute PO to satisfy TAPPXX and limit it depending on bounds
  PO = PCMXX
  IF( ABS( DBT-TR ) .gt. 0.1 )
  1   PO = AMAX( PCMXXX, (TAPPXX-TR)/(DBT-TR) )
  PO = AMIN ( PO, MAXOA )
  IF( (ECONOLL .ne. 0) .and. (DBT .lt. ECONOLL) ) PO = PCMXXX
  IF( (ECONOLT .ne. 0) .and. (DBT .ge. ECONOLT) ) PO = PCMXXX
c--set oa fraction to min if oa temp greater than return air temp
  IF( DBT .GT. TR) PO = PCMXXX
c
c--the following six lines can be un-commented to get debug print
c   IF ( INILZE .LT. 4 ) RETURN { if initialization cycle, don't print }
c   PRINT 1, IMO, IDAY, IHR, PCMXXX, TAPPXX, ECONOLT, ECONOLL, MAXOA, PO
c   1   , TR, DBT
c 1   FORMAT( ' econoFN-- ', 3f3.0, ' PCMXXX, TAPPXX=', f5.2, f6.2,
c   1   ' ECONOLT=', f5.2, ' ECONOLL=', f5.2, ' MAXOA=', f5.2,
c   2   ' PO=', f5.2, ' TR=', f5.2, ' DBT=', f5.2 )
  END
END-FUNCTION ..
COMPUTE SYSTEMS ..
STOP ..
-----+-----1-----+-----2-----+-----3-----+-----4-----+-----5-----+-----6-----+
```

### SYSTEMS Example 3: Enthalpy Economizer

We model an enthalpy economizer that sets the outside air fraction to minimum if the outside air enthalpy is greater than a setpoint value.

```
INPUT SYSTEMS ..
.
.
SUBR-FUNCTIONS   ECONO-2=>econoFNb* .. $ modifying subroutine ECONO at
                                         $ function access point ECONO-2
.
.
END ..

FUNCTION NAME=econoFNb ..

ASSIGN   IHR=IHR  IDAY=IDAY  IMO=IMO  INILZE=INILZE ..
ASSIGN   ENTHSET = 30          $ setpoint for outside air enthalpy stat $
        ENTHAL  = ENTHAL      $ outside air enthalpy $
        PO      = PO          $ outside-air fraction $
        TR      = TR          $ return-air temperature $
        TAPPXX  = TAPPXX      $ requested mixed-air temp $
        PCMPXX  = PCMPXX      $ min outside-air fraction $
        DBT     = DBT         $ outside drybulb temp $
        ECONOLT = ECONO-LIMIT-T $ from BDL input $
        ECONOLL = ECONO-LOW-LIMIT $ from BDL input $
        MAXOA   = MAX-OA-FRACTION $ from BDL input $

CALCULATE ..
c--first compute PO to satisfy TAPPXX and limit it depending on bounds
  PO = PCMXXX
  IF( ABS( DBT-TR ) .gt. 0.1 )
  1    PO = AMAX( PCMXXX, (TAPPXX-TR)/(DBT-TR) )
  PO = AMIN( PO, MAXOA )
  IF( (ECONOLL .ne 0) .and. (DBT .lt. ECONOLL) ) PO = PCMXXX
  IF( (ECONOLT .ne 0) .and. (DBT .ge. ECONOLT) ) PO = PCMXXX
c--now set oa fraction to minimum if oa enthalpy exceeds setpoint
  IF( ENTHAL .gt. ENTHSET ) PO = PCMXXX
c
c--the following six lines can be un-commented for debug print
c   IF ( INILZE .lt. 4 ) RETURN { if initialization cycle, don't print }
c   PRINT 1, IMO, IDAY, IHR, PCMXXX, TAPPXX, ECONOLT, ECONOLL, MAXOA, PO
c   1    , TR, DBT
c 1  FORMAT( ' econoFN-- ', 3f3.0, ' PCMXXX, TAPPXX=', f5.2, f6.2,
c   1    ' ECONOLT=', f5.2, ' ECONOLL=', f5.2, ' MAXOA=', f5.2,
c   2    ' PO=', f5.2, ' TR=', f5.2, ' DBT=', f5.2 )
      END
END-FUNCTION ..
COMPUTE SYSTEMS ..
STOP ..
-----+-----1-----+-----2-----+-----3-----+-----4-----+-----5-----+-----6-----+
```



## HOURLY REPORT FREQUENCIES AND SUMMARIES

There is a keyword in the LOADS-REPORT, SYSTEMS-REPORT, and PLANT-REPORT commands that allows the user to control the frequency at which hourly report data are printed.

REPORT-FREQUENCY may be set to HOURLY (the default), DAILY, MONTHLY, or YEARLY. If REPORT-FREQUENCY is not specified, the program will generate reports with the same format as before except that summary values (minimum, maximum, total, and average) will be printed at the end of each day and month, and at the end of the run period specified in the REPORT-SCHEDULE. When REPORT-FREQUENCY is set to DAILY, the hourly data are suppressed and only summary values are printed for each day and at the end of the month and run period. Similarly, when REPORT-FREQUENCY is set to MONTHLY, only the summary statistics for months and the run period are printed. Specifying frequency equal to YEARLY results in a single summary report covering the entire run period. Only scheduled hours are included in the summaries.

### Example:

```
LOADS-REPORT    VERIFICATION = (LV-A)
                SUMMARY = (SS-A,SS-E)
                REPORT-FREQUENCY = DAILY ..
```

```
REPORT-BLOCK
```

```
.
. ..
```

```
HOURLY-REPORT
```

```
.
. ..
```

-----

When REPORT-FREQUENCY is used in conjunction with the HOURLY-REPORT keyword, OPTION = PLOT, only the TOTAL values are plotted. If REPORT-FREQUENCY is not specified, i.e., hourly data are printed, the plots are unchanged.

Note that some averages may be misleading, e.g., the average solar altitude if the schedule contains nighttime hours during which the solar altitude values are zero.

Examples of hourly reports (with REPORT-FREQUENCY=HOURLY) can be found in the *Sample Run Book (2.1E)* under the Daylighting and Sunspace Examples.

## SAVING FILES OF HOURLY OUTPUT FOR POSTPROCESSING

Options were added in DOE-2.1D and 2.1E to allow you to create binary or formatted-ASCII files of hourly report data. You can then read these files into your postprocessor program (such as a spreadsheet program) and do statistical analysis or process the data to produce customized tables, graphs, histograms, scatterplots, etc.

There are two different ways to create such files:

Method 1 produces binary files if you specify `OPTION=BINARY-FILE` in the `HOURLY-REPORT` command.

Method 2 produces binary or formatted-ASCII files when you specify either `HOURLY-DATA-SAVE=BINARY` or `=FORMATTED`, respectively, in the `LOADS-`, `SYSTEMS-`, or `PLANT-REPORT` commands.

Following are the details for using these two methods.

### Method 1: `OPTION = BINARY-FILE` in `HOURLY-REPORT`

The `OPTION` keyword in the `HOURLY-REPORT` command in `LOADS`, `SYSTEMS`, and `PLANT` now takes the following code-words:

<i>PRINT</i>	The default produces printed output in tabular form (see <i>Reference Manual (2.1A)</i> , p.III.127).
<i>PLOT</i>	An existing code-word, produces printed output in printer-plot form (see <i>Reference Manual (2.1A)</i> , p.III.127-8).
<i>BINARY-FILE</i>	A new code-word in DOE-2.1E that causes the hourly output to be written to a file in binary format. Printed output is suppressed. The format of the resulting binary file is described in the following section.

### `HOURLY-REPORT OPTION = BINARY-FILE` header and data records

The files produced by the `BINARY-FILE` option of the `HOURLY-REPORT` command are named `HRPLDSnn.BIN`, `HRPSYSnn.BIN`, and `HRPPLTnn.BIN`, where `nn` is the sequence number for the program unit execution, starting with 01. These files consist of two portions: header records and data records. Each file contains a minimum of three header records and data records for each hour the `HOURLY-REPORT` is scheduled to be on, plus an end-of-file flag record. Each record item described below is 4-bytes long, either integer or real. The records also contain, when read as binary rather than FORTRAN unformatted, 4-byte headers and trailers that contain the length (4-byte integer) of data contained in the record (does not include the 16 bytes of header and trailer.) The header and trailer contents are compiler dependent, so if this description does not match what you read consult your program supplier or the FORTRAN manual for the compiler used to create the version of the program you are using.

**Record #1**

File header

NHRP,IPROG,ITITLE,CLOCK,VERS where:

	type	description
NHRP	I	number of hourly reports on this file - to read the remaining headers
PROG	I	program unit that created this file (1=LOADS, 2=SYSTEMS, 3=PLANT)
ITITLE(10,5)	I	five lines of 40-character report titles
CLOCK(8)	I	28 bytes of time/date and 4-byte integer run number in this program unit
VERS(2)	I	8 characters of program version

Type: I=integer (4bytes) R=real (4bytes)

**Record #2**

Hourly report header records (and all following HOURLY-REPORT header records)

REPORT-NAME,IOPTION,PLOT-SCALES,AXIS-ASSIGNMENT,AXIS-MAX,  
AXIS-MIN,IU,NUMRB where

	type	len	pos	description
REPORT-NAME	I	4	1	USER NAME OF HOURLY-REPORT (IN 4A4)
IOPTION	I	1	5	1=PRINT 2=PLOT 3=BINARY-FILE
PLOT-SCALES	I	12	6	EACH VALUE IS TO BE SCALED BY THIS FACTOR
AXIS-ASSIGNMENT	I	12	18	AXIS TO WHICH THIS ITEM IS TO BE ON (1 OR 2)
AXIS-MAX	R	2	30	MAXIMUM FOR EACH OF THE PLOT AXIS
AXIS-MIN	R	2	32	MINIMUM FOR EACH OF THE PLOT AXIS
AXIS-TITLES	I	8	34	TITLES FOR EACH AXIS, 16 CHRS EACH (4A4)
IU	I	1	42	Unused on this file
NUMRB	I	1	43	NUMBER OF FOLLOWING REPORT BLOCK RECORDS

Records 2 and 3 repeat for each HOURLY-REPORT on the files (NHRP in first record).

### Record #3

Record #3 (and all following REPORT-BLOCK header records after each HOURLY-REPORT header record). This record repeats NUMRB (from previous HOURLY-REPORT header record) times, one for each REPORT-BLOCK in the HOURLY-REPORT.

COMP-NAME,IVTYPE,NUMITMS,LISTITMS where:

	type	len	pos	description
COMP-NAME	I	4	1	NAME OF THE REPORT-BLOCK COMPONENT (16 bytes)
IVTYPE	I	1	5	TYPE OF THE COMPONENT + 1000*program number
NUMITMS	I	1	7	NUMBER OF ITEMS IN VARIABLE-LIST
LISTITMS	I	NUMITMS	8	INTEGER VALUES OF THE VARIABLE-LIST ITEMS

Records 2 and 3 repeat for each HOURLY-REPORT on the files (NHRP in first record).

### Data records:

COMP-NAME,IVTYPE,NUMITMS,LISTITMS where:

	type	len	pos	description
IYEAR	I	1	1	Year of the RUN-PERIOD
IMON	I	1	2	Month of the RUN-PERIOD
IDAY	I	1	3	Day of the RUN-PERIOD
IHR	I	1	4	Hour of the RUN-PERIOD
ILEN	I	1	5	Number of following items count of items on all REPORT-BLOCKS of all HOURLY-REPORTS file
DATA	R/I	ILEN	6	DATA for each item for the hour

The end of the file is marked with a special data record in which IYEAR=IMON=IDAY=IHR=0 and ILEN=1 and one data item of value 0 is passed.

## SHARING HOURLY-REPORT DATA AMONG PROGRAM MODULES

HOURLY-REPORT data from an upstream program module (such as LOADS) can now be incorporated into an HOURLY-REPORT in a downstream module (such as SYSTEMS).

In the *upstream* module, you create an HOURLY-REPORT using OPTION=BINARY-FILE as described in the previous section. This causes a file to be written that can be read by a downstream module. The file names are "HRPLDSnn.BIN" and "HRPSYSnn.BIN" for LOADS and SYSTEMS, respectively.

In the *downstream* module, you create a REPORT-BLOCK with one of the following VARIABLE-TYPES:

**LOADS-DATA** Specifies that an HOURLY-REPORT file written by the LOADS program using OPTION=BINARY-FILE will be automatically read into the REPORT-BLOCK.

**SYSTEMS-DATA** Specifies that an HOURLY-REPORT file written by the SYSTEMS program using OPTION=BINARY-FILE will be automatically read into the REPORT-BLOCK.

In the downstream module, a VARIABLE-LIST must also be specified since this is a required keyword. The list must be a single entry of the value "1" as shown in the example, below. The actual variable list will be read from the binary file. In other words, all of the variables written to the binary file will be included in this new report block. It is not possible to select only a portion of the variables.

In SYSTEMS, one REPORT-BLOCK may be defined with VARIABLE-TYPE = LOADS-DATA. In PLANT, one REPORT-BLOCK may be defined with VARIABLE-TYPE = LOADS-DATA and another with VARIABLE-TYPE = SYSTEMS-DATA.

The program will coordinate the times defined in the REPORT-SCHEDULES of the HOURLY-REPORTS in the upstream and downstream program modules. There is never a problem when the upstream file has more hours of overlapping data than scheduled in the downstream file; the program skips over the extra hours of data until it finds the hours which match. When the downstream HOURLY-REPORT is scheduled for hours that were not scheduled in the upstream report, then the flag value of "-77777" will be displayed for the hours which are missing.

**Example:**

Passing LOADS hourly report data to SYSTEMS

INPUT LOADS ..

...

```
SCH-1      = SCHEDULE          THRU DEC 31 (ALL)(1,24)(1) ..
LRB-1      = REPORT-BLOCK     VARIABLE-TYPE = GLOBAL
                                VARIABLE-LIST = (15) .. $ horizontal solar
LDS-REP-1  = HOURLY-REPORT    REPORT-SCHEDULE = HR-SCH-1
                                REPORT-BLOCK = (LRB-1)
                                OPTION = BINARY-FILE .. $ to pass LOADS
                                                                $ hourly
                                                                $ variables to
                                                                $ SYSTEMS
```

...

INPUT SYSTEMS ..

```
SCH-2      = SCHEDULE          THRU DEC 31 (ALL)(1,24)(1) ..
SRB-1      = REPORT-BLOCK     VARIABLE-LIST = (1)
                                VARIABLE-TYPE = LOADS-DATA $ to get hourly
                                                                $ variables
                                                                $ from LOADS
SRB-2      = REPORT-BLOCK     VARIABLE-TYPE = <zone u-name>
                                VARIABLE-LIST = (6,8) .. $ zone temp
                                                                $ and extract rate
SYS-REP-1  = HOURLY-REPORT    REPORT-SCHEDULE = SCH-2
                                REPORT-BLOCK = (SRB-1,SRB-2) ..
```

...

See also "Metric Input/Output Example" in the *Sample Run Book (2.1E)*.

## METRIC OPTION

### Introduction

With the metric option it is possible to enter and have reported out numerical values in metric units. In addition, metric output units can be requested from an English unit input deck, and vice versa. The metric units employed by DOE-2 are those used by professionals in Europe; they differ slightly from those of the International System of Units (SI). The metric ranges and defaults for keywords have been calculated from the DOE-2 English ranges and defaults.

A metric input/output example is shown in the *Sample Run Book (2.1E)*. We recommend that you glance at this example before reading further.

The following table shows the metric-to-English unit conversions in DOE-2. You can use this table to:

- (1) Determine what units to use for metric input of a keyword if you know what the corresponding English unit is. For example, the English unit for the HEIGHT keyword in the EXTERIOR-WALL command is FT (feet) as determined from the *BDL Summary (2.1E)* or other manual. The table shows that the corresponding metric unit is M (meters). It is important to know that there are a few keyword values that are NOT converted. See "Exceptions", p.1.38.
- (2) Determine the metric/English conversion factor in DOE-2. For example, the conversion factor from feet to meters is 0.30480, i.e.,  $1.0 \text{ FT} = 0.30480\text{M}$ .

---

The metric conversion of DOE-2 was the result of the combined efforts of the RAMSES Group of the University of Paris (South) in Orsay, France, and the Simulation Research Group of Lawrence Berkeley Laboratory.

DOE-2 Units Table (Excerpt from LOADS Report LV-M)

Metric	English	Conversion factor	Metric	English	Conversion factor
\$DOLLARS	\$DOLLARS	1.	M2	SQFT	.092903
\$/HR	\$/HR	1.	(M2-K/W)2	(HR-SQFT-F/BTU)2	.0310563
1/K	1/R	1.7999	M2-K/W	HR-SQFT-F/BTU	.176228
CANDELA/M2	FOOTLAMBERT	3.426259	M3/H	CFM	1.69901
C(delta)	F(delta)	.555556	M3/H-M2	CFM/SQFT	18.288
CM	IN	2.54	M3	CUFT	.028317
DEGREES(angle)	DEGREES(angle)	1.	M	FT	.30480
HRS/YEARS	HRS/YEARS	1.	MBAR	INCH MER	33.8638
J/K	BTU/F	1897.800049	MBAR-GAGE	LBS/SQIN-GAGE	68.947571
J/KG-K	BTU/LB-F	4183.83	MM-WATER	IN-WATER	25.4
J/M-K	BTU/FT-F	6226.48	M/S	MPH	.44704
J/M2-K	BTU/SQFT-F	20428.400391	M/SEC	KNOTS	.51444
K(delta)	R(delta)	.555556	MWATT	MBTU/HR	.293
KG	LB	.453592	MWH	MBTU	.292875
KG/HR	LB/HR	.453592	PERCENT-RH	PERCENT-RH	1.0
KG/KW	LBS/KW	.45359	RADIANS	RADIANS	1.
KG/M2	LB/SQFT	4.88240	SEC/M	1/KNOT	1.94386
KG/M3	LB/CUFT	16.01846	THERMIES	THERMS	25.0
KGS/KG	LBS/LB	1.	UNITS/CM	UNITS/IN	.3937
KW	KBTU/HR	.293	UNITS/LITER/MIN	UNITS/GAL/MIN	.26417
KW	KW	1.	W/M2	W/SQFT	10.76392
KWH	KBTU	.293	WATT	BTU/DAY	.012302
KWH/KWH	BTU/BTU	1.	WATT	BTU/HR	.293
KWH/M2-YR	KBTU/SQFT-YR	3.15248	WATT /M2	BTU/HR- SQFT	3.15248
KW/M3/HR	KW/CFM	.5885	WATT/WATT	BTU/WATT	.293
KW/TON	KW/TON	1.	WH	BTU	.293
LITER	GAL	3.78541	WH/KG	BTU/LB	.645683
LITERS/MIN	GAL/MIN	3.78541	W/K	BTU/HR-F	.527178
LITERS/MIN/KW	GALLONS/MIN/TON	1.078	W/M-K	BTU/HR-FT-F	1.7296
L/S	CFM	.4719	W/M2-K	BTU/HR-SQFT-F	5.67446
LUMEN/WATT	LUMEN/WATT	1.	W/PERSON	BTU/HR/PERSON	.293
LUX	FOOTCANDLES	10.76391	YEARS	YEARS	1.



### Invoking the Metric Option

To invoke the metric option, specify the following keywords in the INPUT or PARAMETRIC-INPUT command at the beginning of *each* subprogram:

#### INPUT or PARAMETRIC-INPUT

INPUT-UNITS	informs the particular subprogram of the type of units being input. It takes the code-words ENGLISH and METRIC; ENGLISH is the default. Units are reported in the echo of the input if DIAGNOSTIC COMMENTS is specified.
OUTPUT-UNITS	instructs the subprogram to report out in the unit type specified. It takes the code-words ENGLISH and METRIC; ENGLISH is the default.

#### Example

- (1) For metric input and output in LOADS, specify  
INPUT LOADS INPUT-UNITS=METRIC OUTPUT-UNITS=METRIC ..
- (2) For English input and metric output in LOADS, specify  
INPUT LOADS INPUT-UNITS=ENGLISH OUTPUT-UNITS=METRIC ..

**Rule** The LOADS, SYSTEMS, PLANT and ECONOMICS subprograms always default to English units. Therefore if you want metric throughout, you must specify INPUT-UNITS = METRIC at each subprogram level, *including* parametric runs. The program calculations are performed in English units and all files are passed or saved in English. If INPUT-UNITS=METRIC, BDL converts metric input to English, and if OUTPUT-UNITS=METRIC the report generators convert English to metric output. Therefore, it is also possible to switch from one unit system to the other, between subprograms, in a single run.

#### Materials and Construction Library

The LIBRARY-INPUT LOADS command also takes the keyword INPUT-UNITS, which specifies the type of units used in a library run.

- Rule 1. An individual library can contain only one type of units.
- Rule 2. If INPUT-UNITS = METRIC, then BDL LIB, the preassembled DOE-2 materials and constructions library in English units (see *Reference Manual (2.1A)*, p.III.147), can neither be accessed nor augmented. If you try to access a BDL LIB in English units with INPUT-UNITS = METRIC, the following error message will be printed:

“ERROR, THE UNITS OF YOUR LOADS INPUT DO NOT MATCH THE UNITS OF BDL LIB, THE MATERIALS AND CONSTRUCTION LIBRARY. PROGRAM EXECUTION TERMINATED.”

You will have to create your own metric version of BDL LIB by doing a LIBRARY-INPUT LOADS run with INPUT-UNITS = METRIC and OUTPUT-UNITS = METRIC (see *Reference Manual (2.1A)*, p.III.21,147,152). Alternatively, you can remove BDL LIB from your run control file and enter constructions in your input using the MATERIAL, LAYERS and

**Basic Units**

In DOE-2, basic units are as follows:

- length           foot (English) or meter (metric)
- energy           Btu (English) or Wh (metric)
- power            Btu/h (English) or W (metric)
- air flow         cfm (English units) or m<sup>3</sup>/h (metric units)
- temperature     degrees Fahrenheit (English) or degrees centigrade (metric)

**Keyword Synonyms for Metric Option**

As a convenience to metric users, synonyms have been developed for keywords that contain English units as an integral part of their names. For instance, to avoid confusion in a metric input deck, LIGHTING-W/SQFT may be specified as its metric equivalent, LIGHTING-W/AREA. The following table gives the equivalent metric term which can be substituted wherever the English term is encountered in a keyword. These synonyms will also appear in the diagnostics and output reports, if you specify OUTPUT-UNITS = METRIC.

English	Metric	Metric Abbrev.
BTU/HR	POWER	P
CFM	FLOW	F
GAL/MIN	FLOW	
FCFM	FFLOW	FF
SQFT	AREA	A
THERMS	POWER	P

**Keyword Limits in the Metric Option**

DOE-2 obtains the maximum, minimum, and default values for keywords when INPUT-UNITS=METRIC by converting the corresponding English values, which are listed in the *BDL Summary (2.1E)*.

## DAY-SCHEDULES in the Metric Option

A DAY-SCHEDULE command looks like:

```
DS-YES=DAY-SCHEDULE HOURS=( 1 , 8 )   VALUES=( 0 . )  
                   HOURS=( 9 , 17 )  VALUES=( 1 . )  
                   HOURS=( 18 , 24 ) VALUES=( 0 . ) ..
```

or more commonly:

```
DS-YES=DAY-SCHEDULE (1,8)(0.) (9,17)(1.) (18,24)(0.) ..
```

since the keywords HOURS and VALUES are optional in the command. The purpose of the DAY-SCHEDULE command is to assign a number or value to each hour of the day. This number can be dimensionless (as above where it might represent fractional occupancy level), or it can be a temperature or a solar radiation intensity. In order for DOE-2 to do the metric to English unit conversion correctly, the program must be told whether the DAY-SCHEDULE value assigned to an hour is a dimensionless number, a temperature, or a radiation intensity. Therefore, for INPUT-UNITS=METRIC, the *optional keyword* VALUES is replaced by the *required* keywords VALUES, TEMPERATURES (abbreviation TEMP), or RADIATIONS (abbreviation RADT). Failure to specify one of these keywords in a DAY-SCHEDULE command in a metric input will result in the fatal error:

```
*ERROR*****VALUES, TEMP, OR RADT REQUIRED
```

### Example:

```
DS-YES=D-SCH ( 1 , 8 ) VALUES=( 0 . ) ( 9 , 17 ) ( 1 . ) ( 18 , 24 ) ( 0 . ) .. $ dimensionless $  
DS1  =D-SCH ( 1 , 6 ) TEMP=( 16 ) ( 7 , 18 ) ( 21 ) ( 19 , 24 ) ( 16 ) .. $ deg C $  
DS2  =D-SCH ( 1 , 24 ) RADT=( 200 ) .. $ W/m2 $
```

Note that the keywords VALUES, TEMP, or RADT only have to be entered once per DAY-SCHEDULE command. Also, nesting DAY-SCHEDULES within WEEK-SCHEDULES or SCHEDULES is still possible; for example:

```
S1 = SCHEDULE THRU DEC 31 (ALL) (1,24) TEMP=(21) ..  
S2 = SCHEDULE THRU DEC 31  
    (MON,SAT) (1,24) VALUES=(1)  
    (SUN,HOL) (1,2) VALUES=(1) (3,9)(0)(10,24)(1) ..
```

Do not use the HOURS keyword when nesting DAY-SCHEDULES as this will generate an error.

Note 1. The keyword TEMPERATURES has a min - max range of -50. to 100°C. It has no default. If specified in an English unit input file, this keyword has no effect.

Note 2. The keyword RADIATIONS has a range of 0. to 1200. W/m<sup>2</sup>. There is no default. If specified in an English unit input file, this keyword will have no effect. At present the only schedule that takes radiation intensity values is the MAX-SOLAR-SCH in LOADS in the WINDOW command.

### DAY-RESET-SCHEDULES in the Metric Option

DAY-RESET-SCHEDULES are used to specify how an outside air economizer or a baseboard will be controlled as a function of outside air temperature (see *Reference Manual (2.1A)*, p.III.176ff,209). Usually there are four keywords: OUTSIDE-HI and OUTSIDE-LO specify outside temperature; SUPPLY-HI and SUPPLY-LO specify supply air temperatures (for economizer control) or baseboard output ratio (for baseboard control). Since SUPPLY-HI and SUPPLY-LO can be either temperatures or ratios, in a metric input the program must be told whether these keywords represent temperatures or ratios in order for the metric to English unit conversion to be done correctly. Therefore, for metric input only, four new keywords have been introduced: SUPPLY-HI-TEMP (S-H-T), SUPPLY-LO-TEMP (S-L-T), SUPPLY-HI-RATIO (S-H-R), and SUPPLY-LO-RATIO (S-L-R). Metric users must use either SUPPLY-HI-TEMP and SUPPLY-LO-TEMP for resetting supply air temperatures, or SUPPLY-HI-RATIO and SUPPLY-LO-RATIO for resetting baseboard ratios. The keywords OUTSIDE-HI and OUTSIDE-LO remain unchanged since these always represent temperatures. SUPPLY-HI and SUPPLY-LO are still used in English input files.

#### Examples:

```
SUPPLY-T-1      = RESET-SCHEDULE THRU DEC 31 (ALL)
                  SUPPLY-HI-TEMP = 49      SUPPLY-LO-TEMP = 21 $ deg C $
                  OUTSIDE-HI = 21          SUPPLY-LO = -18 .. $ deg C $

BASEB-RATIO-1   = RESET-SCHEDULE THRU DEC 31 (ALL)
                  SUPPLY-HI-RATIO = 1.0    SUPPLY-LO-RATIO = 0.0 $ ratio $
                  OUTSIDE-HI = 21          SUPPLY-LO = -18 .. $ deg C $
```

### Residential Infiltration in Metric Input

Under the SPACE-CONDITIONS command, the English keyword RES-INF-COEF has been replaced, for metric input only, by three keywords:

RES-INF-CST has a range from 0.0 to 20.0 (mixed units), and the default is 0.252.

RES-INF-WND has a range from 0.0 to 39.0 sec/meter, and the default is 0.0488.

RES-INF-TEMP has a range from 0.0 to 36.0 K<sup>1</sup>, and the default is 0.0151.

where infiltration = RES-INF-CST + (RES-INF-WND × windspeed) + (RES-INF-TEMP × ΔT)

### Reporting Fuel Use in Metric Units

Even if OUTPUT-UNITS=METRIC is specified, DOE-2 defaults to English units for fuel use and fuel demand in the following reports:

```
PS-F    Energy-Resource Peak Breakdown by End-Use,
BEPU    Building Energy Performance Summary — Utility Units,
ES-D    Energy Cost Summary,
ES-E    Summary of Utility-Rate, and
ES-F    Block Charge and Ratchet Summary.
```

For example, natural gas use will be reported in therms and fuel oil will be reported in gallons. To report fuel use in metric units in these reports, you have to use the ENERGY-RESOURCE command in PLANT to specify the unit name and energy content of the fuel. For example, if the metric input for natural gas is in cubic meters, which you decide to abbreviate as "M3", the

ENERGY-RESOURCE input would be:

INPUT PLANT INPUT-UNITS=METRIC OUTPUT-UNITS=METRIC IB..

ENERGY RESOURCE RESOURCE=NATURAL-GAS  
UNIT-NAME=M3 \$ user-chosen name \$  
DEM-UNIT-NAME=M3/HR \$ user-chosen name \$  
ENERGY-UNIT=10860 .. \$ Wh/unit \$

## COMPUTE PLANT

See the description of the ENERGY-RESOURCE command in "Energy Meters in Plant", p.4.3, and the Metric Input/Output Example in the *Sample Run Book (2.1E)*.

### Exceptions

- (1) The schedules verification report LV-G reports out schedules in English units only.
- (2) The PLANT-PARAMETERS keywords COMP-KW/TON-START and COMP-KW/TON-END are in kW/ton in both English *and* metric PLANT input (see "Ice and Eutectic Thermal Energy-Storage", p.4.15).
- (3) The WINDOW keywords, SWITCH-SET-LO and SWITCH-SET-HI, should always be entered in English units, even in metric runs (see "Switchable Glazing", p.2.118).
- (4) In SYSTEMS and PLANT, under the CURVE-FIT command, the keyword:

### INPUT-TYPE

specifies the type of DATA being input for independent variables. It takes the code-words NON-DIMENSIONAL and TEMPERATURES; NON-DIMENSIONAL is the default. If TEMPERATURES is specified, then the values are assumed to be in °C.

Note: in PLANT, under the EQUIPMENT-QUAD command, the quadratics, TWR-RFACT-FRT and TWR-APP-FRFACT, must be fitted from English input data.

### Weather Files

Raw weather files have specific units for weather data. For example, TMY files use metric units. The DOE-2 weather processor knows the units and translates accordingly. The resulting packed files produced by the weather processor are always in English units and can be read by DOE-2 whether INPUT-UNITS=METRIC or ENGLISH.

# INPUT MACROS AND GENERAL LIBRARY FEATURES

## Input Macros

The "Input Macros" feature was added to the Building Description Language in DOE-2.1D to increase the flexibility of BDL. This feature is intended for advanced users who are already familiar with preparing BDL input. The basic capabilities are:

- (1) Incorporating external files containing pieces of BDL into the main BDL input stream. This is also called the "General Library" feature.
- (2) Selectively accepting or skipping portions of the input.
- (3) Defining a block of input with parameters and later referencing this block.
- (4) Performing arithmetic and logical operations on the input.
- (5) Input macro debugging and listing control.

These capabilities are invoked in BDL by using *macro commands*. Macro commands are preceded by `##` to distinguish them from regular BDL commands. After execution by the BDL processor, macro commands produce regular lines of BDL input that are shown in the BDL echo print. Following are descriptions of the macro commands associated with the above capabilities. A detailed example of input macros is given at the end of this section. The user should look at this example before reading the macro command descriptions. This example is also in the *Sample Run Book (2.1E)* as "Parameterized Building".

### (1) Incorporating External Files

`##include {includefilename}`

This command puts all of the lines in an external file into the BDL input stream starting right after the command line. The name of the file that is included is the concatenation of `{prefixpathname}`, entered using `##fileprefix`, and `{includefilename}`. The lines in the external file will be listed in the BDL echo so that the user can see exactly what is being included. When all the lines in the external file have been read in, input reverts back to the original input file at the line following the `##include` command.

`##fileprefix {prefixpathname}`

specifies a pathname that will be prefixed to the filename given in an `##include` command. The `##fileprefix` command allows commonly-used include files to be kept in a directory other than the directory in which the current DOE-2 input file resides.

Example: on VAX/VMS, the combination

```
##fileprefix DRC2:[GUEST.LIBRARY]
```

```
##include SCHEDULES.INP
```

will include into the BDL stream the file whose full name is

```
DRC2:[GUEST.LIBRARY]SCHEDULES.INP
```

**##includesilent {includefilename}**

This command is identical to **##include**, except that the lines in the included file will not be listed in the BDL echo.

**##nosilent**

Overrides the listing suppression of **##includesilent**. Used for debugging purposes only. After **##nosilent**, all following **##includesilent** commands are treated as **##include** commands.

**Example:** Assume the following files contain the indicated lines:

Main input file:	External file:
input1.inp	file2.inp
line 1a	line 2a
<b>##include</b> file2.inp	line 2b
line 1b	line 2c
line 1c	

The end result of processing **##include** input1.inp will be:

```
line 1a      (from input1.inp)
line 2a      (from file2.inp)
line 2b      (from file2.inp)
line 2c      (from file2.inp)
line 1b      (from input1.inp)
line 1c      (from input1.inp)
```

External files can also contain **##include** commands, as shown in the following example:

Main input file:	First external file:	Second external file:
input1.inp	file2.inp	file3.inp
line 1a	line 2a	line 3a
<b>##include</b> file2.inp	line 2b	line 3b
line 1b	<b>##include</b> file3.inp	line 3c
line 1c	line 2c	line 3d

The end result of processing `##include input1.tmp` will be:

```
line 1a      (from input1.inp)
line 2a      (from file2.inp)
line 2b      (from file2.inp)
line 3a      (from file3.inp)
line 3b      (from file3.inp)
line 3c      (from file3.inp)
line 3d      (from file3.inp)
line 2c      (from file2.inp)
line 1b      (from input1.inp)
line 1c      (from input1.inp)
```

Note: Up to nine `##include` commands can be nested. However, there should be no recursion. This is an example of a recursion:

```
file1.inp contains ##include file2.inp
file2.inp contains ##include file1.inp
```

## (2) Selectively Accepting or Skipping Lines of Input

The `##if` series of commands is used to selectively accept or skip lines of input according to the following sequence:

```
##if {condition1}
    line1a
    line1b
    ....
##elseif {condition2}
    line2a
    line2b
    ....
##elseif {condition3}
    line3a
    line3b
    ....
##else
    lineNa
    lineNb
    ....
##endif
```



Then the lines that will be included into the BDL stream are:

```

line1a  )
line1b  )  if {condition 1} is TRUE,
....    )
        )  otherwise

line2a  )
line2b  )  if {condition 2} is TRUE,
....    )
        )  otherwise

line3a  )
line3b  )  if {condition 3} is TRUE,
....    )
        )  otherwise

lineNa  )
lineNb  )  if {condition 1}, {condition 2},
....    )  {condition 3} are all FALSE.

```

There are six different `##if...` commands:

Command	Result
<code>##ifdef</code> {macro name}	: if macro name defined, include following lines
<code>##ifndef</code> {macro name}	: if macro name NOT defined, include following lines
<code>##if</code> {condition}	: if condition is TRUE, include following lines
<code>##elseif</code> {condition}	: if condition is TRUE, and previous conditions are FALSE, include following lines
<code>##else</code>	: if all previous conditions are FALSE, include following lines
<code>##endif</code>	: indicates the end of the if block
Notes:	
{macro name} is explained in (3), below.	
{condition} is 0 or BLANK meaning FALSE, and any other character meaning TRUE.	
<code>##ifdef</code> and <code>##ifndef</code> do not have corresponding <code>##elseif</code> commands, but they do have corresponding <code>##else</code> and <code>##endif</code> commands.	



Macro definitions may have one or more arguments; the maximum number of arguments is 32. When a macro with arguments is referenced, its arguments must be given values.

**Example:** Define a macro with name "sched" and argument "x":

```
##def sched[x] SCHEDULE THRU DEC 31 (ALL) (1,24) (x)

##endif
```

Then, when we put the following in the BDL input stream

```
SCHED2 = sched[.20] ..
SCHED3 = sched[.33] ..
```

the result is equivalent to:

```
SCHED2 = SCHEDULE THRU DEC 31 (ALL) (1,24) (.20) ..
SCHED3 = SCHEDULE THRU DEC 31 (ALL) (1,24) (.33) ..
```

Macro names must be unique (except see `##set1` below); i.e., when a macro name is defined it cannot be defined again.

To summarize, commands you use to define macros are the following:

```
##def macro-name [arg1,..,argn] macro-text
```

Defines a macro with the name "macro-name" and arguments "arg1" through "argn". "Macro-text" is one or more lines of text. If there are no arguments, the syntax is `##def macro-name macro-text`

```
##endif
```

Indicates the end of the macro definition initiated by `##def`.

```
##def1 macro-name [arg1,..,argn] macro-text
```

This is the same as `##def` but there is only one line of text so that the terminating command `##endif` is not required.

`##set1 macro-name macro-text`

Like `##def1` but has no arguments and macro-text is evaluated before storing. "Macro-text is evaluated" means that if macro-text contains other macros, these macros will be expanded, and the expanded text becomes the macro-text defined by `##set1`.

Example: `##def1 xx 123`  
`##set1 yy xx [ ]`

is equivalent to:  
`##set1 yy 123`

`##set1` can also be used to redefine macro-name.

Example: `##set1 x 0`  
.  
.  
.  
`##set1 x #eval[x [ ]+1]`

(see (4), Arithmetic Operations, for description of the `#eval` macro.)

#### (4) Arithmetic Operations

The built-in macro called #eval[ ] can be used to perform arithmetic, literal, and logical operations. It can be abbreviated to #[ ].

#eval[ X OP Y ] or #[ X OP Y ] gives the result X OP Y. The allowed values for X, OP, and Y, and the corresponding result, are shown in the following table.

X*	OP**	Y	Result
number	+(plus)	number	number
number	-(minus)	number	number
number	*(times)	number	number
number	/(divided by)	number	number
number	min	number	number
number	max	number	number
number	mod	number	number
number	**	number	number
SIN	OF	number (degrees)	number
COS	OF	number (degrees)	number
TAN	OF	number (degrees)	number
SQRT	OF	number	number
ABS	OF	number	number
ASIN	OF	number	number (degrees)
ACOS	OF	number	number (degrees)
ATAN	OF	number	number
INT	OF	number	number
LOG10	OF	number	number
LOG	OF	number	number
literal1	// (concatenate)	literal2	literal "literal1literal2"
literal1	/// (concatenate)	literal2	literal "literal1 literal2"
literal	EQS (=)	literal	logical (true or false)
literal	NES (≠)	literal	logical (true or false)
logical	AND	logical	logical (true or false)
logical	OR	logical	logical (true or false)
logical	NOT	logical	logical (true or false)
number	EQ (=)	number	logical (true or false)
number	NE (≠)	number	logical (true or false)
number	GT (>)	number	logical (true or false)
number	GE (≥)	number	logical (true or false)
number	LT (<)	number	logical (true or false)
number	LE (≤)	number	logical (true or false)

\* Upper or lower case is allowed for SIN, COS, etc.  
 \*\* Upper or lower case is allowed for OF, EQS, etc.

## Example

```
#eval[ 1 + 2 ]   when expanded becomes 3.  
#eval[ 1 + #eval[ 2 * 3 ] ]   when expanded becomes 7.
```

## Example

```
#set1 city Washington  
TITLE LINE-1 #["large office" /// city[ ] ]  
gives  
TITLE LINE-1 "large office Washington"
```

The following example illustrates the use of `#eval` inside `#if` commands:

```
##if #[ city[ ] EQS "Chicago" ]  
##if #[#[ city[ ] EQS "Chicago" ] and #[ occup[ ] NES "low" ] ]
```

### Notes:

1. For logical values:
  - False = 0 or BLANK,
  - True = any other character
2. A literal must be enclosed inside a pair of double quotes if it contains BLANKs or reserved characters like [ ] ( ) , \* =
  - E.g., "abc \*def"
  - Otherwise, the quotes around the literals are optional.
3. Literal concatenation operators // and /// produce quoted literals.
  - E.g., #[large /// office] gives "large office"
4. Literals are case sensitive. For example, "Chicago", "CHICAGO" "chicago" are distinct.

## (5) Macro Debugging and Listing Control

### ##list

Turn on listing; echo of input lines on the OUTPUT file is enabled. This is the default condition.

### ##nolist

Turn off listing; echo of input lines on the output file is disabled.

### ##show

Start printing expanded line on output file. After this command, if a macro expansion was done, the expanded line is printed on the output file. In this way you can see the end result of macro expansions, which is the input as seen by the BDL processor.

**##noshow**

Stop printing expanded line on output file. This is the default condition.

**##showdetail**

Start printing each macro expansion. After this command, every time a macro expansion is done the result of the expansion is printed. This can produce lots of output.

**##noshowdetail**

Stop printing each macro expansion. This is the default condition.

**##traceback**

Give full traceback when printing an error message. After this command, if there is a BDL error, a full traceback of the macro expansions in progress is printed. This is the default condition.

**##notraceback**

Don't give full traceback when printing an error message.

**##write**

Start writing expanded text into file 22. This is similar to **##show** except that the expanded lines are written into file 22. Therefore, file 22 will contain only the text that will be seen by the BDL processor. This file is used only for debugging purposes. It allows you to see what the macro-processed input file looks like.

**##nowrite**

Stop writing expanded text into file 22. This is the default condition.

**##symboltable**

Prints table of current macro names. All of the macro names that are defined will be printed.

**##clear**

Clear all macro definitions. All the macro names defined up to this point will be deleted.

**##reserve TEXT *k* NAMES *l* STACK *m***

Allocates memory.

Reserves *k* words of space in AA array for macro definition storage.

Reserves *l* positions in macro definition names table.

Reserves *m* words of stack space.

If used, the **##reserve** command must precede all other macro commands in the BDL input. This command should be used only if one or more of the following error messages is received:

“Need more memory for storing macro definitions”

Use “**##reserve TEXT *nnnnn***” command to get more memory. Current value of

*nnnnnn* is: \_ \_ \_

“Macro table capacity exceeded”

Use “**##reserve NAMES *nnnnnn***” command to get more memory. Current value of *nnnnnn* is: \_ \_ \_

“Macro stack overflow”

Use “**##reserve STACK *nnnnnn***” command to get more memory. Current value of *nnnnnn* is: \_ \_ \_

**##\$ <comment>**

Allows you to enter comment lines inside a macro. **<comment>** is printed in the BDL echo but is not acted on by the macro processor.



**Example:**

This example shows the use of the `##set`, `##include`, `##eval` and `##if` commands. Let an external file called `cities.lib` contain the following text:

```
##if  #[city[ ] EQS CHICAGO]

    BUILDING-LOCATION  LAT=41.88
                      LON=87.63
                      ALT=600
                      T-Z=6   $Chicago$
                      ..

##elseif  #[city[ ] EQS WASHINGTON]

    BUILDING-LOCATION  LAT=38.9
                      LON=77
                      ALT=50
                      T-Z=5   $Washington$
                      ..

##else
    ERROR--City Undefined
##endif
```

Then the BDL input

```
INPUT LOADS ..
##set1      city CHICAGO
##include   cities.lib
.
```

will be converted, after macro processing, to:

```
INPUT LOADS ..
BUILDING-LOCATION  LAT=41.88
                  LON=87.63
                  ALT=600
                  T-Z=6   $Chicago$
                  ..
.
```

### Listing Format

The format of listing in DOE-2.1D has been changed to give information about the status of the input macros, as shown in the following:

```
1.1.1 * 123 * ..... DOE-2 input line
-----
↑
↑
↑
↑
↑
echo of DOE-2 input line
line number ( if the current line is being skipped
               by "##if..." etc, this is indicated
               by printing "- 123 -" instead of
               "* 123 *" in the line number field;
               if the current line is part of a
               macro command, it is indicated by
               printing "# 123 #" )
macro expansion nesting level
"##if" nesting level
"##include" nesting level
```

## Library Example

Following is a listing of individual files. File samp7.inp is the DOE-2 input file; the library files that are needed by samp7.inp are the following: samp7loc.inp and samp7lib.inc.

### DOE-2 input and "include" files

```
$----- file : samp7.inp ----- DOE2.1E sample run 7 -----
##write

input LOADS ..
##includesilent samp7loc.inc

run-period JAN 1 1981 THRU JAN 7 1981 ..

LOCATION[chicago] azimuth = 0 ..

WA-1-2 = layers material = (WD01,PW03,IN02,GP01) ..
RB-1-1 = layers material = (RG01,BR01,IN22,WD01) i-f-r = .76 ..
WALL-typl = construction layers = WA-1-2 ..
ROOF-typl = construction layers = RB-1-1 ..
IWF-typl = construction u = 0.5 ..
FLOOR-typl = construction u = 0.05 ..
GT-typl = glass-type p=1 s-c=.60 ..

$-----SPACE CONDITIONS-----$

OCC-SCH= schedule THRU DEC 31 (WD) (1,7)(0) (8,17)(1) (18,24)(0)
              (WEH)(1,24)(0) ..
CORE-LITE-SCH= schedule THRU DEC 31 (WD) (1,6)(0) (7,18)(1) (19,24)(0)
              (WEH)(1,24)(0) ..
INF-SCH= schedule THRU DEC 31 (WD) (1,7)(0) (8,17)(1) (18,24)(0)
              (WEH)(1,24)(0) ..
PERIM-LITE-SCH= schedule THRU DEC 31 (WD) (1,6)(0) (7,18)(.8) (19,24)(0)
              (WEH)(1,24)(0) ..

CORE= space-conditions t = (75)
              people-schedule = OCC-SCH people-heat-gain = 450
              area/person = 100
              lighting-schedule = CORE-LITE-SCH
              lighting-w/sqft = 2
              light-to-space = .75 light-to-return = .25
              inf-method = AIR-CHANGE inf-schedule = INF-SCH
              air-changes/hr = 0.8
              z-type = CONDITIONED ..

PERIM= space-conditions like CORE
              area/person = 90
              lighting-schedule = PERIM-LITE-SCH
              air-changes/hr = 0.6 ..
```

```
$----- set some macros for glass type and constructions.
```

```
##set1 GLASS_TYPE GT-typl
##set1 EW_CONS WALL-typl
##set1 IW_CONS IWF-typl
##set1 ROOF_CONS ROOF-typl
##set1 UGF_CONS FLOOR-typl
```

```
##include samp7lib.inc
```

```
##$---- now generate each floor.
```

```
##$
##$ # W D H perim_D window space conditions for
##$ frac core north south east west
##$ ---
$
$----- ground floor
FLOOR{ g, 100, 50, 10, 15 , .20, CORE, PERIM, PERIM, PERIM, PERIM }
$----- 1st floor
FLOOR{ 1, 100, 50, 10, 15 , .30, CORE, PERIM, PERIM, PERIM, PERIM }
$----- top floor
FLOOR{ t, 100, 50, 10, 15 , .30, CORE, PERIM, PERIM, PERIM, PERIM }
```

```
end ..
```

```
compute LOADS ..
```

```
stop ..
```

---

```
##$ file:samp7loc.inc
```

```
##$
```

```
##$ This file contains the LOCATION[Name] macro, that produces the
##$ 'building-location' command. Here 'Name' is the name of the
##$ city.
```

```
##$ An example of usage is :
```

```
##$ LOCATION[chicago] azimuth = 0 ..
```

```
##$
```

```
##def LOCATION[Name]
```

```
##nolist
```

```
building-location
```

```
##if #[Name eqs boston]
```

```
lat = 42.37 lon = 71.07 alt = 50 t-z = 5
```

```
##elseif #[Name eqs newyork]
```

```
lat = 40.72 lon = 74.00 alt = 50 t-z = 5
```

```
##elseif #[Name eqs philadelphia]
```

```
lat = 39.95 lon = 75.17 alt = 50 t-z = 5
```

```
##elseif #[Name eqs detroit]
```

```
lat = 42.33 lon = 83.00 alt = 600 t-z = 5
```

```
##elseif #[Name eqs chicago]
```

```
lat = 41.88 lon = 87.63 alt = 600 t-z = 6
```

```

##elseif #[Name eqs sanfrancisco]
    lat = 37.78 lon = 122.42 alt = 50 t-z = 8
##elseif #[Name eqs losangeles]
    lat = 34.07 lon = 118.25 alt = 50 t-z = 8
##elseif #[Name eqs sandiego]
    lat = 32.72 lon = 117.15 alt = 50 t-z = 8
##elseif #[Name eqs phoenix]
    lat = 33.45 lon = 112.07 alt = 1000 t-z = 7
##else
Abort -- building location undefined in file : samp7loc.inc
##endif

```

```

##$ defaults for all locations:
    hol = YES daylight-savings = YES
##list
##enddef

```

---

```

##$ file : samp7lib.inc
##$
##$ This file contains the FLOOR[...] and PERIM-SPACE[...] macros.
##$ The FLOOR[...] macro is used for specifying one floor of the
##$ building with given dimensions. It uses the PERIM-SPACE[...]
##$ macro to create the perimeter spaces.
##$
##$ -----
##$ The following macro defines one floor of the building.
##$ Its arguments are :
##$ floor_NUM : g for ground floor; 1 for first floor ;
##$             2 for second floor; etc. ; t for top floor .
##$             s for single floor building.
##$ floor_W   : floor width.
##$ floor_D   : floor depth.
##$ floor_H   : floor height.
##$ floor_perim_D : depth of the perimeter spaces.
##$ floor_winFrac : window to wall ratio for exterior surfaces.
##$ cond_C     : u-name of space conditions for the interior space.
##$ cond_N     : u-name of space conditions for the north space.
##$ In addition, the following macros must be set to define glass type,
##$ and wall constructions:
##$ GLASS_TYPE glass type of windows.
##$ EW_CONS    exterior-wall construction.
##$ IW_CONS    interior-wall construction.
##$ ROOF_CONS  roof construction.
##$ UGF_CONS   underground-wall, floor construction.
##$ WINDOW_HEIGHT .window height. ( default = 3.0 )
##$ -----

```



```

#[SP-NAM0[] // "_E"] = PERIM-SPACE[ _E, floor_W, 0, Z-SP[], -90
                                , AREA-SP[], floor_D, floor_winFrac
                                , cond_E ]
##set1 AREA-IW #[ 1.4142 * #[ floor_perim_D * floor_H ] ]
##if #[AREA-IW[] GT 0 ]
    interior-wall area = AREA-IW[]
                  next-to = #[ SP-NAM0[] // "_N" ]
                  construction = IW_CONS[] ..
    interior-wall area = AREA-IW[]
                  next-to = #[ SP-NAM0[] // "_S" ]
                  construction = IW_CONS[] ..
##endif

#[SP-NAM0[] // "_W"] = PERIM-SPACE[ _W, 0, floor_D, Z-SP[], 90
                                , AREA-SP[], floor_D, floor_winFrac
                                , cond_W ]
##if #[AREA-IW[] GT 0 ]
    interior-wall area = AREA-IW[]
                  next-to = #[ SP-NAM0[] // "_N" ]
                  construction = IW_CONS[] ..
    interior-wall area = AREA-IW[]
                  next-to = #[ SP-NAM0[] // "_S" ]
                  construction = IW_CONS[] ..
##endif

$----- Core space -----$
##set1 TMP1 #[ 2 * floor_perim_D ]
##set1 AREA-SP #[ #[floor_W - TMP1[]] * #[floor_D - TMP1[]] ]
##if #[ AREA-SP[] GT 0 ]
    #[SP-NAM0[] // "_C"] = space x = floor_perim_D y = floor_perim_D
                              z = Z-SP[] azimuth = 0 area = AREA-SP[]
                              volume = #[ AREA-SP[] * FLOOR-HEIGHT[] ]
                              space-conditions=cond_C ..
    interior-wall area = #[ #[floor_W - TMP1[]] * floor_H ]
                  next-to = #[ SP-NAM0[] // "_S" ]
                  construction = IW_CONS[] ..
    interior-wall area = #[ #[floor_W - TMP1[]] * floor_H ]
                  next-to = #[ SP-NAM0[] // "_N" ]
                  construction = IW_CONS[] ..
    interior-wall area = #[ #[floor_D - TMP1[]] * floor_H ]
                  next-to = #[ SP-NAM0[] // "_E" ]
                  construction = IW_CONS[] ..
    interior-wall area = #[ #[floor_D - TMP1[]] * floor_H ]
                  next-to = #[ SP-NAM0[] // "_W" ]
                  construction = IW_CONS[] ..

##if #[ floor_NUM EQS "g" ]
    underground-floor area = AREA-SP[] construction = UGF_CONS[] ..fR
##else
    interior-wall area = AREA-SP[]

```

```

                                next-to = #[ #["SP_" // FLOOR-PREV[]] // "_C"]
                                construction = IW_CONS[] ..
##endif

##if #[ floor_NUM EQS "t" ]
    roof      x = floor_perim_D y = floor_perim_D
              h = #[floor_D - #[ 2 * floor_perim_D ] ]
              w = #[floor_W - #[ 2 * floor_perim_D ] ]
              construction = ROOF_CONS[] ..
##endif
##endif
##$
##$ update the z-coordinate.
##set1 Z-SP #[ Z-SP[] + FLOOR-HEIGHT[] ]
##set1 FLOOR-PREV floor_NUM
##$
##endif

##$
##$-----
##$ The following macro defines one perimeter space.
##$ Its arguments are :
##$      sname :      part of the name of space. ( N, S, E, W )
##$      xx,yy,zz :   x, y, z location of the space.
##$      sazim :      space azimuth.
##$      sarea :      space area.
##$      swidth :     space width.
##$      swinFrac :   window to wall ratio of exterior surfaces.
##$      space_cond : u-name of space conditions.
##$ This macro uses the FLOOR_NUM[], FLOOR-HEIGHT[] and WINDOW_HEIGHT[]
##$ that are set by the FLOOR macro.
##$ It also uses :
##$ GLASS_TYPE macro to set the glass-type of windows.
##$ EW_CONS      macro to set the exterior-wall construction.
##$ IW_CONS      macro to set the interior-wall construction.
##$ ROOF_CONS    macro to set the roof construction.
##$ UGF_CONS     macro to set the underground-wall, floor construction.
##$-----
##$
##def PERIM-SPACE[ sname,xx,yy,zz,sazim,sarea,swidth,swinFrac,space_cond]

    space      x = xx y = yy z = zz azimuth = sazim area = sarea
              volume = #[ sarea * FLOOR-HEIGHT[] ]
              space-conditions = space_cond ..
    exterior-wall x = 0 y = 0 azimuth = 0 h = FLOOR-HEIGHT[]
              w = swidth construction = EW_CONS[] ..
    ##set1 TMP1 #[ #[swinFrac * #[FLOOR-HEIGHT[] * swidth]] / WINDOW_HEIGHT[] ]
    ##if #[ TMP1[] GT 0 ]
        window      x = #[ #[swidth - TMP1[]] / 2 ]
                  y = 3.0

```



```

        w = TMP1[]  h = WINDOW_HEIGHT[]
        glass-type = GLASS_TYPE[]  ..
##endif

##if #[ #FLOOR-NUM[] EQS "g" ] or #[FLOOR-NUM[] EQS "s" ] ]
    underground-floor area = sarea construction = UGF_CONS[] ..
##else
    interior-wall area = sarea construction = IW_CONS[]
    next-to = #[ #["SP_" // FLOOR-PREV[]] // sname ] ..
##endif

##if #[ #FLOOR-NUM[] EQS "t" ] or #[FLOOR-NUM[] EQS "s" ] ]
    roof x = 0 y = 0
        h = FLOOR-PERIM-D[]
        w = #[ swidth - FLOOR-PERIM-D[] ]
        construction = ROOF_CONS[] ..
##endif
##$
##enddef
=====

```

Following is the BDL listing that results from running the samp7.inp file as an input to DOE-2.

```

****      ***      *****      ***      *      ****
*  *  *  *  *      *      *  *      **      *
*  *  *  *  *****  ***      *      *      ***
*  *  *  *  *      *      **      *      *
****      ***      *****      *****  *  ***  ****

```

BUILDING ENERGY ANALYSIS PROGRAM

DEVELOPED BY  
LAWRENCE BERKELEY LABORATORY/UNIVERSITY OF CALIFORNIA,  
WITH THE ASSISTANCE OF HIRSCH & ASSOCIATES, CAMARILLO, CA  
WITH MAJOR SUPPORT FROM  
UNITED STATES DEPARTMENT OF ENERGY  
ASSISTANT SECRETARY FOR CONSERVATION AND RENEWABLE ENERGY  
OFFICE OF BUILDING TECHNOLOGIES  
BUILDING SYSTEMS AND MATERIALS DIVISION  
AND ADDITIONAL SUPPORT FROM  
SOUTHERN CALIFORNIA EDISON CO., PACIFIC GAS AND ELECTRIC CO.,  
GAS RESEARCH INSTITUTE, ELECTRIC POWER RESEARCH INSTITUTE  
COPYRIGHT 1993 REGENTS OF THE UNIVERSITY OF CALIFORNIA,  
LAWRENCE BERKELEY LABORATORY

\*\*\*\*\* L E G A L N O T I C E \*\*\*\*\*  
\* This program was prepared as an account of work sponsored by the \*  
\* United States government. Neither the United States nor the \*  
\* Department of Energy, nor any of their employees, nor any of \*  
\* their contractors, subcontractors, or their employees makes any \*  
\* warranty, express or implied, or assumes any legal liability or \*  
\* responsibility for the accuracy, completeness or usefulness of \*  
\* any information, apparatus, product or process disclosed, or \*  
\* represents that its use would not infringe privately owned rights.\*  
\*\*\*\*\*

LBL RELEASE SEP 1993            version : 2.1E-B20

```

* 1 * $----- file : samp7.inp ----- DOE2.1E sample run 7 -----
* 2 *
# 3 # ##write
* 4 *
* 5 * input LOADS ..

```

LDL PROCESSOR INPUT DATA

Thu Jul 29 16:39:33 1993LDL RUN 1

```

# 6 # ##includesilent samp7loc.inc
file : INPUT2.TMP
* 7 *
* 8 * run-period JAN 1 1981 THRU JAN 7 1981 ..
* 9 *
* 10 * LOCATION[chicago] azimuth = 0 ..
.1# 36 # ##list
* 11 *
* 12 * WA-1-2 = layers material = (WD01,PW03,IN02,GP01) ..
* 13 * RB-1-1 = layers material = (RG01,BR01,IN22,WD01) i-f-r = .76 ..
* 14 * WALL-typ1 = construction layers = WA-1-2 ..
* 15 * ROOF-typ1 = construction layers = RB-1-1 ..
* 16 * IWF-typ1 = construction u = 0.5 ..
* 17 * FLOOR-typ1 = construction u = 0.05 ..
* 18 * GT-typ1 = glass-type p=1 s-c=.60 ..
* 19 *
* 20 * $-----SPACE CONDITIONS-----$
* 21 *
* 22 * OCC-SCH= schedule THRU DEC 31 (WD) (1,7)(0) (8,17)(1) (18,24)(0)
* 23 * (WEH)(1,24)(0) ..
* 24 * CORE-LITE-SCH= schedule THRU DEC 31 (WD) (1,6)(0) (7,18)(1) (19,24)(0)
* 25 * (WEH)(1,24)(0) ..
* 26 * INF-SCH= schedule THRU DEC 31 (WD) (1,7)(0) (8,17)(1) (18,24)(0)
* 27 * (WEH)(1,24)(0) ..
* 28 * PERIM-LITE-SCH= schedule THRU DEC 31 (WD) (1,6)(0) (7,18)(.8) (19,24)(0)
* 29 * (WEH)(1,24)(0) ..
* 30 *
* 31 * CORE= space-conditions t = (75)
* 32 * people-schedule = OCC-SCH people-heat-gain = 450
* 33 * area/person = 100
* 34 * lighting-schedule = CORE-LITE-SCH
* 35 * lighting-w/sqft = 2
* 36 * light-to-space = .75 light-to-return = .25
* 37 * inf-method = AIR-CHANGE inf-schedule = INF-SCH
* 38 * air-changes/hr = 0.8
* 39 * z-type = CONDITIONED ..
* 40 * PERIM= space-conditions like CORE
* 41 * area/person = 90
* 42 * lighting-schedule = PERIM-LITE-SCH
* 43 * air-changes/hr = 0.6 ..

```

```

* 44 *
* 45 * $----- set some macros for glass type and constructions.
* 46 *
# 47 # ##set1 GLASS_TYPE GT-typl
# 48 # ##set1 EW_CONS WALL-typl
# 49 # ##set1 IW_CONS IWF-typl
# 50 # ##set1 ROOF_CONS ROOF-typl
# 51 # ##set1 UGF_CONS FLOOR-typl
* 52 *
# 53 # ##include samp7lib.inc
1 # 1 # ##$ file : samp7lib.inc
1 # 2 # ##$
1 # 3 # ##$ This file contains the FLOOR[...] and PERIM-SPACE[...] macros.
1 # 4 # ##$ The FLOOR[...] macro is used for specifying one floor of the
1 # 5 # ##$ building with given dimensions. It uses the PERIM-SPACE[...]
1 # 6 # ##$ macro to create the perimeter spaces.
1 # 7 # ##$
1 # 8 # ##$-----
1 # 9 # ##$ The following macro defines one floor of the building.
1 # 10 # ##$ Its arguments are :
1 # 11 # ##$ floor_NUM : g for ground floor; 1 for first floor ;
1 # 12 # ##$ 2 for second floor; etc. ; t for top floor .
1 # 13 # ##$ s for single floor building.
1 # 14 # ##$ floor_W : floor width.
1 # 15 # ##$ floor_D : floor depth.
1 # 16 # ##$ floor_H : floor height.
1 # 17 # ##$ floor_perim_D : depth of the perimeter spaces.
1 # 18 # ##$ floor_winFrac : window to wall ratio for exterior surfaces.
1 # 19 # ##$ cond_C : u-name of space conditions for the interior space.
1 # 20 # ##$ cond_N : u-name of space conditions for the north space.
1 # 21 # ##$ In addition, the following macros must be set to define glass type,
1 # 22 # ##$ and wall constructions:
1 # 23 # ##$ GLASS_TYPE glass type of windows.
1 # 24 # ##$ EW_CONS exterior-wall construction.
1 # 25 # ##$ IW_CONS interior-wall construction.
1 # 26 # ##$ ROOF_CONS roof construction.
1 # 27 # ##$ UGF_CONS underground-wall,floor construction.
1 # 28 # ##$ WINDOW_HEIGHT window height. ( default = 3.0 )
1 # 29 # ##$-----

```

```

1 # 30 # ##$
1 # 31 # ##def FLOOR[ floor_NUM, floor_W, floor_D, floor_H, floor_perim_D, floor_winFrac
1 # 32 #           , cond_C, cond_N, cond_S, cond_E, cond_W]
1 # 33 # ##$
1 # 34 # ##$           ---->|           |<---- floor_perim_D
1 # 35 # ##$
1 # 36 # ##$
1 # 37 # ##$
1 # 38 # ##$           -----wwwwwwwww-----
1 # 39 # ##$           |\           //
1 # 40 # ##$           | \           / |
1 # 41 # ##$           |           | |
1 # 42 # ##$           |           | |
1 # 43 # ##$           w |           w |
1 # 44 # ##$           w |           w |
1 # 45 # ##$           w |           w |
1 # 46 # ##$           w |           w |
1 # 47 # ##$           |           | |
1 # 48 # ##$           |           | |
1 # 49 # ##$           | /           \ |
1 # 50 # ##$           |/           \|
1 # 51 # ##$           -----wwwwwwwww-----
1 # 52 # ##$
1 # 53 # ##$
1 # 54 # ##$           <----- floor_W ----->
1 # 55 # ##$
1 # 56 # ##ifndef WINDOW_HEIGHT
1 # 57 #           ##set1 WINDOW_HEIGHT 3.0
1 # 58 #           ##endif
1 # 59 # ##$
1 # 60 # ##ifndef Z-SP
1 # 61 #           ##set1 Z-SP 0
1 # 62 #           ##endif
1 # 63 # ##$
1 # 64 # ##set1 FLOOR-HEIGHT floor_H

```

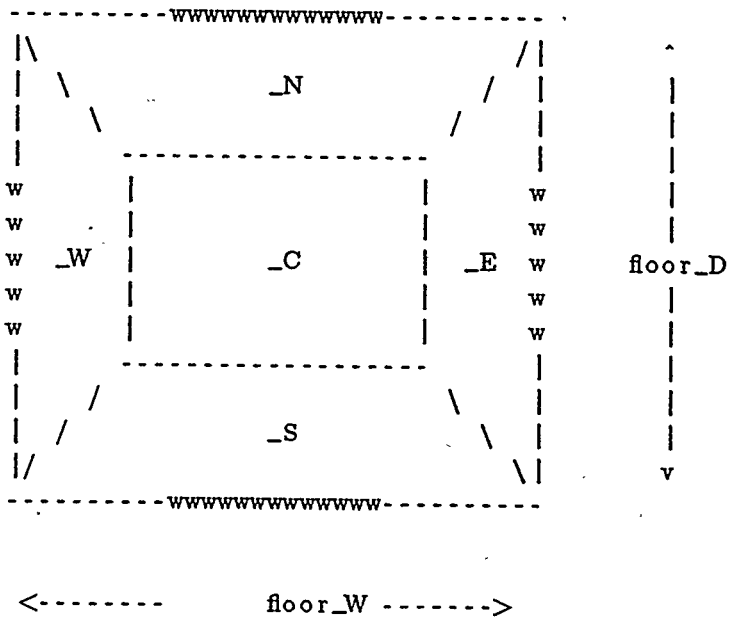

Example Shortened

```

1 # 196 # ##endif
1 # 197 # ##$
1 # 198 # ##enddef
file : INPUT2.TMP
* 54 *
# 55 # ##$---- now generate each floor.
# 56 # ##$
# 57 # ##$ # W D H perim_D window space conditions for

```

```

# 58 # ##$
# 59 # ##$      frac      core  north  south  east  west
* 60 * $
* 61 * $----- ground floor
* 62 * FLOOR[ g, 100, 50, 10, 15 , .20, CORE, PERIM, PERIM, PERIM, PERIM
.1# 32 # ##$
.1# 33 # ##$
.1# 34 # ##$      --->|      |<--- 15
.1# 35 # ##$
.1# 36 # ##$
.1# 37 # ##$
.1# 38 # ##$
.1# 39 # ##$
.1# 40 # ##$
.1# 41 # ##$
.1# 42 # ##$
.1# 43 # ##$
.1# 44 # ##$
.1# 45 # ##$
.1# 46 # ##$
.1# 47 # ##$
.1# 48 # ##$
.1# 49 # ##$
.1# 50 # ##$
.1# 51 # ##$
.1# 52 # ##$
.1# 53 # ##$
.1# 54 # ##$
.1# 55 # ##ifdef WINDOW_HEIGHT
.1# 56 # ##set1 WINDOW_HEIGHT 3.0
.1# 57 # ##endif
.1# 58 # ##$
.1# 59 # ##ifdef Z-SP
.1# 60 # ##set1 Z-SP 0
.1# 61 # ##endif
.1# 62 # ##$
.1# 63 # ##set1 FLOOR-HEIGHT 10
.1# 64 # ##set1 FLOOR-NUM g
.1# 65 # ##set1 FLOOR-PERIM-D 15
.1# 66 # ##$
.1# 67 # ##set1 SP-NAM0 #["SP_" // g]
.1# 68 # ##$
.1# 69 # ##set1 AREA-SP #[ 15 * #[ 100 - 15 ] ]
.1* 70 * #[SP-NAM0[] // "_N"] = PERIM-SPACE[ _N, 100, 50, Z-SP[],180
.1* 71 * , AREA-SP[], 100, .20
.1* 72 * , PERIM ]
.2* 170 *
.2* 171 * space x = 100 y = 50 z = Z-SP[] azimuth = 180 area = AREA-S
.2* 171 * P[]
.2* 172 *
volume = #[ AREA-SP[] * FLOOR-HEIGHT[] ]

```

```

.2* 173 *                space-conditions = PERIM ..
.2* 174 *                exterior-wall x = 0 y = 0 azimuth = 0 h = FLOOR-HEIGHT[]
.2* 175 *                w = 100 construction = EW_CONS[] ..
.2# 176 #                ##set1 TMP1 #[ # [.20 * # [FLOOR-HEIGHT[] * 100]] / WINDOW-HEIGHT[] ]
.2# 177 #                ##if #[ TMP1[] GT 0 ]
.1.2* 178 *                window x = #[ # [100 - TMP1[]] / 2 ]
.1.2* 179 *                y = 3.0
.1.2* 180 *                w = TMP1[] h = WINDOW-HEIGHT[]
.1.2* 181 *                glass-type = GLASS_TYPE[] ..
.2# 182 #                ##endif
.2* 183 *
.2# 184 #                ##if #[ # [FLOOR-NUM[] EQS "g"] or # [FLOOR-NUM[] EQS "s"] ]
.1.2* 185 *                underground-floor area = AREA-SP[] construction = UGF_CONS[] ..
.2# 186 #                ##else
.1.2- 187 -                interior-wall area = AREA-SP[] construction = IW_CONS[]
.1.2- 188 -                next-to = #[ # ["SP_" // FLOOR-PREV[]] // "_N" ] ..
.2# 189 #                ##endif
.2* 190 *
.2# 191 #                ##if #[ # [FLOOR-NUM[] EQS "t"] or # [FLOOR-NUM[] EQS "s"] ]
.1.2- 192 -                roof x = 0 y = 0
.1.2- 193 -                h = FLOOR-PERIM-D[]
.1.2- 194 -                w = #[ 100 - FLOOR-PERIM-D[] ]
.1.2- 195 -                construction = ROOF_CONS[] ..
.2# 196 #                ##endif
.2# 197 #                ##$
.1* 73 *

```

.
.
.
Example Shortened
.
.
.

```

* 65 * $----- top floor
* 66 * FLOOR[ t, 100, 50, 10, 15, .30, CORE, PERIM, PERIM, PERIM, PERIM
.1# 32 # ##$
.1# 33 # ##$
.1# 34 # ##$
.1# 35 # ##$
.1# 36 # ##$
.1# 37 # ##$
.1# 38 # ##$
.1# 39 # ##$
.1# 40 # ##$
.1# 41 # ##$
.1# 42 # ##$
.1# 43 # ##$
.1# 44 # ##$
.1# 45 # ##$
.1# 46 # ##$
.1# 47 # ##$
.1# 48 # ##$
.1# 49 # ##$
.1# 50 # ##$
.1# 51 # ##$
.1# 52 # ##$
.1# 53 # ##$
.1# 54 # ##$
.1.1# 55 # ##ifndef WINDOW_HEIGHT
.1.1- 56 - ##set1 WINDOW_HEIGHT 3.0
.1# 57 # ##endif
.1# 58 # ##$
.1.1# 59 # ##ifndef Z-SP
.1.1- 60 - ##set1 Z-SP 0
.1# 61 # ##endif
.1# 62 # ##$
.1# 63 # ##set1 FLOOR-HEIGHT 10
.1# 64 # ##set1 FLOOR-NUM t
.1# 65 # ##set1 FLOOR-PERIM-D 15
.1# 66 # ##$
.1# 67 # ##set1 SP-NAM0 #["SP_" // t]
.1# 68 # ##$
.1# 69 # ##set1 AREA-SP #[ 15 * #[ 100 - 15 ] ]
.1* 70 * #[SP-NAM0[] // "_N"] = PERIM-SPACE[ _N, 100, 50, Z-SP[], 180
.1* 71 * , AREA-SP[], 100, .30
.1* 72 * , PERIM ]
.2* 170 *
.2* 171 * space x = 100 y = 50 z = Z-SP[] azimuth = 180 area = AREA-S
.2* 171 * P[]
.2* 172 * volume = #[ AREA-SP[] * FLOOR-HEIGHT[] ]
.2* 173 * space-conditions = PERIM ..
.2* 174 * exterior-wall x = 0 y = 0 azimuth = 0 h = FLOOR-HEIGHT[]
.2* 175 * w = 100 construction = EW_CONS[] ..

```

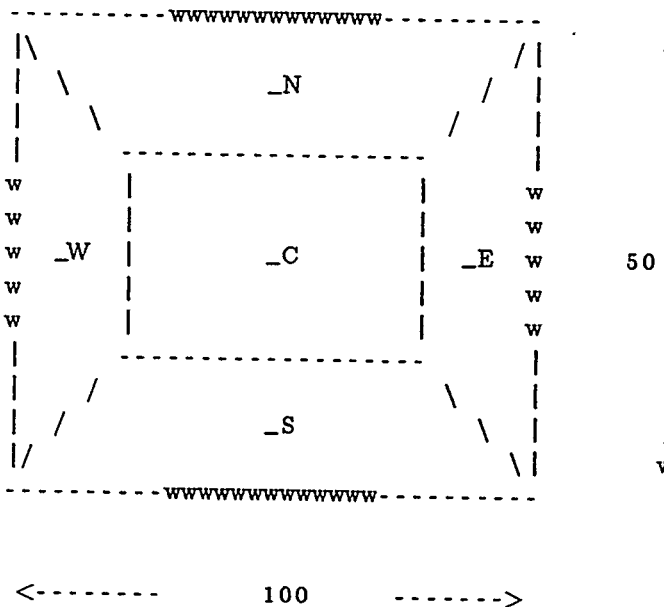



```

.2# 176 #   ##set1 TMP1 #[ #[.30 * #[FLOOR-HEIGHT[] * 100]] / WINDOW_HEIGHT[] ]
.2# 177 #   ##if #[ TMP1[] GT 0 ]
.1.2* 178 *       window      x = #[ #[100 - TMP1[]] / 2 ]
.1.2* 179 *                   y = 3.0
.1.2* 180 *                   w = TMP1[]  h = WINDOW_HEIGHT[]
.1.2* 181 *                   glass-type = GLASS_TYPE[] ..
.2# 182 #   ##endif
.2* 183 *
.2# 184 #   ##if #[ #[FLOOR-NUM[] EQS "g"] or #[FLOOR-NUM[] EQS "s"] ]
.1.2- 185 -       underground-floor  area = AREA-SP[]  construction = UGF_CONS[] ..
.2# 186 #   ##else
.1.2* 187 *       interior-wall      area = AREA-SP[]  construction = IW_CONS[]
.1.2* 188 *                   next-to = #[ #[ "SP_" // FLOOR-PREV[] ] // _N ] ..
.2# 189 #   ##endif
.2* 190 *
.2# 191 #   ##if #[ #[FLOOR-NUM[] EQS "t"] or #[FLOOR-NUM[] EQS "s"] ]
.1.2* 192 *       roof      x = 0  y = 0
.1.2* 193 *                   h = FLOOR-PERIM-D[]
.1.2* 194 *                   w = #[ 100 - FLOOR-PERIM-D[] ]
.1.2* 195 *                   construction = ROOF_CONS[] ..
.2# 196 #   ##endif
.2# 197 # ##$
.1* 73 *
.1* 74 *   #[SP-NAM0[] // "_S"] = PERIM-SPACE[ _S, 0, 0, Z-SP[], 0
.1* 75 *                   , AREA-SP[], 100, .30
.1* 76 *                   , PERIM ]

```

.
  
.
  
.
  
Example Shortened
  
.
  
.
  
.

```

* 67 *
* 68 * end ..
* 69 * compute LOADS ..
* 70 * stop ..

```

Following is the listing of the file for022.dat. This file is requested by the “##write” command in file office.inp. Note that this file shows the end result of macro processing; i.e., all the macro commands are taken out and all macro expansions are done.

```

< 4 >
< 5 > input LOADS ..
< 7 >
< 8 >     run-period JAN 1 1981 THRU JAN 7 1981 ..
< 9 >
< 10 >
< 11 >     building-location
< 21 >             lat = 41.88 lon = 87.63 alt = 600 t-z = 6
< 33 >
< 35 >     hol = YES daylight-savings = YES
< 11 >
< 12 > WA-1-2 = layers material = (WD01,PW03,IN02,GP01) ..
< 13 > RB-1-1 = layers material = (RG01,BR01,IN22,WD01) i-f-r = .76 ..
< 14 > WALL-typ1 = construction layers = WA-1-2 ..
< 15 > ROOF-typ1 = construction layers = RB-1-1 ..
< 16 > IWF-typ1 = construction u = 0.5 ..
< 17 > FLOOR-typ1 = construction u = 0.05 ..
< 18 > GT-typ1 = glass-type p=1 s-c=.60 ..
< 19 >
< 20 > $-----SPACE CONDITIONS-----$
< 21 >
< 22 > OCC-SCH= schedule THRU DEC 31 (WD) (1,7)(0) (8,17)(1) (18,24)(0)
< 23 > (WEH)(1,24)(0) ..
< 24 > CORE-LITE-SCH= schedule THRU DEC 31 (WD) (1,6)(0) (7,18)(1) (19,24)(0)
< 25 > (WEH)(1,24)(0) ..
< 26 > INF-SCH= schedule THRU DEC 31 (WD) (1,7)(0) (8,17)(1) (18,24)(0)
< 27 > (WEH)(1,24)(0) ..
< 28 > PERIM-LITE-SCH= schedule THRU DEC 31 (WD) (1,6)(0) (7,18)(.8) (19,24)(0)
< 29 > (WEH)(1,24)(0) ..
< 30 >
< 31 > CORE= space-conditions t = (75)
< 32 > people-schedule = OCC-SCH people-heat-gain = 450
< 33 > area/person = 100
< 34 > lighting-schedule = CORE-LITE-SCH
< 35 > lighting-w/sqft = 2
< 36 > light-to-space = .75 light-to-return = .25
< 37 > inf-method = AIR-CHANGE inf-schedule = INF-SCH
< 38 > air-changes/hr = 0.8
< 39 > z-type = CONDITIONED ..
< 40 > PERIM= space-conditions like CORE
< 41 > area/person = 90
< 42 > lighting-schedule = PERIM-LITE-SCH
< 43 > air-changes/hr = 0.6 ..
< 44 >
< 45 > $----- set some macros for glass type and constructions.

```

```

< 46 >
< 52 >
< 147 >
< 54 >
< 60 > $
< 61 > $----- ground floor
< 70 > "SP_g_N" =
< 170 >
< 171 > space x = 100 y = 50 z = 0 azimuth = 180 area = 1275
< 172 > volume = 12750
< 173 > space-conditions = PERIM ..
< 174 > exterior-wall x = 0 y = 0 azimuth = 0 h = 10
< 175 > w = 100 construction = WALL-typ1 ..
< 178 > window x = 16.666666031
< 179 > y = 3.0
< 180 > w = 66.666664124 h = 3.0
< 181 > glass-type = GT-typ1 ..
< 183 >
< 185 > underground-floor area = 1275 construction = FLOOR-typ1 ..
< 190 >
< 73 >
< 74 > "SP_g_S" =
< 170 >
< 171 > space x = 0 y = 0 z = 0 azimuth = 0 area = 1275
< 172 > volume = 12750
< 173 > space-conditions = PERIM ..
< 174 > exterior-wall x = 0 y = 0 azimuth = 0 h = 10
< 175 > w = 100 construction = WALL-typ1 ..
< 178 > window x = 16.666666031
< 179 > y = 3.0
< 180 > w = 66.666664124 h = 3.0
< 181 > glass-type = GT-typ1 ..
< 183 >
< 185 > underground-floor area = 1275 construction = FLOOR-typ1 ..
< 190 >
< 77 >
< 79 > "SP_g_E" =
< 170 >
< 171 > space x = 100 y = 0 z = 0 azimuth = -90 area = 525
< 172 > volume = 5250
< 173 > space-conditions = PERIM ..
< 174 > exterior-wall x = 0 y = 0 azimuth = 0 h = 10
< 175 > w = 50 construction = WALL-typ1 ..
< 178 > window x = 8.333333969
< 179 > y = 3.0
< 180 > w = 33.333332062 h = 3.0
< 181 > glass-type = GT-typ1 ..
< 183 >
< 185 > underground-floor area = 525 construction = FLOOR-typ1 ..
< 190 >

```

```

< 84 > interior-wall area = 212.129989624
< 85 > next-to = "SP_g_N"
< 86 > construction = IWF-typl ..
< 87 > interior-wall area = 212.129989624
< 88 > next-to = "SP_g_S"
< 89 > construction = IWF-typl ..
< 91 >
< 92 > "SP_g_W" =
< 170 >
< 171 > space x = 0 y = 50 z = 0 azimuth = 90 area = 525
< 172 > volume = 5250
< 173 > space-conditions = PERIM ..
< 174 > exterior-wall x = 0 y = 0 azimuth = 0 h = 10
< 175 > w = 50 construction = WALL-typl ..
< 178 > window x = 8.333333969
< 179 > y = 3.0
< 180 > w = 33.333332062 h = 3.0
< 181 > glass-type = GT-typl ..
< 183 >
< 185 > underground-floor area = 525 construction = FLOOR-typl ..
< 190 >
< 96 > interior-wall area = 212.129989624
< 97 > next-to = "SP_g_N"
< 98 > construction = IWF-typl ..
< 99 > interior-wall area = 212.129989624
< 100 > next-to = "SP_g_S"
< 101 > construction = IWF-typl ..
< 103 >
< 104 > $----- Core space -----$
< 108 > "SP_g_C" = space x = 15 y = 15
< 109 > z = 0 azimuth = 0 area = 1400
< 110 > volume = 14000
< 111 > space-conditions=CORE ..
< 112 > interior-wall area = 700
< 113 > next-to = "SP_g_S"
< 114 > construction = IWF-typl ..
< 115 > interior-wall area = 700
< 116 > next-to = "SP_g_N"
< 117 > construction = IWF-typl ..
< 118 > interior-wall area = 200
< 119 > next-to = "SP_g_E"
< 120 > construction = IWF-typl ..
< 121 > interior-wall area = 200
< 122 > next-to = "SP_g_W"
< 123 > construction = IWF-typl ..
< 124 >
< 126 > underground-floor area = 1400 construction = FLOOR-typl ..
< 132 >
< 63 > $----- 1st floor
< 70 > "SP_1_N" =

```

```

< 170 >
< 171 >   space           x = 100  y = 50  z = 10  azimuth = 180  area = 1275
< 172 >                                     volume = 12750
< 173 >                                     space-conditions = PERIM ..
< 174 >   exterior-wall  x = 0  y = 0  azimuth = 0  h = 10
< 175 >                                     w = 100  construction = WALL-typ1 ..
< 178 >   window         x = 0
< 179 >                                     y = 3.0
< 180 >                                     w = 100  h = 3.0
< 181 >                                     glass-type = GT-typ1 ..
< 183 >
< 187 >   interior-wall  area = 1275  construction = IWF-typ1
< 188 >                                     next-to = "SP_g_N" ..
< 190 >
< 73 >
< 74 >   "SP_1_S" =
< 170 >
< 171 >   space           x = 0  y = 0  z = 10  azimuth = 0  area = 1275
< 172 >                                     volume = 12750
< 173 >                                     space-conditions = PERIM ..
< 174 >   exterior-wall  x = 0  y = 0  azimuth = 0  h = 10
< 175 >                                     w = 100  construction = WALL-typ1 ..
< 178 >   window         x = 0
< 179 >                                     y = 3.0
< 180 >                                     w = 100  h = 3.0
< 181 >                                     glass-type = GT-typ1 ..
< 183 >
< 187 >   interior-wall  area = 1275  construction = IWF-typ1
< 188 >                                     next-to = "SP_g_S" ..
< 190 >
< 77 >
< 79 >   "SP_1_E" =
< 170 >
< 171 >   space           x = 100  y = 0  z = 10  azimuth = -90  area = 525
< 172 >                                     volume = 5250
< 173 >                                     space-conditions = PERIM ..
< 174 >   exterior-wall  x = 0  y = 0  azimuth = 0  h = 10
< 175 >                                     w = 50  construction = WALL-typ1 ..
< 178 >   window         x = 0
< 179 >                                     y = 3.0
< 180 >                                     w = 50  h = 3.0
< 181 >                                     glass-type = GT-typ1 ..
< 183 >
< 187 >   interior-wall  area = 525  construction = IWF-typ1
< 188 >                                     next-to = "SP_g_E" ..
< 190 >
< 84 >   interior-wall  area = 212.129989624
< 85 >                                     next-to = "SP_1_N"
< 86 >                                     construction = IWF-typ1 ..
< 87 >   interior-wall  area = 212.129989624

```

```

< 88 >
< 89 >                                     next-to = "SP_1_S"
< 91 >                                     construction = IWF-typl ..
< 92 > "SP_1_W" =
< 170 >
< 171 >     space           x = 0  y = 50  z = 10  azimuth = 90  area = 525
< 172 >                                     volume = 5250
< 173 >                                     space-conditions = PERIM ..
< 174 >     exterior-wall  x = 0  y = 0  azimuth = 0  h = 10
< 175 >                                     w = 50  construction = WALL-typl ..
< 178 >         window           x = 0
< 179 >                                     y = 3.0
< 180 >                                     w = 50  h = 3.0
< 181 >                                     glass-type = GT-typl ..
< 183 >
< 187 >     interior-wall      area = 525  construction = IWF-typl
< 188 >                                     next-to = "SP_g_W" ..
< 190 >
< 96 >                                     interior-wall  area = 212.129989624
< 97 >                                     next-to = "SP_1_N"
< 98 >                                     construction = IWF-typl ..
< 99 >                                     interior-wall  area = 212.129989624
< 100 >                                     next-to = "SP_1_S"
< 101 >                                     construction = IWF-typl ..
< 103 >
< 104 > $----- Core space -----$
< 108 >     "SP_1_C" = space  x = 15  y = 15
< 109 >
< 110 >                                     z = 10  azimuth = 0  area = 1400
< 111 >                                     volume = 14000
< 112 >                                     space-conditions=CORE ..
< 113 >     interior-wall  area = 700
< 114 >                                     next-to = "SP_1_S"
< 115 >                                     construction = IWF-typl ..
< 116 >     interior-wall  area = 700
< 117 >                                     next-to = "SP_1_N"
< 118 >                                     construction = IWF-typl ..
< 119 >     interior-wall  area = 200
< 120 >                                     next-to = "SP_1_E"
< 121 >                                     construction = IWF-typl ..
< 122 >     interior-wall  area = 200
< 123 >                                     next-to = "SP_1_W"
< 124 >                                     construction = IWF-typl ..
< 128 >     interior-wall      area = 1400
< 129 >                                     next-to = "SP_g_C"
< 130 >                                     construction = IWF-typl ..
< 132 >
< 65 > $----- top floor
< 70 >     "SP_t_N" =
< 170 >

```

```

< 171 >     space           x = 100  y = 50  z = 20  azimuth = 180  area = 1275
< 172 >                                     volume = 12750
< 173 >                                     space-conditions = PERIM ..
< 174 >     exterior-wall    x = 0  y = 0  azimuth = 0  h = 10
< 175 >                                     w = 100  construction = WALL-typ1 ..
< 178 >         window      x = 0
< 179 >                                     y = 3.0
< 180 >                                     w = 100  h = 3.0
< 181 >                                     glass-type = GT-typ1 ..
< 183 >
< 187 >     interior-wall    area = 1275  construction = IWF-typ1
< 188 >                                     next-to = "SP_1_N" ..
< 190 >
< 192 >     roof      x = 0  y = 0
< 193 >                                     h = 15
< 194 >                                     w = 85
< 195 >                                     construction = ROOF-typ1 ..
< 73 >
< 74 > "SP_t_S" =
< 170 >
< 171 >     space           x = 0  y = 0  z = 20  azimuth = 0  area = 1275
< 172 >                                     volume = 12750
< 173 >                                     space-conditions = PERIM ..
< 174 >     exterior-wall    x = 0  y = 0  azimuth = 0  h = 10
< 175 >                                     w = 100  construction = WALL-typ1 ..
< 178 >         window      x = 0
< 179 >                                     y = 3.0
< 180 >                                     w = 100  h = 3.0
< 181 >                                     glass-type = GT-typ1 ..
< 183 >
< 187 >     interior-wall    area = 1275  construction = IWF-typ1
< 188 >                                     next-to = "SP_1_S" ..
< 190 >
< 192 >     roof      x = 0  y = 0
< 193 >                                     h = 15
< 194 >                                     w = 85
< 195 >                                     construction = ROOF-typ1 ..
< 77 >
< 79 > "SP_t_E" =
< 170 >
< 171 >     space           x = 100  y = 0  z = 20  azimuth = -90  area = 525
< 172 >                                     volume = 5250
< 173 >                                     space-conditions = PERIM ..
< 174 >     exterior-wall    x = 0  y = 0  azimuth = 0  h = 10
< 175 >                                     w = 50  construction = WALL-typ1 ..
< 178 >         window      x = 0
< 179 >                                     y = 3.0
< 180 >                                     w = 50  h = 3.0
< 181 >                                     glass-type = GT-typ1 ..
< 183 >

```

```

< 187 >         interior-wall      area = 525  construction = IWF-typ1
< 188 >                                     next-to = "SP_1_E" ..
< 190 >
< 192 >         roof   x = 0  y = 0
< 193 >                 h = 15
< 194 >                 w = 35
< 195 >                 construction = ROOF-typ1 ..
< 84 >                                     interior-wall  area = 212.129989624
< 85 >                                     next-to = "SP_t_N"
< 86 >                                     construction = IWF-typ1 ..
< 87 >                                     interior-wall  area = 212.129989624
< 88 >                                     next-to = "SP_t_S"
< 89 >                                     construction = IWF-typ1 ..
< 91 >
< 92 > "SP_t_W" =
< 170 >
< 171 >         space           x = 0  y = 50  z = 20  azimuth = 90  area = 525
< 172 >                                     volume = 5250
< 173 >                                     space-conditions = PERIM ..
< 174 >         exterior-wall  x = 0  y = 0  azimuth = 0  h = 10
< 175 >                                     w = 50  construction = WALL-typ1 ..
< 178 >         window           x = 0
< 179 >                                     y = 3.0
< 180 >                                     w = 50  h = 3.0
< 181 >                                     glass-type = GT-typ1 ..
< 183 >
< 187 >         interior-wall      area = 525  construction = IWF-typ1
< 188 >                                     next-to = "SP_1_W" ..
< 190 >
< 192 >         roof   x = 0  y = 0
< 193 >                 h = 15
< 194 >                 w = 35
< 195 >                 construction = ROOF-typ1 ..
< 96 >                                     interior-wall  area = 212.129989624
< 97 >                                     next-to = "SP_t_N"
< 98 >                                     construction = IWF-typ1 ..
< 99 >                                     interior-wall  area = 212.129989624
< 100 >                                     next-to = "SP_t_S"
< 101 >                                     construction = IWF-typ1 ..
< 103 >
< 104 > $----- Core space -----$
< 108 >         "SP_t_C" = space   x = 15  y = 15
< 109 >                                     z = 20  azimuth = 0  area = 1400
< 110 >                                     volume = 14000
< 111 >                                     space-conditions=CORE ..
< 112 >         interior-wall  area = 700
< 113 >                                     next-to = "SP_t_S"
< 114 >                                     construction = IWF-typ1 ..
< 115 >         interior-wall  area = 700
< 116 >                                     next-to = "SP_t_N"

```



```
< 117 >                construction = IWF-typ1 ..
< 118 > interior-wall  area = 200
< 119 >                next-to = "SP_t_E"
< 120 >                construction = IWF-typ1 ..
< 121 > interior-wall  area = 200
< 122 >                next-to = "SP_t_W"
< 123 >                construction = IWF-typ1 ..
< 124 >
< 128 > interior-wall  area = 1400
< 129 >                next-to = "SP_1_C"
< 130 >                construction = IWF-typ1 ..
< 132 >
< 134 > roof          x = 15  y = 15
< 135 >                h = 20
< 136 >                w = 70
< 137 >                construction = ROOF-typ1 ..
< 67 >
< 68 > end ..
< 69 > compute LOADS ..
```

# L O A D S

## Table of Contents

---

<b>SUNSPACES .....</b>	<b>2. 4</b>
Overview .....	2. 4
Sunspace-Related Keywords in LOADS .....	2. 6
Interior Windows.....	2. 8
Interior Doors.....	2. 9
Sunspace-Related Keywords in SYTSEMS.....	2. 15
 <b>SUNSPACE MODELING GUIDELINES .....</b>	 <b>2. 18</b>
Control of Air Flow .....	2. 18
Differential Control.....	2. 18
Time-Clock Control.....	2. 18
Room Thermostat Flow Control.....	2. 19
Sun Control Methods .....	2. 19
Reducing Conductive Heat Loss from Sunspace Exterior Glazing .....	2. 20
Positioning of Sunspace Surfaces.....	2. 21
Massive Interior Walls.....	2. 21
Solar Radiation Absorbed by Interior Walls.....	2. 22
Interior Solar Radiation.....	2. 22
Automatic Sizing of Systems Serving Conditioned Sunspaces .....	2. 23
Description of Window Treatment and Performance .....	2. 24
Use of Multipliers .....	2. 26
Translucent Glazing .....	2. 27
Moisture from Plants and Trees .....	2. 28
Baffles and Louvers.....	2. 28
Atrium as Return Air Plenum .....	2. 28
Heating, Cooling, and Venting of Residential Sunspaces.....	2. 30
Use of Custom Weighting Factors for Sunspaces.....	2. 30
Hourly Report Variables for Sunspace Analysis .....	2. 30
Sunspace-Related Error, Caution, and Warning Messages .....	2. 31
 <b>WINDOW MANAGEMENT AND SOLAR RADIATION .....</b>	 <b>2. 35</b>
Window Management.....	2. 35
Conditional Shading-Device Control.....	2. 35
 <b>DAYLIGHTING .....</b>	 <b>2. 37</b>
Overview .....	2. 37
Guidelines for Daylighting Modeling.....	2. 38
Use of Window and Exterior Wall Multipliers.....	2. 39
Weather Files .....	2. 39
Thermal Zoning .....	2. 39
Surface Orientation .....	2. 40

Multiple Lighting Zones .....	2. 40
Translucent Glazing .....	2. 41
Fins, Overhangs, and Other Shading Surfaces .....	2. 42
Skylights with Light Wells .....	2. 43
Domed Skylights.....	2. 44
Window Management.....	2. 45
Multiple Skylights .....	2. 46
Limitations of the Daylighting Calculation .....	2. 50
Daylighting Commands and Keywords .....	2. 52
Daylighting Input Examples for SPACE-CONDITIONS .....	2. 58
Example of Window Shading Device Assignment .....	2. 63
Daylighting Verification and Summary Reports .....	2. 64
Monthly Average Atmospheric Moisture for U.S. Cities.....	2. 65
Monthly Average Atmospheric Turbidity for U.S. Cities .....	2. 67
<b>TROMBE WALLS.....</b>	
General Rules .....	2. 70
Warning .....	2. 70
Reporting .....	2. 73
<b>FIXED SHADES, FINS AND OVERHANGS, SHADE-SCHEDULE and SELF SHADES.....</b>	
Fixed Shades .....	2. 74
Overhangs and Fins.....	2. 74
Shade Schedule .....	2. 77
Self Shading.....	2. 79
<b>AUTOMATIC CALCULATION OF THE SHADING OF DIFFUSE SOLAR RADIATION.....</b>	
Introduction .....	2. 80
	2. 80
<b>DISTRIBUTION OF HEAT FROM LIGHTS.....</b>	
Introduction .....	2. 81
	2. 81
<b>THE SHERMAN-GRIMSRUD INFILTRATION METHOD.....</b>	2. 86
<b>TERRAIN AND HEIGHT MODIFICATION TO WIND SPEED.....</b>	2. 88
<b>FLOOR MULTIPLIERS AND INTERIOR WALL TYPES.....</b>	2. 91
<b>IMPROVED EXTERIOR INFRARED RADIATION LOSS CALCULATION.....</b>	
Discussion.....	2. 97
	2. 97
<b>IMPROVED OUTSIDE AIR FILM CONDUCTANCE CALCULATION.....</b>	
Discussion.....	2. 98
OUTSIDE-EMISS Keyword.....	2. 98
	2. 98
<b>WINDOW LIBRARY.....</b>	2. 98

Introduction .....	2. 98
Comparison of Methods for Specifying Window Properties .....	2. 99
Index to the Window Library .....	2.100
Printing Window Library Entries.....	2.112
Creating Custom Windows .....	2.112
Using Shading Devices with Windows from the Window Library .....	2.112
Edge-of-Glass Effects.....	2.113
Improved Glass Conduction Calculation .....	2.114
<b>WINDOW FRAMES.....</b>	<b>2.115</b>
Introduction .....	2.115
<b>SWITCHABLE GLAZING.....</b>	<b>2.118</b>
Introduction .....	2.118
Electrochromic Switchable Glazings .....	2.122
Switchable Glazing Examples.....	2.125
(1) Switchable controlled by incident solar radiation.....	2.126
(2) Electrochromic glazing .....	2.127
(3) Switchable controlled by space loads.....	2.128

## SUNSPACES

### Overview

DOE-2 can model the different forms of heat transfer that occur between a sunspace (or atrium) and adjacent spaces; see Fig. 2.1. Sunspaces in DOE-2 can be mechanically heated and cooled, or they may be unconditioned. The program also simulates venting of the sunspace with outside air to prevent overheating and, for residential application, the use of a sunspace to preheat outside ventilation air.

You can control the airflow from the sunspace with a schedule or on the basis of a threshold temperature difference between the sunspace and the adjacent space.

You may simulate additional features for solar-driven spaces, including sun-control with movable window shades, movable insulation on exterior windows, shading by fins and overhangs, sloped glazing, and the effects of thermal mass.

The model is intended primarily for residential and small commercial building applications. Because DOE-2 calculates only a single, average air temperature in a space, this simulation cannot be expected to give accurate results for multi-story atriums unless there is sufficient air mixing to eliminate temperature stratification.

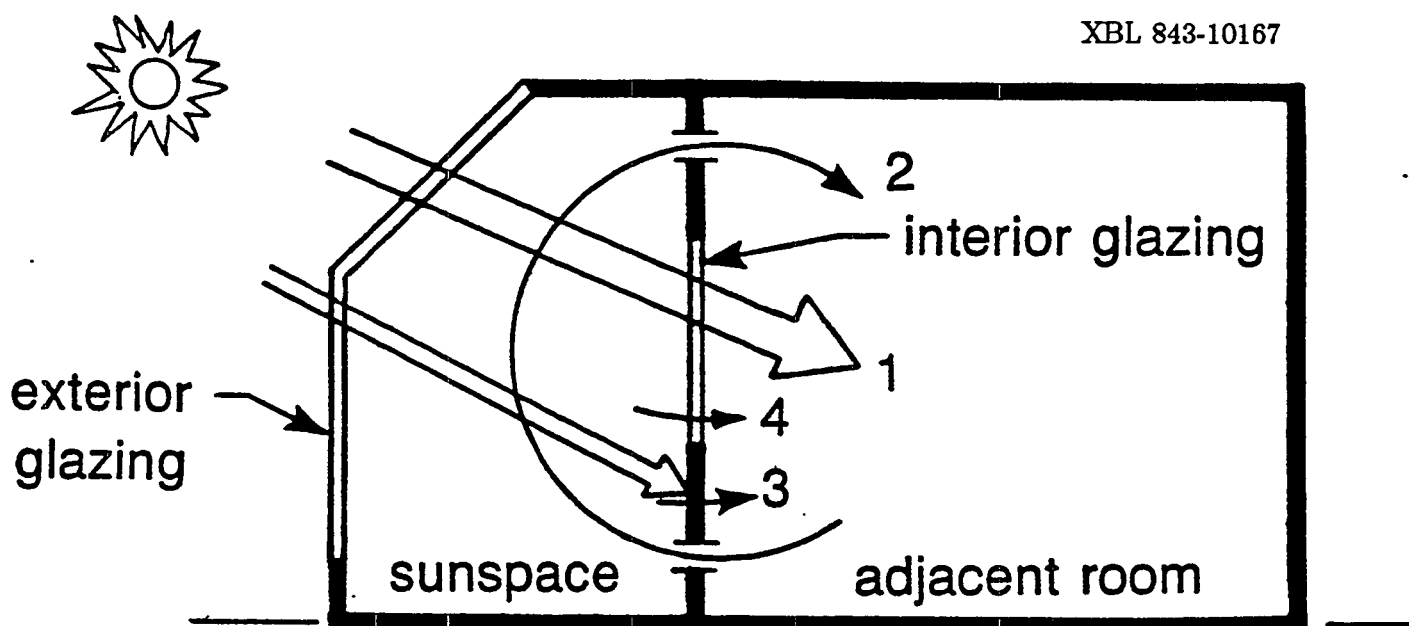

Figure 2.1: Forms of heat transfer calculated by the sunspace model: (1) direct and diffuse solar gain through interior glazing; (2) forced or natural convection through vents or an open doorway; (3) quick or delayed conduction through an interior wall, taking into account solar radiation absorbed on the sunspace side of the wall; and (4) conduction through interior glazing.

Table 2.1 gives a comparison of modeling capabilities for sunspaces in DOE-2.1C vs. DOE-2.1B.

Table 2.1	
Comparison of Modeling Capabilities for Sunspaces in DOE-2.1C vs. DOE-2.1B	
Version 2.1B	Version 2.1C
Solar radiation absorbed by interior surfaces (annual average) is used only in Custom Weighting Factor calculation.	Solar radiation absorbed by sunspace INTERIOR-WALLs is determined hourly and used in conduction calculation.
INTERIOR-WALL position is unused (except for TILT in daylighting calculation).	Sunspace INTERIOR-WALLs can be positioned with X, Y, Z, AZIMUTH, and TILT.
Conduction across INTERIOR-WALLs can be quick only.	Conduction across sunspace INTERIOR-WALLs can be quick or delayed.
INTERIOR-WALLs cannot have WINDOWS.	Sunspace INTERIOR-WALLs can have WINDOWS. Solar gain through these WINDOWS from sunspace to adjacent spaces is calculated. Conduction across interior WINDOWS is calculated. Interior WINDOWS can have movable insulation and shading. They can be shaded by BUILDING-SHADEs inside or outside the sunspace.
Convection across an INTERIOR-WALL can be approximated by assigning an effective U-value to the wall. Non-linear $\Delta T$ dependence of natural convection cannot be modeled. Convection cannot be controlled.	Sunspace INTERIOR-WALLs can have openings through which fan-forced or natural convective heat transfer between sunspaces and adjacent spaces can occur. For natural convection, non-linear $\Delta T$ dependence is accounted for. Convection can be controlled thermostatically or via schedule.
Only the RESYS system has venting. The venting is controlled by the temperature of the control zone.	A sunspace can be vented with outside air to prevent overheating. Venting is independent of temperature of other zones. It works with any SYSTEM-TYPE except PIU.
Moisture gain for ZONE-TYPE = PLENUM is not considered.	Moisture gain in a sunspace (or non-sunspace) is accounted for both ZONE-TYPE = CONDITIONED and ZONE-TYPE = PLENUM.
Zone-level exhaust via EXHAUST-CFM works only for ZONE-TYPE = CONDITIONED.	EXHAUST-CFM works for ZONE-TYPE = CONDITIONED and PLENUM.

## Sunspace-Related Keywords in LOADS

### SPACE-CONDITIONS

#### SUNSPACE

takes code-word values YES or NO (the default). If YES, the space can be directly vented with outside air to prevent overheating (see keywords SS-VENT-SCH, SS-VENT-T-SCH, etc., below), and, if the space has INTERIOR-WALLS, the heat transfer across these walls into adjacent spaces by convection, delayed conduction, and solar transmission will be calculated.

- Note 1. A building can have more than one sunspace (i.e., SPACE with SUNSPACE = YES). There can be more than one sunspace on a system.
- Note 2. A sunspace can have several INTERIOR-WALLS, i.e., a sunspace can have more than one adjoining space.
- Note 3. A sunspace or a non-sunspace can have at most one INTERIOR-WALL with convective heat exchange (AIR-FLOW-TYPE = FORCED-RECIRC, FREE-RECIRC, OPEN-DOORWAY, or FORCED-OA-PREHT in the WALL-PARAMETERS command).
- Note 4. A sunspace and an adjacent non-sunspace can share several INTERIOR-WALLS (only one of which can have convective heat transfer). The conductive heat exchange is calculated separately for each INTERIOR-WALL.
- Note 5. Two sunspaces can be adjacent, but any windows in the common INTERIOR-WALL will be ignored, convective exchange across the wall will not be calculated, and the effect on the conduction through the wall due to absorbed solar radiation will not be considered.
- Note 6. A daylighting simulation can be done for a sunspace (by entering DAYLIGHTING = YES and setting daylighting related keywords), but the program cannot directly calculate daylight passing through interior windows from the sunspace to adjacent spaces.

## INTERIOR-WALL

X, Y, Z

give the coordinates (in the coordinate system of the space in which the wall is defined) of the lower left-hand corner of the wall as viewed from the NEXT-TO space (see Fig. 2.2).

AZIMUTH

is the azimuth of the wall in the coordinate system of the space in which the wall is defined (see Fig. 2.2). The outward normal used to determine the azimuth points into the NEXT-TO space.

Note: HEIGHT, WIDTH, X, Y, Z, AZIMUTH, and TILT are required for an INTERIOR-WALL in a sunspace so that the amount of solar radiation falling on the wall from exterior windows in the sunspace can be calculated. If the sunspace has no exterior windows, which is an exceptional case, these geometrical quantities do not have to be specified. These keywords take the same defaults, meanings, and abbreviations as those under EXTERIOR-WALL.

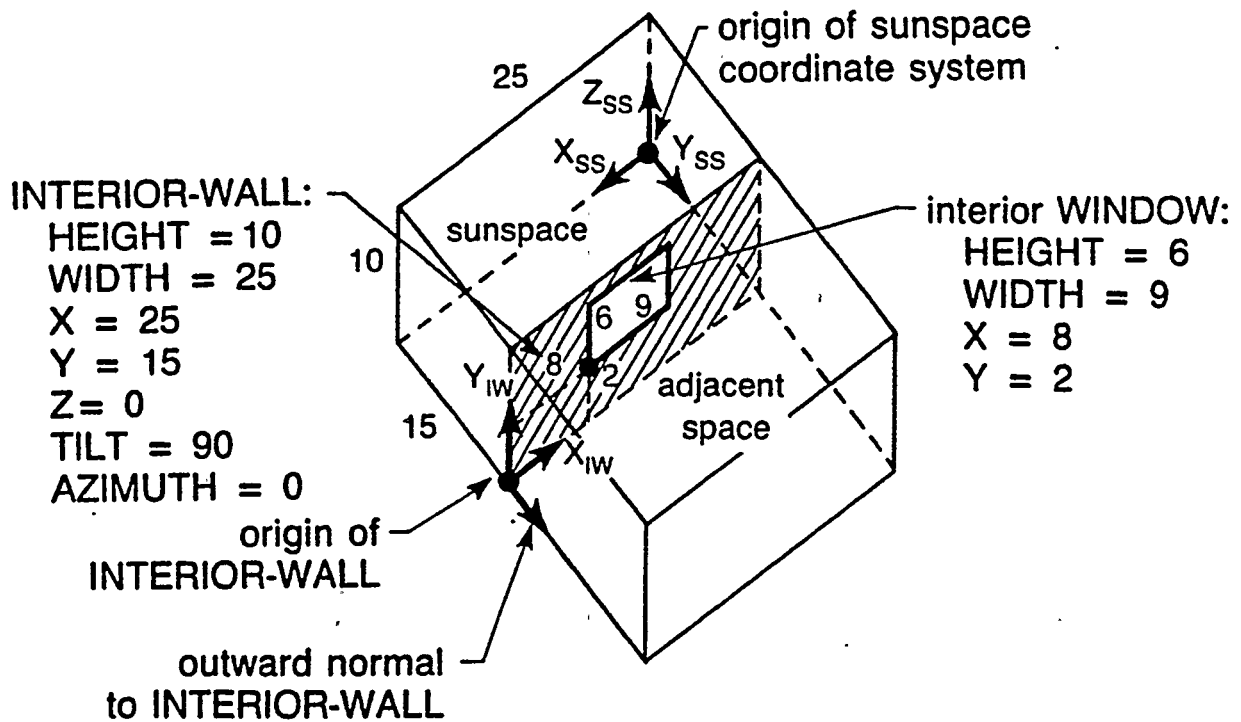

XBL 843-10168

**Figure 2.2:** A sunspace and an adjacent space showing the geometrical positioning of the INTERIOR-WALL separating them. The INTERIOR-WALL has been defined in the sunspace. The lower left-hand corner of the wall (as viewed from the adjacent space) is located at  $X = 25$ ,  $Y = 15$ ,  $Z = 0$  in the sunspace coordinate system. The azimuth of the INTERIOR-WALL is  $0^\circ$ , which is the angle between the sunspace Y-axis,  $Y_{SS}$  and the outward normal to the INTERIOR-WALL. The wall contains a 6 ft x 9 ft WINDOW with lower left-hand corner at  $X=8$ ,  $Y=2$  with respect to the wall origin.



## WINDOW

### SOL-TRANS-SCH

is the u-name of a schedule which gives the solar transmittance of a window shading device when it covers the window. This keyword is used only for exterior windows in a sunspace. The program multiplies the schedule value by the direct and diffuse solar radiation striking the shade to determine the hourly amount of solar radiation (assumed diffuse) which is transmitted by the shade. The SHADING-SCHEDULE value will be used if this keyword is not specified.

This keyword should be defined in addition to, not in place of, SHADING-SCHEDULE. Also, the value of SOL-TRANS-SCH in a given hour must not exceed the corresponding SHADING-SCHEDULE value. If it does, the program will reset it equal to the SHADING-SCHEDULE value.

WIN-SHADE-TYPE = FIXED-EXTERIOR or MOVABLE-EXTERIOR should be entered if a sunspace exterior window has a shading device on the outside of the window. Otherwise, the program will assume the shade is on the inside.

### Interior Windows

Interior windows can be specified by following an INTERIOR-WALL command by one or more WINDOW commands. The keywords for such windows are the same as those for windows in an EXTERIOR-WALL with some exceptions:

- (1) The following keywords are unused:

FRAME-WIDTH	SETBACK
GLARE-CTRL-PROB	SHADING-DIVISION
GLASS-TYPE-SW	SWITCH-CONTROL
GND-FORM-FACTOR	SWITCH-SCH
INF-COEF	SWITCH-SET-HI
LEFT-FIN-A, etc.	SWITCH-SET-LO
OVERHANG-A, etc.	VIS-TRANS-SCH
RIGHT-FIN-A, etc.	WIN-SHADE-TYPE

- (2) SKY-FORM-FACTOR multiplies the total diffuse radiation incident on an interior window. If the interior window has a setback (relative to the sunspace) or there are obstructions inside the sunspace which shade the interior window, a value of SKY-FORM-FACTOR less than 1.0 should be specified (the default value is 1.0).

Shading devices on interior windows, like Venetian blinds, drapes, or pull-down shades, can be simulated via the keywords SHADING-SCHEDULE and MAX-SOLAR-SCH. Movable insulation on interior windows can be modeled using keywords CONDUCT-SCHEDULE and CONDUCT-TMIN-SCH.

For an accurate calculation of the solar radiation transmitted by a sunspace interior window, it is important to specify the X and Y coordinates of the window. These coordinates are measured

with respect to the lower-left hand corner of the INTERIOR-WALL as viewed in the NEXT-TO space (see Fig. 2.2). The position of exterior windows should also be carefully specified. The program will only recognize interior windows in an INTERIOR-WALL between a sunspace and a non-sunspace.

Sliding glass doors can be modeled as interior WINDOWS. If the INTERIOR-WALL containing the glass door has AIR-FLOW-TYPE = FREE-DOORWAY (see WALL-PARAMETERS, below), the door will be assumed to be open, and convection through the opening will be calculated, if  $T(\text{sunspace}) - T(\text{adjacent space}) > \text{AIR-FLOW-CTRL-DT}$ .

Additional control of the opening and closing of the door can be obtained by using SS-FLOW-SCH (see description of new ZONE-AIR keywords, below).

An unglazed opening in a sunspace INTERIOR-WALL can be input as a WINDOW with GLASS-TYPE-CODE = 0 and GLASS-CONDUCTANCE = a small number (e.g. 0.0001). The program will calculate the solar radiation passing through the opening by using a transmittance of 1.0 for all angles of incidence. WALL-PARAMETERS data, described below, would be entered for the INTERIOR-WALL to specify the convective air flow through the opening.

### Interior Doors

The DOOR command cannot be used with INTERIOR-WALL. However, an opaque interior door with a conductance significantly different from the sunspace interior wall containing it can be input as a separate INTERIOR-WALL. Alternatively, the door can simply be ignored if the conduction across it is small compared to the overall conduction across the wall. The program will calculate convection through a fully or partially open door if AIR-FLOW-TYPE = FREE-DOORWAY and appropriate values of DOORWAY-H and DOORWAY-W are specified (see WALL-PARAMETERS, below).

### GLASS-TYPE

It is strongly recommended that exterior WINDOWS in a sunspace be described with GLASS-TYPE-CODE rather than SHADING-COEF. This allows the program to accurately calculate the hourly direct and diffuse radiation transmitted by the glazing. This is not possible with SHADING-COEF except for standard 1/8" clear glass.

## WALL-PARAMETERS

This command is used to specify data which are used by the program to calculate air flow across a sunspace INTERIOR-WALL. The u-name of this command is referenced by the CONSTRUCTION command for the INTERIOR-WALL. The sequence is as follows:

```
WP-1      =   WALL-PARAMETERS FOR INTERIOR-WALL
           .
           . ..
IWCON-1   =   CONSTRUCTION
           WALL-PARAMETERS = WP-1
           .
           . ..
IW-1      =   INTERIOR-WALL
           CONSTRUCTION = IWCON-1
           .
           . ..
```

## WALL-PARAMETERS

**FOR** now accepts the value INTERIOR-WALL (in addition to the Trombe wall code-words).

**AIR-FLOW-TYPE** is the type of air flow across the INTERIOR-WALL. The default is NO-AIR-FLOW, and the other allowed values, which are illustrated in Fig. 2.3, are:

### *FORCED-RECIRC*

A fan blows air through a vent from the sunspace to the adjacent space at a rate equal to AIR-FLOW-RATE. Air is recirculated back to the sunspace through another vent. All of the fan heat is assumed to be picked up by the airstream flowing into the adjacent space.

### *FORCED-OA-PREHT*

A fan draws outside air into the sunspace where it is preheated, then transferred across the INTERIOR-WALL into the adjacent space. The fan is assumed to be located in the building exhaust airstream so that no fan heat is delivered to the building. The flowrate of outside air drawn into the sunspace is the same as the flowrate from the sunspace across the INTERIOR-WALL.

---

In the left column above, bold-faced words are commands, non-bold words are keywords, and italicized words are code-words.

### FREE-RECIRC

Air circulates through upper and lower vents in the INTERIOR-WALL by natural convection. The heat transfer from sunspace to adjacent space is calculated by the program as

$$Q = 31267 C_p P \left[ \frac{h |T_S - T_R|}{T_S T_R \left( \frac{T_S}{A_U^2} + \frac{T_R}{A_L^2} \right)} \right]^{\frac{1}{2}} (T_S - T_R)$$

where

- Q is in Btuh,
- C<sub>p</sub> = heat capacity of air [Btu/lb-°F],
- P = atmospheric pressure [in. Hg],
- h = vertical separation between vents [ft],
- T<sub>S</sub> = sunspace air temperature [°R],
- T<sub>R</sub> = air temperature of adjacent space [°R],
- A<sub>U</sub> = upper vent area [ft<sup>2</sup>],
- A<sub>L</sub> = lower vent area [ft<sup>2</sup>].

### FREE-DOORWAY

Air circulates by natural convection through a doorway in the INTERIOR-WALL. The heat transfer from sunspace to adjacent space when the doorway is fully open is given by

$$Q = 4.6 W H^{\frac{3}{2}} |T_S - T_R|^{\frac{1}{2}} (T_S - T_R),$$

where

- Q is in Btuh,
- W = width of opening [ft],
- H = height of opening [ft],
- T<sub>S</sub> = sunspace air temperature [°F],
- T<sub>R</sub> = air temperature of adjacent space [°F].

Note: this option should only be used for vertical openings.

---

In the left column above, bold-faced words are commands, non-bold words are keywords, and italicized words are code-words.

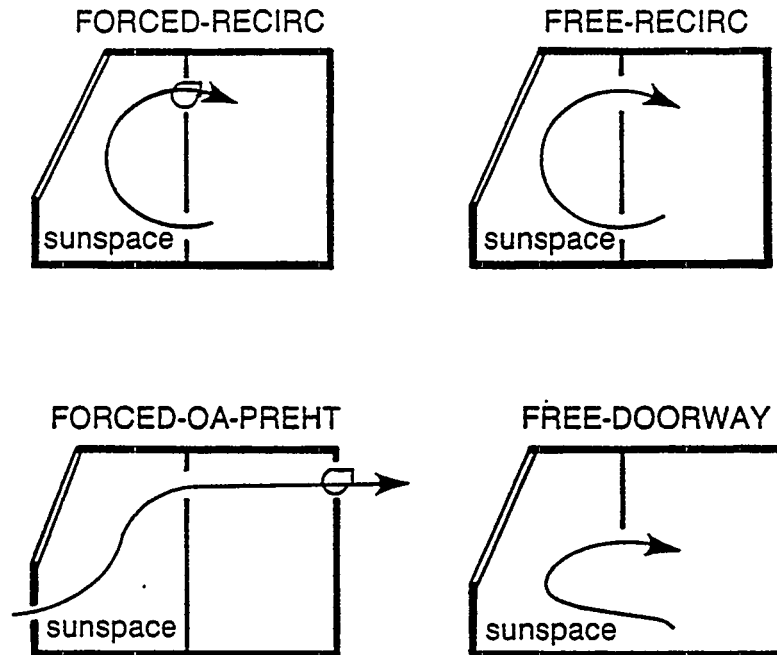

Figure 2.3: Air-flow configurations for different values of AIR-FLOW-TYPE.

The applicability of the following keywords depends on AIR-FLOW-TYPE, as illustrated in Table 2.2.

LOWER-VENT-AREA and UPPER-VENT-AREA	are the cross-sectional areas (ft <sup>2</sup> ) of the lower and upper vents, respectively, for AIR-FLOW-TYPE = FREE-RECIRC.
VERT-VENT-SEP	is the center-to-center vertical separation (ft) between the upper and lower vents for AIR-FLOW-TYPE = FREE-RECIRC.
AIR-FLOW-RATE	is the air flow rate (cfm) across a sunspace INTERIOR-WALL for AIR-FLOW-TYPE = FORCED-RECIRC or FORCED-OA-PREHT. The range is from 0.0 to 999999.0 ft <sup>3</sup> /min, and there is no default.
AIR-FLOW-CTRL-DT	is the threshold temperature difference (°F) for control of air flow across a sunspace INTERIOR-WALL. Air flow will occur only if: [T(sunspace)-T(adjacent space) > AIR-FLOW-CTRL-DT]. The default value is 3.0°F for all AIR-FLOW-TYPEs except FORCED-OA-PREHT, in which case it is -100.0°F (therefore the keyword has no effect if not specified for

FORCED-OA-PREHT).

FAN-KW

is the electrical power per unit air flow (kW/cfm) of the fan for AIR-FLOW-TYPE = FORCED-RECIRC or FORCED-OA-PREHT. The default is 0.00003 and range is from 0.0 to 0.1.

DOORWAY-H  
and  
DOORWAY-W

are, respectively, the height and width in feet of the opening through which air flow occurs for AIR-FLOW-TYPE = FREE-DOORWAY. The range is from 0.0 to 8.0 ft, and 0.0 to 99.0 ft, respectively; there are no defaults.

- Note 1. To get solar radiation transmitted across an unglazed opening, a WINDOW with GLASS-TYPE-CODE = 0, GLASS-CONDUCTANCE = 0.0001, HEIGHT = same value as DOORWAY-H, and WIDTH = same value as DOORWAY-W, should be entered in the sunspace INTERIOR-WALL.
- Note 2. A non-rectangular doorway opening should be approximated by a rectangular opening of the same area.
- Note 3. Multiple openings of height  $H_i$  and width  $W_i$  in the same wall can be represented by a single opening with DOORWAY-H =  $\langle H \rangle$  and DOORWAY-W =  $\sum_i W_i H_i^{1.5} / \langle H \rangle^{1.5}$ , where  $\langle H \rangle$  is the average of the  $H_i$ .
- Note 4. AIR-FLOW-TYPE is applicable only to INTERIOR-WALLs with INT-WALL-TYPE=STANDARD (the default).
- Note 5. The rate of air flow, natural or forced, determined by the program from the above WALL-PARAMETERS data and the temperature difference across the INTERIOR-WALL, is multiplied each hour by the value of SS-FLOW-SCH (default 1.0) which is specified in the SYSTEMS ZONE-AIR input for the sunspace.

**Example:**

A 500 CFM fan circulates air between sunspace and adjacent room if the sunspace is 5° warmer than the room. The fan power is 25W. The WALL-PARAMETERS input would be:

WP-1 = WALL-PARAMETERS    FOR INTERIOR-WALL  
AIR-FLOW-TYPE = FORCED-RECIRC  
AIR-FLOW-RATE = 500  
AIR-FLOW-CTRL-DT = 5  
FAN-KW = .00005 ..

Table 2.2

WALL-PARAMETERS keyword applicability for INTERIOR-WALL.

The X's indicate keywords used for each AIR-FLOW-TYPE.

	AIR-FLOW-TYPE			
	FORCED- RECIRC	FORCED- OA-PREHT	FREE- RECIRC	FREE- DOORWAY
LOWER-VENT-AREA			X	
UPPER-VENT-AREA			X	
VERT-VENT-SEP			X	
AIR-FLOW-RATE	X	X		
AIR-FLOW-CTRL-DT	X	X	X	X
FAN-KW	X	X		
DOORWAY-H				X
DOORWAY-W				X

EXTERIOR-WALL, ROOF, UNDERGROUND-WALL,

UNDERGROUND-FLOOR, INTERIOR-WALL

INSIDE-SOL-ABS

is the inside surface solar absorptance. For INTERIOR-WALL, a list of two values is required, where the first value is the absorptance on the side of the interior wall that is in the space the wall is defined in, and the second value is the absorptance of the other side of the wall.

The default value of INSIDE-SOL-ABS is 0.8 if the surface is a floor ( $TILT > 170^\circ$ ), 0.5 if a wall ( $10^\circ \leq TILT \leq 170^\circ$ ), and 0.3 if a ceiling ( $TILT < 10^\circ$ ).

If Custom Weighting Factors have been requested for a sunspace by inputting FLOOR-WEIGHT = 0, a SOLAR-FRACTION value should be specified for each inside wall/floor/ceiling surface in addition to INSIDE-SOL-ABS (see *Reference Manual (2.1A)*, pp.III.103, 114, and 119). These keyword values are related but not, in general, equal.

SOLAR-FRACTION is the fraction of the solar radiation (that enters and remains in a space) that is ultimately absorbed by a particular surface after inter-reflection in the space; it is used (once) to calculate solar weighting factors. INSIDE-SOL-ABS is the fraction of solar radiation striking an opaque surface that is absorbed (the rest being reflected); it is used hourly to determine the interior solar radiation distribution in a sunspace.

## Sunspace-Related Keywords in SYSTEMS

### ZONE-AIR (or ZONE)

Venting of a sunspace with outside air to prevent overheating can be specified with the following keywords:

- SS-VENT-SCH** is the u-name of a schedule which determines when a sunspace can be vented. The allowed schedule values are 0 if venting is not allowed and 1 if venting is allowed (subject to the temperature conditions described under SS-VENT-T-SCH, below). The default is no venting if this schedule is not input.
- SS-VENT-T-SCH** is the u-name of a schedule of sunspace air temperatures (in °F) above which venting will occur if the outside air temperature is low enough. Letting  $T(\text{vent})$  be the value of SS-VENT-T-SCH, venting will take place if,  
 $T(\text{sunspace}) > T(\text{vent})$ , and  
 $T(\text{outside air}) < \text{SS-VENT-LIMIT-T}$ , and  
 $T(\text{outside air}) < T(\text{sunspace})$ , and  
SS-VENT-SCH value = 1.
- The venting temperature is input as a schedule in order to allow seasonal variation. For example, the venting temperature might be set higher in the winter to increase the amount of heat convected or conducted from the sunspace to adjacent rooms.
- SS-VENT-CST**  
and  
**SS-VENT-WND**  
and  
**SS-VENT-TEMP** are coefficients in the following expression which give the number of outside-air changes per hour when venting by *natural convection*, which is assumed to occur if  
 $\text{SS-VENT-KW} = 0$ :  
$$\text{Venting ach} = (\text{SS-VENT-CST}) + (\text{SS-VENT-WND}) * (\text{windspeed in knots}) + (\text{SS-VENT-TEMP}) * |T(\text{sunspace}) - T(\text{outside air})|$$
- If  $\text{SS-VENT-KW} > 0$ , the venting is assumed to be *fan-forced* at a constant air change rate given by SS-VENT-CST. In this case, SS-VENT-WND and SS-VENT-TEMP are ignored. The ranges and the defaults are:  
SS-V-CST — range of 0.0 to 20.0; default of 5.0  
SS-V-WND — range of 0.0 to 5.0 knot<sup>-1</sup>; default of 0.0 and  
SS-V-TEMP — range of 0.0 to 1.0 1/°F<sup>-1</sup>; default of 0.0.
- SS-VENT-LIMIT-T** is the outside drybulb temperature below which venting can occur (see description of SS-VENT-T-SCH, above); the default value is 120°F.



## SS-VENT-KW

is the electrical power per unit air flow (kW/cfm) of the venting fan. The default value is 0.0. If this keyword is not specified, or is set equal to 0.0, venting is assumed to be by natural convection.

- Note 1. For the RESYS system, sunspace venting is done independently of the natural ventilation of other zones (which is determined by the SYSTEM-AIR keywords NATURAL-VENT-AC, NATURAL-VENT-SCH, and VENT-TEMP-SCH).
- Note 2. If a sunspace is vented, the program will bypass mechanical cooling that hour even if venting cannot bring the sunspace temperature down to the cooling set-point.
- Note 3. If venting can reduce the sunspace temperature below  $T(\text{vent})$ , the program will automatically reduce the fraction of the hour that venting takes place to give a final temperature exactly equal to  $T(\text{vent})$ . The average venting CFM during the hour and the venting fan electrical consumption are adjusted accordingly.

The venting flow rate and the heat extraction due to venting can be printed using SYSTEMS hourly report variable list #63 and #64, respectively, for VARIABLE-TYPE=u-name of ZONE.

The following two keywords are defined for a sunspace. They modify the flow of air across an INTERIOR-WALL between the sunspace and adjoining zone, as determined by the AIR-FLOW-RATE, AIR-FLOW-CTRL-DT, AIR-FLOW-TYPE, etc. parameters for the wall (see description of the WALL-PARAMETERS command for INTERIOR-WALL).

## SS-FLOW-SCH

is the u-name of a schedule, with values between 0 and 1, which multiply the air flow across an INTERIOR-WALL between a sunspace and an adjoining zone. This schedule could be used, for example, to turn off flow at night or during the summer months. If SS-FLOW-SCH is not specified for a sunspace, the flow multiplier defaults to 1.0, and so has no effect.

## SS-FLOW-T-SCH

is specified to prevent warm air from a sunspace from overheating the adjacent zone. The air flow, forced or natural, from the sunspace is turned off if  $T(\text{zone adjacent to sunspace}) > \text{SS-FLOW-T-SCH value}$ . The default is 74°F. Note that if SS-FLOW-SCH or SS-FLOW-T-SCH is defined for a non-sunspace, it will be ignored.

The heat extraction from convection across an interior wall and the corresponding airflow due to convection can be printed for the sunspace or adjoining zone using SYSTEMS hourly report variable list #61 and #62, respectively, for VARIABLE-TYPE=u-name of ZONE.

**Warning:** The PIU (powered induction unit) system should not be used to serve a sunspace or a zone adjacent to a sunspace if the two zones are convectively coupled, or if the sunspace is vented.

**Example:**

A sunspace is mechanically vented at 10 ach from 8:00 a.m. to 7:00 p.m. during the summer months if the inside temperature exceeds 80°F and the outside temperature is below 75°F. The venting fan uses .05 Watts/cfm.

INPUT SYSTEMS ..

```

.
.
.
V-SCH-1 = SCHEDULE THRU MAR 31 (ALL) (1,24) (0)
          THRU OCT 31 (ALL) (1,8) (0)
                               (9,19) (1)
                               (20,24) (0)
          THRU DEC 31 (ALL) (1,24) (0) ..
TV-SCH-1 = SCHEDULE THRU DEC 31 (ALL) (1,24) (80) ..
.
.
.
ZA-1     = ZONE-AIR  SS-VENT-SCH = V-SCH-1
                SS-VENT-T-SCH = TV-SCH-1
                SS-VENT-CST = 10
                SS-VENT-LIMIT-T = 75
                SS-VENT-KW = 0.00005
.
.
.
SUNSP    = ZONE  ZONE-AIR = ZA-1
.
.
.
..
```

## SUNSPACE MODELING GUIDELINES

In the following,

*sunspace* is a SPACE with SUNSPACE = YES;

*room* is a SPACE with SUNSPACE = NO (the default)  
which is adjacent to a sunspace.

### Control of Air Flow

It is usually necessary to control the airflow between a sunspace and adjacent rooms. This is done for one or more of the following reasons: (1) to avoid overheating the room with warmer air from the sunspace; (2) to prevent circulating cold air from the sunspace during the heating season; (3) to run the sunspace fan only when the sunspace-room air temperature differential is large enough to give effective heat transfer at design airflow. In the DOE-2.1C sunspace simulation, the following control mechanisms are available; they can be used singly or in combination.

#### Differential Control

Using AIR-FLOW-CTRL-DT in WALL-PARAMETERS gives differential temperature control for flow across a sunspace INTERIOR-WALL. Air flow across the wall occurs only if

$$T(\text{sunspace}) - T(\text{room}) > \text{AIR-FLOW-CTRL-DT}$$

AIR-FLOW-CTRL-DT is generally chosen to be a few °F.

For AIR-FLOW-TYPE = FREE-RECIRC, this assumes that the vents have back-flow dampers which prevent reverse circulation.

For AIR-FLOW-TYPE = FREE-DOORWAY, this assumes occupants open and close the intervening doorway as relative temperature conditions change.

For AIR-FLOW-TYPE = FORCED-RECIRC, it assumes that the fan is controlled by a differential thermostat.

#### Time-Clock Control

For seasonal or day-night control, SS-FLOW-SCH can be specified under the systems ZONE or ZONE-AIR command for the sunspace. The airflow from a sunspace is multiplied by the hourly SS-FLOW-SCH value. If the value is 0, the flow is cut off completely as in the following example where there is no flow at night or from June to September.

```
FLWSCH-1 = SCHEDULE THRU MAY 31 (ALL) (1,8) (0) (9,17) (1)
                                         (18,24) (0)
```

```
THRU SEP 30 (ALL) (1,24) (0)
```

```
THRU DEC 31 (ALL) (1,8) (0) (9,7) (1) (18,24) (0) ..
```

.

.

.

```
SUNSP-1 = ZONE SS-FLOW-SCH = FLWSCH-1 $ SUNSPACE $
```

.

.

..

### Room Thermostat Flow Control

SS-FLOW-T-SCH allows control of airflow from a sunspace to an adjacent room based on room air temperature. If T(room) is *higher* than the SS-FLOW-T-SCH value, airflow from the sunspace is turned off. If T(room) is *lower* than the SS-FLOW-T-SCH value (and the SS-FLOW-T-SCH value is non-zero) airflow occurs if

$$T(\text{sunspace}) - T(\text{room}) > \text{AIR-FLOW-CTRL-DT}$$

Generally, SS-FLOW-T-SCH values should be between the room heating and cooling setpoints. If SS-FLOW-T-SCH is not specified, the program will use a default value of 74°F for all hours.

### Sun Control Methods

Sun control is generally needed to reduce solar heat gain in a sunspace during the summer. This can be accomplished with external projections such as overhangs, by making some or all of the sunspace exterior glazing reflective or heat absorbing by using switchable glazing (see p.2.123), or by using window coverings. The window coverings may be fixed or movable as determined by SHADING-SCHEDULE. They can also be deployed whenever transmitted solar gain exceeds a threshold value as specified by MAX-SOLAR-SCH.

The degree of shading that a sunspace requires depends, of course, on the extent to which it is used as a living space.

#### Example:

Window coverings with a shading coefficient multiplier of 0.3 and 20% solar transmittance are used from June through October whenever transmitted solar radiation exceeds 50 Btu/ft<sup>2</sup>-hr:

```
SOLTRANS-1    = SCHEDULE THRU DEC 31 (ALL) (1,24) (0.2) ..
SHMULT-1      = SCHEDULE THRU DEC 31 (ALL) (1,24) (0.3) ..
SOL-THRESH-1  = SCHEDULE THRU MAY 31 (ALL) (1,24) (1000)
                THRU OCT 30 (ALL) (1,24) (50)
                THRU DEC 31 (ALL) (1,24) (1000) ..
.
.
.
SUNSPWIN      = WINDOW      SOL-TRANS-SCH    = SOLTRANS-1
                SHADING-SCHEDULE = SHMULT-1
                MAX-SOLAR-SCH     = SOL-THRESH-1
.
.
.
..
```

Sun control may also be desirable for interior windows in a sunspace to prevent excessive direct solar gain into the adjoining room. SHADING-SCHEDULE and MAX-SOLAR-SCH can be used for interior windows in the same way as they are used for exterior windows (however, DOE-2 cannot model switchable interior glazing). Another way of shading interior windows is to locate one or more BUILDING-SHADEs *inside* the sunspace.

### Reducing Conductive Heat Loss From Sunspace Exterior Glazing

Sunspaces typically have large glazed areas. The high U-value of bare, single glazing (about 1.0 Btu/ft<sup>2</sup>-hr-F) leads to significant conductive heat loss to the outside in the winter except in very mild climates. Some ways of ameliorating this heat loss are:

- (1) Use high-performance glass with a low U-value (see "Window Library", p.2.98).
- (2) Use movable insulation by inputting a CONDUCT-SCHEDULE which decreases the overall window conductance at night, or specify CONDUCT-TMIN-SCH which moves insulation into place when the outside temperature is low.
- (3) Use translucent insulating panels in place of some or all of the clear glazing by inputting values for SHADING-COEF and GLASS-CONDUCTANCE obtained from manufacturer's data.

#### Example:

R-5 insulating panels cover a single-glazed sunspace exterior window November through April whenever the outside air temperature falls below 40°F. The shading coefficient multiplier of the insulation is 0.1. The solar transmittance is 2%.

```

CONDMULT-1  =  SCHEDULE  THRU DEC 31 (ALL) (1,24) (.12) ..
SHMULT-1    =  SCHEDULE  THRU DEC 31 (ALL) (1,24) (.1) ..
TMIN-1      =  SCHEDULE  THRU APR 30 (ALL) (1,24) (40)
              THRU OCT 31 (ALL) (1,24) (0)
              THRU DEC 31 (ALL) (1,24) (40)
SOLTRANS-1  =  SCHEDULE  THRU DEC 31 (ALL) (1,24) (.02) ..
              .
              .
              .
SUNSPWIN    =  WINDOW    CONDUCT-SCHEDULE = CONDMULT-1
                   SHADING-SCHEDULE = SHMULT-1
                   CONDUCT-TMIN-SCH = TMIN-1
                   SOL-TRAN-SCH = SOLTRANS-1
              .
              .
              ..
    
```

In this example, the value for the conductance multiplier is the ratio of the window conductance (excluding outside air film) with and without insulation:

$$\frac{(5+.68)^{-1}}{(.68)^{-1}} = \frac{.176}{1.47} = .12$$

The above measures can also be modeled for interior glazing. In this case, the program expects outside air temperatures for CONDUCT-TMIN-SCH (as for exterior windows), not sunspace air temperatures.

### Positioning of Sunspace Surfaces

For an accurate calculation of solar radiation falling on the INTERIOR-WALLS of a sunspace, the bounding surfaces of the sunspace need to be geometrically positioned. This applies to the EXTERIOR-WALLS and ROOFS and their associated windows, and the INTERIOR-WALLS and their associated windows. INTERIOR-WALL keywords X,Y,Z and AZIMUTH, formerly unused, are now operational (along with TILT) for geometrical positioning. It is recommended that INTERIOR-WALLS between a sunspace and adjacent room be defined in the sunspace. Otherwise, the adjacent room must be properly located with respect to the sunspace. If this is not done, the interior walls and windows will be mis-positioned relative to the sunspace exterior windows, and the projection of solar radiation from the windows onto the interior walls will be incorrect. This will result in a wrong calculation of the solar radiation transferred from sunspace to room. Even in this case, there will be no fictitious overall gain or loss of solar gain since the solar which stays in the sunspace plus that transferred to adjacent rooms is constrained by the program to equal that entering the sunspace. There will, however, be an error message if the transferred solar exceeds the entering solar, which would give a net negative solar gain in the sunspace. This may occur if interior walls or windows on them overlap, if MULTIPLIER is used on an interior window, or if MULTIPLIER is used on rooms adjacent to a sunspace.

### Massive Interior Walls

Sunspace interior walls are often fairly massive, leading to a significant time delay in the heat transfer across them by conduction. Such walls should be described by response factors, i.e. with a delayed-type construction. This was a new feature in 2.1C. Previously, INTERIOR-WALL response factors were used only in the Custom Weighting Factor calculation; hourly conduction through all INTERIOR-WALLS was calculated as quick.

The order of defining layers in a delayed INTERIOR-WALL is from "outside" to "inside", where "outside" is the side of the wall in the NEXT-TO space, and "inside" is the side in the space in which the wall was defined.

Delayed conduction through INTERIOR-WALLS is calculated only for INTERIOR-WALLS between a sunspace and a non-sunspace. For other INTERIOR-WALLS the hourly conduction is quick.

Delayed conduction through an INTERIOR-WALL between two non-sunspaces can be obtained simply by assigning SUNSPACE = YES to one of the spaces, even though the space is not actually a sunspace. If the solar flux on the "sunspace" side of the wall is small, it is recommended that INSIDE-SOL-ABS = (0,0) be input for the wall in order to zero out absorption of solar radiation. Otherwise, all interior and exterior walls and windows in the "sunspace" should be geometrically positioned as described above in "Positioning of Sunspace Surfaces".

### Solar Radiation Absorbed by Interior Walls

The program calculates conduction through a sunspace INTERIOR-WALL by doing a heat balance on both surfaces. (This is done in the SYSTEMS program since the actual air temperatures on both sides of the wall have to be known.) The hourly solar radiation absorbed by the sunspace side of the wall is included in the heat balance. Part of this solar radiation is conducted into the adjacent room.

The amount of solar radiation absorbed depends on the incident flux and the absorptance of the wall. The following section describes how the incident flux is determined. The absorptance is input via the keyword INSIDE-SOL-ABS for INTERIOR-WALL. Typical solar absorptance values are listed in a table under the CONSTRUCTION command in the *Reference Manual (2.1A)*, p.III.80. If not specified, absorptance defaults to 0.5 for walls, 0.8 for floors, and 0.3 for ceilings.

For the purposes of the conduction calculation, the direct and diffuse solar radiation absorbed by an interior wall is uniformly distributed over its surface. If part of the wall gets significantly more radiation, you can improve the conduction calculation by dividing the wall into two or more sections. The sections would then be input as separate INTERIOR-WALLs of the same AZIMUTH and TILT, but with X,Y,Z,HEIGHT, and WIDTH chosen to give correct geometrical positioning.

### Interior Solar Radiation

In DOE-2.1B, the solar radiation entering a space is counted as a heat gain only for that particular space. In 2.1C, however, part of the solar radiation entering a sunspace can be transferred directly to adjacent rooms through interior glazing, or indirectly via solar radiation absorbed by the opaque part of INTERIOR-WALLs.

<i>Beam Radiation</i>	To find the <i>beam radiation</i> falling on an inside surface, the program projects the image of each sunspace exterior window onto the surface. This is done using the DOE-2 shadow routines. Summing the contribution from all the exterior windows then gives the net beam radiation incident on the surface. If the surface is an interior window, the transmission and absorption properties of the glazing are used to find the solar gain through the window into the adjacent space. If the surface is opaque, part of the absorbed radiation is conducted to the neighboring space.
-----------------------	---

<i>Diffuse Solar Radiation</i>	The <i>diffuse solar radiation</i> striking sunspace interior walls is also calculated. This radiation has three sources: diffuse radiation from exterior windows; diffuse radiation coming from beam radiation reflected from interior surfaces; and diffuse radiation coming from diffuse radiation from exterior windows which reflects from interior surfaces. The diffuse irradiance inside a sunspace is assumed to be uniform.
--------------------------------	---

If a shading device is present on a sunspace exterior window in a given hour, it is assumed that the radiation transmitted by the shade is totally diffuse; i.e., there is no transmitted beam component. The transmittance of the shade is assumed to be the same for direct and diffuse incident radiation and given by SOL-TRANS-SCH. Solar transmittances for various window treatments can be obtained from Table 2.3 or from manufacturer's data.

The solar energy absorbed by sunspace INTERIOR-WALLS is deducted from the sunspace load. The solar energy transmitted through sunspace interior glazing is also deducted from the sunspace load and credited to the load on adjacent rooms.

Up to 20-25% of the solar radiation entering the sunspace can be reflected back out the exterior windows. The exact percentage depends on inside surface reflectances, glazing fraction, and glass shading coefficient, as described in Section 2.3.4.2 of the *Engineers Manual (2.1A)*. This loss is included in the Custom Weighting Factors for solar gain; therefore, it is accounted for in the weighted solar load for the space (but not in the instantaneous solar gain). The loss is *not* accounted for in the ASHRAE weighting factors, so that Custom Weighting Factors, obtained by specifying FLOOR-WEIGHT = 0, should be used for sunspaces.

The program does not account for the loss of radiation entering one exterior window and leaving another exterior window without an intermediate reflection. This radiation is included in the solar gain.

#### **Automatic Sizing of Systems Serving Conditioned Sunspaces**

We recommend that the automatic sizing feature (see *Reference Manual (2.1A)*, p.IV.298) not be used for a system serving a conditioned sunspace. This is because the peak hourly loads used by SYSTEMS for sizing do not include the contribution of solar radiation absorbed by the sunspace interior walls. (The effect of this contribution is not accounted for until the SYSTEMS hourly calculation; see "Solar Radiation Absorbed by Interior Walls", p.2.22.) As a result, the LOADS cooling peak for sunspaces is underestimated and the heating peak is overestimated.

For a similar reason, auto-sizing of a system serving a space *adjacent* to a sunspace should be avoided if there is likely to be significant conduction of heat to that space across the adjoining interior wall.



**Table 2.3**  
**Description of Window Treatment and Performance<sup>1</sup>**

Window Treatment (1,2,3, or 4) and Fabrication/Finish/Color	Solar Characteristics <sup>2</sup>		
	Transmittance %	Reflectance %	Absorbance %
<b>Lined Drapery</b>			
1 Satin/NFF <sup>3</sup> /Goldenrod--Lining: Plain/Opaque/White	15	66	19
2 Satin/NFF/Dk. Brown--Lining: Plain/Opaque/White	02	57	41
3 Satin/NFF/White--Lining: Plain/Opaque/White	18	68	14
4 Mali/NFF/Beige with brown accent Lining: Plain/Translucent/Beige	34	47	19
<b>Unlined Satin Drapery</b>			
1 Brocade/Acrylic Foam back/Beige	08	70	21
2 Brocade/Acrylic Foam back/Beige	10	67	24
3 Modified Satin/Acrylic Foam back/Beige	17	73	10
4 Modified Satin/Acrylic Foam back/Green	09	75	16
5 Modified Satin/NFF/Variegated Brown	30	51	19
<b>Unlined Casement Drapery</b>			
1 Mali/NFF/Beige	54	41	05
2 Mali/NFF/Variegated Brown	29	54	16
3 Mali/NFF/Beige	56	37	07
4 Mali/NFF/Beige	36	42	23
<b>Shirred Curtains</b>			
1 Plain (Ninon)/NFF/Beige	65	27	08
2 Plain (Ninon)/NFF/White	66	29	05
3 Leno (Marquissette)/NFF/White	86	14	00
<b>Pleated Curtains</b>			
1 Plain (Ninon)/NFF/Beige	27	37	37
<b>Venetian Blinds (slats closed)</b>			
1 2" steel slats/NFF/White	04	55	41
2 1" aluminum slats/NFF/White	02	57	41
<b>Vertical Blinds (slats closed)</b>			
1 3.5" film PVC/NFF/White	01	70	28
2 3.5" Plain weave/NFF/White	31	58	11

**Table 2.3 (Continued)**  
**Description of Window Treatment and Performance<sup>1</sup>**

Window Treatment (1,2,3, or 4) and Fabrication/Finish/Color	Solar Characteristics <sup>2</sup>		
	Transmittance %	Reflectance %	Absorptance %
<b>Translucent Roller Shade</b>			
1 Open plain weave/vinyl-coated Fiberglas/White	48	43	09
2 Plain weave/vinyl-coated cotton/White	19	65	16
<b>Opaque Roller Shade</b>			
1 Plain weave/vinyl-coated cotton embossed/White	00	66	34
2 Plain weave/vinyl-coated layer/White	00	74	26
3 Plain weave/laminated embossed/White	00	75	26
4 Film/vinyl-coated embossed/White	15	67	18
<b>Roll-up Shade</b>			
1 Modified plain weave/vinyl tube yarn/NFF/Beige	33	53	14
<b>Drapery Liner</b>			
1 Plain weave/Acrylic coated/White	18	66	16
2 Plain weave/Acrylic coated/White	17	70	13
<b>Wooden Shutter (louvers closed)</b>			
1 Wood/NFF/Beige	00	63	37
<b>Wooden Shutter Frame with Shirred Fabric</b>			
1 Wood/NFF/Beige--Fabric: Ninon/NFF/White Width: three times the frame opening	62	35	04
2 Wood/NFF/Beige--Fabric: Ninon/NFF/White Width: six times the frame opening	32	51	17

- 1 From *Solar Optical Properties of Accepted Interior Window Treatments*, Eleanor Woodson, Samina Kahn, Patricia Horridge, and Richard W. Tock, ASHRAE Journal, p.40, August 1983.
- 2 Due to roundoff, sum of transmittance, reflectance, and absorptance may not be 100%.
- 3 NFF — No Functional Finish relevant to Heat Flux

### Use of Multipliers

To obtain an accurate interior solar radiation calculation, it is recommended that MULTIPLIER *not* be used for sunspace exterior WINDOWS, interior WINDOWS, or EXTERIOR-WALLs (if they have windows). In addition, it is recommended that MULTIPLIER *not* be used on a SPACE adjacent to a sunspace.

The dangers of using MULTIPLIERS are illustrated in Figs. 2.4 and 2.5. If the two identical exterior WINDOWS in Fig. 2.4 are entered as a single WINDOW W-1 with MULTIPLIER = 2, no direct radiation will be calculated to fall on interior wall IW-2, whereas the radiation on IW-3 will be over-estimated by a factor of 2. The two windows should be input separately. In Fig. 2.5 beam radiation strikes the interior window between sunspace and B, but not the one between sunspace and A. If the "identical" SPACE's A and B are input as A with MULTIPLIER = 2, there will be zero beam radiation transmitted to these SPACES from the sunspace.

If the radiation inside the sunspace is predominately *diffuse*, which would be the case if beam radiation were blocked by overhangs or window shades, the various MULTIPLIERS discussed *can* be used with little loss of accuracy.

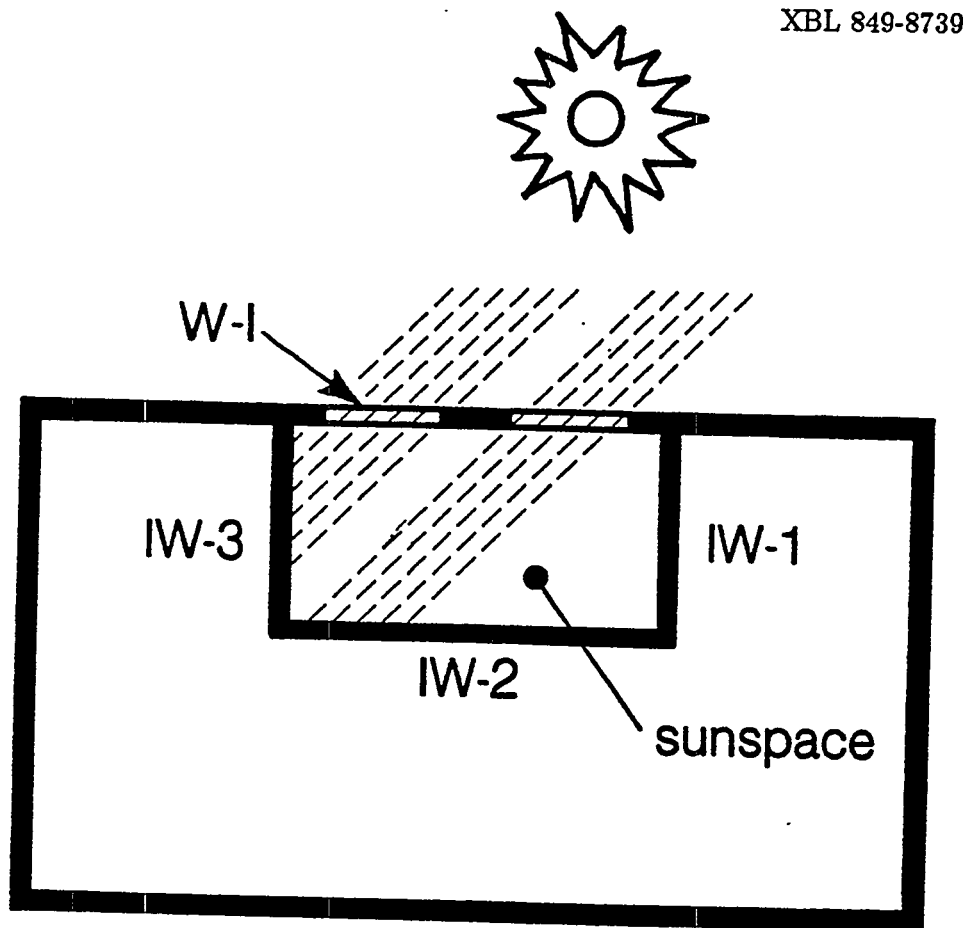
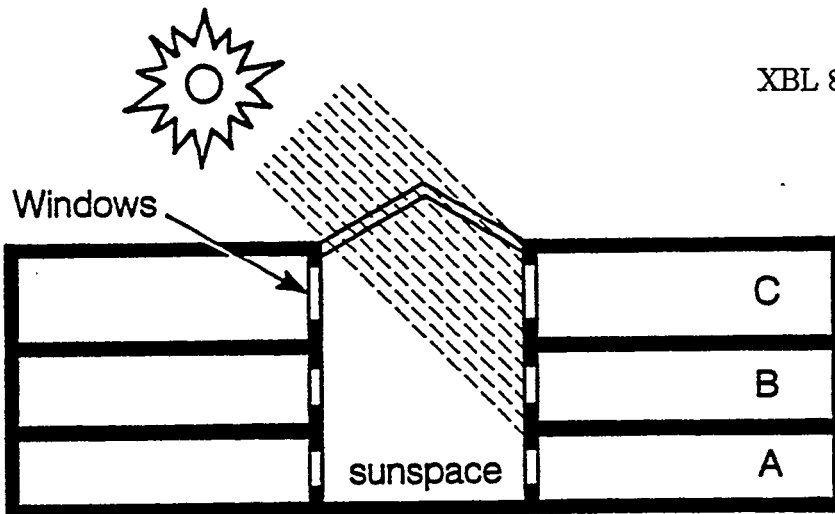

Figure 2.4: If the two exterior WINDOWS are input as a single window W-1 with MULTIPLIER = 2, the program will get zero beam radiation striking interior wall IW-2 and twice the actual amount striking IW-3.



**Figure 2.5:** If SPACES A and B are input as a single space A with MULTIPLIER = 2, the beam radiation transmitted through the interior windows in these spaces will be calculated to be zero.

### Translucent Glazing

Translucent exterior glazing in a sunspace should be modeled with GLASS-TYPE-CODE = 1 and with SHADING-SCHEDULE values equal to the shading coefficient of the glazing. (A SHADING-SCHEDULE is used here to give a window which is diffusely transmitting.) A SOL-TRANS-SCH should also be specified, with a constant value equal to  $T/0.878$ , where T is the solar transmittance of the glazing at normal incidence. (0.878 is the transmittance at normal incidence for the clear reference glass used in DOE-2.)

#### Example:

A sunspace has single-pane translucent exterior glazing with a shading coefficient of 0.71 and solar transmittance of 0.82:

```

GT-1          = GLASS-TYPE  GLASS-TYPE-CODE = 1  ..
               .
               .
               .
SHSCH-1       = SCHEDULE   THRU DEC 31 (ALL) (1,24) (.71)  ..
SOLTRSCH-1   = SCHEDULE   THRU DEC 31 (ALL) (1,24) (.93)  ..
               $ .93 = .82/.878 $
               .
               .
               .
SUNSPWIN-1    = WINDOW     GLASS-TYPE = GT-1
                   SHADING-SCHEDULE = SHSCH-1
                   SOL-TRANS-SCH = SOLTRSCH-1
                   .
                   .
                   .
                   ..

```

### Moisture from Plants and Trees

Atriums often have plants and trees. Moisture transpiring from leaves and evaporating from soil can produce a significant latent load. To model this load, plants can be described using the "SOURCE" keywords in SPACE or SPACE-CONDITIONS as follows:

Under the SPACE or SPACE-CONDITIONS commands	
SOURCE-TYPE	= PROCESS
SOURCE-LATENT	= 1.0
SOURCE-SENSIBLE	= 0.0
SOURCE-BTU/HR	= latent load from plants and soil
SOURCE-SCHEDULE	= u-name of schedule (which could vary seasonally or with time of day, if desired)

### Baffles and Louvers

Baffles and louvers on sunspace exterior windows, which block and/or diffuse incoming beam radiation, can be modeled as shading devices by specifying SOL-TRANS-SCH and SHADING-SCHEDULE. This method is very approximate, however, since the transmittance of devices of this kind is usually very incidence-angle dependent. Furthermore, very little measured data is currently available that would be useful in choosing average transmittance values.

### Atrium as Return Air Plenum

In some commercial building designs, some or all of the return air from conditioned zones is passed to a central sunspace/atrium, from which it is passed back to the central air handling system or exhausted. The atrium thus behaves like a return air plenum. This arrangement can be modeled by assigning ZONE-TYPE = PLENUM to the atrium zone and including the atrium u-name in the PLENUM-NAMES list for the system.

If only part of the system return air goes to the atrium, two PLENUM zones can be defined, one of them being the atrium and the other being a real or dummy plenum. In a system with two plenums, the return air is split by DOE-2 between the plenums, in proportion to their floor areas, as given by the AREA keyword in the SPACE commands. Thus, if a fraction  $f$  of return air goes to the atrium, the atrium AREA divided by the AREA of the second plenum should be  $f/(1-f)$ .

If some of the return air is exhausted directly from the atrium, EXHAUST-CFM can be specified for the atrium zone. Previously, this keyword worked only for ZONE-TYPE = CONDITIONED. (EXHAUST-CFM will also work for PLENUMs which are not sunspaces, i.e., have SUNSPACE = NO.)

The program accounts for the various forms of sensible and latent heat gain or loss, such as solar gain, infiltration, and moisture from people, for ZONE-TYPE = PLENUM just as it does for ZONE-TYPE = CONDITIONED. There are two important restrictions, however. The atrium as PLENUM cannot be mechanically cooled (although it can be vented) and it can be heated only with baseboards (see p.3.115, "Baseboard Heating in Plenums").

**Example:**

Two-thirds of the return air from five identical conditioned zones goes to a 10,000 sq.ft. atrium; the remaining one-third goes directly back to the air handling system.

```
INPUT LOADS      ..  
  .  
  .  
  .  
CONDZONES = SPACE MULTIPLIER = 5  
             ZONE-TYPE = CONDITIONED  
  .  
  .  
  .  
ATRIUM     = SPACE AREA = 10000  
             SUNSPACE = YES  
             ZONE-TYPE = PLENUM  
  .  
  .  
  .  
DUMPLEN    = SPACE AREA = 5000  
             ZONE-TYPE = PLENUM  
  .  
  .  
  .  
INPUT SYSTEMS  ..  
  .  
  .  
  .  
CONDZONES    = ZONE  
  .  
  .  
  .  
ATRIUM       = ZONE  
  .  
  .  
  .  
DUMPLENS     = ZONE  
  .  
  .  
  .  
SYS-1        = SYSTEM ZONE-NAMES = (CONDZONES, ATRIUM, DUMPLEN)  
             PLENUM-NAMES = (ATRIUM, DUMPLEN)  
  .  
  .  
  .  
  .  
  .  
  .
```

### Heating, Cooling, and Venting of Residential Sunspaces

For SYSTEM-TYPE = RESYS, sunspaces are not heated by the central system; in this case, a sunspace can be heated only with thermostatic baseboards (BASEBOARD-CTRL = THERMOSTATIC). Unlike baseboard heating of the other zones in this system, baseboard heating of a sunspace is independent of the heating requirements of the control zone (the first zone in the ZONE-NAMES list).

Sunspaces in SYSTEM-TYPE = RESYS and RESVVT are not cooled by the central system. They can, however, be vented with outside air, as explained in the keyword descriptions for SS-VENT-SCH, SS-VENT-T-SCH, etc., in the ZONE-AIR command. The venting of a sunspace in this system is independent of the natural ventilation of the other zones as determined by NATURAL-VENT-SCH, etc., in SYSTEM-AIR.

### Use of Custom Weighting Factors for Sunspaces

It is recommended that Custom Weighting Factors (CWF) be used for sunspaces for several reasons:

- (1) For high conductance spaces, the precalculated (ASHRAE) weighting factors in DOE-2 overestimate heating and cooling loads. The overestimate can be as high as 25-30% for heavily glazed spaces.
- (2) The CWF account for loss of solar gain due to reflection of sunlight back out of exterior windows.
- (3) The CWF give a more accurate calculation of the generally large temperature swings in a solar-driven space.

CWF's will automatically be calculated for any space with FLOOR-WEIGHT = 0. Otherwise, the program will use ASHRAE weighting factors. See the *Reference Manual (2.1A)*, p.III.141-162, for CWF input guidelines.

### Hourly Report Variables for Sunspace Analysis

In 2.1C, nine hourly report variables (56 through 64) were added in SYSTEMS to VARIABLE-TYPE = u-name of ZONE for sunspace analysis. Also, the LOADS VARIABLE-TYPE = u-name of WINDOW variable descriptions were updated to reflect the addition of sunspace-related interior windows. See Appendix A, "Hourly Report Variable List", for a full listing of the program hourly variables.

## Sunspace-Related Error, Caution, and Warning Messages

In the following, *sunspace* means a SPACE with SUNSPACE = YES; *non-sunspace* means a SPACE with SUNSPACE = NO (the default).

**Error Message (1)** INTERIOR-WALL <u-name>, WHICH IS BETWEEN A SUNSPACE AND A NON-SUNSPACE, HAS AREA SPECIFIED RATHER THAN HEIGHT AND WIDTH. HEIGHT AND WIDTH ARE REQUIRED FOR CALCULATION OF SOLAR RADIATION ABSORBED ON THE SUNSPACE SIDE OF THIS WALL.

**Meaning:** Self-explanatory.

**User-Action:** Specify HEIGHT and WIDTH for this wall.

**Error Message (2)** EXTERIOR-WALL <u-name>, IN SUNSPACE <u-name>, HAS A MULTIPLIER OF <value>. THE MULTIPLIER ON AN EXTERIOR-WALL (WITH WINDOWS) IN A SUNSPACE SHOULD BE 1.0.

**Meaning:** A sunspace has an EXTERIOR-WALL with a MULTIPLIER different from 1.0. Since this wall has one or more WINDOWS, the use of a MULTIPLIER will give an inaccurate calculation of the interior solar radiation distribution from these windows.

**User-Action:** Do not use a MULTIPLIER on sunspace EXTERIOR-WALLs.

**Error Message (3)** SPACE <u-name> HAS <value> SUNSPACE COMMON WALLS WITH CONVECTIVE HEAT TRANSFER (AIR-FLOW-TYPE = FORCED-RECIRC, FORCED-OA-PREHT, FREE-RECIRC, OR FREE-DOORWAY). AT MOST ONE COMMON WALL WITH CONVECTIVE TRANSFER IS ALLOWED IN A SPACE.

**Meaning:** A space cannot have more than one interior wall across which convective flow is specified using the AIR-FLOW-TYPE keyword in the WALL-PARAMETERS command.

**User-Action:** Reduce number of interior walls with convection to one.

**Warning Message (1)** WINDOW <u-name> ON INTERIOR WALL <u-name> HAS X=0, Y=0 AND THEREFORE HAS PROBABLY NOT BEEN CORRECTLY POSITIONED. THIS MAY CAUSE AN INACCURATE SOLAR RADIATION TRANSMISSION CALCULATION.



Meaning: You have probably forgotten to geometrically position the interior WINDOW.

User-Action: Specify X, Y, HEIGHT and WIDTH for the WINDOW; see Fig. 2.2 and subsection "Positioning of Sunspace Surfaces" (p. 2.21).

**Warning Message (2)** <u-name> IS AN INTERIOR-WALL BETWEEN SUNSPACE <u-name> AND SPACE <u-name>. SINCE THE INTERIOR-WALL WAS DEFINED IN <u-name> IT IS IMPORTANT THAT THIS SPACE BE CORRECTLY POSITIONED WITH RESPECT TO THE SUNSPACE TO OBTAIN AN ACCURATE CALCULATION OF SOLAR RADIATION INCIDENT ON THE WALL FROM EXTERIOR WINDOWS IN THE SUNSPACE.

Meaning: A sunspace INTERIOR-WALL was defined in the adjacent space rather than in the sunspace.

User-Action: Be sure that the SPACE in which the INTERIOR-WALL was defined is geometrically positioned with respect to the sunspace. Alternatively, define the INTERIOR-WALL in the sunspace.

**Warning Message (3)** SPACE <u-name>, WHICH IS NEXT TO SUNSPACE <u-name> HAS MULTIPLIER <value>. A MULTIPLIER DIFFERENT FROM 1.0 MAY CAUSE AN INACCURATE CALCULATION OF HEAT TRANSFER FROM THE SUNSPACE.

Meaning: The use of a MULTIPLIER on a SPACE adjacent to a sunspace multiplies the common INTERIOR-WALL. This may give an incorrect calculation of the total solar radiation absorbed by the wall and transmitted by windows in the wall.

User-Action: See subsection "Use of Multipliers" (p.2.26).

**Warning Message (4)** WINDOW <u-name> IN INTERIOR-WALL <u-name> HAS MULTIPLIER <value>. A MULTIPLIER DIFFERENT FROM 1.0 MAY CAUSE AN INACCURATE SOLAR RADIATION TRANSMISSION CALCULATION.

Meaning: The location of sunspace interior glazing is important in the calculation of the amount of solar radiation striking the glazing.

User-Action: Do not use a MULTIPLIER. Input WINDOWS separately.

**Caution Message (1)** SUNSPACE INTERIOR WALL <u-name> HAS X=0, Y=0 AND THEREFORE MAY NOT BE CORRECTLY POSITIONED. THIS MAY CAUSE AN INACCURATE CALCULATION OF SOLAR

## RADIATION ABSORBED BY THE WALL.

**Meaning:** You have probably forgotten to geometrically position a sunspace INTERIOR-WALL.

**User-Action:** Specify X, Y, Z, AZIMUTH, TILT, HEIGHT, and WIDTH. See Fig. 2.2 and subsection "Positioning of Sunspace Surfaces" (p.2.21).

**Caution Message (2)** WINDOW <u-name> IN SUNSPACE EXTERIOR-WALL <u-name> HAS MULTIPLIER <value>. A MULTIPLIER DIFFERENT FROM 1.0 MAY CAUSE AN INACCURATE CALCULATION OF THE AMOUNT OF SOLAR RADIATION FROM THIS WINDOW WHICH STRIKES THE INTERIOR WALLS OF THE SUNSPACE.

**Meaning:** The geometrical position of a sunspace exterior WINDOW is important in the interior solar radiation calculation.

**User-Action:** Do not use MULTIPLIER; input windows separately.

**Caution Message (3)** WINDOW <u-name> IS IN INTERIOR WALL <u-name> WITH TYPE=[AIR, ADIABATIC, or INTERNAL]. THIS WINDOW WILL BE IGNORED.

**Meaning:** The program calculates heat transfer through interior windows only if they are in an INTERIOR-WALL with INT-WALL-TYPE = STANDARD (the default) and this INTERIOR-WALL is between a sunspace and a non-sunspace. In all other cases, INTERIOR-WALLS are considered as being without WINDOWS.

**User-Action:** Remove WINDOW from wall, or change INT-WALL-TYPE to STANDARD if heat transfer calculation across the wall is desired.

**Caution Message (4)** WINDOW <u-name> IS IN INTERIOR-WALL <u-name> BETWEEN TWO SUNSPACES. THIS WINDOW WILL BE IGNORED.

**Meaning:** The program calculates heat transfer through interior windows only if they are in an INTERIOR-WALL with INT-WALL-TYPE = STANDARD (the default) and this INTERIOR-WALL is between a sunspace and a non-sunspace. In all other cases, INTERIOR-WALLS are considered as being without WINDOWS.

**User-Action:** Check whether the spaces on either side of this wall should both be sunspaces. If not, assign SUNSPACE = NO to one of them. Otherwise, remove WINDOW from wall.

**Caution Message (5)** WINDOW <u-name> IS IN INTERIOR-WALL <u-name>  
BETWEEN TWO NON-SUNSPACES. THIS WINDOW WILL BE  
IGNORED. (HEAT TRANSFER WILL BE CALCULATED ONLY  
FOR WINDOWS IN A STANDARD-TYPE INTERIOR WALL  
BETWEEN A SUNSPACE AND A NON-SUNSPACE.)

**Meaning:** The program calculates heat transfer through interior windows only if they are in an INTERIOR-WALL with INT-WALL-TYPE = STANDARD (the default) and this INTERIOR-WALL is between a sunspace and a non-sunspace. In all other cases, INTERIOR-WALLs are considered as being without WINDOWS.

**User-Action:** Check whether the spaces separated by this wall should both be non-sunspaces. If not, assign SUNSPACE = YES to one of them. Otherwise, remove WINDOW from wall.

## WINDOW MANAGEMENT AND SOLAR RADIATION

### Window Management

There are several ways of controlling the operation of window shading devices in DOE-2. In DOE-2.1A, the shading-coefficient and conductance of a window could be modified each hour to account for the presence of a shading device by specifying a SHADING-SCHEDULE and CONDUCT-SCHEDULE for the window. We call these *schedule controls*. This option was retained in 2.1B; in addition, options to control shading devices when solar gain, outside temperature, or daylight glare exceed user-specified threshold values were added in 2.1B. We call these *threshold controls*.

The 2.1B options made use of the following keywords:

MAX-SOLAR-SCH  
SUN-CTRL-PROB  
CONDUCT-TMIN-SCH  
WIN-SHADE-TYPE

Please refer to the DAYLIGHTING section, p.2.37, of this manual for a discussion on the use of these keywords (whether or not daylighting is to be employed).

The various control options for window management and their input requirements are summarized in Table 2.4 (p.2.51) in the DAYLIGHTING section. Note in Table 2.4 the additional input requirements for windows in spaces for which a daylighting calculation has been requested by specifying DAYLIGHTING = YES in SPACE or SPACE-CONDITIONS.

### Conditional Shading-Device Control

In 2.1C a keyword was introduced, under the WINDOW command, to be used in conjunction with window management:

### WINDOW

OPEN-SHADE-SCH

is the u-name of a schedule whose value in any given hour is the probability that the shading device will be opened if both the solar gain and the glare (with shade open) would be below the limits set by MAX-SOLAR-SCH in the WINDOW command and MAX-GLARE in the SPACE-CONDITIONS command. If OPEN-SHADE-SCH is not specified, the shading devices will be reopened as soon as both the heat gain and glare fall below the specified limits. The shading devices are reopened at midnight in any case. The abbreviation is O-S-SCH.

**Example:**

Drapes on a window are closed from April to October whenever the transmitted direct solar gain (with the drapes open) exceeds a threshold value of 15 Btu/ft<sup>2</sup>-hr. From November to March, the drapes are closed when the solar gain exceeds 50 Btu/ft<sup>2</sup>-hr. The shading coefficient multiplier for the drapes when they are closed is 0.3. The drapes have a negligible effect on the window conductance. There is a 10% probability each hour that the occupants will reopen the drapes if the transmitted solar gain falls below the above threshold values.

```
DRAPEMULTSCH-1 = SCHEDULE THRU DEC 31 (ALL) (1,24) (0.3) ..
MAXSOLSCH-1    = SCHEDULE THRU MAR 31 (ALL) (1,24) (50)
                THRU OCT 31 (ALL) (1,24) (15)
                THRU DEC 31 (ALL) (1,24) (50) ..
REOPEN-PROB-1 = SCHEDULE THRU DEC 31 (ALL) (1,24) (0.1) ..
.
.
.
WIN-1          = WINDOW SHADING-SCHEDULE = DRAPEMULTSCH-1
                MAX-SOLAR-SCH           = MAXSOLSCH-1
                OPEN-SHADE-SCH          = REOPEN-PROB-1
                .
                .
                . ..
```

# DAYLIGHTING

## Overview

The DOE-2 daylighting calculation allows you to determine what effect the use of daylighting to dim electric lighting has on energy use, peak loads, and energy cost. The calculation is done in the LOADS program; it has three main stages:

- (1) A preprocessor calculates in detail a set of *daylight factors* (interior illuminance divided by exterior horizontal illuminance) for later use in the hourly loads calculation. You specify the coordinates of one or two reference points in a space. DOE-2 then integrates over the area of each window to obtain the contribution of direct light from the window to the illuminance at the reference points, and the contribution of light from sky and ground which enters the window and reflects from the walls, floor, and ceiling before reaching the reference points. Taken into account are such factors as window size and orientation, glass transmittance, inside surface reflectance of the space, sun-control devices such as blinds and overhangs, and the luminance distribution of the sky. Since this distribution depends on the position of the sun and cloudiness of the sky, the calculation is carried out for standard clear and overcast sky conditions for a series of 20 different solar altitude and azimuth values covering the annual range of sun positions. Analogous factors for discomfort glare are also calculated and stored.
- (2) An hourly daylight illuminance and glare calculation is performed. The illuminance contribution from each window is found by interpolating the stored daylight factors using the current-hour sun-position and cloud cover, then multiplying by the current-hour exterior horizontal illuminance obtained from measured horizontal solar radiation, if present on the weather file, or from a calculation. If the glare-control option has been specified, the program will automatically close window blinds or drapes in order to decrease glare below a pre-defined comfort level. (A similar option is available to use window shading devices to automatically control solar gain.) Adding the illuminance contributions from all the windows then gives the total number of footcandles at each reference point.
- (3) Stepped and continuously dimming control systems are simulated to determine the electrical lighting energy needed to make up the difference, if any, between the daylighting level and the required illuminance. Finally, the zone lighting electrical requirements are passed to the DOE-2 thermal loads calculation.

---

Acknowledgement: The Daylighting Program was developed in collaboration with the Windows and Daylighting Group at Lawrence Berkeley Laboratory.

### Guidelines for Daylighting Modeling

Following are some guidelines for preparing DOE-2 input to model the effects of daylighting. Before studying these guidelines, however, you should read the description of each daylighting keyword\* in the DOE-2 Daylighting Keywords section, p.2.52, and review the sample daylighting run in the *Sample Run Book (2.1E)*.

* The daylighting keywords are:		
Daylighting Commands	Daylighting Keywords	
in BUILDING-LOCATION	ATM-MOISTURE ATM-TURBIDITY	
in GLASS-TYPE	VIS-TRANS	
in BUILDING-SHADE and FIXED-SHADE	SHADE-VIS-REFL  SHADE-GND-REFL	
in SPACE-CONDITIONS	DAYLIGHTING DAYLIGHT-REP-SCH LIGHT-CTRL-PROB LIGHT-CTRL-STEPS LIGHT-CTRL-TYPE1 LIGHT-CTRL-TYPE2 LIGHT-REF-POINT1 LIGHT-REF-POINT2	LIGHT-SET-POINT1 LIGHT-SET-POINT2 MAX-GLARE MIN-POWER-FRAC MIN-LIGHT-FRAC VIEW-AZIMUTH ZONE-FRACTION1 ZONE-FRACTION2
in WINDOW	CONDUCT-TMIN-SCH** GLARE-CTRL-PROB MAX-SOLAR-SCH** OPEN-SHADE-SCH**	SUN-CTRL-PROB** VIS-TRANS-SCH WIN-SHADE-TYPE
in WINDOW DOOR ROOF EXTERIOR-WALL UNDERGROUND-WALL UNDERGROUND-FLOOR and INTERIOR-WALL	INSIDE-VIS-REFL	
** can also be used without daylighting		

As is the case when custom weighting factors are being used, all of the bounding surfaces of a space should be input, even INTERIOR-WALLs across which negligible heat transfer takes place.

### Use of Window and Exterior Wall Multipliers

If an exterior wall in a daylit space has a number of identical windows, the windows should be entered separately rather than using MULTIPLIER (which would give an incorrect illuminance calculation since individual windows would not be positioned correctly on the wall). Similarly, for a daylit space, MULTIPLIER should not be used on any exterior wall that contains a window.

### Weather Files

We recommend that weather files with measured solar radiation (such as TMY and WYEC files) be used for DOE-2 daylighting simulation because the solar information, coupled with a luminous efficacy calculation ( $(\text{irradiance}) \times (\text{luminous efficacy}) = \text{illuminance}$ ), gives a relatively good determination of the exterior daylight availability hour by hour as the sky conditions change. You can do daylighting simulation with non-solar weather files (such as TRY files), but the calculation will not be as accurate.

### Thermal Zoning

To correctly calculate both direct and inter-reflected illuminance, one should try to model thermal zones consisting of several rooms separated by interior walls as a representative room with a multiplier. An example of this is shown in Fig. 2.6. ROOM-1 is the representative room, with MULTIPLIER = 4. INTERIOR-WALLS IW-1 and IW-2 should have INT-WALL-TYPE = ADIABATIC. INTERIOR-WALL IW-3 could be INT-WALL-TYPE = STANDARD or ADIABATIC. (See section "Floor Multipliers and Interior Wall Types", p.2.91 for a description of INT-WALL-TYPE.) The floor and ceiling of ROOM-1 would probably be input as interior walls with INT-WALL-TYPE = ADIABATIC.

XBL 8211-7338

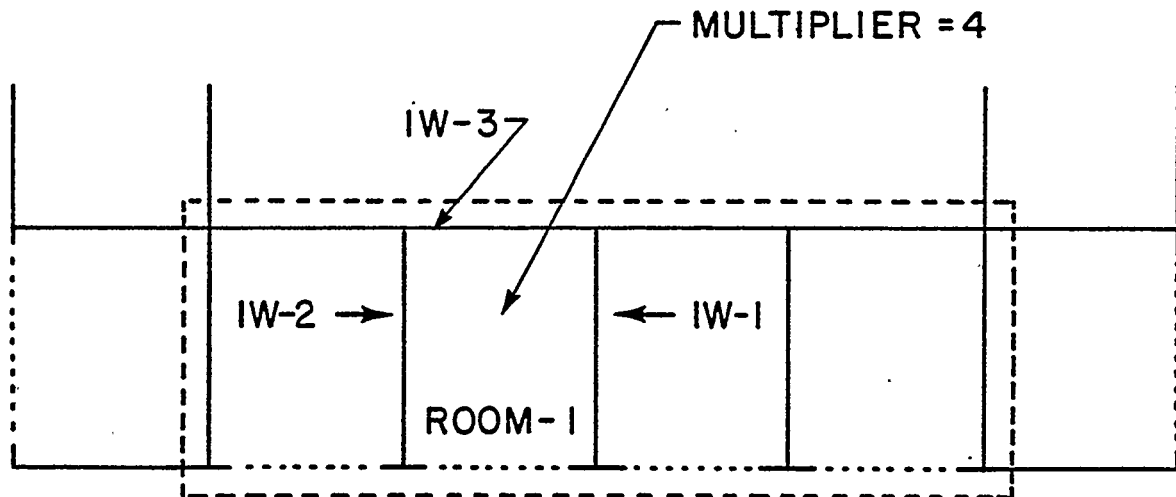
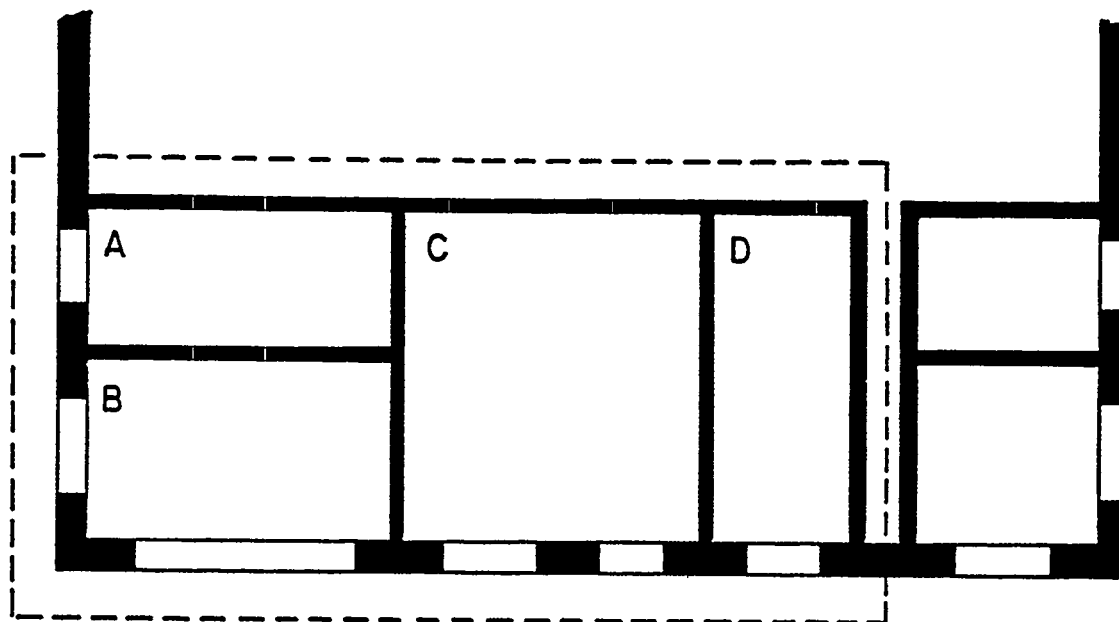

**Figure 2.6:** For daylighting purposes the thermal zone indicated by the dashed boundary line should be modeled as a typical room with a MULTIPLIER of 4.



Sometimes a representative room cannot be found. Figure 2.7 shows a section of a building with four rooms having different daylight characteristics because of floor area, orientation, and window size. In this case, the analyst must choose between two alternatives: (1) simplify input by lumping the rooms into a single thermal zone, neglect partitions, and thereby get a possibly questionable daylighting result; or (2) describe each room as a separate thermal zone, input the partitions, and obtain an accurate daylighting calculation.

XBL 8211-7337



**Figure 2.7:** Rooms A, B, C, and D have different daylighting characteristics. If lumped into a single zone, input is simplified, but daylighting calculation will be inaccurate.

### Surface Orientation

In the calculation of inter-reflected illuminance, the daylighting program uses surface tilt to distinguish between floors, walls, and ceilings. It is therefore important that the TILT values of all the bounding surfaces of a space be correctly specified. This applies not only to EXTERIOR-WALLS, but also to INTERIOR-WALLS, and UNDERGROUND-FLOORS and UNDERGROUND-WALLS.

### Multiple Lighting Zones

The daylighting program allows a thermal zone to be divided into two independently-controlled lighting zones. An example is shown in Fig. 2.8(a), where a relatively deep thermal zone has two lighting zones of equal area.

It is also possible to daylight only part of a thermal zone. Fig. 2.8(b) shows an example in which room A, with 40% of the zone's floor area, is daylit, whereas B, C, and D, having no windows, are not daylit. Note that a reference point and zone fraction are specified only for the daylit room.

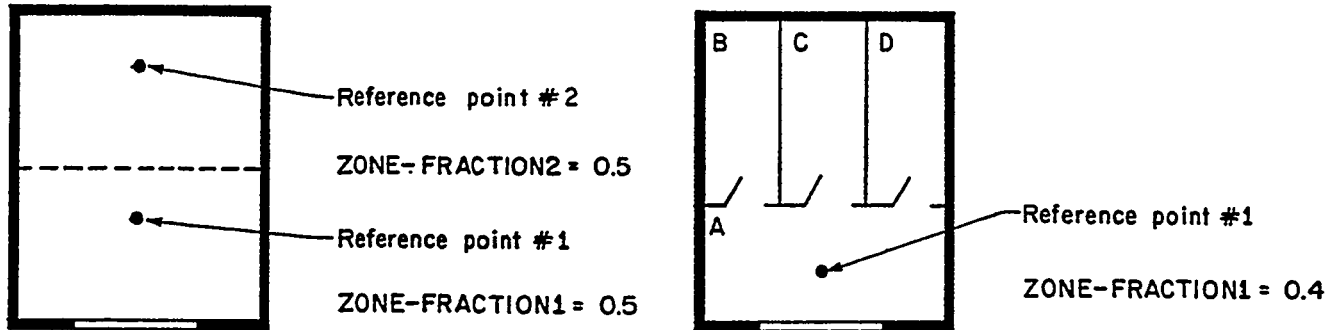

(a) two independently controlled lighting zones, each with 50% of the area of the thermal zone;

(b) a thermal zone with four rooms. Only room (a), with 40% of the floor area, is daylit.

Figure 2.8: Examples of multiple lighting zones in a single thermal zone

**Translucent Glazing**

Skylights with diffusing glass, translucent fabric roofs, etc., can be modeled as clear glazing with a diffusing shade. For example, the input for a skylight with specularly-reflective, diffusely-transmitting glass, having a visible transmittance at normal incidence of 0.14 and a shading coefficient of 0.20, might be as follows:

```

GT-1      = GLASS-TYPE  VIS-TRANS  = 1.0
           SHADING-COEF = 1.0  ..
VT-MULT-1 = SCHEDULE   THRU DEC 31 (ALL) (1,24) (.14) ..
SC-MULT-1 = SCHEDULE   THRU DEC 31 (ALL) (1,24) (.20) ..
           .
           .
           .
WINDOW    GLASS-TYPE      = GT-1
           VIS-TRANS-SCH  = VT-MULT-1
           SHADING-SCHEDULE = SC-MULT-1
           WIN-SHADE-TYPE  = FIXED-INTERIOR
           .
           .
           .
           ..
    
```

If the outside surface of the glazing material reflects diffusely, rather than specularly, WIN-SHADE-TYPE = FIXED-EXTERIOR is recommended.

### Fins, Overhangs, and Other Shading Surfaces

The daylighting program accounts for the presence of overhangs and other shading surfaces which affect the amount of solar radiation and visible light that strikes the windows (see p.2.74, "Fixed Shades, Fins, and Overhangs"). There are five categories of shading surfaces in DOE-2:

1) Shades defined by BUILDING-SHADE	} global shades
2) Shades defined by FIXED-SHADE	
3) Shades defined by EXTERIOR-WALLs with SHADING-SURFACE = YES ("self shades")	
4) Shades associated with window SETBACK	} local shades
5) Overhangs and fins generated by the WINDOW keywords OVERHANG-A, LEFT-FIN-A, RIGHT-FIN-A, etc. ("overhangs" and "fins")	

For daylighting, the program assumes local shades are opaque and black, i.e., they neither transmit nor reflect incident light. A horizontal "overhang", for example, is modeled as blocking part of the diffuse light from the sky and the direct light from the sun, and reflecting none of the light from the ground.

XBL 8211-7333

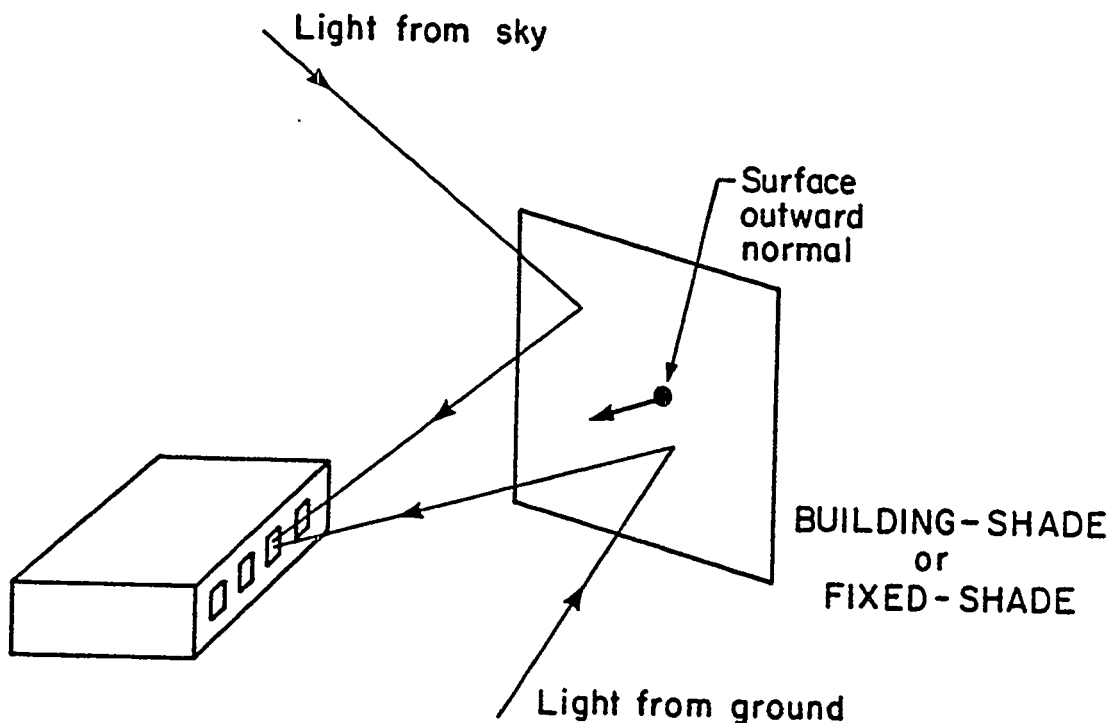

Figure 2.9: Shading surface oriented so that building sees luminous side of shade (the other side of the shade is assumed to be non-reflective).

Global shades are also assumed to be opaque, but, unlike local shades, they are assumed to have luminance due to the light from the sky and ground which they reflect. (However, the building itself is assumed to have no effect on this luminance. For this reason, light shelves cannot be accurately modeled.) Only one side of the shade is taken to be luminous. For BUILDING-SHADE and FIXED-SHADE, this is the side from which the surface outward normal points. For "self shades", it is the outside of the wall. To receive reflected light from BUILDING-SHADES and FIXED-SHADES (which may represent neighboring buildings, trees, etc.,) the shade azimuth should be chosen so that the surface outward normal points toward the building, as shown in Fig. 2.9. The visible reflectance of BUILDING-SHADES and FIXED-SHADES is given by the SHADE-VIS-REFL keyword and the ground reflectance by the SHADE-GND-REFL keyword. The visible reflectance of "self shades" is calculated from the absorptance of the exterior wall which generates the "self shade".

In general, it is recommended that building projections be described as "fins" and "overhangs", category (5).

### Skylights with Light Wells

Skylights often have a rectangular light well (Fig. 2.10) which is deep enough to cause substantial attenuation of the light which is transmitted into the room below. This attenuation can be approximately accounted for by multiplying  $T_{vis}$ , the visible transmittance of the skylight glazing material, by  $W_e$ , the light well efficiency factor<sup>†</sup> given in Fig. 2.11.  $W_e$  is determined by the well wall reflectance and by the well index, which is related to the dimensions of the well.

XBL 8211-7332

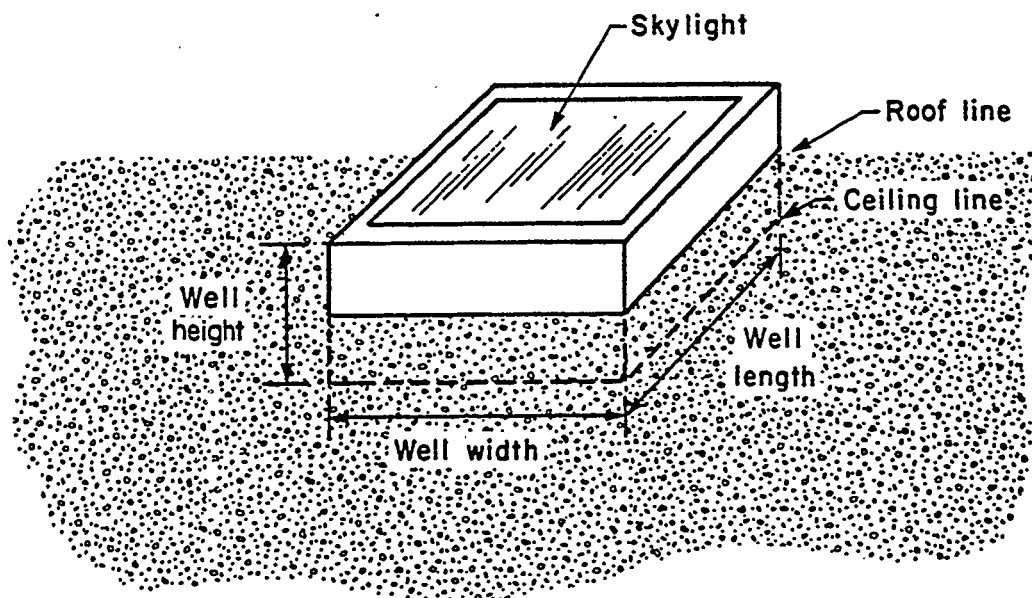

Figure 2.10: Skylight with light well.

<sup>†</sup> IES Lighting Handbook, 1981 Reference Volume, Illuminating Engineering Society of North America, p.9-84 ff.

For example, if well height = 3 ft,  
 well width = 4 ft,  
 and well length = 6 ft,  
 then...

$$\begin{aligned} \text{well index} &= \frac{(\text{well height}) \times (\text{well width} + \text{well length})}{2 \times (\text{well length}) \times (\text{well width})} \\ &= \frac{3 \times (4 + 6)}{2 \times 4 \times 6} = 0.63 \end{aligned}$$

If the well wall reflectance is 80%, Fig. 2.11 gives  $W_e = 0.74$ . If  $T_{\text{vis}}$  is 90%, then the effective skylight transmittance that would be input to DOE-2 is

$$\text{VIS-TRANS} = T_{\text{vis}} \times W_e = 0.90 \times 0.74 = 0.67.$$

### Domed Skylights

The visible transmittance of the acrylic material commonly used in domed skylights is generally given for the flat-sheet material before it is formed. The forming process produces a dome with a thickness that decreases towards the center. To account for the effect of this thickness variation and for the shape of the dome, the following equation can be used<sup>†</sup> to determine an effective transmittance:

$$T_{\text{eff}} = 1.25 T_{\text{vis}} (1.18 - 0.416 T_{\text{vis}})$$

where  $T_{\text{vis}}$ , the acrylic sheet's unformed visible transmittance at normal incidence, can be obtained from skylight manufacturer's data. (If the skylight has a light well, the above value of  $T_{\text{eff}}$  should also be multiplied by the well efficiency factor,  $W_e$ , as described in the previous section.)

#### Example:

A skylight consists of a double dome. The outer dome is transparent with an unformed visible transmittance of 90%. The inner dome is translucent with an unformed transmittance of 40%. The effective transmittance of the outer dome is

$$1.25 \times 0.9 (1.18 - 0.416 \times 0.9) = 0.91$$

The effective transmittance of the inner dome is

$$1.25 \times 0.4 (1.18 - 0.416 \times 0.4) = 0.51$$

The effective transmittance of both layers (neglecting inter-reflection between the domes) is then  $0.91 \times 0.51 = 0.46$ . If the well efficiency factor is 0.67, as in the example in the previous section, the value entered into DOE-2 for the net effective transmittance would be

$$\text{VIS-TRANS} = 0.46 \times 0.67 = 0.31$$

Note that, since the inner dome in this example is translucent, a diffusing shade should be assigned with a visible transmittance of 1.0 (see p.2.27, "Translucent Glazing").

<sup>†</sup> IES Lighting Handbook, 1981 Reference Volume, Illuminating Engineering Society of North America, p.9-84 ff.

## EFFICIENCY FACTORS FOR VARIOUS DEPTHS OF LIGHT WELLS

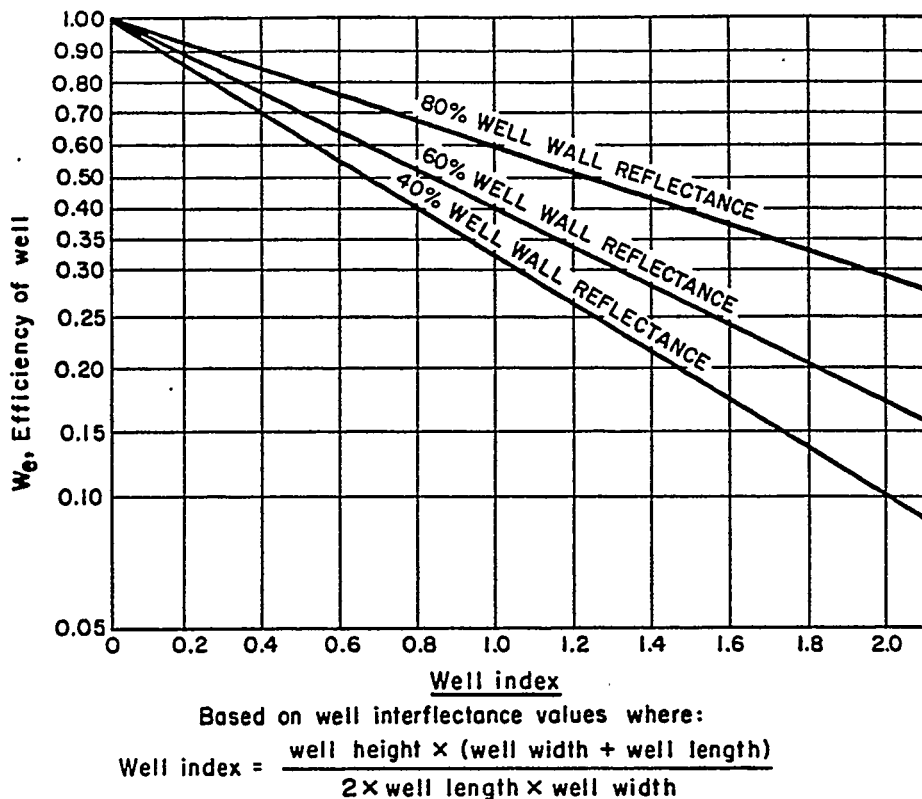

Figure 2.11: Reprinted with permission from the *IES Lighting Handbook*, 1981 Reference Volume, fig. 9-75.

### Window Management

There are several ways of controlling the operation of window shading devices in DOE-2. The shading-coefficient and conductance of a window can be modified each hour to account for the presence of a shading device by specifying a SHADING-SCHEDULE and CONDUCT-SCHEDULE for the window. We call this "preset schedule control". In addition, there are options to control shading devices when solar gain, outside temperature, or daylight glare exceed user-specified threshold values. These are called "threshold controls".

The various control options and their input requirements are summarized in Table 2.4(A), p.2.51. Note in Table 2.4(B) the additional input requirements for windows in spaces for which a daylighting calculation has been requested by specifying DAYLIGHTING = YES in SPACE or SPACE-CONDITIONS.

#### Notes:

- (1) For threshold controls, the preset schedule values given by SHADING-SCHEDULE, CONDUCT-SCHEDULE, or VIS-TRANS-SCH are still used, *but only when the shading device is closed*, i.e., only when a threshold condition is exceeded. When the shading device is open, the schedule values are automatically replaced with a value of 1.0.

- (2) If two or more threshold controls are specified for the same window (e.g., if MAX-SOLAR-SCH and MAX-GLARE are both input), the shading device will be deployed if either threshold condition is met.
- (3) The program cannot model windows with more than one operable shading device. However, windows with one fixed and one operable shading device can be handled by describing the operable shade with SHADING-SCHEDULE, VIS-TRANS-SCH, etc., and describing the properties of the window-plus-fixed-shade combination in the GLASS-TYPE keywords SHADING-COEF, GLASS-CONDUCTANCE, and VIS-TRANS.
- (4) CONDUCT-SCHEDULE will have no effect on a window unless a corresponding SHADING-SCHEDULE is also given.
- (5) WIN-SHADE-TYPE is required only for windows in daylight spaces.

### Multiple Skylights

Rooms often have several individual skylights distributed over the ceiling. If you model this by entering one skylight and using MULTIPLIER, you will get a warning message saying the daylight calculation will be wrong. The problem is that the interior illuminance from a skylight depends on its position relative to the daylighting reference point. If you use a multiplier, all of the skylights "pile up" in one location rather than being spread out. This would generally greatly overestimate the daylight illuminance at the reference point. The solution is to enter the skylights individually, which would significantly increase the input effort as well as the calculation time, or to use the following "equivalent skylight" approach.

The idea is to separate the illuminance and thermal calculations in such a way to combine the multiple skylights into (1) a large skylight that gives nearly the same daylight illuminance as the separate skylights but without heat transfer, and (2) another large skylight that gives heat transfer but no daylighting. Here is an example with nine skylights, with sample values shown in square brackets. The original skylight configuration looks like:

SRG-9305.1

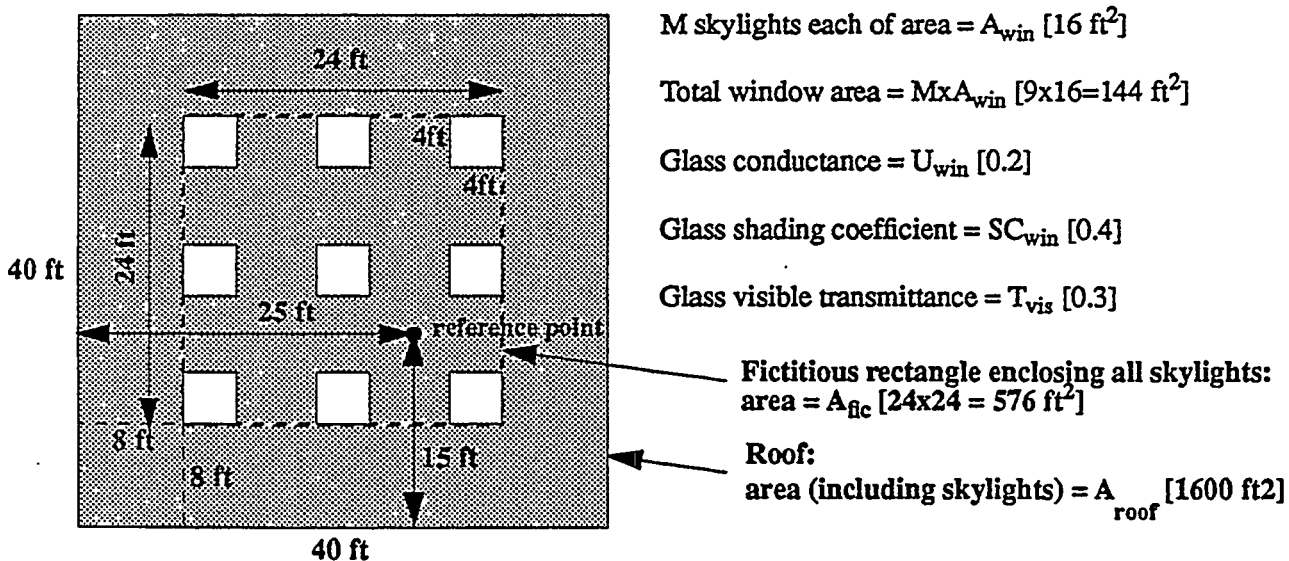

Picture (A): Original Configuration - Roof with daylighting and heat transfer

This is modeled by entering the following two roof sections, (B) and (C):

SRG-9305.2

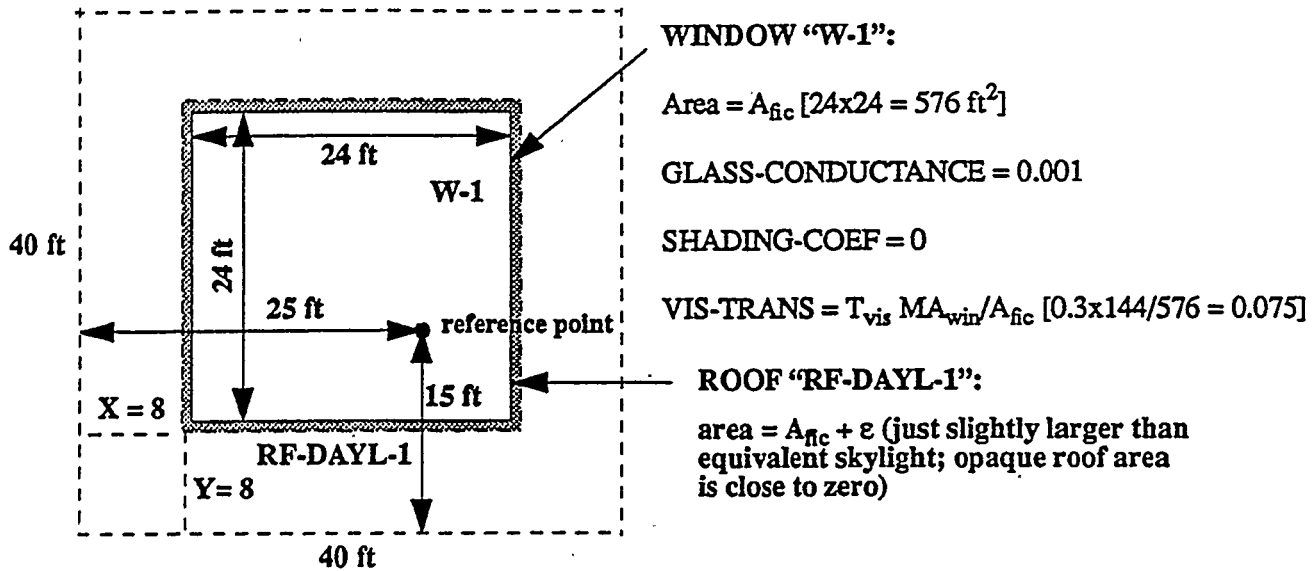

Picture (B): Equivalent roof with daylighting but no heat transfer

SRG-9305.3

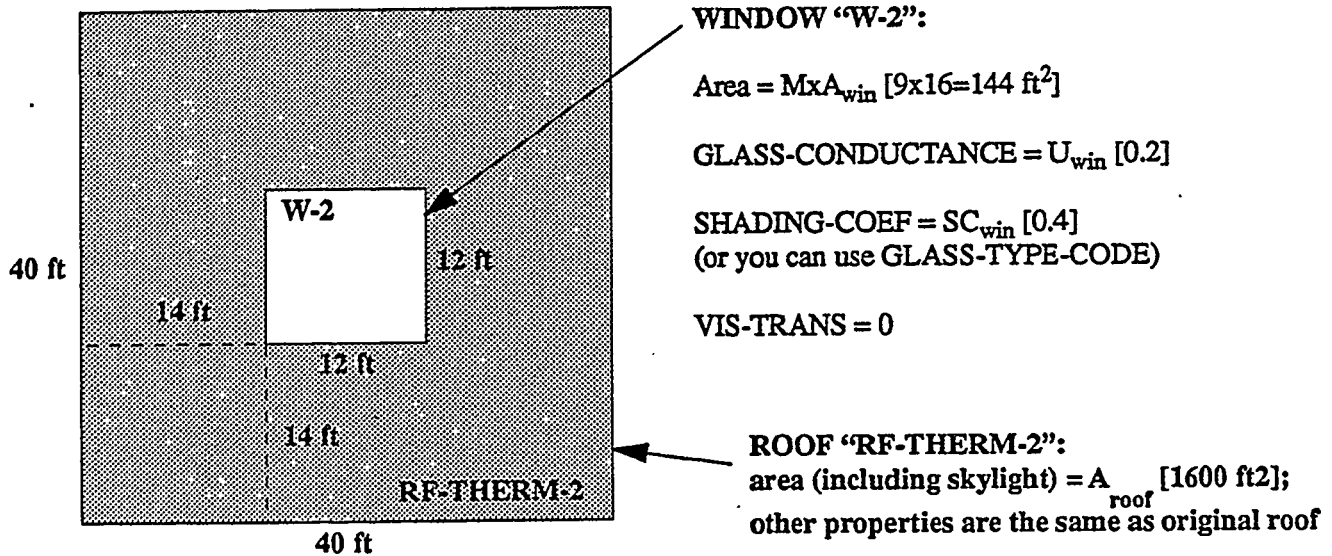

Picture (C): Equivalent roof with daylighting and heat transfer



The DOE-2 input for these two roof sections might look like this:

G-1 = GLASS-TYPE SHADING-COEF = 0.0 \$ No solar gain \$  
GLASS-CONDUCTANCE = 0.001 \$ No conduction \$  
VIS-TRANS = 0.075 \$ Scaled \$ ..

G-2 = GLASS-TYPE SHADING-COEF = 0.4 \$ Actual value\$  
GLASS-CONDUCTANCE = 0.2 \$ Actual value \$  
VIS-TRANS = 0.0 \$ No daylighting \$ ..

S-1 = SPACE DAYLIGHTING = YES  
LIGHT-REF-POINT1 = (25,15,2.5)

...

RF-DAYL-1 = ROOF H = 24.01 W = 24.01 \$ Daylighting roof sect. \$  
TILT = 0  
CONSTRUCTION = CONST-1  
X = 8 Y = 8 Z = 10 ..

W-1 = WINDOW H = 24 W = 24  
X = 0 Y = 0  
GLASS-TYPE = G-1  
INSIDE-VIS-REFL = 0 ..

RF-THERM-2 = ROOF H = 40 W = 40 \$ Heat transfer roof sect. \$  
TILT = 0  
CONSTRUCTION = CONST-1  
X = 0 Y = 0 Z = 10 ..

W-2 = WINDOW H = 12 W = 12  
X = 14 Y = 14  
GLASS-TYPE = G-2 ..

Notes:

- (1) Be sure to adjust the visible transmittance of W-1 as shown in GLASS-TYPE G-1.
- (2) The roof section in (B) should be positioned the same as the dashed bounding rectangle in (A). The position of the roof section in (C) is not important unless the roof is shaded. In this case, (C) can overlap (B).
- (3) If the original skylight array is not conveniently bounded by a single effective rectangle, then two or more effective rectangles can be used, as illustrated for the following L-shaped roof (which would give three effective roof sections):

SRG-9305.4

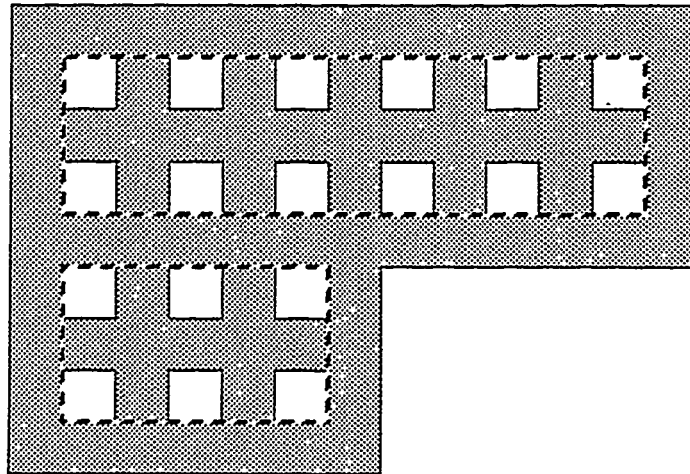

### Limitations of the Daylighting Calculation

The built-in daylight illuminance calculation in DOE-2 works best when most of the illuminance at a reference point is due to light that reaches the reference point directly from the windows (i.e., without reflection from room surfaces), and when the shading devices on the windows, if present, act like diffusers (i.e., drapes, pull-down shades, screens, etc.). As a result, the built-in illuminance calculation cannot reliably simulate the following configurations:

- 1) interior or exterior light shelves;
- 2) light scoops;
- 3) skylights with deep wells;
- 4) roof monitors;
- 5) rooms with internal obstructions (partitions, etc.) that block light from the windows;
- 6) reference point near the back of side-lit rooms that are very deep, i.e., whose depth is more than three times floor-to-ceiling height;
- 7) the light reaching the reference point comes from windows in another space (for example, an atrium providing daylight to adjacent spaces; and
- 8) windows with Venetian blinds or other slatted devices that are highly directional.

In these cases, the recommended procedure is to determine daylight illuminance factors from physical scale model measurements under real or artificial skies, or from a detailed illuminance calculation, such as SUPERLITE\*. You can then read these factors into DOE-2 using the Functional Value feature and override the built-in daylight factor calculation. For an example of doing this, see LOADS Example 4, p.1.17, "Using Measured Daylight Factors". An actual application of this process is described in "Modeling Complex Daylighting with DOE-2.1C" by M. Steven Baker, DOE-2 *User News*, Vol. 11, No. 1, Spring 1990\*.

---

\* Contact the Windows and Daylighting Group (510-486-6345) at LBL for information on how to obtain SUPERLITE.  
Contact the Simulation Research Group (510-486-5711) at LBL for the Spring 1990 *User News*.

**Table 2.4**  
**Window Shading Device Control Options**

<b>A. Windows in Non-Daylit Spaces (DAYLIGHTING = NO)</b>		
<b>Control Type</b>	<b>Input Required</b>	<b>Effect</b>
Preset schedule	SHADING-SCHEDULE*	Shading coefficient of glazing is multiplied hourly by SHADING-SCHEDULE value.
Solar gain control	MAX-SOLAR-SCH SHADING-SCHEDULE* (SUN-CTRL-PROB and OPEN-SHADE-SCH optional)††	Shade is fully closed if transmitted direct solar gain exceeds MAX-SOLAR-SCH value.
Heat loss control with movable insulation	CONDUCT-TMIN-SCH CONDUCT-SCHEDULE SHADING-SCHEDULE (OPEN-SHADE-SCH optional)††	Insulation is moved into place if outside drybulb temperature falls below CONDUCT-TMIN-SCH value.
<b>B. Windows in Daylit Spaces (DAYLIGHTING = YES)</b>		
<b>Control Type</b>	<b>Input Required</b>	<b>Effect</b>
Preset schedule	VIS-TRANS-SCH SHADING-SCHEDULE*	Glass visible transmittance and shading coefficient are multiplied hourly by VIS-TRANS-SCH and SHADING-SCHEDULE, respectively.
Solar gain control	MAX-SOLAR-SCH VIS-TRANS-SCH SHADING-SCHEDULE* WIN-SHADE-TYPE† (SUN-CTRL-PROB and OPEN-SHADE-SCH optional)††	Shade is fully closed if transmitted direct solar gain exceeds MAX-SOLAR-SCH value
Heat loss control with movable insulation	CONDUCT-TMIN-SCH CONDUCT-SCHEDULE VIS-TRANS-SCH** SHADING-SCHEDULE WIN-SHADE-TYPE† (OPEN-SHADE-SCH optional)††	Insulation is moved into place if outside drybulb temperature falls below CONDUCT-TMIN-SCH value
Glare control	MAX-GLARE (in SPACE command) VIS-TRANS-SCH SHADING-SCHEDULE* WIN-SHADE-TYPE† (OPEN-SHADE-SCH optional)††	Shade is fully closed if daylight glare at either lighting reference point exceeds MAX-GLARE value
<p>* CONDUCT-SCHEDULE should also be input if shading device significantly affects window conductance.</p> <p>** Since VIS-TRANS-SCH can be assigned, the insulation need not be opaque.</p> <p>† Must be either MOVABLE-INTERIOR (the default) or MOVABLE-EXTERIOR.</p> <p>†† See "Window Management and Solar Radiation" for a description of OPEN-SHADE-SCH</p>		

## Daylighting Commands and Keywords

### BUILDING-LOCATION

#### ATM-MOISTURE

is a list of twelve monthly values, given in inches, of the amount of precipitable moisture in the atmosphere. The values should be chosen from Table 2.5, p.2.65. If the location being analyzed is not in Table 2.5, choose values for a location with a similar climate.

If a similar climate cannot be found, a set of twelve constant monthly values can be assigned according to the following climate types:

Climate Type	Atmospheric Moisture (in.)
Desert (dry air)	0.4
Temperate	0.7 (default)
Tropical (humid air)	1.3

#### ATM-TURBIDITY

is a list of twelve monthly values of atmospheric turbidity (a measure of the amount of aerosols, i.e., particulate pollutants in the atmosphere). The values should be chosen from Table 2.6, p.2.67. If the location being analyzed is not in this Table, choose values for a location with a similar level of atmospheric pollution.

If a similar climate cannot be found, a set of twelve constant monthly values can be assigned according to the following categories:

Category	Atmospheric Turbidity
Rural Area	0.07
Urban Area	0.12 (default)
Industrial Area	0.16

Note: ATM-MOISTURE and ATM-TURBIDITY are used by the program to calculate the luminance of clear skies.

### BUILDING-SHADE and FIXED-SHADE

#### SHADE-VIS-REFL

is the visible reflectance of that side of a BUILDING-SHADE or FIXED-SHADE from which the outward normal points (see text). The other side of the shading surface is assumed to be black, i.e., to have zero reflectance.

#### SHADE-GND-REFL

is the visible reflectance of the ground in the vicinity of the BUILDING-SHADE or FIXED-SHADE.

## GLASS-TYPE

### VIS-TRANS

is the visible (daylight) transmittance of glazing at normal incidence. Values, which can be found in glass manufacturer's product data sheets, vary from about 0.90 for clear, 1/8" sheet glass, to about 0.05 for some kinds of reflective, heat-absorbing glazing. You should not specify VIS-TRANS if GLASS-TYPE-CODE  $\geq 1000$ , in which case it is taken from the Window Library (see "Window Library", p.2.98).

Note: *visible* transmittance, which determines how much daylight is transmitted by the glass, should not be confused with *total solar* transmittance, which determines how much solar radiation (ultraviolet, visible, and infrared) is transmitted.

## SPACE-CONDITIONS

### DAYLIGHTING

takes code-word values YES or NO (the default). If YES, a daylighting calculation will be done for the space.

### LIGHT-REF-POINT1 LIGHT-REF-POINT2

give the x, y, z coordinates (in the space coordinate system) of the reference points at which daylight illuminance levels are to be calculated. If DAYLIGHTING = YES, then LIGHT-REF-POINT1 must be specified. If you want to divide a thermal zone into two independently-controlled lighting zones, then LIGHT-REF-POINT2 should also be specified.

It is assumed that the photocells which control the electric lighting system respond to the light levels at the specified reference points.

**Example:** The lighting reference point is located at  $x = 20$ ,  $y = 10$ , and  $z = 2.5$ ft (desk height). Then, LIGHT-REF-POINT1 = (20,10,2.5).

Since the location of the reference point(s) is used to determine if the design illuminance condition is met, specification of these points must be done with some care if the daylighting results are to be meaningful.

Zones are generally laid out parallel to the plane of the glazing and a typical depth is 15 ft. Thus, a row of perimeter offices may be treated as a single SPACE with a MULTIPLIER, with results from a single sensor being used to determine daylighting savings for the entire row. If the reference point is placed too near the window, the levels will be high relative to the rest of the space and will overpredict savings. A point at the back of the room will underpredict total savings. Since the drop-off in illuminance from vertical glazing is a function with an exponentially declining shape, a point just beyond the midpoint is normally selected as a reasonable location. Until more definitive data is available, the reference point(s) should be

placed two-thirds of the zone depth back from the window wall.

These guidelines assume the use of a ceiling-mounted sensor. Although these sensors may be located at a specific point in the room, they generally "view" the reflected light from a larger area in the room. Thus, the sensor itself tends to see an average light level.

**ZONE-FRACTION1**  
**ZONE-FRACTION2**

give the fraction of the floor-area of the thermal zone (SPACE) which is controlled by LIGHT-REF-POINT1 and LIGHT-REF-POINT2, respectively. If only one reference point (i.e. LIGHT-REF-POINT1) is specified, then ZONE-FRACTION1 should not exceed 1.0. If ZONE-FRACTION1 is less than 1.0, then a fraction of the thermal zone equal to  $1.0 - \text{ZONE-FRACTION1}$  is assumed to be non-daylit. If two reference points are specified (i.e. LIGHT-REF-POINT1 and LIGHT-REF-POINT2), then the sum of ZONE-FRACTION1 and ZONE-FRACTION2 should not exceed 1.0. If  $\text{ZONE-FRACTION1} + \text{ZONE-FRACTION2}$  is less than 1.0, then a fraction of the thermal zone equal to  $1.0 - (\text{ZONE-FRACTION1} + \text{ZONE-FRACTION2})$  is assumed to be non-daylit.

**LIGHT-SET-POINT1**  
**LIGHT-SET-POINT2**

give the desired lighting level, in footcandles, at LIGHT-REF-POINT1 and LIGHT-REF-POINT2, respectively. Recommended values, which depend on type of activity, occupant age, and other factors, may be found on p.2.5ff of the IES Lighting Handbook, 1987 Application Volume. It is assumed that this lighting level will be produced by the electric lights at full input power as specified by keywords LIGHTING-KW or LIGHTING-W/SQFT.

**LIGHT-CTRL-TYPE1**  
**LIGHT-CTRL-TYPE2**

take code-words which specify the type of electric lighting control system at LIGHT-REF-POINT1 and LIGHT-REF-POINT2, respectively. Allowed values are CONTINUOUS and STEPPED.

*CONTINUOUS*

gives the dimmable control system shown in Fig. 2.12 in which light output varies linearly and continuously with input power. Non-linear dimming control can be modeled using the functional input capability. See p.1.3, INPUT FUNCTIONS IN LOADS AND SYSTEMS, and the Daylighting Sample in the *Sample Run Book (2.1E)*. Specifically, the fractional light output (light output at partial power divided by light output at full power) decreases from 1.0 at full power to a value MIN-LIGHT-FRAC at minimum power fraction MIN-POWER-FRAC (see keyword definitions below).

---

In the left column above, bold-faced words are commands, non-bold words are keywords, and italicized words are code-words.

STEPPED

gives the control system shown in Fig. 2.13, in which power input and light output vary in discrete, equally spaced steps. The number of steps (excluding zero) is given by keyword LIGHT-CTRL-STEPS.

XBL 8211-7343(a)

CONTINUOUS lighting control

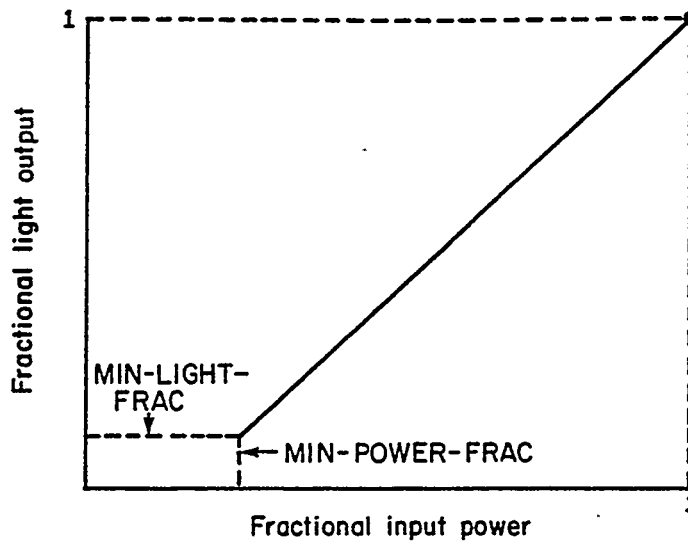

Figure 2.12: Relationship between light output and electrical input for a continuous dimming system.

MIN-POWER-FRAC

specifies the lowest input power fraction for a continuously dimmable lighting control system (see Fig. 2.12). See manufacturer's data for appropriate value.

MIN-LIGHT-FRAC

specifies the fractional light output that a continuously dimmable lighting control system produces at the minimum fractional input power given by MIN-POWER-FRAC (see Fig. 2.12). See manufacturer's data for appropriate value.

LIGHT-CTRL-STEPS

gives the number of steps, excluding zero, in a stepped lighting control system. The steps are assumed to be equally spaced, as shown in Fig. 2.13.



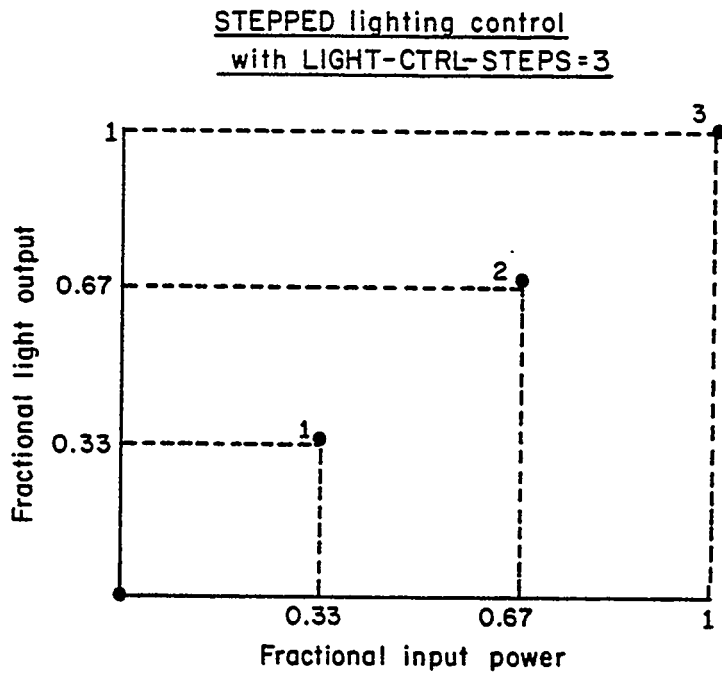

Figure 2.13: STEPPED lighting control with LIGHT-CTRL-STEPS=3

#### LIGHT-CTRL-PROB

may be specified if a stepped lighting control system is manually operated, such as in a simple one-step, on-off system. This keyword gives the probability the occupants of a daylit space will set the electric lights to the correct level to obtain the required illuminance. The rest of the time the lights are assumed to be set one step too high. For example, consider an on-off system with

```
LIGHT-SET-POINT1 = 60,
LIGHT-CTRL-TYPE1 = STEPPED,
LIGHT-CTRL-STEPS = 1, and
LIGHT-CTRL-PROB = 0.7
```

Then, when daylighting exceeds 60 fc, the electric lights will be off 70% of the time and on 30% of the time.

## DAYLIGHT-REP-SCH

is the name of a schedule which specifies the time periods over which various entries in daylighting reports LS-G and LS-J are to be accumulated. See Appendix C for more details.

### Example:

For space SP-1, accumulate report entries, such as percent lighting energy reduction by daylighting in report LS-G, only from 7am to 6pm on weekdays, i.e., only for the hours that the space is occupied.

```
OCC-HOURS-1 = SCHEDULE THRU DEC 31
              (MON,FRI) (1,7) (0) (8,18) (1)
              (19,24) (0)
              (SAT) (1,24) (0)
              (SUN,HOL) (1,24) (0) ..
```

```
SP-1 = SPACE DAYLIGHTING = YES
      DAYLIGHT-REP-SCH = OCC-HOURS-1
```

## MAX-GLARE

The program will automatically deploy window shading devices to reduce daylight glare (if WIN-SHADE-TYPE = MOVABLE-INTERIOR or MOVABLE-EXTERIOR) whenever glare with bare windows exceeds the MAX-GLARE value.

Table 2.7 gives recommended MAX-GLARE values for different situations. For example, MAX-GLARE = 22 would be specified for general office work.

If a space has two or more windows, the shading devices will be deployed one by one in the order in which the windows are input, until the glare level at each lighting reference point falls below MAX-GLARE. If MAX-GLARE is not specified, no glare control will occur.

## VIEW-AZIMUTH

is the direction of occupant view (in the horizontal plane), measured as a clockwise angle from the space y-axis (see Fig. 2.14). It is used by the program to calculate daylight glare. If not specified, VIEW-AZIMUTH will be calculated by the program for a view direction parallel to the first window in the space (obtained by rotating clockwise by 90° the horizontal projection of the window outward normal). In general, the daylight glare contribution from a particular window is highest when the occupant faces the window.

# VIEW-AZIMUTH

XBL 8211-7342

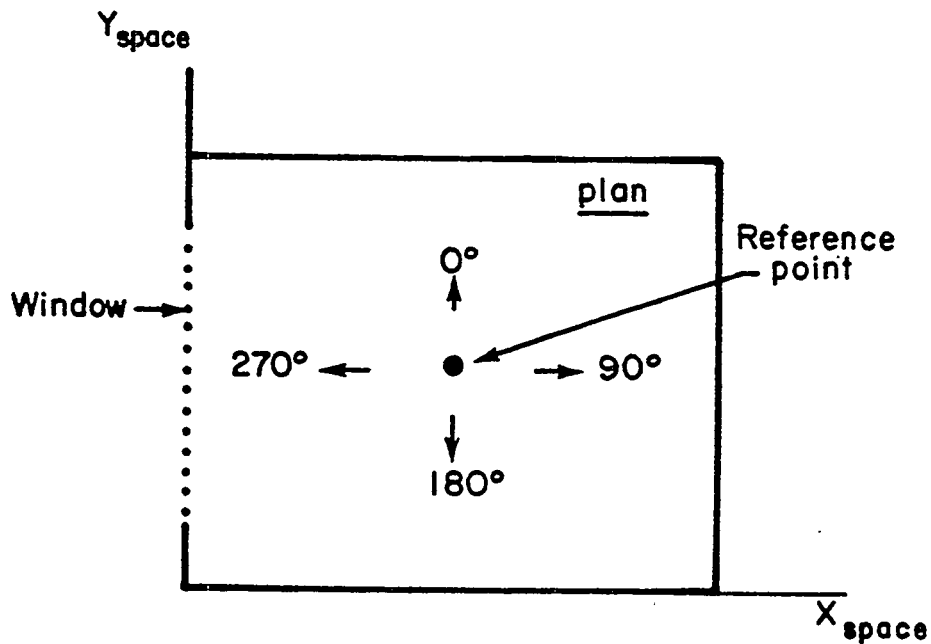

Figure 2.14: VIEW-AZIMUTH for four different occupant view directions. Daylight glare from the window will be greatest when occupant faces window, which corresponds to VIEW-AZIMUTH=270° in this example.

## Daylighting input examples for SPACE-CONDITIONS

### Example (1)

A space has a single lighting zone with 2.4 watts/ft<sup>2</sup> of installed electric lighting power. The photocell of a 5-step lighting control responds to the lighting level at x = 10, y = 20, z = 2.5 ft. The illuminance set point is 60 footcandles.

The SPACE-CONDITIONS (or SPACE) daylighting input would then be

\$ --- ONE LIGHTING ZONE WITH STEPPED SYSTEM --- \$

```
SCON-1    =    SPACE-CONDITIONS
            DAYLIGHTING          =    YES
            LIGHTING-W/SQFT      =    2.4
            LIGHT-REF-POINT1     =    (10,20,2.5)
            ZONE-FRACTION1       =    1.0 (the default)
            LIGHT-SET-POINT1     =    60
            LIGHT-CTRL-TYPE1     =    STEPPED
            LIGHT-CTRL-STEPS     =    5
            .
            .
            . ..
```

**Example (2)**

An office space with 2 watts/ft<sup>2</sup> of installed electric lighting power has three lighting zones. The first lighting zone, with 40% of the floor area, has a continuously dimmable control system with a setpoint of 60 footcandles and a minimum light output of 10 footcandles at 30% input power. The lighting reference point is at x = 10, y = 10, z = 2.5ft. The second lighting zone, with 50% of the floor area, has a 4-step control system with a setpoint of 60 footcandles. The lighting reference point is at x = 10, y = 25, z = 2.5ft. A third lighting zone with 10% of the floor area is not daylit.

The SPACE-CONDITIONS (or SPACE) daylighting input would then be:

\$ --- THREE LIGHTING ZONES --- \$

SCON-2	=	SPACE-CONDITIONS	
		DAYLIGHTING	= YES
		LIGHT-CTRL-STEPS	= 4
		LIGHT-CTRL-TYPE1	= CONTINUOUS
		LIGHT-CTRL-TYPE2	= STEPPED
		LIGHT-REF-POINT1	= (10,10,2.5)
		LIGHT-REF-POINT2	= (10,25,2.5)
		LIGHT-SET-POINT1	= 60
		LIGHT-SET-POINT2	= 60
		LIGHTING-W/SQFT	= 2
		MIN-LIGHT-FRAC	= 0.167
		MIN-POWER-FRAC	= 0.3
		ZONE-FRACTION1	= 0.4
		ZONE-FRACTION2	= 0.5
		.	
		.	
		.	
		..	

Note that no entry is required for the third, non-daylit lighting zone.

**Example (3)**

A space has a task-ambient lighting system. Task lighting is provided by electric lights with an installed power of 0.5 watts/ft<sup>2</sup>. Ambient lighting with a setpoint of 10 footcandles is provided by daylight plus installed electric lighting at 0.4 watts/ft<sup>2</sup> controlled by a 3-step control system. The ambient lighting reference point is at  $x = 15$ ,  $y = 20$ ,  $z = 2.5$ ft.

The SPACE CONDITIONS (or SPACE) daylighting input would then be:

\$ --- TASK-AMBIENT SYSTEM --- \$

```
SCON-3   =   SPACE-CONDITIONS
           DAYLIGHTING           =   YES
           LIGHT-CTRL-TYPE1      =   STEPPED
           LIGHT-REF-POINT1      =   (15,20,2.5)
           LIGHT-SET-POINT1      =   10
           LIGHTING-W/SQFT       =   0.4
           TASK-LT-W/SQFT        =   0.5
           ZONE-FRACTION1        =   1.0 (the default)
           .
           .
           . ..
```

## WINDOW

### WIN-SHADE-TYPE

specifies a code-word giving the type of shading device when a shading device is present on the window for sun and/or glare control. The choices are:

*MOVABLE-INTERIOR*

(the default) interior shade which can be retracted, such as drapes or Venetian blinds.

*MOVABLE-EXTERIOR*

exterior shade which can be retracted.

*FIXED-INTERIOR*

interior shade which cannot be retracted.

*FIXED-EXTERIOR*

exterior shade which cannot be retracted.

Note: If SHADING-SCHEDULE is not assigned to a window, the window will be considered to have no shading device and WIN-SHADE-TYPE will be ignored.

### VIS-TRANS-SCH

is the u-name of a schedule which gives the daylight transmittance of the window shading device when it covers the window. (If WIN-SHADE-TYPE = MOVABLE-INTERIOR or MOVABLE-EXTERIOR, the program will use a transmittance multiplier value of 1.0 when the shade is retracted.) Typical visible transmittance values for translucent drapes and shades are given in Table 2.8. A transmittance schedule is used, rather than a single fixed value, to allow seasonal change in the transmittance of the shading device. Note that this schedule is used only for windows in a space with DAYLIGHTING = YES.

For windows with a shading device in a daylit space, be sure to specify not only VIS-TRANS-SCH, but also SHADING-SCHEDULE (and CONDUCT-SCHEDULE if the change in window conductance with the shade in place is significant).

In the daylighting calculation, shading surfaces are modeled as perfect diffusers with a daylight transmittance which is independent of angle of incidence. For this reason, slat-type devices, such as Venetian blinds, whose transmittance is a strong function of the angles at which light enters and leaves the device, can only be modeled very approximately.

### MAX-SOLAR-SCH

is the u-name of a schedule of direct solar gain values in Btu/ft<sup>2</sup>-hr. The program will automatically deploy a shading device if the heat gain per ft<sup>2</sup> of window from direct (beam) solar radiation transmitted through the window exceeds the specified value. If MAX-SOLAR-SCH is specified, a corresponding SHADING-SCHEDULE (and

---

In the left column above, bold-faced words are commands, non-bold words are keywords, and italicized words are code-words.

CONDUCT-SCHEDULE, if desired) should be assigned to the window.

Note: if the space is daylight, a VIS-TRANS-SCH should be assigned and WIN-SHADE-TYPE should be set equal to MOVABLE-INTERIOR or MOVABLE-EXTERIOR. However, if the SHADING-SCHEDULE value in a particular hour is 1.0, the shade will be forced to be retracted and MAX-SOLAR-SCH will have no effect.

#### SUN-CTRL-PROB

may be specified if the sun control device on a window is manually operated. This keyword gives the probability that the occupants of a space will deploy the shading device if the transmitted direct solar gain exceeds the MAX-SOLAR-SCH value.

#### GLARE-CTRL-PROB

may be specified if manual operation of a window shading device for glare control is desired. This keyword gives the probability that the occupants of a space will deploy a shading device when the MAX-GLARE value (see SPACE-CONDITIONS) is exceeded.

#### CONDUCT-TMIN-SCH

is a schedule of values of outside drybulb temperature below which movable insulation will be deployed on a window. If this keyword is specified, a corresponding SHADING-SCHEDULE and CONDUCT-SCHEDULE should be assigned to the window. In addition, if the space is daylight, a VIS-TRANS-SCH should be assigned and WIN-SHADE-TYPE should be set equal to MOVABLE-INTERIOR or MOVABLE-EXTERIOR.

Note that the CONDUCT-SCHEDULE, in the WINDOW command, will have no effect on a window unless a corresponding SHADING-SCHEDULE is also given.

### Example of Window Shading Device Assignment

Window glazing has a visible transmittance of 0.83. Operable drapes have a visible transmittance multiplier of 0.35, a shading coefficient multiplier of 0.25, and a conductance multiplier of 0.85. The drapes will be closed when transmitted direct solar gain exceeds 30 Btu/ft<sup>2</sup>-hr.

The input might be

```
SC-SCH-1      =  SCHEDULE THRU DEC 31 (ALL)(1,24)(0.25) ..
TVIS-SCH-1    =  SCHEDULE THRU DEC 31 (ALL)(1,24)(0.35) ..
COND-MULT-1   =  SCHEDULE THRU DEC 31 (ALL)(1,24)(0.85) ..
SOL-SCH-1     =  SCHEDULE THRU DEC 31 (ALL)(1,24)(30) ..
               .
               .
GT-1          =  GLASS-TYPE
                VIS-TRANS = 0.83
                SHADING-COEF = 0.75
                .
                . ..
SP-1          =  SPACE
                DAYLIGHTING = YES
                .
                . ..
WIN-1        =  WINDOW
                GLASS-TYPE = GT-1
                WIN-SHADE-TYPE = MOVABLE-INTERIOR
                VIS-TRANS-SCH = TVIS-SCH-1
                MAX-SOLAR-SCH = SOL-SCH-1
                SHADING-SCH = SC-SCH-1
                CONDUCT-SCH = COND-MULT-1
                .
                .
                . ..
```



WINDOW, DOOR, EXTERIOR-WALL, ROOF, UNDERGROUND-WALL,  
UNDERGROUND-FLOOR, INTERIOR-WALL

INSIDE-VIS-REFL

is the inside surface visible reflectance (hemispherical average). For INTERIOR-WALL a list of two values is required, where the first value is the reflectance on the side of the interior wall that is in the space the wall is defined, and the second value is the reflectance on the other side of the wall.

For EXTERIOR-WALL,  
ROOF,  
UNDERGROUND-WALL,  
UNDERGROUND-FLOOR, and  
INTERIOR-WALL,

the default value of INSIDE-VIS-REFL is

0.2 if surface is a floor ( $TILT > 170^\circ$ ),

0.5 if a wall ( $10^\circ \leq TILT \leq 170^\circ$ ), and

0.7 if a ceiling ( $TILT < 10^\circ$ ).

**Daylighting Verification and Summary Reports**

The following verification and summary reports may be printed to help you understand the effects of daylighting. These reports are described in Appendix C of this Supplement and are illustrated in the daylighting sample in the *Sample Run Book (2.1E)*.

- Report LV-L Daylight Factor Summary
- Report LS-G Space Daylighting Summary
- Report LS-H Percent Lighting Energy Reduction by Daylighting vs Hour of Day  
(for each daylit space)
- Report LS-I Percent Lighting Energy Reduction by Daylighting vs Hour of Day  
(for whole building)
- Report LS-J Daylight Illuminance Frequency of Occurrence

Table 2.5

Monthly Average Atmospheric Moisture (inches of water) for U.S. Cities

City	Month											
	J	F	M	A	M	J	J	A	S	O	N	D
Montgomery, AL	.65	.56	.65	.85	1.00	1.31	1.58	1.60	1.39	.95	.67	.69
Ft. Smith, AR	.48	.47	.56	.78	1.08	1.39	1.66	1.56	1.16	1.03	.53	.48
Little Rock, AR	.51	.46	.55	.81	.94	1.26	1.47	1.42	1.29	.86	.63	.59
Ft. Huachuca, AZ	.27	.27	.24	.26	.36	.59	1.01	1.01	.73	.48	.31	.27
Phoenix, AZ	.42	.38	.38	.45	.51	.67	1.29	1.31	.92	.63	.43	.40
China Lake, CA	.28	.25	.28	.34	.38	.40	.66	.68	.47	.33	.29	.32
Oakland, CA	.52	.49	.48	.45	.53	.63	.64	.67	.64	.59	.61	.50
Point Mugu, CA	.46	.45	.48	.51	.65	.79	1.04	.97	.89	.69	.54	.49
San Diego, CA	.46	.46	.47	.50	.60	.71	.98	1.04	.83	.62	.60	.48
San Nicolas Is., CA	.47	.42	.43	.42	.52	.65	.85	.80	.73	.61	.53	.46
Santa Maria, CA	.48	.48	.48	.52	.61	.68	.82	.80	.74	.63	.55	.49
Santa Monica, CA	.48	.51	.49	.56	.65	.75	.93	.95	.85	.72	.54	.50
Denver, CO	.20	.19	.21	.27	.41	.57	.75	.71	.51	.35	.25	.20
Grand Junction, CO	.25	.24	.24	.28	.39	.51	.73	.72	.52	.41	.31	.26
Cocoa Beach, FL	.86	.85	.95	1.03	1.26	1.60	1.73	1.79	1.76	1.37	1.02	.90
Key West, FL	1.04	1.03	1.06	1.13	1.34	1.65	1.64	1.71	1.78	1.53	1.20	1.05
Miami, FL	.96	.95	1.00	1.10	1.31	1.64	1.69	1.74	1.77	1.50	1.16	1.10
Atlanta, GA	.54	.52	.56	.72	.95	1.26	1.48	1.45	1.20	.83	.59	.54
Boise, ID	.35	.32	.30	.34	.44	.59	.60	.60	.52	.42	.40	.32
Joliet, IL	.36	.32	.40	.53	.76	1.11	1.21	1.12	.88	.66	.43	.35
Peoria, IL	.30	.31	.37	.55	.76	1.02	1.17	1.13	.96	.65	.46	.36
Salem, IL	.31	.35	.41	.57	.72	1.09	1.19	1.19	1.12	.74	.46	.42
Dodge City, KS	.28	.27	.30	.42	.61	.86	1.09	1.04	.81	.53	.37	.30
Boothville, LA	.82	.72	.78	1.00	1.13	1.41	1.69	1.72	1.60	1.17	.87	.94
Lake Charles, LA	.74	.72	.77	.95	1.17	1.45	1.70	1.67	1.50	1.05	.83	.78
Nantucket, MA	.38	.36	.40	.53	.73	.97	1.15	1.26	.95	.71	.56	.42
Caribou, ME	.23	.22	.26	.36	.55	.79	.95	.90	.74	.55	.40	.27
Portland, ME	.30	.29	.33	.46	.66	.93	1.08	1.05	.87	.63	.49	.34
Flint, MI	.27	.26	.31	.46	.64	.89	.99	.97	.86	.61	.43	.33
Sault Ste. Marie, MI	.23	.22	.27	.39	.57	.83	.92	.93	.78	.58	.39	.28
Int'l Falls, MN	.19	.19	.23	.35	.52	.77	.90	.87	.68	.49	.30	.22
St. Cloud, MN	.22	.23	.27	.42	.63	.86	1.00	.99	.77	.56	.34	.26
Columbia, MO	.36	.32	.42	.62	.78	1.10	1.23	1.21	.98	.70	.52	.42
Jackson, MS	.59	.60	.65	.87	1.05	1.36	1.59	1.56	1.36	.92	.71	.65
Glasgow, MT	.23	.24	.25	.34	.49	.68	.77	.73	.57	.42	.31	.25
Great Falls, MT	.23	.22	.23	.27	.39	.54	.58	.58	.46	.34	.28	.23
North Platte, NB	.26	.28	.30	.41	.62	.85	1.02	.99	.72	.49	.33	.28
Omaha, NB	.28	.29	.35	.50	.74	1.03	1.18	1.13	.87	.62	.40	.31
Cape Hatteras, NC	.59	.52	.56	.70	.96	1.20	1.57	1.57	1.25	.97	.67	.63
Greensboro, NC	.47	.45	.50	.65	.90	1.18	1.39	1.37	1.11	.77	.55	.47

Table 2.5 (Continued)

Monthly Average Atmospheric Moisture (inches of water) for U.S. Cities

City	Month											
	J	F	M	A	M	J	J	A	S	O	N	D
Bismark, ND	.22	.24	.26	.38	.56	.81	.93	.88	.65	.47	.31	.25
Rapid City, ND	.26	.26	.28	.37	.53	.75	.87	.81	.59	.42	.30	.26
Ely, NV	.21	.20	.20	.22	.31	.42	.54	.57	.38	.29	.26	.21
Albuquerque, NM	.21	.20	.21	.24	.33	.47	.80	.79	.58	.38	.27	.22
Albany, NY	.30	.28	.35	.48	.70	.98	1.11	1.10	.93	.65	.49	.36
Buffalo, NY	.30	.29	.34	.47	.66	.91	1.04	1.02	.87	.63	.46	.35
New York City, NY	.34	.33	.40	.54	.76	1.02	1.18	1.16	1.01	.69	.55	.42
Dayton, OH	.33	.33	.39	.56	.74	1.00	1.13	1.08	.93	.65	.47	.38
Medford, OR	.46	.42	.40	.41	.51	.65	.67	.67	.59	.52	.53	.43
Salem, OR	.52	.48	.45	.47	.56	.71	.73	.76	.70	.62	.60	.51
Pittsburgh, PA	.34	.32	.38	.52	.72	.97	1.09	1.06	.90	.63	.47	.37
Charleston, SC	.65	.63	.68	.83	1.11	1.42	1.67	1.66	1.43	1.02	.75	.66
Nashville, TN	.45	.41	.49	.70	.85	1.13	1.33	1.31	1.19	.77	.55	.53
Amarillo, TX	.28	.26	.30	.39	.55	.80	1.03	1.00	.80	.52	.37	.30
Brownsville, TX	.90	.90	.94	1.12	1.31	1.48	1.57	1.60	1.64	1.31	1.07	.96
Midland, TX	.34	.33	.37	.48	.65	.89	1.06	1.10	.97	.64	.44	.36
El Paso, TX	.29	.28	.30	.33	.44	.67	.98	1.00	.83	.52	.37	.32
Ft. Worth, TX	.48	.51	.58	.80	1.06	1.32	1.48	1.46	1.28	.90	.65	.54
Salt Lake City, UT	.29	.26	.25	.30	.40	.54	.66	.66	.50	.38	.34	.27
Quillayute - Tatoosh Is., WA	.46	.47	.44	.48	.57	.71	.77	.82	.75	.67	.55	.50
Green Bay, WI	.23	.23	.28	.44	.63	.89	1.02	.99	.82	.60	.39	.28
Huntington, WV	.39	.37	.47	.62	.82	1.08	1.25	1.19	1.04	.72	.53	.45
Lander, WY	.18	.17	.18	.24	.33	.47	.54	.53	.40	.29	.23	.18

Source:

George A. Lott, "Precipitable Water Over the United States, Volume 1: Monthly Means", National Oceanic and Atmospheric Administration Technical Report NWS 20, November 1976.

Table 2.6

## Monthly Average Atmospheric Turbidity for U. S. Cities

City	Source	Month											
		J	F	M	A	M	J	J	A	S	O	N	D
Eielson AFB, AL	2	.03	.03	.11	.11	.20	.07	.09	.12	.07	.04	.04	.04
Little Rock, AR	2	.11	.16	.17	.22	.22	.20	.22	.20	.19	.13	.10	.09
Phoenix, AZ	3	.05	.06	.07	.08	.08	.08	.08	.07	.07	.06	.07	.07
Tucson, AZ	1	.05	.05	.06	.07	.07	.07	.07	.07	.07	.06	.06	.07
Edwards AFB, CA	2	.02	.02	.06	.09	.09	.08	.08	.08	.07	.06	.04	.04
Fresno, CA	3	.06	.08	.08	.05	.11	.06	.06	.05	.08	.07	.05	.03
Los Angeles, CA	1	.11	.14	.15	.16	.18	.21	.20	.21	.19	.17	.11	.11
Santa Maria, CA	3	.09	.13	.16	.19	.23	.20	.17	.18	.22	.20	.15	.09
Alamosa, CO	2	.09	.11	.12	.15	.13	.10	.10	.06	.07	.07	.07	.07
Boulder, CO	1	.04	.05	.07	.09	.08	.07	.07	.07	.07	.05	.05	.04
Washington, DC	3	.12	.14	.16	.18	.20	.22	.24	.21	.18	.16	.13	.14
Appalachicola, FL	3	.13	.14	.16	.21	.24	.24	.23	.24	.25	.19	.20	.14
Cape Canaveral, FL	4	.10	.11	.13	.13	.19	.20	.17	.17	.19	.17	.11	.10
Gainesville, FL	4	.08	.08	.10	.14	.14	.17	.21	.21	.22	.13	.08	.06
Miami, FL	4	.11	.14	.15	.20	.21	.21	.21	.20	.18	.17	.14	.12
Tallahassee, FL	4	.09	.11	.11	.14	.18	.22	.25	.22	.20	.10	.07	.07
Dodge City, KA	3	.03	.04	.04	.06	.08	.07	.09	.09	.08	.04	.03	.04
Lake Charles, LA	3	.13	.14	.16	.21	.24	.24	.23	.24	.25	.19	.20	.14
Idaho Falls, ID	1	.03	.04	.06	.07	.07	.07	.06	.06	.06	.05	.04	.03
Chicago, IL	1	.15	.18	.21	.18	.18	.19	.22	.16	.16	.14	.13	.15
Salem, IL	2	.09	.10	.16	.17	.21	.22	.23	.21	.17	.16	.10	.09
Topeka, KS	1	.05	.07	.07	.07	.09	.12	.09	.07	.07	.06	.04	.04
Blue Hill, MA	1	.07	.07	.09	.11	.13	.16	.17	.13	.08	.07	.07	.06
Boston, MA	3	.09	.10	.13	.16	.18	.17	.18	.17	.11	.11	.08	.07
Baltimore, MD	1	.12	.18	.18	.19	.22	.27	.31	.32	.31	.12	.17	.18
College Park, MD	2	.07	.08	.13	.17	.23	.21	.13	.23	.17	.13	.08	.07
Caribou, ME	3	.05	.06	.05	.08	.07	.08	.09	.08	.05	.05	.03	.05
Great Falls, MN	3	.05	.06	.07	.08	.08	.07	.07	.07	.07	.06	.06	.05
St. Cloud, MN	2	.08	.06	.08	.13	.11	.09	.11	.10	.08	.06	.05	.05
Columbia, MO	3	.04	.05	.05	.07	.09	.09	.09	.09	.08	.04	.03	.04
St. Louis, MO	1	.12	.12	.16	.17	.21	.20	.22	.19	.19	.12	.12	.11
Meridian, MS	1	.07	.07	.07	.09	.12	.15	.15	.13	.11	.07	.07	.07
Missoula, MT	1	.06	.07	.07	.08	.09	.07	.07	.06	.09	.08	.07	.07
N. Omaha, NE	3	.04	.05	.05	.07	.09	.09	.09	.09	.08	.04	.03	.04
Cape Hatteras, NC	3	.06	.08	.09	.12	.15	.17	.24	.25	.21	.09	.07	.05
Greensboro, NC	1	.07	.08	.09	.11	.14	.24	.22	.21	.14	.08	.07	.07
Raleigh, NC	3	.07	.08	.10	.13	.15	.25	.23	.23	.17	.10	.09	.07
Bismark, ND	3	.05	.07	.12	.13	.12	.11	.12	.11	.07	.06	.03	.03
Ely, NE	3	.05	.06	.07	.08	.08	.08	.08	.07	.07	.06	.07	.07
Albuquerque, NM	3	.03	.04	.04	.06	.05	.04	.04	.05	.03	.03	.02	.02
Albany, NY	1	.10	.09	.11	.12	.14	.14	.15	.15	.14	.11	.10	.09
Brookhaven, NY	1	.07	.07	.10	.11	.12	.14	.15	.11	.12	.07	.07	.07
New York, NY	3	.10	.10	.14	.15	.17	.18	.22	.20	.16	.14	.10	.08
Cincinnati, OH	1	.07	.09	.12	.13	.14	.20	.20	.19	.17	.12	.10	.08

Table 2.6 (Continued)

Monthly Average Atmospheric Turbidity for U. S. Cities

City	Source	Month											
		J	F	M	A	M	J	J	A	S	O	N	D
Toledo, OH	2	.09	.08	.12	.11	.15	.13	.15	.11	.09	.05	.06	.06
Youngstown, OH	2	.14	.14	.16	.19	.25	.29	.22	.28	.22	.17	.15	.13
Medford, OR	3	.09	.13	.16	.19	.23	.20	.17	.18	.22	.20	.15	.09
Pendleton, OR	2	.10	.12	.16	.20	.19	.19	.16	.15	.11	.09	.09	.09
Philadelphia, PA	1	.12	.15	.18	.20	.22	.25	.27	.23	.17	.15	.14	.14
Charleston, SC	3	.06	.08	.09	.12	.15	.17	.24	.25	.21	.09	.07	.05
Huron, SD	1	.04	.05	.07	.07	.08	.09	.08	.07	.07	.06	.05	.04
Memphis, TN	1	.08	.08	.10	.16	.15	.18	.19	.16	.16	.09	.10	.08
Nashville, TN	3	.09	.11	.13	.15	.17	.20	.19	.17	.15	.13	.11	.09
Oak Ridge, TN	2	.10	.14	.13	.17	.33	.26	.37	.31	.25	.13	.09	.09
Brownsville, TX	3	.05	.06	.07	.08	.08	.08	.08	.07	.07	.06	.07	.07
College Stn., TX	1	.10	.10	.11	.12	.13	.08	.15	.12	.11	.09	.08	.07
El Paso, TX	3	.05	.06	.07	.08	.08	.08	.08	.07	.07	.06	.07	.07
Ft. Worth, TX	3	.04	.08	.09	.12	.12	.13	.13	.19	.14	.08	.04	.04
Grand Prarie, TX	2	.07	.12	.16	.16	.36	.35	.36	.53	.45	.23	.19	.21
Victoria, TX	2	.03	.03	.05	.02	.08	.08	.06	.05	.04	.04	.03	.02
Seattle, WA	3	.09	.13	.16	.19	.23	.20	.17	.18	.22	.20	.15	.09
Green Bay, WI	2	.09	.09	.15	.16	.19	.17	.16	.10	.09	.10	.05	.06
Madison, WI	3	.05	.06	.07	.10	.13	.11	.11	.12	.08	.07	.07	.05
Elkins, WV	1	.07	.07	.09	.14	.15	.21	.21	.19	.14	.07	.07	.07

This table contains values for the Angstrom turbidity coefficient ( $\beta$ ).

Source:

1. E. C. Flowers, R. A. McCormick, and K. R. Kurfis, "Atmospheric Turbidity over the United States, 1961-66", Journal of Applied Meteorology, Vol. 8, No. 6, 1969, pp. 955-962.
2. "Global Monitoring of the Environment for Selected Atmospheric Constituents, 1977", Environmental Data and Information Service, National Climatic Center, Asheville, NC, June 1980.
3. "SOLMET Vol. 2, Hourly Solar Radiation - Surface Meteorological Observations", Final Report TD-9724, National Climatic Center, Asheville, NC, June 1979, as quoted in M. Iqbal, *An Introduction to Solar Radiation*, Academic press, 1983, p.120.
4. Gueymard, C. and McCluney, R.M., "The Average Beam, Global Horizontal and Global Normal Radiation, Sunshine Probability and Turbidity at Cape Canaveral, FL", Proc. Solar 92 - The National Solar Energy Conference, Cocoa Beach, FL, 1992.

Table 2.7			
Recommended MAX-GLARE Values			
Location or Building Type	Maximum Daylight Glare Index	Location or Building Type	Maximum Daylight Glare Index
Art Galleries	16	Laboratories	22
Factories		Museums	20
Rough Work	28	Offices	
Engine Assembly	26	General	22
Fine Assembly	24	Drafting	20
Instrument Assembly	22	School Classrooms	20
Hospital Wards	18		

Note: The values in this table were obtained from the relationship

$$\text{MAX-GLARE} = 2/3 (14 + I_{\text{max}}),$$

where  $I_{\text{max}}$  is the limiting IES (London) glare index for artificial lighting given in R.G. Hopkinson, P. Petherbridge and J. Longmore, *Daylighting*, Heinemann, London, 1966, p.309.

Table 2.8	
Daylight Transmittance of Different Window Shading Devices	
Shading Device	Daylight Transmittance (VIS-TRANS-SCH Value)
Translucent Drapes <sup>1</sup>	
Light (white)	.35
Medium (grey)	.23
Dark (tan)	.14
Translucent Shades <sup>2</sup>	
Glossy white	.18
Flat white	.23

Data Sources:

1. Pennington, C. W., et. al., *Experimental Analysis of Solar Heat Gain Through Insulating Glass with Indoor shading*, ASHRAE Journal, February 1964.
2. Jordan, R. C., and Threlkeld, J. L., "Determination of the Effectiveness of Window Shading Materials on the Reduction of Solar Radiation Heat Gain", ASHRAE Transactions, Volume 65, 1959.

Note: Refer to manufacturer's data for specific products.

## TROMBE WALLS

### TROMBE-WALL-V and TROMBE-WALL-NV

DOE-2 has models for both vented and unvented Trombe walls. The following describes the input needed to use the Trombe wall simulation. The simulation requires the following sets of information:

- A) The size, location, and orientation of the Trombe wall.
- B) The size and type of glazing of the window that covers the Trombe wall. The amount and scheduling of window insulation.
- C) The material description of the wall.
- D) The channel width of the air gap and the emissivity of the wall.
- E) The cross-sectional area of the upper and lower vents and the vertical distance separating the vents (vented Trombe walls only).
- F) The venting schedule (vented Trombe walls only).

Most of the information is handled in a way familiar to DOE-2 users. The command is TROMBE-WALL-V (T-W-V) or TROMBE-WALL-NV (T-W-NV). Trombe walls are synonymous with EXTERIOR-WALLs. Thus, all information (see A above) is entered exactly like the information for an EXTERIOR-WALL command. Specifying TROMBE-WALL-V or TROMBE-WALL-NV tells the program to model a vented or unvented Trombe wall in the given space. The TROMBE-WALL-V or TROMBE-WALL-NV command is immediately followed by a WINDOW command, which contains the information in (B). Note that the use of the keywords SHADING-SCHEDULE and CONDUCT-SCHEDULE allows you to simulate movable insulation being placed over the glass. The material description of the wall (C) is entered in the same way as a regular wall; i.e. through the MATERIAL, LAYERS, and CONSTRUCTION commands.

#### General Rules

1. Only *one* TROMBE-WALL-V or TROMBE-WALL-NV is allowed per SPACE.
2. The wall is denoted a Trombe wall by use of the commands TROMBE-WALL-V or TROMBE-WALL-NV.
3. Each TROMBE-WALL-V or TROMBE-WALL-NV command must be followed by one, and only one, WINDOW command.
4. The window area must equal the Trombe wall area.
5. The CONSTRUCTION command referenced by the TROMBE-WALL-V or TROMBE-WALL-NV command must, in turn, reference a WALL-PARAMETERS command.

#### Warning

There are certain restrictions on the use of Trombe walls in combination with other DOE-2 features. Use of the *vented* Trombe wall should be avoided in combination with systems which use the COOL-CONTROL = WARMEST or HEAT-CONTROL = COLDEST option. In the warmest/coldest calculations, the thermal gains from the vented Trombe wall are not included.

This could cause the hot or cold duct supply temperatures to be incorrectly set, resulting in excess energy consumption, or overheated or undercooled zones. The system types involved are MZS, DDS, SZCI, HVSYS, TPIU, FPIU, VAVS, RHFS, CBVAV, PMZS, and PVAVS. This problem will not occur in these systems if other control methods are used. For similar reasons, the use of Trombe walls in combination with optimum start (see p.3.101, OPTIMUM FAN START OPTION) should be avoided.

### WALL-PARAMETERS

The remaining physical descriptions of the Trombe wall (D and E) are entered with the WALL-PARAMETERS command, which is referenced by the CONSTRUCTION command. The keywords for WALL-PARAMETERS (abbreviated as W-P) are:

WALL-PARAMETERS					
Keyword	Abbrev.	Input	Default	Min.	
FOR	—	Code-word	Note 1		
EMISSIVITY	EM	fraction	0.93	0.0	1.0
CHANNEL-WIDTH	C-W	ft	required	0.0	1.0
LOWER-VENT-AREA	L-V-A	ft <sup>2</sup>	Note 2	0.0	100.0
UPPER-VENT-AREA	U-V-A	ft <sup>2</sup>	Note 2	0.0	100.0
VERT-VENT-SEP	V-V-S	ft	Note 2	0.0	20.0

Note 1: Required; legal values are TROMBE-WALL-V and TROMBE-WALL-NV.  
 Note 2: Required for TROMBE-WALL-V; unused by TROMBE-WALL-NV.  
 Rule: The keyword FOR must be the first keyword entered.  
 It operates just as it does in SET-DEFAULT.

### ZONE

One additional keyword is used (in SDL) to specify a venting schedule, for the vented Trombe wall only. The keyword is in the ZONE command and is TROM-VENT-SCH (T-V-SCH).

#### TROM-VENT-SCH

This keyword allows you to define which hours the Trombe wall is allowed to vent to the occupied space. A schedule value of 1 means venting is allowed. A value of 0 means venting is not allowed. The venting is done by natural convection and *not* by mechanical means, i.e., fans.



**Example:**

We add a Trombe wall (vented) to the Simple Structure, Run 3A, in the *Sample Run Book (2.1E)*.

TWLAY = LAYERS MAT = (CB32) ..

TWCONS = CONSTRUCTION LAYERS = TWLAY  
WALL-PARAMETERS = TWPARS ..

TWPARS = WALL-PARAMETERS FOR TROMBE-WALL-V  
CHANNEL-WIDTH = .3333  
LOWER-VENT-AREA = 15  
UPPER-VENT-AREA = 15  
VERT-VENT-SEP = 7 ..

TROMWGLASS = GLASS-TYPE  
GLASS-TYPE-CODE = 1  
PANES = 2 ..

.  
.  
.

SPACE1-1 = SPACE  
SPACE-CONDITIONS = OFFICE etc. ..

FRONT-1 = TROMBE-WALL-V  
HEIGHT = 8  
WIDTH = 100  
X = 0 Y = 0  
Z = 0 AZ = 180  
CONSTRUCTION = TWCONS ..

WF-1 = WINDOW  
HEIGHT = 8 WIDTH = 100  
GLASS-TYPE = TROMWGLASS ..

.  
.  
.

INPUT SYSTEMS ..

VENT-1 = DAY-SCHEDULE (1,7) (0) (8,18) (1) (19,24) (0) ..  
VENT-2 = DAY-SCHEDULE (1,24) (0) ..

VENT-WEEK = WEEK-SCHEDULE  
(MON,FRI) VENT-1  
(WEH) VENT-2 ..

VENT-SCH = SCHEDULE THRU DEC 31 VENT-WEEK ..

.  
.  
.

SPACE1-1 = ZONE  
ZONE-TYPE = CONDITIONED  
ZONE-CONTROL = CONTROL  
TROM-VENT-SCH = VENT-SCH ..

### Reporting

No new hourly report variables have been added, but some of the existing ones for wall and window can be informative. Variables of interest are Q (E-W(5)), the heat conducted into the space through the wall, and T (E-W(6)), the outside surface temperature of the wall. In the window variables, QTRANS, (WI(13)), the amount of solar passing through the window (and hence the energy available to the Trombe wall), and QCON, (WI(15)), the heat lost back out the window by conduction, are very useful. These variables are of interest only for the unvented Trombe wall. For the vented Trombe wall, all calculations are done in SYSTEMS and no useful hourly report variables are available.

## FIXED SHADES, FINS AND OVERHANGS, SHADE-SCHEDULE, and SELF SHADES

The shading routines, upgraded in DOE-2.1B, will do the following:

- 1) model fixed shades (e.g., neighboring buildings) that do not move when the position or orientation of the building being analyzed is changed;
- 2) model fins and overhangs on windows;
- 3) permit the transmittance of a shading surface to be scheduled, allowing, for example, deciduous trees to be modeled; and
- 4) simplify the input for exterior walls that shade other exterior walls and windows ("self shading").

### Fixed Shades

When the location or orientation of a building is changed, then shading surfaces defined with BUILDING-SHADE (or with the new fin and overhang keywords described below) will move with the building. In order to describe shading surfaces that *do not move* with the building, the FIXED-SHADE command was introduced:

### FIXED-SHADE

This command specifies the position of stationary shading surfaces that remain fixed with respect to the surface of the earth when the building is translated or rotated. The keywords for FIXED-SHADE are the same as those for BUILDING-SHADE except for X, Y and Z, which for FIXED-SHADE are replaced by X-REF and Y-REF.

X-REF  
Y-REF

are the coordinates of the lower left-hand corner of a fixed shade in the *reference coordinate system*, as shown in Fig. 2.15. The reference coordinate system is a coordinate system that is fixed with respect to the surface of the earth. Its y-axis points North and its x-axis points East. The FIXED-SHADE keyword, AZIMUTH, gives the angle between the y-axis of the reference coordinate system and the outward normal of the fixed shade. The reference coordinate system is used only when fixed shades are present. Then it is also necessary to position the building in the reference coordinate system in order to obtain the proper geometrical relationship between the fixed shade(s) and the building. This is done by assigning values to the X-REF and Y-REF keywords of the BUILDING-LOCATION command.

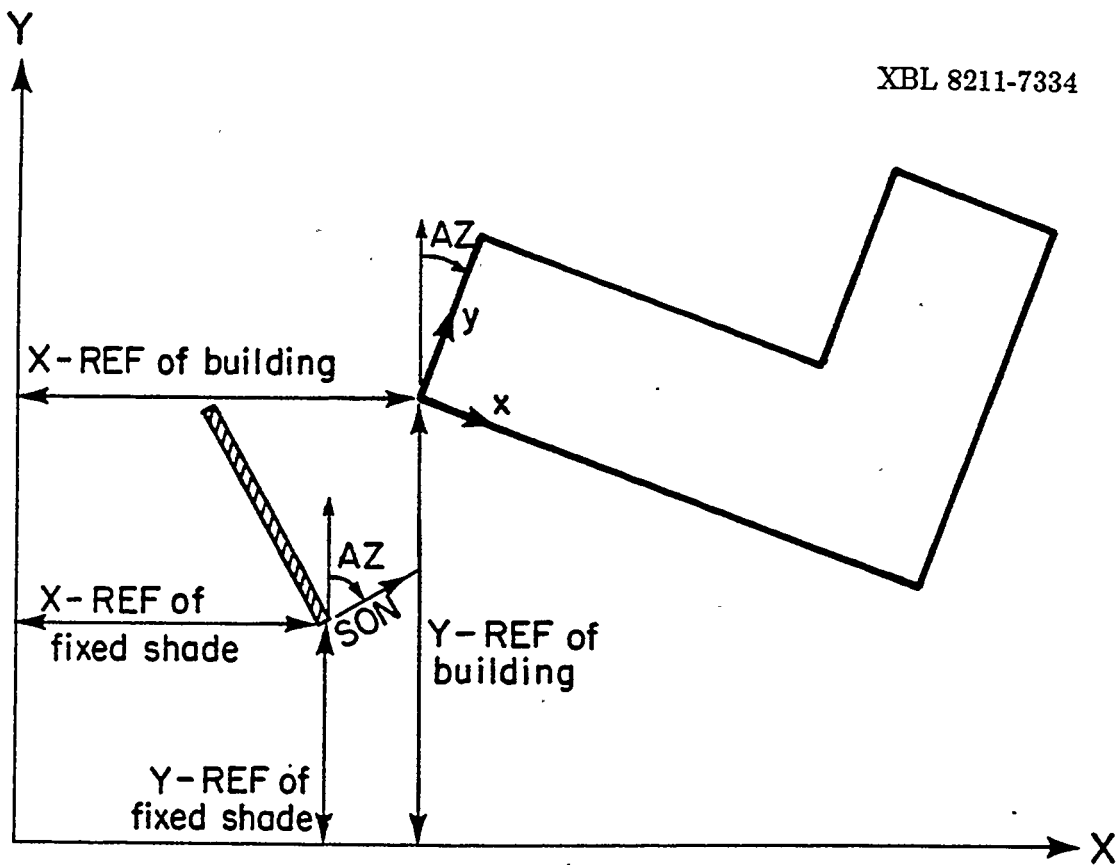

Figure 2.15 Reference Coordinate System. X-REF and Y-REF are the coordinates of the lower left-hand corner of a fixed shade.

## BUILDING-LOCATION

X-REF  
Y-REF

are the coordinates of the origin of the building coordinate system in the reference coordinate system. As before, the BUILDING-LOCATION keyword AZIMUTH is the angle between North and the y-axis of the building coordinate system. Since the y-axis of the reference coordinate system points North, AZIMUTH is also the angle between the y-axis of the reference coordinate system and y-axis of the building coordinate system.

Figure 2.16 shows an example in which a fixed shade and an L-shaped building have been positioned in the reference coordinate system using X-REF, Y-REF, and AZIMUTH for the fixed shade and X-REF, Y-REF, and AZIMUTH for the building. This figure also shows the building being translated and rotated (dashed lines) in the reference coordinate system by changing the building's X-REF, Y-REF, and AZIMUTH values. This moves the building but not the fixed shade.

XBL 8211-7334(a)

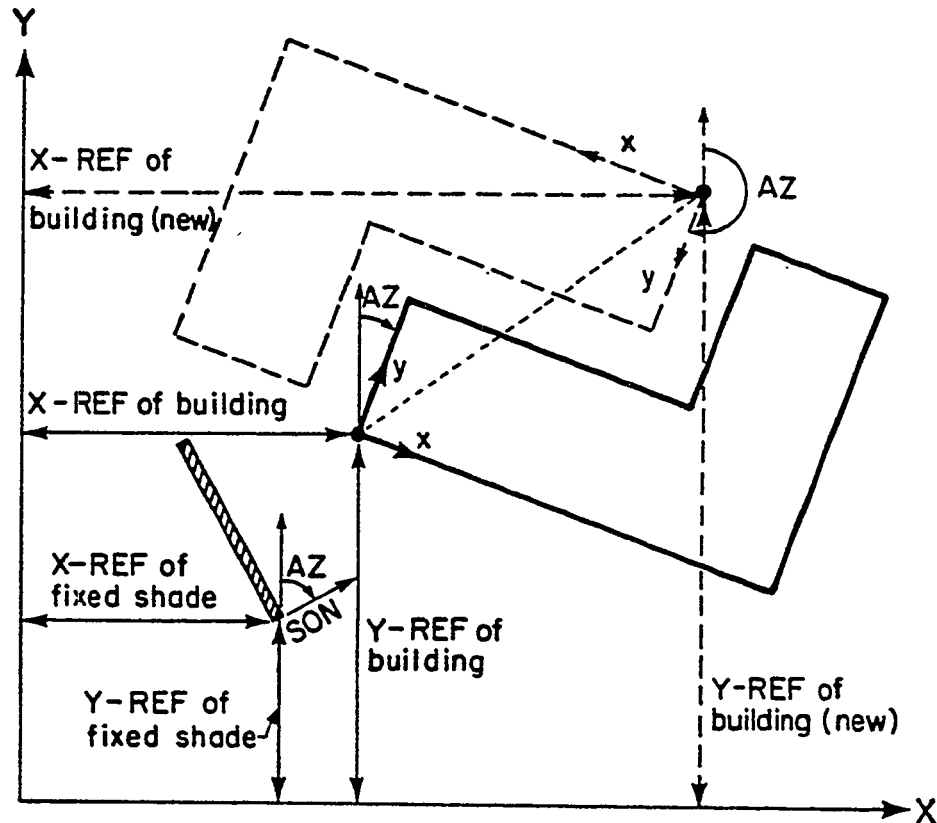

Figure 2.16 Reference coordinate system showing fixed shade and building. When the building is moved (dashed line), the fixed shade remains stationary.

## Overhangs and Fins

Note that even though overhangs and/or fins are specified under the WINDOW or DOOR command, these shading surfaces are attached to the wall where the window or door is located. These attached shades are used in shading calculations for this wall and for all of the windows and doors on this wall. Also, if this WINDOW or DOOR is referred to in another WINDOW or DOOR command with the LIKE keyword, the attached shades are also copied.

### WINDOW or DOOR

OVERHANG-A	Units are feet, 0.0 is the default; there are no limits. See Fig. 2.17.
OVERHANG-B	Units are feet, 0.0 is the default; there are no limits. See Fig. 2.17.
OVERHANG-W	Units are feet, 0.0 is the default; the range is 0.0 to no limits. See Fig. 2.17.
OVERHANG-D	Units are feet, 0.0 is the default; the range is 0.0 to no limits. See Fig. 2.17.
OVERHANG-ANGLE	is the angle between the overhang and the window. When set at $90^\circ$ , the overhang is perpendicular to the window (the default); if $< 90^\circ$ it is tilted down; if $> 90^\circ$ it is tilted up. The range is 0 to $180^\circ$ .

Note: For overhang shading calculations to be performed, both OVERHANG-W and OVERHANG-D must be specified. If one of them is specified but not both, a WARNING message is printed and overhang shading is not performed.

LEFT-FIN-A	Units are feet; 0.0 is the default; there are no limits. See Fig. 2.17.
LEFT-FIN-B	Units are feet; 0.0 is the default; there are no limits. See Fig. 2.17.
LEFT-FIN-H	Units are feet; 0.0 is the default; the range is 0.0 to no limits. See Fig. 2.17.
LEFT-FIN-D	Units are feet; 0.0 is the default; the range is 0.0 to no limits. See Fig. 2.17.
RIGHT-FIN-A	Units are feet; 0.0 is the default; there are no limits. See Fig. 2.17.
RIGHT-FIN-B	Units are feet; 0.0 is the default; there are no limits. See Fig. 2.17.
RIGHT-FIN-H	Units are feet; 0.0 is the default; the range is 0.0 to no limits. See Fig. 2.17.

RIGHT-FIN-D

Units are feet; 0.0 is the default; the range is 0.0 to no limits.  
See Fig. 2.17

Note: For fin shading calculations to be performed, both of the pair (-FIN-H and -FIN-D) must be specified. If only one of the pair is specified, a WARNING message is printed and fin shading is not performed.

Note: Overhangs and fins are assumed by the program to be opaque. Non-opaque shades can be specified with the BUILDING-SHADE and FIXED-SHADE commands.

XBL 8210-4858

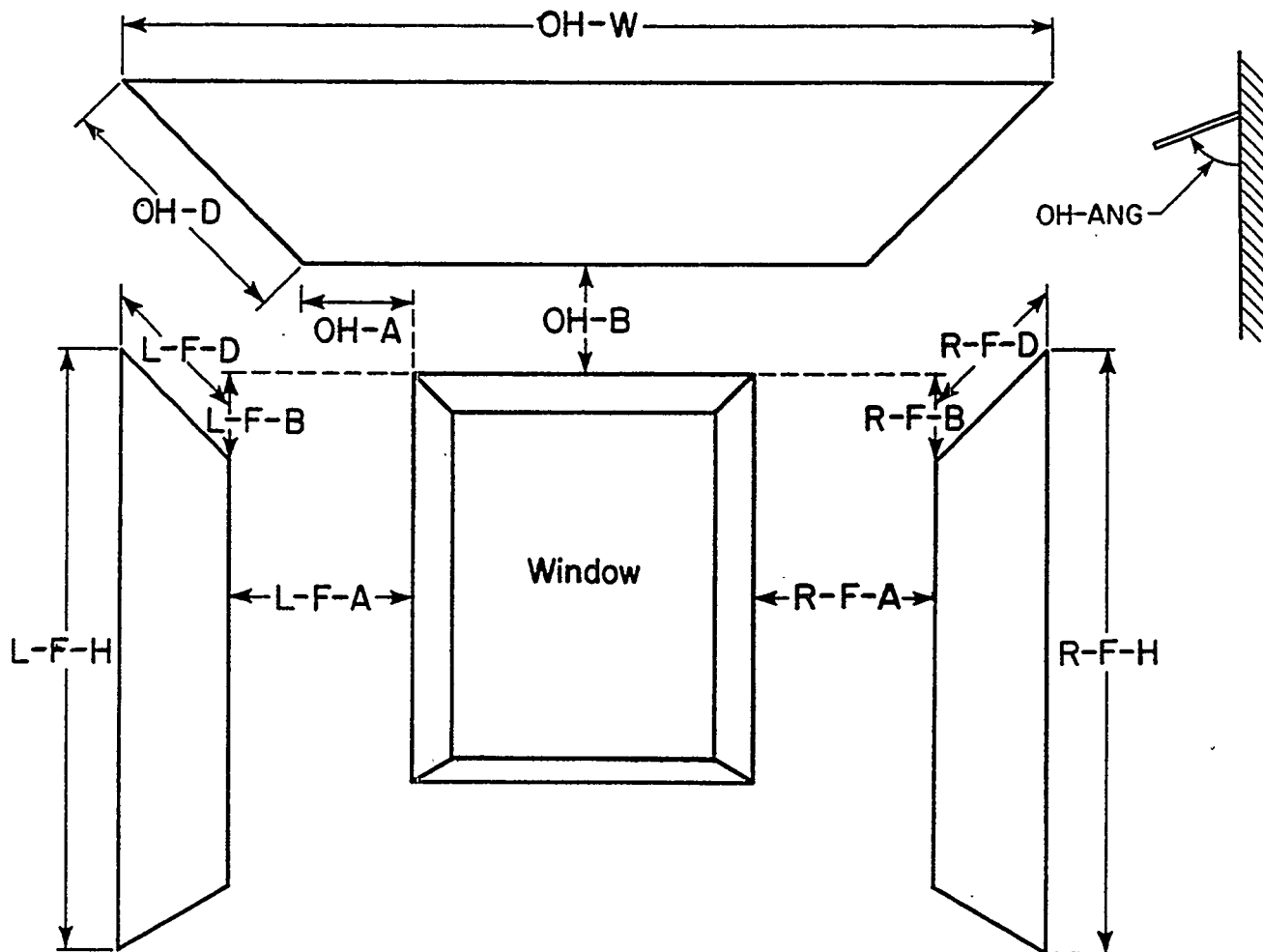

Figure 2.17

Positioning of overhang and fins with respect to a window. The values in this figure are all positive. If the value for  $L-F-B$  is input as negative, then the left fin will originate at a point above the top edge of the window, and similarly for  $R-F-B$ .

### Shade Schedule

A keyword was added in DOE-2.1B to the **FIXED-SHADE** and the **BUILDING-SHADE** commands. Some things to keep in mind are these:

1. DOE-2 calculates direct solar shading factors for sun positions on the first day of each month, so only the **SHADE-SCHEDULE** values on those particular days are used.
2. DOE-2 calculates diffuse solar shading factors only once (before the hourly loads calculation); this means that **SHADE-SCHEDULE** has no effect on diffuse shading; instead, the **TRANSMITTANCE** value is used. See **AUTOMATIC CALCULATION OF THE SHADING OF DIFFUSE SOLAR RADIATION**, p.2.80.

### FIXED-SHADE or BUILDING-SHADE

#### SHADE-SCHEDULE

is the u-name of a schedule that gives the time-dependent transmittance value of the shading device for direct (beam) solar radiation. This keyword can be used to simulate movable exterior devices. The values in the schedule override the **TRANSMITTANCE** keyword value. The range of the schedule values is 0.0 to 1.0. A value of 0.0 represents an opaque device and a value greater than 0.0 represents a device that passes some solar radiation, such as a tree, lattice, or fabric.

### Self Shading

A keyword was added in DOE-2.1B to the **EXTERIOR-WALL** command:

### EXTERIOR-WALL

#### SHADING-SURFACE

takes a code-word value of YES or NO (NO is the default). YES causes this **EXTERIOR-WALL** surface to be considered also as a **BUILDING-SHADE** surface with **TRANSMITTANCE=0**. Whenever an exterior wall is capable of shading another exterior surface (for example, in an L-shaped building), setting **SHADING-SURFACE=YES** greatly simplifies shading surface input.



# AUTOMATIC CALCULATION OF THE SHADING OF DIFFUSE SOLAR RADIATION

## Introduction

DOE-2 has always automatically calculated shading of *direct* solar radiation by overhangs and other obstructions. On the other hand, shading of *diffuse* solar radiation by the same obstructions was not automatically calculated; instead, you were required to estimate the effects of diffuse shading by entering values for SKY-FORM-FACTOR and GND-FORM-FACTOR for each exterior wall, window, and door that was shaded. Because these form factors are difficult to estimate, users rarely specified them, resulting in no diffuse shading even though building shades had been input. However, diffuse radiation can be a large contributor to overall solar gain. For example, the annual solar gain for an unshaded rectangular building in Chicago with the same amount of vertical glazing on north, south, east, and west facades is roughly 50% direct and 50% diffuse. To relieve you of having to guess form factors, routines have been added to DOE-2.1D that automatically calculate the shading of diffuse radiation by obstructions defined by BUILDING-SHADE, FIXED-SHADE, SETBACK, SHADING-SURFACE, etc. The diffuse solar shading factors are calculated in a preprocessor for use in the hourly loop. In this calculation, it is assumed that the radiance of the sky and ground is uniform.

## Notes:

- (1) Overhangs and fins (input using OVERHANG-A, LEFT-FIN-A, etc. in the WINDOW and DOOR commands) are assumed by DOE-2 to be opaque. For non-opaque (partially transmitting) shades, use BUILDING-SHADE or FIXED-SHADE and specify TRANSMITTANCE (default = 0).
- (2) SHADE-SCHEDULE can be specified for BUILDING-SHADE and FIXED-SHADE to model shades whose transmittance varies with time (see "Shade Schedule", p.2.79). However, SHADE-SCHEDULE varies the shade transmittance for *direct* solar only. It has *no* effect on diffuse radiation because the diffuse solar shading factors are calculated in DOE-2 before the hourly loop. Therefore, to model the diffuse solar shading effects of objects like deciduous trees, whose transmittance varies from summer to winter, it is recommended that SHADE-SCHEDULE not be used, but rather that separate winter and summer runs be made with different values for TRANSMITTANCE. The results of the two runs can then be added by hand to get the annual energy performance. If this approach is used, it is recommended that design days be used for system sizing or that capacities be entered by hand.
- (3) Obstructions are assumed to have zero reflectance for both direct and diffuse radiation; the effects of solar radiation bouncing off obstructions onto a window or wall are not considered.
- (4) You have the option of overriding the automatic diffuse shading calculation for a particular exterior wall, window, or door by specifying SKY-FORM-FACTOR and GND-FORM-FACTOR for that surface, as in previous versions of DOE-2 (see the descriptions of these keywords on p.III.100 of the *Reference Manual (2.1A)*).

## DISTRIBUTION OF HEAT FROM LIGHTS

### Introduction

The heat from the lights in a space can be considered to be deposited in three places:

- in the space itself,
- in an adjoining unconditioned space on the other side of the fixture,
- in the return air stream.

This distribution of light heat is determined by the keywords LIGHT-TO-SPACE, LIGHT-TO-OTHER, and LIGHT-TO-RETURN under the SPACE-CONDITIONS command. The heat transfer to the space and/or to the adjoining space is considered to be partially radiative and partially convective. This split is determined by the keyword LIGHT-RAD-FRAC and is only applicable if Automatic Custom Weighting Factors have been specified (FLOOR-WEIGHT = 0). The convective portion is treated as an instantaneous load, whereas the radiative portion is assumed to be absorbed by the mass in the space and released in time according to the lighting weighting factors.

### SPACE-CONDITIONS

- LIGHT-TO-SPACE is the fraction of the light heat in a given hour that is to be treated as heat gain in the space.
- LIGHT-TO-OTHER is the fraction of light heat in a given hour that is deposited in an adjacent space. Unless the light fixture is in contact with an adjacent space or unless the "interior wall" between this space and the adjacent space is translucent or transparent, LIGHT-TO-OTHER should be zero.
- LIGHT-TO-RETURN is the fraction of light heat in a given hour that goes directly into the return air stream. Unless the return air passes through the light fixtures, LIGHT-TO-RETURN should be zero.

The sum of LIGHT-TO-SPACE + LIGHT-TO-OTHER + LIGHT-TO-RETURN must be 1.0 and the program will increase LIGHT-TO-RETURN to ensure this total, if the sum is less than 1.0. If the sum is greater than 1.0, an ERROR message will be issued. When it is appropriate to have a non-zero value for LIGHT-TO-OTHER, its value should be chosen in the following way: assume that the return air path is through a duct and estimate the values of LIGHT-TO-SPACE and LIGHT-TO-RETURN under conditions of maximum air flow; now set  $\text{LIGHT-TO-OTHER} = 1.0 - (\text{LIGHT-TO-SPACE}) - (\text{LIGHT-TO-RETURN})$ .

This procedure is valid even if you intends to simulate return air plenums in SYSTEMS.

- LIGHT-HEAT-TO takes the u-name of an unconditioned or plenum space as a value and indicates the space that is the recipient of the fraction of light heat specified as LIGHT-TO-OTHER. This is a required keyword if LIGHT-TO-OTHER > 0. Only unconditioned or plenum spaces may be the recipients of such heat from lights.

**LIGHT-RAD-FRAC**

takes a list of two fractions: the first is the fraction of the light heat to a space that is radiative, the second is the fraction of light heat to an adjacent space that is radiative. The second fraction, although required if this keyword is used, is not used if **LIGHT-TO-OTHER** = 0. This keyword only applies if Automatic Custom Weighting Factors are requested by specifying **FLOOR-WEIGHT** = 0.

The **LIGHTING-TYPE** keyword has the effect of determining defaults for the keywords **LIGHT-TO-SPACE**, **LIGHT-TO-RETURN**, and **LIGHT-RAD-FRAC**, described above. If you define these keywords explicitly, **LIGHTING-TYPE** may be allowed to default. In particular, if there is a mixture of types of lighting within a space, you should select appropriate values for **LIGHT-TO-SPACE**, **LIGHT-TO-OTHER**, **LIGHT-TO-RETURN**, and **LIGHT-RAD-FRAC** corresponding to a weighted average for the lighting types present.

Default Values For Lighting Types					
	SUS- FLUOR	REC- FLUOR-RV	REC- FLUOR-RSV	INCAND	REC- FLUOR-NV
LIGHT-TO-SPACE	1.0	0.8	0.8	1.0	1.0
LIGHT-TO-OTHER	0.0	0.0	0.0	0.0	0.0
LIGHT-TO-RETURN	Defaults to 1.0 minus LIGHT-TO-SPACE minus LIGHT-TO-OTHER.				
LIGHT-RAD-FRAC:					
in this space	0.67	0.59	0.19	0.71	0.67
in other space	1.0	0.09	0.09	1.0	0.09

Depending upon the type of system being modeled in **SYSTEMS**, or upon the choice for **RETURN-AIR-PATH** in the **SYSTEM** command, the light heat that you have assigned to the return air path through the use of the keyword **LIGHT-TO-RETURN** (referred to here as **QRETURN**) will be treated as follows. If the HVAC system is zonal (that is, if **SYSTEM-TYPE** in the **SYSTEM** command is **UHT**, **UVT**, **HP**, **TPFC**, **FPFC**, **TPIU**, **FPIU**, **PTAC**, or **PVVT**) or **RETURN-AIR-PATH** = **DIRECT**, **QRETURN** will be added to the zone load in **SYSTEMS**. If plenum zones are defined in **SYSTEMS**, then the return air path, along with **QRETURN**, is assumed to pass through the plenum zones. If there is a variable volume fan, then the light heat to the return air is proportional to the airflow rate to the zone, with the residue of **QRETURN** being added to the zone load.

As an example of these lighting keywords, consider the situation shown in Fig. 2.18. A 2500 ft<sup>2</sup> conditioned zone **SPACE-1** is illuminated to an intensity of 2 watts/ft<sup>2</sup> with recessed fluorescent light fixtures, designed so that the return air passes through the fixture into a return air duct. It is estimated that at design air flow, 30% of the heat given off from the fixture goes directly into the return air stream and 45% remains in the space. The remaining 25% is dissipated from the back of the fixture into the unconditioned space **PLEN-1**. Measurements indicate that 75% of the heat that goes into **SPACE-1** is radiative (the other 25% is convective), while only 5% of the heat into **PLEN-1** is radiative.

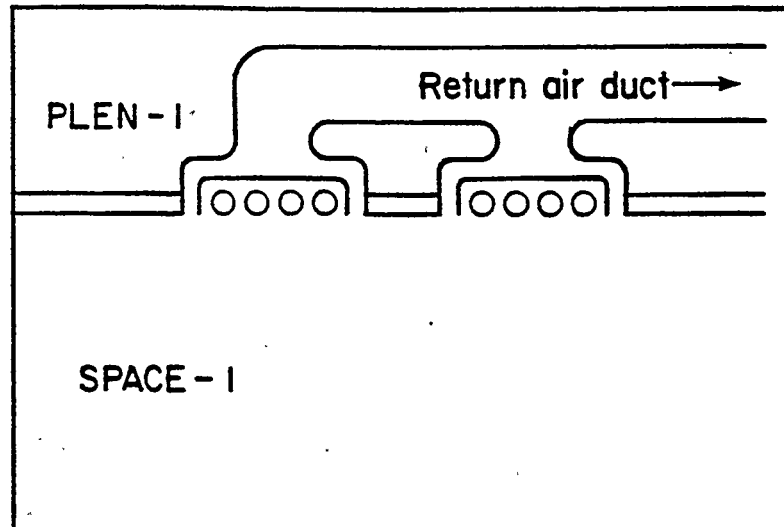

**Figure 2.18:** A 2500 ft<sup>2</sup> conditioned zone SPACE-1 is illuminated to an intensity of 2 watts/ft<sup>2</sup> with recessed fluorescent light fixtures, designed so that the return air passes through the fixture into a return air duct.

The DOE-2 input for this situation is:

```
SPACE-1 = SPACE
AREA = 2500
LIGHTING-W/SQFT = 2.0
LIGHT-TO-SPACE = .45
LIGHT-TO-OTHER = .25
LIGHT-HEAT-TO = PLEN-1
LIGHT-RAD-FRAC = (.75, .05)
.
.
. ..
```

Note that no value for LIGHT-TO-RETURN has been entered. It could have been entered as .30, but the program will adjust its default value of 0.2 to ensure that the sum of the three fractions is 1.0.

In SYSTEMS the keyword RETURN-AIR-PATH will be given the value DUCT. Suppose that the system being simulated is a constant volume system. In that case, the heat added to the return air will be a constant 1.5 kW (30% of 2500 ft<sup>2</sup> times 2 watts/ft<sup>2</sup>). If the system were a variable air volume system with a minimum cfm ratio of 0.4, then at the minimum air flow the light heat going into the return air would be 0.6 kW (0.4 times 1.5 kW). The 0.9 kW difference between 1.5 kW and 0.6 kW would be added to the zone load. The meanings of the code-words applicable to RETURN-AIR-PATH have been revised as follows:

## SYSTEM

### RETURN-AIR-PATH

#### *DIRECT*

This code-word is used when the return air flows back to the air-handler or relief point (central exhaust) via the zones, hallways or stairwells. Any heat from lights that was specified in LOADS to go to the return air through the LIGHT-TO-RETURN keyword will be added to the zone load.

#### *DUCT*

Use of this code-word causes a fraction of the heat from lights, specified through the LIGHT-TO-RETURN keyword in LOADS, to be added to the return air stream. If there is a variable air volume system, the fraction is the ratio of the cfm to the zone that hour to the maximum design cfm to the zone.

This code-word should be used in two cases:

- (1) when return air duct work actually exists in the building, and
- (2) when the return air passes through a plenum and the plenum is essentially at the same temperature as the zone it serves.

The second case allows a great simplification of input for high-rise office buildings where there are plenum zones in the intermediate floors. You specify the conditioned spaces large enough to include the plenum areas and does not input a plenum at all. The heat from lights that goes to the plenum is specified through the LIGHT-TO-RETURN keyword (*not* the LIGHT-TO-OTHER keyword). In the first case, if the return air ducts are located in an unconditioned zone, that zone should be identified in SYSTEMS as ZONE-TYPE = UNCONDITIONED.

#### *PLENUM-ZONES*

This code-word is used when the return air path is through plenums and the heat exchange between the return air and the plenum wall mass is important. Heat from lights can be added in two ways: directly through the LIGHT-TO-OTHER keyword in LOADS and through the LIGHT-TO-RETURN. The former assignment will allow some of the light heat to be stored in the plenum wall mass, while the latter will show up as an instantaneous cooling load in the return air. This keyword must be chosen if there are zones in this system, defined as ZONE-TYPE = PLENUM and listed under the SYSTEM command in the PLENUM-NAMES keyword.

---

In the left column above, bold-faced words are commands, non-bold words are keywords, and italicized words are code-words.

Because of these improvements in the calculation of the distribution of heat from lights, it is necessary that you be more specific in the definition of ZONE-TYPES in the SPACE-CONDITIONS command. Also, be sure that the ZONE-TYPES in the SYSTEMS ZONE command are in *perfect* agreement with those specified in LOADS. There are two major reasons for this.

- 1) First, the program sorts the spaces by ZONE-TYPE to assure that the heat of lights is first calculated for CONDITIONED spaces prior to calculating PLENUMs and UNCONDITIONED spaces and any light heat going into the latter types of spaces.
- 2) The second reason is to insure that the spaces specified in the SYSTEMS input as UNCONDITIONED are not included in the building coincident peak loads calculation. An inconsistency between LDL and SDL can result in a calculated SUPPLY-CFM greater than the sum of the zone CFMs.

Associated with this treatment of heat from lights are changes in certain hourly report variables. In LOADS, for VARIABLE-TYPE = u-name of SPACE, VARIABLE-LIST numbers 15 and 34 have the following meanings:

15	QPLENUM	Light heat gain to return air
34	ZLTOTH	Light heat gain to other space

In SYSTEMS, for VARIABLE-TYPE = u-name of ZONE, the meaning of VARIABLE-LIST number 4, <QP>, is "Light heat to return air — from LOADS (Btu/hr)".

For VARIABLE-TYPE = u-name of SYSTEM, the description of VARIABLE-LIST number 16, QPSUM, has been changed to "Total system light heat to return (Btu/hr)".

See Appendix A, "Hourly Report Variable List".

## THE SHERMAN-GRIMSRUD INFILTRATION METHOD

An additional method of computing residential air infiltration was added to DOE-2.1B using a model developed by Sherman and Grimsrud.\* It is applicable only to single zone residential simulation (system type RESYS). This method is specified by setting INF-METHOD = S-G in the SPACE-CONDITIONS command. The following keywords under SPACE-CONDITIONS and BUILDING-LOCATION should also be specified:

### SPACE-CONDITIONS

#### HOR-LEAK-FRAC

To compute the stack effect term in the S-G infiltration method, the leakage area and the leakage distribution are needed. HOR-LEAK-FRAC is the fraction of the leakage that is in the floor and ceiling. A value of 0.3 is appropriate if there are few ceiling penetrations. Otherwise, the default of 0.4 may be used.

#### NEUTRAL-LEVEL

is the dimensionless height of the neutral level for the S-G infiltration method. That is, it is the fraction of the height of the space at which the indoor-outdoor pressure is zero. In general, this keyword can be allowed to default (to 0.5).

#### FRAC-LEAK-AREA

is the total leakage area expressed as a fraction of the floor area used in the S-G infiltration method. This number can be obtained from a pressurization measurement. Otherwise, values may be selected from Table 2.9. The default is 0.0005.

Type of construction	FRAC-LEAK-AREA
Tight	0.0003
Average	0.0005
Loose	0.0010

### BUILDING-LOCATION

#### SHIELDING-COEF

is the shielding coefficient in the Sherman-Grimsrud infiltration method. This coefficient modifies the wind speed term in the model to account for changes in the wind pressure caused by local obstructions. A value should be selected from Table 2.10 (default = 0.24, moderate local shielding). The wind speed is also modified for terrain and space height effects using the

\* See report LBL-10852, M.H. Sherman and D.T. Grimsrud, *Measurement of Infiltration Using Fan Pressurization and Weather Data*, October 1980.

BUILDING-LOCATION keywords TERRAIN-PAR1,  
 TERRAIN-PAR2, WS-TERRAIN-PAR1, and  
 WS-TERRAIN-PAR2, and the SPACE height keyword, Z (see  
 "Terrain and Height Modification to Wind Speed", p.2.88).

<b>Table 2.10</b>	
<b>Shielding Coefficient Values</b>	
SHIELDING-COEF	Description
0.32	No obstructions or local shielding whatsoever, e.g., desert.
0.29	Light local shielding with few obstructions, perhaps a few trees or a small shed.
0.24	Moderate local shielding, some obstructions within two house heights, a thick hedge or a solid fence, or one neighboring house.
0.19	Heavy shielding, obstructions around most of perimeter, buildings or trees within 30 feet in most directions, typical suburban shielding.
0.10	Very heavy shielding, large obstructions surrounding perimeter within two house heights, typical downtown shielding.

Associated with the infiltration method are three variables appearing in the LV-C report. Under INFILTRATION, (if INF-METHOD=S-G), these are:

1. FRAC.OF LEAKAGE AREA
2. S-G NEUTRAL LEVEL
3. HOR-LEAK AREA/FLOOR AREA



## TERRAIN AND HEIGHT MODIFICATION TO WIND SPEED

The wind speed used to calculate outside air film conductance and wind-speed-dependent infiltration is now the weather file windspeed *with corrections for terrain effects, weather station height above ground level, and SPACE height above ground level*. This correction generally gives wind speeds at the building that are lower than those at the weather station. This results in lower outside air film conductance and lower infiltration rates, both of which tend to decrease heating loads and increase cooling loads. In DOE-2.1D and earlier versions, this wind speed correction was applied only to the Sherman-Grimsrud infiltration method.

The relationship between site wind speed,  $v_{\text{site}}$ , and weather station wind speed,  $v_{\text{weather-file}}$ , is

The wind speed that is used is the free-stream wind speed,  $v_{\text{site}}$ , at the building site at the height of the space. It is given by:

$$v_{\text{site}} = v_{\text{weather-file}} \frac{[\text{TERRAIN-PAR1}] \left( \frac{\text{space height}}{33.0 \text{ ft}} \right)^{\text{TERRAIN-PAR2}}}{[\text{WS-TERRAIN-PAR1}] \left( \frac{\text{WS-HEIGHT}}{33.0 \text{ ft}} \right)^{\text{WS-TERRAIN-PAR2}}}$$

where "space height" is the height of the top of the space above ground level (determined from the SPACE keywords Z, VOLUME and AREA). The other parameters in this expression are the following keywords in the BUILDING-LOCATION command:

### BUILDING-LOCATION

- TERRAIN-PAR1** is a constant used to modify the free stream wind speed to account for ground roughness and height above ground level at the building site. Select a value from Table 2.11.
- TERRAIN-PAR2** is a constant used to modify the free stream wind speed to account for ground roughness and height above ground level at the building site. Select a value from Table 2.11.
- WS-TERRAIN-PAR1** is a constant corresponding to TERRAIN-PAR1, but for the location of the wind speed measurement; i.e., the weather station. Select a value from Table 2.11.
- WS-TERRAIN-PAR2** is a constant corresponding to TERRAIN-PAR2, but for the location of the wind speed measurement; i.e., the weather station. Select a value from Table 2.11.
- WS-HEIGHT** is the height (in feet) above ground level at which the wind speed measurement was made.

For most weather stations, this information can be obtained from *Local Climatological Data — Annual Summaries for 1981*, published by: The National Climatic Data Center, Federal Building, Asheville, NC 28801.

The site wind speed is a new LOADS hourly report variable: VARIABLE-TYPE = u-name of SPACE, variable list #58. The weather file wind speed is LOADS hourly report VARIABLE-TYPE = GLOBAL, variable list #17.

If the weather station is at the building site, be sure to set TERRAIN-PAR1 = WS-TERRAIN-PAR1 and TERRAIN-PAR2 = WS-TERRAIN-PAR2.

TERRAIN-PAR1 WS-TERRAIN-PAR1	TERRAIN-PAR2 WS-TERRAIN-PAR2	Description
1.30	0.10	Ocean or other body of water with at least 5 km of unrestricted expanse.
1.00	0.15	Flat terrain with some isolated obstacles, e.g., buildings or trees well separated from each other.
0.85	0.20	Rural area with low buildings, trees, etc.
0.67	0.25	Urban, industrial, or forest area.
0.47	0.35	Center of big city, e.g., Manhattan

## FLOOR MULTIPLIERS AND INTERIOR WALL TYPES

With the addition of Automatic Custom Weighting Factors and Daylighting, the requirement to input all of the interior surfaces of a space becomes mandatory. Thus a long-standing problem with space multipliers (see the *Reference Manual (2.1A)*, Section III.B.14 for discussion) has been addressed by the addition of keywords to the SPACE command as discussed below.

### SPACE

#### MULTIPLIER

may be used to specify the total number of *identical* spaces. Use of this keyword reduces the amount of required data entry, but does not actually create other spaces. The program will calculate the loads for the space defined and multiply these loads by MULTIPLIER. If a STANDARD or AIR type INTERIOR-WALL (see discussion immediately following) is defined within the space, the heat transfer to the NEXT-TO space is multiplied by MULTIPLIER. In effect, the area of the INTERIOR-WALL, as seen from the NEXT-TO space, is larger than that entered by a factor of MULTIPLIER. You must enter a wall AREA for INTERIOR-WALLs corresponding to that in the space being multiplied.

Because it creates an ambiguity with regard to the area of the interior wall between them, it is always an ERROR for MULTIPLIER to be different from 1.0 in both of two adjacent spaces connected by STANDARD or AIR type INTERIOR-WALLs.

#### FLOOR-MULTIPLIER

may also be used, like MULTIPLIER, to multiply the loads from one of a number of essentially identical spaces. Unlike MULTIPLIER, there is no multiplication of heat transfer through INTERIOR-WALLs. The major function of FLOOR-MULTIPLIER (abbreviated as F-M) is to simplify the input for a multi-storied building where a number of the floors are thermodynamically identical and where there is negligible heat transfer from floor-to-floor. The default is 1.0 and the range is from 1.0 to 200.0.

The MULTIPLIER or FLOOR-MULTIPLIER keywords in the SPACE command should be used only when the several spaces being modeled in this fashion are equivalent with respect to thermodynamics and/or daylighting. Exterior shading, for example, must be the same for each of the spaces included. When there are adjacent spaces that are presumably identical, there should not be heat transfer between the spaces and it might be supposed that the wall could be ignored. When precalculated weighting factors are used and daylighting is not important, this solution is satisfactory. However, if Custom Weighting Factors are to be calculated or daylighting is being invoked, the wall must be described. The common wall must be described as INT-WALL-TYPE = ADIABATIC.

In the INTERIOR-WALL command, the MULTIPLIER keyword has been removed and the following keyword added:

## INTERIOR-WALL

### **INT-WALL-TYPE**

indicates the type of interior wall. It can take the following code-word values:

#### *STANDARD*

designates a physical interior wall that separates two spaces and is capable of transmitting heat between the spaces. STANDARD is the default. Such a wall typically has non-zero values for both INSIDE-VIS-REFL and SOLAR-FRACTION. It may be defined with LAYERS-type CONSTRUCTION or with U-VALUE-type CONSTRUCTION. In either case its overall U-value must be less than  $UCRIT = 0.709 \text{ Btu/ft}^2\text{-}^\circ\text{F-hr}$ , since that is the value for a wall of R-value  $.05 \text{ ft}^2\text{-}^\circ\text{F-hr/Btu}$  with an inside film resistance on both sides. If you input a U-value for a STANDARD wall that is greater than UCRIT, the INT-WALL-TYPE is changed to AIR. The NEXT-TO keyword is required for this wall type. If the NEXT-TO space is the same as the space under which the interior wall is defined, the value of INT-WALL-TYPE will be changed to ADIABATIC. A STANDARD wall will contribute to the overall conductance of the zone.

#### *AIR*

specifies an artifice intended to approximate the convective coupling between two spaces that are separated by an imaginary wall (such as the opening between perimeter zone and core zone in an open landscape floor layout). It must be defined with a U-VALUE-type CONSTRUCTION. A typical U-value to use is  $2.0 \text{ Btu/hr-ft}^2\text{-F}$ . If the U-value is less than UCRIT, a CAUTION message is printed stating that the U-value is low for air.

The NEXT-TO keyword is required for AIR type walls. If the NEXT-TO space is the same as the space under which the interior wall is defined, the value of INT-WALL-TYPE will be changed to ADIABATIC. An AIR wall contributes to the overall conductance of a zone, but not to the Custom Weighting Factors.

If the AIR wall is part of a daylit space, its INSIDE-VIS-REFL values need to be specified (even though it is not a physical wall) since daylight can be reflected back across the AIR wall from the adjacent space. If an AIR wall of area A (defined in space 1) separates spaces 1 and 2 with inside surface area,  $S_i$  (excluding the AIR wall) and average reflectance,  $\rho_i$  (excluding the AIR wall), then

---

In the left column above, bold-faced words are commands, non-bold words are keywords, and italicized words are code-words.

*INSIDE-VIS-REFL* = (*R*<sub>2</sub>, *R*<sub>1</sub>) ,

where *R*<sub>*i*</sub> is the cavity reflectance of space *i*, given by

$$R_i = \frac{A \rho_i}{S_i - (S_i - A) \rho_i} .$$

For example, if *A*=200 ft<sup>2</sup>, *S*<sub>1</sub>=1500 ft<sup>2</sup>, *S*<sub>2</sub>=2000 ft<sup>2</sup>, and  $\rho_1 = \rho_2 = 0.5$ ,

*R*<sub>1</sub> = 0.12    and    *R*<sub>2</sub> = 0.09

This gives

*INSIDE-VIS-REFL* = (.09,.12).

If the AIR wall was defined in space 2,

*INSIDE-VIS-REFL* = (.12,.09)

## ADIABATIC

ADIABATIC interior walls have been introduced to allow you to model daylighting and/or to calculate Custom Weighting Factors for similar spaces using the MULTIPLIER keyword in the SPACE command. Such walls may have reflective and absorptive properties, as well as the ability to store heat. They will not, however, allow heat to be transferred between spaces (and thus the name). The NEXT-TO keyword is not used for this type wall. Since such walls will not contribute to Custom Weighting Factors unless they have mass, a WARNING message will be issued if a U-VALUE-type CONSTRUCTION is used.

Generally, ADIABATIC interior walls should be used to separate two spaces that are considered to be identical and are defined via the MULTIPLIER or FLOOR-MULTIPLIER keywords in a SPACE command (see discussion below). Examples are (1) identical spaces that are side-by-side on one floor of a building and (2) identical spaces that are above one another in a high rise building. The wall or ceiling/floor that separates these spaces should be designated as ADIABATIC. In this way, the representative space will have appropriate boundaries even though there is no named space to be NEXT-TO. Another type of use arises when one is modeling only part of a building, e.g., a store abutting two adjacent buildings. The wall that separates that portion of the building that is being modeled from the rest of the structure should be ADIABATIC. The assumption here is that there is no appreciable heat flow through these boundaries. ADIABATIC walls will not contribute to the conductance of the space.

---

In the left column above, bold-faced words are commands, non-bold words are keywords, and italicized words are code-words.

*INTERNAL*

The last type of interior wall has been introduced to permit the treatment of another kind of thermal mass interior to a space. Like furniture, the *INTERNAL* wall will contribute only to the calculation of Custom Weighting Factors and therefore must be of *LAYERS*-type *CONSTRUCTION*. This type of wall is ignored by the daylighting calculation, and therefore daylighting-related keywords do not apply. On the other hand, *SOLAR-FRACTION* is applicable. The *NEXT-TO* keyword is not used with this type of interior wall. One possible use for walls of this type is to model water walls.

**Example**

Assume one wants to simulate a multi-story office building with an elevation as in Fig. 2.19 and a typical floor plan as in Fig. 2.20.

XBL 8210-8740

XBL 8210-4844

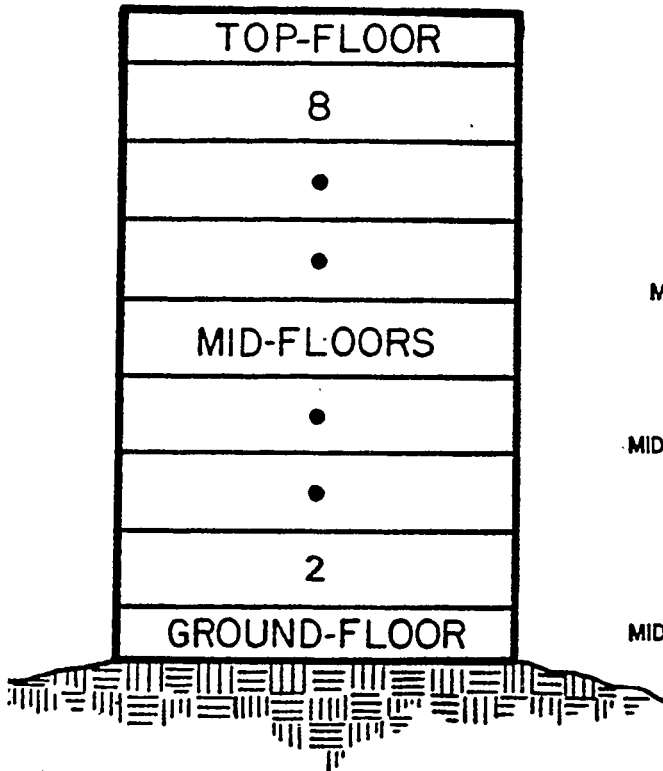

**Figure 2.19:** Multi-Story Office Building:  
Elevation

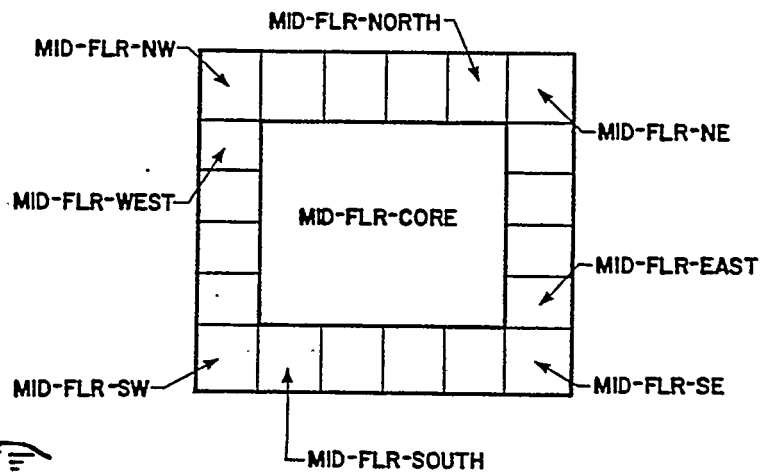

**Figure 2.20:** Typical Floor Plan

In the left column above, bold-faced words are commands, non-bold words are keywords, and italicized words are code-words.

The floors named TOP-FLOOR and GROUND-FLOOR are both unique. Floors 2 through 8, typified by the floor labeled MID-FLOORS, are identical enough to permit the use of the FLOOR-MULTIPLIER keyword. Similarly, the non-corner spaces on each exposure are sufficiently alike to permit the use of the MULTIPLIER keyword. Using MULTIPLIER rather than FLOOR-MULTIPLIER for these spaces will permit the treatment of heat transfer between the peripheral spaces and the core space. Omitting keywords and commands not pertinent to this discussion and illustrating only the East exposure, the input for the building in Figs. 2.19 and 2.20 is:

```

TOP-FLOOR      =   SPACE
                .
                .
                . ..
FLOOR          =   INTERIOR-WALL   INT-WALL-TYPE = ADIABATIC ..
MID-FLR-CORE   =   SPACE
                FLOOR-MULTIPLIER = 7  $- FLOORS 2 THRU 8 -$
                .
                .
                . ..
CORE-FLOR     =   INTERIOR-WALL   INT-WALL-TYPE = ADIABATIC ..
CORE-CEIL     =   INTERIOR-WALL   INT-WALL-TYPE = ADIABATIC ..
MID-FLR-EAST  =   SPACE
                FLOOR-MULTIPLIER = 7  $- FLOORS 2 THRU 8 -$
                .
                .
                . ..
EAST-FLOR     =   INTERIOR-WALL   INT-WALL-TYPE = ADIABATIC ..
EAST-CEIL     =   INTERIOR-WALL   INT-WALL-TYPE = ADIABATIC ..
EAST-CORE     =   INTERIOR-WALL   INT-WALL-TYPE = STANDARD
                NEXT-TO MID-FLR-CORE ..
                .
                . $- OTHER MID-FLOOR SPACES -$
                . ..
GROUND-FLOOR  =   SPACE
                .
                .
                . ..
CLNG          =   INTERIOR-WALL   INT-WALL-TYPE = ADIABATIC ..
                .
                .
                . ..

```

Of the walls entered above only those between the peripheral spaces and the core space will permit the transfer of heat between the spaces. On the other hand, thermal mass and daylighting effects will be accounted for correctly.

In the UNDERGROUND-WALL (or UNDERGROUND-FLOOR) command, the keyword MULTIPLIER is used to specify the total number of identical underground wall or floor panels. Its effect is to multiply the AREA by MULTIPLIER.

In SYSTEMS, the MULTIPLIER keyword in the ZONE command refers to the number of identical zones in the building served by the same system and in thermal contact with an adjoining zone, e.g., a plenum or core zone. This keyword is analogous to the MULTIPLIER keyword in the SPACE command in LOADS and will default to the value of that keyword, if not entered in the ZONE command.

In SYSTEMS, the FLOOR-MULTIPLIER keyword in the ZONE command is analogous to the FLOOR-MULTIPLIER in the SPACE command in LOADS and will default to the value given that keyword in the space with the same u-name as the current zone.

Associated with the interior wall types are two ERROR messages in the Custom Weighting Factors Generation Program.

**Error Message (4)**

**CUSTOM WEIGHTING FACTOR CALCULATION FAILED FOR SPACE <U-name>. USE ASHRAE WEIGHTING FACTORS FOR THIS SPACE.**

Meaning:

The weighting factor calculation does not converge.

User Action:

Check for odd constructions such as upside-down floors with carpets on underside (as a result of incorrectly entering material layers), or walls that are too massive or too light. If nothing out of the ordinary can be found, you are advised to abandon the Custom Weighting Factor approach and to use pre-calculated weighting factors (either custom weighting factors calculated earlier and stored in a library or ASHRAE weighting factors using the FLOOR-WEIGHT keyword with a non-zero value).

**Error Message (5)**

**INTERNAL TYPE INTERIOR WALLS MUST HAVE DELAYED CONSTRUCTION.**

Meaning:

U-VALUE-type CONSTRUCTION has been used to describe an INTERNAL type INTERIOR-WALL. Since the only purpose for INTERNAL type walls is to provide another thermal mass in the space, you must use a massive (LAYERS) type CONSTRUCTION for this type of wall.

User Action:

Use a LAYERS-type CONSTRUCTION for INTERNAL-type INTERIOR-WALLS.



# IMPROVED EXTERIOR INFRARED RADIATION LOSS CALCULATION

## Discussion

The Berdahl-Martin correlation used in DOE-2.1D to determine sky emissivity as a function of atmospheric moisture, cloud amount, and cloud type, was found to underestimate sky emissivity for cloudy conditions. It was replaced in DOE-2.1E with the correlation used in the Thermal Analysis Research Program (TARP) [NIST Report No. NBSIR 83-2655, March 1983]. The result is to decrease radiative heat loss from windows, walls and roofs relative to 2.1D values, giving a 2-5% lower heating load and 2-5% higher cooling load depending on climate and building envelope U-value.

# IMPROVED OUTSIDE AIR FILM CONDUCTANCE CALCULATION

## Discussion

In DOE-2.1E an improved correlation has been introduced for the outside air film conductance for EXTERIOR-WALLS, ROOFs, DOORs and WINDOWs.\* In the new correlation, the convective part of the conductance depends on wind speed, wind direction, and surface temperature, roughness, and orientation. The radiative part of the conductance depends on surface temperature and IR emissivity. In contrast, in earlier versions, the convective part of the conductance depended only on wind speed and the radiative part was constant.

The improved outside air film correlation gives air film conductances that are two to three times smaller than in earlier versions, primarily due to a reduction in the wind-speed dependent portion of the conductance. The result is to decrease heating loads and to increase cooling loads by 5-15% relative to DOE-2.1D, primarily due to (1) higher inward-flowing fraction of solar radiation absorbed by opaque surface and windows, and (2) reduced conduction through windows, especially those with single glazing. The differences with DOE-2.1D will be highest for poorly insulated structures.

Note also that, beginning with DOE-2.1E, the wind speed used to calculate the convective part of the outside air film conductance is the wind speed at the site, which is obtained from the weather file wind speed by applying terrain and space height corrections (see "Terrain and Height Modification to Wind Speed", p.2.88). Since the site wind speed is generally lower than the weather file wind speed, this further decreases the film conductance relative to DOE-2.1D.

## OUTSIDE-EMISS Keyword

In implementing the new correlation, the keyword OUTSIDE-EMISS has been added to the CONSTRUCTION command. This is the infrared (IR) emissivity of the outside surface (default 0.9). In DOE-2.1D and earlier versions, this emissivity was fixed at 0.9 and could not be changed.

---

\* The correlation was derived by J. Klems and M. Yazdanian of the LBL Windows and Daylighting Group, based on measurements in the LBL MoWITT facility. (M. Yazdanian and J.H. Klems, "Measurement of the Exterior Convective Film Coefficient for Windows in Low-Rise Buildings", Lawrence Berkeley Laboratory report, 1993.)

# WINDOW LIBRARY

## Introduction

DOE-2.1E contains a new Window Library with approximately 200 entries covering commonly-available glazings as well as experimental electrochromic glazings.\* The choices are shown in the library index, Table 2.12. Included are single-, double-, triple- and quadruple-pane glazings with different tints, coatings, gas fills, glass thicknesses, and gap widths.

The Window Library was created for DOE-2 using WINDOW-4, a computer program that does a very detailed calculation of conduction and solar heat gain through windows.\*\* When windows from this library are selected, the window heat transfer calculation in DOE-2 will be very close to that in WINDOW-4.

You select an entry from the Window Library by specifying GLASS-TYPE-CODE = 1000 or higher (the G-T-C value in Table 2.12). Because conductance data, number of panes, and solar-optical properties come from the library, you do not have to specify the GLASS-TYPE keywords GLASS-CONDUCTANCE, PANES, or VIS-TRANS (if you do specify them, they will be ignored).

### Example:

For low-E clear double-pane window with 6mm glass and 12mm gap filled with argon (G-T-C number 2635 in Table 2.12, p.2.103), enter:

```
u-name = GLASS-TYPE    GLASS-TYPE-CODE = 2635 ..
```

Each window entry in the library also contains a frame type and a spacer type (for multipane windows), both of which can be overridden, as explained below in the sections "Window Frames" and "Edge-of-Glass Effects."

The glazing and frame dimensions in the library are *not* used. You specify glazing dimensions with the WINDOW keywords HEIGHT and WIDTH. Frame size is specified with the WINDOW keyword FRAME-WIDTH (see "Window Frames", p.2.115).

For upward compatibility with previous versions of DOE-2, you can still specify glazing characteristics using SHADING-COEF, or GLASS-TYPE-CODE = 1 to 11 (see *Reference Manual (2.1A)*, pp.III.87-93). However, using the Window Library will give the most accurate window heat transfer calculation because (1) the angular dependence of transmission and absorption of solar radiation is precisely modeled, and (2) the temperature dependence of the window U-value is taken into account. The following input examples show the three methods now available in DOE-2 to specify window properties.

---

\* The Window Library and the implementation of the WINDOW-4 heat transfer calculations in DOE-2 are the result of a collaboration among the Simulation Research Group, D.K. Arasteh and M.S. Reilly of the LBL Windows and Daylighting Group, and W.L. Carroll of the LBL Building Systems Analysis Group.

\*\*See D.K. Arasteh, M.S. Reilly, and M.D. Rubin, "A Versatile Procedure for Calculating Heat Transfer Through Windows," ASHRAE Trans. 1989, Vol. 95, Pt. 2, and Lawrence Berkeley Laboratory report no. 27534, 1989. See also "WINDOW 4.0: Program Description", Lawrence Berkeley Laboratory report no. LBL-32091, 1992.

**Method 1: Shading Coefficient**

uname =GLASS-TYPE	SHADING-COEF = value	required for this method
	PANES = 1,2, or 3	default is 1
	GLASS-CONDUCTANCE = value	default depends on PANES
	VIS-TRANS = value	required only for daylighting
	FRAME-CONDUCTANCE = value	optional;
	FRAME-ABS = value	default is 0.434 Btuh/ft <sup>2</sup> -F
		optional; default is 0.7

**Method 2: GLASS-TYPE-CODE ≤ 11**

uname =GLASS-TYPE	GLASS-TYPE-CODE = 1 to 11	required for this method
	PANES = 1,2, or 3	default is 1
	GLASS-CONDUCTANCE = value	default depends on PANES
	VIS-TRANS = value	required only for daylighting
	FRAME-CONDUCTANCE = value	optional;
	FRAME-ABS = value	default is 0.434 Btuh/ft <sup>2</sup> -F
		optional; default is 0.7

**Method 3: Window Library (GLASS-TYPE-CODE ≥ 1000)**

uname =GLASS-TYPE	GLASS-TYPE-CODE = 1000 to 9999	required for this method
	FRAME-CONDUCTANCE = value	optional;
	FRAME-ABS = value	default is 0.434 Btuh/ft <sup>2</sup> -F
		optional; default is 0.7

The pros and cons of the different methods are compared in the following table:

Comparison of Methods for Specifying Window Properties		
Method	Pro	Con
1. Shading Coefficient	Convenient for conceptual design	Inaccurate angular dependence for multipane glazing
2. GLASS-TYPE-CODE ≤ 11	More accurate angular dependence	May not be good match to actual glazing
3. Window Library: GLASS-TYPE-CODE ≥ 1000	Highly accurate angular dependence and conduction; user can expand library	50-100% increase in LOADS calculation time depending on number of windows

## Index to the Window Library

Table 2.12 is an index to the Window Library. Single-pane entries are given first, followed by double-, triple-, and quadruple-pane. For a given number of panes, clear and low-iron glazings are given first, followed by tinted, reflective, low-E, and electrochromic options. A graphical overview of the library is given in Figs. 2.21 (p.2.110) and 2.22 (p.2.111), which show scatter plots of shading coefficient vs. visible transmittance and shading coefficient vs. U-value, respectively, for all entries in the library except the electrochromic glazings. You may find these plots useful in choosing a window having the solar-thermal properties desired for a particular application.

You can find the best GLASS-TYPE-CODE for a particular glazing product by matching the number of panes, glass thickness, gap width, tint, coating, and gas fill from the manufacturer's data sheet with the corresponding information in Table 2.12. Manufacturer's values for shading coefficient, transmittance, and reflectance can be used to check your selection. If you can't find a good match, which may be the case for unusual or experimental glazings, you can create your own GLASS-TYPE-CODE, as described below in "Creating Custom Windows".

The column headings in Table 2.12 are as follows:

G-T-C	GLASS-TYPE-CODE. The first digit is the number of panes. The second digit is 0 for clear or low-iron; 2 for tinted but no coating; 4 for reflective coating with clear or tinted glass; 6 for low-E coating on clear or tinted glass, and 8 for electrochromic glass.
U-SI	Center-of-glass U-value* in SI units ( $W/m^2-K$ ) for ASHRAE winter conditions [-17.8°C (0°F) outside temperature, 21.1°C (70°F) inside temperature, 6.71 m/s (15 mph) windspeed and zero incident solar radiation]. Includes a combined convective plus radiative outside air film conductance of 28.7 $W/m^2-K$ .
U-IP	Center-of-glass U-value in inch-pound units ( $Btu/ft^2-h-F$ ) for ASHRAE winter conditions. Includes a combined convective plus radiative outside air film conductance of 5.0 $Btu/ft^2-h-F$ .
SC	Center-of-glass shading coefficient for ASHRAE summer conditions [35°C (95°F) outside temperature, 24°C (75°F) inside temperature, 3.3 m/s (7.5 mph) windspeed, and near-normal incident solar radiation of 783 $W/m^2$ (248 $Btu/h-ft^2$ )]
SHGC	Center-of-glass solar heat gain coefficient at near normal incidence for ASHRAE summer conditions.
Tsol	Center-of-glass solar transmittance for all glazing layers, at normal incidence.
Rfsol	Center-of-glass solar reflectance for all glazing layers for radiation incident from the front at normal incidence.

---

\* DOE-2 calculates the overall U-value of a window as the area-weighted average of the center-of-glass U-value, the edge-of-glass U-value and the frame U-value (if the frame is defined).

Tvis	Center-of-glass visible transmittance for all glazing layers, at normal incidence.
Rfvis	Center-of-glass visible reflectance for all glazing layers for radiation incident from the front at normal incidence.
LAYn ID	Identification number of the <i>n</i> th solid layer (pane) in the glazing assembly. The panes are numbered from the outdoor side of the window to the room side. (For windows in an interior wall between a sunspace and adjacent room, the "outdoor" side is the sunspace side.) The properties of this layer are given in Appendix D, "WINDOW-4 Glass Layer Library" (although called the "glass layer library", some of the entries are for plastic films). (This library is not accessible by DOE-2 and is shown here for reference only. It was used with WINDOW-4 to create the DOE-2 Window Library.)
LAYn WID	Thickness of the <i>n</i> th pane (mm).
GAPn GAS	Type of gas (air, argon, etc.) in the <i>n</i> th gap. Gaps are numbered from the outdoor side of the window to the room side.
GAPn WID	Thickness of the <i>n</i> th gap (mm).

*Terminology is as follows:*

CLEAR or CLR	No impurities added to the glass mix.
LOW IRON	Clear glass with a low iron content, resulting in higher transmittance.
TINT	Outer pane is tinted with inorganic materials to increase absorption in certain areas of the visible spectrum in order to produce a certain color.
REF	Reflective; i.e., a metallic coating is applied to one surface of a pane in order to increase solar reflection. REF A refers to stainless steel coatings, REF B to titanium, REF C to pewter, and REF D to tin-oxide. L, M, and H refer to low, medium, and high transmittance coating, respectively.
LOW-E	Low emissivity: a metallic coating is applied in order to increase thermal infrared reflectance. The coated surface is indicated by $en=v$ , where $n=1$ is the outside of the outer pane, $n=2$ is the inside of the outer pane, etc., and $v$ is the emissivity (see, for example, G-T-C = 2635, where $e2=.1$ indicates a coating with an emissivity of 0.1 on surface #2).
IG	Insulating glass: multipane glass with the gap(s) between panes filled with air or some other gas to produce an insulating effect.
FILM	A polyester film (with low-E coating) stretched between glass panes. The approximate visible transmittance of the film (in percent) is shown as ( <i>nn</i> ); see, for example, G-T-C = 3641.

**ELECTROCHROMIC** A coating that makes the glazing more absorbing or more reflecting as the voltage applied to glazing changes.

**BLEACHED** The clearest state of electrochromic glass.

**COLORED** The darkest state of electrochromic glass.

**Table 2.12**  
**Index to the Window Library**

G-T-C	WINDOW	U-SI	U-IP	SC	SHGC	Tsol	Rfsol	Tvis	Rfvis	LAY1	
										ID	WID
<b>SINGLE CLEAR</b>											
1000	CLEAR	6.31	1.11	1.00	.86	.84	.08	.90	.08	2	3.0
1001	CLEAR	6.17	1.09	.95	.81	.77	.07	.88	.08	3	6.0
1002	LOW IRON	6.31	1.11	1.05	.90	.90	.08	.91	.08	14	3.0
1003	LOW IRON	6.22	1.10	1.04	.90	.89	.08	.91	.08	16	5.0
<b>SINGLE TINT</b>											
1200	BRONZE	6.31	1.11	.84	.73	.64	.06	.69	.06	5	3.0
1201	BRONZE	6.17	1.09	.71	.61	.48	.05	.53	.06	6	6.0
1202	GREEN	6.31	1.11	.83	.72	.63	.06	.82	.08	11	3.0
1203	GREEN	6.17	1.09	.71	.61	.49	.06	.75	.07	12	6.0
1204	GREY	6.31	1.11	.83	.71	.63	.06	.61	.06	8	3.0
1205	GREY	6.17	1.09	.69	.59	.46	.05	.43	.05	9	6.0
1206	BLUE	6.17	1.09	.71	.61	.48	.05	.57	.06	17	6.0
<b>SINGLE REF A</b>											
1400	CLEAR-L	4.90	.86	.23	.19	.07	.34	.08	.41	200	6.0
1401	CLEAR-M	5.11	.90	.29	.25	.11	.27	.14	.31	201	6.0
1402	CLEAR-H	5.41	.95	.36	.31	.16	.22	.20	.25	202	6.0
1403	TINT-L	4.93	.87	.26	.22	.04	.15	.05	.17	210	6.0
1404	TINT-M	5.11	.90	.29	.25	.06	.13	.09	.14	211	6.0
1405	TINT-H	5.29	.93	.34	.29	.10	.11	.10	.11	212	6.0
<b>SINGLE REF B</b>											
1406	CLEAR-L	5.44	.96	.35	.31	.15	.22	.20	.23	220	6.0
1407	CLEAR-H	5.50	.97	.45	.39	.24	.16	.30	.16	221	6.0
1408	TINT-L	4.93	.87	.26	.23	.04	.13	.05	.09	230	6.0
1409	TINT-M	5.05	.89	.33	.28	.10	.11	.13	.10	231	6.0
1410	TINT-H	5.50	.97	.40	.34	.15	.09	.18	.08	232	6.0
<b>SINGLE REF C</b>											
1411	CLEAR-L	4.99	.88	.29	.25	.11	.25	.13	.28	240	6.0
1412	CLEAR-M	5.23	.92	.37	.32	.17	.20	.19	.21	241	6.0
1413	CLEAR-H	5.35	.94	.41	.35	.20	.16	.22	.17	242	6.0
1414	TINT-L	4.99	.88	.29	.25	.07	.13	.08	.13	250	6.0
1415	TINT-M	5.23	.92	.34	.29	.10	.10	.11	.10	251	6.0
1416	TINT-H	5.35	.94	.37	.31	.12	.09	.13	.09	252	6.0
<b>SINGLE REF D</b>											
1417	CLEAR	6.12	1.08	.58	.50	.43	.31	.33	.45	260	6.0
1418	TINT	6.12	1.08	.53	.46	.30	.14	.25	.18	270	6.0
<b>SINGLE LOW-E CLEAR</b>											
1600	(e2=.4)	4.99	.88	.91	.78	.75	.10	.85	.12	300	3.0
1601	(e2=.2)	4.34	.76	.89	.77	.74	.09	.82	.11	350	3.0
1602	(e2=.2)	4.27	.75	.84	.72	.68	.09	.81	.11	351	6.0
<b>SINGLE ELECTROCHROMIC ABSORBING BLEACHED/COLORED</b>											
1800		6.17	1.09	.98	.84	.81	.09	.85	.10	700	6.0
1801		6.17	1.09	.36	.31	.11	.18	.13	.08	701	6.0
<b>SINGLE ELECTROCHROMIC REFLECTING BLEACHED/COLORED</b>											
1802		6.17	1.09	.85	.73	.69	.17	.82	.11	702	6.0
1803		6.17	1.09	.34	.29	.10	.22	.16	.07	703	6.0



**Table 2.12 (continued)**  
**Index to the Window Library**

G-T-C	U-SI	U-IP	SC	SHGC	Tsol	Rfsol	Tvis	Rfvis	LAY1		GAP1		LAY2	
									ID	WID	GAS	WID	ID	WID
<b>DOUBLE CLEAR IG</b>														
2000	3.23	.57	.88	.76	.70	.13	.81	.15	2	3.0	Air	6.3	2	3.0
2001	2.79	.49	.89	.76	.70	.13	.81	.15	2	3.0	Air	12.7	2	3.0
2002	2.61	.46	.89	.76	.70	.13	.81	.15	2	3.0	Arg	12.7	2	3.0
2003	3.16	.56	.81	.69	.60	.11	.78	.14	3	6.0	Air	6.3	3	6.0
2004	2.74	.48	.81	.70	.60	.11	.78	.14	3	6.0	Air	12.7	3	6.0
2005	2.56	.45	.81	.70	.60	.11	.78	.14	3	6.0	Arg	12.7	3	6.0
<b>DOUBLE LOW IRON IG</b>														
2006	3.23	.57	.96	.83	.81	.14	.84	.15	14	3.0	Air	6.3	14	3.0
2007	2.79	.49	.96	.83	.81	.14	.84	.15	14	3.0	Air	12.7	14	3.0
2008	2.61	.46	.96	.83	.81	.14	.84	.15	14	3.0	Arg	12.7	14	3.0
2009	3.18	.56	.95	.82	.80	.14	.83	.15	16	5	Air	6.3	16	5.0
2010	2.76	.49	.95	.82	.80	.14	.83	.15	16	5	Air	12.7	16	5.0
2011	2.58	.45	.95	.82	.80	.14	.83	.15	16	5	Arg	12.7	16	5.0
<b>DOUBLE TINT BRONZE IG</b>														
2200	3.23	.57	.72	.62	.54	.09	.62	.10	5	3.0	Air	6.3	2	3.0
2201	2.79	.49	.72	.62	.54	.09	.62	.10	5	3.0	Air	12.7	2	3.0
2202	2.61	.46	.72	.62	.54	.09	.62	.10	5	3.0	Arg	12.7	2	3.0
2203	3.16	.56	.57	.49	.38	.07	.47	.08	6	6.0	Air	6.3	3	6.0
2204	2.74	.48	.57	.49	.38	.07	.47	.08	6	6.0	Air	12.7	3	6.0
2205	2.56	.45	.56	.49	.38	.07	.47	.08	6	6.0	Arg	12.7	3	6.0
<b>DOUBLE TINT GREEN IG</b>														
2206	3.23	.57	.72	.62	.53	.09	.74	.13	11	3.0	Air	6.3	2	3.0
2207	2.79	.49	.71	.61	.53	.09	.74	.13	11	3.0	Air	12.7	2	3.0
2208	2.61	.46	.71	.61	.53	.09	.74	.13	11	3.0	Arg	12.7	2	3.0
2209	3.16	.56	.58	.50	.38	.07	.66	.12	12	6.0	Air	6.3	3	6.0
2210	2.74	.48	.57	.49	.38	.07	.66	.12	12	6.0	Air	12.7	3	6.0
2211	2.56	.45	.57	.49	.38	.07	.66	.12	12	6.0	Arg	12.7	3	6.0
<b>DOUBLE TINT GREY IG</b>														
2212	3.23	.57	.71	.61	.53	.09	.55	.09	8	3.0	Air	6.3	2	3.0
2213	2.79	.49	.71	.61	.53	.09	.55	.09	8	3.0	Air	12.7	2	3.0
2214	2.61	.46	.70	.61	.53	.09	.55	.09	8	3.0	Arg	12.7	2	3.0
2215	3.16	.56	.55	.47	.35	.07	.38	.07	9	6.0	Air	6.3	3	6.0
2216	2.74	.48	.54	.47	.35	.07	.38	.07	9	6.0	Air	12.7	3	6.0
2217	2.56	.45	.54	.47	.35	.07	.38	.07	9	6.0	Arg	12.7	3	6.0
<b>DOUBLE TINT BLUE IG</b>														
2218	3.16	.56	.57	.49	.37	.07	.50	.09	17	6.0	Air	6.3	3	6.0
2219	2.74	.48	.57	.49	.37	.07	.50	.09	17	6.0	Air	12.7	3	6.0
2220	2.56	.45	.56	.49	.37	.07	.50	.09	17	6.0	Arg	12.7	3	6.0
<b>DOUBLE REF A CLEAR-L IG</b>														
2400	2.79	.49	.17	.14	.05	.34	.07	.41	200	6.0	Air	6.3	3	6.0
2401	2.26	.40	.15	.13	.05	.34	.07	.41	200	6.0	Air	12.7	3	6.0
2402	2.02	.36	.14	.12	.05	.34	.07	.41	200	6.0	Arg	12.7	3	6.0
<b>DOUBLE REF A CLEAR-M IG</b>														
2403	2.86	.50	.22	.19	.09	.27	.13	.31	201	6.0	Air	6.3	3	6.0
2404	2.35	.41	.20	.17	.09	.27	.13	.31	201	6.0	Air	12.7	3	6.0
2405	2.13	.38	.20	.17	.09	.27	.13	.31	201	6.0	Arg	12.7	3	6.0

**Table 2.12 (continued)**  
**Index to the Window Library**

G-T-C	U-SI	U-IP	SC	SHGC	Tsol	Rfsol	Tvis	Rfvis	LAY1		GAP1		LAY2	
									ID	WID	GAS	WID	ID	WID
<b>DOUBLE REF A CLEAR-H IG</b>														
2406	2.95	.52	.27	.23	.13	.22	.18	.25	202	6.0	Air	6.3	3	6.0
2407	2.47	.44	.26	.22	.13	.22	.18	.25	202	6.0	Air	12.7	3	6.0
2408	2.26	.40	.25	.22	.13	.22	.18	.25	202	6.0	Arg	12.7	3	6.0
<b>DOUBLE REF A TINT-L IG</b>														
2410	2.80	.49	.18	.15	.03	.15	.05	.17	210	6.0	Air	6.3	3	6.0
2411	2.27	.40	.15	.13	.03	.15	.05	.17	210	6.0	Air	12.7	3	6.0
2412	2.04	.36	.15	.13	.03	.15	.05	.17	210	6.0	Arg	12.7	3	6.0
<b>DOUBLE REF A TINT-M IG</b>														
2413	2.86	.50	.20	.17	.05	.13	.08	.14	211	6.0	Air	6.3	3	6.0
2414	2.35	.41	.18	.15	.05	.13	.08	.14	211	6.0	Air	12.7	3	6.0
2415	2.13	.38	.17	.15	.05	.13	.08	.14	211	6.0	Arg	12.7	3	6.0
<b>DOUBLE REF A TINT-H IG</b>														
2416	2.92	.51	.24	.21	.08	.11	.09	.11	212	6.0	Air	6.3	3	6.0
2417	2.42	.43	.22	.19	.08	.11	.09	.11	212	6.0	Air	12.7	3	6.0
2418	2.21	.39	.21	.19	.08	.11	.09	.11	212	6.0	Arg	12.7	3	6.0
<b>DOUBLE REF B CLR-L IG</b>														
2420	2.96	.52	.27	.23	.12	.22	.18	.23	220	6.0	Air	6.3	3	6.0
2421	2.48	.44	.25	.22	.12	.22	.18	.23	220	6.0	Air	12.7	3	6.0
2422	2.27	.40	.25	.21	.12	.22	.18	.23	220	6.0	Arg	12.7	3	6.0
<b>DOUBLE REF B CLR-H IG</b>														
2426	2.98	.53	.35	.30	.19	.16	.27	.17	221	6.0	Air	6.3	3	6.0
2427	2.50	.44	.34	.29	.19	.16	.27	.17	221	6.0	Air	12.7	3	6.0
2428	2.30	.41	.34	.29	.19	.16	.27	.17	221	6.0	Arg	12.7	3	6.0
<b>DOUBLE REF B TINT-L IG</b>														
2430	2.80	.49	.18	.15	.03	.13	.05	.09	230	6.0	Air	6.3	3	6.0
2431	2.27	.40	.16	.14	.03	.13	.05	.09	230	6.0	Air	12.7	3	6.0
2432	2.04	.36	.15	.13	.03	.13	.05	.09	230	6.0	Arg	12.7	3	6.0
<b>DOUBLE REF B TINT-M IG</b>														
2433	2.84	.50	.24	.20	.08	.11	.12	.10	231	6.0	Air	6.3	3	6.0
2434	2.33	.41	.22	.19	.08	.11	.12	.10	231	6.0	Air	12.7	3	6.0
2435	2.10	.37	.21	.18	.08	.11	.12	.10	231	6.0	Arg	12.7	3	6.0
<b>DOUBLE REF B TINT-H IG</b>														
2436	2.98	.53	.29	.25	.12	.09	.16	.08	232	6.0	Air	6.3	3	6.0
2437	2.50	.44	.27	.23	.12	.09	.16	.08	232	6.0	Air	12.7	3	6.0
2438	2.30	.41	.27	.23	.12	.09	.16	.08	232	6.0	Arg	12.7	3	6.0
<b>DOUBLE REF C CLEAR-L IG</b>														
2440	2.82	.50	.22	.19	.09	.25	.12	.28	240	6.0	Air	6.3	3	6.0
2441	2.30	.41	.20	.18	.09	.25	.12	.28	240	6.0	Air	12.7	3	6.0
2442	2.07	.36	.20	.17	.09	.25	.12	.28	240	6.0	Arg	12.7	3	6.0
<b>DOUBLE REF C CLEAR-M IG</b>														
2443	2.90	.51	.28	.24	.14	.20	.17	.21	241	6.0	Air	6.3	3	6.0
2444	2.40	.42	.27	.23	.14	.20	.17	.21	241	6.0	Air	12.7	3	6.0
2445	2.18	.38	.26	.23	.14	.20	.17	.21	241	6.0	Arg	12.7	3	6.0

Table 2.12 (continued)  
Index to the Window Library

G-T-C	U-SI	U-IP	SC	SHGC	Tsol	Rfsol	Tvis	Rfvis	LAY1		GAP1		LAY2	
									ID	WID	GAS	WID	ID	WID
<b>DOUBLE REF C CLEAR-H IG</b>														
2446	2.94	.52	.32	.27	.16	.16	.20	.17	242	6.0	Air	6.3	3	6.0
2447	2.45	.43	.30	.26	.16	.16	.20	.17	242	6.0	Air	12.7	3	6.0
2448	2.23	.39	.30	.26	.16	.16	.20	.17	242	6.0	Arg	12.7	3	6.0
<b>DOUBLE REF C TINT-L IG</b>														
2450	2.82	.50	.21	.18	.06	.13	.07	.13	250	6.0	Air	6.3	3	6.0
2451	2.30	.41	.19	.16	.06	.13	.07	.13	250	6.0	Air	12.7	3	6.0
2452	2.07	.36	.18	.15	.06	.13	.07	.13	250	6.0	Arg	12.7	3	6.0
<b>DOUBLE REF C TINT-M IG</b>														
2453	2.90	.51	.24	.21	.08	.10	.10	.10	251	6.0	Air	6.3	3	6.0
2454	2.40	.42	.22	.19	.08	.10	.10	.10	251	6.0	Air	12.7	3	6.0
2455	2.18	.38	.21	.19	.08	.10	.10	.10	251	6.0	Arg	12.7	3	6.0
<b>DOUBLE REF C TINT-H IG</b>														
2456	2.94	.52	.26	.23	.10	.09	.12	.09	252	6.0	Air	6.3	3	6.0
2457	2.45	.43	.24	.21	.10	.09	.12	.09	252	6.0	Air	12.7	3	6.0
2458	2.23	.39	.24	.20	.10	.09	.12	.09	252	6.0	Arg	12.7	3	6.0
<b>DOUBLE REF D CLEAR IG</b>														
2460	3.15	.56	.49	.42	.34	.32	.31	.46	260	6.0	Air	6.3	3	6.0
2461	2.72	.48	.49	.42	.34	.32	.31	.46	260	6.0	Air	12.7	3	6.0
2462	2.54	.45	.49	.42	.34	.32	.31	.46	260	6.0	Arg	12.7	3	6.0
<b>DOUBLE REF D TINT IG</b>														
2470	3.15	.56	.41	.35	.24	.15	.23	.19	270	6.0	Air	6.3	3	6.0
2471	2.72	.48	.40	.35	.24	.15	.23	.19	270	6.0	Air	12.7	3	6.0
2472	2.54	.45	.40	.34	.24	.15	.23	.19	270	6.0	Arg	12.7	3	6.0
<b>DOUBLE LOW-E (e3-.4) CLEAR IG</b>														
2600	2.85	.50	.84	.72	.63	.15	.77	.18	2	3.0	Air	6.3	300	3.0
2601	2.30	.41	.85	.73	.63	.15	.77	.18	2	3.0	Air	12.7	300	3.0
2602	2.05	.36	.85	.73	.63	.15	.77	.18	2	3.0	Arg	12.7	300	3.0
<b>DOUBLE LOW-E (e3-.2) CLEAR IG</b>														
2610	2.61	.46	.84	.72	.62	.15	.74	.18	2	3.0	Air	6.3	350	3.0
2611	1.99	.35	.85	.73	.62	.15	.74	.18	2	3.0	Air	12.7	350	3.0
2612	1.70	.30	.86	.74	.62	.15	.74	.18	2	3.0	Arg	12.7	350	3.0
2613	2.57	.45	.77	.66	.53	.13	.72	.17	3	6.0	Air	6.3	351	6.0
2614	1.96	.35	.78	.67	.53	.13	.72	.17	3	6.0	Air	12.7	351	6.0
2615	1.67	.29	.79	.68	.53	.13	.72	.17	3	6.0	Arg	12.7	351	6.0
<b>DOUBLE LOW-E (e2-.1) CLEAR IG</b>														
2630	2.47	.44	.69	.60	.54	.22	.77	.14	400	3.0	Air	6.3	2	3.0
2631	1.81	.32	.69	.60	.54	.22	.77	.14	400	3.0	Air	12.7	2	3.0
2632	1.48	.26	.69	.59	.54	.22	.77	.14	400	3.0	Arg	12.7	2	3.0
2633	2.43	.43	.65	.56	.47	.20	.75	.11	401	6.0	Air	6.3	3	6.0
2634	1.78	.31	.65	.56	.47	.20	.75	.11	401	6.0	Air	12.7	3	6.0
2635	1.46	.26	.66	.56	.47	.20	.75	.11	401	6.0	Arg	12.7	3	6.0

Table 2.12 (continued)  
Index to the Window Library

G-T-C	U-SI	U-IP	SC	SHGC	Tsol	Rfsol	Tvis	Rfvis	LAY1 ID	LAY1 WID	GAP1 GAS	GAP1 WID	LAY2 ID	LAY2 WID
<b>DOUBLE LOW-E (e2=.1) TINT IG</b>														
2636	2.43	.43	.45	.39	.28	.10	.44	.05	451	6.0	Air	6.3	3	6.0
2637	1.78	.31	.43	.37	.28	.10	.44	.05	451	6.0	Air	12.7	3	6.0
2638	1.46	.26	.43	.37	.28	.10	.44	.05	451	6.0	Arg	12.7	3	6.0
<b>DOUBLE LOW-E (e3=.1) CLEAR IG</b>														
2640	2.47	.44	.74	.63	.54	.23	.77	.13	2	3.0	Air	6.3	400	3.0
2641	1.81	.32	.75	.64	.54	.23	.77	.13	2	3.0	Air	12.7	400	3.0
2642	1.48	.26	.75	.65	.54	.23	.77	.13	2	3.0	Arg	12.7	400	3.0
<b>DOUBLE LOW-E (e2=.04) CLEAR IG</b>														
2660	2.38	.42	.51	.44	.39	.36	.70	.12	500	3.0	Air	6.3	2	3.0
2661	1.68	.30	.51	.44	.39	.36	.70	.12	500	3.0	Air	12.7	2	3.0
2662	1.34	.24	.50	.43	.39	.36	.70	.12	500	3.0	Arg	12.7	2	3.0
<b>DOUBLE LOW-E (e2=.04) CLEAR IG</b>														
2663	2.41	.42	.49	.42	.34	.31	.68	.12	501	6.0	Air	6.3	3	6.0
2664	1.67	.29	.48	.42	.34	.31	.68	.12	501	6.0	Air	12.7	3	6.0
2665	1.32	.23	.48	.42	.34	.31	.68	.12	501	6.0	Arg	12.7	3	6.0
<b>DOUBLE LOW-E (e2=.04) TINT IG</b>														
2666	2.41	.42	.35	.31	.21	.14	.41	.08	550	6.0	Air	6.3	3	6.0
2667	1.67	.29	.33	.29	.21	.14	.41	.08	550	6.0	Air	12.7	3	6.0
2668	1.32	.23	.32	.28	.21	.14	.41	.08	550	6.0	Arg	12.7	3	6.0
<b>DOUBLE ELECTROCHROMIC ABSORBING IG BLEACHED/COLORED AIR</b>														
2800	2.43	0.43	.85	.73	.64	.14	.76	.16	704F	6.0	Air	6.3	709	6.0
2801	2.43	0.43	.21	.18	.09	.18	.12	.08	705F	6.0	Air	6.3	709	6.0
<b>DOUBLE ELECTROCHROMIC ABSORBING IG BLEACHED/COLORED AIR</b>														
2802	1.78	0.31	.86	.74	.64	.14	.76	.16	704F	6.0	Air	12.7	709	6.0
2803	1.78	0.31	.19	.20	.16	.18	.12	.08	705F	6.0	Air	12.7	709	6.0
<b>DOUBLE ELECTROCHROMIC ABSORBING IG BLEACHED/COLORED ARGON</b>														
2804	1.49	0.26	.86	.74	.64	.14	.76	.16	704F	6.0	Arg	12.7	709	6.0
2805	1.49	0.26	.18	.15	.09	.18	.12	.08	705F	6.0	Arg	12.7	709	6.0
<b>DOUBLE ELECTROCHROMIC REFLECTING IG BLEACHED/COLORED AIR</b>														
2820	2.43	0.43	.73	.63	.55	.21	.73	.17	706F	6.0	Air	6.3	709	6.0
2821	2.43	0.43	.20	.17	.09	.22	.14	.08	707F	6.0	Air	6.3	709	6.0
<b>DOUBLE ELECTROCHROMIC REFLECTING IG BLEACHED/COLORED AIR</b>														
2822	1.78	0.31	.74	.64	.55	.21	.73	.17	706F	6.0	Air	12.7	709	6.0
2823	1.78	0.31	.17	.15	.09	.22	.14	.08	707F	6.0	Air	12.7	709	6.0
<b>DOUBLE ELECTROCHROMIC REFLECTING IG BLEACHED/COLORED ARGON</b>														
2824	1.49	0.26	.74	.64	.55	.21	.73	.17	706F	6.0	Arg	12.7	709	6.0
2825	1.49	0.26	.16	.15	.09	.22	.14	.08	707F	6.0	Arg	12.7	709	6.0
<b>DOUBLE LOW-E (e2=.029) ELECTROCHROMIC ABS IG BLEACHED/COLORED AIR</b>														
2840	2.33	0.41	.51	.44	.34	.33	.66	.14	704F	6.0	Air	6.3	708F	5.7
2841	2.33	0.41	.18	.16	.06	.19	.10	.08	705F	6.0	Air	6.3	708F	5.7
<b>DOUBLE LOW-E (e2=.029) ELECTROCHROMIC ABS IG BLEACHED/COLORED AIR</b>														
2842	1.64	0.29	.59	.51	.34	.33	.66	.14	704F	6.0	Air	12.7	708F	5.7
2843	1.64	0.29	.15	.13	.06	.19	.10	.08	705F	6.0	Air	12.7	708F	5.7
<b>DOUBLE LOW-E (e2=.029) ELECTROCHROMIC ABS IG BLEACHED/COLORED ARGON</b>														
2844	1.33	0.23	.60	.52	.34	.33	.66	.14	704F	6.0	Arg	12.7	708F	5.7
2845	1.33	0.23	.14	.12	.06	.19	.10	.08	705F	6.0	Arg	12.7	708F	5.7

Table 2.12 (continued)  
Index to the Window Library

G-T-C	U-SI	U-IP	SC	SHGC	Tsol	Rfsol	Tvis	Rfvis	LAY1		GAP1		LAY2		
									ID	WID	GAS	WID	ID	WID	
<b>DOUBLE LOW-E (e2=.029) ELECTROCHROMIC REF IG BLEACHED/COLORED AIR</b>															
2860	2.33	0.41	.54	.46	.32	.32	.64	.14	706F	6.0	Air	6.3	708F	5.7	
2861	2.33	0.41	.18	.16	.07	.22	.12	.08	707F	6.0	Air	6.3	708F	5.7	
<b>DOUBLE LOW-E (e2=.029) ELECTROCHROMIC REF IG BLEACHED/COLORED AIR</b>															
2862	1.64	0.29	.55	.47	.32	.32	.64	.14	706F	6.0	Air	12.7	708F	5.7	
2863	1.64	0.29	.16	.14	.07	.22	.12	.08	707F	6.0	Air	12.7	708F	5.7	
<b>DOUBLE LOW-E (e2=.029) ELECTROCHROMIC REF IG BLEACHED/COLORED ARGON</b>															
2864	1.33	0.23	.56	.48	.32	.32	.64	.14	706F	6.0	Arg	12.7	708F	5.7	
2865	1.33	0.23	.15	.13	.07	.22	.12	.08	707F	6.0	Arg	12.7	708F	5.7	

**Table 2.12 (continued)**  
**Index to the Window Library**

G-T-C	U-SI	U-IP	SC	SHGC	Tsol	Rfsol	Tvis	Rfvis	LAY1		GAP1		LAY2		GAP2		
									ID	WID	GAS	WID	ID	WID	GAS	WID	
<b>TRIPLE CLEAR IG</b>																	
3001	2.19	.39	.79	.68	.60	.17	.74	.20	2	3.0	Air	6.3	2	3.0	Air	6.3	
3002	1.79	.32	.79	.68	.60	.17	.74	.20	2	3.0	Air	12.7	2	3.0	Air	12.7	
3002	1.64	.29	.79	.68	.60	.17	.74	.20	2	3.0	Arg	12.7	2	3.0	Arg	12.7	
<b>TRIPLE LOW-E (e5=.1) CLEAR IG</b>																	
3601	1.81	.32	.67	.57	.46	.24	.70	.18	2	3.0	Air	6.3	2	3.0	Air	6.3	
3602	1.28	.23	.67	.58	.46	.24	.70	.18	2	3.0	Air	12.7	2	3.0	Air	12.7	
3603	1.06	.19	.67	.58	.46	.24	.70	.18	2	3.0	Arg	12.7	2	3.0	Arg	12.7	
<b>TRIPLE LOW-E (e2=e5=.1) CLEAR IG</b>																	
3621	1.55	.27	.54	.47	.36	.29	.66	.17	400	3.0	Air	6.3	2	3.0	Air	6.3	
3622	.99	.17	.55	.47	.36	.29	.66	.17	400	3.0	Air	12.7	2	3.0	Air	12.7	
3623	.77	.14	.55	.47	.36	.29	.66	.17	400	3.0	Arg	12.7	2	3.0	Arg	12.7	
<b>TRIPLE LOW-E FILM (88) CLEAR IG</b>																	
3641	1.83	.32	.66	.57	.48	.28	.71	.18	2	3.0	Air	6.3	600	0.1	Air	6.3	
3642	1.32	.23	.67	.57	.48	.28	.71	.18	2	3.0	Air	12.7	600	0.1	Air	12.7	
<b>TRIPLE LOW-E FILM (77) CLEAR IG</b>																	
3651	1.79	.32	.53	.46	.38	.38	.64	.24	2	3.0	Air	6.3	601	0.1	Air	6.3	
3652	1.26	.22	.54	.47	.38	.38	.64	.24	2	3.0	Air	12.7	601	0.1	Air	12.7	
<b>TRIPLE LOW-E FILM (66) CLEAR IG</b>																	
3661	1.75	.31	.41	.35	.26	.40	.54	.31	3	6.0	Air	6.3	602	0.1	Air	6.3	
3662	1.23	.22	.42	.36	.26	.40	.54	.31	3	6.0	Air	12.7	602	0.1	Air	12.7	
<b>TRIPLE LOW-E FILM (66) TINT IG</b>																	
3663	1.75	.31	.30	.26	.16	.18	.32	.14	6	6.0	Air	6.3	602	0.1	Air	6.3	
3664	1.23	.22	.29	.25	.16	.18	.32	.14	6	6.0	Air	12.7	602	0.1	Air	12.7	
<b>TRIPLE LOW-E FILM (55) CLEAR IG</b>																	
3671	1.74	.31	.35	.30	.21	.44	.45	.37	3	6.0	Air	6.3	603	0.1	Air	6.3	
3672	1.22	.22	.36	.31	.21	.44	.45	.37	3	6.0	Air	12.7	603	0.1	Air	12.7	
<b>TRIPLE LOW-E FILM (55) TINT IG</b>																	
3673	1.74	.31	.26	.23	.13	.19	.27	.16	6	6.0	Air	6.3	603	0.1	Air	6.3	
3674	1.22	.22	.25	.22	.13	.19	.27	.16	6	6.0	Air	12.7	603	0.1	Air	12.7	
<b>TRIPLE LOW-E FILM (44) TINT IG</b>																	
3681	1.74	.31	.23	.20	.10	.21	.22	.18	6	6.0	Air	6.3	604	0.1	Air	6.3	
3682	1.21	.21	.22	.19	.10	.21	.22	.18	6	6.0	Air	12.7	604	0.1	Air	12.7	
<b>TRIPLE LOW-E FILM (33) TINT IG</b>																	
3691	1.74	.31	.19	.16	.07	.23	.17	.23	6	6.0	Air	6.3	605	0.1	Air	6.3	
3692	1.20	.21	.17	.15	.07	.23	.17	.23	6	6.0	Air	12.7	605	0.1	Air	12.7	
<b>QUAD LOW-E GLAZING / LOW-E FILMS CLEAR IG</b>																	
4651	.66	.12	.52	.45	.34	.34	.62	.21	2	3.0	Kry	7.9	600	0.1	Kry	3.2	
										LAY3		GAP3		LAY4			
										ID	WID	GAS	WID	ID	WID		
										600	0.1	Kry	7.9	2	3.0		

DOE2.1E WINDOW LIBRARY  
ALL WINDOWS

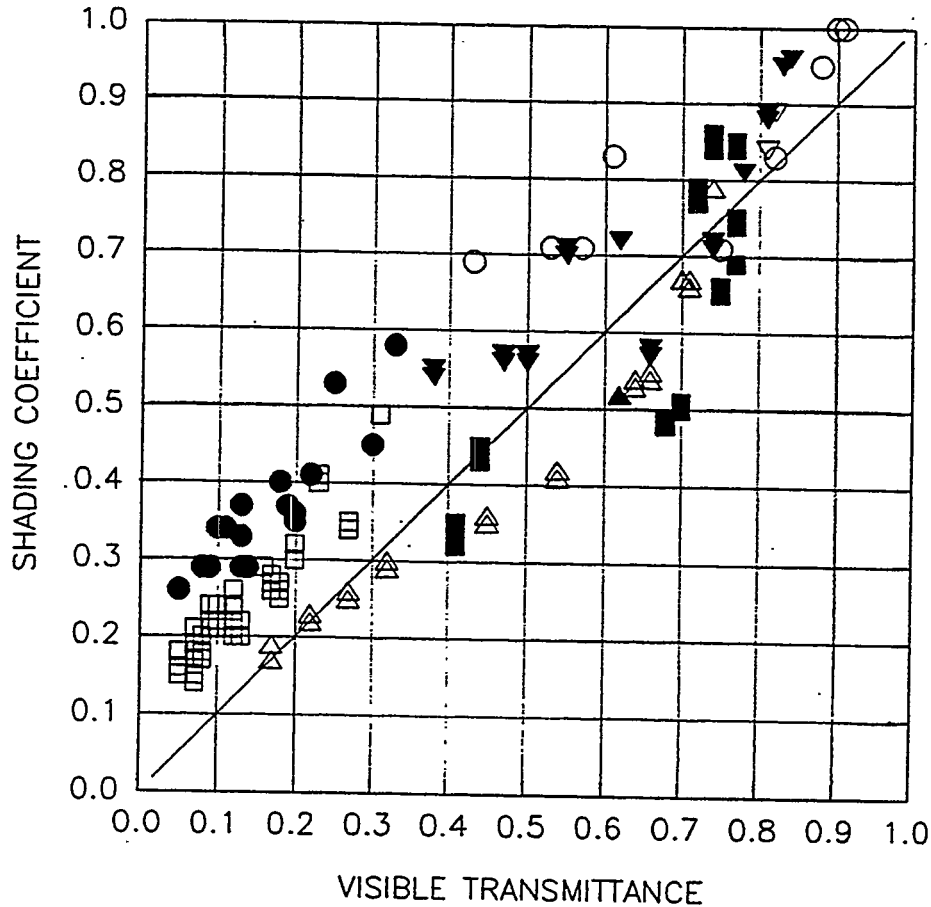

- | SINGLE |                      | DOUBLE |                      | OTHER |                    |
|--------|----------------------|--------|----------------------|-------|--------------------|
| ○      | CLR/TINT (1000-1206) | ▼      | CLR/TINT (2000-2220) | △     | TRIPLE (3001-3692) |
| ●      | REF (1400-1418)      | □      | REF (2400-2472)      | ▲     | QUAD (4651)        |
| ▽      | LOW-E (1600-1602)    | ■      | LOW-E (2600-2668)    |       |                    |

**Figure 2.21:** Center-of-glass shading coefficient (ASHRAE summer conditions) vs. visible transmittance for all glazings in the Window Library except the electrochromic glazings. The values shown correspond to SC and T<sub>vis</sub>, respectively, in the Index to the Window Library, Table 2.12. CLR/TINT is clear or tinted glass. REF is glass with a reflective coating. LOW-E is glass with a low-emissivity coating. SINGLE, DOUBLE, TRIPLE and QUAD refer to the number of panes. Numbers in parentheses give the G-T-C range from Table 2.12.

DOE2.1E WINDOW LIBRARY  
ALL WINDOWS

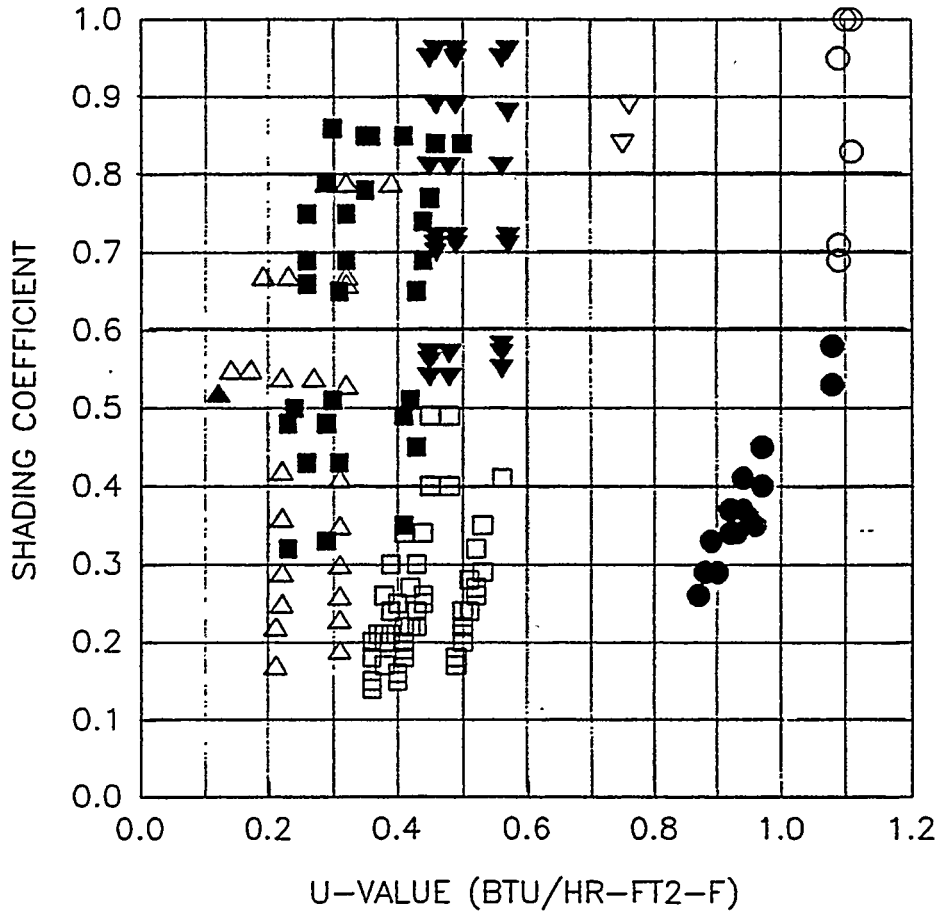

- | SINGLE |                      | DOUBLE |                      | OTHER |                    |
|--------|----------------------|--------|----------------------|-------|--------------------|
| ○      | CLR/TINT (1000-1206) | ▼      | CLR/TINT (2000-2220) | △     | TRIPLE (3001-3692) |
| ●      | REF (1400-1418)      | □      | REF (2400-2472)      | ▲     | QUAD (4651)        |
| ▽      | LOW-E (1600-1602)    | ■      | LOW-E (2600-2668)    |       |                    |

**Figure 2.22:** Center-of-glass shading coefficient (ASHRAE summer conditions) vs. center-of-glass U-value (ASHRAE winter conditions) for all glazings in the Window Library except the electrochromic glazings. The values shown correspond to SC and U-IP, respectively, in the Index to the Window Library, Table 2.12. CLR/TINT is clear or tinted glass; REF is glass with a reflective coating. LOW-E is glass with a low-emissivity coating. SINGLE, DOUBLE, TRIPLE and QUAD refer to the number of panes. Numbers in parentheses give the G-T-C range from Table 2.12.



### Printing Window Library Entries

A printout of the contents of the selected entry can be obtained as part of the DOE-2 input echo by entering

DIAGNOSTIC COMMENTS ..

in the line just before the GLASS-TYPE instruction. This printout can be used to verify that the selected entry is what you really want. See Appendix E for a sample printout. Detailed print can be turned off by entering

DIAGNOSTIC WARNINGS

or

DIAGNOSTIC ERRORS

after the GLASS-TYPE instruction.

### Creating Custom Windows

You can add your own custom windows to the Window Library. To do this, layer-by-layer glass characteristics are entered in the WINDOW-4 computer program.\* Running WINDOW-4 then produces an ASCII output file that you can append to the DOE-2 Window Library file, which is called W4LIB.DAT. Alternatively, you can replace the regular W4LIB.DAT library with your own custom library, which should also be called W4LIB.DAT.

The GLASS-TYPE-CODE value for a custom window should not be the same as that of an existing entry in Table 2.12. We therefore suggest using the following ranges for custom windows:

1900-1999 for single glazing,

2900-2999 for double glazing,

3900-3999 for triple glazing,

4900-4999 for quadruple glazing, and

5900-5999 for quintuple glazing (the maximum number of solid layers allowed is five).

### Using Shading Devices with Windows from the Window Library

The effect of shading devices like blinds and drapes can be modeled for glazing from the Window Library by using the WINDOW keywords SHADING-SCHEDULE, CONDUCT-SCHEDULE, VIS-TRANS-SCH, etc. (see *Reference Manual (2.1A)*, p.III.107, and Table 2.4, "Window Shading Device Control Options," on p.2.51).

---

\* See "WINDOW 4.0: Program Description", Lawrence Berkeley Laboratory report no. LBL-32091, 1992. For information on how to obtain WINDOW-4, contact the Windows and Daylighting Group, 90-3111, Lawrence Berkeley Laboratory, Berkeley, CA 94720 (phone 510-486-6845 or FAX 510-486-4089)

**Example:**

A window with argon-filled, low-E insulating glass (GLASS-TYPE-CODE = 2635) has light-colored drapes deployed in the summer that reduce the shading coefficient of the glass by 40% and have negligible effect on the conductance of the glass:

```

$ -- DRAPES    ON    GLAZING    FROM    WINDOW    LIBRARY -- $

SH-SCH-1 = SCHEDULE THRU MAY 31 (ALL)(1,24)(1.0)
          THRU OCT  31 (ALL)(1,24)(0.6)
          THRU DEC  31 (ALL)(1,24)(1.0) ..

GT-1     = GLASS-TYPE
          GLASS-TYPE-CODE = 2635 ..

WIN-1    = WINDOW.
          HEIGHT           = 5
          WIDTH            = 10
          GLASS-TYPE       = GT-1
          SHADING-SCHEDULE = SH-SCH-1 ..
```

In this example, the multiplier, 0.6, is the ratio of the shading coefficient of the glass with drapes present (a number that can usually be obtained from the glass manufacturer's data sheets) to the shading coefficient of the bare glass (which can be obtained from the glass manufacturer's data sheets or from Table 2.12).

Note that the window HEIGHT and WIDTH must be input; the window dimensions from the library are *not* used.

**Edge-of-Glass Effects**

Because of two-dimensional heat conduction effects in multipane windows, the U-value of the edge-of-glass region (a 2.5-in wide border strip at the boundary of the glazing) differs from the U-value in the center-of-the-glass region (the central part of the glazing). The edge-of-glass U-value depends on the center-of-glass U-value and the type of spacer used to separate the panes. For windows from the Window Library, the spacer type is specified using the following GLASS-TYPE keyword:

**GLASS-TYPE**

SPACER-TYPE-CODE

is an integer indicating the type of spacer used to separate the glass layers in multipane windows. It is applicable only to *multipane* windows (GLASS-TYPE-CODE = 2000 or above) from the Window Library. Allowed values are shown in Table 2.13. The default is 1 (aluminum spacer). If SPACER-TYPE-CODE = 0, spacer information is obtained from the Window Library entry corresponding to the specified GLASS-TYPE-CODE.

**Table 2.13**  
**Between-Glass Spacers**

SPACER- TYPE- CODE	Spacer type
0	Spacer is taken from the Window Library
1(default)	Aluminum
2	Stainless steel (dual seal)
3	Butyl/Metal (also fiberglass, wood, or glass edge)
4	Insulated (a hypothetical insulating material with conductivity = 0.017 Btu/h-ft-°F)
5	U-edge = U-center-of-glass

**Improved Glass Conduction Calculation**

The conduction calculation for glazings from the Window Library will be a few percent more accurate if you specify the GLASS-TYPE keyword CONVERGENCE-TOL (in °C for both metric *and* English runs). This invokes a time-consuming iterative calculation that converges when, for each glass layer, the temperature difference between successive iterations is less than CONVERGENCE-TOL. Because of the increase in calculation time, CONVERGENCE-TOL should only be used for research applications. If CONVERGENCE-TOL is not specified, the glazing U-value is based on glass layer temperatures that are equally spaced between the outside and inside air temperature.

## WINDOW FRAMES

### Introduction

In versions of DOE-2 previous to 2.1E, heat conduction through the frame of a window could not easily be modeled. It was necessary to include frame effects, if important, by adjusting the U-value and shading coefficient of the glazing or by entering the frame as a separate exterior wall. In DOE-2.1E, frames can be explicitly defined. However, we recommend that frames be entered only if the frame area is more than 10% or so of the glazed area, which is generally the case only in residential applications.

To define a window frame you enter the width of the frame in the WINDOW command and the conductance and solar absorptance of the frame in the GLASS-TYPE command.

### WINDOW

#### HEIGHT

is the height of the glazed portion of the window.

#### WIDTH

is the width of the glazed portion of the window.

#### FRAME-WIDTH

is the projected width of the frame in the plane of the glazing (see Fig. 2.23); default is 0.0 ft.

SRG-9202

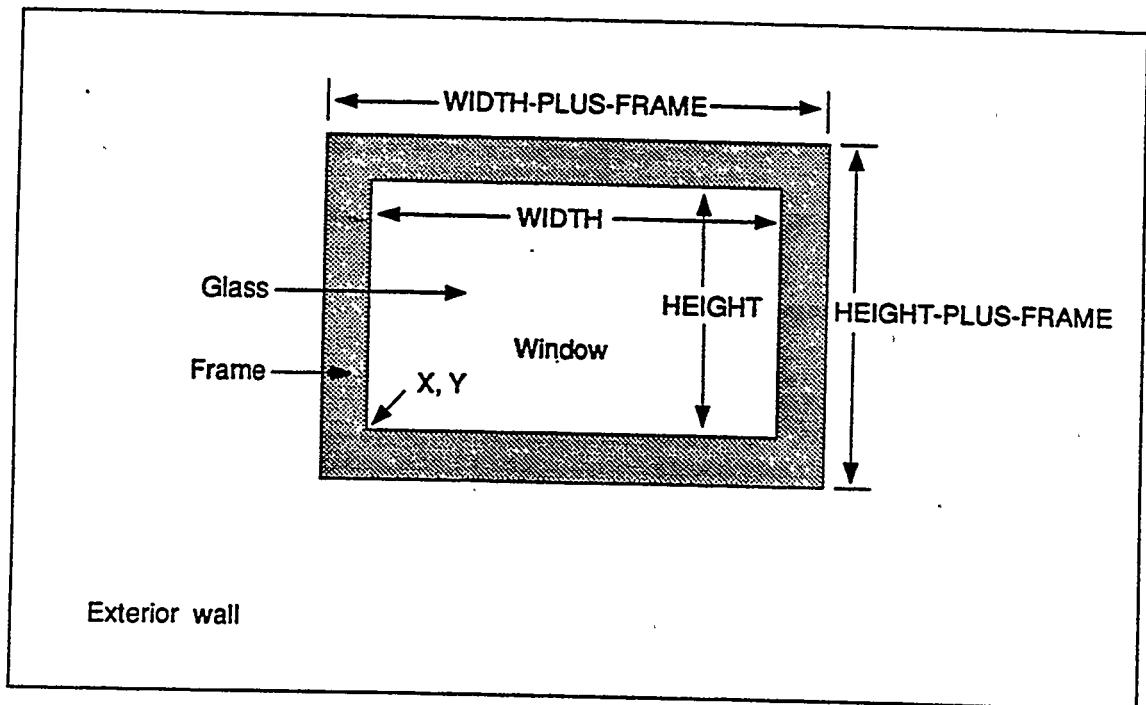

Figure 2.23: The dimensioning of a window with a frame. The WINDOW keywords X and Y, which indicate the position of the window on the wall, refer to the lower left corner of the glazed portion, *not* the lower left corner of the frame.

## GLASS-TYPE

### FRAME-ABS

is the solar absorptance of the outside surface of the frame. The default is 0.7 and the range is 0.0 to 1.0.

### FRAME-CONDUCTANCE

is the conductance of the frame, *excluding* the outside air film but including the inside air film. The range is 0 to 10 Btu/ft<sup>2</sup>-F-h. Values for typical frame constructions are shown in Table 2.14.\* If SHADING-COEF or GLASS-TYPE-CODE  $\leq 11$  is specified, the default for FRAME-CONDUCTANCE is 0.434 Btu/ft<sup>2</sup>-F-h (wood with or without cladding). For a window from the Window Library (GLASS-TYPE-CODE  $\geq 1000$ ), the default is obtained from the library entry for that window.

Frame Type	FRAME- CONDUCTANCE (excludes OA film)	U-value** (includes OA film at 15mph windspeed)
Thermally unbroken aluminum	3.037	1.90
Thermally broken aluminum	1.245	1.00
External flush glazed aluminum	0.812	0.70
Wood with or without cladding	0.434	0.40
Vinyl	0.319	0.30

\*\* FRAME-CONDUCTANCE =  $[(U\text{-value})^{-1} - 0.197]^{-1}$

#### Notes:

- (1) In DOE-2, you can define frames only for exterior windows, not for interior windows.
- (2) DOE-2 will do a frame calculation only if you enter FRAME-WIDTH. Otherwise, the frame area will be zero. The frame dimensions in the Window Library are *not* used.
- (3) DOE-2 automatically removes the overall window area, including frame, from the associated exterior wall area.
- (4) The conductances in Table 2.14 are effective values that take two-dimensional conduction effects into account.
- (5) Each hour, DOE-2 adds the effect of a wind-speed-dependent outside air film to the user-specified FRAME-CONDUCTANCE.

\* You can determine the frame conductance for arbitrary frame configurations by using the FRAME program, available from the National Fenestration Rating Council (201-589-NFRC).

- (6) If a window has dividers (such as mullions or muntins), then HEIGHT, WIDTH, and FRAME-WIDTH should be chosen so that:
- $$(\text{HEIGHT}) \times (\text{WIDTH}) = \text{total area of glazed parts of window;}$$
- and
- $$[\text{HEIGHT} + 2 \times (\text{FRAME-WIDTH})] \times [\text{WIDTH} + 2 \times (\text{FRAME-WIDTH})] - (\text{HEIGHT}) \times (\text{WIDTH}) = \text{total area of frame (perimeter plus dividers).}$$
- (7) The various elements of a frame (top, bottom, side, dividers, etc.) may have different conductances. In this case, FRAME-CONDUCTANCE should be an area-weighted average of the different elements.
- (8) The frame conductance in the Window Library is in SI units ( $\text{W}/\text{m}^2\text{-K}$ ) and includes an outside air film at 15 mph windspeed. Before using this value, DOE-2 converts it to IP units ( $\text{Btu}/\text{ft}^2\text{-F-h}$ ) and removes an outside air film resistance of  $0.197 (\text{Btu}/\text{ft}^2\text{-F-h})^{-1}$ .
- (9) DOE-2 finds the overall window conduction by adding frame, edge-of-glass, and center-of-glass contributions. Thus, all three of these contributions are included in each of the following report quantities:
- (1) "Window Conduction" in summary reports LS-B, LS-C, LS-E, and LS-F;
  - (2) "Window U-value" and "Window Area" in verification report LV-D;
  - (3) WINDOW hourly report variable #1, "Window U-value".
- (10) A window MULTIPLIER also multiplies the frame.
- (11) Window fins and overhangs shade the frame as well as the glazing.
- (12) Shading devices, like blinds and drapes, that you specify using the WINDOW keywords SHADING-SCHEDULE and CONDUCT-SCHEDULE, affect only the glazed part of the window; they do *not* affect the heat conduction through the frame.

**Example:**

The glazed part of a window is 3 ft wide and 4 ft high. The glazing is double-pane low-E with 6-mm glass thickness and argon gas fill (GLASS-TYPE-CODE = 2635). The wood frame is 3 in (0.25 ft) wide on all sides and has an absorptivity of 0.8. The spacer separating the glass panes is aluminum.

\$ -- WINDOW WITH FRAME -- \$

GT-1 = GLASS-TYPE	GLASS-TYPE-CODE	= 2635
	SPACER-TYPE-CODE	= 1
	FRAME-ABS	= 0.8
	FRAME-CONDUCTANCE	= 0.434 ..
WIN-1 = WINDOW	GLASS-TYPE	= GT-1
	HEIGHT	= 4.0
	WIDTH	= 3.0
	FRAME-WIDTH	= 0.25 ..

## SWITCHABLE GLAZING

### Introduction

A model has been added in DOE-2.1E for switchable glazing.\* This is glazing whose solar-optical properties, such as transmittance, change according to environmental conditions. An example is electrochromic glass that can be switched from a bleached state to a colored state of lower transmittance by changing the applied voltage in response to a control variable such as outside temperature or solar radiation. Switchable glazing has the potential for a higher level of solar gain control than is possible with conventional glazing having fixed solar-optical properties.

To model switchable glazing you enter the glass type for the unswitched state, the glass type for the fully switched state, the control variable, the switching set points, and a schedule that tells when switching is allowed. Figure 2.24 shows the control action that DOE-2 uses for all control options except SWITCH-CONTROL = DAYLIGHT-LEVEL.

If the value of the control variable is less than SWITCH-SET-LO, the glass is in the *unswitched* state, with solar-optical properties given by GLASS-TYPE. If the control variable is greater than SWITCH-SET-HI, the glass is in the *fully switched* state, with solar-optical properties given by GLASS-TYPE-SW. If the control variable is between SWITCH-SET-LO and SWITCH-SET-HI, the glass is in a *partially switched* state, with solar-optical properties given by a weighted average of GLASS-TYPE and GLASS-TYPE-SW. For example, if  $T_1$  and  $T_2$  are the direct solar transmittances for GLASS-TYPE and GLASS-TYPE-SW, respectively, and  $V$  is the value of the control variable in a particular hour, then the resultant transmittance is  $T = T_1 * (1-S) + T_2 * S$ , where  $S$ , the "switching factor", is given by:

$$S = 0.0, \text{ if } V \leq \text{SWITCH-SET-LO}$$

$$S = \frac{V - (\text{SWITCH-SET-LO})}{(\text{SWITCH-SET-HI}) - (\text{SWITCH-SET-LO})}$$

if  $(\text{SWITCH-SET-LO}) < V < (\text{SWITCH-SET-HI})$

$$S = 1.0, \text{ if } V \geq \text{SWITCH-SET-HI}$$

Thus,  $S$  varies from 0.0 for the unswitched state to 1.0 for the fully-switched state. If the low and high switching points are equal (i.e., SWITCH-SET-LO = SWITCH-SET-HIGH), the glass changes from the unswitched state to the fully-switched state with no intermediate, partially-switched states. In this case  $S$  has only two values, 0.0 or 1.0.

Hourly values of  $S$  for each window are printed by hourly report VARIABLE-TYPE = u-name of WINDOW, Variable-List Number 18.

---

\* Integration of switchable glazing routines into DOE-2 was supported in part by the Solar Heating and Cooling Program of the International Energy Agency.

For daylit spaces, a different type of control scheme can be used by specifying SWITCH-CONTROL = DAYLIGHT-LEVEL. In this case, the visible transmittance of the window is modulated between unswitched and fully switched values in order to provide daylight illuminance that is as close as possible to the illuminance setpoint at the first reference point. This type of control is a way of avoiding unwanted solar gain during the cooling season.

SRG-92-01

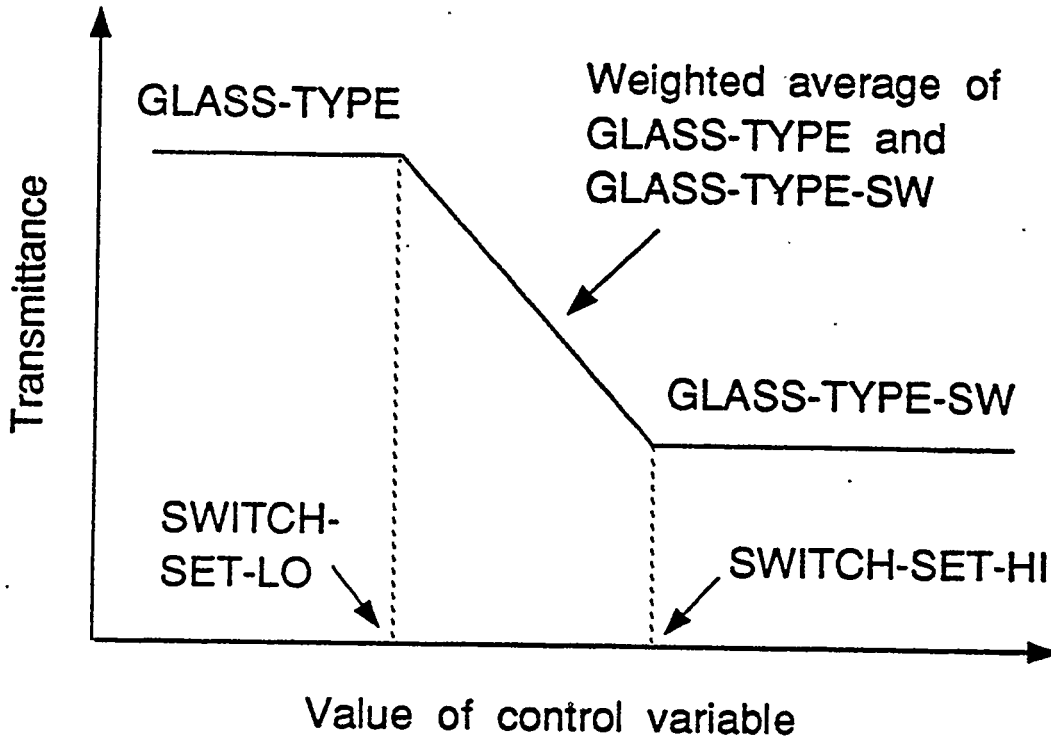

Figure 2.24: Control action for switchable glazing. Glass properties, such as solar and visible transmittance, depend on the value of a user-specified control variable.

WINDOW

**GLASS-TYPE**

accepts the u-name of the glass type for the *unswitched* state. For switchable glazing, glass types *must* be chosen from the Window Library.

These glass types have **GLASS-TYPE-CODE**  $\geq 1000$  (see WINDOW LIBRARY, p.2.98).

**GLASS-TYPE-SW**

accepts the u-name of the glass type for the *fully switched* state. For switchable glazing, glass types *must* be chosen from the Window Library. These glass types have **GLASS-TYPE-CODE**  $\geq 1000$  (see WINDOW LIBRARY). An error will result if the number of glass layers is different for **GLASS-TYPE** and **GLASS-TYPE-SW**.

In the left column above, bold-faced words are commands, non-bold words are keywords, and italicized words are code-words.



<b>SWITCH-CONTROL</b>	accepts a code-word that specifies the control variable for switching. The choices are:
<i>NO-SWITCH</i>	No switching (the default).
<i>DIR-SOL-INC</i>	Direct solar incident on the glazing (Btu/h-ft <sup>2</sup> [glass]), after shading by overhangs, setback, neighboring buildings, etc.
<i>TOT-SOL-INC</i>	Total (direct plus diffuse) solar radiation incident on the glazing (Btu/h-ft <sup>2</sup> [glass]), after shading by overhangs, setback, neighboring buildings, etc.
<i>DIR-SOL-TR</i>	Direct solar radiation transmitted by the glazing in the unswitched state (Btu/h-ft <sup>2</sup> [glass]).
<i>TOT-SOL-TR</i>	Total (direct plus diffuse) solar radiation transmitted by the glazing in the unswitched state (Btu/h-ft <sup>2</sup> [glass]).
<i>TOT-SOL-HOR</i>	Total (direct plus diffuse) solar radiation incident on an unobstructed horizontal plane (Btu/h-ft <sup>2</sup> [glass]).
<i>OUTSIDE-TEMP</i>	Outside drybulb temperature (°F).
<i>SPACE-LOAD</i>	Previous-hour thermal load per square foot of floor area for the space that contains the window (Btu/h-ft <sup>2</sup> [floor]). Note that cooling loads in DOE-2 are positive and heating loads are negative. Switching control based on space load should be modeled only if the actual space temperature for hours that the control is in effect is within a few degrees of the LOADS calculation temperature (as given by the TEMPERATURE keyword in SPACE-CONDITIONS).
<i>DAYLIGHT-LEVEL</i>	The visible transmittance of the glazing is adjusted continuously between the values corresponding to the WINDOW keywords GLASS-TYPE and GLASS-TYPE-SW in order to provide a daylight illuminance that is as close as possible to the illuminance setpoint at the first daylighting reference point. The solar properties of the glazing are adjusted accordingly. For this control option, the visible transmittance (at normal incidence) for GLASS-TYPE should be greater than that for GLASS-TYPE-SW, otherwise an error message will result.
<b>SWITCH-SET-LO</b>	is the lower setpoint value for the control variable (see Fig. 2.24). Unused if SWITCH-CONTROL = DAYLIGHT-LEVEL.
<b>SWITCH-SET-HI</b>	is the upper setpoint value for the control variable (see Fig. 2.24). Unused if SWITCH-CONTROL = DAYLIGHT-LEVEL.

In the left column above, bold-faced words are commands, non-bold words are keywords, and italicized words are code-words.

SWITCH-SET-HI should be  $\geq$  SWITCH-SET-LO.

The units for SWITCH-SET-LO and SWITCH-SET-HI are determined by the code-word you assigned to SWITCH-CONTROL. For example, if SWITCH-CONTROL=TOT-SOL-INC, the unit is Btu/ft<sup>2</sup>-h. *Even in metric runs, English units should be used.*

#### SWITCH-SCH

accepts the u-name of a schedule the specifies when switching is allowed (schedule value = 1) and not allowed (schedule value = 0). This schedule allows switching to be disabled at times of the day or year when it might be disadvantageous. If SWITCH-SCH is not entered, the program will assume that switching is allowed all the time.

#### Notes:

- (1) If there is more than one window in a space, some may have switching control and others not. For example, skylights might be controlled and view windows not. Also, multiple windows in a space can have different control types.
- (2) Switching control is applicable only to exterior windows (windows in EXTERIOR-WALLs). It does not work for interior windows.
- (3) Switching control is in effect only during sun-up hours. It does not work at night. It should not be used to switch between window U-values; use the WINDOW keyword CONDUCT-TMIN-SCH instead.
- (4) Shading devices such as blinds and drapes (as specified with WINDOW keywords SHADING-SCHEDULE, VIS-TRANS-SCH, etc.) can be used in conjunction with switching control of the glazing. In this case, the program decides what state the glazing should be switched to, ignoring the possible presence of shading devices, and then adjusts the solar intensity through the switched glazing for the presence of the shading device. For example, if MAX-SOLAR-SCH is used to deploy a shading device when the transmitted direct solar gain exceeds a trigger value, the program will first apply the switching control to the glazing and then calculate the transmitted solar intensity based on the solar properties of the switched glass.

See "Switchable Glazing Examples", p.2.125, for sample inputs.

### Electrochromic Switchable Glazings

The Window Library contains electrochromic glazing entries that can be used for switchable glazing simulation.\* When a voltage is applied, electrochromics switch continuously from a clear, or "bleached", state to a colored state of lower transmittance. The variation in transmittance is determined by DOE-2 according to the control action for switchable glazing shown in Fig. 2.24.

The electrochromics in the library are called "absorbing" or "reflecting". For absorbing electrochromics, the near-IR absorptance increases in the colored state. For reflecting electrochromics, the near-IR reflectance increases in the colored state. Reflecting electrochromics have a somewhat lower shading coefficient for a given visible transmittance and so may perform better in daylighting applications in cooling-dominated buildings.

The electrochromic entries are as follows:

#### GLASS-TYPE-CODE

Range	Description
1800-1801	Single-pane absorbing electrochromic
1802-1803	Single-pane reflecting electrochromic
2800-2805	Double-pane absorbing electrochromic
2820-2825	Double-pane reflecting electrochromic
2840-2845	Double-pane absorbing electrochromic, low-E
2860-2865	Double-pane reflecting electrochromic, low-E

For the single-pane cases, the electrochromic layer is sandwiched between two 3mm clear glass layers. For the double-pane cases, the electrochromic layer is on surface 2, i.e. on the gap side of the outer pane. For the double-pane low-E cases, the low-E coating is on surface 3, i.e. on the gap side of the inner pane. For the double-pane cases you can choose gap widths of 6.3mm (air fill) or 12.7mm (air or argon fill).

A more detailed list of the electrochromic entries can be found in the "Index to the Window Library", Table 2.12. A graphical overview of electrochromic glazings in the library is shown in Fig. 2.25.

The electrochromic entries in the Window Library are in pairs, such as (1800,1801), (1802,1803), etc.; the first member of the pair is the unswitched, bleached state and the second member is the fully-switched, colored state. For electrochromic switchable glazing simulation, GLASS-TYPE and GLASS-TYPE-SW must correspond to one of these pairs; for example, the following would be an acceptable input using the 1800 and 1801 pair:

\* Electrochromics are still in the experimental stage. The electrochromic glazings in the Window Library are generic; they are representative of products that were under development at the time of this writing (December 1992). The electrochromic entries were generated with WINDOW-4 by D. Hopkins and E. Finlayson of the LBL Windows and Daylighting Group using spectral transmittance and reflectance data. These data were compiled by M. Rubin of LBL from measurements on actual electrochromics from LBL and other research organizations.

EC-1 = GLASS-TYPE  
GLASS-TYPE-CODE = 1800 .. \$ Single-pane absorbing electrochromic, bleached

EC-2 = GLASS-TYPE  
GLASS-TYPE-CODE = 1801 .. \$ Single-pane absorbing electrochromic, colored

WIN-1 = WINDOW  
...  
GLASS-TYPE = EC-1  
GLASS-TYPE-SW = EC-2  
SWITCH-CONTROL = TOT-SOL-INC  
SWITCH-SET-LO = 20  
SWITCH-SET-HI = 100 ..

You will get an error message if the GLASS-TYPE and GLASS-TYPE-SW values for a window are not a legal pair. For example using 1803 instead of 1801 in the above example would give an error message because 1800 and 1803 are not a legal electrochromic pair.

Switchable glazing Example (2) shows a more complete switchable glazing input using electrochromics from the Window Library.

## DOE-2.1E WINDOW LIBRARY ELECTROCHROMIC GLAZINGS

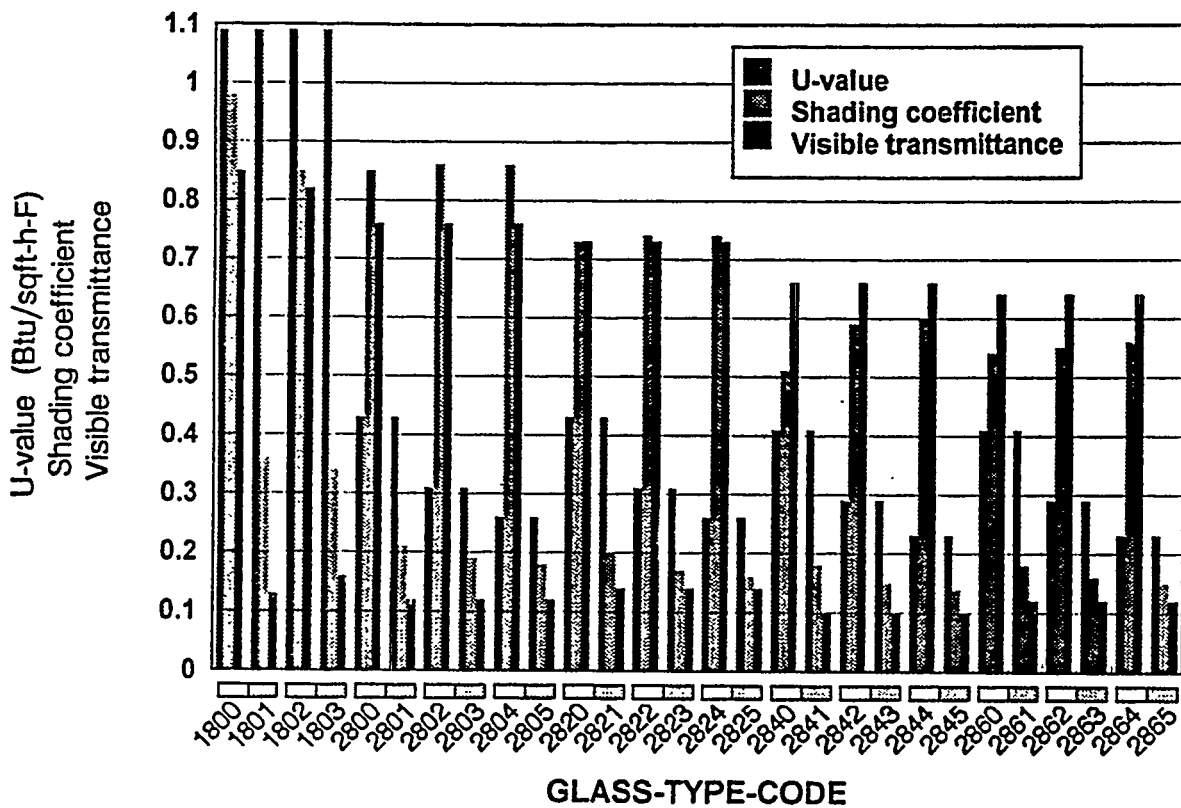

**Figure 2.25:** DOE-2.1E Window Library Electrochromic Glazings  
 U-value (ASHRAE winter conditions), shading coefficient (ASHRAE summer conditions), and visible transmittance for the electrochromic glazings in the Window Library. The values shown correspond to U-IP, SC, and Tvis, respectively, in the Index to the Window Library, Table 2.12.  
 For each GLASS-TYPE-CODE pair, such as (1800,1801), the left-hand group of three bars corresponds to the unswitched, bleached state and the right-hand group corresponds to the fully-switched colored state.

## Switchable Glazing Examples

### Example (1): Switching controlled by incident solar radiation

During the summer, the outer pane of insulating glass switches from clear to fully tinted over a range of 20 to 100 Btu/ft<sup>2</sup>-h of incident solar radiation.

\$ SWITCHING CONTROLLED BY INCIDENT SOLAR DURING THE SUMMER \$

CLEAR-IG-1 = GLASS-TYPE

GLASS-TYPE-CODE = 2003 .. \$ SC=0.81 \$

TINTED-IG-1 = GLASS-TYPE

GLASS-TYPE-CODE = 2203 .. \$ SC=0.81 \$

SUMMER-1 = SCHEDULE THRU MAY 31 (ALL)(1,24)(0) \$ no switching \$  
THRU SEP 30 (ALL)(1,24)(1) \$ switching ok \$  
THRU DEC 31 (ALL)(1,24)(0) \$ no switching \$ ..

WIN-1 = WINDOW

GLASS-TYPE = CLEAR-IG-1

GLASS-TYPE-SW = TINTED-IG-1

SWITCH-CONTROL = TOT-SOL-INC

SWITCH-SET-LO = 20

SWITCH-SET-HI = 100

SWITCH-SCH = SUMMER-1

.  
.  
..

**Example (2): Electrochromic glazing**

For an electrochromic window in a daylight space, the visible transmittance is adjusted to a value between 0.73 and 0.14 during the summer so that the resulting daylight illuminance is as close as possible to the illuminance setpoint. At other times of the year, the switching does not occur.

```
$ -- ELECTROCHROMIC GLAZING CONTROLLED BY DAYLIGHT ILLUMINANCE -  
SUMMERONLY-1 = SCHEDULE THRU MAY 31 (ALL)(1,24)(0) $ no switch $  
                THRU SEP 30 (ALL)(1,24)(1) $ switching ok $  
                THRU DEC 31 (ALL)(1,24)(0) $ no switch $ ..  
BLEACHED-EC   = GLASS-TYPE  
                GLASS-TYPE-CODE = 2820 .. $ Tvis=.73 $  
COLORED-EC    = GLASS-TYPE  
                GLASS-TYPE-CODE = 2821 .. $ Tvis=.14 $  
WIN-2         = WINDOW  
                GLASS-TYPE       = BLEACHED-EC  
                GLASS-TYPE-SW    = COLORED-EC  
                SWITCH-CONTROL   = DAYLIGHT-LEVEL  
                SWITCH-SCH       = SUMMERONLY-1  
                .  
                .  
                . ..
```

**Example (3): Switching controlled by space load**

The glazing switches from clear (shading coefficient = 0.81) to reflective (shading coefficient = 0.17) when the space has a cooling load the previous hour (i.e., when the previous-hour space load is greater than zero).

```
$ --- SWITCHING CONTROLLED BY SPACE LOAD ALL YEAR --- $  
CLEAR-IG-1 = GLASS-TYPE  
            GLASS-TYPE-CODE = 2003 .. $ SC=.81 $  
REFL-IG-1  = GLASS-TYPE  
            GLASS-TYPE-CODE = 2400 .. $ SC=.17 $  
ALLYEAR-1  = SCHEDULE THRU DEC 31 (ALL)(1,24)(1) ..  
WIN-3      = WINDOW  
            GLASS-TYPE       = CLEAR-IG-1  
            GLASS-TYPE-SW    = REFL-IG-1  
            SWITCH-CONTROL   = SPACE-LOAD  
            SWITCH-SET-LO    = 0  
            SWITCH-SET-HI    = 0  
            SWITCH-SCH       = ALLYEAR-1  
            .  
            .  
            . ..
```

# S Y S T E M S

## Table of Contents

---

<b>ENERGY END USES AND METERS</b> .....	3. 4
Metering and Reporting of Energy End Uses .....	3. 4
Electricity End Uses .....	3. 4
Fuel End Uses.....	3. 7
Electrical and Fuel Meters in LOADS .....	3. 8
Electrical and Fuel Meters in SYSTEMS .....	3. 8
Specifying Meters in SYSTEMS.....	3. 8
Example 1: Gas Cooling Rate.....	3. 11
Example 2: Electric Lighting Rate.....	3. 12
Building Resources in SYSTEMS.....	3. 13
<b>POWERED INDUCTION UNIT (PIU)</b> .....	3. 16
Introduction .....	3. 16
Input for PIU .....	3. 18
<b>PACKAGED VARIABLE VOLUME, VARIABLE TEMPERATURE SYSTEM (PVVT)</b> .....	3. 22
Introduction .....	3. 22
<b>RESIDENTIAL VARIABLE VOLUME, VARIABLE TEMPERATURE SYSTEM (RESVVT)</b> .....	3. 23
Overview .....	3. 23
Input for RESVVT .....	3. 24
SYSTEM-EQUIPMENT Curve Defaults.....	3. 25
<b>AIR SOURCE HEAT PUMP ENHANCEMENTS</b> .....	3. 26
Introduction .....	3. 26
Report Changes for the Air/Air Heat Pump Simulation.....	3. 28
<b>WATER LOOP HEAT PUMP SYSTEM (HP) ENHANCEMENTS</b> .....	3. 29
Introduction .....	3. 29
Description of All Air/Air Heat Pump Keywords .....	3. 33
<b>VARIABLE SPEED ELECTRIC HEAT PUMP</b> .....	3. 43
Introduction .....	3. 43
Input .....	3. 44
Electric Heat Pump Heat Recovery.....	3. 46
Fans .....	3. 47
Notes:.....	3. 47
<b>GAS HEAT PUMPS</b> .....	3. 48
Introduction .....	3. 48
Description of Gas Heat Pump Systems.....	3. 48
How to Specify a Gas Heat Pump .....	3. 49
Supplemental Heating for the Gas Heat Pump .....	3. 51
Gas Heat Pump Electrical Consumption .....	3. 52
Gas Heat Pump Waste Heat Recovery.....	3. 53
Gas Heat Pump Examples.....	3. 55



MISCELLANEOUS CHANGES TO SOME SYSTEM KEYWORDS.....	3. 56
DOMESTIC HOT WATER HEATER AND TANK MODEL IN SYSTEMS.....	3. 57
Introduction .....	3. 57
Default Sizing.....	3. 59
Waste Heat Use .....	3. 59
Simulation Strategy.....	3. 60
Curves.....	3. 61
SERVICE HOT WATER HEAT PUMPS.....	3. 62
Hourly Report Variables.....	3. 63
EVAPORATIVE COOLING.....	3. 64
Introduction .....	3. 64
Stand Alone Evaporative Cooler .....	3. 64
Add-On Evaporative Cooling.....	3. 66
Residential Direct Evaporative Cooler .....	3. 70
PACKAGED TOTAL-GAS SOLID-DESICCANT SYSTEM (PTGSD).....	3. 72
Introduction .....	3. 72
ADD-ON (INTEGRATED) DESICCANT COOLING.....	3. 76
Introduction .....	3. 76
Control of Integrated Desiccant Cooling Units .....	3. 78
Control of Solid Desiccant Unit .....	3. 80
WATER COOLED CONDENSER OPTION FOR PACKAGED UNITS PSZ, PVAVS AND PVVT.....	3. 83
Introduction .....	3. 83
Example Input.....	3. 93
EVAPORATIVE PRECOOLER FOR AIR-COOLED DIRECT- EXPANSION UNITS.....	3. 95
Introduction .....	3. 95
OUTSIDE AIR ECONOMIZER CONTROL.....	3. 97
Examples.....	3.100
OPTIMUM FAN START.....	3.101
Rules .....	3.101
Cautions.....	3.102
HEAT RECOVERY FROM REFRIGERATED CASE WORK.....	3.103
Introduction .....	3.103
Example .....	3.109
Reporting .....	3.111
NIGHT VENTILATION.....	3.112
Report Modification.....	3.114
BASEBOARD HEATING IN PLENUMS .....	3.115
ENHANCED MOISTURE BALANCE CALCULATION.....	3.116

<b>VARIOUS CONTROL ENHANCEMENTS</b> .....	3.118
Control of Air Flow Rate to Zones.....	3.119
<b>MIN-CFM-SCH AND OTHER SCHEDULE USES</b> .....	3.121
<b>ENHANCEMENTS TO THE RESIDENTIAL NATURAL VENTILATION ALGORITHM</b> .....	3.122
Discussion.....	3.122
<b>DESIGN-DAY ROUTINES</b> .....	3.124
Introduction .....	3.124
Investigating Design Alternatives using DESIGN-DAY .....	3.126
1) Monday Morning Start-Up .....	3.126
2) Start-Up Following a Holiday .....	3.126
3) Mitigate Monday Morning Start-Up .....	3.126
4) Estimate Building Residual Heat.....	3.127
5) A Series of Hot Days.....	3.127
6) Heat Island Effect .....	3.127
7) Activate Economizer During Design .....	3.127
8) Adjust Packaged Unit size.....	3.127
9) Simulate Equipment Outage.....	3.127
10) Night Setback or Setup.....	3.127
<b>IMPROVEMENTS TO THE COOLING COIL MODEL</b> .....	3.128
<b>SYSTEM SIZING</b> .....	3.130
Introduction .....	3.130
Step by Step Design Procedure for SYSTEMS .....	3.130
Consequences of User Inputs .....	3.134
How Sizing Routines and Run Period Simulations Differ .....	3.136
<b>INDEPENDENT COOLING AND HEATING SIZING RATIOS</b> .....	3.138
<b>ADDITIONS TO SYSTEMS REPORT SS-J</b> .....	3.139
DESIGN-DAY Systems Report .....	3.139
<b>USER-DEFINED CURVE-FIT BOUNDARIES</b> .....	3.140
<b>SYSTEM-EQUIPMENT DEFAULT CURVES</b> .....	3.141

## ENERGY END USES AND METERS

DOE-2.1E incorporates major improvements in the method by which energy is tracked, accounted for, and billed. Electrical and fuel energy consumption now disaggregate into 20 different energy end uses. The end use values are passed along hourly from LOADS to SYSTEMS to PLANT, and each program module contributes to the applicable end use categories.

Multiple energy meters for electricity and fuels disaggregate energy from any or all of the end uses. You can assign up to five different electric meters and up to five different fuel meters in order to achieve a high degree of flexibility in how energy is disaggregated and billed. (For example, the lighting energy in two zones may be directed to two separate meters. The energy consumption of a shared HVAC system and central plant may be directed to another meter.) Meters can be assigned in SYSTEMS at the ZONE, SYSTEM, and PLANT—ASSIGNMENT levels, and in PLANT at the PLANT—EQUIPMENT level.

PLANT report PS—B reports energy usage by meter in the actual units of consumption, such as kWh, therms, or gallons of oil.

### Metering and Reporting of Energy End Uses

For each of the end uses, the following tables give the category name (with the corresponding heading as it appears in summary reports PS—E, PS—F, BEPS, and BEPU shown in square brackets), meter keyword, and description. New PLANT report PS—E (Monthly Energy End Use Summary) gives the monthly energy consumption for these end uses, and PS—F (Energy Resource Peak Breakdown By End Use) shows the monthly peaks. Annual consumption by end use is shown in PLANT reports BEPS (Building Energy Performance Summary) and BEPU (Building Energy Performance Summary - Utility Units). Consumption by end use is also shown in hourly reports for VARIABLE—TYPE=END—USE in LOADS, SYSTEMS, and PLANT (see Appendix A).

### Electricity End Uses

Category	Meter Keyword	Description
Area Lighting	[Area Lights] LIGHT—ELEC—METER	All lighting, except task lighting, defined under the SPACE command in LOADS with the LIGHTING—W/SQFT or LIGHTING—KW keywords.
Task Lighting	[Task Lights] TASK—ELEC—METER	All task lighting defined under the SPACE command in LOADS with the TASK—LT—W/SQFT or TASK—LIGHTING keywords.

The ENERGY END USES AND METERS section was developed by James J. Hirsch and Steven D. Gates, Hirsch & Associates, Camarillo, CA.

## Electricity End Uses (continued)

Category	Meter Keyword	Description
Exterior Lighting	[Ext Lights] EXT-LIGHT-METER	Electrical consumption of exterior lights defined by the new EXT-LIGHT-KW keyword of the PLANT-ASSIGNMENT command.
Equipment	[Misc Equipment] EQUIP-ELEC-METER	All equipment defined under the SPACE command in the keywords EQUIPMENT-W/SQFT or EQUIPMENT-KW. May also include the power defined in the Source category (see below).
Source	[Source Uses] SOURCE-ELEC-METER	All source electric defined by the SPACE keyword SOURCE-BTU/HR, or by the new INT-ELEC-KW keyword in the PLANT-ASSIGNMENT command in SYSTEMS. This category, if not specifically separated by linking to a meter, will be grouped in the Equipment category, above.
Heating	[Space Heat] HEAT-ELEC-METER	All electricity consumption associated with equipment whose primary purpose is heating. This includes the electrical consumption of a gas boiler with an electric draft fan, even if the boiler is used exclusively to power an absorption chiller. This may include supplemental electric resistance heaters in heat pumps defined in the Supplemental category (see below).
Cooling	[Space Cool] COOL-ELEC-METER	All electricity consumption associated with cooling equipment, exclusive of condenser fans, cooling towers, and pumps.
Heat Rejection	[Heat Reject] HTREJ-ELEC-METER	Electrical consumption of condenser fans and cooling towers, including any condenser pumps. This category, if not specifically separated by linking to a meter, will be grouped in the following Auxiliary category.

## Electricity End Uses (continued)

Category	Meter Keyword	Description
Auxiliary	[Pumps & Misc] AUX-ELEC-METER	Electrical consumption of pumps and miscellaneous equipment, including component based TES systems. This category may also include the Heat Rejection category (see above).
Ventilation	[Vent Fans] VENT-ELEC-METER	All electrical consumption of supply, return, and exhaust fans used to move air into and through a building. Excluded are condenser fans and cooling tower fans, which are in the Heat Rejection category.
Refrigeration	[Refrigeration] REFG-ELEC-METER	Electrical consumption of refrigerated display cases, including heat rejection devices.
Supplemental Heat	[Supplmt Heat] SUPP-ELEC-METER	Electrical consumption of supplemental electric resistance heaters in heat pumps. This category, if not specifically separated by linking to a meter, will be included in the Heating category (see above).
Domestic Hot Water	[Dom Hot Water] DHW-ELEC-METER	Electric consumption of electric domestic hot water heaters.
Exterior Misc	[Ext Misc] EXT-ELEC-METER	Electrical consumption of miscellaneous exterior devices as defined in the new EXT-ELEC-KW keyword of the PLANT-ASSIGNMENT command.
Cogeneration	[Cogeneration] ELEC-METER	Electricity usage for electrical generation specified in the ELEC-METER keyword when defining equipment using the PLANT-EQUIPMENT command in PLANT. This category does <i>not</i> appear in reports PS-E or PS-F.

## Fuel End Uses

Category	Meter Keyword	Description
Source	[Source Uses] SOURCE-FUEL-METER	Source fuel usage specified by the SOURCE-BTU/HR keyword of the SPACE command, or by the new INT-FUEL-BTU/HR keyword of the PLANT-ASSIGNMENT command
Heating	[Space Heat] HEAT-FUEL-METER	All fuel consumed by boilers, furnaces, and other heating devices. This may include supplemental heating fuel consumption defined in the Supplemental category (see below).
Cooling	[Space Cool] COOL-FUEL-METER	All fuel consumed by gas-fired chillers, engine chillers, and gas-fired heat pumps during cooling.
Supplemental	[Supplmt Heat] SUPP-FUEL-METER	Fuel consumption of supplemental furnaces which augment a heat pump. This category, if not specifically separated by linking to a meter, will be included in the Heating category (see above).
Domestic Hot Water	[Dom Hot Water] DHW-FUEL-METER	Fuel consumption of non-electric hot water heaters.
Exterior Misc	[Ext Fuel] EXT-FUEL-METER	Fuel consumption of miscellaneous exterior devices as defined in the new EXT-FUEL-BTU/HR keyword of the PLANT-ASSIGNMENT command.
Cogeneration	[Cogeneration] FUEL-METER	Fuel usage for electricity generation specified in the FUEL-METER keyword when defining equipment using the PLANT-EQUIPMENT command in PLANT. This category does not appear in reports PS-E or PS-F.

**Electrical and Fuel Meters in LOADS**

No meters are directly available in the LOADS module; instead the energy consumption of lights, task lights, equipment, and source energy of each SPACE is passed to SYSTEMS where it is metered via the ZONE meter keywords. The ZONE with the same u-name as the space with the energy end use is where the meters are assigned.

**Electrical and Fuel Meters in SYSTEMS**

The program accumulates energy in up to five electrical and five fuel meters, each named M1, M2, M3, M4 or M5. These meters are specified in the ZONE, SYSTEM, and PLANT-ASSIGNMENT commands in SYSTEMS, and the PLANT-EQUIPMENT and PLANT-PARAMETERS commands in PLANT. Energy is directed to these meters according to the end use categories described above, or by individual zone, system, plant-assignment, or plant-equipment.

The electrical meters are for, of course, electricity. The fuel meters, however, may represent any of the fuel resources specified in the ENERGY-RESOURCE command in PLANT, and are linked to a resource via this command. Acceptable resources are NATURAL-GAS, LPG, DIESEL-OIL, FUEL-OIL, COAL, METHANOL, and OTHER-FUEL. The fuel meters may all represent the same fuel, or different fuels. By default, all fuel meters are for NATURAL-GAS.

**Specifying Meters in SYSTEMS**

In SYSTEMS, the meters at each level (ZONE, SYSTEM and PLANT-ASSIGNMENT) monitor the flow of energy consumed at that level. For example, zone meters monitor the end-use consumption of lights, task lights, equipment, source energy, baseboards, zone reheat, zone exhausts, and zonal units such as fan coils and package terminal air conditioners. At the SYSTEM level, meters may be assigned to monitor the energy consumption of HVAC system equipment such as central fans, packaged equipment, gas heat pumps, and desiccant coolers. At the PLANT-ASSIGNMENT level, the meters monitor process and domestic hot water energy use. They also monitor the energy consumption of the boilers, cooling towers, and pumps associated with water loop heat pump system.

Electric and fuel meters specified in SYSTEMS apply only to equipment in LOADS and SYSTEMS; meters for equipment simulated in PLANT may also be specified in PLANT (see "Energy Meters in PLANT", p.4.3).

The following meter keywords can be specified in the PLANT-ASSIGNMENT, SYSTEM and ZONE commands of the SYSTEMS module. See "Building Resources in SYSTEMS", p.3.13 for additional meter keywords in PLANT-ASSIGNMENT.

**SYSTEM, ZONE, and PLANT-ASSIGNMENT**

- MSTR-ELEC-METER**      The master electrical meter for all meters in this command. If no other electrical meters are specified, all electrical consumption will default to this meter. Acceptable entries are M1, M2, M3, M4 or M5. The default in PLANT-ASSIGNMENT is M1. If no master is specified in the SYSTEMS command, it will default to the master in PLANT-ASSIGNMENT (which in turn defaults to M1). If no master is specified in the ZONE(s), the zone master(s) will default to the system master.
- MSTR-FUEL-METER**      The master fuel meter for all meters in this command. If no other fuel meters are specified, all fuel consumption will default to this meter. Acceptable entries are M1, M2, M3, M4 or M5. The default hierarchy is the same as described for MSTR-ELEC-METER.
- LIGHT-ELEC-METER**      This is the first of the end use meters. Acceptable values are M1, M2, M3, M4 or M5. At the zone level, it meters the area lighting energy of a specific SPACE (as defined in LOADS). Different zones may be on the same or different meters. There is an ascending level of defaults for all end use meters that will be illustrated using the LIGHT-ELEC-METER. If this meter is not specified at the zone level, it will default to the zone level MSTR-ELEC-METER. If the zone master is not specified, the zone LIGHT-ELEC-METER will default to the system level LIGHT-ELEC-METER. In this manner, the system level LIGHT-ELEC-METER can meter the electrical consumption of all lights in the zones in this system. SYSTEM level end use meters default in a similar fashion. If the LIGHT-ELEC-METER is not specified at the system level, it will default to the system MSTR-ELEC-METER. If the system master is not specified, the system LIGHT-ELEC-METER will default to the plant-assignment level LIGHT-ELEC-METER. At the PLANT-ASSIGNMENT level, all electrical and fuel end uses default to the MSTR-ELEC-METER and MSTR-FUEL-METER. The defaults for these masters are M1. Note that the system and zone MSTR-ELEC-METERS do not have a default; this is to permit all of the system and zone level end use meters to ultimately default to the plant-assignment level. In this fashion, the master meters and/or end use meters specified in the plant-assignment will meter all energy flows not specified otherwise at the system or zone level.



TASK-ELEC-METER  
EQUIP-ELEC-METER  
SOURCE-ELEC-METER  
HEAT-ELEC-METER  
COOL-ELEC-METER  
HTREJ-ELEC-METER  
AUX-ELEC-METER  
VENT-ELEC-METER  
REFG-ELEC-METER  
SUPP-ELEC-METER  
DHW-ELEC-METER

These and the following end use meters default in the same manner as described for LIGHT-ELEC-METER.

Caution: For example, if in SYSTEMS the COOL-ELEC-METER is specified to be M2, a chiller in PLANT will still default to meter M1.

SOURCE-FUEL-METER  
HEAT-FUEL-METER  
COOL-FUEL-METER  
SUPP-FUEL-METER  
DHW-FUEL-METER

The fuel end use meters default in a similar fashion as the electric meters, but the master meter at each level is specified by MSTR-FUEL-METER.

Caution: For example, if in SYSTEMS the HEAT-FUEL-METER is specified to be M2, a boiler in PLANT will still default to meter M1.

**Example 1: Gas Cooling Rate**

Many gas utilities offer rates for separately metered gas cooling equipment. In the following example a separate gas meter serves a gas air conditioner.

INPUT SYSTEMS ..

GAC =	SYSTEM		
	SYSTEM-TYPE	= PSZ	
	HEAT-SOURCE	= GAS-HEAT-PUMP	\$ For packaged gas heat pump
	COOLING-CAPACITY	= 12000	
	HEATING-CAPACITY	= -15000	\$ This unit only
			\$ provides cooling
	COOL-FUEL-METER	= M3	
	.		
	..		

END ..

INPUT PLANT

...

END ..

INPUT ECONOMICS ..

GASCL =	UTILITY-RATE		
	RESOURCE	= NATURAL-GAS	
	METER	= (M3)	\$ Attaches energy used by \$ Gas AC to this rate
	MONTH-CHGS	= (4)	
	ENERGY-CHG	= 0.30 ..	
OTHER =	UTILITY-RATE		\$ This utility rate for \$ all non-cooling gas
	RESOURCE	= NATURAL-GAS	
	METER	= (M1)	\$ Default meter for all \$ other gas equipment
	ENERGY-CHG	= 0.45 ..	

END ..

**Example 2: Electric Lighting Rate**

High efficiency lighting retrofits may be encouraged by a utility by offering special reduced rates for all electricity consumed by the lighting system.

INPUT LOADS ..

LITEON = SCHEDULE THRU DEC 31 (ALL) (1,24) (1) ..

SP-1 =	SPACE		
	LIGHTING-W/SQFT	= 1.2	\$ lighting is specified in
	LIGHTING-SCHEDULE	= LITEON	\$ LOADS but assigned
	.		\$ to a meter in SYSTEMS
	. ..		

END ..

INPUT SYSTEMS ..

SP-1 =	ZONE	
	LIGHT-ELEC-METER	= M2
	.	
	. ..	

END ..

INPUT PLANT ..

...

END ..

INPUT ECONOMICS ..

LITCHG =	UTILITY RATE		
	RESOURCE	= ELECTRICITY	
	METER	= M2	\$ Assigns the lighting
			\$ energy to this rate
	MONTH-CHGS	= (12)	
	ENERGY-CHG	= 0.07 ..	
ELECHG =	UTILITY RATE		\$ Electric rate (not lights)
	RESOURCE	= ELECTRICITY	
	METER	= M1	\$ Default meter
	MONTH-CHGS	= (20)	
	ENERGY-CHG	= 0.11 ..	

END ..

**Building Resources in SYSTEMS**

The BUILDING-RESOURCE command has been removed from LOADS in DOE-2.1E, and new resource keywords have been added to the PLANT-ASSIGNMENT command in SYSTEMS. This was done to prevent the resource energy defined in LOADS from being double counted in SYSTEMS when two or more PLANT-ASSIGNMENTS are defined.

Additional resource types and corresponding meters have been added, including process hot water, process chilled water, and exterior fuel consumption. The new PLANT-ASSIGNMENT keywords, except for those related to domestic hot water, are as follows. The new domestic hot water keywords are described in DOMESTIC HOT WATER HEATER AND TANK MODEL IN SYSTEMS, p.3.57.

**PLANT-ASSIGNMENT**

INT-FUEL-BTU/HR	Is the consumption in Btu/hr of fuel that is consumed in the interior of the building, but that does not contribute to the space cooling load. Fuels which contribute to the space cooling load should be entered under the SPACE affected in LOADS.
INT-FUEL-POWER	The same as INT-FUEL-BTU/HR, but used with metric input
INT-FUEL-SCH	Identifies the schedule that is used to specify the building-level fuel use as a function of time. Schedule inputs are fractions of the quantity given by the keywords INT-FUEL-BTU/HR or INT-FUEL-POWER. If INT-FUEL-SCH is not input, the schedule values will all default to zero and no fuel usage will occur, regardless of the value specified for INT-FUEL-BTU/HR or INT-FUEL-POWER.
INT-FUEL-METER	Identifies the fuel meter to which the hourly consumption given by INT-FUEL-BTU/HR and INT-FUEL-SCH will be assigned. Acceptable entries are M1, M2, M3, M4 and M5. The default is meter M1. The fuel associated with this meter is defined in the ENERGY-RESOURCE command in PLANT. If no fuel is defined, it will default to NATURAL-GAS.
EXT-FUEL-BTU/HR	Is the consumption in Btu/hr of fuel that is consumed exterior to the building. Decorative gas torches and pool heaters are examples.
EXT-FUEL-POWER	The same as EXT-FUEL-BTU/HR, but used with metric input.
EXT-FUEL-SCH	Schedule of exterior fuel use.
EXT-FUEL-METER	Identifies the fuel meter for exterior fuel use. It takes values M1, M2, M3, M4 and M5.

INT-ELEC-KW	Is electricity consumed in kW within the building that does not contribute to space conditioning loads. Electrical consumption which contributes to space cooling loads should be defined within the SPACES affected in LOADS. Included in this category are elevators, escalators, etc. that were previously modeled using the VERT-TRANS-KW and VERT-TRANS-SCH keywords in the now-obsolete BUILDING-RESOURCE command. These keywords are no longer used.
INT-ELEC-SCH	Schedule that corresponds to INT-ELEC-KW.
INT-ELEC-METER	Is the meter that corresponds to INT-ELEC-KW. It takes values M1, M2, M3, M4 and M5.
EXT-ELEC-KW	Is electricity consumed in kW outside of the building. Power for fountains and pool pumps are included in this category.
EXT-ELEC-SCH	Schedule of exterior electricity use.
EXT-ELEC-METER	Is the meter for exterior electricity use. It takes values M1, M2, M3, M4 and M5.
EXT-LIGHT-KW	Is electricity consumed in kW for lights outside of the building. Power for signs, landscaping, etc. is included in this category. Note that it is not necessary to separate EXT-ELEC-KW from EXT-LIGHT-KW unless separate end use categories are desired, or unless they are on separate electrical meters. If combined, total energy usage for the building will be the same.
EXT-LIGHT-SCH	Is the schedule for exterior lighting.
EXT-LIGHT-METER	Is the meter for exterior lighting. It takes values M1, M2, M3, M4 and M5.
PROCESS-HW-BTU/HR (or PROCESS-HW-POWER)	Is a process hot water load in Btu/hr. This load increases the total plant heating load as shown in report SS-D, and is passed on to the boilers or other heating equipment in PLANT. A manufacturing process which uses hot water is an example of a process hot water load.
PROCESS-HW-SCH	Is the schedule for the process hot water load.
PROCESS-CHW-BTU/HR (or PROCESS-CHW-POWER)	Is a process chilled water load in Btu/hr. This load increases the total plant cooling load as shown in report SS-D, and is passed on to the chillers or other cooling equipment in PLANT. A computer room which has computers directly cooled by

Supplement - 2.1E Update

chilled water is an example of a process cooling load. (The electricity consumed by these computers should be input using the INT-ELEC-KW keyword.)

PROCESS-CHW-SCH

Is the schedule for the process chilled water load.

## POWERED INDUCTION UNIT (PIU)

### Introduction

The PIU system is basically just a VAV terminal box with a small fan that pulls some amount of air from a ceiling plenum. PIU's have two functions:

- 1) to move warm air from a core area through the plenum to exterior zones requiring heat; this conserves heating energy; and
- 2) to provide increased air movement in zones normally served by VAV terminals; such zones often suffer from stagnant air when the primary air damper is in its minimum position.

Two types of PIU are modeled — series and parallel. These are sometimes also called constant and intermittent fan powered units. In the series unit (Fig. 3.1), the fan draws air from both the secondary and primary air streams. The proportion of secondary to primary air is controlled by the primary air dampers. The amount of secondary plus primary air is constant, and the blower runs all the time (when the central fans are on) at constant speed. The booster (reheat) coil can be located in the secondary air inlet to save energy when cooling is near a maximum. The fan can run when the central system is off for ventilation or heating. Generally, the blower is sized by the zone recirculation air requirements (AIR-CHANGES/HR, CFM/SQFT). It must be sized equal to or greater than the primary air cfm.

XBL 843-10166

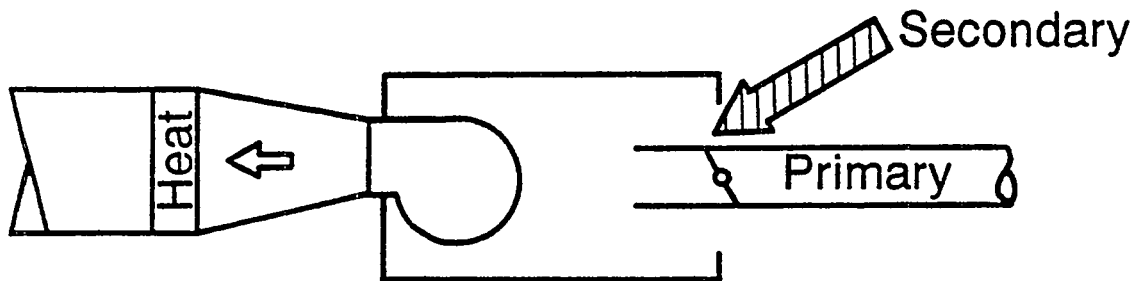

Figure 3.1: Series PIU

The series unit is controlled like a normal VAV unit. At maximum cooling, the primary air damper is open and only a small amount ( $\leq 5\%$ ) of secondary air is induced (Fig. 3.2). As the space temperature falls, the primary air damper gradually closes. However, unlike VAV units, the PIU can throttle primary air down to essentially zero. Once the primary air damper is closed, booster heating (reheat in VAV) can be supplied to meet any heating demand not met by the secondary air from the warm ceiling plenum. The fan can be used at night to limit the lowest building temperature. The fan will normally be off when the central fans are off, but when the zone temperature falls below the night set point, the fan turns on and the booster coil is activated.

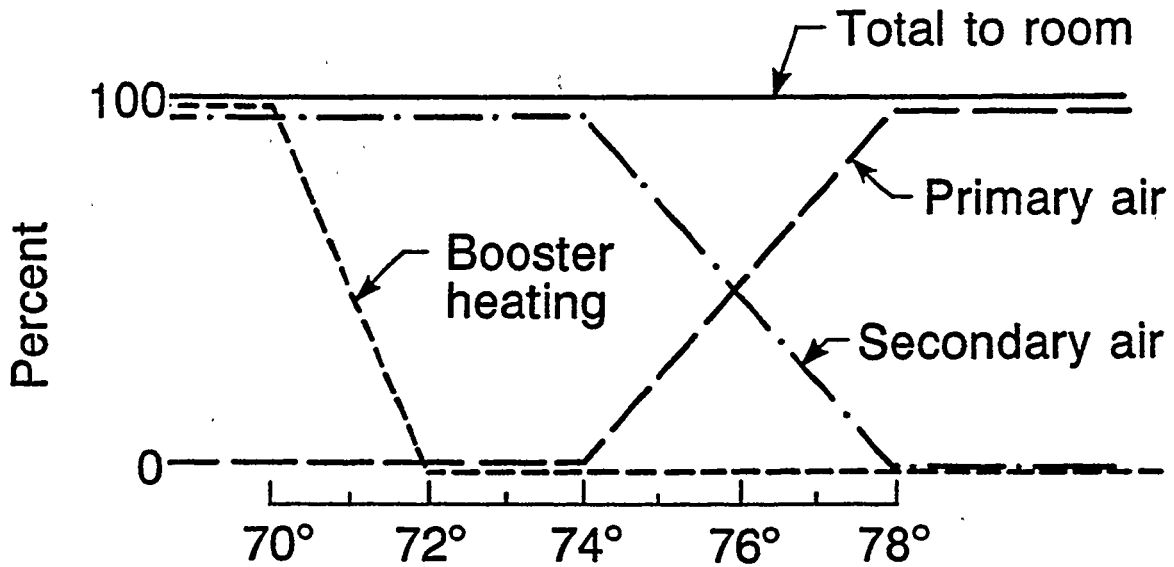

Figure 3.2: Series PIU

The parallel fan unit is slightly more complicated. As illustrated in the schematic, the parallel unit draws air from the secondary air stream only. In addition, the operation of the parallel blower is intermittent. A thermostat set point regulates turning the fan on and off. When cooling is required, the fan is generally off. Thus, we have normal variable volume - constant temperature cooling with the primary air. When the primary air damper is closed and the fan is on, we have constant volume ventilating/heating. Thus total air to the zone is not a constant, as in the series cases.

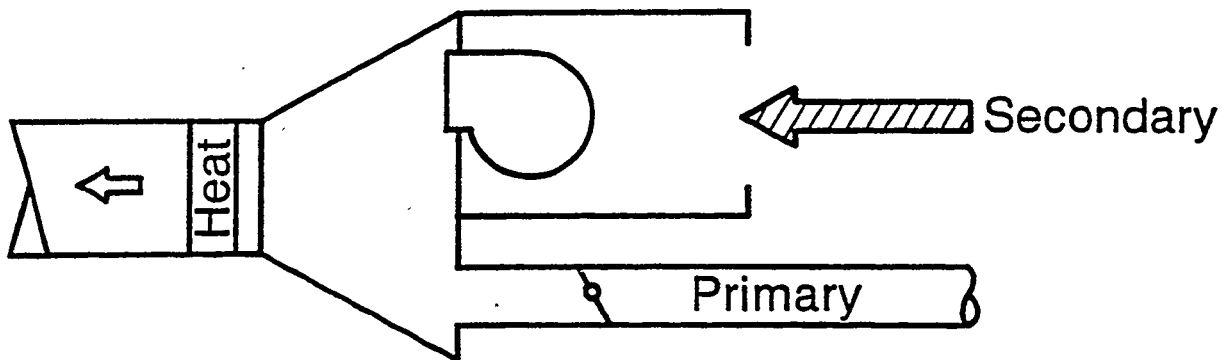

Figure 3.3: Parallel PIU



For parallel PIU's, the blower may be any size. It is commonly *less* than the primary cold air cfm.

At maximum cooling, the blower is off and the primary air damper is open (Fig. 3.4). As the space temperature drops, the damper closes. At a temperature selected by the designer, the blower turns on, and secondary air is mixed with the primary air. As the temperature continues to fall, the primary air damper closes to its minimum position, and the booster heater eventually turns on. The heating coil can (and probably should) be located in the secondary air stream.

XBL 843-10170

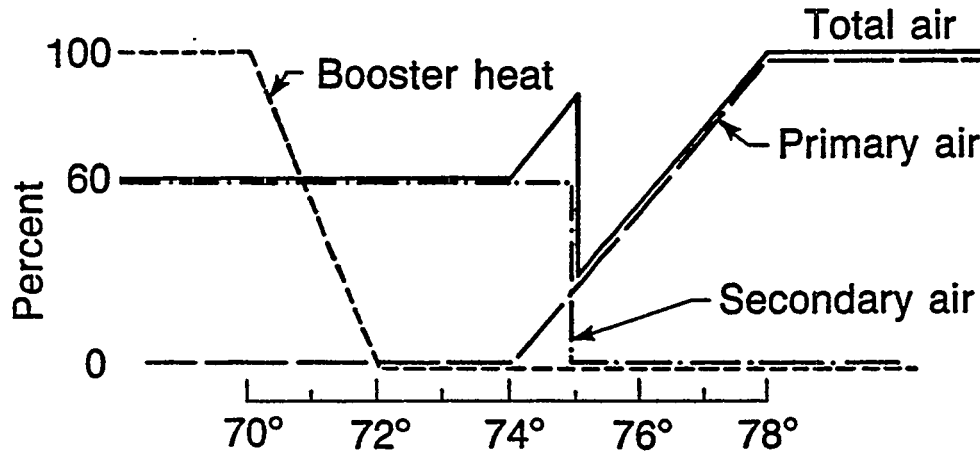

Figure 3.4: Parallel PIU

The blowers operate at a very low static pressure — 0.2 or 0.3 inches are common. A 1400 cfm blower against 0.2 inch static pressure will use about 400 watts.

#### Input for PIU

The PIU system is selected by using the code-word PIU in the SYSTEM command:

SYSTEM-TYPE = PIU

There are three ZONE keywords associated with PIU:

**ZONE**

**TERMINAL—TYPE**

This keyword specifies the type of terminal serving the zone. The same type of terminal box does not have to be used for the entire system. Typically, a PIU system will contain a mixture of fan powered terminal boxes and regular VAV or constant volume reheat units. The available code-words are:

*SVAV*

(the default) stands for Standard Variable Air Volume; i.e., regular VAV or constant volume.

*SERIES—PIU*

means that the fan draws air from both the secondary and primary air streams, and that the blower runs all the time.

*PARALLEL—PIU*

means that the fan draws air from the secondary air stream only, and that the blower runs intermittently.

**INDUCED—AIR—ZONE**

This keyword takes as a value the u-name of another zone. It is assumed that the PIU zone is taking its secondary air from the return air of the zone named as the **INDUCED—AIR—ZONE**. Normally, the core zone, served by a non-PIU terminal, will be designated the **INDUCED—AIR—ZONE**. Zones with PIU boxes will normally be exterior zones that need the heat reclaimed from the core zone. An exception would be a zone (such as a classroom) in which the primary concern is air movement, not energy conservation. In such a case, the corridors can be specified as the **INDUCED—AIR—ZONE** even though there is no heat to reclaim from them. The program treats this situation in the same way as it does when a core plenum is at a temperature lower than the exterior zone. For zones in which **TERMINAL—TYPE = SERIES—PIU** or **PARALLEL—PIU**, this keyword is required. *The INDUCED—AIR—ZONE should not be a zone with ZONE—TYPE = PLENUM.*

**REHEAT—DELTA—T**

should be specified, at the ZONE level, if reheat or booster heat is desired. This keyword used to be on the SYSTEM level only. Now, for the PIU system only, it is a keyword in both the SYSTEM and ZONE commands, and the ZONE level use takes precedence over the SYSTEM level. Its meaning remains the same as before.

**MIN—CFM—RATIO**

should be specified in ZONE, just as it is for VAV systems. The usual input for PIU terminals should be to specify a ratio that just satisfies the minimum ventilation air requirements of

---

In the left column above, bold-faced words are commands, non-bold words are keywords, and italicized words are code-words.

the zone.

ZONE-FANS, a zone-level command associated with PIU, has been added. It is a subcommand of the ZONE command.

### ZONE-FANS

#### ZONE-FAN-CFM

If `TERMINAL-TYPE = SERIES-PIU` or `PARALLEL-PIU`, you can size the fan with this keyword. If `ZONE-FAN-CFM` is not specified, the program will size the fan. For series PIU fans, this is a straightforward process. The blower is sized to the zone cfm; i.e., the maximum of the cfm input via `ASSIGNED-CFM`, `AIR-CHANGES/HR`, or `CFM/SQFT`; or the cfm derived from the heating and cooling peaks from `LOADS`. For parallel PIU's, if `ZONE-FAN-CFM` is not input, the blower is sized from the heating peak. The ZONE level cfm keywords are assumed to refer to the primary air from the central system. It is recommended that you explicitly size the fans, since the use of the heating peak to size the parallel PIU might result in a ridiculously small fan. The range is from 0.0 to 99999999.0 ft<sup>3</sup>/min.

#### ZONE-FAN-RATIO

For `TERMINAL-TYPE = SERIES-PIU` or `PARALLEL-PIU`, you may enter a value which sets the `ZONE-FAN-CFM` as a ratio of the primary air. If both `ZONE-FAN-CFM` and `ZONE-FAN-RATIO` are specified, `ZONE-FAN-CFM` takes precedence.

#### ZONE-FAN-KW

For `TERMINAL-TYPE = SERIES-PIU` or `PARALLEL-PIU`, this keyword specifies the power consumption of the fan. The default is .00033 kW/cfm. The range is from 0.0 to 0.01.

#### ZONE-FAN-T-SCH

is the u-name of a schedule which gives, for zones with parallel PIU's, the space temperature at which the terminal blower turns on. This temperature must be above the heating range. This keyword is required for zones with `TERMINAL-TYPE = PARALLEL-PIU`.

## Supplement – 2.1E Update

In addition, there is a code-word associated with PIU for NIGHT-CYCLE-CTRL in the SYSTEM-FANS command.

### SYSTEM-FANS

#### NIGHT-CYCLE-CTRL

##### *ZONE-FANS-ONLY*

If input, the main or central system fan will remain off. However, the individual zone terminal fans will cycle on separately to satisfy the heating setback temperature for each zone.

##### **Example**

Sample input for the PIU system can be found in the *Sample Run Book (2.1E)* (31-Story Office Building, Run 5) and in *DOE-2 Basics (2.1D)* (Section 4, Specific HVAC Distribution Systems).

## PACKAGED VARIABLE VOLUME, VARIABLE TEMPERATURE SYSTEM (PVVT)

### Introduction

PVVT is a variable temperature, variable volume system. It behaves like a PSZ system in that when no heating or cooling is required by the control zone (first ZONE in the ZONE-NAMES list), mixed air is passed into the zone for ventilation. In this situation the cooling or heating unit is cycled off. To cycle the fans off in this situation, the INDOOR-FAN-MODE should be specified as INTERMITTENT. It also behaves like a PVAVS system in that it adjusts the volume flow into the zones to match the heating or cooling requirement of the control zone. PVVT is intended to be a single zone system; you should not place multiple zones on this system if they can be in different modes (one in heating and another in cooling). For optional GAS-HEAT-PUMP, PVVT assumes a variable speed compressor and a variable volume fan. In this case the fan and compressor speed are decreased together as the load drops in either the heating or cooling thermostat range. In conventional electric motor/compressor systems the standard defaults are used for both heating and cooling (a HEAT-SOURCE = HEAT-PUMP is allowed).

The MIN-CFM-RATIO in the ZONE and SYSTEM commands behaves as with a PVAVS system. The outside air requirements are interpreted as a constant volume of ventilation air. As the supply flow drops, the outside air fraction increases. MIN-SUPPLY-T and MAX-SUPPLY-T are used to size the heating and cooling equipment as well as hourly operational limits on the supply temperature.

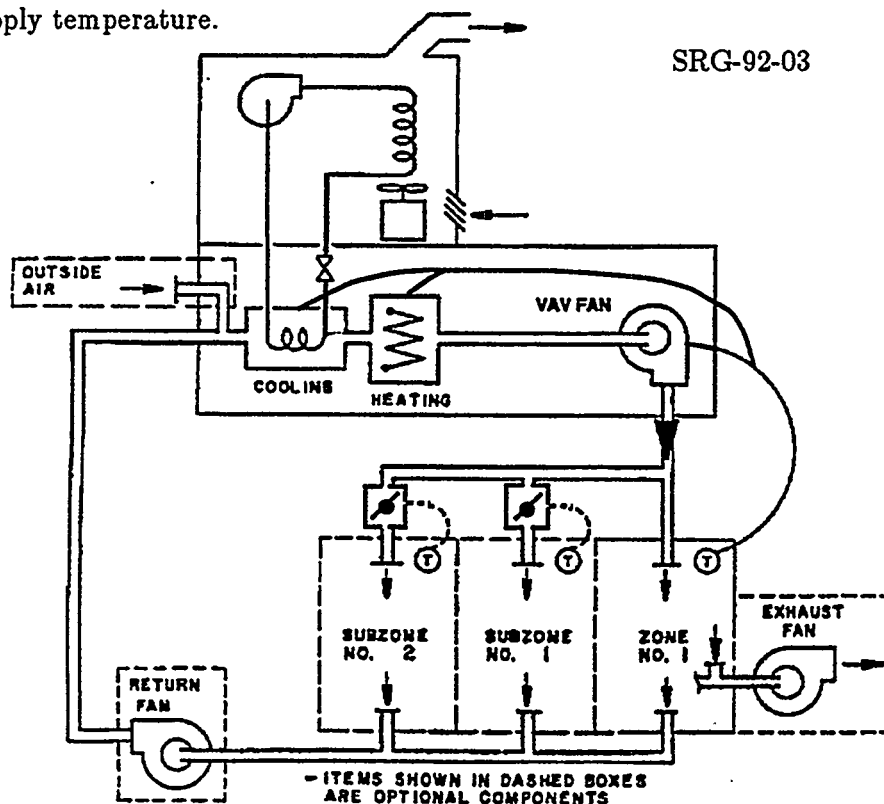

Figure 3.5: Packaged variable temperature, variable volume system (PVVT).

## RESIDENTIAL VARIABLE VOLUME, VARIABLE TEMPERATURE SYSTEM (RESVVT)

### Overview

A new HVAC system model (RESVVT) has been added to DOE-2.1E. RESVVT is a forced air residential system featuring multiple, individually ducted and thermostatically controlled zones. Central heating and cooling are available from a high efficiency variable speed heat pump. Each thermostat controls a motor-driven air damper in the zone duct. These dampers can close completely, giving zero air flow to the zone. Thus some zones can be conditioned, while other zones are permitted to float. The system can also do simultaneous heating and cooling in the sense that it can switch between cooling one group of zones and heating another group of zones within the one hour time step in DOE-2. The electronically commutated motors for the compressor and indoor fan allow the heat pump unit to adjust the cfm and compressor rpm to meet the total cooling or heating load. Figure 3.6 shows a schematic for this system.

SRG-93-1101

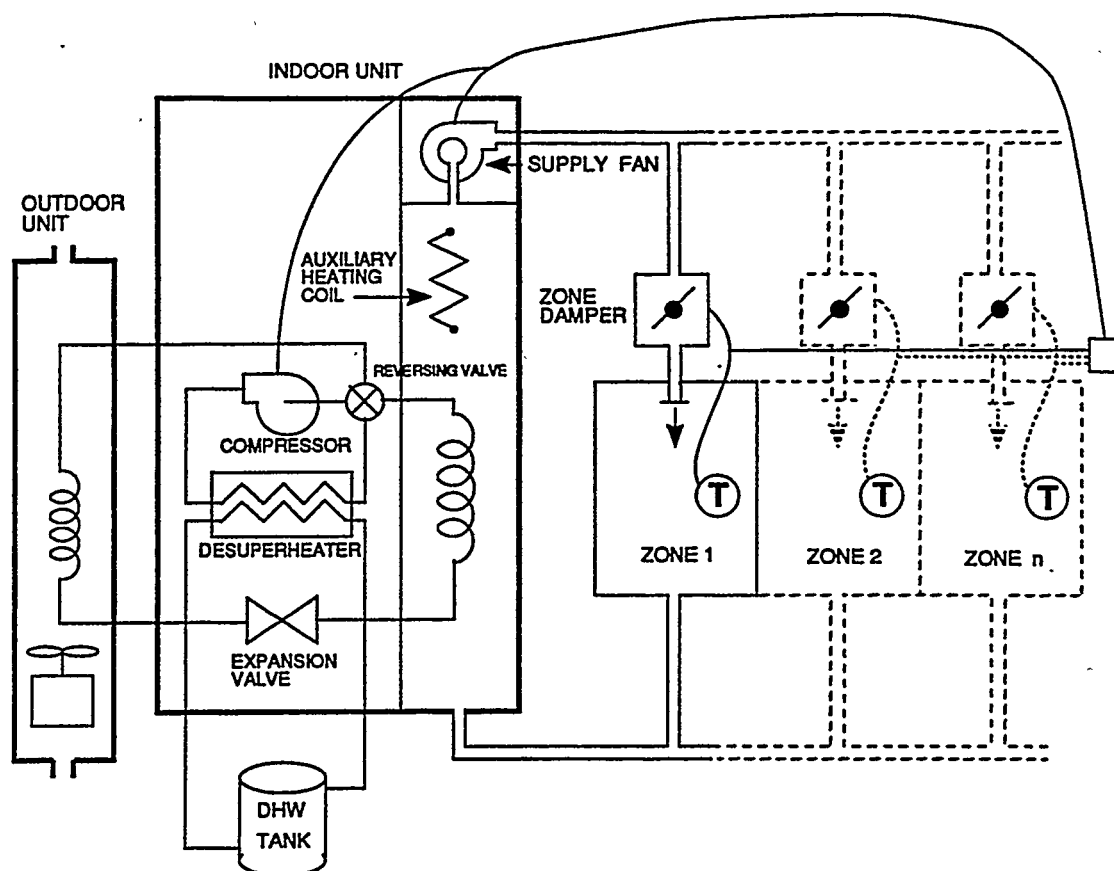

Figure 3.6: RESVVT system with variable speed heat pump and desuperheater

The RESVVT system differs from the other residential system model (RESYS) in that RESYS allows only *one* thermostatically controlled zone. RESYS does not allow the heating or cooling in the noncontrol zones to be adjusted for different occupancy levels or different desired comfort levels. The ability of the RESVVT system to turn off the conditioning of unoccupied zones through thermostat setup or setback should yield considerable energy savings compared to a RESYS system.

The RESVVT system most closely resembles a VAV system. It differs primarily in its capability to have the duct air dampers close completely. The RESVVT system is designed to be used in a situation with a high degree of load diversity. For example, in a residence the bedrooms might be unconditioned during the day and early evening, while comfort levels are maintained in the rest of the house. At night the opposite might be true — the bedrooms would be conditioned while the rest of the house could be unconditioned or minimally conditioned. In these circumstances some care should be used in specifying the input. The zone cfm's cannot be expected to add up to the system cfm. Indeed, depending on how the house is zoned and on its expected occupancy patterns, the individual zone cfm's might each equal the supply cfm. You will have to specify by hand the individual zone cfm's, as well as the supply cfm and cooling capacity, since the program cannot size the system correctly to reflect thermostat setups and setbacks that result from diverse occupancy patterns. It is important not to oversize the compressor; if it is oversized it may spend the majority of its operating hours cycling on and off rather than operating in the more efficient variable speed mode.

#### Input for RESVVT

The RESVVT system is selected by specifying

```
SYSTEM-TYPE = RESVVT
```

in the SYSTEM command. Minimal input for the system might look like this for a 1-1/2 ton 450 cfm unit:

```
SYS-1 = SYSTEM
      SYSTEM-TYPE      = RESVVT
      ZONE-NAMES       = ( ZONE-1 , ZONE-2 )
      SUPPLY-CFM       = 450
      COOLING-CAPACITY = 18000 ..
```

In the ZONE command both zones are given ASSIGNED-CFM = 450 so that all the air can be sent to one zone or the other. The SYSTEM keywords HEAT-SOURCE and COMPRESSOR-TYPE are defaulted to HEAT-PUMP and VARIABLE-SPEED respectively so that the system uses a variable speed heat pump for heating and cooling.

#### Example:

Sample input for the RESVVT system can be found in the *Sample Run Book (2.1E)*, Single Family Residence, Runs 2 and 3.

System equipment curve defaults for RESVVT can be found at the end of the SYSTEMS section (p.3.141). The following keyword defaults also define the performance of the default RESVVT system.

SYSTEM-EQUIPMENT Curve Defaults			
Keyword	Default	Keyword	Default
<b>In the SYSTEM-EQUIPMENT Command</b>		<b>In the SYSTEM-CONTROL Command</b>	
COIL-BF	0.1400	MAX-SUPPLY-T	105.°F
COOLING-EIR	0.3430	MIN-SUPPLY-T	55.°F
COMPRESSOR-TYPE	VARIABLE-SPEED	<b>In the SYSTEM-FANS Command</b>	
DEFROST-CTRL	ON-DEMAND	FAN-CONTROL	SPEED
DEFROST-T	40.°F	SUPPLY-DELTA-T	0.4°F
DEFROST-TYPE	REVERSE-CYCLE	SUPPLY-KW	.00016 kW/cfm
HEATING-EIR	0.3060	<b>In the SYSTEM-AIR Command</b>	
HP-SUPP-SOURCE	ELECTRIC	MIN-FAN-RATIO	0.3
MAX-HP-SUPP-T	40.°F	MIN-OUTSIDE-AIR	unused
MIN-HP-T	10.°F	OA-CONTROL	unused
RESIST-CAP-RATIO	0.7		
<b>In the SYSTEM-TERMINAL Command</b>			
MIN-FLOW-RATIO	unused (set to 0.0 in DESIGN)		

**Notes**

*Like* RESYS, RESVVT has no outside air capability.

*Unlike* RESYS, RESVVT cannot use natural ventilation.



## AIR SOURCE HEAT PUMP ENHANCEMENTS

### Expanded Supplemental-heat-source and Defrost Options

#### Description of All Air/Air Heat Pump Keywords

##### Introduction

In this section we describe all of the air/air heat pump keywords, including those added in DOE-2.1C (to expand the supplemental-heat-source options) and in DOE-2.1E (to expand the defrost options). Air/air heat pumps can be assigned to system types PSZ, PTAC, PVVT, RESYS, and RESVVT, by specifying HEAT-SOURCE = HEAT-PUMP in the SYSTEM instruction.

##### SYSTEM-EQUIPMENT

HEATING-CAPACITY	is the heating capacity (Btu/hr) of the system, entered as a <i>negative</i> value. If not input, it will be calculated by the program. The heating capacity of a heat pump is related to its cooling capacity; if the heat pump is sized by the program, the compressor capacity is determined by the larger of the heating and cooling requirements as follows: Compressor capacity = max (required cooling capacity * heating COP / cooling COP, required heating capacity * cooling COP / heating COP) Note: DOE-2 does not round up or round down the calculated capacity to correspond to the integral sizes that are available for packaged units. If desired, you have to do this manually after the calculated value is known.
HEAT-CAP-FT	accepts the u-name of a CURVE-FIT that gives the heat pump heating capacity as a function of outdoor drybulb temperature and entering drybulb temperature.
HEATING-EIR	accepts the inverse of the heating COP of the heat pump unit at ARI rated conditions, including fan power.
HEAT-EIR-FT	is the u-name of a CURVE-FIT that gives the heat pump heating EIR as a function of outdoor drybulb temperature and entering drybulb temperature.
HEAT-EIR-FPLR	accepts the u-name of a CURVE-FIT that gives the heat pump heating EIR as a function of part load ratio.
MIN-HP-T	is the outdoor drybulb temperature below which the heat pump turns off. The range is -30°F to 70°F; the default is system dependent.

Supplement - 2.1E Update

HP-SUPP-SOURCE	accepts code-words that specify the type of supplemental heating. The default is ELECTRIC. Other choices are HOT-WATER (which requires that a boiler be specified in PLANT), GAS-FURNACE, and OIL-FURNACE.
HP-SUPP-HT-CAP	is the supplemental heating capacity for a heat pump, expressed as a <i>negative</i> number. The program will size this to the maximum heating load since this usually occurs when the heat pump is unavailable. The range is -9999999.0 to 0.0 Btu/hr.
MAX-HP-SUPP-T	is the outside drybulb temperature below which the heat pump supplemental heating is allowed to operate. The range is -30°F to 70°F. and the default is system dependent.
DEFROST-TYPE	accepts code-words REVERSE-CYCLE and RESISTIVE (the default) to describe the type of defrost cycle on the heat pump.
<b>REVERSE-CYCLE</b>	The heat pump action is reversed to provide heat to melt frost.
<b>RESISTIVE</b>	The frost is melted using electric resistance heat. The capacity of the resistive element is specified as a fraction of the heat pump's heating capacity using RESIST-CAP-RATIO.
DEFROST-CTRL	accepts code-words ON-DEMAND and TIMED (the default) to describe the defrost control action on the heat pump. These control choices apply to both REVERSE-CYCLE and RESISTIVE defrost.
<b>ON-DEMAND</b>	Defrost starts when the capacity of the heat pump drops by approximately 25% due to frost buildup on the coil. The program calculates frost accumulation as a function of outdoor drybulb temperature and evaporator coil temperature. For DEFROST-TYPE = REVERSE-CYCLE, the energy to run the compressor to melt the frost and the resultant cooling effect in the zone are calculated. For DEFROST-TYPE = RESISTIVE, the electric resistance energy to melt the frost is calculated.
<b>TIMED</b>	Defrost is controlled by the elapsed operating time of the compressor whether or not frost has actually accumulated. However, defrost does not occur above a user-specified outdoor temperature, DEFROST-T. For DEFROST-TYPE = REVERSE-CYCLE, the compressor energy to defrost for a set period of 3.5 minutes and the cooling effect produced in the zone are calculated. For DEFROST-TYPE = RESISTIVE, the electrical energy of the heating element is calculated for 3.5 minutes of defrost time.

In the left column above, bold-faced words are commands, non-bold words are keywords, and italicized words are code-words.

Supplement — 2.1E Update

RESIST—CAP—RATIO is the ratio of the resistive coil capacity to the heating capacity of the heat pump rated at 47°F. The default is 0.7.

DEFROST—T is the outside drybulb temperature below which the defrost cycle of a heat pump is allowed to operate. The default is 40°F.

**Report Changes for the Air/Air Heat Pump Simulation**

An additional field has been added to the SV-A report when a heat pump has been specified as the heat source for system types PSZ, PTAC, PVVT, RESYS, and RESVVT. This field, labeled HEAT PUMP SUPP HEAT, shows the capacity in Btu/hr of the supplemental heating element. For PTAC systems this value will be used with each unit.

In the SYSTEMS hourly reports, variable 43 (QHR) is now the adjusted capacity of the heat pump this hour in Btu/hr for system types PSZ, PVVT, RESYS, and RESVVT. A new variable, 81 (QHSUP), gives the total supplemental heat load for system types PSZ, PVVT, PTAC, RESYS, and RESVVT if HP—SUPP—SOURCE = HOT—WATER.

ZONE hourly report variable 48 (FCHPS(15)) is now the supplemental heat load in Btu/hr for the zone's heat pump, independent of the supplemental heat source.

SYSTEMS hourly report variable 125 (HPDefE) is the heat pump defrost energy.

## WATER LOOP HEAT PUMP SYSTEM (HP) ENHANCEMENTS

### Introduction

As shown in Fig. 3.7, the water loop heat pump system (HP) (also known as water source heat pump, California heat pump, and incremental heat pump) provides heating and cooling for a number of individually controlled zones by operation of heat pump units located in each space to be conditioned. Each heat pump unit may provide a fixed quantity of outside ventilation air or, if no outside air is specified, recirculated air only. Enhancements have been made to this system to provide a more accurate model of the types of equipment and operating strategies in current use.\* The changes to HP include the addition of a boiler, a cooling tower, and loop pumps to the SYSTEMS program (while still retaining the option to pass the loads to PLANT). The new SYSTEMS components can be automatically or manually sized. HP can now have an air side economizer. You may define multiple HP systems in a single PLANT—ASSIGNMENT; they are all placed on a single loop which allows different types of units with different performance characteristics to be placed on the same loop. For example, smaller perimeter units without outside air can be placed in one SYSTEM command and the larger core units (possibly with outside air) can be placed in another SYSTEM command. You can default or specify the gpm/ton of loop flow, the gallons of water (loop capacity) and the boiler, tower, and pump sizing. The HP loop temperature is controlled either at a fixed setpoint or allowed to float to the lowest temperature the cooling tower can provide.

The tower curves for the new model are the same as those in the PLANT program (the curve names have not been repeated here). The cooling tower simulation used in SYSTEMS is derived from that in the PLANT program, with added flexibility and more detailed controller/loop temperature calculations.

The new summary report SS—P (LOAD, ENERGY, AND PART LOAD HEATING AND COOLING) is automatically generated for the boiler, cooling tower, and loop pumps. SS—P is generated for each zone if either SS—H or SS—L is requested.

Hourly reports allow you to examine in detail the simulation of all system components.

Each heat pump consists of a refrigerant compressor, a room air-to-refrigerant exchanger, a fluid-to-refrigerant exchanger connected to the water loop, controls to switch the evaporating and condensing functions from one heat exchanger to the other, a supply air fan, and a two-setpoint ZONE thermostat. When the heat pump is used in the room heating mode the room air-to-refrigerant heat exchanger is used to reject heat to the room and simultaneously accept heat from the water loop. In the room cooling mode, this same heat exchanger is used as a refrigerant cooling coil, and room heat and compressor heat are rejected to the water loop, which acts as a means of recovering heat rejected to it and allows this heat to be transferred to the rooms that require heating. Each heat pump provides dehumidification when in the cooling mode but has no dehumidification control, per se. Humidification (adding moisture to the air) cannot be simulated.

Temperature is controlled in each zone by on/off operation of the compressor in the unit. The fan operation defaults to continuous when outside air is specified, although fan cycling with the compressor on-off cycle may be specified by using no outside air. You must input both a heating and cooling setpoint using schedules that are referenced by HEAT—TEMP—SCH and

\* The enhancements described here were made by J.J. Hirsch with support from the Southern California Edison Company and the Electric Power Research Institute.

## Supplement — 2.1E Update

COOL-TEMP-SCH. The heat pump provides cooling when the space temperature is in the COOL-TEMP-SCH throttling range and heating in the HEAT-TEMP-SCH range. It does not operate when the space temperature is between the two setpoints.

A piping system with the circulating fluid is connected to the water-to-refrigerant heat exchanger in each heat pump. The circulating fluid absorbs heat from those units that are operating in the cooling mode and are rejecting heat, and serves as a heat source to those units that are operating in the heating mode. Because some zone units may be cooling while others are heating, the temperature of the circulating fluid will depend on the relative quantities of each. When cooling demand exceeds heating demand and the fluid temperature increases to the control setpoint (see the keyword TWR-SETPT-T which may be allowed to "float" or be held at a fixed temperature) the cooling tower (water cooler) rejects heat to the atmosphere. When heating demand exceeds cooling and the fluid temperature decreases to the minimum allowable value (see keyword BOILER-SET-POINT), then heat is added from a boiler or other heat source. No heat is added or rejected when heating and cooling requirements hold a balance between the high and low temperature limits of the water loop. The volume of water in the water loop determines how fast the loop temperature changes as well as how much heat may be stored in the loop. By specifying a large volume one may simulate a storage tank.

The heat rejection unit (cooling tower or water cooler), heating unit, and circulating pump may be simulated in either PLANT (which has been the case in versions of the program prior to DOE-2.1E) or in SYSTEMS, now the default. The advantage of simulating these components in SYSTEMS is that the operating dependence of the units to the temperature of the water loop may be simulated with a greater degree of accuracy and control flexibility. The pump schedule controls whether the HP system is available; however, you may put additional limits on when the cooling tower or boiler are available. Otherwise, the tower and boiler schedules default to the circulating pump schedule. The fan schedule controls when the zone unit is on or off. When a variable speed circulating pump is specified, the program simulates a valve that opens whenever the heat pump compressor is on and closes it when off.

Note that the heat pump units, especially in the smaller sizes equipped with direct-drive fans, may not be available in the sizes resulting from automatic sizing by the program; increased accuracy will result if you input the nominal fan sizes that are to be installed. The program checks the zone cooling and heating capacities and then sizes the units to meet the larger of these two requirements.

Due to the plethora of reports now generated by the HP system, you may suppress individual ZONE level reports using the keyword ZONE-REPORT=NO; the default is YES. This feature may be used at the SYSTEM and PLANT-ASSIGNMENT levels using the keywords SYSTEM-REPORT=NO and PLANT-REPORT=NO. Notice that these keywords apply to all other system types. It is especially useful at the ZONE level since many times a few zones of special interest will suffice for all zones.

Supplement - 2.1E Update

Suggested minimal input for the HP system with outside air economizer:

```

INPUT SYSTEMS ..
SYSTEMS-REPORT SUMMARY = (SS-A,SS-H,SS-J) .. $ SS-P REPORTS
                                                $ ARE GENERATED
                                                $ AUTOMATICALLY

FANS-ON = SCHEDULE THRU DEC 31 (WD) (1,7)(0) (8,18)(1) (19,24)(0)
                                         (WEH) (1,24)(0) ..
PUMP-ON = SCHEDULE THRU DEC 31 (WD) (1,6)(0) (7,18)(1) (19,24)(0)
                                         (WEH) (1,24)(0) ..

TWR-CTRL = SCHEDULE THRU JUN 1 (ALL) (1,24) (85) $ FIXED TEMP
              THRU OCT 1 (ALL) (1,24) (60) $ FLOATING LOW
              THRU DEC 31 (ALL) (1,24) (85) .. $ FIXED TEMP
HEAT-SETPT = SCHEDULE THRU DEC 31 (ALL) (1,24)(74) ..
COOL-SETPT = SCHEDULE THRU DEC 31 (ALL) (1,24)(75) ..

ENV = ZONE-CONTROL HEAT-T = 73 DESIGN-COOL-T = 74
      HEAT-TEMP-SCH = HEAT-SETPT
      H = COOL-SETPT ..

ZONE1 = ZONE ZONE-CONTROL = ENV OA-CFM/PER = 10 ..
ZONEn = ZONE LIKE ZONE1 ..

SYSTEM1 = SYSTEM SYSTEM-TYPE = HP
              ZONE-NAMES = (ZONE1,ZONEn)
              OA-CONTROL = TEMP
              DRYBULB-LIMIT = 68
              FAN-SCHEDULE = FANS-ON ..

HP-1 = PLANT-ASSIGNMENT
SYSTEM-NAMES = (SYSTEM1)
HP-LOOP-HEATING = FROM-SYSTEMS $ THE DEFAULT
HP-LOOP-COOLING = FROM-SYSTEMS $ THE DEFAULT
CIRC-PUMP-SCH = PUMP-ON
TWR-CAP-CTRL = TWO-SPEED-FAN
MIN-TWR-WTR-T = 60 $ WHEN TWR WATER TEMP FLOATS
TWR-SETPT-SCH = TWR-CTRL ..

END ..
COMPUTE SYSTEMS ..
INPUT PLANT ..
PLANT-REPORT SUMMARY = (BEPS)
END ..
COMPUTE PLANT ..
STOP ..

```

In the “Medical Building” in the *Sample Run Book (2.1E)*, there is an example of a water loop heat pump with outside air economizers on the core unit. The circulating pump is variable speed and simulates individual unit loop control valves that open when each unit’s compressor is operative.

SRG-92-07

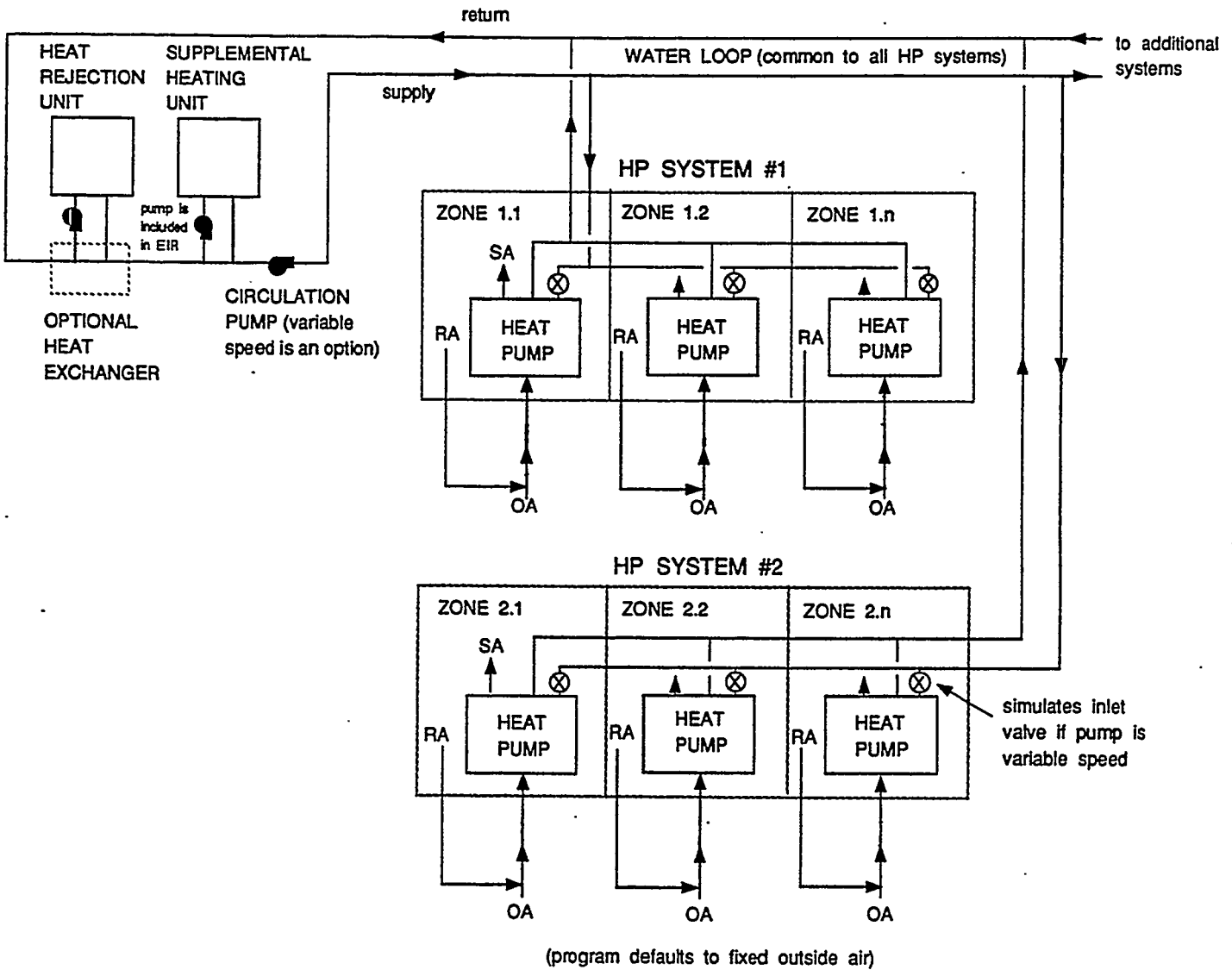

Figure 3.7: Water Loop Heat Pump System

The complete list of keywords now available for the HP system is as follows:

SYSTEM—CONTROL

- DRYBULB—LIMIT**  
(or **ECONO—LIMIT—T**) is the outside drybulb temperature above which the outside air damper returns to minimum position
- ENTHALPY—LIMIT** is the outside air enthalpy above which the outside air damper returns to minimum. There is no default; if not specified, there is no enthalpy limit.
- ECONO—LOW—LIMIT** is the outside drybulb temperature *below* which the economizer dampers return to a minimum position. (See Fig 3.21) This may be used to insure that core units are rejecting heat to the loop.
- MAX—OA—FRACTION** is the fraction of total supply air that can be drawn through the outside air dampers. The purpose of this keyword is to allow for the case where an intake is restricted.
- RECOVERY—EFF** is the fraction of heat that may be recovered from the return air and exchanged to the outside air stream using a heat wheel, air/air exchanger, or run around coils.

SYSTEM—AIR

- OA—CONTROL** The economizer type is selected with keyword **OA—CONTROL**, which takes code-words **TEMP**, **ENTHALPY**, or **FIXED**.
- TEMP* simulates a standard mixed-air-controlled economizer. The outside air damper is returned to minimum whenever the outside air temperature is higher than the value specified for **DRYBULB—LIMIT**. If **DRYBULB—LIMIT** is not specified, it defaults each hour to the return air temperature.
- ENTHALPY* simulates an economizer that returns the outside air damper to minimum if the outside air enthalpy is higher than the return air enthalpy *or* if the outside air temperature is higher than **DRYBULB—LIMIT** (which defaults to the return air temperature).
- FIXED* simulates no economizer; in other words, a fixed position minimum outside air damper.

---

In the left column above, bold-faced words are commands, non-bold words are keywords, and italicized words are code-words.



SYSTEM-FLUID

**MIN-FLUID-T** is the safety shutoff low limit temperature of the water loop for the water loop heat pump units (they do not operate if loop is at or below this temperature). The default is from **PLANT-ASSIGNMENT**.

**MAX-FLUID-T** is the safety shutoff high limit temperature of the water loop for the water loop heat pump. The default is from **PLANT-ASSIGNMENT**.

**FLUID-VOLUME** is the volume of water in the water loop of the HP system. The default is from **PLANT-ASSIGNMENT**. If a storage tank is to be simulated, this value should include its volume.

**COND-FLOW-TYPE** accepts code-words of **FIXED-FLOW** (the default) and **VARIABLE-FLOW**, which specifies that valves are present that cut off water flow when the compressors are inoperative.

**COND-WTR-FLOW** is the condenser (loop) water flow rate based on the cooling capacity of the HP units. The default is 3.0 gpm/ton

PLANT-ASSIGNMENT

**HP-LOOP-HEATING** accepts a code-word that specifies how HP loop heating is supplied. The choices are as follows:

*FROM-PLANT* specifies that a boiler in **PLANT** will supplement the HP water loop whenever insufficient heat is rejected to the loop by those units that are cooling.

*FROM-SYSTEMS* (the default) specifies that a boiler in **SYSTEMS** will supplement the HP water loop.

**HP-LOOP-COOLING** accepts a code-word that specifies how HP loop cooling is supplied. The choices are as follows:

*FROM-PLANT* specifies that a tower in **PLANT** will reject heat from the HP water loop to hold the maximum loop temperature.

*FROM-SYSTEMS* (the default) specifies that a tower in **SYSTEMS** will reject heat from the HP water loop.

Note: If **HP-LOOP-HEATING=FROM-PLANT** or **HP-LOOP-COOLING=FROM-PLANT**, then only one (or more) HP systems can be in the **PLANT-ASSIGNMENT**; i.e., you cannot combine an HP system with other system types in the **PLANT-ASSIGNMENT**. However, if **HP-LOOP-HEATING** and **HP-LOOP-COOLING** are *both* **FROM-SYSTEMS** (the default),

In the left column above, bold-faced words are commands, non-bold words are keywords, and italicized words are code-words.

Supplement — 2.1E Update

you can have HP and other systems in the PLANT—ASSIGNMENT. The one exception to this case: you cannot combine an HP system with a PSZ, PVAVS, or PVVT system that has CONDENSER—TYPE=WATER—COOLED.

The following keywords allow you to specify various parameters for a boiler when it is simulated in SYSTEMS for the HP system.

BOILER—SIZE	specifies the boiler size in MBtu/hr of output capacity. When not input, the program automatically sizes the capacity of the boiler.
BOILER—MIN—RATIO	is the boiler minimum operating ratio expressed as a fraction of the boiler's nominal output capacity. The default is 0.25.
BOILER—MAX—RATIO	is the boiler maximum operating ratio if overfired, expressed as a fraction of nominal capacity. The default is 1.2.
BOILER—MAX—SCH	accepts the u-name of a schedule of hourly values that specify a boiler's maximum operating capacity a fraction of design output; it may be used for demand control.
BOILER—EIR	specifies electric input as a ratio of the boiler's capacity. It represents energy for power burners and/or induced draft fans and pumps. The default of 0.02 represents a power burner with induced draft fan. This keyword should be set to 0.01 for atmospheric type boilers with only a hot water pump.
BOILER—HIR	specifies the ratio of heat input to boiler output; the default is 1.25. The inverse of HIR is the peak operating efficiency, which defaults to 0.80.
BOILER—HIR—FPLR	accepts the u-name of a default curve (or a user-specified CURVE—FIT) that modifies the rated peak heat input ratio as a function of part load ratio.
BOILER—TYPE	accepts code-words FUEL—BOILER (the default), and ELECTRIC—BOILER.
BOILER—SCH	accepts the u-name of a schedule that regulates the availability of the boiler. Allowed schedule values are 0=off, 1=on, and a value >1 is interpreted as the outside temperature below which the boiler is available. If not input, the boiler schedule will default to the CIRC—PUMP—SCH. See CIRC—PUMP—SCH.
BOILER—SET—POINT	is the midpoint of the boiler/loop controller setpoint. The default is 62.5°F.

Supplement — 2.1E Update

BOILER—SET—SCH	accepts the u-name of a schedule that allows you to adjust the boiler setpoint daily and/or seasonally.
BOILER—THROTTLE	is the throttling range of the boiler/loop temperature controller. The default is 10°F.
BOILER—LOSS	is the loss of the boiler and distribution system expressed as a fraction of the capacity of the boiler. The default is 0.01.

The following keywords allow you to specify various parameters for a cooling tower/water cooler when it is simulated in SYSTEMS for the HP system.

TWR—SIZE is the nominal rated output capacity, expressed in units of one million Btu's per hour, of each cell in the cooling tower. The capacity is the capacity of the tower at the TWR—DESIGN—WETBULB, and TWR—DESIGN—APPROACH. The range is determined by the program based on the design loop flowrate and load. If TWR—SIZE is not entered, the program will automatically size the tower based on the cooling equipment specified. Only one type and size of cooling tower may be entered in a PLANT—ASSIGNMENT.

TWR—NUM—CELLS are the total number of cells of the type and size previously specified. If not entered, the program will determine the number of cells required, based on a maximum load of 15 million Btu/hr per cell.

TWR—EIR is the electric input to nominal capacity ratio for the cooling tower fan expressed as  
$$\text{ratio} = (\text{fan electric power in Btu/hr}) / (\text{SIZE in Btu/hr})$$
where SIZE is the heat rejection capacity per cell as specified or defaulted. If not specified, the program will default the fan power consumption of an open tower to 0.0154 HP/gpm at the Cooling Tower Institute (CTI) rating conditions. This corresponds to an ELEC—INPUT—RATIO of approximately 0.0105 Btu/Btu.

TWR—SCH specifies the availability of the cooling tower. If not specified, the tower will be available whenever the loop pumps operate as specified in CIRC—PUMP—SCH.  
Acceptable values are:

- 0 Tower is not available.
- 1 Tower is available.
- >1 Tower is available whenever the ambient temperature is greater than this value.

TWR-SETPT-CTRL

Specifies the control for the exiting fluid temperature setpoint. The default is FIXED.

*FIXED*

the default, controls the tower to the fixed setpoint specified by TWR-SETPT-T or TWR-SETPT-SCH. Tower capacity adjusts according to the TWR-CAP-CTRL. To simulate a tower whose temperature floats with the load and wetbulb, simply specify a low setpoint, such as 60°F.

*WETBULB-RESET*

causes the setpoint to drop as the wetbulb drops. This approach recognizes that, as the wetbulb drops, the exiting tower temperature can also drop without any increase in tower energy consumption (although tower energy might otherwise be saved). At design conditions, the tower setpoint will be

$$\text{setpoint} = \text{TWR-DESIGN-WETBULB} + \text{TWR-DESIGN-APPROACH}$$

For a given load, a tower cannot achieve the same approach as the wetbulb drops (the approach will increase). Accordingly, the program will modify the approach as the wetbulb drops as follows:

$$\text{APP} = (\text{TWR-DESIGN-WETBULB} - \text{TWB}) * \text{TWR-RESET-RATIO} + \text{TWR-DESIGN-APPROACH}$$

Setpoint = TWB + APP, where APP is the achievable approach, and TWB is the current hour's wetbulb temperature.

TWR-SETPT-T

specifies the exiting water temperature setpoint when the TWR-SETPT-CTRL is FIXED. This value is defined to be the midpoint of the controller's throttling range. The default is 80°F. When TWR-SETPT-CTRL is WETBULB-RESET, this value acts as an upper limit on the tower setpoint.

TWR-SETPT-SCH

accepts the u-name of a schedule that allows the setpoint to be varied with time. If specified, the schedule value will override any value specified for TWR-SETPT-T.

TWR-THROTTLE

is the effective throttling range about the setpoint. The default is 10°F. When a variable speed fan is used, setting this value to a relatively broad range (10°F-30°F) will allow the fan to slowly unload as the tower temperature drops. In many cases, this strategy may result in the best overall system efficiency.

MIN-TWR-WTR-T

specifies the minimum temperature for leaving tower cooling water when TWR-SETPT-CTRL is WETBULB-RESET. This value acts as a lower limit on tower temperature as the wetbulb drops (chiller capacity may be impaired otherwise). The default is 65°F.

TWR-RESET-RATIO

specifies the ratio of the change in achievable approach with wetbulb. The default is 0.29. The default value is accurate for

an open tower at full load. Oftentimes, however, the load may be less at lower wet-bulbs since lower wet-bulbs often correspond to lower drybulbs and reduced building loads. To take this effect into account, you may want to experiment with other values, such as 0.40

**TWR-CELL-CTRL**

in multiple-cell towers, specifies whether the controls attempt to operate only the number of cells needed to meet the load, or operate as many cells as possible. Options are:

*MIN-CELLS*

the default, indicates that only the actual number of cells needed will be used. All other cells will be shut down with no water flow. If the tower is controlling to a fixed setpoint, the gallons/minute capacity per cell will increase as the wetbulb drops. The program will attempt to use as few cells as possible to cool the fluid. In no case, however, will the flow per cell be allowed to exceed the **MAX-RATIO** as specified in the **PART-LOAD-RATIO** command.

*MAX-CELLS*

**MAX-CELLS** indicates that all cells will be used in parallel. In no case, however, will the flow per cell be allowed to drop below the **MIN-RATIO** as specified in the **PART-LOAD-RATIO** command (unless only one cell is operating). This strategy will enhance the energy savings associated with two-speed or variable speed fans, and is strongly recommended.

**TWR-CAP-CTRL**

specifies the control method which regulates the tower exit temperature. The default is **ONE-SPEED-FAN**, which simulates a one-speed fan cycling on and off. Options are:

*FLUID-BYPASS*

utilizes a three-way valve to bypass water around the cooling tower. The valve modulates to maintain the tower setpoint. The tower fan runs continuously during all hours that a heat rejection load exists.

*ONE-SPEED-FAN*

the default, causes the one speed fan to cycle to maintain the tower setpoint. Note that DOE-2 assumes the fan can cycle as often as required to maintain the setpoint. In actual practice, fan cycling is usually limited to no more than 4-8 cycles per hour to protect the motor against burnout. This can cause wide fluctuations in the condenser loop temperature, which is not modeled in DOE-2.

*TWO-SPEED-FAN*

causes the fan to cycle between off, low and high speeds to maintain the tower setpoint.

*VARIABLE-SPEED-FAN*

modulates the airflow so that tower capacity exactly matches the load at the desired setpoint. This code word simulates both variable speed drives as well as variable pitch fans. Power consumption at reduced airflows is calculated using the

	TWR-FAN-FPLR curve in the EQUIPMENT-QUAD command.
TWR-FAN-OFF-CFM	is the airflow rate through the tower when the fans are off. That is, this is the flow rate caused by natural convection, divided by the flow rate at high speed (design). The default is 0.17.
TWR-FAN-LOW-CFM	specifies the ratio of airflow through the tower when the fans are on low speed, to the airflow at high speed. This keyword is used only when the TWR-CAP-CTRL is TWO-SPEED. The default is 0.50.
TWR-FAN-LOW-ELEC	specifies the ratio of the power consumed by the fan at low speed to the power consumed at high speed. This keyword is used only when the TWR-CAP-CTRL is TWO-SPEED. The default is 0.16.
TWR-MIN-FAN-SPEED	when a variable speed fan is used, specifies the minimum fraction of at nominal fan speed at which the fan can operate. The default is 0.40. If the load is such that the tower will overcool the fluid at this minimum speed, then the fan will cycle between off and minimum speed. It is possible that the tower fan may reach a "critical speed" as the airflow is reduced. This is because the static pressure capability of the fan will drop as the square of the speed. The static pressure drop of the tower, however, may not fall off as the square of the airflow, as air flowing through falling water does not obey the ideal fan laws. As a result, the fan may enter a "surge region" if the speed is sufficiently low. For specific applications, the tower manufacturer should be consulted.
TWR-PUMP-HEAD	is the pressure head in the tower water circulation loop. This head is used together with the fluid flowrate, impeller efficiency and motor efficiency to determine the power consumption of the condenser pump. The default is 20.
TWR-IMPELLER-EFF	specifies the impeller efficiency of the tower circulation pump. The default is 0.77.
TWR-MOTOR-EFF	specifies the efficiency of the tower pump motor. The default is 0.90.
TWR-CELL-MAX-GPM	specifies the largest allowable ratio of actual flow rate to nominal flow rate determined at the CTI conditions. The default is 2.0. You should refer to TWR-CELL-CTRL in PLANT-PARAMETERS for more information on the meaning of this keyword.

- TWR—CELL—MIN—GPM** specifies the smallest allowable fraction of the nominal flow rate for which the cooling tower is still rated. The nominal flow rate is determined at The Cooling Tower Institute (CTI) rating conditions of 95°F entering fluid temperature, 85°F leaving fluid temperature, and 78°F approach (95-85-78). These conditions correspond to a range of 10°F and an approach of 7°F. The default is 0.33. You should refer to TWR—CELL—CTRL for more information on the meaning of this keyword.
- TWR—DESIGN—WETBULB** is the wet-bulb temperature used in the cooling tower design calculations. If not specified, the default is 78°F, which corresponds to the point at which towers are nominally rated by the Cooling Tower Institute. Specifying a lower higher with other conditions fixed (including design approach) will cause the program to use a larger tower than otherwise. Energy consumption may then either increase or decrease depending on the method of TWR—CAP—CTRL and the temperature setpoint.
- TWR—DESIGN—APPROACH** is the approach used in the cooling tower design calculations. If not specified, the default is 7°F, which corresponds to the point at which towers are nominally rated by the Cooling Tower Institute (95°F entering fluid temperature, 85°F leaving, when the wetbulb is 78°F). Specifying a higher approach with other conditions fixed (including design wetbulb) will cause the program to use a smaller tower than otherwise. Energy consumption may then either increase or decrease depending on the method of TWR—CAPACITY—CTRL and the temperature setpoint.
- TWR—FAN—FPLR** accepts the u-name of a CURVE-FIT instruction that defines a cubic equation. That equation will be used to express the tower fan horsepower as the airflow drops as a fraction of the horsepower at full airflow.
- TWR—GPM—FRA** accepts the u-name of a CURVE—FIT instruction that defines a bi-quadratic equation. That equation will be used to express an intermediate variable which is a function of the range and approach. The intermediate variable is in turn used in the curve TWR—GPM—FWB.
- TWR—GPM—FWB** accepts the u-name of a CURVE-FIT instruction that defines a bi-quadratic equation. That equation defines the current tower capacity relative to the capacity at the CTI design conditions. It is a function of TWR—GPM—FRA, defined above, and the wetbulb temperature.

Supplement -- 2.1E Update

The following keywords allow you to specify various parameters for a water loop circulating pump when it is simulated in SYSTEMS for the HP system.

- CIRC-IMPELLER-EFF is water loop circulating pump impeller efficiency. The default is 0.77.
- CIRC-MOTOR-EFF is water loop circulating pump motor efficiency. The default is 0.90.
- CIRC-HEAD is the water loop circulating pump head. The default is 60 feet.
- CIRC-PUMP-TYPE accepts code-words of FIXED-FLOW (the default) or VARIABLE-FLOW. The latter corresponds to HP units that cut the flow of water whenever the unit is off.
- CIRC-MIN-PLR is the minimum part load allowed for VARIABLE-FLOW pumping, below which the flow is considered to be constant. Default is 0.5.
- CIRC-PUMP-FPLR accepts the u-name of default curve (or user-specified CURVE-FIT) that modifies the pumping energy as a function of part load ratio. Default is CIRC-PUMP-CURVE.
- CIRC-PUMP-SCH accepts the u-name of a schedule that serves as the main control over the operation of the HP system. The default is always on. An hourly value of 0=off, and 1=on. Both BOILER-SCH and TWR-SCH default to the hourly and seasonal profile of this schedule and when both are input they should be compatible with one another. If not compatible, cooling may not be available from the tower when the pumps are on. If system fans are cycled on for night operation, the pumps will also be cycled on.



## Supplement -- 2.1E Update

These keywords allow you to specify various parameters for the water loop. All three may also be input in the SYSTEM-FLUID instruction; however, an input here takes precedence.

- MAX-FLUID-T is the maximum loop temperature. Above this temperature, the safety cut-off of the unit prevents it from operating. The default of 120°F.
- MIN-FLUID-T is the minimum loop temperature. Below this temperature, the safety cut-off of the unit prevents it from operating. The default of 50°F.
- FLUID-VOLUME is the volume of water (including storage) in the loop based on the nominal tonnage of the units connected to the loop. The default is 15.0 gallons/ton (typical value, without storage, ranges from 3 to 10).
- COND-WTR-FLOW is the condenser (loop) water flow rate based on the cooling capacity of the HP units. The default is 3.0 gpm/ton

## VARIABLE SPEED ELECTRIC HEAT PUMP

### Introduction

A model of a variable speed electric heat pump has been added to DOE-2.1E. Electronically commutated motors driving the compressor and indoor fan allow the cooling and heating capacities to be continuously varied through a ratio of roughly 3:1 as a function of the load. Below the minimum compressor RPM, the unit cycles to match the load. Supplemental heating is normally available to meet heating loads above the unit's capacity. The variable speed electric heat pump configuration, which can be used in the RESVVT, PSZ, PVAVS, and PVVT systems, is shown in Fig. 3.8.

SRG-93-1102

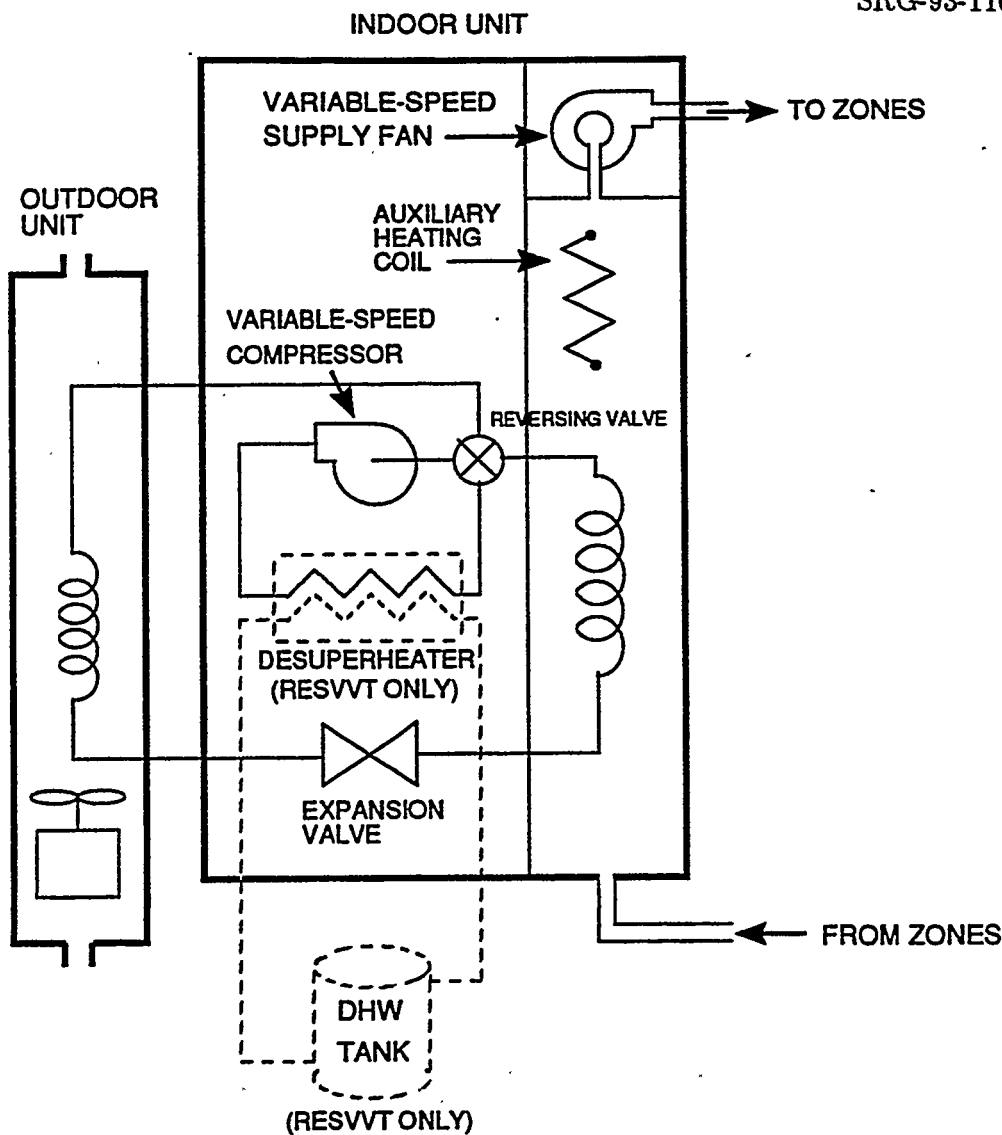

Figure 3.8: System configuration for a variable speed electric heat pump.

**Input**

The VSEHP is the default unit for SYSTEM-TYPE = RESVVT. For system types PSZ, PVAVS, and PVVT the unit can be specified by setting HEAT-SOURCE = HEAT-PUMP in the SYSTEM command and COMPRESSOR-TYPE = VARIABLE-SPEED in the SYSTEM or SYSTEM-EQUIPMENT commands. A number of keywords and curves are used to specify the size and define the performance of the unit. The keywords COOLING-CAPACITY, COOL-SH-CAP, HEATING-CAPACITY, COOLING-EIR, HEATING-EIR, COOL-CAP-FT, COOL-SH-CAP-FT, and HEAT-CAP-FT are used in the usual manner as described in the *Reference Manual (2.1A)*. The following keywords (in SYSTEM or SYSTEM-EQUIPMENT commands) are new or are used in a new way.

**SYSTEM or SYSTEM-EQUIPMENT**

- COOL-RPM-LIMITS**            A list of two values. The first is the maximum RPM during cooling; the second is the minimum. DOE-2 actually only uses the ratio of these two numbers.
- COOL-CAP-FRPM**            A curve that gives the variation in compressor cooling capacity as a function of the motor RPM. At maximum cooling RPM the curve is normalized to be 1.0. This curve is inverted by DOE-2 to obtain the RPM from the unit cooling load.
- COOL-EIR-FRPM**            A curve that gives the variation in the unit EIR as a function of motor RPM. The curve is normalized to 1.0 at maximum cooling RPM. It is used to obtain the part load power consumption of the unit. For variable speed compressors it replaces COOL-EIR-FPLR used for constant speed units.
- COOL-EIR-FT**              A curve that describes the variation in the EIR at maximum RPM as a function of entering wetbulb temperature and outside drybulb temperature. Note that this is an old keyword used in a slightly different way. The curve is normalized to 1.0 at the ARI rating point (entering wetbulb 67°F, outside drybulb 95°F).
- COOL-EIR-LS-FT**          A curve that describes the variation in the EIR at minimum RPM as a function of entering wetbulb temperature and outside drybulb temperature. DOE-2 interpolates between this curve and COOL-EIR-FT to obtain the entering wetbulb - outside drybulb correction factor for RPM's between the minimum and the maximum. This curve is also normalized to 1.0 at the ARI rating point.
- COOL-CLOSS-FPLR**        This curve gives (cycling part load ratio)/(fraction of hour unit runs) as a function of cycling part load ratio. The cycling part load ratio is defined as the cooling load divided by the cooling capacity at minimum RPM. The curve is used only when the unit is cycling; that is, whenever the cooling load is less than the cooling capacity at minimum RPM. It expresses the extra

## Supplement - 2.1E Update

run time needed to make up for cycling losses. The curve is normalized to 1.0 at minimum RPM (cycling part load ratio = 1.0).

COOL-CLOSS-MIN

The minimum cycling part load ratio used as input to COOL-CLOSS-FPLR.

HEAT-RPM-LIMITS

A list of two values. The first is the maximum RPM during heating; the second is the minimum. DOE-2 actually only uses the ratio of these two numbers.

HEAT-CAP-FRPM

A curve that gives the variation in unit heating capacity as a function of the motor RPM. At maximum RPM the curve is normalized to be 1.0. This curve is inverted by DOE-2 to obtain the RPM when given the unit heating load.

HEAT-EIR-FRPM

A curve that gives the variation in the unit EIR during heating as a function of motor RPM. The curve is normalized to 1.0 at maximum heating RPM. It is used to obtain the part load power consumption of the unit. For variable speed heat pumps it replaces HEAT-EIR-FPLR used for constant speed units.

HEAT-EIR-FT

A curve that describes the variation in the EIR for heating at maximum RPM as a function of entering wetbulb temperature and outside drybulb temperature. Note that this is an old keyword used in a slightly different way. The curve is normalized to 1.0 at the ARI rating point (entering wetbulb 67°F, outside drybulb 95°F).

HEAT-EIR-LS-FT

A curve that describes the variation in the EIR for heating at minimum RPM as a function of entering wetbulb temperature and outside drybulb temperature. DOE-2 interpolates between this curve and HEAT-EIR-FT to obtain the entering wetbulb - outside drybulb correction factor for RPM's between the minimum and the maximum. This curve is also normalized to 1.0 at the ARI rating point.

HEAT-CLOSS-FPLR

This curve gives (cycling part load ratio)/(fraction of hour unit runs) as a function of cycling part load ratio. The cycling part load ratio is defined as the heating load divided by the heating capacity at minimum RPM. The curve is used only when the unit is cycling; that is, whenever the heating load is less than the heating capacity at minimum RPM. It expresses the extra run time needed to make up for cycling losses. The curve is normalized to 1.0 at minimum RPM (cycling part load ratio = 1.0).

## Supplement — 2.1E Update

HEAT—CLOSS—MIN	The minimum cycling part load ratio used as input to HEAT—CLOSS—FPLR.
DEFROST—FRAC—FT	A curve that gives defrost run time (expressed as a fraction of total run time) as a function of outside wetbulb and outside drybulb temperature.

### Electric Heat Pump Heat Recovery

When electric heat pumps are in the cooling mode, the heat rejected by the condenser is potentially available for other uses, such as heating domestic hot water. There are several ways of recovering heat from an electric heat pump. The simplest is to put a heat exchanger in the circuit immediately after the compressor. Water from the domestic hot water tank circulates through one side of the heat exchanger, picking up some of the "superheat" from the hot compressed gas in the other side of the heat exchanger. The gas remains in its gaseous state and is condensed in the condenser in the normal manner. This arrangement is called a "desuperheater". Another method is to have two separate condensers. When there is a hot water load, the hot gas—DHW heat exchanger acts as a condenser and the refrigerant is never sent through the normal condenser. The second condenser also allows the heat pump to run in order to meet a hot water load even when there is no cooling load. This second arrangement (called "full-condensing") is more complicated than the first, but allows more heat to be recovered and more effective use of the heat pump.

In DOE-2.1E a desuperheater can be simulated for the variable speed electric heat pump. Simulation of the full-condensing arrangement is not yet available. To simulate a desuperheater, set DHW—TYPE = DESUPERHEAT in the PLANT—ASSIGNMENT command. The following keywords, in the SYSTEM or SYSTEM—EQUIPMENT command, describe the heat recovery.

### SYSTEM or SYSTEM—EQUIPMENT

COOL—WASTE—HEAT	The fraction of the cooling load available as recoverable heat at full load and rated conditions.
COOL—WH—FT	A curve giving the variation in COOL—WASTE—HEAT as a function of entering wetbulb and outside drybulb temperature. The curve is normalized to 1.0 at full load and entering wetbulb = 67°F, outside drybulb = 95°F.
COOL—WH—FRPM	This curve describes the variation in COOL—WASTE—HEAT as a function of motor RPM. The curve is normalized to 1.0 at full RPM.
HEAT—WASTE—HEAT	The fraction of the heating load available as recoverable heat at full load and rated conditions.
HEAT—WH—FT	A curve giving the variation in HEAT—WASTE—HEAT as a function of outside drybulb temperature. The curve is normalized to 1.0 at full load and outside drybulb = 47°F.

**HEAT—WH—FRPM**

This curve describes the variation in HEAT—WASTE—HEAT as a function of motor RPM. The curve is normalized to 1.0 at full RPM.

Desuperheaters are often operated in the heating as well as the cooling mode. When operated in the heating mode, the heat exchanger is not picking up waste heat. Instead it is lowering the heat pump's space heating capacity. Obviously this is effective only if extra heating capacity is available, and this is highly dependent on the climate. For locations with very mild winters, operation of the desuperheater in the heating mode can be effective. DOE-2 assumes that the desuperheater operates in both the heating and cooling modes. To prevent operation in the heating mode, the user should set HEAT—WASTE—HEAT = 0.

**Fans**

Indoor fan performance and energy consumption are specified in the usual way with the SYSTEM or SYSTEM—FANS commands that apply to the supply fan (SUPPLY—CFM, SUPPLY—KW, FAN—CONTROL etc.). Outdoor fan energy consumption is always included in the default EIR and performance curves. However outside fan performance and energy consumption can be specified separately. This is done through the existing keywords OUTSIDE—FAN—ELEC (replaces OUTSIDE—FAN—KW), OUTSIDE—FAN—T, and OUTSIDE—FAN—MODE, plus the following new keywords.

**SYSTEM or SYSTEM—FANS**

**OUTSIDE—FAN—CFLT**

This curve is a modifier for outdoor fan power during cooling as a function of the cooling part load ratio and the condenser entering temperature (either outside drybulb or evaporative precooler exit temperature). The outdoor fan energy is multiplied by the value of this curve hourly. This allows the simulation of multi-speed or multi-fan condensing units.

**OUTSIDE—FAN—HFLT**

This curve provides a modifier for outdoor fan power during heating as a function of the heating part load ratio and the outside drybulb temperature. The outdoor fan energy is multiplied by the value of this curve hourly. This allows the simulation of multi-speed or multi-fan units.

**Note:**

The VSEHP should only be used in conjunction with the RESVVT system. Use in other systems will give incorrect results.

## GAS HEAT PUMPS

### Introduction

The gas heat pump (GHP) model simulates a natural gas engine-driven compressor that uses a standard refrigerant cycle to provide heating and cooling. The unit can directly replace the standard electric motor/compressor set found in conventional DX packaged cooling (and/or heating) systems. The GHP includes a hydronic boiler or furnace for supplemental heating. Operation of the supplemental boiler/furnace and reverse-cycle heating mode defrost operation is modeled in a similar manner to the conventional system. The GHP also includes an option to use waste heat generated by the gas engine to directly satisfy domestic hot water loads. The gas heat pump configuration, which can be placed in PSZ, PVAVS, PTAC, PVVT, and RESYS systems, is shown in Fig. 3.9.

SRG-92-25

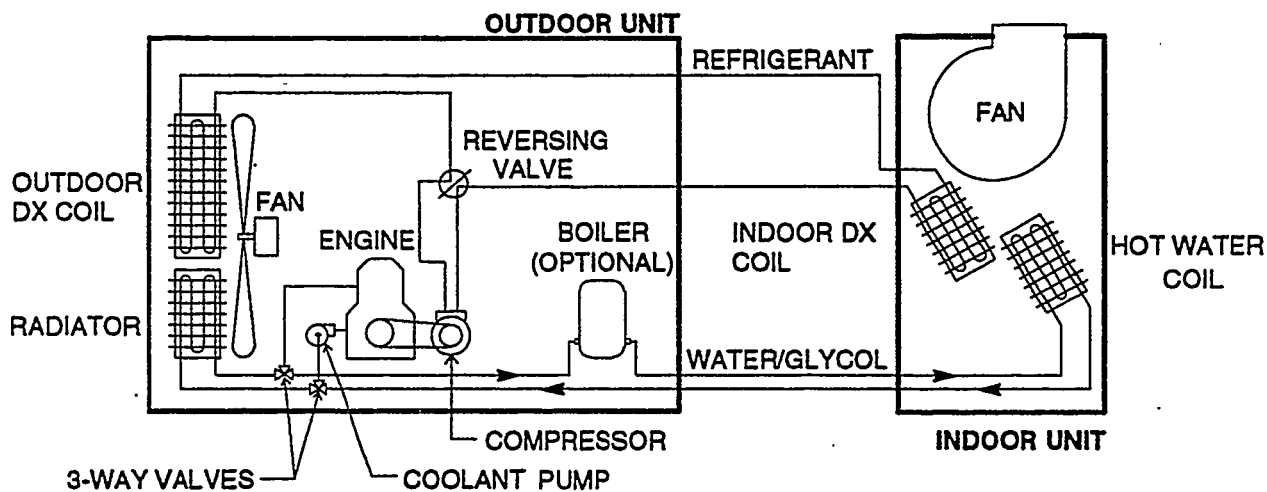

**Figure 3.9:** System configuration for a typical packaged system with a gas engine-driven heat pump (GHP). The arrangement of blower and coils for the indoor unit depends upon the particular air handling system type. Four-pipe GHP systems have a water/glycol loop with a hot water coil; two-pipe GHP systems do not.

### Description of Gas Heat Pump Systems

GHP systems are classified as “two-pipe” or “four-pipe” depending upon the presence of a water/glycol loop between the indoor and outdoor units. The default GHP simulation is a four-pipe system. The engine/compressor unit and refrigerant loop are similar to a typical air-to-air heat pump with a natural gas engine instead of the electric compressor motor. The gas engine not only drives the compressor, but it also rejects heat that can be recovered for space heating or other uses. The water/glycol loop provides engine cooling, recovers engine waste heat, and serves the optional hydronic boiler. During cooling operation, the water/glycol loop cools the engine through the radiator or it may be used to recover engine waste heat for domestic hot water or other uses. During heating operation, the water/glycol loop recovers engine waste heat and supplies the hot water coil in the indoor unit to supplement the heat pump cycle.

GHP system operation is similar to that of other variable-speed heat pumps. The system modulates the engine/compressor speed to match the load, as shown in Fig. 3.10. At very low loads, the system cycles at minimum speed. At higher loads, the system will run continuously and modulate the engine speed. As the load increases, the system speed increases until maximum speed is reached. In heating, when maximum speed operation is insufficient, supplemental heat will operate (if available).

SRG-92-26

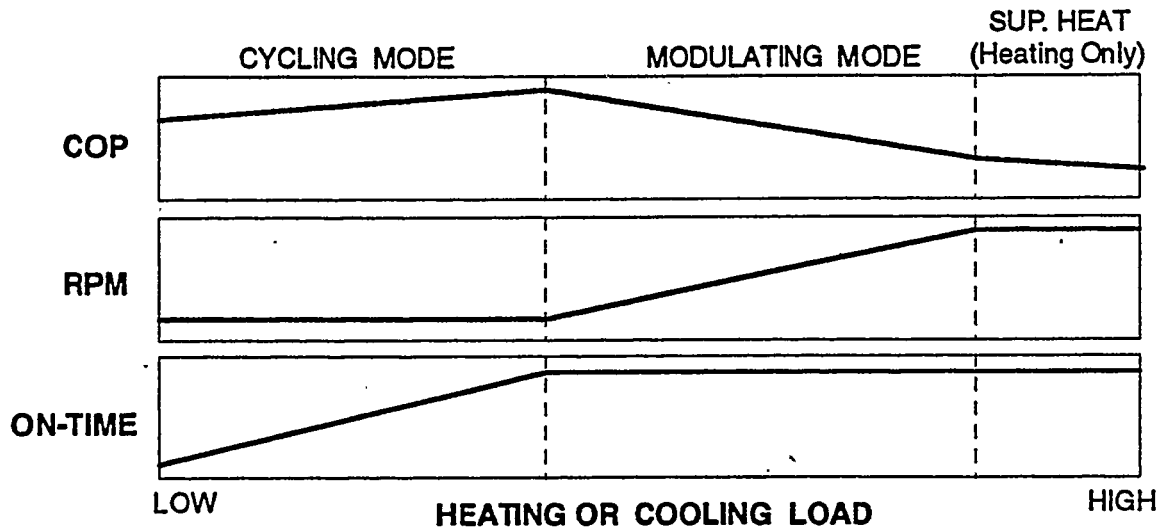

**Figure 3.10:** Gas heat pump system operation. At very low loads, the system cycles at minimum speed. At higher loads, the system will run continuously and modulate the engine speed to match the load. In heating, when maximum speed operation is insufficient, supplemental heat will operate (if available). The COP decreases during cycling and at higher engine speeds.

There are several new hourly report variables related to gas heat pumps. These are described in Appendix A under SYSTEMS, VARIABLE-TYPE = u-name of SYSTEM.

### How to Specify a Gas Heat Pump

The method used to simulate the gas heat pump, in terms of the sequence of events during the course of the hourly simulation, is the same as with conventional systems. The gas heat pump performance model uses some of the same design value keywords and curves as conventional units. New curves and keywords have been added to describe the part load performance when the system is modulating (varying engine speed) and when the system is cycling. Standard keywords which apply to the GHP include COOLING-CAPACITY, COOL-CAP-FT, COOL-SH-CAP, COOL-SH-CAP-FT, COOLING-EIR, COOL-EIR-FT, HEATING-CAPACITY, HEAT-CAP-FT, HEATING-EIR, and HEAT-EIR-FT. The following new keywords are used to describe GHP performance. *The default GHP performance data is representative of a four-pipe system; you must input appropriate performance curves to simulate a two-pipe system.* The HEAT-SOURCE keyword under the SYSTEM command is used to select the gas heat pump for both heating and cooling, as described below.



SYSTEM

HEAT—SOURCE

is the keyword that identifies the heat source for the distribution system for heating coils.

*GAS—HEAT—PUMP*

This code-word is valid for SYSTEM—TYPES=PSZ, PVAVS, PTAC, RESYS, and PVVT. If this value is specified it indicates that a natural gas engine driven heat pump is to be used for both heating and cooling. The speed (RPM) of the engine is adjusted for capacity modulation. Backup heat is available from a FURNACE or GAS\—HYDRONIC source (and with a capacity) defined as with other types of heat pumps. The heating and cooling gas input, capacities, off design point performance, part load performance, and minimum operating points are defined using the same keywords as conventional heat pumps plus the new keywords below, which apply only to GAS—HEAT—PUMPS.

SYSTEM—EQUIPMENT

COOL—RPM—LIMITS

This is a list of two values which specify the maximum and minimum engine RPM during cooling operation. The maximum value must be listed first. The default is (3000,1000).

COOL—CAP—FRPM

This curve describes how the capacity of the engine/compressor pair (or motor/compressor pair for electric units) changes as the RPM of the unit is reduced. The value of the function is normalized to 1.0 at high RPM. This curve is used to determine the RPM of the engine/motor at part load conditions.

COOL—EIR—FRPM

This curve describes how the fuel/power input to the engine/compressor pair (or motor/compressor pair for electric units) changes as the RPM of the unit is reduced. The value of the function is normalized to 1.0 at high RPM. This curve is used to determine the fuel/power input to the engine/motor at part load conditions in place of the COOL—EIR—FPLR curve used for conventional constant speed motor compressors.

COOL—CLOSS—FPLR

This curve gives the fraction of the hour the unit runs (as a fraction of part load ratio) when the unit is cycling. The unit is cycling when the load on the unit is less than the unit capacity at the minimum RPM (see COOL—RPM—LIMITS). The curve is normalized to 1.0 at a run-time fraction of 1.0.

COOL—CLOSS—MIN

This is the minimum input value for the COOL—CLOSS—FPLR curve.

HEAT—RPM—LIMITS

This is a list of two values which specify the maximum and minimum engine RPM during heating operation. The

maximum value must be listed first. The default is (3000,1000).

**HEAT-CAP-FRPM**

This curve describes how the capacity of the engine/compressor pair (or motor/compressor pair for electric units) changes as the RPM of the unit is reduced. The value of the function is normalized to 1.0 at high RPM. This curve is used to determine the RPM of the engine/motor at part load conditions.

**HEAT-EIR-FRPM**

This function describes how the fuel/power input to the engine/compressor pair (or motor/compressor pair for electric units) changes as the RPM of the unit is reduced. The value of the function is normalized to 1.0 at high RPM. This curve is used to determine the fuel/power input to the engine/motor at part load conditions in place of the HEAT-EIR-FPLR curve used for conventional constant speed motor compressors.

**HEAT-CLOSS-FPLR**

This curve gives the fraction of the hour the unit runs (as a function of part load ratio) when the unit is cycling. The unit is cycling when the load on the unit is less than the unit capacity at the minimum RPM (see HEAT-RPM-LIMITS). The curve is normalized to 1.0 at a run-time fraction of 1.0.

**HEAT-CLOSS-MIN**

This is the minimum input value for the HEAT-CLOSS-FPLR curve.

**DEFROST-FRAC-FT**

This curve gives the defrost run time, expressed as a fraction of the total run-time as a function of outside WBT and outside DBT. For example, a value of 0.1 means 0.1x60, or 6 minutes of defrost time per hour of run-time.

**Supplemental Heating for the Gas Heat Pump**

The GHP simulation allows either a gas furnace or a gas hydronic boiler as the supplemental heat source. Four-pipe GHP systems, which have a water/glycol loop for waste heat recovery (Figure 3.9), will typically have a gas hydronic boiler. Two-pipe GHP systems, which do not have a water/glycol loop, will typically have a gas furnace. Supplemental heat is controlled by the standard keywords HP-SUPP-HT-CAP, MAX-HP-SUPP-T, MIN-HP-T. The supplemental heat source is specified by:

**HP-SUPP-SOURCE**

Input for this keyword is a code-word that specifies the source for the heat pump supplemental heating. Legal values for this keyword are ELECTRIC, HOT-WATER and FURNACE. Default value is ELECTRIC. For GHP systems, only GAS-HYDRONIC and FURNACE are valid.

*GAS-HYDRONIC*

Indicates that the supplemental heat source is a gas-fueled hydronic boiler. This type of equipment requires the circulation pump (see UNIT-PUMP-ELEC below) to operate if the supplemental unit is on but the GHP is off. For

GAS-HYDRONIC, other applicable keywords are FURNACE-HIR, FURNACE-AUX, FURNACE-AUX-KW, and UNIT-PUMP-ELEC.

**FURNACE**

Indicates that the supplemental heat source is a gas-fueled furnace. For FURNACE, other applicable keywords are FURNACE-HIR, FURNACE-AUX, and FURNACE-AUX-KW.

**Gas Heat Pump Electrical Consumption**

Six components of the GHP can consume electricity: indoor fan, outdoor fan, circulation pump, supplemental heat combustion fan, system controls, and crankcase heater. The indoor fan energy is specified by the standard supply fan keywords (SUPPLY-KW, FAN-CONTROL, etc.) applicable for each system type, plus the new INDOOR-FAN-MODE keyword. Other standard SYSTEM-EQUIPMENT keywords that apply to the GHP are OUTSIDE-FAN-ELEC (which has replaced OUTSIDE-FAN-KW), OUTSIDE-FAN-MODE, OUTSIDE-FAN-T, FURNACE-AUX-KW, CRANKCASE-HEAT, and CRANKCASE-MAX-T. New keywords affecting GHP electrical consumption under the SYSTEM-EQUIPMENT command are:

**OUTSIDE-FAN-CFLT** This curve provides a modifier for outdoor fan power during the cooling mode of operation as a function of the cooling part load ratio and the condenser entering temperature (either outside drybulb or evaporative precool exit temp). The outdoor fan energy is multiplied by the value of this curve hourly. This allows the simulation of multi-speed or multi-fan condensing units.

**OUTSIDE-FAN-HFLT** This curve provides a modifier for outdoor fan power during the cooling mode of operation as a function of the heating part load ratio and the condenser entering temperature (outside drybulb). The outdoor fan energy is multiplied by the value of this curve hourly. This allows the simulation of multi-speed or multi-fan condensing units.

**UNIT-PUMP-ELEC** This value is used to calculate the pump power consumption during operation of the GHP or its supplemental gas hydronic boiler during operation. The value is specified as watts of pump power per BTU of the GHP's COOLING-CAPACITY (either specified or calculated) at ARI rated conditions.

**UNIT-AUX-KW** This is the power consumption in kW of GHP auxiliaries, such as controls, that operate continuously.

**Gas Heat Pump Waste Heat Recovery**

One feature of GHP systems is the ability to recover waste heat from the engine jacket and exhaust. During heating operation, the waste heat will automatically be used for space heating by supplementing the heating output of the refrigerant cycle (the default HEAT-CAP-FT, HEAT-CAP-FRPM, HEAT-EIR-FT, and HEAT-EIR-FRPM performance curves are assumed to include the recovered waste heat available for space heating). The recovered waste heat may also be used for space heating (preheat, zone coils, and/or baseboards) and domestic hot water heating. Waste heat use is controlled by the following keywords.

**SYSTEM-EQUIPMENT**

WASTE-HEAT-USE

takes code-words SPACE-HEAT (default) or SPACE-HEAT+DHW.

*SPACE-HEAT*

When the GHP is in the *heating mode*, waste heat is used to supplement the output of the main heating coil. If BASEBOARD-SOURCE, PREHEAT-SOURCE, and/or ZONE-HEAT-SOURCE = GAS-HEAT-PUMP (see below), waste heat will also be used for baseboards, preheat, and/or reheat, respectively, but only if the main heating coil needs are met. The GHP supplementary heating unit (usually a gas-hydronic boiler) will make up the difference between baseboard/preheat/reheat demand and what is provided by waste heat.

When the GHP is in the *cooling mode*, waste heat goes to baseboards, preheat, and/or reheat if BASEBOARD-SOURCE, PREHEAT-SOURCE, and/or ZONE-HEAT-SOURCE, respectively, = GAS-HEAT-PUMP.

*SPACE-HEAT+DHW*

Same as WASTE-HEAT-USE = SPACE-HEAT except that waste heat will also supplement a domestic hot water heater, if present (see DHW- keywords in PLANT-ASSIGNMENT).

COOL-WH-FT

This curve describes how the waste heat generated by the engine changes as the operating condition (outside air temperature) varies. The value of the function is normalized to 1.0 at ARI outside drybulb (95°F) and full RPM.

COOL-WH-FRPM

This curve describes how the waste heat generated by the engine changes as the RPM of the unit is reduced. The value of the function is normalized to 1.0 at full RPM.

COOL-WASTE-HEAT

This is the fraction of heat input to cooling (heating value of gas consumed) that is available as recoverable waste heat at full load and rated conditions.

HEAT-WH-FT

This curve describes how the waste heat generated by the engine changes as the operating condition (outside air temperature) varies. The value of the function is normalized to 1.0 at

ARI outside drybulb (47°F).

**HEAT–WH–FRPM**

This curve describes how the waste heat generated by the engine changes as the RPM of the unit is reduced. The value of the function is normalized to 1.0 at full RPM.

**HEAT–WASTE–HEAT**

This is the fraction of heat input to heating (heating value of gas consumed) that is available as recoverable waste heat at full load and rated conditions.

**SYSTEM**

**PREHEAT–SOURCE**  
**ZONE–HEAT–SOURCE**  
**BASEBOARD–SOURCE**

each take code-words **GAS–HEAT–PUMP**, **FURNACE**, or **GAS–HYDRONIC** for PSZ, PVAVS, and PVVT systems

*GAS–HEAT–PUMP*

If **HEAT–SOURCE = GAS–HEAT–PUMP** for a PSZ, PVAVS, or PVVT system, then waste heat from the gas heat pump can be used for preheat (if **PREHEAT–SOURCE = GAS–HEAT–PUMP**), for zone-level reheat (if **ZONE–HEAT–SOURCE = GAS–HEAT–PUMP**), and/or for baseboard heating (if **BASEBOARD–SOURCE = GAS–HEAT–PUMP**).

*FURNACE*

The heat source for preheat, reheat, or baseboards is a furnace.

*GAS–HYDRONIC*

The heat source for preheat, reheat, or baseboards is the hydronic supplemental boiler for the gas heat pump. This option is only valid if **HEAT–SOURCE = GAS–HEAT–PUMP** and **HP–SUPP–SOURCE = GAS–HYDRONIC**.

---

In the left column, bold-faced words are commands, non-bold words are keywords, and italicized words are code-words.

**Gas Heat Pump Examples:**

- (1) A fully-defaulted, auto-sized, four-pipe gas heat pump with hydronic boiler in a PSZ system.

GHP = SYSTEM    SYSTEM-TYPE = PSZ  
                   HEAT-SOURCE = GAS-HEAT-PUMP

·  
·  
·

- (2) A four-pipe GHP air conditioner with furnace in a PVAVS system. Waste heat is used for reheat when in the cooling mode. Space heating by the GHP has been disabled by specifying a large value for MIN-HP-T.

GAC = SYSTEM    SYSTEM-TYPE                = PVAVS  
                   HEAT-SOURCE                = GAS-HEAT-PUMP  
                   ZONE-HEAT-SOURCE        = GAS-HEAT-PUMP  
                   HP-SUPP-SOURCE            = FURNACE  
                   HP-SUPP-HT-CAP            = -90000  
                   MAX-HP-SUPP-T             = 70  
                   MIN-HP-T                    = 1500

·  
·  
·

MISCELLANEOUS CHANGES TO SOME SYSTEMS KEYWORDS

Following is a list of some SYSTEMS keywords that have been modified in 2.1E by adding code-words or changing the keyword name.

<b>HEAT-SOURCE</b>	takes new code-word, <b>GAS-HEAT-PUMP</b> , for RESYS, PSZ, PVAVS, PVVT, and PTAC systems. <b>HEAT-SOURCE</b> = <b>HEAT-PUMP</b> plus <b>COMPRESSOR-TYPE</b> = <b>VARIABLE-SPEED</b> invokes a variable speed electric heat pump (p.3.43), new in 2.1E
<b>ZONE-HEAT-SOURCE</b>	takes new code-word, <b>GAS-HEAT-PUMP</b> , for PSZ, PVAVS, and PVVT systems. The previously-allowed code-words, <b>GAS-FURNACE</b> and <b>OIL-FURNACE</b> , have been replaced with <b>FURNACE</b> , since the fuel source is now determined by the meter to which the equipment is connected.
<b>PREHEAT-SOURCE</b>	takes new code-word, <b>GAS-HEAT-PUMP</b> , for PSZ, PVAVS, and PVVT systems. The previously-allowed code-words, <b>GAS-FURNACE</b> and <b>OIL-FURNACE</b> , have been replaced with <b>FURNACE</b> , since the fuel source is now determined by the meter to which the equipment is connected.
<b>BASEBOARD-SOURCE</b>	takes new code-word, <b>GAS-HEAT-PUMP</b> , for RESYS, PSZ, PVAVS, PVVT, and PTAC systems. The previously-allowed code-words, <b>GAS-FURNACE</b> and <b>OIL-FURNACE</b> , have been replaced with <b>FURNACE</b> , since the fuel source is now determined by the meter to which the equipment is connected.
<b>FURNACE-AUX-KW</b>	This new keyword is the furnace electrical auxiliary power (kW) consumed during furnace run time. It is used for all furnaces including the gas heat pump supplemental furnace. Default is 0.0 except when used with a gas heat pump, in which case the default is 0.1 kW.
<b>OUTSIDE-FAN-ELEC</b>	replaces <b>OUTSIDE-FAN-KW</b> . It gives the condenser fan power (watts) per unit cooling capacity (Btu).
<b>INSIDE-FAN-MODE</b>	This new keyword accepts the code-words <b>CONTINUOUS</b> (default) and <b>INTERMITTENT</b> for system types PSZ, PVAVS, PVVT. Controls indoor fan operation within the deadband.
<i>CONTINUOUS</i>	The indoor fan always runs when it is scheduled on by the <b>FAN-SCHEDULE</b> (or with <b>NIGHT-CYCLE-CTRL</b> )
<i>INTERMITTENT</i>	The indoor fan operates during the times as in <i>CONTINUOUS</i> , except only for that fraction of the hour required for space heating or cooling.

---

In the left column, bold-faced words are commands, non-bold words are keywords, and italicized words are code-words.

## DOMESTIC HOT WATER HEATER AND TANK MODEL IN SYSTEMS

### Introduction

A domestic hot water (DHW) heater and tank model has been added to SYSTEMS at the PLANT-ASSIGNMENT level. This model combines features of the domestic hot water heater and hot water storage tank in PLANT. That is, it can store hot water for later use and use stored hot water as well as heater capacity to meet an existing domestic hot water load. Adding this model to SYSTEMS allows DOE-2 to simulate the use of stored waste heat from gas or electric heat pumps to meet the domestic hot water load.

The following keywords in the PLANT-ASSIGNMENT command in SYSTEMS describe the domestic hot water heater and tank.

### PLANT-ASSIGNMENT

DHW-SIZE	The size, in gallons, of the DHW tank. If no size is input, but DHW-SCH and DHW-GAL/MIN are specified, the tank is default sized to meet the largest hourly flow for the year.
DHW-GAL/MIN (or DHW-FLOW)	Is the supply flow of building-level domestic hot water (gallons per minute). This flow is multiplied hourly by the DHW-SCH schedule value. This is <i>in addition</i> to that specified with SOURCE-TYPE = HOT-WATER in SPACE-CONDITIONS in LOADS, and does not contribute to space thermal loads.
DHW-SCH	Is the schedule of building-level domestic hot water use. It multiplies DHW-GAL/MIN.
DHW-SUPPLY-T	Is the building-level domestic hot water supply temperature (°F); the default is 140°F.
DHW-INLET-T-SCH	Is the schedule of building-level domestic hot water inlet temperature (°F). The default is the monthly ground temperature from the weather tape.
DHW-HEAT-RATE	The capacity in Btu/hr of the burner, immersion heater, or heat pump used to meet the DHW load and charge the tank. If this keyword is not input, but DHW-SCH and DHW-GAL/MIN are specified, the default is set to meet the largest hourly hot water heating load.
DHW-TYPE	The type of DHW unit. The types are as follows:
GAS	is a gas or fuel fired unit (the default);
ELECTRIC	is an electric DHW unit;



Supplement -- 2.1E Update

<i>HEAT-PUMP</i>	is a DHW unit using an electric heat pump for tank charging;
<i>DESUPERHEAT</i>	is an electric DHW unit that can be charged with the superheat from an electric heat pump; and
<i>WASTE-HEAT</i>	is a gas DHW unit that can use the waste heat from a gas heat pump to charge the tank.
DHW-EIR	<p>The energy input ratio in Btu/Btu of the DHW heater. This specifies, at the design point, the ratio of the energy into the unit divided by DHW-HEAT-RATE.</p> <p>The default is</p> <p>1.39 for DHW-TYPE = GAS or WASTE-HEAT, 1.0 for DHW-TYPE = ELECTRIC or DESUPERHEAT, and 0.37 for DHW-TYPE = HEAT-PUMP.</p>
DHW-LOSS	The heat loss per hour from the DHW tank as a fraction of the operating capacity of the tank in Btu. The default is .03 Btu/hr of loss per Btu/hr of capacity.
DHW-EIR-FT	The variation of EIR as a function of outside drybulb temperature for units with DHW-TYPE = HEAT-PUMP. The default curve is given below.
DHW-HEAT-RATE-FT	The variation in DHW-HEAT-RATE as a function of outside drybulb temperature for units with DHW-TYPE = HEAT-PUMP. The default curve is given below.
DHW-EIR-FPLR	<p>The variation in EIR as a function of part load (DHW heater load/DHW heater operating capacity) for fuel fired DHW units (DHW-TYPE = GAS or WASTE-HEAT) or heat-pump charged DHW units (DHW-TYPE = HEAT-PUMP).</p> <p>The two default curves are given below.</p>

DHW-PUMP-ELEC	The electric power, in watts/Btuh of the DHW-HEAT-RATE, used by the DHW circulating pump when it operates. The default is no pumping power.
DHW-PUMP-SCH	is equal to the u-name of a schedule that defines the operation of the DHW circulation pump.
DHW-HSUP-RATE	The maximum rate at which heat (hot water in Btu/hr) can be supplied by the DHW unit. The default is to size this quantity for the maximum heat rate needed to meet the DHW load set by DHW-SCH and DHW-GAL/MIN.
DHW-HSTOR-RATE	The maximum rate at which waste or recovered heat can be supplied to the DHW tank. The default is to set this quantity to the maximum heat rate needed to meet the DHW load defined by DHW-SCH and DHW-GAL/MIN.

#### Default sizing

If you don't specify DHW-SIZE, the unit is sized in the DESIGN subroutine in the SYSTEMS subprogram. The tank size is set to GPHMAX, the maximum hot water flow rate in gallons per hour derived from DHW-GAL/MIN and DHW-SCH. If DHW-HEAT-RATE is not input it is set by:

$$\langle \text{DHW-HEAT-RATE} \rangle = (8.341 \text{ lbs/gal})(1 \text{ Btu/lb-F}) \text{ GPHMAX} (\langle \text{DHW-SUPPLY-T} \rangle - \text{TINMIN})$$

where TINMIN is the minimum inlet temperature specified by DHW-INLET-T-SCH, or the minimum monthly ground temperature if DHW-INLET-T-SCH is not input. DHW-HSUP-RATE and DHW-HSTOR-RATE are defaulted in the same manner as DHW-HEAT-RATE.

#### Waste heat use

The DHW simulation is capable of using waste or recovered heat to meet the DHW load or to charge the tank for later use. At present the recovered heat is available from two sources: (1) gas heat pumps; (2) superheat from electric heat pumps.

- (1) To recover waste heat from gas heat pumps, you should set HEAT-SOURCE = GAS-HEAT-PUMP in the SYSTEM command and DHW-TYPE = WASTE-HEAT in the PLANT-ASSIGNMENT command. The program will then simulate a gas heat pump for space heating and cooling and a gas fired domestic hot water heater and tank which can store waste heat from the heat pump. The simulation of the waste heat production is controlled by the SYSTEM or SYSTEM-EQUIPMENT keywords COOL-WASTE-HEAT, COOL-WH-FT, COOL-WH-FRPM, HEAT-WASTE-HEAT, HEAT-WH-FT, and HEAT-WH-FRPM. These keywords are discussed in "Gas Heat Pumps", p.3.48.

Here we will just note that COOL-WASTE-HEAT and HEAT-WASTE-HEAT are the fractions of the cooling or heating fuel input heat equivalent, respectively, that become waste heat at design load and conditions. COOL-WH-FT, COOL-WH-FRPM, HEAT-WH-FT, and HEAT-WH-FRPM are curves that modify these fractions at part load and off design conditions. At present all the curves are set to a constant value of 1 and COOL-WASTE-HEAT and HEAT-WASTE-HEAT default to .25.

- (2) To simulate the recovery of desuperheat from electric heat pumps, you should set `DHW-TYPE = DESUPERHEAT` in the `PLANT-ASSIGNMENT` command and use `SYSTEM-TYPE = RESVVT` in the `SYSTEM` command. The program will then model a multi-zone, multi-thermostat residential system with a variable speed electric heat pump used for heating and cooling and an electric domestic hot water heater and tank. The tank will have a water loop and heat exchanger that allow it to extract the available superheat from the heat pump. This desuperheat is then either used to meet the immediate hot water load or can be stored in the tank. The same keywords are relevant in this case as for the gas heat pump. Again, the four curves `COOL-WH-FT`, `COOL-WH-FRPM`, `HEAT-WH-FT`, and `HEAT-WH-FRPM` default to 1. `COOL-WASTE-HEAT` defaults to .23 and `HEAT-WASTE-HEAT` to .25. In the cooling mode, the recovered desuperheat is "free"; in the heating mode, however, it subtracts from the heat pump's space heating capacity.

### Simulation Strategy

The unit is simulated by the subroutine `DHWTNK` in `SYSTEMS`. `DHWTNK` is called twice each hour for each `PLANT-ASSIGNMENT`. In the first call, at the start of the hourly calculations, the operating capacity of the tank and the heat stored in the tank are calculated relative to the inlet temperature for the hour. Heat loss from the tank is calculated, and stored heat is expended to meet the domestic hot water load. In the second call, at the end of the hourly calculations, the HVAC equipment has been simulated and the amount, if any, of waste heat available is known. The heater or burner capacity is calculated and any remaining domestic hot water load is met first by waste heat, if available, and then by the heater or burner. Any remaining waste heat and heater capacity is used to recharge the tank. If part of the domestic hot water load remains unsatisfied, it is passed on to `PLANT`.

In most cases you will specify domestic hot water demand with the `DHW-GAL/MIN` and `DHW-SCH` keywords in `PLANT-ASSIGNMENT` in `SYSTEMS`. The domestic hot water heater and tank will then be sized and simulated `SYSTEMS`. By specifying `DHW-SIZE = 0`, however, you can still force the domestic hot water heater to be simulated in `PLANT`. Also, the default sizing algorithm in `SYSTEMS` doesn't take into account the domestic hot water load coming from `LOADS` via the `SOURCE` keywords (`SOURCE-TYPE = HOT-WATER`) in the `SPACE` or `SPACE-CONDITIONS` commands. Some or all of this load may not be satisfied by the default sized hot water heater in `SYSTEMS` and the remaining load would be passed to `PLANT`.

Domestic hot water load can also met by a service hot water heat pump (specified with the `SHW-` keywords in `SYSTEM` and `PLANT-ASSIGNMENT`; see `SERVICE HOT WATER HEAT PUMPS`, p.3.62). The service hot water load is not separate from the domestic hot water load; i.e., there is only one domestic hot water load for each `PLANT-ASSIGNMENT`. If you input both a domestic hot water heater and tank and a service hot water heater, stored hot water from the DHW tank will be used to meet the DHW load first, the service hot water heat pump will be used next, and waste heat and the DHW burner or heater will be used last.

Supplement — 2.1E Update

Curves

For DHW—TYPE = HEAT—PUMP the default curves are:

Keyword	Type	Independent Variables	(a)	(b)	(c)	(d)	(e)	(f)
			DHW—EIR—FT	cubic	outside drybulb	2.1855478	-.0494718	.00070417
DHW—EIR—FPLR	cubic	part load ratio	.08565215	.93881371	-.1834361	.15897022	0.	0.
DHW—HEAT—RATE—FT	cubic	outside drybulb	.29495686	.01425344	-.0000117	.00000059	0.	0.

For DHW—TYPE = GAS and DHW—TYPE = WASTE—HEAT the default curves are:

Keyword	Type	Independent Variables	(a)	(b)	(c)	(d)	(e)	(f)
			DHW—EIR—FPLR	quad	part load	0.021826	.977630	.000543

Performance curves are not used for other values of DHW—TYPE.

In summary, the keywords relevant to the domestic hot water heater and tank under the PLANT—ASSIGNMENT command in the SYSTEMS subprogram are these:

Keyword	Abbr	Type	Unit	Default	Min	Max
DHW—SIZE	none	numeric	gal	*	0.0	1000.
DHW—GAL/MIN	none	numeric	gal/min	0.	0.0	10000.
DHW—SCH	none	schedule	—			
DHW—HEAT—RATE	none	numeric	Btu/hr	*	0.0	100000.
DHW—TYPE	none	code-word		GAS		
DHW—EIR	none	numeric	Btu/Btu	*	0.0	3.0
DHW—LOSS	none	numeric	frac	.03	0.0	1.0
DHW—EIR—FT	none	curve	—	**		
DHW—HEAT—RATE—FT	none	curve	—	**		
DHW—EIR—FPLR	none	curve	—	**		
DHW—INLET—T—SCH	none	schedule	—	**		
DHW—SUPPLY—T	none	numeric	°F	140.	70.	200.
DHW—PUMP—ELEC	none	numeric	watt/Btuh	0.0	0.0	0.1
DHW—PUMP—SCH	none	schedule	none			
DHW—HSUP—RATE	none	numeric	Btu/hr	*	0.0	100000.
DHW—HSTOR—RATE	none	numeric	Btu/hr	*	0.0	100000.

\*See keyword description

\*\*See curve default table

## SERVICE HOT WATER HEAT PUMPS

The following keywords in SYSTEM and PLANT—ASSIGNMENT allow you to specify a service hot water electric heat pump. For an example, see the “Medical Building” in the *Sample Run Book (2.1E)*.

### SYSTEM

#### SHW—HP—SIZE

specifies the heat rejection capacity in Btu/hr of an air/water heat pump (rated at 47°F ambient) that removes heat from a zone or from the outside air and then supplies it at 90 °F to a service hot water tempering tank.

The DOE-2 calculation is based on the instantaneous hot water hourly load, calculated in LOADS and then passed to SYSTEMS. Therefore you should represent the service hot water requirements as a smoothed, diversified load using SOURCE—TYPE, SOURCE—BTU/HR, and SOURCE—SCHEDULE keywords in the LOADS SPACE—CONDITIONS command to represent a tempering tank. The service hot water heat pump is controlled as only being responsive to the service hot water demand for the hour. Its heating effect (the heat rejected by the unit) is subtracted from the domestic hot water load passed to PLANT—EQUIPMENT. If the heat pump is located in a zone, its heat removal effect is subtracted from the zone sensible cooling load or added to the zone heating load.

#### SHW—HP—SOURCE

accepts code-words ZONE (the default) and OUTDOOR. If ZONE, the heat source is the air in the zone specified by SHW—HP—ZONE. If OUTSIDE, the unit is located outside the building and the heat source is the outside air.

#### SHW—HP—ZONE

accepts the u-name of the zone in which the unit is located, for the case in which SHW—HP—SOURCE = ZONE. This zone is the unit's source of heat. Typically this zone is an area with high heat gains, such as a restaurant kitchen. But it can be any zone where there is heat that can be reclaimed without resulting in objectionable overcooling (e.g., the basement of a house).

An error message will result if the zone specified for SHW—HP—ZONE is not one of the zones in this SYSTEM (i.e., SHW—HP—ZONE cannot be in another SYSTEM).

PLANT-ASSIGNMENT

SHW-HT-CAP-FT

accepts the u-name of a bi-linear or bi-quadratic curve that gives the heat pump heating capacity as a function of the dry-bulb temperature of the heat source and the water temperature of the tempering tank. The default curve u-name is SDL-C51.

The default curves for the service hot water heat pump curves (SHW-HT-CAP-FT, SHW-HT-EIR-FT and SHW-HT-EIR-FPLR) are the same as those for the air-to-air heat pump curves (HEAT-CAP-FT, HEAT-EIR-FT and HEAT-EIR-FPLR). See "SYSTEM-EQUIPMENT Default Curves", p.3.141.

SHW-HT-EIR

is the Electric Input Ratio, or  $1/(\text{heating COP})$ , for the heat pump, at ARI rated conditions. Heat pump fan power is included in the EIR.

SHW-HT-EIR-FT

accepts the u-name of a bi-linear or bi-quadratic curve that gives the heat pump EIR as a function of the dry-bulb temperature of the heat source and the water temperature of the tempering tank. The default curve u-name is SDL-C56.

SHW-HT-EIR-FPLR

accepts the u-name of a linear, quadratic, or cubic curve that gives the heat pump EIR as a function of part load ratio. The default curve u-name is SDL-C61.

**Hourly Report Variables**

Hourly values of water heating, zone cooling, and energy consumed by a service hot water heat pump are provided by hourly report variable list numbers 126, 127, and 128, respectively, for VARIABLE-TYPE=u-name of SYSTEM.

## EVAPORATIVE COOLING

### Introduction

The simulation of evaporative cooling was introduced in DOE-2.1E. The algorithms cover *stand-alone* units as well as evaporative cooling as an *add-on* to standard HVAC systems with mechanical cooling components. Indirect, indirect-direct, and (for residential system RESYS) direct evaporative cooling units may be selected. The performance of add-on variable volume evaporative cooling units is modeled by effectiveness curves which you may replace.

There are several new hourly report variables related to evaporative cooling. These are described in Appendix A under SYSTEMS, VARIABLE—TYPE = u-name of SYSTEM.

*Caution:* Evaporative cooling keywords should *not* be input if desiccant cooling is specified. This is because the evaporative cooling algorithms used in the simulation of desiccant-plus-evaporative cooling units are separate from the evaporative-only algorithms to which the keywords discussed in this section apply (see PACKAGED TOTAL-GAS SOLID-DESICCANT SYSTEM p.3.72, and ADD—ON (INTEGRATED) DESICCANT COOLING, p.3.76).

### Stand-alone Evaporative Cooler

The stand-alone evaporative cooler system (Fig. 3.11) is selected by specifying SYSTEM—TYPE = EVAP—COOL in the SYSTEM instruction. For an example, see "Bar/Lounge, System 3" in the *Sample Run Book (2.1E)*. The following keywords apply:

#### SYSTEM—EQUIPMENT

EVAP—CL—TYPE	accepts code-words INDIRECT and INDIRECT—DIRECT (the default).
INDIRECT	the system has only an indirect evaporative cooling element.
DIRECT—DIRECT	the system has both indirect and direct evaporative cooling demands (see Fig.3.11).
DIRECT—EFF	is the rated effectiveness of the direct evaporative cooler. The default is 0.85.
INDIR—EFF	is the rated effectiveness of the indirect evaporative cooler. The default is 0.80.
EVAP—CL—KW	is the kW/CFM required by the evaporative cooling pump and secondary fan. The default is 0.0005.
EVAP—CL+REC—RA	accepts code-words YES and NO (the default), which specify whether return air (YES) or outside air (NO) is used for the secondary air stream of the indirect cooler. When EVAP—CL+REC—RA = YES, the SYSTEM—AIR keyword RECOVERY—EFF determines the effectiveness of the heat exchange (during heating periods) between return air and outside air.

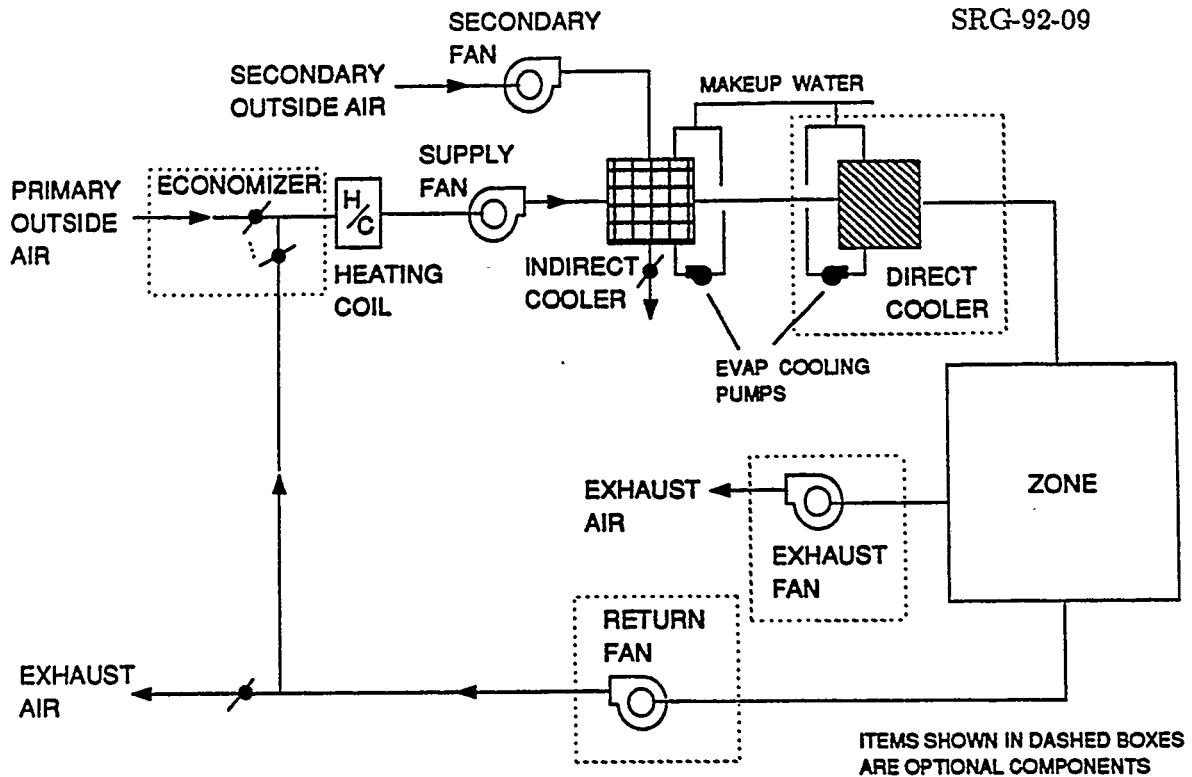

Figure 3.11: Stand-alone evaporative cooler system (SYSTEM-TYPE = EVAP-COOL).

The following additional keywords are required:

ZONE-CONTROL

HEAT-TEMP-SCH  
 COOL-TEMP-SCH  
 DESIGN-HEAT-T  
 DESIGN-COOL-T

are all required, as for any other DOE-2 system.  
 See *Reference Manual (2.1A)*, p.IV.192

SYSTEM-EQUIPMENT

HEATING-CAPACITY

must be precalculated by you and input as a *negative* number of Btu/hr (e.g., HEATING-CAPACITY = -300000).

SYSTEM-AIR

SUPPLY-CFM

you must precalculate, since SYSTEMS does not automatically size evaporative cooling units.

MIN-OUTSIDE-AIR

is the ratio [minimum ventilation air flow]/[supply air flow] during winter heating periods. When evaporative cooling is in effect, the outside air dampers are 100% open. When outside air is able to cool the building without the aid of evaporative cooling, the outside and return air dampers modulate open.



**SYSTEM**

**ZONE-NAMES** is the list of zone names attached to this system. The first-named zone is the control zone.

**Add-on Evaporative Cooling**

The following **SYSTEM-EQUIPMENT** keywords apply when an evaporative pre-cooler is an add-on to **SYSTEM-TYPE = SZRH, PSZ, SZCI, RHFS, VAVS, PIU, PVAVS, CBVAV, MZS, PMZS, DDS, TPIU, or FPIU** (see Figs. 3.11 and 3.12). These keywords are in addition to those usually required for the inputs of the system type selected. The system is sized and simulated as if the evaporative cooling were truly an add-on. When the opposite is true (e.g., when mechanical cooling is added to an evaporative cooling system), you must intervene and manually size the HVAC system coils and set the supply air flow equal to the evaporative cooling supply air rate.

For add-on evaporative cooling, **SYSTEMS** report **SUPL**, "System Supplemental Evaporative and Desiccant Cooling", is automatically printed. This report, described in Appendix C, gives the monthly sensible, latent, total cooling provided by the evaporative cooling unit, the number of hours it is on, and its electricity consumption.

**SYSTEM-EQUIPMENT**

**EVAP-CL-TYPE** accepts code-words **NONE** (the default), **INDIRECT**, and **INDIRECT-DIRECT**, which specify the type of evaporative cooling element.

**EVAP-CL-KW** specifies the kW/CFM required by the evaporative cooling pump and secondary fan. The default is 0.0005. For add-on evaporative cooling you should increase the supply fan static pressure to compensate for the added pressure drop through the indirect/direct exchangers.

**EVAP-CL+M-SUP** accepts code-words **SEPARATE** and **TOGETHER** (the default), which specify whether the evaporative cooler can operate in conjunction with mechanical cooling.

*SEPARATE* The evaporative cooler operates only when it meets the entire cooling load.

*TOGETHER* The evaporative cooler does as much cooling as possible; mechanical cooling handles the remaining load (plus any dehumidification needed).

For both **SEPARATE** and **TOGETHER** the evaporative cooler will cycle off if **OA-CONTROL = TEMP** and the outside air is cool enough to handle the entire cooling load.

**EVAP-CL+REC-RA** accepts code-words **YES** and **NO** (the default), which specify whether return air (**YES**) or outside air (**NO**) is used for the

---

In the left column, bold-faced words are commands, non-bold words are keywords, and italicized words are code-words.

secondary airstream of the indirect cooler.

Figures 3.12 and 3.13 illustrate  $EVAP-CL+REC-RA = NO$ .

When  $EVAP-CL+REC-RA = YES$ , the  $SYSTEM-AIR$  keyword  $RECOVERY-EFF$  simulates heat exchange between return air and outside air (during heating periods).

**DIRECT-EFF**

is the rated nominal effectiveness of the direct evaporative cooler. The default is 0.85. For variable volume systems, this value is modified by a default curve of effectiveness vs. CFM (which can be overridden using  $DIRECT-EFF-FCFM$ , below).

**INDIR-EFF**

specifies the rated effectiveness of the indirect evaporative cooler. The default is 0.80. For variable volume systems, this value is modified by a default curve of effectiveness vs. CFM (which can be overridden using  $INDIR-EFF-FCFM$ , below).

**EVAP-CL-LIMIT-T**

is the outside air drybulb setpoint above which the evaporative cooler will be turned off. The default is 199°F. In very hot weather (above 120°F), it is sometimes more energy efficient to revert to mechanical cooling alone rather than evaporative cooling supplemented by mechanical cooling.

**EVAP-CL-AIR**

is the fraction of the design supply air flow that passes through the evaporative cooler. Among other things, it is used to size the evaporative cooler. The usual choices for  $EVAP-CL-AIR$  would be these:

- (1) Allow  $EVAP-CL-AIR$  to default; then it will be set equal to the minimum outside air ratio for the system (Fig. 3.12); or
- (2) Set  $EVAP-CL-AIR = 1.0$ ; then all of the supply air will pass through the evaporative cooler. If  $EVAP-CL-AIR$  is *less than or equal to* the minimum outside air ratio, only outside air will flow through the evaporative cooler, as shown in Fig. 3.11.

If  $EVAP-CL-AIR$  is *greater than* the minimum outside air ratio, all of the outside air plus some of the return air will flow through the the evaporative cooler, as shown in Fig. 3.12. The economizer keywords ( $OA-CONTROL$ ,  $DRYBULB-LIMIT$ ) and outside air control operate just as if the evaporative cooler were not there, except that the outside air flow does not go to minimum when  $OA-CONTROL=TEMP$  and the outside air temperature is above the return air temperature, but below  $DRYBULB-LIMIT$ . For example, for  $OA-CONTROL=TEMP$ ,  $DRYBULB-LIMIT=100$ , and  $EVAP-CL-LIMIT-T=100$ , if the outside drybulb is above 100, the outside air flow will go to minimum, the evaporative cooler will be off, and all cooling will be done conventionally. If the outside drybulb is below 100 but above the needed supply air temperature, the system will use 100% outside air and the evaporative cooler will operate. If the outside drybulb is below

Supplement - 2.1E Update

the supply temperature, cooling will be done by outside air only. When the full capacity of the evaporative cooler is not needed to cool the mixed air to the needed supply air temperature, the evaporative cooler is assumed to cycle on and off to meet the partial load. You can specify the minimum outside air with the keyword MIN-OUTSIDE-AIR; note, however, that the zone level keywords OUTSIDE-AIR-CFM, OA-CFM/PER, and OUTSIDE-CHANGES, when input, take precedence over MIN-OUTSIDE-AIR.

DIRECT-EFF-FCFM accepts the u-name of a user-defined CURVE-FIT that modifies the rated effectiveness of the *direct* evaporative cooling element as a function of CFM for variable volume systems.

INDIR-EFF-FCFM accepts the u-name of a user-defined CURVE-FIT that modifies the rated effectiveness of the *indirect* evaporative cooling element as a function of CFM for variable volume systems.

**Example:**

The following example is a PSZ system, with add-on evaporative cooling, serving a single zone.

```

$ -- PSZ SYSTEM WITH ADD-ON EVAPORATIVE COOLING -- $

INPUT SYSTEMS ..
SYSTEMS-REPORT SUMMARY = (SS-A,SS-H,SS-I,SS-N,SS-O) ..
FANSON = SCH THRU DEC 31 (MON,SAT) (1,24) (1)
              (SUN,HOL) (1,2) (1) (3,9)(0)
              (10,24)(1) ..
C-SETPT = SCH THRU DEC 31 (ALL) (1,24) (76) ..
H-SETPT = SCH THRU DEC 31 (ALL) (1,24) (72) ..
ENV = ZONE-CONTROL
      DESIGN-COOL-T = 76      DESIGN-HEAT-T = 72
      COOL-TEMP-SCH = C-SETPT HEAT-TEMP-SCH = H-SETPT ..

BLDG = ZONE      ZONE-CONTROL = ENV ..

SYS1 = SYSTEM
SYSTEM-TYPE = PSZ      EVAP-CL-TYPE = INDIRECT
EVAP-CL-KW = .0004     EVAP-CL-M-SUP = SEPARATE
EVAP-CL-AIR = .20 $ minimum OA air precooling only $
SUPPLY-CFM = 2500     HEATING-CAPACITY = -120000
MAX-SUPPLY-T = 100    MIN-SUPPLY-T = 55
SUPPLY-STATIC = 2.5   SUPPLY-EFF = .47
F-SCH = FANSON      ZONE-NAMES = (BLDG) ..

END ..
COMPUTE SYSTEMS ..

```

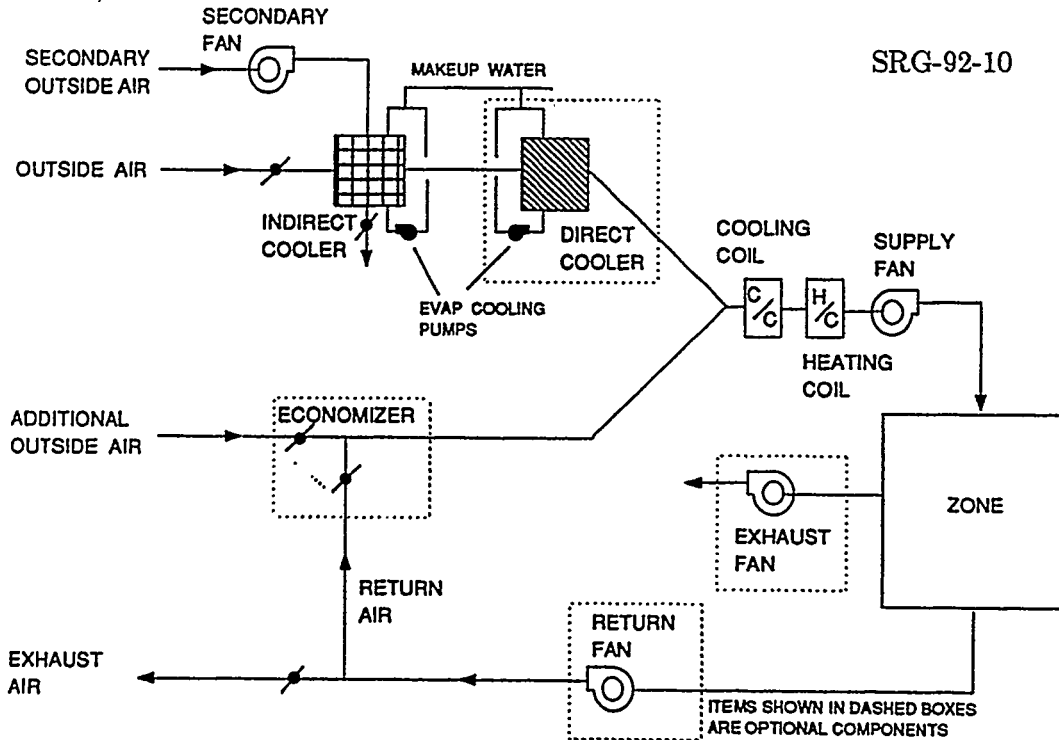

**Figure 3.12:** Add-on evaporative cooling unit in which only outside air is passed through the evaporative cooler (EVAP-CL-AIR allowed to default), shown integrated with a conventional HVAC system.

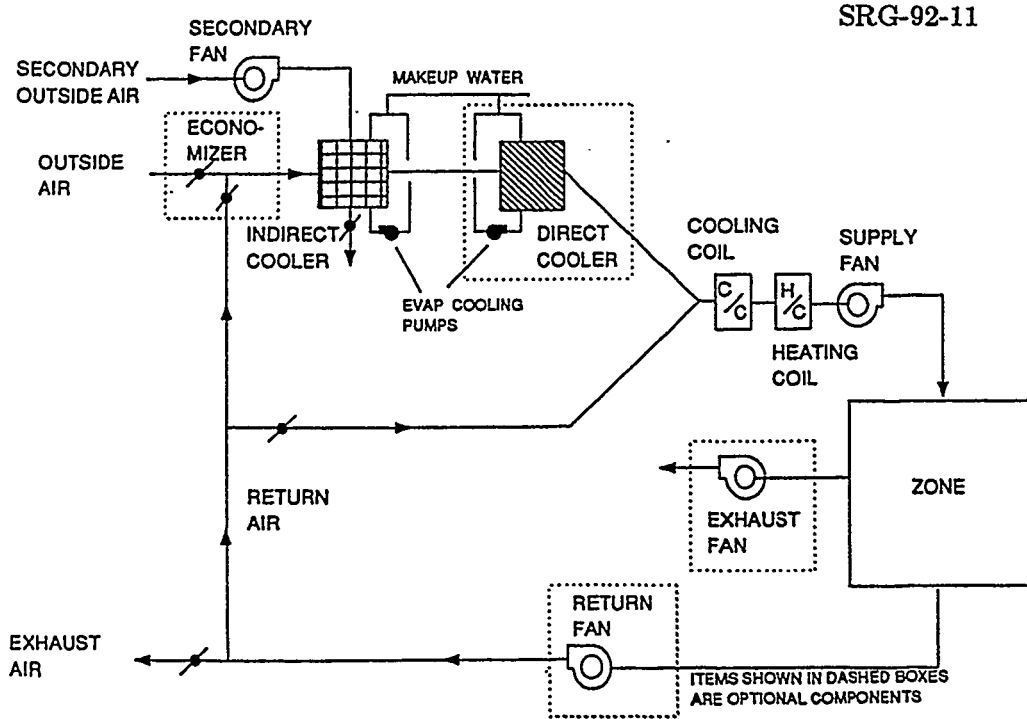

**Figure 3.13:** Add-on evaporative cooling unit in which some of the return air passes through the evaporative cooler (EVAP-CL-AIR > MIN-OUTSIDE-AIR), shown integrated with a conventional HVAC system.

### Residential Direct Evaporative Cooler

The following four keywords apply when a direct evaporative cooler is an add-on to the residential system (SYSTEM-TYPE = RESYS), as shown schematically in Fig. 3.14. These keywords are in addition to those usually required for RESYS.

#### SYSTEM-EQUIPMENT

- RES-EVAP-COOLER** accepts code-words YES and NO (the default). This keyword is applicable only to SYSTEM-TYPE = RESYS. If RES-EVAP-COOLER = YES, it is assumed that mechanical cooling is not present. However, natural ventilation (opening windows), if specified, can be active.
- RES-EVAP-CL-CFM** is the air side capacity of the residential evaporative cooler. This is a required keyword. The heating CFM for the RESYS system is sized automatically and, since it is determined by the peak heating load, it may differ from the value of RES-EVAP-CL-CFM.
- EVAP-CL-KW** specifies the kW/CFM of energy required by the evaporative unit fan. The default is 0.0001 for the residential direct evaporative cooler only.
- DIRECT-EFF** is the rated nominal effectiveness of the direct evaporative cooler. The default is 0.85.

SRG-92-12

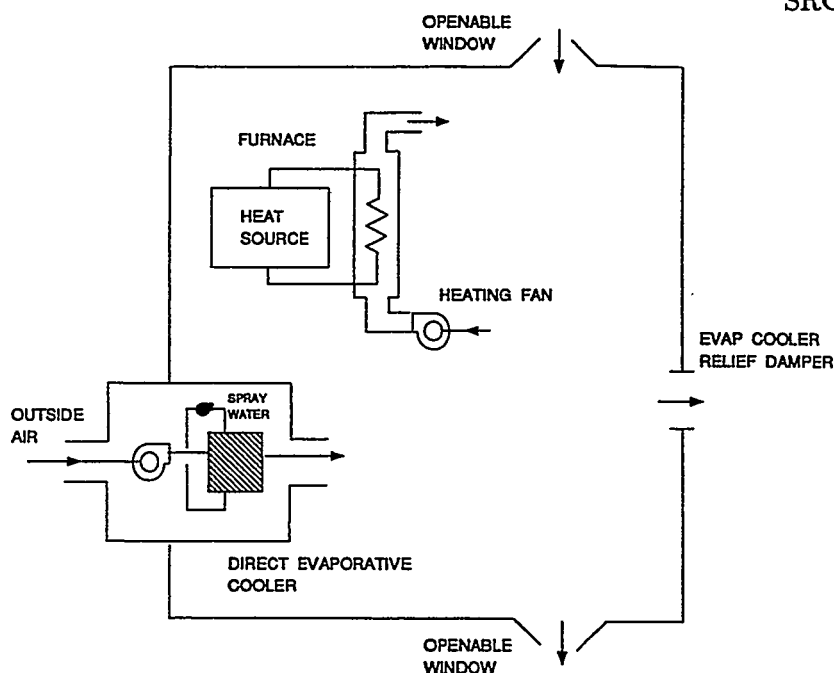

Figure 3.14: Residential System (RESYS) with Direct Evaporative Cooler.

Supplement - 2.1E Update

**Example:**

Following is an example of a residential system with a direct evaporative cooler serving a single zone.

```

$ -- RESIDENTIAL SYSTEM WITH DIRECT EVAPORATIVE COOLER -- $
INPUT SYSTEMS ..
SYSTEMS-REPORT SUMMARY = (SS-A, SS-H, SS-I, SS-N, SS-O) ..
FANSON = SCH THRU DEC 31 (MON, SAT) (1, 24) (1)
                               (SUN, HOL) (1, 2) (1) (3, 9) (0)
                                       (10, 24) (1) ..
C-SETPT = SCH THRU DEC 31 (ALL) (1, 24) (76) ..
H-SETPT = SCH THRU DEC 31 (ALL) (1, 24) (72) ..
ENV = ZONE-CONTROL
      DESIGN-HEAT-T = 72
      DESIGN-COOL-T = 74
      HEAT-TEMP-SCH = H-SETPT
      COOL-TEMP-SCH = C-SETPT ..
BLDG = ZONE
      ZONE-CONTROL = ENV ..
SYS1 = SYSTEM
      SYSTEM-TYPE      = RESYS
      RES-EVAP-COOLER  = YES
      RES-EVAP-CL-CFM  = 3500
      HEATING-CAPACITY = -120000
      MAX-SUPPLY-T     = 100
      MIN-SUPPLY-T     = 55
      SUPPLY-STATIC    = .5
      SUPPLY-EFF       = .47
      F-SCH            = FANSON
      ZONE-NAMES       = (BLDG) ..
END ..
COMPUTE SYSTEMS ..

```

## PACKAGED TOTAL-GAS SOLID-DESICCANT SYSTEM

### Introduction

The Packaged Total-Gas Solid-Desiccant System (PTGSD) is a small (5 to 10 ton, 1800 - 3600 cfm) packaged unit that uses a desiccant wheel in conjunction with direct and indirect evaporative cooling, instead of the usual DX coils used in small packaged units. The unit uses a gas-fired hydronic heater to regenerate the desiccant and to provide space heating. The result is a unit that primarily consumes gas to provide heating and cooling.

The unit consists of supply and return air fans, a lithium chloride impregnated desiccant wheel, an indirect evaporative cooler, a heating coil, a direct evaporative cooler, and a reactivation air heater coil (see Fig. 3.15). In the cooling mode, the supply fan blows 100% outside air onto the "dry" half of the desiccant wheel. Hot, dry air emerges from the other side of the wheel. This air is then cooled by an air-to-air heat exchanger, the other air stream being evaporatively cooled return air. Finally, the air is cooled even further by a direct evaporative cooler. The resulting supply air is then ducted to the zones. Return air is drawn through a direct evaporative cooler, and then heated by passing through the air-to-air heat exchanger (taking heat from the supply air emerging from the desiccant wheel). Further heat is added by the reactivation air heater coil. Then, the return air passes through the other half of the wheel, regenerating the desiccant by carrying off the moisture absorbed by the lithium chloride. Finally the return air is exhausted to the outside.

At rated conditions, outside air is at 95°F drybulb, 75°F wetbulb, and return air is 80°F drybulb, 67°F wetbulb. After going through the desiccant wheel and the air-to-air heat exchanger, the supply air is at 73°F drybulb, with a humidity ratio of .0055 (about 33% relative humidity). Upon emerging from the final direct evaporative cooling stage, the supply air is at 57°F drybulb, with a humidity ratio of .0092 (around 92% relative humidity).

The supply and return fans are assumed to be variable speed. The zone air temperature is controlled by varying the flow of the supply air; the system is a variable air volume system.

In the heating mode, the fans are assumed to be at minimum speed. The minimum amount of outside air is brought in, mixed with return air, and heated by the heating coil. The wheel motor, reactivation heater coil, and both humidifiers (direct evaporative coolers) and their pumps are, of course, turned off.

The unit can be operated in several intermediate modes. One such mode is to operate the unit as an evaporative cooler. Only the supply air indirect evaporative cooler (return air humidifier and air-to-air heat exchanger) and direct evaporative cooler are operated, no dehumidifying is done, and no gas is consumed. Another mode is to cool with outside air only, or with a mixture of outside and return air.

At present, you have no control over which operating mode is selected for each hour time step. The simulation determines which modes are capable of meeting the load and, of these, which is most efficient. Thus, the unit is simulated to use the minimum possible energy.

---

The desiccant cooling system simulation in DOE-2.1D was developed with the support and collaboration of the Gas Research Institute and the GARD Division of the Chamberlain Manufacturing Corporation.

Supplement – 2.1E Update

The unit is modeled with a set of six curves. These curves relate the supply air conditions at the exit of the air-to-air heat exchanger (point 8 in Fig. 3.15) to the outside wetbulb (point 6) and the return air wetbulb (point 1). The curves are:

Keyword	----- Coefficients -----					
	(a)	(b)	(c)	(d)	(e)	(f)
T8-FWB1WB6	1.20347	0.902420	0.0	0.142597	0.0	0.0
T8PL-FWB1WB6	0.494371	0.971983	0.0	.0366191	0.0	0.0
HR8-FWB1WB6	-4.55708	.0514960	.00022655	.0953548	.00018254	-.00081736
HR8PL-WB1WB6	-3.66836	.0566377	.00015508	.0635270	.00038127	-.00075737
QREG-FWB1WB6	142.125	-.872537	.00527466	-1.40269	.00001349	.00585206
QREGPL-FWB1WB6	36.5727	-.231413	.00141848	-.372583	-.00007401	.00160681

The formula is:

$$f(wb1,wb6) = a + b*wb1 + c*wb1**2 + d*wb6 + e*wb6**2 + f*wb1*wb6$$

T8-FWB1WB6 gives the drybulb temperature at point 8 at full load. HR8-FWB1WB6 yields the natural log of 10,000 times the humidity ratio at full load. QREG-FWB1WB6 gives the full load regeneration energy in Btu/hr. The other three curves give the same quantities at 25% part load. Interpolation is used to find the general part load results.

XBL 893-6159

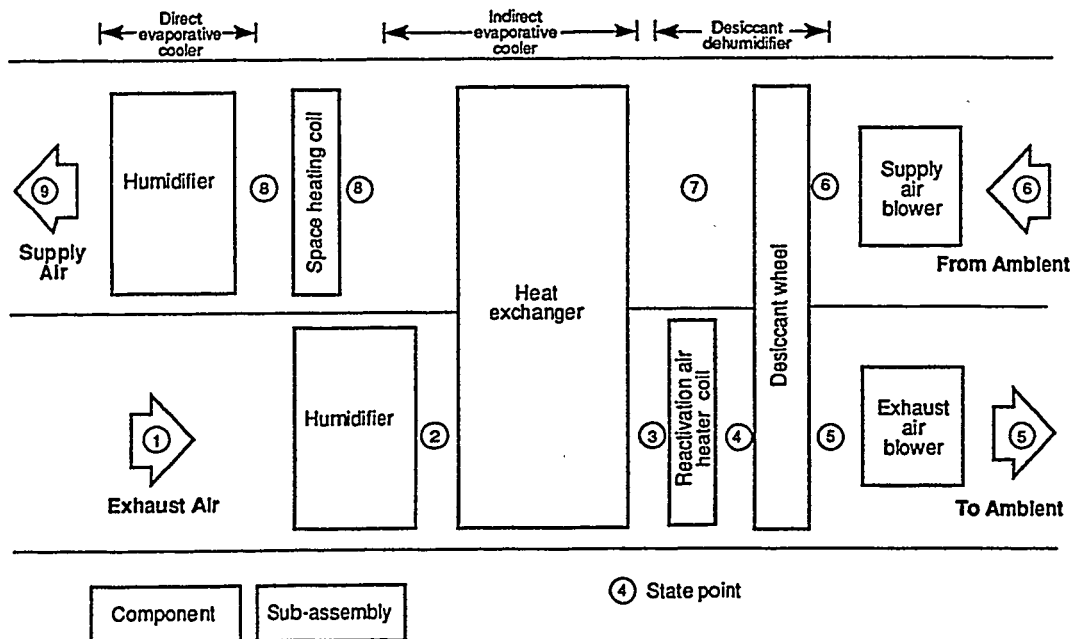

Figure 3.15: Schematic diagram for the Packaged Total Gas Solid Desiccant System



Supplement — 2.1E Update

The PTGSD system must be sized by you. The DOE-2 design routine will not estimate a size from the LOADS peaks as it does for other system types. The two keywords required are SUPPLY-CFM or SUPPLY-FLOW in the SYSTEM or SYSTEM-AIR command and HEATING-CAPACITY in the SYSTEM or SYSTEM-EQUIPMENT command. Keywords that are relevant to the PTGSD system are:

Keyword	Abbr	Command	Default
HEAT-SOURCE	HEAT-S	SYSTEM	GAS-HYDRONIC
BASEBOARD-SOURCE	BASEB-S	SYSTEM	GAS-HYDRONIC
RETURN-AIR-PATH	R-A-P	SYSTEM	DIRECT
HEATING-SCHEDULE	H-SCH	SYSTEM-CONTROL	none
COOLING-SCHEDULE	C-SCH	SYSTEM-CONTROL	none
MAX-HUMIDITY	MAX-H	SYSTEM-CONTROL	100%
BASEBOARD-SCH	B-SCH	SYSTEM-CONTROL	none
SUPPLY-FLOW	S-F	SYSTEM-AIR	required
MIN-OUTSIDE-AIR	M-O-A	SYSTEM-AIR	0.1
MIN-AIR-SCH	M-A-SCH	SYSTEM-AIR	none
FAN-SCHEDULE	F-SCH	SYSTEM-FANS	none
FAN-CONTROL	F-C	SYSTEM-FANS	SPEED
SUPPLY-DELTA-T	SUP-D-T	SYSTEM-FANS	1.2°F
MAX-FAN-RATIO	MAX-F-R	SYSTEM-FANS	1.1
MIN-FAN-RATIO	MIN-F-R	SYSTEM-FANS	0.3
NIGHT-CYCLE-CTRL	N-C-C	SYSTEM-FANS	STAY-OFF
MIN-FLOW-RATIO	M-F-R	SYSTEM-TERMINAL	0.3
HEATING-CAPACITY	H-CAP	SYSTEM-EQUIPMENT	required
T8-FWB1WB6	T-FWB	SYSTEM-EQUIPMENT	SDL-C63
T8PL-FWB1WB6	TPL-FWB	SYSTEM-EQUIPMENT	SDL-64
HR8-FWB1WB6	HR-FWB	SYSTEM-EQUIPMENT	SDL-C67
HR8PL-FWB1WB6	HRPL-FWB	SYSTEM-EQUIPMENT	SDL-C68
QREG-FWB1WB6	QR-FWB	SYSTEM-EQUIPMENT	SDL-C69
QREGPL-FWB1WB6	QRPL-FWB	SYSTEM-EQUIPMENT	SDL-70
PLENUM-NAMES	P-N	SYSTEM	none
ZONE-NAMES	Z-N	SYSTEM	required

Electrical consumption is modeled by a fixed curve that you cannot alter. At full load this consumption is .000976 kW/cfm. In the hourly and summary reports, columns labeled "Fan Energy" will include this full auxiliary electrical consumption -- both fans and pumps.

Supplement — 2.1E Update

Outside air amounts can still be specified in the ZONE or ZONE—AIR commands. Supply air is apportioned to the zone according to the cooling load peaks, or by the cfm keywords in ZONE or ZONE—AIR. The ZONE keyword usage is basically the same as for any other system. Most of the above SYSTEM keywords should be allowed to default. You should be concerned with sizing the system and deciding whether to have supplemental baseboard heaters:

A typical input would look like:

\$ PTGSD EXAMPLE \$

INPUT SYSTEMS ..

TITLE LINE-5 \* PCKGD TOTAL GAS SOLID DESICCANT \* ..

SYSTEMS—REPORT SUMMARY = (SS-A,SS-H,SS-I,SS-N,SS-O) ..

FANSON = SCHEDULE THRU DEC 31 (WD) (1,6) (0) (7,18) (1) (19,24) (0)  
 (WEH) (1,24) (0) ..

C—SETPT = SCHEDULE THRU DEC 31 (WD) (1,6) (90) (7,18) (76) (19,24) (90)  
 (WEH) (1,24) (90) ..

H—SETPT = SCHEDULE THRU DEC 31 (WD) (1,5) (62) (6,18) (72) (19,24) (62)  
 (WEH) (1,24) (62) ..

ENV ZONE—CONTROL = DESIGN—HEAT—T = 72  
 DESIGN—COOL—T = 74  
 HEAT—TEMP—SCH = H—SETPT  
 COOL—TEMP—SCH = C—SETPT  
 BASEBOARD—CTRL = THERMOSTATIC ..

CENTER = ZONE  
 ZONE—CONTROL = ENV  
 O—CFM/P = 15  
 BASEBOARD—RATING = -10000 ..

EASTSIDE = ZONE LIKE CENTER ..  
 SOUTHSIDE = ZONE LIKE CENTER BASEBOARD—RATING = 0 ..  
 LOUNGE = ZONE LIKE CENTER ..

SYS1 = SYSTEM  
 SYSTEM—TYPE = PTGSD  
 FAN—SCHEDULE = FANSON  
 SUPPLY—CFM = 2500  
 MIN—CFM—RATIO = .4  
 HEATING—CAPACITY = -100000  
 ZONE—NAMES = (SOUTHSIDE, CENTER, EASTSIDE, LOUNGE)  
 NIGHT—CYCLE—CONTROL = CYCLE—ON—FIRST ..

END ..

CCMPUTE SYSTEMS ..

## ADD-ON (INTEGRATED) DESICCANT COOLING

### Introduction

This section describes models added in DOE-2.1E for desiccant cooling integrated with conventional HVAC systems that have mechanical cooling components. (A stand-alone desiccant cooling unit, introduced in DOE-2.1D, is described in PACKAGED TOTAL-GAS SOLID-DESICCANT SYSTEM, p.3.72.) These add-on desiccant units can be integrated with the following system types: SZRH, PSZ, SZCI, RHFS, VAVS, PIU, PVAVS, CBVAV, MZS, PMZS, DDS, TPIU, FPIU, and HP.

For integrated desiccant units, SYSTEMS report SUPL, "System Supplemental Evaporative and Desiccant Cooling", is automatically printed. This report, described in Appendix C, gives the monthly sensible, latent, and total cooling provided by the desiccant unit, the number of hours it is on, and its electricity consumption.

There are several new hourly report variables related to desiccant cooling. These are described in Appendix A under SYSTEMS, VARIABLE-TYPE = u-name of SYSTEM.

*Caution:* Evaporative cooling keywords should *not* be input if desiccant cooling is specified. This is because the algorithms used in the simulation of evaporative cooling units (see EVAPORATIVE COOLING, p.3.64) are separate from the desiccant-plus-evaporative cooling algorithms to which the keywords discussed in this section apply.

### SYSTEM

DESICCANT	takes code-words LIQ-VENT-AIR-1, LIQ-VENT-AIR-2, SOL-VENT-AIR-1, and NO-DESICCANT (the default), which indicate the type of desiccant unit.
<i>LIQ-VENT-AIR-1</i>	is a liquid desiccant dehumidifying unit (Fig. 3.15).
<i>LIQ-VENT-AIR-2</i>	is a liquid desiccant dehumidifying unit combined with a direct gas-fired absorption chiller (ABSORG-CHLR) (Fig. 3.17).
<i>SOL-VENT-AIR-1</i>	is a solid desiccant dehumidifying unit (Figs. 3.17-3.20).
<i>NO-DESICCANT</i>	(the default) indicates that no desiccant unit is present.

The sizing of the integrated desiccant unit, which is related to the size of the standard HVAC system with which it is integrated, is specified with the following keyword:

DESICCANT-AIR	is the air flow rate through the desiccant unit, entered as a fraction of the design supply air flow rate of the HVAC system. If DESICCANT-AIR is equal to the minimum outside air ratio, only outside air flows through the unit. This is the default when DESICCANT-AIR is not input. If DESICCANT-AIR exceeds the minimum outside air ratio, the inlet air stream of the desiccant unit is a mixture of outside air and return air. Usually, DESICCANT-AIR is set equal to MIN-OUTSIDE-AIR or to 1.0, which provides a 100% outside
---------------	--

In the left column above, bold-faced words are commands, non-bold words are keywords, and italicized words are code-words.

## Supplement — 2.1E Update

air system. However, if **OA-CONTROL = FIXED**, the unit operates at 100% outside air only when the unit is on, and returns to minimum outside air when the unit is off.

The source of heat to regenerate (dry out) the desiccant is specified with the following keyword:

**REG-HEAT-SOURCE** takes code-words **GAS-HYDRONIC** and **HOT-WATER**.

*GAS-HYDRONIC* indicates that the regeneration heat load is met in **SYSTEMS** with a gas-fired heater. This is the default for **LIQ-VENT-AIR-1** and **SOL-VENT-AIR-1**.

*HOT-WATER* indicates that the regeneration heat load is passed to **PLANT**, where it is met by heating equipment or by recovered heat. This is the default for **LIQ-VENT-AIR-2**.

If the regeneration heat is to be provided by heat recovery, then, in the **HEAT-RECOVERY** instruction in **PLANT**, **REGEN-HEAT** should be assigned as a **DEMAND-n**. For example, if regeneration heat is recovered from diesel engine exhaust, enter:

```
HEAT-RECOVERY  SUPPLY-1 = (DIESEL-GEN)
                DEMAND-1 = (REGEN-HEAT) ..
```

**LIQ-VENT-AIR-2** requires that the regeneration heat load be passed to a direct fired gas absorption chiller heat exchanger. This is done automatically when there is an **ABSORG-CHLR** assigned to **PLANT-EQUIPMENT**. The **PLANT-PARAMETERS** keyword **DESICCANT-XEFF** (default 0.8) specifies the exchanger effectiveness.

### Performance

The **LIQ-VENT-AIR-1** unit's exit temperature, exit humidity ratio, gas usage and auxiliary kw are given as a function of entering temperature and humidity ratio by four curves. They are:

<u>Keyword</u>	<u>Abbreviation</u>	<u>Default</u>
<b>DESC-T-FTW</b>	none	<b>SDL-C71</b>
<b>DESC-W-FTW</b>	none	<b>SDL-C72</b>
<b>DESC-GAS-FTW</b>	none	<b>SDL-C73</b>
<b>DESC-KW-FTW</b>	none	<b>SDL-C74</b>

Similar exit quantities for the **LIQ-VENT-AIR-2** desiccant subsystem are obtained from a hardwired performance map. For the **SOL-VENT-AIR-1** unit, they are obtained from subroutines containing hardwired curves.

---

In the left column above, bold-faced words are commands, non-bold words are keywords, and italicized words are code-words.

**Control of Integrated Desiccant Cooling Units**

Control of the integrated desiccant units varies by type; however, they all operate when the outside air temperature is above DRYBULB-LIMIT. Therefore, the setting for DRYBULB-LIMIT takes on greater importance than for standard HVAC systems and the optimum setting for a given climate must be derived experimentally using parametric runs. DRYBULB-LIMIT = 70°F is often used as a nominal setting.

**LIQ-VENT-AIR-1 and LIQ-VENT-AIR-2**

The control of the LIQ-VENT-AIR-1 (Fig. 3.16) and LIQ-VENT-AIR-2 (Fig. 3.17) units is specified using the following keywords in the SYSTEM instruction:

DESC-CTRL-MODE

is an integer indicating the control mode.

- = 0 (the default) operates the unit whenever the outside air temperature is above DRYBULB-LIMIT and the system fan is on.
- = 1 cycles on a direct evaporative cooling unit to maintain the exit dewpoint, DESC-DEW-SET. (The rationale for this is that when the air exiting the desiccant unit is overly dry, the evaporative cooler can provide additional sensible cooling and add moisture back into the air.) Not allowed for LIQ-VENT-AIR-2.
- = 2 cycles the desiccant unit itself on and off to maintain the exit dewpoint, DESC-DEW-SET. Not allowed for LIQ-VENT-AIR-2.

DESC-DEW-SET

is the dewpoint temperature setpoint of air exiting the desiccant unit (default is 50°F).

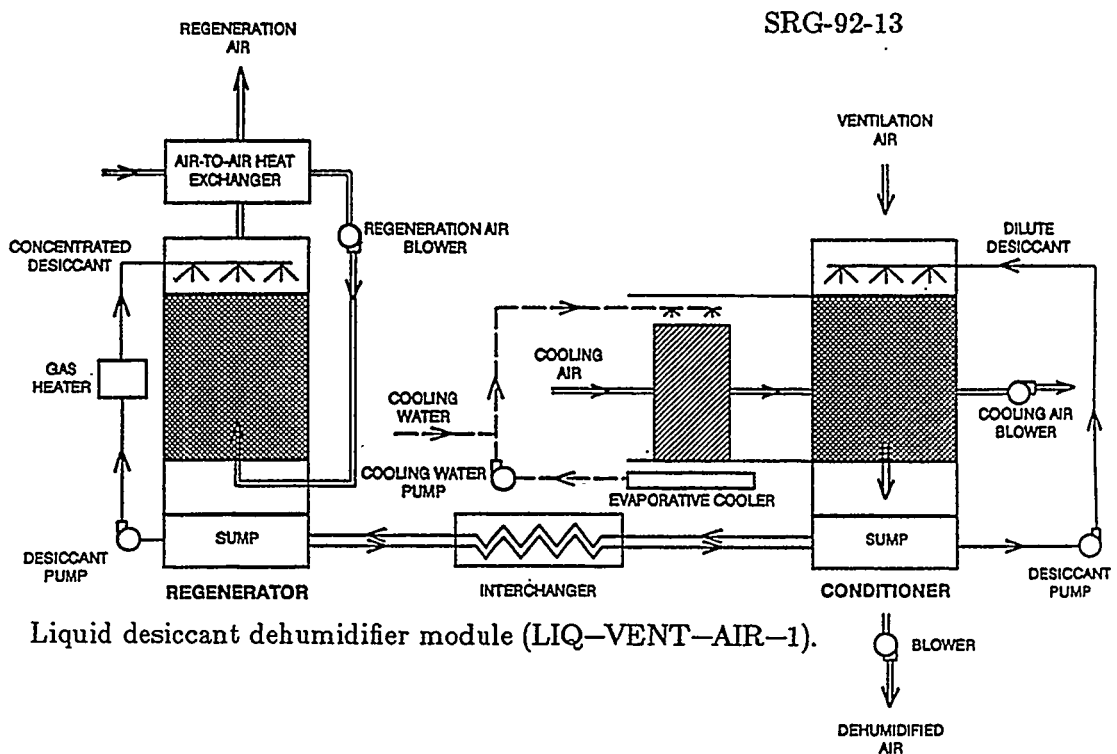

Figure 3.16: Liquid desiccant dehumidifier module (LIQ-VENT-AIR-1).

For code-word LIQ-VENT-AIR-2 (Fig. 3.17), use of the keyword DESC-CTRL-MODE = 0 operates the unit whenever the outside air temperature is above the DRYBULB-LIMIT and the system fan is on. This is the only control mode allowed since the regeneration gas firing rate is varied to maintain the exit air dewpoint at DESC-DEW-SET.

SRG-92-14

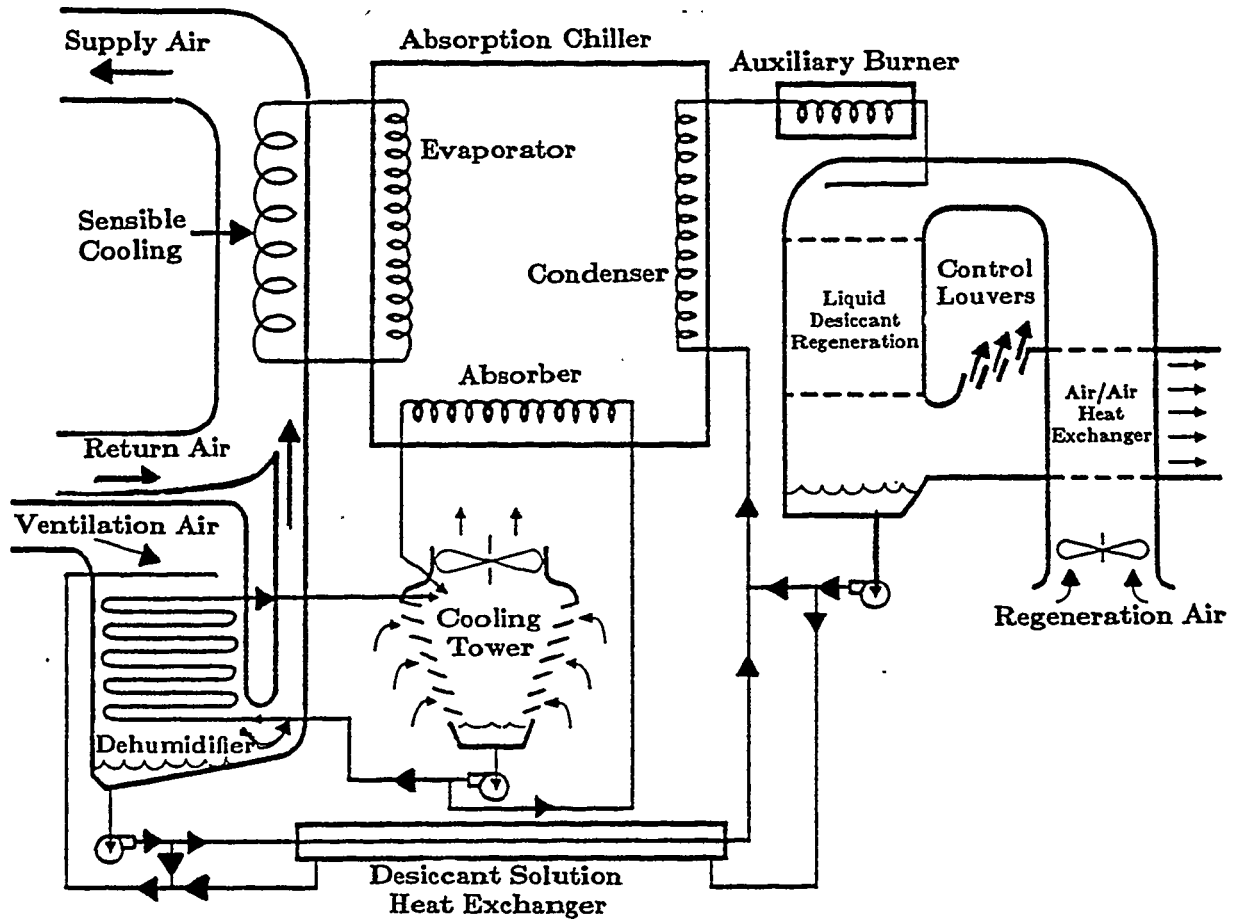
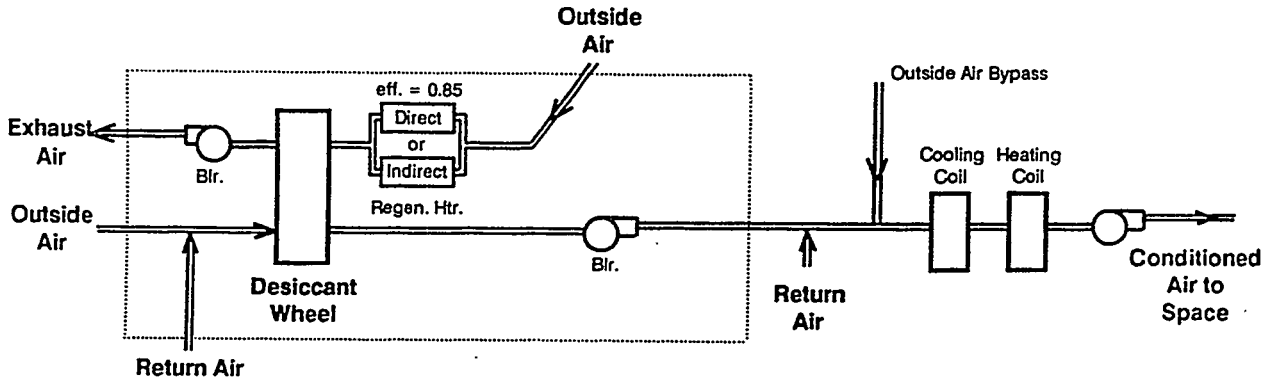

Figure 3.17: Liquid desiccant dehumidifier unit with gas-fired absorption chiller (LIQ-VENT-AIR-2).

**Control of Solid Desiccant Unit (SOL-VENT-AIR-1)**

For code-word SOL-VENT-AIR-1, DESC-CTRL-MODE specifies the unit's configuration rather than its control mode (DESC-DEW-SET is unused). Keyword DESC-CTRL-MODE = 0 is a dehumidifier-only configuration (Fig. 3.18). The desiccant wheel is cycled on and off during the hour to control the removal of the latent loads.

SRG-92-15



**Figure 3.18:** Mode 0 — Solid desiccant unit with dehumidifier only, shown integrated with a sensible cooling system.

For code-word SOL-VENT-AIR-1, DESC-CTRL-MODE = 1 is a dehumidifier plus heat exchanger configuration with regeneration preheat (Fig. 3.19). The air exiting the desiccant wheel passes through a sensible heat exchanger. This cools the hot dry air that leaves the desiccant wheel and preheats the outside air before passing through the regenerator.

SRG-92-16

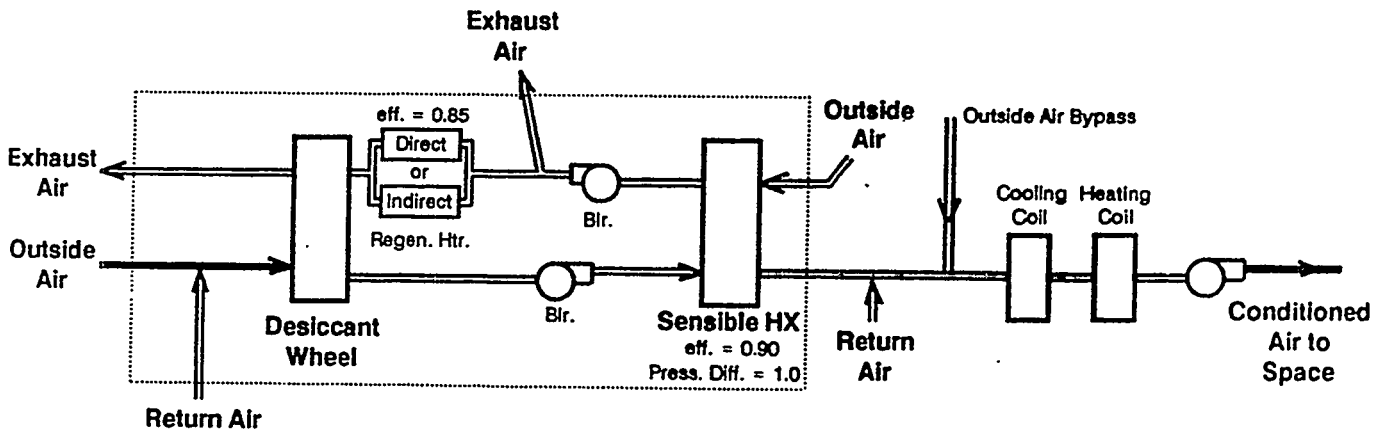

**Figure 3.19:** Mode 1 — Solid desiccant unit with dehumidifier and heat exchanger, with regeneration preheat, shown integrated with a sensible cooling system.

For code-word SOL-VENT-AIR-1, DESC-CTRL-MODE = 2 is a dehumidifier plus heat exchanger, as in Mode 1, but *without* regeneration preheat (Fig. 3.20). The outside air leaving the heat exchanger is exhausted and does not pass through the regenerator.

SRG-92-17

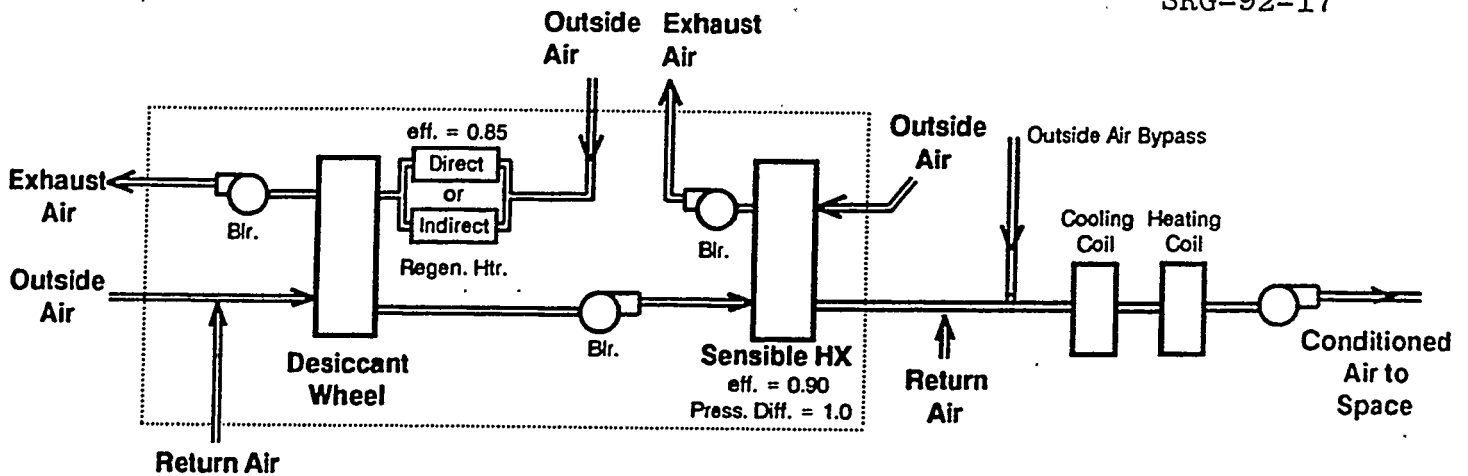

Figure 3.20: Mode 2 — Solid desiccant unit with dehumidifier and heat exchanger, without regeneration preheat, shown integrated with a sensible cooling system.

For code-word SOL-VENT-AIR-1, DESC-CTRL-MODE = 3 is the same as Mode 2, except that the heat exchanger is replaced with an indirect evaporative cooler (Fig. 3.21). This cools the hot dry air leaving the desiccant wheel but adds some moisture back into the supply air stream. The regeneration of the desiccant wheel is not affected.

SRG-92-18

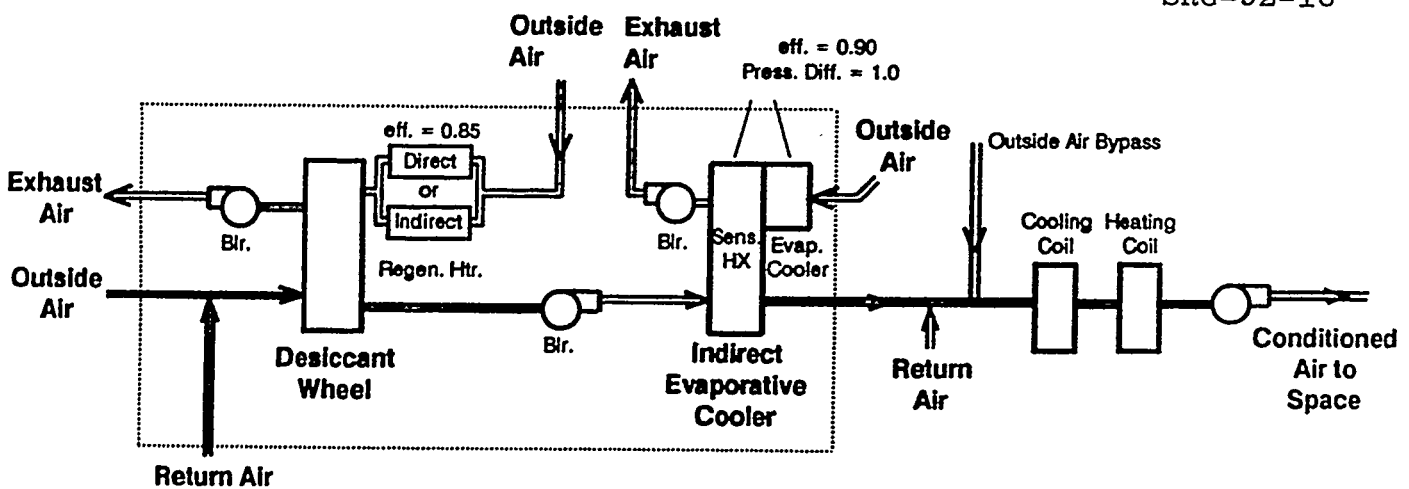

Figure 3.21: Mode 3 — Solid desiccant unit with dehumidifier and indirect evaporative cooler, without regeneration preheat, shown integrated with a sensible cooling system.



## Supplement – 2.1E Update

The following SYSTEM keywords apply to the SOL-VENT-AIR-1 sensible heat exchanger for DESC-CTRL-MODE = 1 and 2. For an example of an integrated desiccant cooling system, see “Bar/Lounge, System 2” in the *Sample Run Book (2.1E)*.

HEAT-EXCH-EFF is the effectiveness of the sensible heat exchanger (default 0.9).

HEAT-EXCH-DELP is the supply air stream pressure drop across the sensible heat exchanger (default is 1.0 inches of water).

## WATER COOLED CONDENSER OPTION FOR PACKAGED UNITS PSZ, PVAVS AND PVVT

### Introduction

In DOE-2.1E, a water cooled condenser option has been added to systems PSZ, PVAVS and PVVT whereby a cooling tower is simulated in SYSTEMS along with loop pumps (see Fig. 3.22)\*. The tower operation and control can be fixed or scheduled. A water side economizer (WSE) option is available that allows the condenser water to be diverted through a WSE coil (that cools the entering air) if the water temperature is more than a predetermined number of degrees below the air temperature; after leaving the WSE coil the water then enters the unit condenser. The cooling tower simulation for this system is the same as that for the HP system.

The tower curves for all the new simulations are the same as in the PLANT program (curve names are also the same). The cooling tower simulation used in SYSTEMS is derived from that in the PLANT program with added flexibility and more detailed controller/loop temperature calculations. In the PSZ, PVAVS, and PVVT systems, the water side economizer and outside air economizer are normally mutually exclusive; the system should only have one of these options.

New verification, summary, and hourly reports are available. The verification report gives unit size, system size, loop flowrates, and boiler and cooling tower size. The summary reports provide load, energy use, and hours-at-part-load information. Hourly reports allow detailed examination of the simulation of all system components.

**Important:** An HP system is incompatible with any other packaged system that has CONDENSER-TYPE = WATER-COOLED (PSZ, PVAVS, PVVT) in the same PLANT-ASSIGNMENT. If you are trying to model this combination of systems, then the HP system and water cooled condenser systems have to be in different PLANT-ASSIGNMENTS.

All keywords that apply, including those added in 2.1E, are as follows:

### SYSTEM-CONTROL

- WS-ECONO accepts code-words NO (the default) and YES which tell the program if a water side economizer will be simulated on PSZ and PVAVS units. This keyword only applies to the PSZ and PVAVS packaged units when CONDENSER-TYPE = WATER-COOLED.
- WS-ECONO-MIN-DT is the temperature difference between the condenser water loop temperature and the entering air temperature. The  $\Delta T$  must be greater than this minimum in order for it to reduce the unit's cooling coil load. The default is 5°F.

---

\* The enhancements described here were made by J.J. Hirsch with support from Pacific Northwest Laboratories.

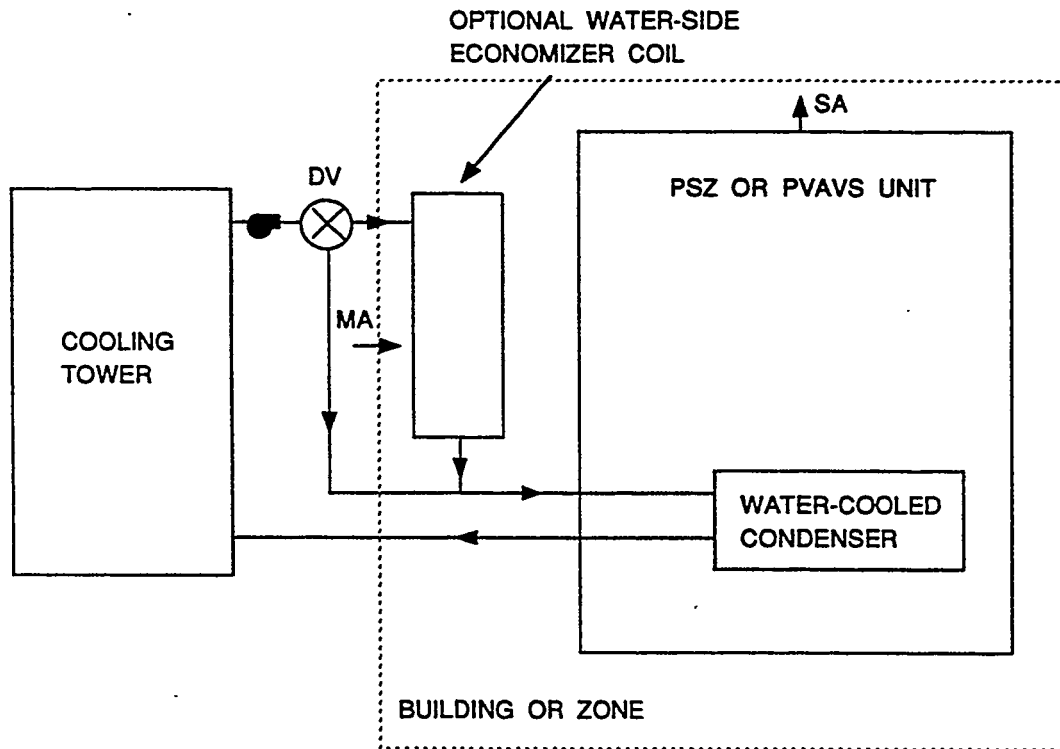

**Figure 3.22:** Packaged Water Cooled Units with or without Water Side Economizers. A diverting valve sends water directly to the water cooled condensers when cooling tower water cannot provide cooling through water side economizers.

**SYSTEM-FLUID**

**FLUID-VOLUME**

is the volume of condenser water (per unit cooling capacity) for PSZ and PVAVS water cooled units. The default is 15.0 gal/ton.

**COND-FLOW-TYPE**

accepts code-words **FIXED-FLOW** (the default) and **VARIABLE-FLOW**. If **VARIABLE-FLOW**, it is assumed that valves installed that cut off water flow when the compressors are not operating.

**COND-WTR-FLOW**

specifies the condenser water flow rate based on the PSZ or PVAVS cooling capacity. The default is 3.0 gpm/ton.

**SYSTEM-EQUIPMENT**

**CONDENSER-TYPE**

accepts code-words **AIR-COOLED** (the default), **EVAP-PRECOOLED**, or **WATER-COOLED** for the PSZ, PVAVS and PVVT systems.

In the left column above, bold-faced words are commands, non-bold words are keywords, and italicized words are code-words.

WS-ECONO-XEFF

is the coil design effectiveness for a heat exchanger, if present, between the tower water loop and the condenser water loop. The default is 0.60. This only applies to PSZ or PVAVS.

The following keywords allow you to specify various parameters for a cooling tower/water cooler when it is simulated in SYSTEMS for the PSZ and PVAVS water cooled condensers and water side economizers.

### PLANT-ASSIGNMENT

TWR-SIZE

is the nominal rated output capacity, expressed in units of one million Btu's per hour, of each cell in the cooling tower. The capacity is the capacity of the tower at the TWR-DESIGN-WETBULB and TWR-DESIGN-APPROACH. The range is determined by the program based on the design loop flowrate and load. If TWR-SIZE is not entered, the program will automatically size the tower based on the cooling equipment specified. Only one cooling tower size may be entered in a PLANT-ASSIGNMENT.

TWR-NUM-CELLS

are the total number of cells of the type and size previously specified. If not entered, the program will determine the number of cells required, based on a maximum load of 15 million Btu/hr per cell.

TWR-EIR

is the electric input to nominal capacity ratio for the cooling tower fan expressed as ratio = (fan electric power in Btu/hr) / (SIZE in Btu/hr) where SIZE is the heat rejection capacity per cell as specified or defaulted. If not specified, the program will default the fan power consumption of an open tower to 0.0154 HP/gpm at the Cooling Tower Institute (CTI) rating conditions. This corresponds to an ELEC-INPUT-RATIO of approximately 0.0105 Btu/Btu. TWR-SCH specifies the availability of the cooling tower. If not specified, the tower will be available whenever the loop pumps operate as specified in CIRC-PUMP-SCH.

Acceptable values are:

- 0 Tower is not available.
- 1 Tower is available.
- >1 Tower is available whenever the ambient temperature is greater than this value.

TWR-SETPT-CTRL

Specifies the control for the exiting fluid temperature setpoint. The default is *FIXED-TEMP*.

*FIXED-TEMP*

the default, controls the tower to the fixed setpoint specified by *TWR-SETPT-T* or *TWR-SETPT-SCH*. Tower capacity adjusts according to the *TWR-CAP-CTRL*. To simulate a tower whose temperature floats with the load and wetbulb, simply specify a low setpoint, such as 60°F.

*WETBULB-RESET*

causes the setpoint to drop as the wetbulb drops. This approach recognizes that, as the wetbulb drops, the exiting tower temperature can also drop without any increase in tower energy consumption (although tower energy might otherwise be saved). At design conditions, the tower setpoint will be  
setpoint = *TWR-DESIGN-WETBULB*  
+ *TWR-DESIGN-APPROACH*

For a given load, a tower cannot achieve the same approach as the wetbulb drops (the approach will increase). Accordingly, the program will modify the approach as the wetbulb drops as follows:

$$\text{APP} = (\text{TWR-DESIGN-WETBULB} - \text{TWB}) \\ * \text{TWR-RESET-RATIO} \\ + \text{TWR-DESIGN-APPROACH.}$$

Setpoint = TWB + APP, where APP is the achievable approach, and TWB is the current hour's wetbulb temperature.

TWR-SETPT-T

specifies the exiting water temperature setpoint when the *TWR-SETPT-CTRL* is *FIXED-TEMP*. This value is defined to be the midpoint of the controller's throttling range. The default is 80°F. When *TWR-SETPT-CTRL* is *WETBULB-RESET*, this value acts as an upper limit on the tower setpoint.

TWR-SETPT-SCH

accepts the u-name of a schedule that allows the setpoint to be varied with time. If specified, the schedule value will override any value specified for *TWR-SETPT-T*.

TWR-THROTTLE

is the effective throttling range about the setpoint. The default is 10°F. When a variable speed fan is used, setting this value to a relatively broad range (10°F-30°F) will allow the fan to slowly unload as the tower temperature drops. In many cases, this strategy may result in the best overall system efficiency.

**MIN-TWR-WTR-T** specifies the minimum temperature for leaving tower cooling water when **TWR-SETPT-CTRL** is **WETBULB-RESET**. This value acts as a lower limit on tower temperature as the wetbulb drops. The default is 65°F.

**TWR-RESET-RATIO** specifies the ratio of the change in achievable approach with wetbulb. The default is 0.29. The default value is accurate for an open tower at full load. Oftentimes, however, the load may be less at lower wetbulbs since lower wetbulbs often correspond to lower drybulbs and reduced building loads. To take this effect into account, you may want to experiment with other values, such as 0.40

**TWR-CELL-CTRL** in multiple-cell towers, specifies whether the controls attempt to operate only the number of cells needed to meet the load, or operate as many cells as possible. Options are:

**MIN-CELLS** the default, indicates that only the actual number of cells needed will be used. All other cells will be shut down with no water flow. If the tower is controlling to a fixed setpoint, the gallons/minute capacity per cell will increase as the wetbulb drops. The program will attempt to use as few cells as possible to cool the fluid. In no case, however, will the flow per cell be allowed to exceed the **MAX-RATIO** as specified in the **PART-LOAD-RATIO** command.

**MAX-CELLS** indicates that all cells will be used in parallel. In no case, however, will the flow per cell be allowed to drop below the **MIN-RATIO** as specified in the **PART-LOAD-RATIO** command (unless only one cell is operating). This strategy will enhance the energy savings associated with two-speed or variable speed fans, and is strongly recommended.

**TWR-CAP-CTRL** specifies the control method which regulates the tower exit temperature. The default is **ONE-SPEED-FAN**, which simulates a one-speed fan cycling on and off. Options are:

**FLUID-BYPASS** utilizes a three-way valve to bypass water around the cooling tower. The valve modulates to maintain the tower setpoint. The tower fan runs continuously during all hours that a heat rejection load exists.

**ONE-SPEED-FAN** the default, causes the one speed fan to cycle to maintain the tower setpoint. Note that DOE-2 assumes the fan can cycle as often as required to maintain the setpoint. In actual practice, fan cycling is usually limited to no more than 4-8 cycles per hour to protect the motor against burnout. This can cause wide fluctuations in the condenser loop temperature, which is not modeled in DOE-2.

Supplement — 2.1E Update

- TWO-SPEED-FAN* causes the fan to cycle between off, low and high speeds to maintain the tower setpoint.
- VARIABLE-SPEED-FAN* modulates the airflow so that tower capacity exactly matches the load at the desired setpoint. This code word simulates both variable speed drives as well as variable pitch fans. Power consumption at reduced airflows is calculated using the *TWR-FAN-FPLR* curve in the *EQUIPMENT-QUAD* command.
- TWR-FAN-OFF-CFM* is the airflow rate through the tower when the fans are off. That is, this is the flow rate caused by natural convection, divided by the flow rate at high speed (design). The default is 0.17. *TWR-FAN-LOW-CFM* specifies the ratio of airflow through the tower when the fans are on low speed, to the airflow at high speed. This keyword is used only when the *TWR-CAP-CTRL* is *TWO-SPEED*. The default is 0.50.
- TWR-FAN-LOW-ELEC* specifies the ratio of the power consumed by the fan at low speed to the power consumed at high speed. This keyword is used only when the *TWR-CAP-CTRL* is *TWO-SPEED*. The default is 0.16.
- TWR-MIN-FAN-SPEED* when a variable speed fan is used, specifies the minimum fraction of at nominal fan speed at which the fan can operate. The default is 0.40. If the load is such that the tower will overcool the fluid at this minimum speed, then the fan will cycle between off and minimum speed. It is possible that the tower fan may reach a "critical speed" as the airflow is reduced. This is because the static pressure capability of the fan will drop as the square of the speed. The static pressure drop of the tower, however, may not fall off as the square of the airflow, as air flowing through falling water does not obey the ideal fan laws. As a result, the fan may enter a "surge region" if the speed is sufficiently low. For specific applications, the tower manufacturer should be consulted.
- TWR-PUMP-HEAD* is the pressure head in the tower water circulation loop. This head is used together with the fluid flowrate, impeller efficiency and motor efficiency to determine the power consumption of the condenser pump. The default is 20.
- TWR-IMPELLER-EFF* specifies the impeller efficiency of the tower circulation pump. The default is 0.77 *TWR-MOTOR-EFF* specifies the efficiency of the tower pump motor. The default is 0.90.
- TWR-CELL-MAX-GPM* specifies the largest allowable ratio of actual flow rate to nominal flow rate determined at the CTI conditions. The default is 2.0. You should refer to *TWR-CELL-CTRL* in

PLANT—PARAMETERS for more information on the meaning of this keyword.

TWR—CELL—MIN—GPM

specifies the smallest allowable fraction of the nominal flow rate for which the cooling tower is still rated. The nominal flow rate is determined at The Cooling Tower Institute (CTI) rating conditions of 95°F entering fluid temperature, 85°F leaving fluid temperature, and 78°F approach (95-85-78). These conditions correspond to a range of 10°F and an approach of 7°F. The default is 0.33. You should refer to TWR—CELL—CTRL for more information on the meaning of this keyword.

TWR—DESIGN—WETBULB

is the wetbulb temperature used in the cooling tower design calculations. If not specified, the default is 78°F, which corresponds to the point at which towers are nominally rated by the Cooling Tower Institute. Specifying a higher wetbulb with other conditions fixed (including design approach) will cause the program to use a larger tower than otherwise. Energy consumption may then either increase or decrease depending on the method of TWR—CAP—CTRL and the temperature setpoint.

TWR—DESIGN—APPROACH

is the approach used in the cooling tower design calculations. If not specified, the default is 7°F, which corresponds to the point at which towers are nominally rated by the Cooling Tower Institute (95°F entering fluid temperature, 85°F leaving, when the wetbulb is 78°F). Specifying a higher approach with other conditions fixed (including design wetbulb) will cause the program to use a smaller tower than otherwise. Energy consumption may then either increase or decrease depending on the method of TWR—CAPACITY—CTRL and the temperature setpoint.

TWR—FAN—FPLR

accepts the u-name of a CURVE—FIT instruction that defines a cubic equation. That equation will be used to express the tower fan horsepower as the airflow drops as a fraction of the horsepower at full airflow.

TWR—GPM—FRA

accepts the u-name of a CURVE—FIT instruction that defines a bi-quadratic equation. That equation will be used to express an intermediate variable which is a function of the range and approach. The intermediate variable is in turn used in the curve TWR—GPM—FWB.

TWR—GPM—FWB

accepts the u-name of a CURVE—FIT instruction that defines a bi-quadratic equation. That equation defines the current tower capacity relative to the capacity at the CTI design conditions. It is a function of TWR—GPM—FRA, defined above, and the wetbulb temperature.



## Supplement - 2.1E Update

The following keywords allow you to specify various parameters for a water loop circulating pump when it is simulated in SYSTEMS for the PSZ, PVVT and PVAVS water cooled condensers and water side economizers.

- CIRC-IMPELLER-EFF is the condenser water loop circulating pump impeller efficiency. The default is 0.77.
- CIRC-MOTOR-EFF is the condenser water loop circulating pump motor efficiency. The default is 0.90.
- CIRC-HEAD is the condenser water loop circulating pump head at which it must work. The default is 60 feet.
- CIRC-PUMP-TYPE accepts code-words of FIXED-FLOW (the default) or VARIABLE-FLOW (which covers the case of packaged units that cut the flow of water whenever the unit is off).
- CIRC-MIN-PLR is the minimum part load ratio allowed for VARIABLE-FLOW pumping; below this value, the flow is considered to be constant. The default is 0.5.
- CIRC-PUMP-FPLR accepts the u-name of a curve that modifies the pumping energy as a function of part load ratio. The default is CIRC-PUMP-CURVE.
- CIRC-PUMP-SCH accepts the u-name of a schedule that serves as the main control over the operation of the system. The default is always on. An hourly value of 0=off and 1=on.

Supplement - 2.1E Update

**Example:**

This is a sample SYSTEMS input of a water cooled condenser. The system employs vertical packaged cooling units (VPCUS), each serving an entire building floor. The VPCUS are DX units simulated using a packaged variable air volume (PVAVS) system. Cooling water is pumped to the VPCUS from a central cooling tower and the VPCUS are equipped with water-side economizers. Heating is provided by electrical resistance heating coils in VAV boxes and by resistance coils in the VPCUS.

\$ ..... PACKAGED SYSTEM WITH WATER-COOLED CONDENSER \$ ..... \$

INPUT SYSTEMS ..  
 ABORT ERRORS ..  
 DIAGNOSTIC CAUTIONS NARROW ..

\$ ..... SYSTEM PARAMETERS \$ ..... \$

PARAMETER

NO-MID-FLOORS = 8 ..

\$ ..... SYSTEM OPERATING SCHEDULES \$ ..... \$

HVAC-HEAT = SCHEDULE THRU DEC 31 (ALL) (1,24) (1) ..  
 HVAC-COOL = SCHEDULE THRU DEC 31 (ALL) (1,24) (1) ..  
 HVAC-FAN = SCHEDULE THRU DEC 31 (WD) (1,6) (0) (7,22) (1) (23,24) (0)  
   (SAT) (1,6) (0) (7,22) (1) (23,24) (0)  
   (SUN,HOL) (1,8) (0) (9,21) (1) (22,24) (0) ..  
  
 TWR-SET - SCHEDULE THRU FEB 28 (ALL) (1,24) (50)  
   THRU OCT 31 (ALL) (1,24) (75)  
   THRU DEC 31 (ALL) (1,24) (50) ..  
  
 HEAT-SET - SCHEDULE THRU DEC 31 (WD) (1,5) (60) (6,22) (70) (23,24) (60)  
   (SAT) (1,5) (60) (6,22) (70) (23,24) (60)  
   (SUN,HOL) (1,7) (60) (8,21) (70) (22,24) (60) ..  
  
 COOL-SET - SCHEDULE THRU DEC 31 (WD) (1,5) (99) (6,22) (75) (23,24) (99)  
   (SAT) (1,5) (99) (6,22) (75) (23,24) (99)  
   (SUN,HOL) (1,7) (99) (8,21) (75) (22,24) (99) ..

Supplement -- 2.1E Update

§ ----- ZONE DEFINITIONS § ----- §

```

INTERIOR-GROUND = ZONE
    ZONE-TYPE           = CONDITIONED
    SIZING-OPTION      = ADJUST-LOADS
    MIN-CFM-RATIO      = 0.30
    THERMOSTAT-TYPE    = REVERSE-ACTION
    DESIGN-COOL-T      = 75
    DESIGN-HEAT-T      = 70
    HEAT-TEMP-SCH      = HEAT-SET
    COOL-TEMP-SCH      = COOL-SET ..

NORTH-GROUND = ZONE LIKE INTERIOR-GROUND EXHAUST-CFM = 0 ..
EAST-GROUND  = ZONE LIKE NORTH-GROUND ..
SOUTH-GROUND = ZONE LIKE NORTH-GROUND ..
WEST-GROUND  = ZONE LIKE NORTH-GROUND ..

INTERIOR-MID = ZONE LIKE INTERIOR-GROUND
                MULTIPLIER = NO-MID-FLOORS ..
NORTH-MID    = ZONE LIKE NORTH-GROUND
                MULTIPLIER = NO-MID-FLOORS ..
EAST-MID     = ZONE LIKE NORTH-GROUND
                MULTIPLIER = NO-MID-FLOORS ..
SOUTH-MID    = ZONE LIKE NORTH-GROUND
                MULTIPLIER = NO-MID-FLOORS ..
WEST-MID     = ZONE LIKE NORTH-GROUND
                MULTIPLIER = NO-MID-FLOORS ..

INTERIOR-TOP = ZONE LIKE INTERIOR-GROUND ..
NORTH-TOP    = ZONE LIKE NORTH-GROUND ..
EAST-TOP     = ZONE LIKE NORTH-GROUND ..
SOUTH-TOP    = ZONE LIKE NORTH-GROUND ..
WEST-TOP     = ZONE LIKE NORTH-GROUND ..

GRND-FLR-PLENUM = ZONE
    ZONE-TYPE           = PLENUM
    DESIGN-HEAT-T      = 64
    DESIGN-COOL-T      = 90 ..

MID-FLR-PLENUM = ZONE LIKE GRND-FLR-PLENUM
                MULTIPLIER = NO-MID-FLOORS ..

TOP-FLR-PLENUM = ZONE LIKE GRND-FLR-PLENUM ..
    
```

Supplement - 2.1E Update

§ ----- SYSTEM DEFINITIONS § ----- §

GROUND-SYSTEM = SYSTEM § SYSTEM SERVING GROUND FLOOR ZONES

SYSTEM-TYPE = PVAVS  
 SIZING-RATIO = 1.10  
 HEAT-SOURCE = ELECTRIC  
 ZONE-HEAT-SOURCE = ELECTRIC  
 RETURN-AIR-PATH = PLENUM-ZONES  
 MIN-SUPPLY-T = 55  
 REHEAT-DELTA-T = 55  
 HEATING-SCHEDULE = HVAC-HEAT  
 COOLING-SCHEDULE = HVAC-COOL  
 FAN-SCHEDULE = HVAC-FAN  
 FAN-CONTROL = INLET  
 SUPPLY-STATIC = 2.5  
 SUPPLY-MECH-EFF = 0.80  
 SUPPLY-EFF = 0.55  
 MOTOR-PLACEMENT = IN-AIRFLOW  
 FAN-PLACEMENT = DRAW-THROUGH  
 MAX-FAN-RATIO = 1.00  
 MIN-FAN-RATIO = 0.30  
 NIGHT-CYCLE-CTRL = CYCLE-ON-ANY  
 CONDENSER-TYPE = WATER-COOLED  
 WS-ECONO = YES  
 ZONE-NAMES = ( INTERIOR-GROUND, NORTH-GROUND,  
 EAST-GROUND, SOUTH-GROUND,  
 WEST-GROUND, GRND-FLR-PLENUM)  
 PLENUM-NAMES = (GRND-FLR-PLENUM) ..

MID-SYSTEM = SYSTEM LIKE GROUND-SYSTEM

ZONE-NAMES = ( INTERIOR-MID, NORTH-MID, EAST-MID,  
 SOUTH-MID, WEST-MID, MID-FLR-PLENUM)  
 PLENUM-NAMES = (MID-FLR-PLENUM) ..

TOP-SYSTEM = SYSTEM LIKE GROUND-SYSTEM

ZONE-NAMES = ( INTERIOR-TOP, NORTH-TOP, EAST-TOP,  
 SOUTH-TOP, WEST-TOP, TOP-FLR-PLENUM)  
 PLENUM-NAMES = (TOP-FLR-PLENUM) ..

Supplement - 2.1E Update

```
PLANT-1 = PLANT-ASSIGNMENT
CIRC-PUMP-SCH      = HVAC-FAN $ 0=off, 1=on
TWR-SCH           = HVAC-FAN $ 0=off, 1=on, >1 is min operating
TWR-SETPT-SCH = TWR-SET
MIN-TWR-WTR-T     = 50          $ low limit tower control $
TWR-CAP-CTRL      = TWO-SPEED-FAN
CIRC-HEAD         = 60          $ main condenser pumps $
SYSTEM-NAMES      = (GROUND-SYSTEM, MID-SYSTEM, TOP-SYSTEM) .
```

```
$ ----- SYSTEMS REPORT ----- $
```

```
SYSTEMS-REPORT
VERIFICATION = (SV-A)
SUMMARY = (SS-D, SS-A, SS-H, SS-L) .. $ NEW SS-P reports turned on
                                           $ with SS-H (new SS-L too)

END ..
COMPUTE SYSTEMS ..
STOP ..
```

## EVAPORATIVE PRECOOLER FOR AIR-COOLED DIRECT-EXPANSION UNITS

### Introduction

An option to add an evaporative cooler to the condenser section of RESYS, PSZ, PMZS, PVAVS, PVVT, and PTAC systems has been added to DOE-2.1E. This unit, when activated, uses a direct evaporative cooling process to cool outdoor air before it enters the air-cooled condensing unit. The model used for the direct evaporative process is a simple saturation efficiency relation that assumes a constant air flow (and thus effectiveness) through the evaporative precooler when it is active. The unit operation can be scheduled in time or operated whenever the outside temperature goes above (or stays below a threshold value). If the DX unit has a heat pump heating option it operates in the standard manner when in the heating mode. The keywords controlling the operation of this unit are described below.

### SYSTEM

#### CONDENSER-TYPE

##### *EVAP-PRECOOLED*

Specifies that the air-cooled condensing unit on a RESYS, PSZ, PMZS, PVAVS, PTAC, or PVVT system includes an evaporative precooler. The precooler is controlled by a time and/or temperature controller that decides if the unit should operate (see *EVAP-PCC-SCH*, *EVAP-PCC-EFF*, and *EVAP-PCC-ELEC*). When this unit doesn't operate, the condenser returns to `CONDENSER-TYPE=AIR-COOLED` simulation. The evaporative precooler is only active during cooling mode. If no operation schedule is specified using *EVAP-PCC-SCH*, a default operation is assumed which provides for cooling mode operation whenever the outside drybulb temperature is more than two degrees above the value of `COOL-FT-MIN` in the `SYSTEM-EQUIPMENT` command.

##### *EVAP-PCC-SCH*

Controls when the evaporatively precooled condenser for air cooled units can operate. A zero value indicates that the unit is locked off; 1 indicates the unit is operating. A value  $>1$  indicates that the unit operates only if the outside temperature is *less than* the scheduled value. A value  $<0$  indicates that the unit operates only if the outside temperature is *greater than* the absolute value of the scheduled value ( $-1*\text{value}$ ).

##### *EVAP-PCC-EFF*

Is the effectiveness of the evaporative process in the evaporative precooling unit. This value is defined as the fraction of the maximum wetbulb depression that can be realized by the outdoor air passing through the precooling unit before entering the condensing section. Independent of this value, the approach to the wetbulb temperature is not allowed to become smaller than

---

In the left column above, bold-faced words are commands, non-bold words are keywords, and italicized words are code-words.

Supplement — 2.1E Update

3°F during the precooling unit operation.

EVAP—PCC—ELEC

Provides the electric consumption of the evaporative precooling unit during operation. The value is specified as watts of electric consumption per Btu of cooling system output at ARI conditions (which is the value specified or calculated for COOLING—CAPACITY).

## OUTSIDE AIR ECONOMIZER CONTROL

There are a number of different applications and different methods of controlling outside air economizers. The primary differences lie in whether the system is a central built-up system with chilled water coils served by central plant water chillers, or a packaged unit (either rooftop or split system) with direct expansion cooling coils served by reciprocating compressors. DOE-2 makes a distinction between these different applications in that some of the economizer keywords apply only to the packaged units (PSZ, PVAVS, PVVT, PMSZ, and HP).

### SYSTEM-AIR

Under the SYSTEM-AIR command, economizer type is selected with the keyword OA-CONTROL, which takes code-words TEMP, ENTHALPY, or FIXED.

### OA-CONTROL

#### *TEMP*

(the default) simulates a standard mixed-air-controlled economizer. The outside air damper is returned to minimum whenever the outside dry bulb temperature is higher than DRYBULB-LIMIT (which defaults to the return air temperature at the beginning of each hour).

For packaged air conditioners, additional limits may be specified with the SYSTEM-CONTROL keywords ENTHALPY-LIMIT, ECONO-LOW-LIMIT, and ECONO-LOCKOUT, as described below.

#### *ENTHALPY*

simulates an economizer that returns the outside air damper to minimum if the outside air enthalpy is higher than the return air enthalpy or if the outside air temperature is higher than DRYBULB-LIMIT (which defaults to the return air temperature).

For packaged air conditioners, additional limits may be specified with the SYSTEM-CONTROL keywords ECONO-LOW-LIMIT and ECONO-LOCKOUT, as described below.

#### *FIXED*

simulates no economizer; i.e., the position of the outside air damper is fixed.

**CAUTION:** In some climates, notably northern California, a drybulb limit is not used for either the TEMP or ENTHALPY type of economizer and only the comparison of outside and return air drybulb and/or enthalpy determine whether the economizer is open. In this situation, to *not* specify DRYBULB-LIMIT (thus allowing it to default to return air temperature).

---

In the left column above, bold-faced words are commands, non-bold words are keywords, and italicized words are code-words.



SYSTEM-CONTROL

DRYBULB-LIMIT

is the outside drybulb temperature above which the outside air damper returns to minimum position (if OA-CONTROL=TEMP or ENTHALPY). If not specified, DRYBULB-LIMIT defaults each hour to the return air temperature at the beginning of the hour. The drybulb limit can be removed by specifying a high value (e.g., DRYBULB-LIMIT = 99). For a standard drybulb economizer, a value of 68°F is common for humid climates. A setting of 72°F is most often used when OA-CONTROL = ENTHALPY. For upward compatibility with previous versions of DOE-2, DRYBULB-LIMIT has been equivalenced to ECONO-LIMIT-T.

The following SYSTEM-CONTROL keywords apply only to packaged air conditioners (system type PSZ, PVAVS, PVVT, PMZS, and HP) with economizers:

ENTHALPY-LIMIT

is the outside air enthalpy above which the outside air damper returns to minimum (if OA-CONTROL=TEMP or ENTHALPY). There is no default; if not specified, there is no enthalpy limit. If a high value of ENTHALPY-LIMIT (>30 Btu/lb-dry-air) is entered, it is recommended that OA-CONTROL = TEMP be used rather than OA-CONTROL = ENTHALPY.

ECONO-LOW-LIMIT

is the outside drybulb temperature *below* which the economizer dampers return to a minimum position (if OA-CONTROL=TEMP or ENTHALPY) (see Fig. 3.23). This may be used to minimize the amount of moisture needed for humidification. It may also be used to simulate false loading of a double bundle heat recovery chiller.

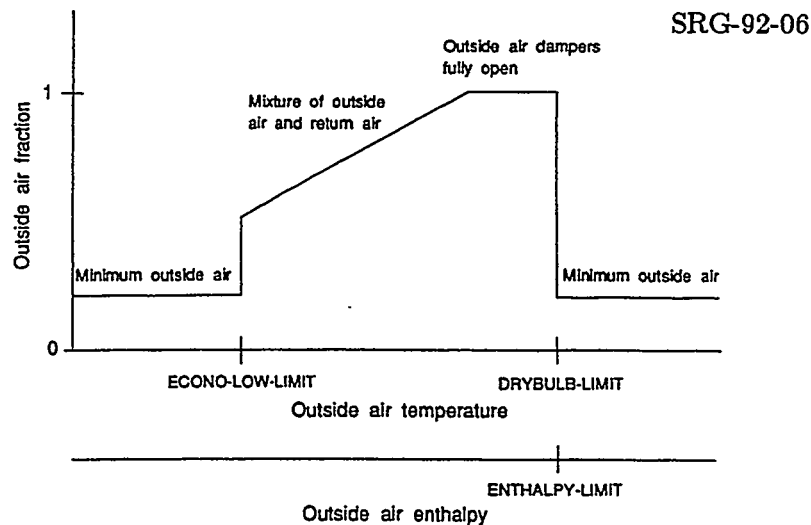

Figure 3.23: Economizer control action.

ECONO—LOCKOUT

accepts code-words YES and NO. The default is system dependent: System type PSZ defaults to YES and PVAVS and PMZS default to NO. ECONO—LOCKOUT control is applicable to OA—CONTROL = TEMP and OA—CONTROL = ENTHALPY. This keyword is not applicable to the water loop heat pump (HP).

YES

is equivalent to what the California Energy Commission calls a “nonintegrated” economizer — the compressor is never on when the economizer dampers are open, and the economizer takes precedence over the compressor whenever the economizer can satisfy the cooling load by itself.

NO

is equivalent to what the California Energy Commission calls an “integrated” economizer — the compressor can operate even though the economizer dampers are open, but, again, the economizer takes precedence over the compressor. The ENTHALPY—LIMIT and DRYBULB—LIMIT values corresponding to the A through D settings of an “integrated” controller (furnished as part of the controls on many packaged units manufactured in the USA), are as follows:

Setting	ENTHALPY—LIMIT (Btu/lb)	DRYBULB—LIMIT (°F)
A	28.0	78
B (nominal setting)	25.0	74
C	22.0	68
D	20.0	63

Economizer control examples are shown on the following page

Supplement — 2.1E Update

Examples:

- (1) For a Drybulb Economizer with a fixed drybulb limit of 68°F the input is:

OA-CONTROL = TEMP  
DRYBULB-LIMIT = 68

- (2) For an Enthalpy Economizer with a drybulb limit of 72°F the input is:

OA-CONTROL = ENTHALPY  
DRYBULB-LIMIT = 72

In the following examples, California Energy Commission terminology is shown in quotation marks.

- (3) For a "Differential Drybulb Economizer" the input is:

OA-CONTROL = TEMP

- (4) For a "Differential Enthalpy Economizer" with a drybulb limit equal to the return air temperature, the input is:

OA-CONTROL = ENTHALPY

- (5) For a "Differential Enthalpy Economizer" with no drybulb limit the input is:

OA-CONTROL = ENTHALPY  
DRYBULB-LIMIT = 99

- (6) For a "nonintegrated" packaged rooftop unit (PSZ) with an "A" setting of an Enthalpy Economizer control, the input is:

OA-CONTROL = ENTHALPY  
ENTHALPY-LIMIT = 28  
DRYBULB-LIMIT = 78  
ECONO-LOCKOUT = YES  
MIN-HGB-RATIO = .25 (the default for PSZ)  
MIN-UNLOAD-RATIO = .25 (the default)

- (7) For an "integrated" packaged variable volume unit (PVAVS) with a "B" setting of an Enthalpy Economizer control, the input is:

OA-CONTROL = ENTHALPY  
ENTHALPY-LIMIT = 25  
DRYBULB-LIMIT = 74  
ECONO-LOCKOUT = NO  
MIN-HGB-RATIO = 0.0 (the default for PVAVS)  
MIN-UNLOAD-RATIO = .25 (the default)

## OPTIMUM FAN START OPTION

### SYSTEM-FANS

#### FAN-SCHEDULE

takes as a value the u-name of a schedule instruction that specifies fan operation for each hour. If the hourly value is -1, the fans are on. If the hourly value is 0, the fans are off but may be turned on by NIGHT-CYCLE-CTRL if ZONE temperatures warrant it. If the hourly value is -1, the fans are not permitted to be on for any reason.

The program now accepts hourly values of -999 to define an optimum start period of up to six hours duration. During this period the fan start time is delayed until the fan run time matches that which is needed to meet the desired ZONE temperatures. Notice that this decision is made on an hourly basis, whereas in the real world it is made on much smaller increments of time (i.e., ten minutes or less). For the hourly calculation, the number of hours needed to bring each ZONE on the system up or down to its set point is estimated. If the number of such hours for the majority of the zones is equal to or greater than the number of hours remaining in the start period, the fans are turned on. The target zone temperatures used in the calculation are the heating and cooling set temperatures scheduled in HEAT-TEMP-SCH and COOL-TEMP-SCH that correspond to the first hour following the scheduled optimum start period.

#### Rules:

1. The optimum start period must be less than or equal to six hours.
2. The fan must be scheduled on using the value 1 for the first hour following the optimum start period.
3. An optimum start period must be defined within a contiguous set of hours. Therefore, the optimum start period cannot begin before 1:00 A.M. E.g., the following example is *not valid*:

F1 = D-SCH (1,4) (-999) (5,18) (1) (19,22) (0) (23,24) (-999) ..

**Cautions:**

1. Zones with Trombe walls should not be used with optimum start.
2. Optimum start will not work well on systems serving zones which are not evenly balanced with respect to their start up duration.
3. If the system is under-sized, or can not supply sufficient air at its minimum or maximum supply temperature, the start time will be delayed too long and there will be excessive hours reported with loads not met. A VAV system with a low MIN-CFM-RATIO and a thermostat type that is not REVERSE-ACTION fits this description.
4. The results for short RUN-PERIODs of just a few days will not produce results as good as those for longer RUN-PERIODs since the program attempts to learn (simulating feedback) to improve on its estimating abilities.
5. During hours of the optimum start period in which the fan has not been started, the system will behave as if the fan schedule that hour were (0). Thus, the fan can cycle on during this period if NIGHT-CYCLE-CTRL is used.
6. For Air/Air Heat Pumps, where the primary interest is one of minimizing the use of electric resistance heating during start-up, it is suggested that the set point temperature be ramped upward. This should start with the first hour during a normal fan start period.

Example input/output may be found in the *Sample Run Book (2.1E)* in the 31-Story Office Building, Runs 1 through 6.

## HEAT RECOVERY FROM REFRIGERATED CASE WORK

### Introduction

Keywords were added to the PSZ (Packaged Single Zone) system to allow simulation of refrigerated case work, such as that found in supermarkets, with or without heat recovery. The routines can also be used to simulate ice rinks with or without heat recovery. You can specify refrigerated case work up to three different temperature levels and specify a corresponding load for each level. The temperature levels reflect the evaporator temperatures of different types of display cases for various products such as frozen foods, meats, dairy products, and produce. However, these routines are only applicable to the situation of one main zone, served by a single PSZ unit, and all case work contained within that zone. This does not preclude splitting a supermarket into two or more zones, each with separate PSZ units. Subzones are allowed, such as office mezzanines, but the refrigerated cases, space temperature control, and heat recovery only apply to the *first-named* main zone in the ZONE—NAMES list. Therefore, subzone reheat can not be simulated as recovered heat.

### ZONE

The ZONE keyword additions are as follows:

#### REFG—ZONE—LOAD

is the total cooling effect (sensible + latent) to the zone due to air spilling from the open cases and by heat radiating from other surfaces to the cold surfaces of the cases. A list of up to three entries is allowed, all at zone design drybulb and relative humidity defined under keywords REFG—ZONE—DES—T and REFG—ZONE—DES—RH; see below. The list entries must be made in order, starting with the coldest and progressing to the warmest evaporator temperature. This keyword is required for the simulation, and can range from -99999999.0 to 0.0 Btu/hr.

Manufacturers of supermarket cases usually do not list the total cooling effect of their cases directly. Instead, they list the compressor capacity at a standard suction temperature required per lineal foot of case work. The sensible cooling effect is typically 65% of this number, and the latent cooling effect is about 10%. The total cooling effect is then about 75% of the listed compressor capacity per lineal foot, multiplied by the lineal feet of case work.

#### REFG—ZONE—SHR

is the ratio of sensible to total heat. List of three entries (order corresponds to REFG—ZONE—LOAD entries) at all zone design drybulb and relative humidity defined under keywords REFG—ZONE—DES—T and REFG—ZONE—DES—RH, see below. The default is 0.8.

#### REFG—ZONE—DES—T

is the zone drybulb temperature at which the case is rated (usually 75°F) as referenced by REFG—ZONE—LOAD. List of three entries (order corresponds to REFG—ZONE—LOAD entries). The range is from 30.0 to 100.0°F and the default is 75°F. Values must be greater than the corresponding

Supplement — 2.1E Update

REFG—EVAP—T values.

- REFG—ZONE—DES—RH** is the zone relative humidity at which the case is rated (usually 55% RH) as referenced by REF—ZONE—LOAD. List of three entries (order corresponds to REFG—ZONE—LOAD entries). The range is from 20.0 to 100.0°F and the default is 55°F.
- REFG—DISCHARGE—T** is the temperature of the air inside the cases. List of three entries (order corresponds to REFG—ZONE—LOAD entries). This keyword is required, and can range from -40.0 to 60.0°F.
- Note: A simulation ERROR will occur if the zone temperature is ever allowed to float below the warmest temperature in this list.
- REFG—EVAP—T** is the apparatus dew point temperature. List of three entries (order corresponds to REFG—ZONE—LOAD entries). Values default to the corresponding REFG—DISCHARGE—T - 10.0°F, and the range is from -40.0 to 60.0°F.
- REFG—SENS—SCH** accepts schedules to simulate covers on case work at night and holidays to inhibit loss of cooling effect to the zone. List of three u-names (order corresponds to REFG—ZONE—LOAD entries).
- REFG—LAT—SCH** accepts schedules to simulate covering case work and the effect on moisture condensing inside the cases. List of three u-names (order corresponds to REFG—ZONE—LOAD entries).
- REFG—AUX—KW** is the rated capacity in kW of lights, fans, anti-sweat heaters, or other electrical equipment within the case. List of three entries (order corresponds to REFG—ZONE—LOAD entries). Values default to 0.4 \* the corresponding REFG—ZONE—LOAD / 3413. The range is 0.0 to 100.0 kW for each entry.
- REFG—AUX—HEAT** allows for the entry of non-electrical loads, such as hot water resurfacing of an ice rink. List of three entries (order corresponds to REFG—ZONE—LOAD entries). The default is 0.0 Btu/hr, and can range from 0.0 to 99999999.0.
- REFG—AUX—SCH** accepts schedules for turning off lights, anti-sweat heaters, etc, and applies to both REFG—AUX—KW and REFG—AUX—LOAD. List of three u-names (order corresponds to REFG—ZONE—LOAD entries).

---

In the left column above, bold-faced words are commands, non-bold words are keywords, and italicized words are code-words.

REFG—DEF—MECH	accepts code-words for type of defrost ( <b>RESISTANCE</b> , <b>FREON</b> , <b>TIME—OFF</b> , <b>NO—DEFROST</b> ) for the cases. List of three code-words (order corresponds to <b>REFG—ZONE—LOAD</b> entries).
<i>RESISTANCE</i>	is electric resistance defrost (the default).
<i>FREON</i>	is hot gas defrost.
<i>TIME—OFF</i>	is timer controlled off cycle for frost melt.
<i>NO—DEFROST</i>	is for use with units that never need defrosting, or for ice rinks.
REFG—DEF—EFF	is the efficiency of the defrost mechanism. Based on the humidity ratio in the zone, the program calculates the moisture that condenses on each evaporator. It assumes that all condensation freezes and the energy required to defrost is equal to:  <i>POUNDS FROST * PHASE CHANGE ÷ DEF—EFF.</i>  List of three entries (order corresponds to <b>REFG—ZONE—LOAD</b> entries). Values default to 0.9, unless <b>REFG—DEF—MECH = TIME—OFF</b> , in which case the corresponding value defaults to 1.0.
REFG—DEF—CTRL	is the type of defrost control. Code words are either <b>TIMER</b> (for a timed defrost cycle) or <b>THERMOSTATIC</b> (for a timed start with thermostat controlled off cycle). List of three entries (order corresponds to <b>REFG—ZONE—LOAD</b> entries). The default is <b>THERMOSTATIC</b> .

**SYSTEM**

The **SYSTEM** keyword additions are as follows:

REFG—SIZING—RAT	is a single input to adjust the capacity of all compressors in the system. It is the ratio of compressor size to the total evaporator load (which includes the case work plus lights, anti-sweat heaters, etc.). It defaults to 1.2, and ranges from 0.8 to 2.0.
REFG—COMP—CAP	allows you to enter the installed compressor capacity at each temperature level. List of three entries (order corresponds to <b>REFG—ZONE—LOAD</b> entries of the <b>ZONE</b> input). The range is from 0.0 to 99999999.0 Btu/hr. The default is the refrigeration equipment design load multiplied by <b>REFG—SIZING—RAT</b> .

Note: Manufacturers of supermarket cases nominally rate compressors at a standard suction temperature which is usually *not* the actual suction temperature of the case. The input for this keyword must be the compressor capacity at the actual

---

In the left column above, bold-faced words are commands, non-bold words are keywords, and italicized words are code-words.



suction temperature of the case.

REFG—COMP—EER

allows you to input the compressor unit efficiency at each temperature level. If not input, the program will calculate these values as a linear relationship between a range of 3.5 Btu/W at  $-30^{\circ}\text{F}$  and 7.3 Btu/W at  $25^{\circ}\text{F}$ . The range is from 0.0 to 20.0 Btu/W. List of three entries (order corresponds to REFG—ZONE—LOAD entries of the ZONE input).

REFG—COMP—GROUP

allows you to specify whether the compressors are multiplexed or serve separate refrigeration circuits. The code-words are SEPARATE (the default) and COMMON. For example, if the first (lowest temperature level) is separate, and the remaining two levels multiplexed, then the input must be as follows: REFG—COMP—GROUP = (SEPARATE, COMMON, COMMON). A mistaken input, such as (SEPARATE, COMMON, SEPARATE), will be interpreted as (SEPARATE, SEPARATE, SEPARATE). When separate refrigeration circuits share a COMMON compressor, the compressor must operate at a suction temperature low enough to match the coldest evaporator temperature in the multiplexed circuits. The energy consumption of the compressor is determined as though the total load of the multiplexed circuits occurred at the coldest evaporator temperature.

Multiplexing circuits will affect the input of other keywords pertaining to the compressors. Consider the following input for three circuits:

```
REFG—COMP—GROUP = (COMMON,COMMON,SEPARATE)
REFG—COMP—EER = (3.5, 20.0, 5.7)
```

```
  .
  .
  . ..
```

Because the first two circuits are multiplexed, the program will use the value 3.5 Btu/W in calculating the energy consumption of the compressor serving these two circuits. The value of 20.0 input for the second circuit is ignored. It (or any other legal value) was input simply to mark the second position in the list, so that the value for the third circuit could be input in the third position.

REFG—FAN—KW

is the total value in KW to be assigned to either the fans of air cooled condensers or the fans of cooling towers. The default is 0.105 kW per ton of compressor capacity. The range is from 0.0 to 100.0 kW.

Supplement — 2.1E Update

- REFG—PUMP—KW is the total value in KW to be assigned to the condenser water pumps for cooling towers. The default is 0.025 kW per ton of compressor capacity. The range is from 0.0 to 100.0 kW.
- REFG—MIN—COND—T is the setpoint of a thermostat located in the outside air that modulates condensing capacity of either air cooled condensers or cooling towers to maintain an approximate 10°F higher (than setpoint) condensing temperature. In situations where the condensing temperature is not allowed to “float”, this value should be set 10°F lower than the rated condensing temperature of the equipment. The range is from 50.0 to 110.0°F, and defaults to 60.0°F.
- REFG—COND—TYPE allows you to input a code-word for either WATER (the default) for cooling towers or AIR for air cooled condensers. It is assumed that all condensing is of one type.
- REFG—MAX—HTREC is the input value of total BTUH of all recoverable heat. The range is from 0.0 to 99999999.0 Btu/hr, and the default is that all compressor heat is recoverable.
- REFG—HTREC—UNITS accepts the code-word of either YES (the default) or NO, which allows you to specify which compressors operating at different evaporator temperature levels are available for heat recovery. List of three entries (order corresponds to REFG—ZONE—LOAD entries of the ZONE input).
- REFG—HTREC—GROUP accepts the entry of a single code-word of either SEPARATE or COMMON (the default).
- SEPARATE* Using SEPARATE, DOE-2 simulates the compressors operating at the highest evaporator temperature level as the first units to switch to the heat recovery mode, and thus forced to operate at a higher condensing temperature, given by REFG—HTREC—T.
- COMMON* Using COMMON, DOE-2 simulates all compressors specified as being available for heat recovery as being switched to the heat recovery mode and the higher condensing temperature whenever the space temperature requires heating.
- REFG—HTREC—T is the input value of the condensing setpoint during the heat recovery mode. The default is 90°F, and can range from 80.0 to 120.0°F.
- REFG—FAN—T is the low limit setpoint at which the cooling tower fans or air cooled condenser fans shut off. The default is 30°F, and can range from 0.0 to 100.0°F.

SYSTEM-EQUIPMENT

Four curves were added to the SYSTEM-EQUIPMENT command in DOE-2.1B.

REFG-KW-FTCOND

accepts the u-names of the curves you input to replace default curves of KW as a function of condensing temperature. List of three entries (order corresponds to REFG-ZONE-LOAD entries of the ZONE input). The default coefficients are 0.713536, -0.004959, 0.0000980.

REFG-KW-FPLR

accepts the u-names of the curves you input to replace default curves of KW as a function of part load ratio of the compressors. List of three entries (order corresponds to REFG-ZONE-LOAD entries of the ZONE input). The default coefficients are 0.03829, 1.077839, -0.116129.

TWR-RFACT-FRT

accepts a u-name of a curve you input that replaces the default curve. (See description of this same keyword in PLANT in the *Reference Manual (2.1A)*.) The default coefficients are 1.484326, 0.129479, -0.004014, -0.054336, 0.0003120, -0.000147.

TWR-APP-FRFACT

accepts a u-name of a curve you input that replaces the default curve. (See description of this same keyword in PLANT in the *Reference Manual (2.1A)*.) The default coefficients are 4.981467, -6.761789, 24.709033, 0.114499, -0.000612, -0.250651.

Supplement — 2.1E Update

**Example:**

Consider a supermarket which has three sets of cases: 1) frozen foods, 2) meat, dairy, and deli, and 3) produce. There are two sets of compressors, one set for the frozen foods and one set for the rest. Only the compressor set serving the meat, dairy, deli, and produce cases is available for heat recovery. All of the cases are covered at night.

\$ SUPERMARKET CASE SCHEDULES \$

```

FOOD—SENS—SCH   =   SCHEDULE THRU DEC 31 (ALL)
                    (1,9) (0.4)
                    (10,21) (1.0)
                    (22,24) (0.4)
                    $ COVER CUTS SENSIBLE BY 60%$
                    $ UNCOVERED $
                    $ COVERED AGAIN $ ..

FOOD—LAT—SCH     =   SCHEDULE THRU DEC 31 (ALL)
                    (1,9) (0.7)
                    (10,21) (1.0)
                    (22,24) (0.7) ..
                    $ COVER CUTS LATENT BY 30% $

FOOD—AUX—SCH     =   SCHEDULE THRU DEC 31 (ALL)
                    (1,9) (0.2)
                    (10,21) (1.0)
                    (22,24) (0.2)
                    $ AT NIGHT ONLY CASE FANS
                    $ AND SWEAT HEATERS RUN.
                    $ LIGHTS TURNED OFF.$ ..

.
.
.

MARKET            =   ZONE ZONE—TYPE = CONDITIONED
                    .
                    .
                    .

REFG—ZONE—LOAD = (-70000., -100000., -40000.)
                    $ FROZEN FOOD, MEAT/DAIRY/DELI, AND
                    $ PRODUCE INPUT AS NEGATIVE BECAUSE
                    $ THIS IS THE EFFECT ON THE ZONE.

REFG—ZONE—SHR = (0.9, 0.8, 0.9)
                    $ THE MEAT/DAIRY/DELI CASE SET IS MULTI—SHELF
                    $ AND INCURS A LARGER LATENT LOAD.

REFG—DISCHARGE—T = (-10.0, 35.0, 45.0)
                    $ ORDER OF ALL LISTS IS COLDEST TO WARMEST.

REFG—EVAP—T = (-25.0, 25.0, 36.0)

REFG—SENS—SCH = (FOOD—SENS—SCH,
                  FOOD—SENS—SCH,
                  FOOD—SENS—SCH)
                  $ SCHEDULES COULD BE DIFFERENT.

REFG—LAT—SCH = (FOOD—LAT—SCH, FOOD—LAT—SCH,
                 FOOD—LAT—SCH)

REFG—AUX—KW = (2.0, 8.0, 1.0)

REFG—AUX—SCH = (FOOD—AUX—SCH, FOOD—AUX—SCH,

```

Supplement - 2.1E Update

FOOD--AUX--SCH)

REFG--DEF--MECH = (RESISTANCE, FREON, NO--DEFROST)

\$ NOTE THAT THIS INPUT FOR PRODUCE CASE IS  
\$ IRRELEVANT; SINCE EVAP--T IS ABOVE FREEZING,  
\$ NO DEFROST WILL OCCUR REGARDLESS.

REFG--DEF--EFF = (0.95, 0.85)

\$ THE HEAT THAT DOESNT MELT ICE WILL BECOME A  
\$ COMPRESSOR LOAD. VALUE FOR PRODUCE NOT INPUT  
\$ BECAUSE NOT NEEDED.

REFG--DEF--CTRL (THERMOSTATIC, TIMER) ..

.  
.  
.

MARKET--SYS = SYSTEM SYSTEM--TYPE = PSZ

.  
.  
.

REFG--SIZING--RAT = 1.3

\$ WANT EXTRA SAFETY FOR FROZEN FOOD CIRCUIT.

REFG--COMP--GROUP = (SEPARATE, COMMON, COMMON)

\$ MEAT/DAIRY/DELI CIRCUIT SHARES  
\$ COMPRESSORS WITH PRODUCE CIRCUIT

REFG--MAX--HTREC = 90000.

\$ HEAT RECOVERY COIL SIZED TO 90000 BTU

REFG--HTREC--UNITS = (NO, YES)

\$ NO HEAT RECOVERY FROM FROZEN FOOD CASE;  
\$ ONLY TWO VALUES INPUT BECAUSE THIRD SET  
\$ SHARES COMPRESSORS WITH THE SECOND.\$ ..

## Supplement – 2.1E Update

### Reporting

A SUMMARY report, REFG, was added in DOE-2.1C for refrigerated case work, and the SV-A report was expanded to print verification values for case work energies at design temperatures, compressor efficiencies, and condenser energies. The REFG report and the expanded SV-A will automatically be printed whenever REFG-type keywords have been specified in system type PSZ (see Appendix C).

In addition, seven hourly report variables (82 through 88) have been added to SYSTEMS, VARIABLE-TYPE = u-name of SYSTEM. See Appendix A, "Hourly Report Variable List", for a description.

## NIGHT VENTILATION

Several keywords allow the simulation of night-time ventilation cooling using outside air and an alternative set of fans which run when the FAN-SCHEDULE is off. The keyword NIGHT-VENT-CTRL in the SYSTEM or SYSTEM-FANS command has five legal code-words which define the operation of fans when the FAN-SCHEDULE is off (and the NIGHT-CYCLE-CTRL has not caused the fans to cycle on). You should consult the new SS-K report for assistance in determining the potential for night ventilation (see Appendix C). The NIGHT-VENT-CTRL code-words are as follows:

SYSTEM or SYSTEM-FANS

## NIGHT-VENT-CTRL

*NOT-AVAILABLE*

(the default) means that, when the FAN-SCHEDULE is off, no other fans can be on.

*NIGHT-FAN*

means that, when the main fans are scheduled off, the night fans always run to pressurize, for instance, a fabric roof system. One can also think of this as the main fans running but at a reduced volume.

*NIGHT-FAN+REVERT*

means that, when the main fans are scheduled off, the night fans run unless any zone falls below its heating throttling range or rises above its cooling throttling range, in which case the main fans are turned on that hour.

*WHEN-SCHEDULED*

means that, when the main fans are scheduled off, the night ventilation fans will turn on if the NIGHT-VENT-SCH is on and the outside drybulb temperature is at least NIGHT-VENT-DT degrees below the temperature in the first zone specified in the ZONE-NAMES list.

*SCHEDULED+DEMAND*

is the same as WHEN-SCHEDULED except that, in addition, at least one conditioned zone in the ZONE-NAMES list must be above the VENT-TEMP-SCH value.

The following keywords supply the additional information for simulating the night fans and night ventilation options:

NIGHT-VENT-SCH

is a required entry in the SYSTEM or SYSTEM-FANS command, when NIGHT-VENT-CTRL is equal to WHEN-SCHEDULED or SCHEDULED+DEMAND. It is the u-name of a schedule that defines the hours when the night ventilation fans are allowed to run, if the main fans are scheduled off. A zero or non-zero value is used to specify that the night ventilation fans are either not allowed or allowed, respectively, to turn on.

---

In the left column above, bold-faced words are commands, non-bold words are keywords, and italicized words are code-words.

## NIGHT-VENT-DT

in the SYSTEM or SYSTEM-FANS command, is the minimum number of degrees that the outside drybulb temperature must be below the inside temperature for the night ventilation fans to operate. This inside temperature is that of the first zone specified in the ZONE-NAMES list. The value is usually set equal to at least the temperature rise across the ventilation fans plus a couple of degrees to ensure that a reasonable cooling capacity is available before ventilation cooling is used. The default is 5°F.

## NIGHT-VENT-RATIOS

is a required entry in the SYSTEM or SYSTEM-FANS command when NIGHT-VENT-CTRL is not equal to NOT-AVAILABLE. It is a list of six values that are ratios of night fan parameters to the normal operating fan parameters. The first three values define the ratios of flowrate, kW per unit flowrate, and fan temperature rise of the night supply fans to the normal supply fans. The last three values define the same three ratios of the night return fans to the normal return fans.

$$Q_N, \text{ night fan flowrate} = \text{SUPPLY-CFM} * \text{NIGHT-FAN-RATIOS}(1)$$

$$P_N, \text{ night fan power/flowrate} = \text{SUPPLY-KW} * \text{NIGHT-FAN-RATIOS}(2)$$

$$DT_N, \text{ night fan temperature rise} = \text{SUPPLY-DELTA-T} * \text{NIGHT-FAN-RATIOS}(3)$$

where  $Q_N * P_N =$  night supply fan total energy use

Similar relationships are true for the return fans during night operation. If no return fans are used during the night operation, the last three values of NIGHT-FAN-RATIOS should be set equal to zero. The ratios of power/flowrate and temperature rise are usually similar and larger than the flowrate ratio (this is especially true if the night and day fans are the same fans operated under different control or pressure conditions). If the night and normal fans are, in fact, the same set to run in the identical manner, all six values should be set to 1.0.

## VENT-TEMP-SCH

in the SYSTEM or SYSTEM-AIR command, is the u-name of a schedule used to define the setpoint for forced or natural ventilation. *Natural* ventilation is appropriate to the RESYS system only. The hourly values specified in the referenced SCHEDULE are the indoor drybulb temperatures to which the zone is to be cooled by natural ventilation in lieu of mechanical cooling. For forced ventilation, this value is used when NIGHT-VENT-CTRL is equal to SCHEDULED+DEMAND. The night ventilation fan, in this case, will operate only if any conditioned zone specified in the ZONE-NAMES list is above this value. If this keyword is not defined, the top of the zone's heating throttling range (defined by value of HEAT-TEMP-SCH plus  $0.5 * \text{THROTTLING-RANGE}$ ) is used.



## Supplement — 2.1E Update

### Report Modification

Report SS—C now reports out the number of hours of night venting. This report has been enhanced in other ways as well; it now also reports the number of hours the terminal unit is operating in the dead-band (HOURS FLOATING), the number of hours of heating and cooling available, number of hours the fans are on, fans cycling on, and number of hours the terminal unit is operating in the dead-band when the fans are on (HOURS FLOATING WHEN FANS ON).

Note: NIGHT—CYCLE—CTRL now also cycles fans on when the temperature goes above the COOL—TEMP—SCH's throttling range.

## BASEBOARD HEATING IN PLENUMS

Several zone level keywords were activated in DOE-2.1B for PLENUM type zones. The use of these keywords allows "baseboards" to be placed in plenums. This allows the simulation of outside or space temperature controlled heaters in the return air space. The allowed keywords are:

HEAT-TEMP-SCH	to define the thermostat setpoint for the plenum heater when it is THERMOSTATICally controlled.
BASEBOARD-RATING	to define the size of the heating unit.
BASEBOARD-CTRL	to define the control method as THERMOSTATIC using HEAT-TEMP-SCH as the setpoints, or OUTDOOR-RESET to allow BASEBOARD-SCH reset control.
THROTTLING-RANGE	to define the throttling range around HEAT-TEMP-SCH.

The plenum heater is activated based on outside air temperature and reset schedule when it is outside controlled. When it is space temperature controlled, and if the interaction with the return air does not result in a temperature above the scheduled value, the heater is turned on. In both cases, the source of energy input to the heater is defined by the specified or defaulted value for BASEBOARD-SOURCE.

## ENHANCED MOISTURE BALANCE CALCULATION

The desiccant units have excellent moisture removal characteristics and are especially suited to make-up air systems for hotel and apartment buildings. The keyword OA—FROM—SYSTEM was introduced primarily to address the differences in moisture control between standard make-up air systems and those employing desiccant units. It simulates the transfer of air from a corridor make-up air system (in a hotel or apartment building, for example) to adjacent rooms that are on another system. This allows return air from one system to be used as a replacement for the outside air in another system. This feature was added to enable DOE-2 to address the advantage of desiccant systems (which supply a lower moisture content in make-up air) over conventional systems. The keyword may also be used between two conventional systems if desired. For an example, see "Medical Building" in the *Sample Run Book (2.1E)*.

### SYSTEM

#### OA—FROM—SYSTEM

accepts the u-name of the system that supplies make-up air either directly, or through the corridor, to apartments or hotel rooms.

You must insure that minimum outside air of a make-up air system assigned to the corridor matches the sum of the minimum outside air flow rate of the apartments or hotel rooms.

In the input, you must define the make-up air system prior to the apartment or hotel room system. An option is to use a PLANT—ASSIGNMENT instruction with the make-up air system placed directly ahead of the apartment or hotel room air system in the list of SYSTEM—NAMES.

## VARIOUS CONTROL ENHANCEMENTS

A keyword was added in 2.1B to define the source of heat used to provide humidification in those SYSTEM-TYPEs that allow MIN-HUMIDITY to be specified. Note that humidification has been added to the HVSYS system.

**HUMIDIFIER-TYPE** in the SYSTEM command, is given one of the standard heat source code-word values: HOT-WATER, ELECTRIC, GAS-FURNACE, or OIL-FURNACE. The gas and oil furnace sources should be used with caution since the same HIR and part load functions are used as for other furnaces specified in the same system. The defaults for HUMIDIFIER-TYPEs are the same as those for BASEBOARD-TYPE.

**MAX-HUMIDITY** in the SYSTEM or SYSTEM-CONTROL command causes the simulation to function differently for system types SZRH, PSZ, and PVAVS than previously described. For SZRH, if the MAX-HUMIDITY level is exceeded, the system reverts to a full reheat. The cooling coil leaving air temperature is driven lower and reheat is added at the fan unit to satisfy the first-named zone. Further, for PSZ and PVAVS systems, specification of MAX-COND-RCVRY will activate the use of condenser recovery to accomplish a similar result.

A keyword was added in 2.1B to the SYSTEM and SYSTEM-CONTROL commands that adds an additional control to the outside air economizer cycle.

**ECONO-LOW-LIMIT** defines the outdoor drybulb temperature *below* which the outside dampers are returned to their minimum position (see Fig. 3.24). This is analogous to the ECONO-LIMIT-T, except that it is a low limit rather than a high limit. The range is from 0.0 to °F, and the abbreviation is E-L-L.

Note that Fig. 3.24 assumes some relative values for outside drybulb and return air drybulb temperatures. The purpose of this keyword is to allow you to simulate the loading of an evaporator on a double bundle chiller (DBUN-CHLR) to satisfy the heating load. The value input for ECONO-LOW-LIMIT is the outside air temperature at which the outside air economizer damper is forced to a minimum position. This, in effect, increases the load on the evaporator and the additional heat rejected is available to satisfy the heating load. The economizer is only active between the outside temperature specified for ECONO-LOW-LIMIT and ECONO-LIMIT-T as seen in Fig. 3.24.

Another use of the ECONO-LOW-LIMIT keyword is to simulate the closing (to minimum position) of outside air dampers when humidification is required. There would be no direct tie to the humidifier controller as ECONO-LOW-LIMIT is only based on drybulb temperatures. However, you could address the savings of humidifying minimum versus maximum outside air quantities.

SRG-92-24

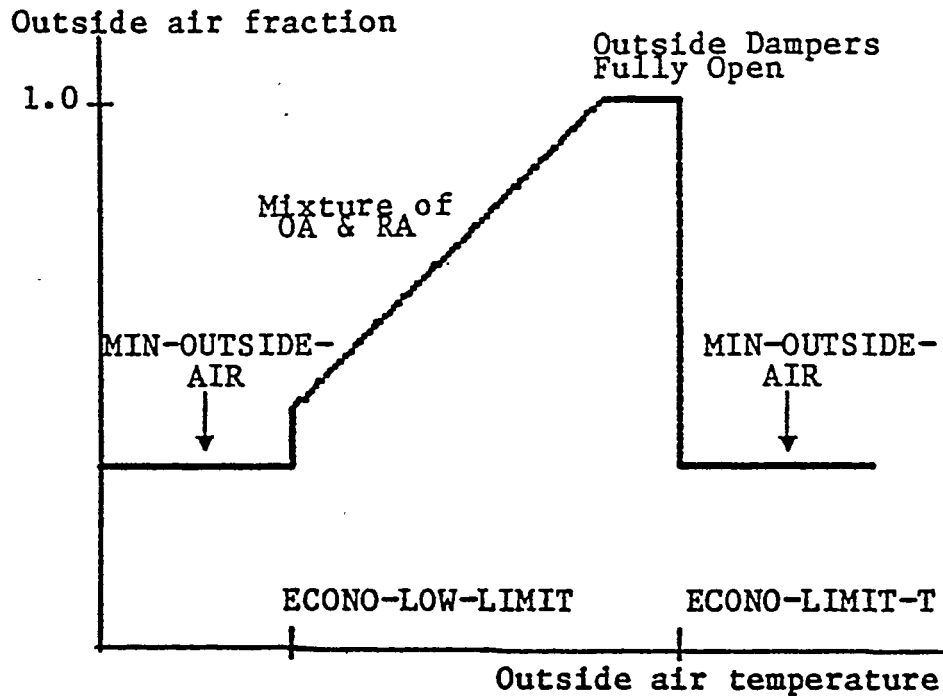

Figure 3.24: Outside Air Control Action

Control of Air Flow Rate to Zones

CFM/SQFT  
and  
AIR-CHANGES/HR

under the ZONE-AIR command took on new meanings in 2.1B. In previous versions of the program, these two keywords always overrode the calculated zone CFM's and set them to satisfy these criteria. They now allow you to set a minimum air flow rate to the zone, and only override the calculated value when the latter is less than the minimum criteria. The keyword ASSIGNED-CFM is now the only method you have to set a value at the ZONE level.

## SUPPLY—CFM

in the SYSTEM—AIR command has not been changed in meaning; however, the method of proportioning the specified total supply air into zone air quantities has been made more exact in the following manner.

Adjusted Zone Air CFM =

$$\left( \frac{\langle \text{SUPPLY—CFM} \rangle}{\sum \text{Calculated Zone Air CFMs}} \right) * (\text{Calculated Zone Air})$$

Note that your inputs of ZONE-level ASSIGNED—CFM and EXHAUST—CFM replace the other “Calculated Zone Air CFMs” in the summation (but only when the latter exceeds calculated zone CFM).

When you allow the program to calculate MIN—CFM—RATIO (rather than input it), the values for Minimum Flow Ratio (see SV—A Report) are corrected relative to the values of “Adjusted Zone Air CFM”, taking into account the specified outside/exhaust air or the peak heating load. Likewise, your input of MIN—OUTSIDE—AIR would result in new quantities of Outside Air Flow (see SV—A report) as these values would be simply the ratio of the the zone flowrate and the SUPPLY—CFM value times the MIN—OUTSIDE—AIR value.

## MIN-CFM-SCH AND OTHER SCHEDULE USES

A schedule keyword was added in DOE-2.1B to allow an hourly variation of the MIN-CFM-RATIO.

## MIN-CFM-SCH

in the ZONE command, is the u-name of a schedule which has values that are to be used *in place of* the MIN-CFM-RATIO keyword to allow an hourly variation of MIN-CFM-RATIO (see *Reference Manual (2.1A)*, p.IV.200). This schedule will always override the value specified or calculated for MIN-CFM-RATIO, unless the scheduled value is equal to -999.0 for an hour. When the value is equal to -999.0, then the calculated or specified value of MIN-CFM-RATIO (found on report SV-A for each zone) is used for that hour. This schedule can be used with a value of 1.0 during warmup periods and -999.0 for other hours to simulate full open VAV boxes during a warmup cycle.

## MIN-AIR-SCH

The MIN-AIR-SCH keyword in the SYSTEM or SYSTEM-AIR command defines the hourly value of the ratio of minimum outside air flow to supply air flow. Values in the MIN-AIR-SCH vary from 0 (no outside air flow; economizer inactive if specified) to 1 (100% outside air flow). However, a value of -999.0 is also allowed; in this case the calculated or specified value for MIN-OUTSIDE-AIR (found on report SV-A for the SYSTEM or for each zone for zonal systems) is used as the minimum outside air ratio for the current hour. During a warmup period, this schedule is normally set to zero and can then be set to -999.0 during other hours to allow the specified or calculated ventilation minimum damper position to be used.

HEATING-SCHEDULE  
COOLING-SCHEDULE

The HEATING-SCHEDULE and COOLING-SCHEDULE in the SYSTEM or SYSTEM-CONTROL commands are equal to the schedules whose values define the availability of active heating and cooling, respectively. A zero value for one of these schedules means that heating or cooling is not available except through ventilation. A non-zero value indicates that mechanical heating or cooling is available. Additionally, if either of the schedules has a value greater than 1.0, a special meaning is inferred. If the HEATING-SCHEDULE is set to a value greater than 1.0, heating is available only if the outside drybulb temperature is less than or equal to the specified value. In a similar manner, if the COOLING-SCHEDULE is set to a value greater than 1.0, cooling is available only if the outside drybulb temperature is greater than or equal to the specified value.

## ENHANCEMENTS TO THE RESIDENTIAL NATURAL VENTILATION ALGORITHM

### Discussion

In DOE-2.1D significant additions have been made to the capabilities of the natural ventilation model in the residential system (SYSTEM-TYPE = RESYS) simulation in SYSTEMS. The capabilities previous to 2.1D are described in the *Reference Manual (2.1A)* pp.IV.217-19. Basically, you have considerable control over when venting occurred (i.e., when the windows were opened or closed) through the keywords NATURAL-VENT-SCH and VENT-TEMP-SCH in the SYSTEM-AIR command, but were forced to estimate (or guess) the air changes due to natural ventilation (keyword NATURAL-VENT-AC) when the windows were open. DOE-2.1D increased your ability to control when venting occurred; more importantly, it added the capability to estimate the amount of venting that takes place when the windows were opened.

The model used to calculate the amount of natural ventilation is identical to one of DOE-2's infiltration models — the Sherman-Grimsrud (S-G) model. The input needed for S-G infiltration is described on p.2.86 of this Supplement. The S-G natural ventilation model uses many of the same keywords; in particular the keywords NEUTRAL-LEVEL (in the SPACE or SPACE-CONDITIONS commands in LOADS) and SHIELDING-COEF, TERRAIN-PAR1, TERRAIN-PAR2, WS-TERRAIN-PAR1, WS-TERRAIN-PAR2, and WS-HEIGHT (in the BUILDING-LOCATION command in LOADS) are identical. That is, they are used by both the S-G infiltration model and by the S-G natural ventilation model. A description and discussion of these keywords should be obtained from the aforementioned section of this Supplement.

There are a number of new keywords in SYSTEMS relevant to the new natural ventilation capabilities. They are:

Keyword	Abbr	Type	Units	Default	Min.	Max.
VENT-METHOD	V-M	code-word		AIR-CHANGE		
MAX-VENT-RATE	M-V-R	numeric	air changes/hr	20.	0.0	100.
HOR-VENT-FRAC	H-V-F	numeric	fraction	0.0	0.0	1.0
FRAC-VENT-AREA	F-V-A	numeric	fraction	0.05	0.0	1.0
OPEN-VENT-SCH	O-V-SCH	schedule		none		

All of the above keywords occur in the SYSTEM-AIR or SYSTEM command.

VENT-METHOD is used to select the ventilation model. VENT-METHOD=AIR-CHANGE selects the old natural ventilation model — you must specify the ventilation air changes per hour by using the keyword NATURAL-VENT-AC. This sets a fixed air change rate which is used whenever the windows are open. VENT-METHOD=S-G selects the new natural ventilation model. In this case the new keywords MAX-VENT-RATE, HOR-VENT-FRAC, and FRAC-VENT-AREA are applicable. FRAC-VENT-AREA is analogous to FRAC-LEAK-AREA used in the S-G infiltration model. It should be set to 0.6 times the open



window area divided by the floor area. You might very well want to change the default of .05, depending on the situation being modeled. HOR-VENT-FRAC corresponds to HOR-LEAK-FRAC in the S-G infiltration model. It is the fraction of the venting area that is in the floor and ceiling; it is used to calculate the stack effect contribution to the ventilation. Unless there are openable skylights or clerestory windows or an open fireplace flue, this keyword can be allowed to default to zero. MAX-VENT-RATE sets a maximum on the ventilation air-changes. For high wind speeds, the S-G model can give unrealistically large ventilation rates. MAX-VENT-RATE eliminates this problem.

OPEN-VENT-SCH can be used for either VENT-METHOD=AIR-CHANGE or VENT-METHOD=S-G. It gives you more control over when the windows are opened. OPEN-VENT-SCH references a schedule whose hourly values are probabilities that the windows will be opened that hour, given that the conditions set by NATURAL-VENT-SCH and VENT-TEMP-SCH are met, and given that the windows were not already open. Previously it was always assumed that the windows would be opened if the conditions set by NATURAL-VENT-SCH and VENT-TEMP-SCH were met. For example you can now set a low probability that the windows will be opened when the occupants would normally be asleep, and a high probability that they will be opened when the occupants arise in the morning.

The following table summarizes the two possible natural ventilation algorithms that can be used with SYSTEM-TYPE=RESYS.

VENT-METHOD=AIR-CHANGE			
Applicable Keywords	Program	Command	New to DOE2.1D?
NATURAL-VENT-SCH	SYSTEMS	SYSTEM or SYSTEM-AIR	no
VENT-TEMP-SCH	SYSTEMS	SYSTEM or SYSTEM-AIR	no
NATURAL-VENT-AC	SYSTEMS	SYSTEM or SYSTEM-AIR	no
OPEN-VENT-SCH	SYSTEMS	SYSTEM or SYSTEM-AIR	yes
VENT-METHOD=S-G			
Applicable Keywords	Program	Command	New to DOE2.1D?
NATURAL-VENT-SCH	SYSTEMS	SYSTEM or SYSTEM-AIR	no
VENT-TEMP-SCH	SYSTEMS	SYSTEM or SYSTEM-AIR	no
OPEN-VENT-SCH	SYSTEMS	SYSTEM or SYSTEM-AIR	yes
FRAC-VENT-AREA	SYSTEMS	SYSTEM or SYSTEM-AIR	yes
HOR-VENT-FRAC	SYSTEMS	SYSTEM or SYSTEM-AIR	yes
MAX-VENT-RATE	SYSTEMS	SYSTEM or SYSTEM-AIR	yes
NEUTRAL-LEVEL	LOADS	SPACE or SPACE-CONDITIONS	no
SHIELDING-COEF	LOADS	BUILDING-LOCATION	no
TERRAIN-PAR1	LOADS	BUILDING-LOCATION	no
TERRAIN-PAR2	LOADS	BUILDING-LOCATION	no
WS-TERRAIN-PAR1	LOADS	BUILDING-LOCATION	no
WS-TERRAIN-PAR2	LOADS	BUILDING-LOCATION	no
WS-HEIGHT	LOADS	BUILDING-LOCATION	no

## DESIGN-DAY ROUTINES

### Introduction

The design-day option, which is specified by entering DESIGN-DAY instructions in the LOADS input, allows you to override the weather file data for sizing of SYSTEMS and PLANT. In this section we discuss effective use of the design-day feature and introduce some design-day capabilities that are new in DOE-2.1E.

There are several reasons for using DESIGN-DAY information rather than relying on the summer and winter extremes found on the weather tape:

- 1) The weather tape may have extremes that are not typical.
- 2) Building codes may require that ASHRAE data be used for design calculations.
- 3) You may want to explore the effect of several extreme days in a row, such as a long hot spell.
- 4) You may want to determine the difference between automatic sizing of plant equipment based on design-day data vs. weather tape data. This can be done with the new PLANT-PARAMETERS keyword PLANT-SIZING-BY, which allows you to switch from the design-day run to weather tape run.

The design-day option requires that you enter design-day weather information in the DESIGN-DAY instruction in LOADS. One source for this information is the *1998 ASHRAE Handbook of Fundamentals*, Chapter 24, "Climatic Conditions" tables.\*

Associated with each DESIGN-DAY instruction is one RUN-PERIOD interval. DOE-2 uses transient calculations to account for the storage of energy in the thermal mass of the structure by iteratively calculating the first day of each RUN-PERIOD with the last iteration's result used as the starting point of the RUN-PERIOD. The DESIGN-DAY data apply to every day in the RUN-PERIOD interval; it is extremely important that the RUN-PERIOD(s) not be limited to one day, especially if that one day should fall on a weekend or holiday. We strongly advise that the RUN-PERIOD span a weekend and include a Monday so that the Monday morning start-up load is not missed in the DESIGN-DAY peaks. There must be a RUN-PERIOD representing the summer peak and one for the winter peak; otherwise, the missed period will cause the program to fail in the sizing of equipment for that period.

The input for a RUN-PERIOD must be coordinated with the sequencing of input of DESIGN-DAY data. The first RUN-PERIOD in the sequence will automatically correspond to the first set of DESIGN-DAY data, the second RUN-PERIOD will correspond to the second set of DESIGN-DAY data, etc. If, by mistake, the RUN-PERIOD spans a set of days in January, but the DESIGN-DAY data is for summer weather, the program will calculate a cooling peak in January with incorrect solar time and azimuth. Any number of RUN-PERIODs in excess of the number of sets of DESIGN-DAY data are treated by the program as weather tape runs.

---

\* Table 1 lists "Climatic Conditions for the United States" (p.24.4-15),

Table 2 lists "Climatic Conditions for Canada" (p.24.16-17), and

Table 3 lists "Climatic Conditions for Other Countries" (p.24.18-22).

The *1998 ASHRAE Handbook of Fundamentals* is available from ASHRAE, 1791 Tullie Circle N.E., Atlanta, GA 30329.

The reason that the program allows three DESIGN-DAY periods is not readily apparent. As explained above, two are required, but the third is meant to be used to explore the possibility that an even higher peak cooling load might occur in late fall, due, for example, to a large expanse of glass on a southern exposure combined with low sun angle, typical of high latitudes in the northern hemisphere.

The DESIGN-DAY feature of the program has been enhanced by adding a new report, SS-J (DESIGN-DAY), and a keyword that allows you to change the auto-sizing of the PLANT-EQUIPMENT reported in PV-A to be a result of the weather tape run rather than the design day run. Also, there are two keywords that allow you to modify the cooling coil and heating coil sizing independently from that resulting from SIZING-RATIO. These keywords are COOL-SIZING-RATIO and HEAT-SIZING-RATIO, and they act as multipliers on the cooling and heating coil capacities reported on SV-A. They also act as multipliers on the compressor and furnace capacities of packaged units.

You should interpret the cooling coil capacities in System Design Parameters report (SV-A) as ARI-rated capacities. For packaged units, the coil sizes are treated by the program as the compressor and furnace capacities. This differs from the sizing of chillers and boilers in PLANT, because only after a SYSTEMS run has been made are the peak hourly cooling load, the peak daily integrated load, and the maximum peak heating load (which are displayed on the SS-J report) passed to PLANT for automatic sizing of plant equipment.

In PLANT, the PLANT-PARAMETERS keyword PLANT-SIZING-BY accepts code-words DD-IF-PRESENT and WEATHER which determine whether the DESIGN-DAY SYSTEMS run or the weather tape system run is to be used for plant sizing. The program defaults to DD-IF-PRESENT and will thus use DESIGN-DAYS for plant sizing whenever they are entered in LOADS, and, if not, will do weather-tape sizing. The purpose of this keyword is to allow you to size SYSTEMS based on DESIGN-DAY, but have the PLANT size based on the weather tape. The flow diagram, Fig. 3.25, shows the different sizing paths.

It should be noted that the air-side economizer is unlikely to be simulated as being open in the DESIGN-DAY run; however, it may be simulated as being open in the weather tape run. This can occur when OA-CONTROL = TEMP combines with a high DRYBULB-LIMIT, causing the peak cooling to occur while drawing in air laden with moisture and with the outside air dampers open. The peak loads reported on SS-J for these two situations may differ by a large amount; therefore, the sizing of PLANT-EQUIPMENT will also differ.

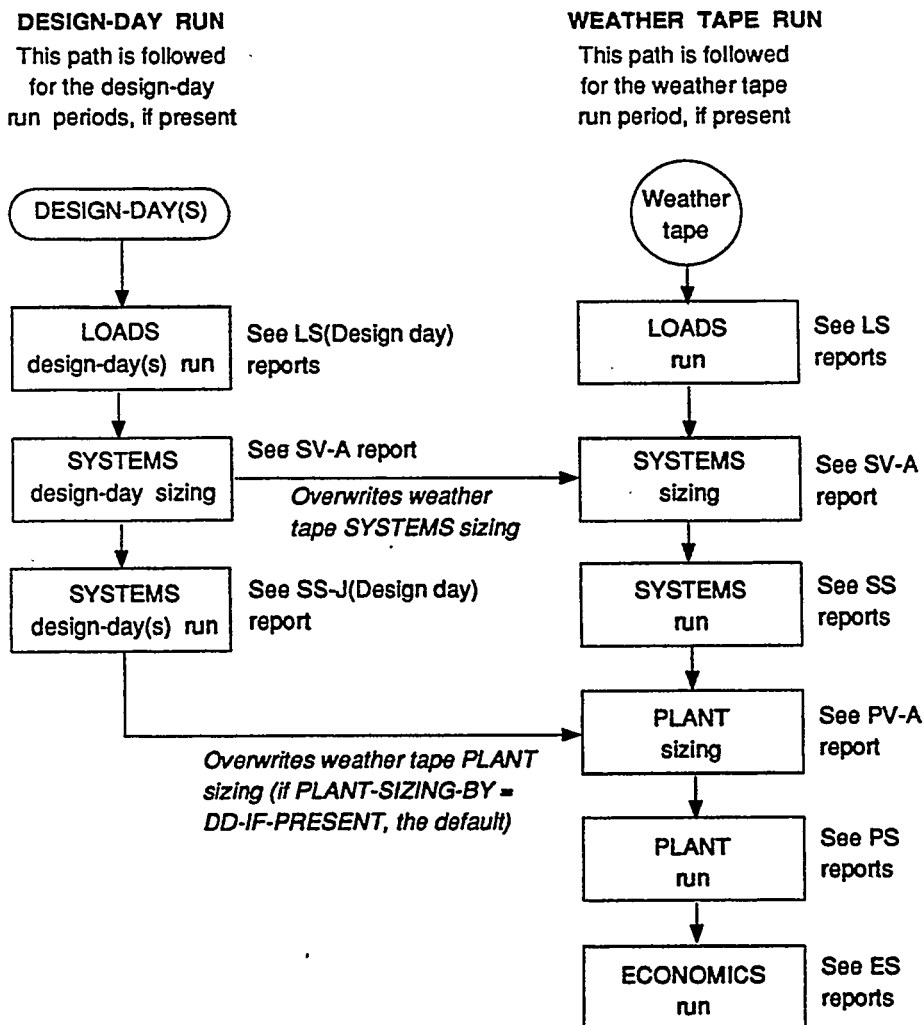

Figure 3.25: DESIGN-DAY and weather tape paths for SYSTEMS and PLANT sizing.

### Investigating Design Alternatives Using DESIGN-DAY

We offer the following suggestions for investigating design alternatives that are most effectively evaluated using DESIGN-DAYS (and thereby controlling the weather conditions over a selected period of time) rather than using weather tapes:

- 1) **MONDAY MORNING START-UP**  
Prepare the RUN-PERIOD so that it spans a weekend.
- 2) **START-UP FOLLOWING A HOLIDAY**  
Prepare the RUN-PERIOD so that it spans a weekend plus a holiday. It may be necessary to change the run period so that one of the holidays falls on a Friday.
- 3) **MITIGATE MONDAY MORNING START-UP**  
Prepare the FAN-SCHEDULE so that the fan and systems operate to reduce the peak load, which in turn reduces the number of hours of "loads not met" to an acceptable level. This

is a trade-off between comfort and initial costs. The SS-J report indicates with asterisks the hours on the peak days when "loads are not met".

— CONVENTIONAL SYSTEMS:

Start early on Monday morning.

— TES SYSTEMS

Start and run for three to five hours on Sunday and holiday evenings with time for the storage to be replenished that night.

4) ESTIMATE BUILDING RESIDUAL HEAT

Prepare the RUN—PERIOD so that it spans from one to five working days. As more days are included, the peak increases because of the residual heat (primarily from lighting) carried from one day into the next. This effect is further aggravated during a series of hot days since the residual heat is less easily dissipated at night by convection and by radiation to the night sky.

5) A SERIES OF HOT DAYS

Prepare the RUN—PERIOD so that it spans a full week. Because hot summer weather is often accompanied by temperature inversions (smog), high nighttime temperatures, and very little wind, we suggest that  $DRYBULB-LOW = (DRYBULB-HI) - 10^{\circ}F$ ,  $WIND-SPEED = 0.0$ , and  $CLEARNESS = 8$  in the DESIGN—DAY input.

6) HEAT ISLAND EFFECT

Prepare the DESIGN—DAY as described in (3) but add 5 to 10 degrees to the DRYBULB—HI value.

7) ACTIVATE ECONOMIZER DURING DESIGN

Input PLANT—SIZING—BY = WEATHER, which forces the plant sizing to be a result of the weather tape run rather than the DESIGN—DAY run. The rationale for this is that since the DESIGN—DAY run is made with the outside air damper set to minimum position, the peak may be missed.

8) ADJUST PACKAGED UNIT SIZE

Input SIZING—RATIO to increase or decrease air system capacity, but input COOL—SIZING—RATIO or HEAT—SIZING—RATIO to readjust capacities of compressor(s) or furnaces(s), respectively. Sizes are displayed on the SV-A report.

9) SIMULATE EQUIPMENT OUTAGE

For buildings that have seven-day operation, a Monday morning start-up is never experienced; however, an outage is almost certain. The time and additional capacity needed to bring the building to comfort conditions after an outage may be determined by scheduling the system fans off for four to six hours on the cooling and heating peak days.

10) NIGHT SETBACK or SETUP

Care must be taken with Thermal Energy Storage systems to set NIGHT—CYCLE—CTRL = STAY—OFF in all weather tape runs. This will avoid a false reading of the Monday morning start-up during the periods when the heating or cooling plant is charging the storage, and is not available to meet any system load. For a similar reason, optimum fan start should not be scheduled during periods of charging the thermal storage.

## IMPROVEMENTS TO THE COOLING COIL MODEL

Keywords have been added to allow better modeling of moisture removal performance for various configurations of chilled water and DX cooling coils and their controls. The new keywords allow different coil part load control such as "wild coils" with face and bypass dampers, different types of chilled water valves and their controls, and multiple series or parallel coil circuits to be modeled based on performance data supplied by you. The effect of chilled water reset on coil latent performance (in SYSTEMS only) can also be simulated.

## COIL-BF-FPLR

This curve applies to PSZ,PVAVS,PMZS,PVVT DX systems plus all single/dual duct air handlers and fan coil units. This curve describes the part load latent performance of the coil. The coil surface condition is determined by the entering conditions, coil capacity (chilled water setpoints or DX system set as implied through MIN-SUPPLY-T or MIN-SUPPLY-SCH), bypass factor at full load (as found by applying the modifier functions to the ARI point values). As the cooling part load ratio drops the bypass factor is modified by the value of this function in the following way:

$$CBF = CBFD + (1.0-CBFD)*(1.0-[COIL-BF-FPLR])$$

where CBFD is the bypass factor at full load

This means the part load operation of the coil alters the bypass factor (usually allowing it to rise toward 1.0 at a zero part load ratio). The coil surface temperature, however, is calculated using the full load bypass factor even at part loading conditions; thus the amount of air which has water removed is less than at full load (since the part load bypass factor is increasing) but the air that does "see" the coil responds to the full load surface conditions.

This curve allows a general specification of the fraction of "wet surface" as a function of the sensible load on the coil. The intent is to simulate the operation of chilled water or DX coils as the capacity is modulated by reducing the flow through the coil, reducing the coil circuits in use, or other methods of capacity control. The general nature of the curve allows all types of coils to be simulated by adjusting the part load latent performance of the coil by the replacement of this curve. This curve has no direct effect on the total capacity or sensible performance of the system.

## MIN-SUPPLY-SCH

This keyword allows you to specify the value of MIN-SUPPLY-T on an hourly basis to simulate the effect of chilled water reset (or other types of capacity control) coil performance. The coil minimum conditions will be based on the value of this schedule rather than the value of MIN-SUPPLY-T. MIN-SUPPLY-T will be used in design calculations for coil and system component sizing only. The

## Supplement — 2.1E Update

values in the schedule are used to calculate the coil surface conditions (temperature and moisture condensation) but are not used to set the supply air controller (if present) except that the supply temperature cannot go below this value (adjusted for fan heat and duct losses). The value specified in this schedule should be coordinated with the COOL-CONTROL method and related schedules, reset schedules, or setpoints, as well as coil performance parameters.

## SYSTEM SIZING

### Introduction

In this section we describe the procedure used in DOE-2 for automatic sizing of systems. The procedure is based on the ASHRAE method found in the *ASHRAE Systems Handbook* (all editions); a few modifications have been made in order to automate the method. It is hoped that this material will provide some background on how the program works and how the DESIGN-DAY routines function. We also point out the effect of different user inputs on the resultant sizes.

To size a heating/cooling system, the following quantities must be determined:

- maximum quantity of air supplied to each zone
- minimum amount of outside ventilation air required by each zone
- maximum and minimum thermostat setpoints of each zone
- heating coil design capacity
- cooling coil total (sensible + latent) design capacity
- cooling coil sensible design capacity
- maximum and minimum coil leaving air temperatures
- heat added to the air by supply and return fans
- minimum zone air flow rates for variable volume systems

### Step by Step Design Procedure for SYSTEMS

We suggest that you open the *BDL Summary (2.1E)* to the SYSTEMS section and follow the location and default values of the keywords as they appear in this discussion. The constants 1.08 and 4.5 will be used here even though the program calculates these values hourly as a function of atmospheric pressure and air temperature:

$$1.08 = \frac{60 \text{ minutes/hr} * .24\text{Btu/lb-F (specific heat of air)}}{13.3 \text{ cuft/lb dry air}}$$

$$4.5 = \frac{60 \text{ minutes/hr}}{13.3 \text{ cuft/lb dry air}}$$

#### Step 1.

From the LOADS run determine the air flow rate that will satisfy the zone peak cooling load:

$$\text{CFM}_{\text{clg}} = \frac{\text{Zone Peak Cooling Load}}{[(\text{DESIGN-COOL-T}) - (\text{MIN-SUPPLY-T})] * 1.08}$$

#### Step 2.

From the LOADS run determine the air flow rate that will satisfy the zone peak heating load:

$$\text{CFM}_{\text{htg}} = \frac{\text{Zone Peak Heating Load}}{[(\text{MAX-SUPPLY-T}) - (\text{DESIGN-HEAT-T})] * 1.08}$$



**Step 3.**

Compare CFM<sub>clg</sub> to CFM<sub>htg</sub> and choose the larger of the two values as the zone CFM.

**Step 4.**

If SIZING-OPTION = NON-COINCIDENT, sum the zone CFMs to determine the SUPPLY-CFM; otherwise:

$$\text{SUPPLY-CFM} = \frac{\text{Building Peak Cooling Load}}{[(\text{DESIGN-COOL-T}) - (\text{MIN-SUPPLY-T})] * 1.08}$$

**Step 5.**

On the psychrometric chart, Fig. 3.26, locate the drybulb temperature points for MIN-SUPPLY-T and DESIGN-COOL-T. For this example we assume that all zones have the same DESIGN-COOL-T. The difference between these values is supply<sub>dt</sub>.

Add fan<sub>dt</sub> to supply<sub>dt</sub> to account for fan heat picked up by the supply air. This gives the desired leaving air drybulb temperature (LAT). Note that when the supply fan is located in the blow through position relative to the coil, fan<sub>dt</sub> is added to the return air temperature.

Determine the total supply<sub>dt</sub> required when a portion of the air entering the coil bypasses the finned coil surface (as determined by the user-specified value of COIL-BF):

$$\text{total\_supply\_dt} = \frac{\text{fan\_dt} + \text{supply\_dt}}{1 - \text{COIL-BF}}$$

This gives temperature TC in Fig. 3.26. The intersection of the vertical line through TC and the saturation line gives the coil condition, C, with corresponding humidity ratio, WC.

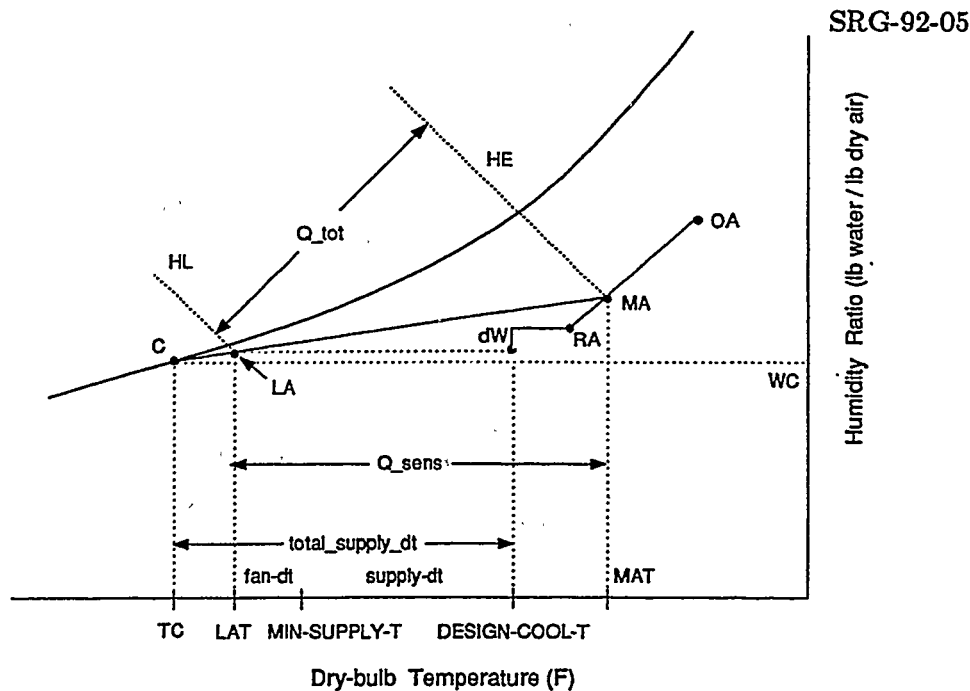

**Figure 3.26:** Psychrometric chart showing SYSTEMS sizing procedure in DOE-2.

**Step 6.**

Calculate the increase in humidity ratio due to moisture gain in the space (dW in Fig. 3.26):

$$dW = \frac{\sum \text{zone latent loads} + (\text{MIN\_OA\_latent})(\text{COIL-BF})}{4.5 * \text{CFM\_clg} * 1010 \text{ Btu/lb (heat of vaporization)}}$$

Add return air light heat and return air fan heat to obtain the return air condition (RA in Fig. 3.26).

**Step 7.**

Locate outside air design point, OA, from weather tape or DESIGN-DAY data. Calculate percent outside air based on one of the following:

- OA-CFM/PERSON
- OA-CHANGES
- OUTSIDE-AIR-CFM
- EXHAUST-CFM
- MIN-OUTSIDE-AIR

Find the mixed air point, MA, resulting from mixing outside air and return air. The enthalpy at this point is the entering air enthalpy, HE.

**Step 8.**

Draw a line connecting points MA and C (Fig. 3.26). The intersection of this line and the vertical line through LAT gives the leaving air condition, LA, with enthalpy HL.

**Step 9.**

Calculate total cooling coil capacity:

$$Q_{\text{tot}} = \text{CFM\_clg} * 4.5 * (\text{HE} - \text{HL})$$

Calculate sensible cooling coil capacity:

$$Q_{\text{sen}} = \text{CFM\_clg} * 1.08 * (\text{MAT} - \text{LAT})$$

Note: These two values, modified by changing entering and condensing temperatures, are treated as the limiting capacities of the cooling coil during simulation run periods. Whenever these capacities are exceeded, the program reports "loads not met" and allows the space temperature to float upwards.

**Step 10.**

For the SV-A report, adjust  $Q_{\text{tot}}$  to ARI rated conditions (80°F dry-bulb room and 67°F wet-bulb room, or, for packaged units, 67°F wet-bulb room and 95°F dry-bulb outside) using the curve COOL-CAP-FT for the appropriate type of coil. Similarly, adjust  $Q_{\text{sen}}$  to ARI rated conditions using the curve COOL-SH-FT for the appropriate type of coil.

Calculate the system Sensible Heat Ratio for the SV-A report:

$$\text{SHR} = \frac{Q_{\text{sen}} @ \text{ARI rating point}}{Q_{\text{tot}} @ \text{ARI rating point}}$$

**Step 11.**

Calculate the design heating capacity of all central heating coils based on the larger of CFM<sub>clg</sub> or CFM<sub>htg</sub> or SUPPLY-CFM:

Central Heating Coil Capacity:

$$1.08 * CFM * [(MAX-SUPPLY-T) - (DESIGN-HEAT-T)]$$

Calculate the design heating capacity of all zonal heating coils based on the larger of CFM<sub>clg</sub> or CFM<sub>htg</sub> or ASSIGNED-CFM:

Zone Heating Coil Capacity:

$$1.08 * CFM * [(MAX-SUPPLY-T) - (DESIGN-HEAT-T)]$$

Supplemental Heating for PTAC:

$$1.08 * CFM * [(MAX-SUPPLY-T) - (DESIGN-HEAT-T)]$$

The heating capacity of HP units is related to the compressor capacity according to:

Incremental HP Coil Capacity:

$$COOLING-CAPACITY * COP_{htg}/COP_{clg}$$

The capacity of baseboard radiators must be hand calculated and input by you.

**Step 12.**

Calculate the default value of MIN-CFM-RATIO for variable air volume systems:

$$MIN-CFM-RATIO = \frac{\text{zone heating load}}{1.08 * [(MAX-SUPPLY-T) - (DESIGN-HEAT-T)]}$$

$$MIN-CFM-RATIO = \frac{\text{minimum outside air cfm}}{SUPPLY-CFM}$$

Most design engineers will see some differences between the DOE-2 and ASHRAE procedures; the latter starts by selecting an apparatus dewpoint, which then determines the humidity ratio of the leaving air. However, the differences are minor and only significant at peak outside air temperatures. Also note that the simulated control point is MIN-SUPPLY-T, which is the temperature of the supply air leaving the air handling unit and eventually entering the zone, and not the coil leaving air temperature.

### Consequences of User Inputs

In this section we describe the consequences of user inputs that override the program's calculated values.

- As you reduce the difference between DESIGN-COOL-T and MIN-SUPPLY-T in Step 1, CFM<sub>clg</sub> increases.
- As you reduce the difference between DESIGN-HEAT-T and MAX-SUPPLY-T in Step 2, CFM<sub>htg</sub> increases.
- If you choose unreasonable values in Steps 1 or 2, the calculations in the other steps are likely to produce unwanted results since the DOE-2 procedure chooses the larger of CFM<sub>clg</sub> and CFM<sub>htg</sub>. For example, baseboard heating is being used and a designer decides to lock out central heating by setting MAX-SUPPLY-T = 75°F and DESIGN-HEAT-T = 70°F. This results in a temperature difference of only 5°F, which gives a very high value for CFM<sub>htg</sub> in Step 2 and a correspondingly high value for CFM<sub>clg</sub> in Step 3. The end result is a cooling coil capacity that is very oversized. The correct way to lock out the availability of heating or cooling is through the use of keywords HEATING-SCHEDULE or COOLING-SCHEDULE with schedule values set to zero.
- The converse of the above problem is when you input a high value for MAX-SUPPLY-T, 150°F for example. Because CFM<sub>htg</sub> is set equal to the CFM<sub>clg</sub>, this results in a heating coil that is oversized. This is especially harmful to the sizing of packaged units with gas-fired furnaces because the result would be always operating at the low end of the part-load-ratio curve when heating.
- If you select SIZING-OPTION = COINCIDENT in Step 4, but the building cooling loads are very low because of excellent glazing and low lighting and equipment load levels, the result is a SUPPLY-CFM of only 0.25 CFM/sqft. This flow rate may be too small to handle the Monday morning pull-down load after a hot weekend. To avoid this, inputs such as CFM/SQFT and AIR-CHANGES/HR can be used to set a minimum design threshold below which the zone air flow rate may not drop.
- If the coil bypass factor (keyword COIL-BF under SYSTEM-EQUIPMENT) is input at 0.3 in Step 5, it will depress the leaving air temperature and the leaving humidity ratio. Note that the default values for COIL-BF differ according to system type. Central chilled water coils default to 0.037, but DX packaged coils default to 0.19, and PTAC and RESYS default to 0.24. The rationale for these defaults is that DX coils are usually less than three rows deep and operate at temperatures lower than chilled water coils, which results in depressed leaving air temperatures.
- If the keyword SUPPLY-DELTA-T (which equals fan<sub>dt</sub> in Fig. 3.26) is set to zero in Step 5, there is no depression for fan heat. This is often done for small packaged units since the evaporator fan energy is included in the EER rating of the unit.
- When you enter ASSIGNED-CFM or SUPPLY-CFM in Step 7, these values override the calculated values and the total cooling and sensible cooling capacities are adjusted based on the previously-calculated leaving air conditions. If SIZING-RATIO = 1.2 is input, the

adjustment is to both the air flow and coil capacities as both are increased by 20%. If the minimum outside air has been specified using the MIN-OUTSIDE-AIR keyword, the minimum outside air is also increased 20%. However, if the minimum outside air has been specified at the zone level, it does not change. Other inputs such as CFM/SQFT and AIR-CHANGES/HR set a minimum design air flow rate and result in the same total and sensible cooling adjustments (as those described for SUPPLY-CFM), but only if they increase the air flow beyond the calculated values. The size of heating coils in the system is also increased by 20% if SIZING-RATIO = 1.2.

- If you enter SUPPLY-CFM (or sum of ASSIGNED-CFM) at Step 9, plus COOLING-CAPACITY and COOL-SH-CAP (which replace the calculated ARI rated capacities), the program overwrites the calculated cooling capacity, but uses COOL-SH-CAP to adjust the supply\_dt according to:

$$\text{supply\_dt (adjusted)} = \frac{\text{COOL-SH-CAP} * \text{COOL-SH-FT} (t_1, t_2)}{1.08 * \text{SUPPLY-CFM}}, \text{ and}$$

$$\text{LAT (adjusted)} = \text{supply\_dt(adjusted)} - \text{MAT}$$

where for built-up systems, t1 = room drybulb and t2 = room wetbulb, and  
for packaged units, t1 = room wetbulb and t2 = outside drybulb.

If COOL-SH-CAP is not specified it is recalculated based on the new SUPPLY-CFM and supply\_dt and adjusted to ARI rated conditions using the COOL-SH-FT curve, with the restriction that COOL-SH-CAP  $\leq$  cooling capacity.

- If you enter COOLING-CAPACITY and COOL-SH-CAP without any other changes that affect design parameters, the program overwrites the calculated Q\_tot and Q\_sens (Step 10) at ARI conditions. Note that these new ratings only serve to set the limits during the simulation for total cooling and sensible cooling capacities of chilled water coils and DX coils. The DX coil ratings also set capacities of the compressors in packaged units; when oversized, they cause the compressors to operate more hours at low part load. On the other hand, changing the capacity of chilled water coils has little effect on the sizing of the chillers in PLANT unless the new coil capacity is less than adequate.
- If you enter COOL-SIZING-RATIO, the program increases or decreases the Q\_tot value established in Step 10. Again, this will adjust the total cooling capacity, but not the sensible cooling capacity. This is analogous to the situation described above when the input is SUPPLY-CFM plus COOLING-CAPACITY minus any input for COOL-SH-CAP.

The most likely application of COOL-SIZING-RATIO is to specify SIZING-RATIO > 1.0 (in order to increase the air-side capacity), with COOL-SIZING-RATIO = 1/(SIZING-RATIO) to keep the coil size constant. The heating coil capacity can be adjusted independently by specifying HEAT-SIZING-RATIO using this same formula.

- The sizing calculation for zonal systems is the same as that described for central systems, but the sizing is done separately for each zonal unit (e.g., fan coil unit, water source heat pump, etc.).

**How Sizing Routines and Run Period Simulations Differ**

The sizing calculation is, in a way, a framework for the hourly simulation in the sense that the fixed state points in the sizing calculation become variable state points in the hourly calculation. State points described for the design are now treated as variables. As with the sizing calculation, the starting point for the hourly calculation is one of determining the leaving air temperature (LAT) and humidity ratio. For constant-temperature systems, the hourly simulation follows the design calculation fairly closely. However, for variable-temperature systems (or systems with reset or “warmest” control), the leaving air temperature is continuously modified to satisfy the zone load.

Examples of what happens during the hourly calculation:

- DESIGN—COOL—T and DESIGN—HEAT—T are replaced with the previous hour’s calculated zone temperature, which is controlled by a room thermostat with setpoints that follow the COOL—TEMP—SCH and HEAT—TEMP—SCH values. These setpoints are further modified by the thermostat’s throttling range.
- The zone temperatures are allowed to float up or down when the fans are off which, in turn, affects the coil conditions at start-up.
- The leaving coil temperature and humidity ratio changes as a function of the system part load ratio and the controller throttling range.
- A moisture balance on each zone replaces the sizing calculation for the change in humidity ratio. This is necessary because the outside air from infiltration and ventilation may be dry and will offset the moisture gain from people. When this happens the calculation assumes a dry coil and reduces the coil capacity to the sensible cooling value.
- Reheat (if available) may be added to the supply air to offset any reductions in space heat gains. Otherwise, the simulated zone temperatures may be much lower than desired.
- Supply air reset control and “warmest” control also change the coil leaving temperature and humidity ratio. Note, however, that unless you input a value for HEAT—SET—T, which is the highest supply air temperature allowed, the supply air temperature will remain at MIN—SUPPLY—T.
- When the return air relative humidity is greater than that specified by MAXIMUM—HUMIDITY, the supply air temperature may be driven down to MIN—SUPPLY—T, thus removing more moisture. This assumes that the supply air temperature is higher than the MIN—SUPPLY—T setpoint due to either a supply air reset, a warmest control, or an elevated COOL—SET—T. Unless the keyword REHEAT—DELTA—T is also input, overcooling may be simulated.
- The program may add moisture to the supply air if the return air relative humidity is less than that specified by MINIMUM—HUMIDITY.
- Coil capacities and fan heat are a function of air flow rate for variable air volume systems.

Supplement — 2.1E Update

- The LOADS program calculates cooling and heating loads at a constant (user-specified) reference temperature. These loads are passed to SYSTEMS, where they are adjusted in the hourly simulation to account for the actual zone temperature (which varies with changes in thermostat setpoints and fan operation) and for conduction to and from adjacent zones.
- Cooling coil capacity and condensing temperature of packaged units depend on hourly-varying outside air conditions.
- In the hourly calculation, the percentage of total outside air can vary from hour to hour depending on the economizer operation. However, for system sizing, the outside air percentage is assumed to be at its minimum. A common mistake is to set DRYBULB-LIMIT (ECONO-LIMIT-T) too high. This can cause the outside air dampers to be wide open even though the outside air is laden with moisture. The resulting large latent load may cause the design cooling coil capacity to be exceeded.
- It is recommended that SIZING-OPTION = ADJUST-LOADS be specified in the ZONE instruction when there are return air plenums. This will improve the system sizing by accounting for conduction from roof to plenum and from plenum to zone.

## INDEPENDENT COOLING AND HEATING SIZING RATIOS

Two keywords were added to DOE-2.1E that allow SYSTEMS sizing ratios to be applied independently to cooling and heating. Previously, only a single multiplier, SIZING-RATIO, was available; it multiplied the supply air CFM which resulted in a like change in the heating and cooling coil capacities.

### SYSTEM

**COOL-SIZING-RATIO**

is a multiplier on the cooling coil capacity. The default is 1.0. If SIZING-RATIO is also specified, the net multiplier is approximately  $(\text{COOL-SIZING-RATIO}) * (\text{SIZING-RATIO})$ .

**HEAT-SIZING-RATIO**

is a multiplier on the heating coil capacity. The default is 1.0. If SIZING-RATIO is also specified, the net multiplier is  $(\text{HEAT-SIZING-RATIO}) * (\text{SIZING-RATIO})$ .

---

In the left column above, bold-faced words are commands, non-bold words are keywords, and italicized words are code-words.



## ADDITIONS TO SYSTEMS REPORT SS-J

In DOE-2.1E, SYSTEMS report SS-J, System Peak Heating and Cooling Days, has been expanded to include the following design information:

- System Type
- Supply CFM/sqft
- Sqft/ton of cooling
- Minimum outside air CFM per person
- Outside air fraction at peak heating
- Outside air fraction at peak cooling

In addition, asterisks now indicate those hours for which loads have not been met. See the SS-J report description in Appendix C.

### DESIGN—DAY Systems Report

Starting with DOE-2.1E, the results of DESIGN—DAY sizing in SYSTEMS will be summarized in report SS-J, System Peak Heating and Cooling Days (DESIGN—DAY).

To complement this new information on the SS-J report, similar information is given on the SS-D report (which is necessary when there is more than one system) for the peak integrated cooling load passed to PLANT.

## USER-DEFINED CURVE-FIT BOUNDARIES

In 2.1B two keywords were added to the CURVE-FIT command in SYSTEMS and PLANT that allow you to establish both the lower and upper boundaries beyond which the curve is not valid. The keywords are:

OUTPUT-MIN	defines the lower boundary of the dependent variable, and
OUTPUT-MAX	defines the upper boundary of the dependent variable.

## SYSTEM-EQUIPMENT DEFAULT CURVES

The default curves for most of the keywords in the SYSTEM-EQUIPMENT command were upgraded in DOE-2.1C in order to more closely resemble equipment now on the market. The table presented on the next two pages replaces Chap. IV, Table 39, of the *Reference Manual* (2.1A). Also introduced are four new keywords and accompanying default curves for special use in the PSZ system (see p.3.103, HEAT RECOVERY FROM REFRIGERATED CASE WORK).

The new curves were developed from rated data using various representative equipment specifications found in manufacturers' catalogs:

RESVVT	37,600 Btu/hr cooling, 34,600 Btu/hr heating, 1100 cfm variable speed heat pump.
RESYS	36,000 Btu/hr air-cooled condensing unit, rated 3 tons @ ARI, 1200 CFM, 3 row, 13-14 fins per inch (fpi), 4.5 ft/sec (indoor), 20 fpi, 3.5 ft/sec (outdoor).
PTAC	A combination of data from three units, from 6,900 Btu/hr to 11,800 Btu/hr in size.
HP	35,000 Btu/hr cooling, 39,000 Btu/hr heating, shr = 0.74, 26,000 Btu/hr sensible, 4.5 GPM 20° ΔT, 4 row, 12 fpi, 500 ft/min.
PSZ	360,000 Btu/hr, 30 tons, 2 compressors unloading to 15%,
PMZS	3 condenser fans, 3 row, 15 fpi, 7 ft/sec (outdoor condenser)
PVAVS	4 row, 15 fpi, 8 ft/sec (indoor evaporator).
Builtup ahu	Tube and fin coil, 6 row, 15 fpi, 600 ft/min, 86°DB/67°WB, 45° entering water, 10° ΔT, 4 ft/sec.
TPFC	
FPPC	4 row, 14 fpi, 600 ft/min, 44° entering water, 12° ΔT, 6 ft/sec.

Curve SDL-C18, COOL-EIR-FPLR for packaged units PSZ, PMZS, and PVAVS, comes from data in the ICES Report ANL/CES/TE 78-2. This curve corresponds to Curve 4 on p. 10 of that report. Coefficients for Curves 1 (Hot gas bypass), 2 (Back pressure valve), and 3 (Suction valve-lift unloading, single compressor) from this same report have been added to the program's predefined curves. However, they are not used as defaults for any of the equipment, but may be specified as alternatives to SDL-C18. The curve numbers are SDL-C117 (Hot gas bypass), SDL-C118 (Back pressure valve) and SDL-C119 (Suction valve). See table below for coefficients.

The hydronic heat pump curves have been normalized to a water temperature of 70°F. In earlier versions of the code, 60°F was used. This change reflects a change in the ARI reference conditions from ARI 240-75 to ARI 320-76, and to ASHRAE Std. 90A-1980, Table 6.10.

TABLE 3.1  
SYSTEM-EQUIPMENT DEFAULT CURVES

SYSTEM-EQUIPMENT DEFAULT CURVES

Equations are assumed to take the form:

- Linear:  $z = a + bx$
- Bi-Linear:  $z = a + bx + dy$
- Cubic:  $z = a + bx + cx^2 + dx^3$
- Quadratic:  $z = a + bx + cx^2$
- Bi-Quadratic:  $z = a + bx + cx^2 + dy + ey^2 + fxy$

Default Curve u-name	Type of Curve	a	b	c	d	e	f	Keyword	Applicable SYSTEM-TYPE* [*see definitions at end of table]	Independent Variable(s)*
SDL-C1	BI-QUAD	0.6003404	0.0022873	-0.000128	0.0013898	-0.0000806	0.0001412	COOL-CAP-FT	RESYS	WB/EDB
SDL-C2	BI-QUAD	1.1839345	-0.0081087	0.0002110	-0.0061425	0.0000016	-0.0000030	COOL-CAP-FT	PTAC	WB/EDB
SDL-C3	BI-QUAD	0.8740302	-0.0011416	0.0001711	-0.0029570	0.0000102	-0.0000592	COOL-CAP-FT	PSZ,PMZS,PVAVS	WB/EDB
SDL-C4	BI-QUAD	-0.2938200	0.0222213	0.00006988	0.0040928	-0.00000236	-0.00013774	COOL-CAP-FT	RESVVT	WB/EDB
SDL-C5	BI-QUAD	-0.2780377	0.0248307	-0.0000095	-0.0032731	0.0000070	-0.0000272	COOL-CAP-FT	HP	WB/WT
SDL-C6	BI-QUAD	0.9452633	-0.0094199	0.0002270	0.0004805	-0.0000045	-0.0000599	COOL-CAP-FT	WTR-CC	WB/WT
SDL-C7	BI-QUAD	2.5882585	-0.2305879	0.0038359	0.1025812	0.0005984	-0.0028721	COOL-CAP-FT	SZRH,MZS,DDS, SZCI,TPIU,FPIU, VAVS,RHFS, CBVAV,PIU	WB/DB
SDL-C8	BI-QUAD	0.8740302	-0.0011416	0.0001711	-0.0029570	0.0000102	-0.0000592	COOL-CAP-FT	PVVT	WB/EDB
SDL-C9	BI-LINEAR	1.0976758	0.0105662	0.0000000	-0.0085506	0.0000000	0.0000000	COOL-CAP-FT	GHP	WB/EDB
SDL-C10	BI-QUAD	0.5038866	-0.0869176	0.0016847	0.0336304	0.0002478	-0.00010297	COOL-CAP-FT	TPFC,FPFC	WB/DB
SDL-C11	BI-QUAD	-0.9617787	0.0481775	-0.0002311	0.0032439	0.0001488	-0.0002952	COOL-EIR-FT	RESYS	WB/EDB
SDL-C12	BI-QUAD	-0.6550461	0.0388910	-0.0001925	0.0013046	0.0001352	-0.0002247	COOL-EIR-FT	PTAC	WB/EDB
SDL-C13	BI-QUAD	-1.0639310	0.0306584	-0.0001269	0.0154213	0.0000497	-0.0002096	COOL-EIR-FT	PSZ,PMZS,PVAVS	WB/EDB
SDL-C14	BI-QUAD	-1.8394760	0.0751363	-0.0005686	0.0047090	0.0000901	-0.0001218	COOL-EIR-FT	WTR-CC	WB/EDB
SDL-C15	BI-QUAD	2.0280385	-0.0423091	0.0003054	0.0149672	0.0000244	-0.0001640	COOL-EIR-FT	HP	WB/WT
SDL-C16	LINEAR	0.1250000	0.8750000	0.0000000	0.0000000	0.0000000	0.0000000	COOL-EIR-FPLR	RESYS	PLR
SDL-C17	LINEAR	0.1250000	0.8750000	0.0000000	0.0000000	0.0000000	0.0000000	COOL-EIR-FPLR	PTAC	PLR
SDL-C18	CUBIC	0.2012301	-0.0312175	1.9504979	-1.1205105	0.0000000	0.0000000	COOL-EIR-FPLR	PSZ,PMZS,PVAVS	PLR
SDL-C19	CUBIC	0.2012301	-0.0312175	1.9504979	-1.1205105	0.0000000	0.0000000	COOL-EIR-FPLR	WTR-CC	PLR
SDL-C20	LINEAR	0.1250000	0.8750000	0.0000000	0.0000000	0.0000000	0.0000000	COOL-EIR-FPLR	HP	PLR
SDL-C21	BI-QUAD	6.5275698	-0.1261375	0.0005688	0.0090757	-0.0000483	-0.0000088	COOL-SH-FT	RESYS	WB/EDB
SDL-C22	BI-QUAD	6.3112707	-0.1129951	0.0004834	0.0037738	-0.0000499	0.0000637	COOL-SH-FT	PTAC	WB/EDB
SDL-C23	BI-QUAD	4.8352962	-0.0575307	0.0000616	-0.0052683	0.0000032	0.0000337	COOL-SH-FT	PSZ,PMZS,PVAVS	WB/EDB

SYSTEM-EQUIPMENT DEFAULT CURVES (continued)

Default Curve u-name	Type of Curve	a	b	c	d	e	f	Keyword	Applicable SYSTEM-TYPE* [*see definitions at end of table]	Independent Variable(s)* Variable(s) at end of table]
SDL-C51	CUBIC	0.2949569	0.0142534	-0.0000117	0.0000006	0.0000000	0.0000000	HEAT-CAP-FT	RESYS	ODB/DBTH
SDL-C52	CUBIC	0.2536714	0.0104351	0.0001861	-0.0000015	0.0000000	0.0000000	HEAT-CAP-FT	PSZ,PVAVS,PTAC	ODB/DBTH
SDL-C53	BI-LINEAR	0.4886534	-0.0067774	0.0000000	0.0140823	0.0000000	0.0000000	HEAT-CAP-FT	WTR-CC	DB/WT
SDL-C54	BI-LINEAR	1.3876102	0.0060479	0.0000000	-0.0115852	0.0000000	0.0000000	HEAT-EIR-FT	WTR-CC	DB/WT
SDL-C55	BI-LINEAR	0.4886534	-0.0067774	0.0000000	0.0140823	0.0000000	0.0000000	HEAT-CAP-FT	HP	DB/WT
SDL-C56	CUBIC	2.1855478	-0.0494718	0.0007042	-0.0000040	0.0000000	0.0000000	HEAT-EIR-FT	RESYS	ODB/DBTH
SDL-C57	CUBIC	2.4600298	-0.0622539	0.0008800	-0.0000046	0.0000000	0.0000000	HEAT-EIR-FT	PSZ,PVAVS,PTAC	ODB/DBTH
SDL-C58	QUAD	1.1833000	-0.2575300	0.0742450	0.0000000	0.0000000	0.0000000	DIRECT-EFF-FFLOW	SZRH,MZS,DDS, SZCI,VAVS, RHF'S,RESYS, PSZ,PVVT, PVAVS,PIU, FNYSI,HP, EVAP-COOL, RESVVT, CBVAV,PMZS	CFM-PLR
SDL-C59	QUAD	1.0970000	-0.1650600	0.0680690	0.0000000	0.0000000	0.0000000	INDIR-EFF-FFLOW	SZRH,MZS,DDS, SZCI,VAVS, RHF'S,HP, PMZS,CBVAV, PVAVS,PIU, FNYSI, EVAP-COOL, PVVT,PSZ	CFM-PLR
SDL-C60	BI-LINEAR	1.3876102	0.0060479	0.0000000	-0.0115852	0.0000000	0.0000000	HEAT-EIR-FT	HP	DB/WT
SDL-C61	CUBIC	0.0856522	0.9388137	-0.1834361	0.1589702	0.0000000	0.0000000	HEAT-EIR-FPLR	RESYS,HPDefrst	PLR
SDL-C62	CUBIC	0.0856522	0.9388137	-0.1834361	0.1589702	0.0000000	0.0000000	HEAT-EIR-FPLR	PSZ,PVAVS,PTAC	PLR
SDL-C63	BI-LINEAR	1.2034744	0.9024203	0.0000000	0.1425972	0.0000000	0.0000000	T8-FWB1WB6	PTGSD	WB1,WB6
SDL-C64	BI-LINEAR	0.4943708	0.9719835	0.0000000	0.0366191	0.0000000	0.0000000	T8PL-FWB1WB6	PTGSD	WB1,WB6
SDL-C65	CUBIC	0.0856522	0.9388137	-0.1834361	0.1589702	0.0000000	0.0000000	HEAT-EIR-FPLR	HP	PLR
SDL-C66	LINEAR	0.0300000	0.0000000	0.0000000	0.0000000	0.0000000	0.0000000			
SDL-C67	BI-QUAD	-4.5570784	0.0514961	0.0002265	0.0953548	0.0001825	-0.0008174	HR8-FWB1WB6	PTGSD	WB1,WB6
SDL-C68	BI-QUAD	-3.6683564	0.0566377	0.0001551	0.0635270	0.0003313	-0.0007574	HR8PL-FWB1WB6	PTGSD	WB1,WB6
SDL-C69	BI-QUAD	142.1253204	-0.8725370	0.0052747	-1.4026911	0.0000135	0.0058521	QREG-FWB1WB6	PTGSD	WB1,WB6
SDL-C70	BI-QUAD	36.5727196	-0.2314126	0.0014185	-0.3725829	-0.0000740	0.0016068	QREGPL-FWB1WB6	PTGSD	WB1,WB6
SDL-C71	BI-QUAD	11.5334997	0.6586730	-0.0010280	0.2950410	-0.0001700	-0.0008724	DESC-T-FTW	SZRH,MZS, SZCI,VAVS, RHF'S,PVAVS,	T,W

SYSTEM-EQUIPMENT DEFAULT CURVES (continued)

Default Curve u-name	Type of Curve	-----Default Curve Coefficients-----										Keyword	Applicable SYSTEM-TYPE* [*see definitions at end of table]	Independent Variable(s) at end of table]
		a	b	c	d	e	f							
SDL-C24	BI-LINEAR	4.33764935	-0.04564833	0.0000000	-0.0029426	0.0000000	0.0000000	0.0000000	0.0000000	0.0000000	0.0000000	COOL-SH-FT	RESVVT	WB/EDB
SDL-C25	BI-QUAD	1.0181313	0.0477591	-0.0006660	-0.0081062	0.0000195	0.0000537	0.0000840	0.0000091	0.0000000	0.0000000	COOL-SH-FT	HP	WB/WT
SDL-C26	BI-QUAD	2.3352058	0.131768	-0.0004590	-0.0067110	-0.0000091	0.0000840	0.0000091	0.0000000	0.0000000	0.0000000	COOL-SH-FT	WTR-CC	WB/WT
SDL-C27	BI-QUAD	0.8982767	-0.1312367	0.0019888	0.08966540	0.0005703	-0.0020087	0.0000000	0.0000000	0.0000000	0.0000000	COOL-SH-FT	SZRH,MZS,DDS, SZCI,TFIU,FPIU, VAVS,RHFS, CBVAV,FPIU	WB/DB
SDL-C28	BI-QUAD	4.8352962	-0.0575307	0.0000616	-0.0052683	0.0000032	0.0000337	0.0000000	0.0000000	0.0000000	0.0000000	COOL-SH-FT	PVVT	WB/EDB
SDL-C29	BI-QUAD	-0.4577598	0.1209203	-0.0012978	-0.0260415	0.0000486	0.0001913	0.0000000	0.0000000	0.0000000	0.0000000	COOL-SH-FT	GAS-HP	WB/WT
SDL-C30	BI-QUAD	-1.2280540	-0.0320956	0.0004838	0.0574913	0.0001374	-0.0005685	0.0000000	0.0000000	0.0000000	0.0000000	COOL-SH-FT	TPFC,FPFC	WB/DB
SDL-C31	QUAD	-3.0128000	6.5855999	-2.5727999	0.0000000	0.0000000	0.0000000	0.0000000	0.0000000	0.0000000	0.0000000	COIL-BF-FFLOW	RESYS	CFM-PLR
SDL-C32	QUAD	-2.2770000	5.2114000	-1.9344000	0.0000000	0.0000000	0.0000000	0.0000000	0.0000000	0.0000000	0.0000000	COIL-BF-FFLOW	PTAC	CFM-PLR
SDL-C33	QUAD	-0.2542341	1.2182558	0.0359784	0.0000000	0.0000000	0.0000000	0.0000000	0.0000000	0.0000000	0.0000000	COIL-BF-FFLOW	PSZ,PMZS,PVAVS	CFM-PLR
SDL-C34	QUAD	-0.2542341	1.2182557	0.0359784	0.0000000	0.0000000	0.0000000	0.0000000	0.0000000	0.0000000	0.0000000	COIL-BF-FFLOW	RESVVT	CFM-PLR
SDL-C35	CUBIC	-0.8281602	14.3179150	-21.8894405	9.3996897	0.0000000	0.0000000	0.0000000	0.0000000	0.0000000	0.0000000	COIL-BF-FFLOW	HP	CFM-PLR
SDL-C36	CUBIC	0.8995464	-3.7310793	7.3715305	-3.5399759	0.0000000	0.0000000	0.0000000	0.0000000	0.0000000	0.0000000	COIL-BF-FFLOW	WTR-CC	CFM-PLR
SDL-C37	QUAD	0.3966057	0.1496471	0.4537471	0.0000000	0.0000000	0.0000000	0.0000000	0.0000000	0.0000000	0.0000000	COIL-BF-FFLOW	SZRH,MZS,DDS, SZCI,TFIU,FPIU, VAVS,RHFS, FPIU,CBVAV, FNSYSI	CFM-PLR
SDL-C38	QUAD	-0.2542341	1.2182558	0.0359784	0.0000000	0.0000000	0.0000000	0.0000000	0.0000000	0.0000000	0.0000000	COIL-BF-FFLOW	PVVT	CFM-PLR
SDL-C39	QUAD	-0.2542341	1.2182558	0.0359784	0.0000000	0.0000000	0.0000000	0.0000000	0.0000000	0.0000000	0.0000000	COIL-BF-FFLOW	GAS-HP	CFM-PLR
SDL-C40	QUAD	-0.7177876	1.9070781	-0.1892906	0.0000000	0.0000000	0.0000000	0.0000000	0.0000000	0.0000000	0.0000000	COIL-BF-FFLOW	TPFC,FPFC	CFM-PLR
SDL-C41	BI-QUAD	-4.7977910	0.1404815	-0.0001864	-0.0095173	0.0001113	-0.0004521	0.0000000	0.0000000	0.0000000	0.0000000	COIL-BF-FT	RESYS	WB/EDB
SDL-C42	BI-QUAD	-1.5713691	0.0469633	0.0003152	-0.0065347	0.0001105	-0.0003719	0.0000000	0.0000000	0.0000000	0.0000000	COIL-BF-FT	PTAC	WB/EDB
SDL-C43	BI-QUAD	1.0660053	-0.0005170	0.0000567	-0.0129181	-0.0000017	0.0001503	0.0000000	0.0000000	0.0000000	0.0000000	COIL-BF-FT	PSZ,PMZS,PVAVS	WB/EDB
SDL-C44	BI-QUAD	1.0660054	-0.0005170	0.0000567	-0.0129181	-0.00000169	0.00015027	0.0000000	0.0000000	0.0000000	0.0000000	COIL-BF-FT	RESVVT	WB/EDB
SDL-C45	BI-QUAD	-29.9391098	0.8753455	-0.0057055	0.1614450	0.0002907	-0.0031523	0.0000000	0.0000000	0.0000000	0.0000000	COIL-BF-FT	HP	WB/WT
SDL-C46	BI-QUAD	-29.9391098	0.8753455	-0.0057055	0.1614450	0.0002907	-0.0031523	0.0000000	0.0000000	0.0000000	0.0000000	COIL-BF-FT	WTR-CC	WB/EDB
SDL-C47	BI-QUAD	-2.2625761	0.2171043	-0.0014736	-0.1055870	0.0003687	0.0002648	0.0000000	0.0000000	0.0000000	0.0000000	COIL-BF-FT	SZRH,MZS,DDS, SZCI,TFIU, FPIU,VAVS, FPIU,RHFS, CBVAV	WB/DB
SDL-C48	BI-QUAD	1.0660053	-0.0005170	0.0000567	-0.0129181	-0.0000017	0.0001503	0.0000000	0.0000000	0.0000000	0.0000000	COIL-BF-FT	PVVT	WB/EDB
SDL-C49	BI-QUAD	1.0660053	-0.0005170	0.0000567	-0.0129181	-0.0000017	0.0001503	0.0000000	0.0000000	0.0000000	0.0000000	COIL-BF-FT	GAS-HP	WB/EDB
SDL-C50	BI-QUAD	1.2049495	-0.0034963	0.0001136	-0.0008867	0.0000076	-0.0000855	0.0000000	0.0000000	0.0000000	0.0000000	COIL-BF-FT	TPFC,FPFC	WB/DB

SYSTEM-EQUIPMENT DEFAULT CURVES (continued)

Default Curve u-name	Type of Curve	a	b	c	d	e	f	Keyword	Applicable SYSTEM--TYPE* [*see definitions at end of table]	Independent Variable(s)*
SDL-C72	BI-QUAD	11.8993998	-0.2695580	0.0044649	0.0830525	0.0006974	0.0015879	DESC-W--FTW	HP,CBVAV, PSZ,PMZS, PIU,FNSYS1, PVVT,DDS SZRH,MZS,SZCI, VAVS,RHFS, HP,CBVAV, PSZ,PMZS, PVAVS,PIU, FNSYS1,PVVT, DDS	T, W
SDL-C73	BI-QUAD	58745.8007813	-1134.4899902	-3.6676099	3874.5900879	-1.6962700	-13.0732002	DESC-GAS--FTW	SZRH,MZS,SZCI, VAVS,RHFS, HP,CBVAV, PSZ,PMZS, PVAVS,PIU, FNSYS1, PVVT,DDS	T, W
SDL-C74	BI-LINEAR	3.5179000	-0.0059317	0.0000000	0.0040401	0.0000000	0.0000000	DESC-KW--FTW	SZRH,MZS,SZCI, VAVS,RHFS, HP,CBVAV, PSZ,PMZS, PVAVS,PIU, FNSYS1, PVVT,DDS	T, W
SDL-C75	CUBIC	0.0856522	0.9988137	-0.1834361	0.1589702	0.0000000	0.0000000	HEAT-EIR--FPLR	WTR-CC	PLR
SDL-C76	LINEAR	0.8000000	0.2000000	0.0000000	0.0000000	0.0000000	0.0000000	RATED-CCAP--FFLOW	RESYS,RESVVT	CFM-PLR
SDL-C77	LINEAR	0.8000000	0.2000000	0.0000000	0.0000000	0.0000000	0.0000000	RATED-CCAP--FFLOW	PTAC	CFM-PLR
SDL-C78	CUBIC	0.4727859	1.2433414	-1.0387055	0.3225781	0.0000000	0.0000000	RATED-CCAP--FFLOW	PSZ,PMZS,PVAVS, PVVT,RESVVT	CFM-PLR
SDL-C79	CUBIC	0.9394026	-0.3005555	0.5495562	-0.1884034	0.0000000	0.0000000	RATED-CCAP--FFLOW	HP	CFM-PLR
SDL-C80	QUAD	0.1888321	1.0928053	-0.2816374	0.0000000	0.0000000	0.0000000	RATED-CCAP--FFLOW	SZRH,MZS, FPIU,VAVS, RHFS,PIU, DDS,SZCI, CBVAV, TPIU	CFM-PLR
SDL-C81	QUAD	0.1827345	1.0990207	-0.2817552	0.0000000	0.0000000	0.0000000	RATED-CCAP--FFLOW	TPFC,FPFC	CFM-PLR
SDL-C82	BI-QUAD	0.6039820	-0.0100620	0.00015672	0.0099508	0.00008421	-0.00020963	COOL-EIR--FT RESVVT		WB/ODB

SYSTEM-EQUIPMENT DEFAULT CURVES (continued)

Default Curve u-name	Type of Curve	a	b	c	d	e	f	Keyword	Applicable SYSTEM-TYPE* [*see definitions at end of table]	Independent Variable(s) at end of table]
SDL-C83	LINEAR	0.600000	0.400000	0.000000	0.000000	0.000000	0.000000	RATED-SH-FFLOW	RESYS,RESVVT	CFM-PLR
SDL-C84	LINEAR	0.600000	0.400000	0.000000	0.000000	0.000000	0.000000	RATED-SH-FFLOW	PTAC	CFM-PLR
SDL-C85	CUBIC	0.3446561	0.8928989	-0.3554498	0.1178948	0.0000000	0.0000000	RATED-SH-FFLOW	PSZ,PMZS,PVAVS, PVVT,RESVVT	CFM-PLR
SDL-C86	CUBIC	-0.1300253	2.1583061	-1.6016819	0.5734015	0.0000000	0.0000000	RATED-SH-FFLOW	HP	CFM-PLR
SDL-C87	QUAD	0.2016452	0.8553716	-0.0570167	0.0000000	0.0000000	0.0000000	RATED-SH-FFLOW	SZRH,MZS,DDS, SZCI,TPIU, FPIU,VAVS, RHFS,PIU, CBVAV, FNSYSI	CFM-PLR
SDL-C88	QUAD	0.1546179	1.0052259	-0.1598438	0.0000000	0.0000000	0.0000000	RATED-SH-FFLOW	TPFC,FPFC	CFM-PLR
SDL-C89	BI-QUAD	-1.0639310	0.0306584	-0.0001269	0.0154213	0.0000497	-0.0002096	COOL-EIR-FT	PVVT	WB/EDB
SDL-C90	BI-QUAD	1.7189276	-0.0360319	0.0002821	0.0152193	0.0000943	-0.0002935	COOL-EIR-FT	GHP	WB/EDB
SDL-C91	QUAD	1.1560000	-0.1816000	0.0256000	0.0000000	0.0000000	0.0000000	RATED-CEIR-FFLOW	RESYS,RESVVT	CFM-PLR
SDL-C92	QUAD	1.1552000	-0.1808000	0.0256000	0.0000000	0.0000000	0.0000000	RATED-CEIR-FFLOW	PTAC	CFM-PLR
SDL-C93	CUBIC	1.0079484	0.3454413	-0.6922891	0.3388994	0.0000000	0.0000000	RATED-CEIR-FFLOW	PSZ,PMZS,PVAVS, PVVT,RESVVT	CFM-PLR
SDL-C94	CUBIC	0.9998731	0.2800943	-0.4368050	0.1556376	0.0000000	0.0000000	RATED-CEIR-FFLOW	HP	CFM-PLR
SDL-C95	LINEAR	0.28153282	0.01528654	0.0000000	0.0000000	0.0000000	0.0000000	HEAT-CAP-FT	RESVVT	ODB
SDL-C96	CUBIC	0.2536714	0.0104351	0.0001861	-0.0000015	0.0000000	0.0000000	HEAT-CAP-FT	PVVT	ODB/DBH
SDL-C97	QUAD	0.5948571	0.0045415	0.0000868	0.0000000	0.0000000	0.0000000	HEAT-CAP-FT	GHP	ODB/DBH
SDL-C98	LINEAR	0.8400000	0.1600000	0.0000000	0.0000000	0.0000000	0.0000000	RATED-HCAP-FFLOW	RESYS,RESVVT	CFM-PLR
SDL-C99	LINEAR	0.8400000	0.1600000	0.0000000	0.0000000	0.0000000	0.0000000	RATED-HCAP-FFLOW	PTAC	CFM-PLR
SDL-C100	LINEAR	1.0000000	0.0000000	0.0000000	0.0000000	0.0000000	0.0000000	RATED-HCAP-FFLOW	PSZ,PMZS,PVAVS, PVVT,RESVVT	CFM-PLR
SDL-C101	QUAD	0.4688184	0.8180775	-0.3018959	0.0000000	0.0000000	0.0000000	RATED-HCAP-FFLOW	HP	CFM-PLR
SDL-C102	LINEAR	1.0000000	0.0000000	0.0000000	0.0000000	0.0000000	0.0000000	RATED-HCAP-FFLOW	SZRH,MZS,DDS, SZCI,TPIU, FPIU,VAVS, RHFS,CBVAV, PIU	CFM-PLR
SDL-C103	QUAD	0.9184665	0.0837524	-0.0022189	0.0000000	0.0000000	0.0000000	RATED-HCAP-FFLOW	TPFC,FPFC	CFM/PLR
SDL-C104	CUBIC	2.0857406	-0.05543158	0.00103072	-0.00000681	0.0000000	0.0000000	HEAT-EIR-FT	RESVVT	ODB
SDL-C105	QUAD	1.3824000	-0.4336000	0.0512000	0.0000000	0.0000000	0.0000000	RATED-HEIR-FFLOW	RESYS,RESVVT	CFM-PLR
SDL-C106	QUAD	1.3924000	-0.4468000	0.0544000	0.0000000	0.0000000	0.0000000	RATED-HEIR-FFLOW	PTAC	CFM-PLR
SDL-C107	CUBIC	2.4600298	-0.0622539	0.0008800	-0.0000046	0.0000000	0.0000000	HEAT-EIR-FT	PVVT	ODB/DB
SDL-C108	QUAD	1.4606527	-0.7969647	0.3363120	0.0000000	0.0000000	0.0000000	RATED-HEIR-FFLOW	HP	CFM-PLR



SYSTEM-EQUIPMENT DEFAULT CURVES (continued)

Default Curve	Type of Curve	-----Default Curve Coefficients-----							Keyword	Applicable SYSTEM-TYPE* [*see definitions at end of table]	Independent Variable(s)*
u-name		a	b	c	d	e	f				
SDL-C109	QUAD	1.4478745	-0.0091517	-0.0000080	0.0000000	0.0000000	0.0000000	HEAT-EIR-FT	GHP	ODB/DB	
SDL-C110	LINEAR	0.0000000	1.0000000	0.0000000	0.0000000	0.0000000	0.0000000	HEAT-EIR-FPLR	RESVVT		
SDL-C111	QUAD	0.0186100	1.0942090	-0.1128190	0.0000000	0.0000000	0.0000000	FURNACE-HIR-FPLR	SUM,SZRH, UVT,UHT,FPFH, TPFC,FPFC, DDS,SZCI, MZS,TPIU, FPIU,YAVS, RHFS,PVVT, HVSYS,RESYS, CBVAV,PSZ, PMZS,PVAVS, PTAC,PIU, FNSYS1,HP EVAP-COOL, PTGSD,RESVVT, PSZ [for use with PSZ [reiterated PSZ [casework PSZ ] PVVT ] compressor ] part load ] curves HP,PSZ,PMZS, PTAC,PVVT, PVAVS	PLR	
SDL-C112	QUAD	0.7135360	-0.0049590	0.0000980	0.0000000	0.0000000	0.0000000	REFG-KW-FTCOND		TTWR	
SDL-C113	QUAD	0.0382900	1.0778390	-0.1161290	0.0000000	0.0000000	0.0000000	REFG-KW-FPLR		PLR	
SDL-C114	BI-QUAD	1.4843260	0.1294790	-0.0040140	-0.0543360	0.0003120	-0.0001470	TWR-RFAC-T-FRT		RNG/OWB	
SDL-C115	BI-QUAD	4.9814668	-6.7617888	24.7090321	0.1144990	-0.0006120	-0.2506510	TWR-APP-FRFACT		RNG/OWB	
SDL-C116	CUBIC	0.0856522	0.9388137	-0.1834361	0.1589702	0.0000000	0.0000000	HEAT-EIR-FPLR		PLR	
SDL-C117	CUBIC	1.0758898	-0.6164059	0.9340174	-0.3935014	0.0000000	0.0000000	↑		PLR	
SDL-C118	CUBIC	0.2103936	2.2429550	-2.3194859	0.8661371	0.0000000	0.0000000	↑		PLR	
SDL-C119	CUBIC	0.0312539	1.4895132	-0.7868148	0.2660478	0.0000000	0.0000000	↑		PLR	
SDL-C120	LINEAR	0.0000000	1.0000000	0.0000000	0.0000000	0.0000000	0.0000000	COIL-BF-FPLR		PLR	
BLRHIR2	QUAD	0.0825970	0.9967640	-0.0793610	0.0000000	0.0000000	0.0000000	BOILER-HIR-FPLR	HP	PLR	
RRNGWB	BI-QUAD	1.4843260	0.1294790	-0.0040140	-0.0543360	0.0003120	-0.0001470	TWR-RFAC-T-FRT	HP,WTR-CC	RNG/OWB	
RAPPWB	BI-QUAD	0.8953280	-0.1165500	0.0019170	-0.0010400	-0.0000260	0.0003980	TWR-RFAC-T-FAT	HP,WTR-CC	APP/OWB	
APPRWB	BI-QUAD	4.9814668	-6.7617888	24.7090321	0.1144990	-0.0006120	-0.2506510	TWR-APP-FRFACT	HP,WTR-CC	RNG/OWB	
ECELL	QUAD	-395.1400146	90.9899979	-0.0160000	0.0000000	0.0000000	0.0000000	TWR-FAN-ELEC-FTU	HP,WTR-CC	ARCELL	
TWR-FAN	CUBIC	0.33162901	-0.88567609	0.60556507	0.94848233	0.0000000	0.0000000	TWR-FAN-FPLR	HP,WTR-CC	ARCELL	
GPMRA	BI-QUAD	2.22888899	0.16679543	-0.01410247	0.03222333	0.18560214	0.24251871	TWR-GPM-FRA	HP,WTR-CC	RANGE/FRA	
GPMWB	BI-QUAD	0.60531402	-0.03554556	0.00804083	0.02860259	0.00024972	0.00490857	TWR-GPM-FWB	HP,WTR-CC	FRA/OWB	
CIRC-PUMP	CUBIC	0.0015303	0.0052081	1.1086242	-0.1163556	0.0000000	0.0000000	CIRC-PUMP-FPLR	HP,WTR-CC	PLR	

SYSTEM-EQUIPMENT DEFAULT CURVES (continued)

Default Curve u-name	Type of Curve	----- Default Curve Coefficients -----							Keyword	Applicable SYSTEM-TYPE* [*see definitions at end of table]	Independent Variable(s)* Variable(s) at end of table]
		a	b	c	d	e	f				
-CURVE											
DHW-PLR	QUAD	0.0218260	0.9776800	0.0005430	0.0000000	0.0000000	0.0000000	DHW-HIR-FPLR	all	PLR	
-CURVE											
SDL-C128	LINEAR	0.0000000	1.0000000	0.0000000	0.0000000	0.0000000	0.0000000	COOL-EIR-FPLR	RESVVT	PLR	
SDL-C129	CUBIC	0.2012301	-0.0312175	1.9504979	-1.1205105	0.0000000	0.0000000	COOL-EIR-FPLR	PVVT	PLR	
SDL-C130	LINEAR	0.0000000	1.0000000	0.0000000	0.0000000	0.0000000	0.0000000	†			
SDL-C131	LINEAR	0.0000000	1.0000000	0.0000000	0.0000000	0.0000000	0.0000000	COIL-BF-FPLR	RESYS,RESVVT	PLR	
SDL-C132	BI-QUAD	1.2894493	-0.0271387	0.00024172	0.0059154	0.00015088	-0.00023211	COOL-EIR-LS-FT	RESVVT†	WB/ODDB	
SDL-C133	CUBIC	2.65529561	-0.08409809	0.00147869	-0.00000933	0.0000000	0.0000000	HEAT-EIR-LS-FT	RESVVT†	ODDB	
SDL-C134	LINEAR	-0.09729726	1.09729731	0.0000000	0.0000000	0.0000000	0.0000000	COOL-EIR-FRPM	RESVVT	RPM	
SDL-C135	LINEAR	0.0000000	1.0000000	0.0000000	0.0000000	0.0000000	0.0000000	†			
SDL-C136	BI-QUAD	1.0000000	0.0000000	0.0000000	0.0000000	0.0000000	0.0000000	COOL-WH-FT	RESVVT	EDB	
SDL-C137	QUAD	1.0000000	0.0000000	0.0000000	0.0000000	0.0000000	0.0000000	COOL-WH-FRPM	RESVVT	RPM	
SDL-C138	LINEAR	0.0000000	1.0000000	0.0000000	0.0000000	0.0000000	0.0000000	COOL-CFM-FPLR	RESVVT	-	
SDL-C139	LINEAR	1.0000000	0.0000000	0.0000000	0.0000000	0.0000000	0.0000000	OUTSIDE-FAN-CFLT	RESVVT	-	
SDL-C140	LINEAR	0.00280108	0.9971990	0.0000000	0.0000000	0.0000000	0.0000000	HEAT-EIR-FRPM	RESVVT	RPM	
SDL-C141	BI-LINEAR	0.0000000	0.0000000	0.0000000	0.0000000	0.0000000	0.0000000	†			
SDL-C142	BI-QUAD	1.0000000	0.0000000	0.0000000	0.0000000	0.0000000	0.0000000	HEAT-WH-FT	RESVVT	WB/ODDB	
SDL-C143	QUAD	1.0000000	0.0000000	0.0000000	0.0000000	0.0000000	0.0000000	HEAT-WH-FRPM	RESVVT	WB/ODDB	
SDL-C144	BI-LINEAR	0.0000000	0.0000000	0.0000000	0.0000000	0.0000000	0.0000000	HEAT-CFM-FPLR	RESVVT	-	
SDL-C145	LINEAR	1.0000000	0.0000000	0.0000000	0.0000000	0.0000000	0.0000000	OUTSIDE-FAN-HFLT	RESVVT	CYC-PLR	
SDL-C146	LINEAR	0.7500000	0.2500000	0.0000000	0.0000000	0.0000000	0.0000000	HEAT-CLOSS-FPLR	RESVVT	CYC-PLR	
SDL-C147	LINEAR	0.7000000	0.3000000	0.0000000	0.0000000	0.0000000	0.0000000	COOL-CLOSS-FPLR	RESVVT	CYC-PLR	
SDL-C148	LINEAR	0.0333000	0.0000000	0.0000000	0.0000000	0.0000000	0.0000000	DEFROST-FRAC-FT	HPDefrst,RESYS, PSZ,PMZS	OWB/ODDB	
SDL-C149	LINEAR	1.0000000	0.0000000	0.0000000	0.0000000	0.0000000	0.0000000	DEFROST-CAP-FT	HPDefrst,RESYS, PSZ,PMZS, PTAC,PVVT	OWB/ODDB	
SDL-C150	LINEAR	1.0000000	0.0000000	0.0000000	0.0000000	0.0000000	0.0000000	DEFROST-PWR-FT	HPDefrst,RESYS, PSZ,PMZS, PTAC,PVVT	OWB/ODDB	
SDL-C151	QUAD	-0.12178216	1.84937334	-0.7275877	0.0000000	0.0000000	0.0000000	COOL-CAP-FRPM	RESVVT	RPM	
SDL-C152	QUAD	-0.1170394	1.63974738	-0.52271318	0.0000000	0.0000000	0.0000000	HEAT-CAP-FRPM	RESVVT	RPM	

SYSTEM-EQUIPMENT DEFAULT CURVES (continued)

Default Curve u-name	Type of Curve	-----Default Curve Coefficients-----										Keyword	Applicable SYSTEM-TYPE* [*see definitions at end of table]	Independent Variable(s)*
		a	b	c	d	e	f	g	h	i	j			
SDL-C153	LINEAR	1.0000000	0.0000000	0.0000000	0.0000000	0.0000000	0.0000000	0.0000000	0.0000000	0.0000000	0.0000000	†	HP	PLR
SDL-C154	LINEAR	1.0000000	0.0000000	0.0000000	0.0000000	0.0000000	0.0000000	0.0000000	0.0000000	0.0000000	0.0000000	HEAT-CLOSS-FPLR	HP	PLR
SDL-C155	LINEAR	1.0000000	0.0000000	0.0000000	0.0000000	0.0000000	0.0000000	0.0000000	0.0000000	0.0000000	0.0000000	COOL-CLOSS-FPLR	HP	PLR
SDL-C156	LINEAR	1.0000000	0.0000000	0.0000000	0.0000000	0.0000000	0.0000000	0.0000000	0.0000000	0.0000000	0.0000000	†		
SDL-C157	LINEAR	1.0000000	0.0000000	0.0000000	0.0000000	0.0000000	0.0000000	0.0000000	0.0000000	0.0000000	0.0000000	†		
SDL-C158	LINEAR	0.0000000	0.0000000	0.0000000	0.0000000	0.0000000	0.0000000	0.0000000	0.0000000	0.0000000	0.0000000	DEFROST-FRAC-FT	HPDefrst	OWB/ODB
SDL-C159	LINEAR	1.0000000	0.0000000	0.0000000	0.0000000	0.0000000	0.0000000	0.0000000	0.0000000	0.0000000	0.0000000	DEFROST-CAP-FT	HPDefrst	OWB/ODB
SDL-C160	LINEAR	1.0000000	0.0000000	0.0000000	0.0000000	0.0000000	0.0000000	0.0000000	0.0000000	0.0000000	0.0000000	DEFROST-PWR-FT	HPDefrst	OWB/ODB
SDL-C161	LINEAR	0.0000000	1.0000000	0.0000000	0.0000000	0.0000000	0.0000000	0.0000000	0.0000000	0.0000000	0.0000000	COIL-BF-FPLR	SZRH,MZS,DDS, SZCI,FPH, TFPC,FPC, TPIU,FPIU, VAVS,RHFS, CBVAV,PIU	PLR
SDL-C162	LINEAR	1.0000000	0.0000000	0.0000000	0.0000000	0.0000000	0.0000000	0.0000000	0.0000000	0.0000000	0.0000000	†		
SDL-C163	LINEAR	1.0000000	0.0000000	0.0000000	0.0000000	0.0000000	0.0000000	0.0000000	0.0000000	0.0000000	0.0000000	†		
SDL-C164	LINEAR	0.0000000	1.0000000	0.0000000	0.0000000	0.0000000	0.0000000	0.0000000	0.0000000	0.0000000	0.0000000	COOL-EIR-FRPM	RESYS,PSZ, PMZS,PVAVS, PTAC,PVVT	RPM/EDB†
SDL-C165	no type	0.0000000	1.0000000	0.0000000	0.0000000	0.0000000	0.0000000	0.0000000	0.0000000	0.0000000	0.0000000	†		
SDL-C166	LINEAR	1.0000000	0.0000000	0.0000000	0.0000000	0.0000000	0.0000000	0.0000000	0.0000000	0.0000000	0.0000000	COOL-WH-FT	RESYS,PSZ, PMZS,PVAVS, PTAC,PVVT	RPM/EDB†
SDL-C167	LINEAR	1.0000000	0.0000000	0.0000000	0.0000000	0.0000000	0.0000000	0.0000000	0.0000000	0.0000000	0.0000000	COOL-WH-FRPM	RESYS,PSZ, PMZS,PVAVS, PTAC,PVVT	RPM/EDB†
SDL-C168	LINEAR	0.0000000	1.0000000	0.0000000	0.0000000	0.0000000	0.0000000	0.0000000	0.0000000	0.0000000	0.0000000	COOL-CFM-FPLR	RESYS,PSZ, PMZS,PVAVS, PTAC,PVVT	PLR
SDL-C169	LINEAR	1.0000000	0.0000000	0.0000000	0.0000000	0.0000000	0.0000000	0.0000000	0.0000000	0.0000000	0.0000000	OUTSIDE-FAN-CFLT	RESYS,PSZ, PMZS,PVAVS, PTAC,PVVT	PLR/EDB
SDL-C170	BI-LINEAR	0.0000000	1.0000000	0.0000000	0.0000000	0.0000000	0.0000000	0.0000000	0.0000000	0.0000000	0.0000000	HEAT-EIR-FRPM	RESYS,PSZ, PMZS,PVAVS, PTAC,PVVT	RPM
SDL-C171	no type	0.0000000	0.0000000	0.0000000	0.0000000	0.0000000	0.0000000	0.0000000	0.0000000	0.0000000	0.0000000	†		
SDL-C172	LINEAR	1.0000000	0.0000000	0.0000000	0.0000000	0.0000000	0.0000000	0.0000000	0.0000000	0.0000000	0.0000000	HEAT-WH-FT	RESYS,PSZ, PMZS,PVAVS,	ODB/DB

SYSTEM-EQUIPMENT DEFAULT CURVES (continued)

Default Curve u-name	Type of Curve	-----Default Curve Coefficients-----										Applicable SYSTEM-TYPE*	Independent Variable(s)*
		a	b	c	d	e	f	Keyword					
SDL-C173	LINEAR	1.0000000	0.0000000	0.0000000	0.0000000	0.0000000	0.0000000	HEAT-WH-FRPM			PTAC,PVVT RESYS,PSZ, PMZS,PVAVS, PTAC,PVVT	RPM,ODB	
SDL-C174	BI-LINEAR	0.0000000	1.0000000	0.0000000	0.0000000	0.0000000	0.0000000	HEAT-CFM-FPLR			RESYS,PSZ, PMZS,PVAVS, PTAC,PVVT	PLR	
SDL-C175	LINEAR	1.0000000	0.0000000	0.0000000	0.0000000	0.0000000	0.0000000	OUTSIDE-FAN-HFLT			RESYS,PSZ, PMZS,PVAVS, PTAC,PVVT	PLR/ODB	
SDL-C176	LINEAR	0.7500000	0.2500000	0.0000000	0.0000000	0.0000000	0.0000000	HEAT-CLOSS-FPLR			RESYS,PSZ, PMZS,PVAVS, PTAC,PVVT	PLR	
SDL-C177	LINEAR	0.7000000	0.3000000	0.0000000	0.0000000	0.0000000	0.0000000	COOL-CLOSS-FPLR			RESYS,PSZ, PMZS,PVAVS, PTAC,PVVT	PLR	
SDL-C178	LINEAR	0.0000000	0.0000000	0.0000000	0.0000000	0.0000000	0.0000000	DEFROST-FRAC-FT			HPDefrst	OWB/ODB	
SDL-C179	LINEAR	1.0000000	0.0000000	0.0000000	0.0000000	0.0000000	0.0000000	DEFROST-CAP-FT			HPDefrst	OWB/ODB	
SDL-C180	LINEAR	0.0000000	0.0000000	0.0000000	0.0000000	0.0000000	0.0000000	DEFROST-PWR-FT			HPDefrst	OWB/ODB	
SDL-C181	LINEAR	0.0000000	1.0000000	0.0000000	0.0000000	0.0000000	0.0000000	COOL-CAP-FRPM			RESYS,PSZ, PMZS,PVAVS, PTAC,PVVT	RPM/EDB††	
SDL-C182	BI-LINEAR	0.0000000	1.0000000	0.0000000	0.0000000	0.0000000	0.0000000	HEAT-CAP-FRPM			RESYS,PSZ, PTAC,PVVT	RPM/ODB	
SDL-C183	LINEAR	1.0000000	0.0000000	0.0000000	0.0000000	0.0000000	0.0000000	†					
SDL-C184	LINEAR	1.0000000	0.0000000	0.0000000	0.0000000	0.0000000	0.0000000	†					
SDL-C185	LINEAR	1.0000000	0.0000000	0.0000000	0.0000000	0.0000000	0.0000000	†					
SDL-C186	LINEAR	1.0000000	0.0000000	0.0000000	0.0000000	0.0000000	0.0000000	†					
SDL-C187	LINEAR	1.0000000	0.0000000	0.0000000	0.0000000	0.0000000	0.0000000	†					
SDL-C188	LINEAR	0.0000000	0.0000000	0.0000000	0.0000000	0.0000000	0.0000000	DEFROST-FRAC-FT			HPDefrst	OWB/ODB	
SDL-C189	LINEAR	1.0000000	0.0000000	0.0000000	0.0000000	0.0000000	0.0000000	DEFROST-CAP-FT			HPDefrst	OWB/ODB	
SDL-C190	LINEAR	1.0000000	0.0000000	0.0000000	0.0000000	0.0000000	0.0000000	DEFROST-PWR-FT			HPDefrst	OWB/ODB	
SDL-C191	LINEAR	0.0000000	1.0000000	0.0000000	0.0000000	0.0000000	0.0000000	COIL-BF-FPLR			GHP	PLR	
SDL-C192	LINEAR	1.0000000	0.0000000	0.0000000	0.0000000	0.0000000	0.0000000	†					
SDL-C193	BI-QUAD	0.7006023	0.2980410	0.0013554	0.0000000	0.0000000	0.0000000	†					
SDL-C194	QUAD	-0.0059824	1.4111446	-0.4051616	0.0000000	0.0000000	0.0000000	COOL-EIR-FRPM			GHP	RPM/EDB††	
SDL-C195	no type	0.0000000	1.0000000	0.0000000	0.0000000	0.0000000	0.0000000	†					
SDL-C196	LINEAR	1.0000000	0.0000000	0.0000000	0.0000000	0.0000000	0.0000000	COOL-WH-FT			GHP	DB/EDB	

SYSTEM-EQUIPMENT DEFAULT CURVES (continued)

Default Curve u-name	Type of Curve	-----Default Curve Coefficients-----										Applicable SYSTEM-TYPE* [*see definitions at end of table]	Independent Variable(s)* at end of table]
		a	b	c	d	e	f	g	h	i	Keyword		
SDL-C197	LINEAR	1.0000000	0.0000000	0.0000000	0.0000000	0.0000000	0.0000000	0.0000000	0.0000000	0.0000000	COOL-WH-FRPM	GHP	RPM/EDB††
SDL-C198	LINEAR	0.0000000	0.0000000	0.0000000	0.0000000	0.0000000	0.0000000	0.0000000	0.0000000	0.0000000	COOL-CFM-FPLR	GHP	-
SDL-C199	LINEAR	1.0000000	0.0000000	0.0000000	0.0000000	0.0000000	0.0000000	0.0000000	0.0000000	0.0000000	OUTSIDE-FAN-CFLT	GHP	PLR/EDB
SDL-C200	QUAD	0.2125741	0.6172991	0.1701274	0.0000000	0.0000000	0.0000000	0.0000000	0.0000000	0.0000000	HEAT-EIR-FRPM	GHP	RPM/ODB
SDL-C201	no type	0.0000000	0.0000000	0.0000000	0.0000000	0.0000000	0.0000000	0.0000000	0.0000000	0.0000000	†	GHP	ODB/DB
SDL-C202	LINEAR	1.0000000	0.0000000	0.0000000	0.0000000	0.0000000	0.0000000	0.0000000	0.0000000	0.0000000	HEAT-WH-FT	GHP	RPM/DB
SDL-C203	LINEAR	1.0000000	0.0000000	0.0000000	0.0000000	0.0000000	0.0000000	0.0000000	0.0000000	0.0000000	HEAT-WH-FRPM	GHP	-
SDL-C204	BI-LINEAR	0.0000000	1.0000000	0.0000000	0.0000000	0.0000000	0.0000000	0.0000000	0.0000000	0.0000000	HEAT-CFM-FPLR	GHP	PLR, ODB
SDL-C205	LINEAR	1.0000000	0.0000000	0.0000000	0.0000000	0.0000000	0.0000000	0.0000000	0.0000000	0.0000000	OUTSIDE-FAN-HFLT	GHP	PLR
SDL-C206	LINEAR	0.8200000	0.1800000	0.0000000	0.0000000	0.0000000	0.0000000	0.0000000	0.0000000	0.0000000	HEAT-CLOSS-FPLR	GHP	PLR
SDL-C207	LINEAR	0.8200000	0.1800000	0.0000000	0.0000000	0.0000000	0.0000000	0.0000000	0.0000000	0.0000000	COOL-CLOSS-FPLR	GHP	OWB/ODB
SDL-C208	LINEAR	0.0333000	0.0000000	0.0000000	0.0000000	0.0000000	0.0000000	0.0000000	0.0000000	0.0000000	DEFROST-FRAC-FT	GHP	OWB/ODB
SDL-C209	LINEAR	1.0000000	0.0000000	0.0000000	0.0000000	0.0000000	0.0000000	0.0000000	0.0000000	0.0000000	DEFROST-CAP-FT	GHP	OWB/ODB
SDL-C210	LINEAR	1.0000000	0.0000000	0.0000000	0.0000000	0.0000000	0.0000000	0.0000000	0.0000000	0.0000000	DEFROST-PWR-FT	GHP	OWB/ODB
SDL-C211	QUAD	0.1916220	1.2099284	-0.4015489	0.0000000	0.0000000	0.0000000	0.0000000	0.0000000	0.0000000	COOL-CAP-FRPM	GHP	RPM/EDB††
SDL-C212	QUAD	0.3562899	0.5057386	0.1379728	0.0000000	0.0000000	0.0000000	0.0000000	0.0000000	0.0000000	HEAT-CAP-FRPM	GHP	RPM/ODB††
SDL-C213	LINEAR	1.0000000	0.0000000	0.0000000	0.0000000	0.0000000	0.0000000	0.0000000	0.0000000	0.0000000	†		
SDL-C214	LINEAR	1.0000000	0.0000000	0.0000000	0.0000000	0.0000000	0.0000000	0.0000000	0.0000000	0.0000000	†		
SDL-C215	LINEAR	1.0000000	0.0000000	0.0000000	0.0000000	0.0000000	0.0000000	0.0000000	0.0000000	0.0000000	†		
SDL-C216	LINEAR	1.0000000	0.0000000	0.0000000	0.0000000	0.0000000	0.0000000	0.0000000	0.0000000	0.0000000	†		
SDL-C217	LINEAR	1.0000000	0.0000000	0.0000000	0.0000000	0.0000000	0.0000000	0.0000000	0.0000000	0.0000000	†		
SDL-C218	LINEAR	1.0000000	0.0000000	0.0000000	0.0000000	0.0000000	0.0000000	0.0000000	0.0000000	0.0000000	†		
SDL-C219	LINEAR	1.0000000	0.0000000	0.0000000	0.0000000	0.0000000	0.0000000	0.0000000	0.0000000	0.0000000	†		
SDL-C220	LINEAR	1.0000000	0.0000000	0.0000000	0.0000000	0.0000000	0.0000000	0.0000000	0.0000000	0.0000000	†		

† Unused curve

†† Default curve for air source electric and gas heat pumps do not use the DB dependence capability; default curves for gas heat pumps do not use EDB dependence capability

\* Independent Variables are defined as follows:

- APP -- approach
- ARCELL -- number of cooling tower units per cell
- CFM -- flow (cfm)

SYSTEM-EQUIPMENT DEFAULT CURVES (continued)

- CFM-PLR -- (flow over coil)/(design or rated flow)(fraction)
- CYC-PLR -- cycling part load ratio =  $\frac{\text{cooling load}}{\text{cooling load at initiation of cycling}}$
- DB -- entering coil dry-bulb temperature (°F)
- EDB -- outside drybulb temperature, evaporative precooler exit temperature when CONDENSER-TYPE-EVAP-PRECOOLED (°F)
- GHP -- PSZ, PVAVS, PVVT, PTAG, or RESYS system when HEAT-SOURCE-GAS-HEAT-PUMP
- HPDefrost -- system with heat pump defrost
- ODB -- outside dry-bulb temperature (°F)
- OWB -- outside wet-bulb temperature (°F)
- PLR -- part-load ratio (fraction)
- RF -- rating factor
- RNG -- range, temperature drop through tower
- RPM -- variable speed compressor (rpm)
- TTWR -- cooling tower temperature (°F)
- WB -- entering coil wet-bulb temperature (°F)
- WB1 -- outside air wet-bulb temperature (°F)
- WB6 -- return air wet-bulb temperature (°F)
- WT -- entering water temperature (°F)
- WTR-CC -- PSZ, PVAVS, or PVVT system with CONDENSER-TYPE-WATER-COOLED

# P L A N T

## Table of Contents

---

<b>ENERGY METERS IN PLANT .....</b>	<b>4. 3</b>
Introduction .....	4. 3
Example: Gas Cooling Rate.....	4. 4
<b>GAS FIRED ABSORPTION CHILLER .....</b>	<b>4. 8</b>
Introduction .....	4. 8
<b>ENGINE DRIVEN COMPRESSION CHILLER.....</b>	<b>4.11</b>
Introduction .....	4.11
<b>ICE AND EUTECTIC THERMAL ENERGY STORAGE.....</b>	<b>4.15</b>
Introduction .....	4.15
Hourly Reports .....	4.22
Examples of Thermal Energy Storage .....	4.22
1: Full-storage brine system .....	4.22
2: Partial storage ice-on-coil system with screw-type chillers.....	4.25
3: Ice harvester system .....	4.29
Discussion.....	4.32
User-Specified Sizing.....	4.32
Automatic Sizing.....	4.33
Pumping.....	4.35
Curves.....	4.36
Other parameters.....	4.36
Seven-day cycle.....	4.36
<b>IMPROVED COOLING TOWER MODEL.....</b>	<b>4.37</b>
Discussion.....	4.37
<b>REVISED CIRCULATION PUMP SIMULATIONS.....</b>	<b>4.45</b>
Introduction .....	4.45
<b>PLANT EQUIPMENT OPERATING MODES.....</b>	<b>4.47</b>
Introduction .....	4.47
Note on the Default Operation of Chillers .....	4.49
Examples of Plant Equipment Operating Modes.....	4.51
1: Chillers, Gas Turbine, and Boiler.....	4.51
2: Chillers, Diesel Generator, and Boiler .....	4.52
3: Scheduling of Cogeneration Modes .....	4.53

Supplement – 2.1E Update

<b>ELECTRICAL GENERATOR SIMULATIONS</b> .....	4.54
Introduction.....	4.54
Gas Turbine.....	4.56
Steam Turbine.....	4.57
<b>PLANT OPERATING STRATEGIES</b> .....	4.59
Introduction.....	4.59
<b>Input Descriptions for Typical Plant Configurations</b> .....	4.61
1: No plant - all heating and cooling by packaged units in SYSTEMS .....	4.61
2: A simple plant with boiler, chiller and domestic hot water heater .....	4.62
3: Heat recovery from a double bundle chiller .....	4.63
4: Heat recovery from an engine driven chiller .....	4.64
5: Sequencing of two differently-sized boilers .....	4.65
6: Lead-lag operation of two differently-sized chillers.....	4.66
7: Using an absorption chiller for peak shaving electric demand .....	4.67
8: Using a natural-gas engine generator for peak shaving, etc.....	4.69
9: Sequencing the operation of gas turbine and diesel engine, etc.....	4.71
10: Recovering heat from a diesel generator engine jacket, etc.....	4.72
11: A cogeneration system that recovers heat, etc. ....	4.74
12: A cogeneration system that provides recovered heat, etc. ....	4.76
<b>PLANT Reports</b> .....	4.80
<b>EQUIPMENT—QUAD Default Curves</b> .....	4.81



Supplement — 2.1E Update

**Example: Gas Cooling Rate**

Many gas utilities offer rates for separately metered gas cooling equipment. In the following example an absorption chiller is simulated.

**\$ FUEL METER IN PLANT \$**

```
INPUT PLANT ..
ABS-1 = PLANT-EQUIPMENT
      TYPE           = ABSORG-CHLR $ Direct fired two-stage
                        $ absorption chiller
      SIZE           = 1.2
      INSTALLED-NUMBER = 3
      FUEL-METER     = M3 ..
```

END ..

COMPUTE PLANT ..

INPUT ECONOMICS ..

```
GASCL = UTILITY-RATE
      RESOURCE = NATURAL-GAS
      METER    = (M3) $ Attaches energy used by the
                        $ absorption chiller to this rate
      MONTH-CHGS = (4)
      ENERGY-CHG = 0.3 ..
```

```
OTHER = UTILITY-RATE $ for all non-cooling gas
      RESOURCE = NATURAL-GAS
      METER    = (M1) $ default meter for all
                        $ other gas equipment
      ENERGY-CHG = 0.45 ..
```

PLANT-PARAMETERS

New keywords have been added to allow the electrical usage of hot-water pumps, chilled-water pumps and miscellaneous pumps to be assigned. They are

HCIRC-ELEC-METER      accepts the inputs of M1, M2, M3, M4 or M5. The default is meter M1.

CCIRC-ELEC-METER      accepts the inputs of M1, M2, M3, M4 or M5. The default is meter M1.

MISC-ELEC-METER        accepts the inputs of M1, M2, M3, M4 or M5. The default is meter M1.

## ENERGY METERS IN PLANT

### Introduction

The use of electrical meters in PLANT is straightforward and a continuation of the material covered in SYSTEMS (see "Specifying Meters in SYSTEMS", p.3.8). The ELEC-METER keyword is specified under the PLANT-EQUIPMENT command and the program takes care of the rest. Electrical meters for pumps and miscellaneous equipment are specified under the PLANT-PARAMETERS command.

Fuel meters are slightly more complex. As with electricity, the fuel meter is specified under the PLANT-EQUIPMENT command. The actual fuel associated with each fuel meter is specified under the ENERGY-RESOURCE command or it defaults to NATURAL-GAS. A total of five meters are allowed, and each of these meters may be associated with any of the fossil fuel RESOURCES (NATURAL-GAS, LPG, DIESEL-OIL, FUEL-OIL, COAL, METHANOL or OTHER-FUEL).

### PLANT-EQUIPMENT

The PLANT-EQUIPMENT command has two new keywords to assign electrical and/or fuel consumption to the meters. They are:

- |            |  |
|------------|--|
| ELEC-METER | specifies the meter for the electrical consumption of this type of equipment. Acceptable values are M1, M2, M3, M4 or M5. The default is M1.   |
| FUEL-METER | Specifies the meter for the fuel consumption of this type of equipment. Acceptable values are M1, M2, M3, M4 or M5, and the default is M1. Each PLANT-EQUIPMENT command may reference a different FUEL-METER representing different fuels or rate schedules. |

In PLANT, power consumption is specific to the PLANT-EQUIPMENT specified. Cooling tower power consumption includes the energy of the condenser pumps. The meters for other pump energy and miscellaneous energy is specified in the following new PLANT-PARAMETERS keywords. An equipment type may have both an electric and fuel meter. For example, a boiler may have a gas meter for fuel consumption and an electric meter for a draft fan. All equipment of the same TYPE but of different SIZEs must have the same meters. By specifying meters at the equipment level in PLANT, different types of equipment can be on different meters. For example, chillers that are used exclusively for ice-making can be on a meter separate from the rest of the building. In ECONOMICS, this meter can then be linked to a separate electrical UTILITY-RATE which has charges favorable to making ice at night.

To simulate a boiler with fuel switching capability, specify two boilers and assign them to different fuel meters. Put each boiler in a separate LOAD-ASSIGNMENT, and use the ASSIGN-SCHEDULE keyword of LOAD-MANAGEMENT to specify when each boiler is used.

## Supplement - 2.1E Update

Because fuel meters are now specified under the PLANT-EQUIPMENT command, the following keywords have been eliminated:

ABSORG-FUEL  
BOILER-FUEL  
DHW-HEATER-FUEL  
DIESEL-FUEL  
ENG-CH-FUEL  
FURNACE-FUEL  
GTURB-FUEL

In the PLANT module, electrical and fuel meters are defined for each type of equipment via new keywords in the PLANT-EQUIPMENT command. Several miscellaneous meters for pumps are included in the PLANT-PARAMETERS command. Finally, the ENERGY-RESOURCE command is used to link one or more fuel RESOURCES to the fuel meters used in both SYSTEMS and PLANT.

### ENERGY-RESOURCE

This command has several new keywords that link fuel RESOURCES to fuel meters. In addition, you can specify the names of the energy and demand units used in the reports. For the sake of completeness, both existing and new keywords are described herein:

#### RESOURCE

Accepts the code-words of STEAM, CHILLED-WATER, ELECTRICITY, NATURAL-GAS, LPG, DIESEL-OIL, FUEL-OIL, COAL, METHANOL, or OTHER-FUEL. The old code-word BIOMASS has been eliminated (but see OTHER-FUEL-NAME). Note that, as with the DOE-2.1D command, an ENERGY-RESOURCE command must be entered if a steam/hot-water (code-word STEAM) or CHILLED-WATER utility is to be used.

#### SOURCE-SITE-EFF

Accepts a numeric value, which indicates the generating efficiency of the fuel or utility prior to its use in the facility being simulated. Failure to specify an ENERGY-RESOURCE command for a fuel or utility will result in the use of the default values listed in Table 4.1.

#### FUEL-METERS

for fossil fuels only, accepts a list in parentheses of up to five fuel meters that link to this resource. Acceptable input values are M1 (the default), M2, M3, M4 or M5. Any or all of the meters may be listed in any order. For example, if both COAL and LPG are used in a facility, two ENERGY-RESOURCE commands should be input, one for COAL and the other for LPG. The COAL resource may be assigned to FUEL-METERS (1,2,5), and the LPG resource to FUEL-METERS (3,4). If any FUEL-METERS are referenced in the SYSTEMS or PLANT-EQUIPMENT commands, but are not listed in an ENERGY-RESOURCE, they will default

Supplement - 2.1E Update

to a fuel that has been defined in an ENERGY-RESOURCE command. *If no fuels have been defined, all meters will default to NATURAL-GAS.*

ENERGY/UNIT

Accepts a numeric value that indicates the Btu per billing unit for this RESOURCE. Report PS-B in PLANT and all ECONOMICS utility-rate reports will report consumption in these units. Default values are listed in Table 4.1.

UNIT-NAME

accepts an alphanumeric string of up to eight characters that defines the name of the energy unit used for billing purposes. The defaults are shown in Table 4.1. For example, if you want FUEL-OIL consumption to be reported in barrels rather than gallons, the word BARRELS should be entered here.

DEM-UNIT-NAME

accepts an alphanumeric string of up to eight characters that defines the name of the demand units used in billing purposes. The defaults are shown in Table 4.1. For example, energy and demand units for ELECTRICITY are kWh and kW respectively.

OTHER-FUEL-NAME

when RESOURCE = OTHER-FUEL, accepts an alphanumeric string of up to 16 characters that describes the fuel. The default description is BIOMASS. This description will be substituted for the normal name of the RESOURCE in the reports.

**Example**

Assume a facility is to be heated using wood pellets. The pellets are bought by the ton, and have a fuel content of 30 million Btu/ton. Acceptable input might be:

ENERGY-RESOURCE	RESOURCE	= OTHER-FUEL
	OTHER-FUEL-NAME	= WOOD-PELLETS
	SOURCE-SITE-EFF	= 1.0
	ENERGY/UNIT	= 30000000
	UNIT-NAME	= TONS
	DEM-UNIT-NAME	= TONS/HR

..

In this example, no meters were specified and it is assumed that no other ENERGY-RESOURCE commands were defined for other fossil fuels. If so, all fuel meters will default to WOOD-PELLETS.

As before, a total up to five RESOURCES may be defined. While there can be up to five electrical meters, these all count as one resource, i.e. ELECTRICITY. Similarly, any number of FUEL-METERS sharing a common resource such as NATURAL-GAS count as one RESOURCE toward the limit.

Table 4.1

English Default UNIT Values for ENERGY-RESOURCE

RESOURCE	SOURCE-SITE-EFF	ENERGY/UNIT	English	
		Btu	UNIT-NAME	DEM-UNIT-NAME
STEAM	0.6	1,000,000	MBTU	MBTU/HR
CHILLED-WATER	1.5	12,000	TON-HR	TONS
ELECTRICITY	0.3333	3,412.969	KWH	KW
NATURAL-GAS	1.0	100,000	THERM	THERMS/HR
LPG	1.0	95,500	GALLON	GALLONS/HR
FUEL-OIL	1.0	138,700	GALLON	GALLONS/HR
DIESEL-OIL	1.0	138,700	GALLON	GALLONS/HR
COAL	1.0	24,580,000	TON	TONS/HR
METHANOL	1.0	63,500	GALLON	GALLONS/HR
OTHER-FUEL	1.0	1,000,000	MBTU	MBTU/HR
ELEC-NET-SALE	calculated	3,412.969	KWH	KW
ELEC-BUY/SELL	calculated	3,412.969	KWH	KW

Metric Default UNIT Values for ENERGY-RESOURCE

RESOURCE	SOURCE-SITE-EFF	ENERGY/UNIT	Metric	
		Btu	UNIT-NAME	DEM-UNIT-NAME
STEAM	0.6	1,000,000	MWH	MW
CHILLED-WATER	1.5	1,000,000	MWH	MW
ELECTRICITY	0.3333	1,000	KWH	KW
NATURAL-GAS	1.0	10,871	M3	M3/HR
LPG	1.0	7,383	LITER	LITERS/HR
FUEL-OIL	1.0	10,723	LITER	LITERS/HR
DIESEL-OIL	1.0	10,723	LITER	LITERS/HR
COAL	1.0	7,940,396	TONNE	TONNES/HR
METHANOL	1.0	4,909	LITER	LITERS/HR
OTHER-FUEL	1.0	1,000,000	MWH	MW
ELEC-NET-SALE	calculated	1,000	KWH	KW
ELEC-BUY/SELL	calculated	1,000	KWH	KW

## GAS FIRED ABSORPTION CHILLER

### Introduction

A model of a direct fired two-stage absorption chiller with optional heating capability was added to the PLANT subprogram in DOE-2.1D. These units are now available in sizes ranging from 100 to 1500 tons; the units can burn either gas or oil.

To simulate a direct fired absorption chiller, you must first specify it with the code-word ABSORG—CHLR in the PLANT—EQUIPMENT command. For instance:

DF—CHLR = PLANT—EQUIPMENT TYPE=ABSORG—CHLR SIZE=1.5 ..

Like the usual two-stage absorption chiller in DOE-2 (ABSOR2—CHLR), the unit is modeled with a full load, standard condition heat input ratio (HIR), modified by a set of curves, as well as an electric input ratio (EIR) for auxiliary power. The HIR can be specified with the keyword ABSORG—HIR in the PLANT—PARAMETERS command; the default is 1.0. Standard conditions are defined to be 85°F entering condenser temperature and 44°F leaving chilled water temperature. In the simulation the HIR is modified by the following curves:

Keyword	Independent Variables	Coefficients					
		(a)	(b)	(c)	(d)	(e)	(f)
ABSORG—HIR—FT	leaving chilled water temp.	4.42871284	-.13298607	.00125331	0	0	0
ABSORG—HIR1—FTI	condenser temperature	.86173749	-.00708917	.00010251	0	0	0
ABSORG—HIR—FPLR	part load ratio	.13551150	.61798084	.24651277	0	0	0

The curves are all quadratic in the independent variable. The HIR at the operating point is the result of multiplying ABSORG—HIR by these curves.

The fuel used is the HIR times the capacity times the fraction of the hour the unit is on. The capacity is the size specified by the input (SIZE keyword in the PLANT—EQUIPMENT command) modified by following curve:

Keyword	Independent Variables	Coefficients					
		(a)	(b)	(c)	(d)	(e)	(f)
ABSORG—CAP—FT	leaving chilled water temp. and condenser temperature	1.0	0.	0.	0.	0.	0.

The curve is bi-quadratic. For now, the default curve does nothing, since no data on its shape is available.

The gas fired absorption chiller model in DOE-2.1D was developed with the support and collaboration of the Gas Research Institute and ElectroCOM GARD, Ltd.

## Supplement — 2.1E Update

One final curve is used in the model. The chiller can optionally operate as a heater. The heating capacity is specified with the ABSORG-HCAPR keyword in the PLANT-PARAMETERS command. This keyword is the heat capacity ratio (the heat capacity of the unit divided by the cooling capacity). The default is 1.0; heating and cooling capacity are equal. When the unit is simultaneously cooling and heating, the available heating capacity is a function of the cooling load. This relationship is expressed by the following curve:

Keyword	Independent Variables	Coefficients					
		(a)	(b)	(c)	(d)	(e)	(f)
ABSG-HCAP-FQC	cooling load	.863599	-1.30495346	.44135284	0.	0.	0.

This curve is quadratic. All the curves are keywords in the EQUIPMENT-QUAD command. They can be changed by using the keyword to reference the u-name of a CURVE-FIT command.

Several inputs to the model are accessed via the PART-LOAD-RATIO command. The most important is the electric input ratio (EIR) and is input with the ELEC-INPUT-RATIO keyword. The default is .0071 in units of Btuh/Btuh, the numerator being the electric power input to the unit and the denominator the nominal cooling capacity of the unit. This ratio can vary significantly depending on the size of the unit. The default is for a 600 ton unit. For a 100 ton unit .014 would be appropriate and for 1400 tons .0053 could be used. Other keywords input through this command are MIN-RATIO and MAX-RATIO. The MIN-RATIO (default = 0.1) is the minimum operating ratio for the unit. Below this ratio, the unit cycles on and off. The MAX-RATIO (default = 1.15) is the maximum ratio at which the program allows the unit to operate.

Finally, there is another relevant keyword in the PLANT-PARAMETERS command.

### PLANT-PARAMETERS

**ABSORG-FUEL-XEFF** is the effectiveness of the hot water heat exchanger used in the heating mode; the default is 0.8.

The chiller always meets the cooling load first. The available heating capacity is then calculated and is used to meet the space heating and domestic hot water loads. The heat from the direct fired absorption chiller cannot be assigned via the HEAT-RECOVERY command. The chiller can be operated through the LOAD-MANAGEMENT and LOAD-ASSIGNMENT commands, and this is recommended if there are multiple chillers. The program cannot optimize the operation of the direct fired chiller in conjunction with compression or other types of absorption chillers. The only default mode of operation of the direct fired chiller is that it is used in preference to any other chiller or heat source.

**DESICCANT-XEFF** is the effectiveness of the direct-fired gas absorption chiller heat exchanger when used to provide recovered heat for regenerating the LIQ-VENT-AIR-2 desiccant cooling system (see description of the REG-HEAT-SOURCE keyword in ADD-ON (INTEGRATED) DESICCANT COOLING, p.3.76).

Supplement — 2.1E Update

In summary, the keywords relevant to the direct fired absorption chiller input are:

under the <b>PLANT-PARAMETERS</b> command:						
Keyword	Abbr	Type	Unit	Default	Min	Max
ABSORG-HIR	none	numeric	frac.	1.0	0.0	3.0
ABSORG-HCAPR	none	numeric	frac.	1.0	0.	2.
ABSORG-HEAT-XEFF	none	numeric	frac.	0.8	0.1	1.0

under the <b>EQUIPMENT-QUAD</b> command:						
Keyword	Abbr	Type	Unit	Default	Min	Max
ABSORG-HIR-FT	none	curve		HIRT3		
ABSORG-HIR1-FTI	none	curve		HIRTI1		
ABSORG-HIR-FPLR	none	curve		HIRPLR3		
ABSG-HCAP-FQC	none	curve		HCAPQC		
ABSORG-CAP-FT	none	curve		ACAPT3		

under the <b>PART-LOAD-RATIO</b> command:						
Keyword	Abbr	Type	Unit	Default	Min	Max
ELEC-INPUT-RATIO	E-I-R	numeric	frac.	.0071	0.	10.
MIN-RATIO	MIN-R	numeric	frac.	0.1	0.	1.
MAX-RATIO	MAX-R	numeric	frac.	1.15	1.0	2.0

A simple example input might be:

DF-CHLR = PLANT-EQUIPMENT TYPE=ABSORG-CHLR SIZE=2.4 ..

·  
·  
·

PLANT-PARAMETERS ABSORG-HIR=1.023 ..

PART-LOAD-RATIO E-I-R=.011 ..



## ENGINE DRIVEN COMPRESSION CHILLER

## Introduction

The capability to simulate an engine-driven compression chiller equipped with a screw compressor was added to the DOE-2.1D PLANT subprogram. To simulate the unit, you must use the code-word ENG-CHLR in the PLANT-EQUIPMENT command in the PLANT input. For example:

```
ENGINE-CHILLER = PLANT-EQUIPMENT TYPE=ENG-CHLR SIZE=1.8 ..
```

The unit is modeled with a full load, standard condition coefficient of performance (COP) which is modified by several curves for part load and nonstandard conditions. Standard conditions are defined as 44°F leaving chilled water temperature and 85°F entering condenser temperature. The COP can be input by means of the ENG-CH-COP keyword in the PLANT-PARAMETERS command; the default is 1.4. The curves that modify the COP are as follows: These have the form  $z=a+bx+cx^2+dy+ey^2+fxy^2$ , where  $x$  = first independent variable and  $y$  = second independent variable.

Keyword	Independent Variables	Coefficients					
		(a)	(b)	(c)	(d)	(e)	(f)
ENG-CH-COP-FT	chilled water temperature, entering condenser temperature	1.23624	.0168923	0	-.0115235	0	0
ENG-CH-COP-FTS	chilled water temperature, entering condenser temperature	1.08815	.0141064	0	-.00833923	0	0
ENG-CH-COP-FPLR1	part load ratio	1.14336	.0228899	0	0	0	0
ENG-CH-COP-FPLR2	part load ratio	1.38861	-.388614	0	0	0	0
ENG-CH-COP-FPLRS	part load ratio	.3802	2.3609	0	0	0	0

The function that modifies the COP as a function of the part load ratio is parameterized as three linear curves; i.e., the function is piecewise linear.

- ENG-CH-COP-FPLR1 is used below 0.6 but above the minimum speed of the engine.
- ENG-CH-COP-FPLR2 is used above a part load of 0.6 (where 0.6 is the point with the highest COP; the point defined by the keyword OPERATING-RATIO in the PART-LOAD-RATIO command and defaulted to 0.6 for this type of chiller).

The engine driven compression chiller model in DOE-2.1D was developed with the support and collaboration of the Gas Research Institute and ElectroCOM GARD, Ltd.

Supplement — 2.1E Update

- ENG-CH-COP-FPLRS is used when the engine is at minimum speed. The minimum speed is defined by the ENG-CH-IDLE-RAT keyword in the PLANT-PARAMETERS command; the default is .3125.

COP is modified as a function of chilled water temperature and entering condenser temperature by two bilinear curves. ENG-CH-COP-FT is used for part loads above the minimum speed of the engine and ENG-CH-COP-FTS for those below it.

The capacity of the unit at standard conditions is set by the SIZE keyword in your input to the PLANT-EQUIPMENT command. For nonstandard conditions, the capacity is modified by the following bi-linear curve:

Keyword	Independent Variables	Coefficients					
		(a)	(b)	(c)	(d)	(e)	(f)
ENG-CH-CAP-FT	chilled water temperature, entering condenser temperature	.573597	.0186802	0	-.00465325	0	0

The engine also produces a large amount of recoverable heat. The efficiency of recoverable heat production at full load and standard conditions is set by the ENG-CH-REC-EFF keyword in the PLANT-PARAMETERS command. The default is .519; this number is modified by the following curves for nonstandard and part load conditions:

Keyword	Independent Variables	Coefficients					
		(a)	(b)	(c)	(d)	(e)	(f)
ENG-CH-HREJ-FT	entering condenser temperature	.705841	.00346070	0	0	0	0
ENG-CH-HREJ-FPLR	part load ratio	1.05270	-.0526991	0	0	0	0

Both curves are linear in the independent variable. All the curves described above are keywords in the EQUIPMENT-QUAD command. They can be changed by using the keywords to reference the u-name of a CURVE-FIT command.

Several important parameters in the model are set through the PART-LOAD-RATIO command. The most important is the electrical consumption of the unit. This is calculated using an electric input ratio (EIR); the ratio of the electrical usage in Btuh to the nominal capacity in the same units. The EIR is input by the ELEC-INPUT-RATIO keyword in the PART-LOAD-RATIO command; default is .0053. The minimum operating part load ratio (keyword MIN-RATIO, default .06623) and the maximum operating part load ratio (keyword MAX-RATIO, default 1.25) can also be set in this command. Below the MIN-RATIO the unit is cycled on and off. The high value of the MAX-RATIO reflects the fact that the engine can be over-revved for short periods.

There is another keyword in the PLANT-PARAMETERS command that is relevant to the engine driven chiller.

PLANT-PARAMETERS

ENG-CH-COND-TYPE can be given the value TOWER or AIR to denote whether the condenser is cooled by tower water or air; the default is TOWER.

The engine driven chiller should be operated through the LOAD-MANAGEMENT and LOAD-ASSIGNMENT commands when there are other chillers available. There is no default optimizing of the operation of this chiller in conjunction with electrically driven compression chillers and/or steam or direct fired absorption chillers. The waste heat from the engine can be recovered using the HEAT-RECOVERY command. The code-word to be used with the SUPPLY keywords in HEAT-RECOVERY is the equipment type code-word ENG-CHLR.

In summary, the keywords relevant to the engine driven chiller input are:

under the PLANT-PARAMETERS command:						
Keyword	Abbr	Type	Unit	Default	Min	Max
ENG-CH-COP	none	numeric	frac.	1.4	0.1	3.0
ENG-CH-REC-EFF	none	numeric	frac.	.519	0.1	1.0
ENG-CH-IDLE-RAT	none	numeric	frac.	.3125	0.0	1.0
ENG-CH-COND-TYPE	none	code-word		TOWER		
under the EQUIPMENT-QUAD command:						
Keyword	Abbr	Type	Unit	Default	Min	Max
ENG-CH-COP-FT	none	curve		ECCOPT		
ENG-CH-COP-FTS	none	curve		ECCOPTS		
ENG-CH-COP-FPLR1	none	curve		ECCOPPLR1		
ENG-CH-COP-FPLR2	none	curve		ECCOPPLR2		
ENG-CH-COP-FPLRS	none	curve		ECCOPPLRS		
ENG-CH-CAP-FT	none	curve		ECCAPT		
ENG-CH-HREJ-FT	none	curve		ECHREJT		
ENG-CH-HREJ-FPLR	none	curve		ECHREJPLR		
under the PART-LOAD-RATIO command:						
Keyword	Abbr	Type	Unit	Default	Min	Max
ELEC-INPUT-RATIO	E-I-R	numeric	frac.	.0053	0.	10.
MIN-RATIO	MIN-R	numeric	frac.	.06623	0.	1.
MAX-RATIO	MAX-R	numeric	frac.	1.25	1.0	2.0
OPERATING-RATIO	O-R	numeric	frac.	0.6	0.	2.0

Supplement -- 2.1E Update

**Example:**

A simple input for the engine driven chiller might look like;

```
ENGINE-CHILLER = PLANT-EQUIPMENT
                TYPE = ENG-CHLR
                SIZE = 1.8 ..
```

...

```
HEAT-RECOVERY SUPPLY-1 = (ENG-CHLR)
                    DEMAND-1 = (SPACE-HEAT, PROCESS-HEAT) ..
```

```
PLANT-PARAMETERS  ENG-CH-COP = 1.1 ..
```

## ICE AND EUTECTIC THERMAL ENERGY STORAGE

**Introduction** (see also "Discussion", p.4.32)

Models have been added to the DOE-2.1E PLANT program for simulating ice-on-coil, ice-harvester, brine, ice-slurry, and eutectic-salt thermal energy storage (TES) systems. System options include full vs. partial storage, chiller priority vs. storage priority, and demand limiting. In this section we describe the new keywords, give input examples for a variety of systems, and discuss the simulation method, with emphasis on the sizing of these systems.

For background information on TES systems and illustrations of different system configurations, you are referred to the EPRI "Commercial Cool Storage Design Guide" available from the Electric Power Research Institute, 3412 Hillview Avenue, Palo Alto, CA 94304.

The CBS/ICE component-based program for ice-on-coil systems, which was included in DOE-2.1D, has been removed from DOE-2.1E.\* It has been replaced with the following, easier-to-use model for the case that TES-TYPE=ICE-ON-COIL.

The keywords added in 2.1E, plus existing keywords that apply to TES, are as follows:

### PLANT-PARAMETERS

TES-TYPE	accepts the following code-words that represent different types of TES systems.
<i>NO-TES</i>	The default; no ice or eutectic storage.
<i>ICE-ON-COIL</i>	Ice is built up on refrigerant tubes mounted in a water storage tank. This system has a distinct operating characteristic: as the ice forms on the tubes it acts as an insulator and thus degrades the capacity and efficiency of the refrigerating compressor. Any ice remaining on the tubes when the charging cycle restarts also acts as an insulator.
<i>ICE-HARVESTER</i>	Very thin ice is built up on refrigerant plates. This allows the compressor to operate with small changes in capacity and efficiency. The ice is dislodged from the plates by periodically defrosting the plates using a reverse refrigerant cycle. The ice then drops into a holding bin or into a water storage tank.
<i>BRINE</i>	A block of ice is built up inside an expandable storage tank in which tubes circulating brine (or other low temperature fluid) are embedded. The compressor of the chiller that refrigerates the brine operates within a fairly limited temperature range. The freezing of ice within plastic containers mounted inside a tank also falls into this category.

\* Bugs found in CBS/ICE have been corrected by its original developer (the Center for Energy Studies at the University of Texas at Austin), and the corrections have been included in an enhanced microcomputer-based program called ICICLE. ICICLE is under continuing development and is expected to include load forecasting, control optimization, and chilled water systems as future features. For more information on using ICICLE, contact Joel A. Banks, Building Energy Systems Program, Center for Energy Studies, University of Texas at Austin, 10100 Burnet Road, Austin, TX 78758.

Supplement — 2.1E Update

<i>ICE-SLURRY</i>	A water and brine mixture is frozen in a holding tank. As ice crystals are formed the mixture becomes an ice-slurry. A chiller is required, but the refrigerant system operates within a small temperature range.
<i>EUTECTIC</i>	The storage medium is a eutectic material that changes phase at a temperature other than 32°F. The configuration of the storage and refrigerant system will most likely be the same as that of a BRINE system.
TES-PRIORITY	accepts code-words CHILLER and STORAGE (the default). This selection is used only for automatic sizing of the chiller and of the COOL-SUPPLY-RATE for partial storage systems (see "Automatic Sizing", p.4.33). The selection must be consistent with the order of the STORAGE or of CHILLER equipment input in the LOAD-ASSIGNMENT instruction.
<i>CHILLER</i>	Automatic sizing will assume that the chiller has priority in meeting the cooling load, with the storage supplementing the chiller (see Examples, p.4.22).
<i>STORAGE</i>	Automatic sizing will assume that the storage has priority in meeting the cooling load, with the chiller supplementing the storage (see Examples, p.4.22). This is the preferred priority; however, if the storage is undersized and is depleted before the end of the cooling period, the chiller may not be able to handle the cooling load.
PERCENT-STORED	is the percentage of the peak integrated daily cooling load that will be stored. The default is 100%, which corresponds to a full storage system. Values less than 100% result in partial storage.
HOURS-CHARGING	is the number of hours available for charging the storage during a week night. This value should agree with the hours in the charging schedule.
HOURS-DISCHARGING	is the number of hours over which the storage must last. On the peak day it is assumed that the storage will be depleted on the last hour.
COMP-MODE-DCHG	is the "compressor mode during discharging". It accepts the following code-words related to compressor suction temperature.
<i>LOW-T</i>	simulates chiller operation during both the charging and discharging periods at the temperature specified by the keyword REFRIG-T-AT-PC, which defaults to 26°F.

---

In the left column, bold-faced words are commands, non-bold words are keywords, and italicized words are code-words.

- RATED-T** (the default) simulates chiller operation during the discharge period at a rated suction temperature of 38°F. During the charging period, the compressor operates at LOW-T.
- DEM-LIM+LOW-T** simulates chiller operation during a “shoulder period” as explained above under LOW-T; during the “demand limiting period”, the chiller is off. If you choose automatic sizing for COOL-SUPPLY-RATE (see p.4.20), this rate will be sized to meet the peak cooling load during the “demand limiting period”. See Example (3), p.4.29, in which the “shoulder period” is 7 am to 1 pm and 5pm to 6pm, and the “demand limiting period” is 1pm to 5pm.
- DEM-LIM+RATED-T** simulates chiller operation during a “shoulder period” as explained above under RATED-T (38°F); during the “demand limiting period”, the chiller is off. If you choose automatic sizing for COOL-SUPPLY-RATE (see p.4.20), this rate will be sized to meet the peak cooling load during the “demand limiting period”.
- PER-COMP-REDUCT/F** is the percent reduction in capacity of the refrigeration machine for each degree drop in suction temperature. The default is 2% reduction per °F. See Fig. 4.1.
- The reference base for TES chiller sizing corresponds to a water chiller operating with a 38°F suction temperature. The chiller size you enter must also be at 38°F suction temperature and not at the suction temperature required for making ice. The program assumes that a suction temperature of 38°F is normal to maintain 44°F chilled water temperature.
- REFRIG-T-AT-PC** is the refrigerant suction temperature at storage phase change. It defaults to 26°F, which is the nominal refrigerant suction temperature required to make ice. See Fig. 4.1. You should enter the appropriate suction temperature for the application. For example, for a brine application the brine may be circulated at 26°F, but the refrigerant suction temperature will most likely be 18 to 20°F. For eutectic systems where the phase change may occur at higher temperatures, the correct suction temperature should be entered.
- COMP-KW/TON-START** is the compressor kW/ton value at the start of making ice for the ice-on-coil system. The default is 0.96 kW/ton. For systems that operate with little change in suction temperature, this establishes average operating energy requirements for the entire charging period. See Fig. 4.2. *Even in metric runs, this keyword should be entered in kW/ton: there is no conversion in DOE-2.*

SRG-92-19

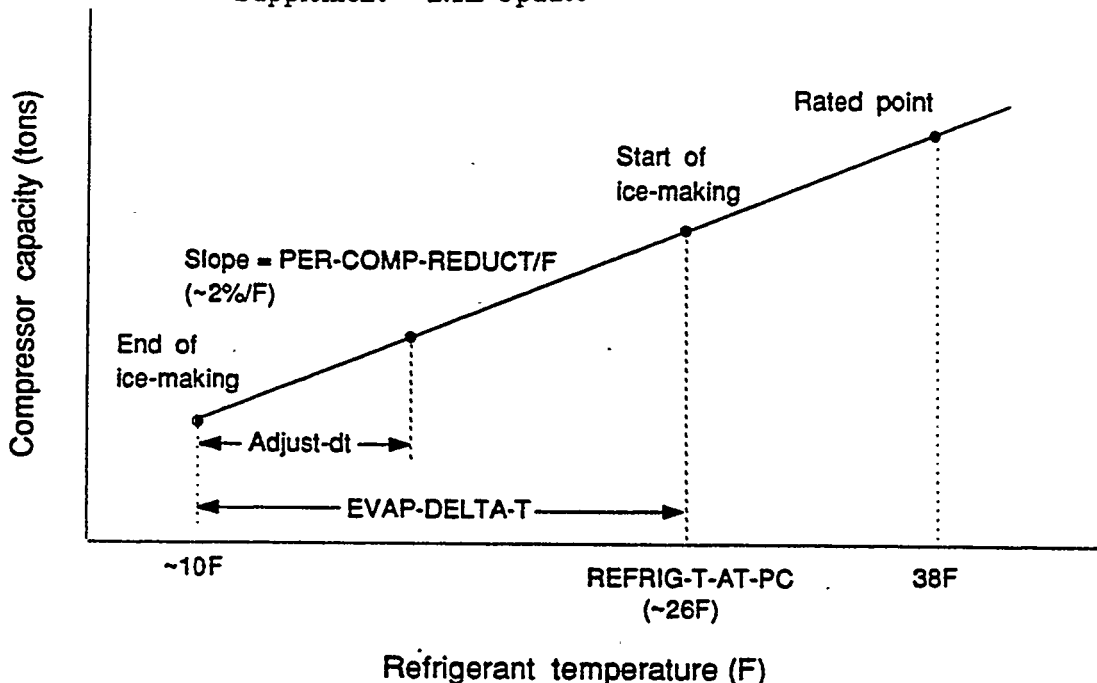

Figure 4.1: Compressor capacity vs. refrigerant temperature for ice making.

COMP-KW/TON-END

is the compressor kW/ton value at the end of making ice for the ice-on-coil system. If no value is entered, the program assumes there is no degradation in performance during the ice building period and so defaults to the starting kW/ton value, COMP-KW/TON-START. See Fig. 4.2. Even in metric runs, this keyword should be entered in kW/ton: there is no conversion in DOE-2.

EVAP-DELTA-T

is the drop in refrigerant suction temperature as the compressor charges the ice-on-coil system. The default is 16°F, which assumes a starting temperature of 26°F, and an ending temperature of 10°F. See Figs. 4.1 and 4.2. Users should check with the manufacturer to obtain a value for this keyword for a particular refrigeration machine.

This temperature drop is used to derate both the capacity of the compressor and the kW/ton energy use as the ice builds on the tubes of an ice-on-coil system. It is also used to calculate the starting suction temperature for charging when the ice was not depleted the previous day. To do this the program adjusts EVAP-DELTA-T to

$EVAP-DELTA-T * (\text{previous day's load}) / (\text{storage capacity})$ .  
This is shown as "Adjust-dt" in Figs. 4.1 and 4.2.

PUMP+AUX-KW

is the pumping and/or auxiliary electrical power needed to circulate water to facilitate even ice melt and buildup on the tubes for the ice-on-coil system. It could also represent energy for ice handling or crushing for ice harvester systems.

You should note that in the PART-LOAD-RATIO instruction, ELECTRIC-INPUT-RATIO (entered as a fraction of



tank capacity) may be used to represent other pumping requirements (e.g., circulation between tank and heat exchanger to the building distribution system).

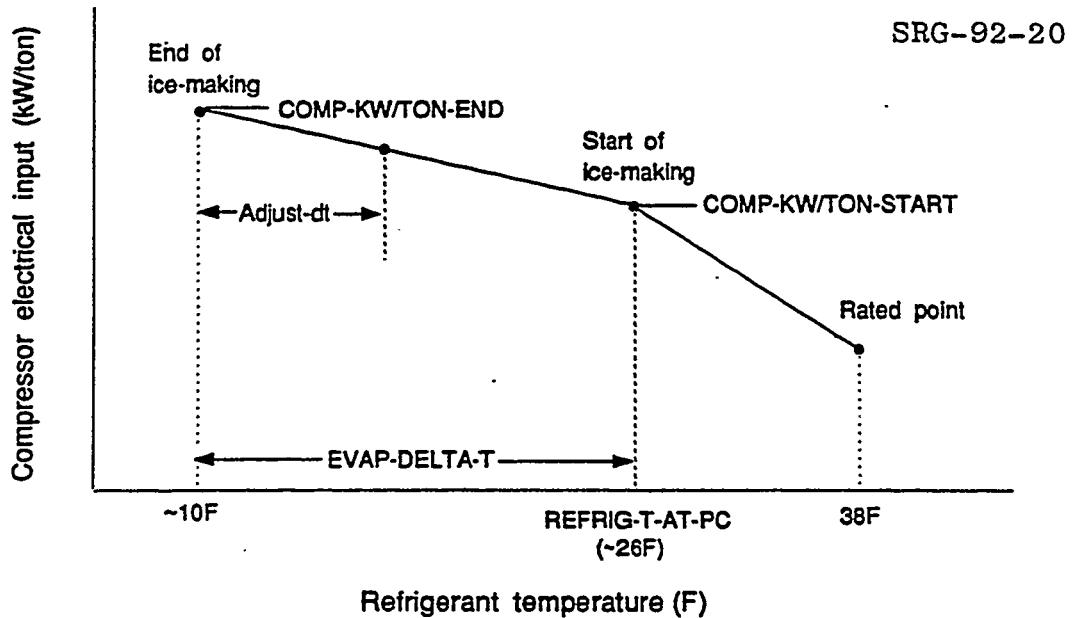

Figure 4.2: Compressor electrical input vs. refrigerant temperature for ice making.

PUMP+AUX-SCH

accepts the u-name of a schedule that specifies the hours that the pumping and auxiliary energy is required. The default is "always on".

ICE-HARVEST-RATIO

is the fraction of time spent making ice for TES-TYPE=ICE-HARVESTER. The time for harvesting, which requires a hot gas reverse cycle, is therefore equal to  $[1 - (\text{ICE-HARVEST-RATIO})]$ . The default is 0.75.

DELAY-CHARGE-HOUR

Specifies the latest time to which the start of charging can be delayed. If not specified, the tank will start to charge the first hour, defined in COOL-STORE-SCH.

If used, the DELAY-CHARGE-HOUR will usually be the last hour defined in COOL-STORE-SCH. In the following example, charging can be delayed as late as 6:00 a.m. if very little of the storage was used the previous day.

The time required to charge the tank is calculated as:

$$\text{Hours to Charge} = \frac{\text{Amount Depleted}}{\text{COOL-STORE-RATE}}$$

The time the tank starts charging will be as follows:

$$\text{DELAY-CHARGE-HOUR} - (\text{hours to charge}).$$

## Supplement - 2.1E Update

When you use this keyword, bear in mind that it is important for the COOL-STORE-RATE to reflect the actual charging rate, as limited by either the chiller capacity (in the ice-making mode) or the practical freezing rate of the tanks (this concept also applies to the chilled water storage systems). If COOL-STORE-RATE is set too high, the program will underestimate the time required to charge the tanks, the delay will be longer than it should, and the tank may not be fully charged at the end of the charging period. If too low, the tank will start to charge earlier than it needs (but never earlier than the start time specified in the COOL-STORE-SCH).

### Example:

Some electrical utilities offer various incentives for thermal energy storage. One of these incentives is "super off-peak", a very low energy charge rate offered during a restricted period at night. For example, the following electrical rate has four different charges which are a function of the time of use:

#### ENERGY-SUMMER = WEEK SCHEDULE

(WD)	( 1, 6 )	( 0.03 )	\$ Super Off-Peak
	( 7, 12 )	( 0.10 )	\$ Mid Peak
	( 13, 17 )	( 0.12 )	\$ Peak
	( 18, 21 )	( 0.10 )	\$ Mid Peak
	( 22, 24 )	( 0.06 )	\$ Off-Peak
(WEH)	( 1, 6 )	( 0.03 )	\$ Super Off-Peak
	( 7, 24 )	( 0.06 )	\$ Off-Peak \$ ..

Ideally, a chilled water storage system should be charged during the super off-peak period as the energy charge is only one-fourth of the peak rate and only one-half of the off-peak rate.

Now assume that it takes eight hours to fully charge the storage tank. The charging schedule would usually be defined to start charging at 10:00 p.m. and continue to 6:00 a.m. The off-peak rate is to be used for charging during the first two hours and the super off-peak for the next six hours. But what if only one-half of the tank's capacity was used the previous day? In this case, the tank only needs to charge for four hours. It would make sense to delay the start of charging until 2:00 a.m. so that the super off-peak could be used for all of the charging period. In addition, the chiller might run more efficiently when the start time is delayed to take advantage of lower outside air temperatures.

## ENERGY-STORAGE

### COOL-STORE-RATE

is the maximum rate (MBtu/hr) at which the tank can be cooled during the charging period. For Thermal Energy Storage systems you may enter -999 for automatic sizing.

### COOL-SUPPLY-RATE

is the maximum rate (MBtu/hr) at which the tank can supply coolant to its connected load. For Thermal Energy Storage systems you may enter -999 for automatic sizing.

- COOL—STORE—SCH accepts the u-name of a schedule that contains the hourly profile for when the tank can be charged with coolant.  
An hourly value of 0 indicates no charging.  
An hourly value of 1 allows charging with coolant.  
To take advantage of “super off-peak” utility rates, the PLANT—PARAMETERS keyword DELAY—CHARGE—HOUR (see above) can be used to delay the start of charging that is specified by COOL—STORE—SCH.
- CTANK—BASE—T is the highest temperature (°F) at which the stored water can be delivered yet still provide cooling to the connected load.
- CTANK—T—RANGE is the temperature difference (°F) between the coldest storage temperature and CTANK—BASE—T.
- CTANK—LOSS—COEF is the UA value of the tank (Btuh/°F). It equals the conduction heat gain to the tank per degree temperature difference between storage medium and ambient. (See CTANK—ENV—T and CTANK—ENV—T—SCH below.) For an underground storage tank, a CTANK—LOSS—COEF value consistent with this would be  
 $0.03 / (24 \text{ hours} * 10^{\circ}\text{F}) * \text{capacity} = 0.000125 * \text{capacity}$ .  
DOE-2 uses CTANK—LOSS—COEF to determine the hourly cold loss from the tank, but it does not use it in automatic sizing of the tank. For auto-sizing, the program assumes that the cold loss from the tank per day is 3% of the storage capacity. This corresponds to a loss coefficient of  $C * 0.03 / (24 \text{ hours} * \Delta T)$ , where C is the tank capacity in Btu and  $\Delta T$  is the average temperature difference between storage medium and ambient on the peak day. *If the insulation on the tank or the ambient conditions give a CTANK—LOSS—COEF value that is higher than this, the tank will be undersized and the storage will be depleted before the end of the discharge period on the peak day.* In this case you should manually increase the storage capacity over that resulting from automatic sizing.
- CTANK—ENV—T is the ambient temperature of the tank’s environment. If not input, the program defaults to the hourly outside drybulb temperature from the weather tape.
- CTANK—ENV—T—SCH accepts the u-name of a schedule that gives the ambient temperature profile for a cool storage tank. If this temperature is constant, you may specify CTANK—ENV—T instead.

**Hourly Reports**

PLANT hourly reports are available to give a detailed view of tank and chiller performance (see Appendix A, VARIABLE-TYPE = CTANK-STORAGE, p.A.76 and VARIABLE-TYPE = OPEN-CENT-CHLR or OPEN-REC-CHLR, p.A.66).

**Examples of Thermal Energy Storage**

The following three input examples illustrate typical cool storage configurations and operating strategies. They are presented in order of complexity. More examples are in the *Sample Run Book (2.1E)*, "Office Building and Open Atria". Cool storage input requires the use of the ENERGY-STORAGE, LOAD-ASSIGNMENT, and LOAD-MANAGEMENT instructions, which are described in the PLANT section of the *Reference Manual (2.1A)*. A series of examples that show the use of these instructions can be found in the section, PLANT OPERATING STRATEGIES, p.4.59.

DOE-2 input is shown in the left-hand column and notes to some individual lines of input are shown at the right.

**Example (1): Full-storage brine system**

This is a brine system providing full storage for all HVAC operating hours.

INPUT PLANT ..

ICEM = PLANT-EQUIPMENT  
TYPE = OPEN-REC-CHLR

Open refrigeration chillers must be used for TES applications in DOE-2. Sizing is done automatically by DOE-2.

SIZE = -999 ..

CTANK = PLANT-EQUIPMENT  
TYPE = CTANK-STORAGE  
SIZE = -999 ..

Sizing is done automatically by DOE-2.

ENERGY-STORAGE  
COOL-STORE-RATE = -999

This is the peak cooling capacity of the OPEN-REC-CHLR; it will be sized by DOE-2.

COOL-SUPPLY-RATE = -999

This is the peak cooling capacity of the storage, it will be sized by DOE-2.

COOL-STORE-SCH = TANK-CHG

This schedules when the cooling tank is a demand on the OPEN-REC-CHLR.

CTANK-LOSS-COEF = 100

This is the tank's UA value (the conduction heat gain to the tank per degree temperature difference between storage medium and ambient (Btuh/°F)).

CTANK-BASE-T = 44

This is the highest temperature of brine delivered.

CTANK-T-RANGE = 10

The temperature difference expected between empty and full conditions.

Supplement — 2.1E Update

CTANK-ENV-T = 65 ..	The ambient temperature of the tank. Defaults to the outside air drybulb temperature.
PLANT-PARAMETERS	
TES-TYPE = BRINE	Is the type of storage medium.
HOURS-CHARGING = 13	Is the number of hours each night that the tank will be charged. This should agree with the following charging schedule.
HOURS-DISCHARGING = 11	Is the number of hours each weekday that the HVAC systems operate and discharge the cold storage.
PERCENT-STORED = 100	(default value) Implies a full storage system.
COMP-KW/TON-START = .95	Gives the average electrical consumption of the refrigeration compressor during charging period.
REFRIG-T-AT-PC = 20 ..	Is the refrigeration compressor's suction temperature while cooling the brine.
TANK-CHG = SCHEDULE THRU DEC 31 (ALL)	The u-name TANK-CHG was referenced above by COOL-STORE-SCH. This schedule specifies when the tank is a cooling load.
(1,7)(1)	The tank is charging.
(8,18)(0)	The tank is not charging.
(19,24)(1) ..	The tank is charging.
TANK-CHARGE = LOAD-ASSIGNMENT	Assigns the refrigeration machine's operation.
TYPE = COOLING	Cooling equipment is assigned.
LOAD-RANGE = 99	No threshold applies.
PLANT-EQUIPMENT = ICEM	The u-name of the compressor.
NUMBER = 1 ..	
TANK-DISCHARGING = LOAD-ASSIGNMENT	This is used to assign the availability of the storage to meet the cooling load.
TYPE = COOLING	No threshold applies.
LOAD-RANGE = 99	The tank is the only source of cooling.
PLANT-EQUIPMENT = CTANK	
NUMBER = 1 ..	
CHW-CTRL = DAY-ASSIGN-SCH	This day schedule references the LOAD-ASSIGNMENTS; it tells the program when to assign the control strategies during the day.
(1,7) (TANK-CHARGE)	The hours input normally correspond to those input for HOURS-CHARGING
(8,18) (TANK-DISCHARGING)	

Supplement — 2.1E Update

(19,24) (TANK-CHARGE) ..

and HOURS-DISCHARGING.

CHILLER-CTRL = SCHEDULE  
THRU DEC 31  
(ALL) CHW-CTRL ..

This completes the schedule by referencing the day schedule.

LOAD-MANAGEMENT

PRED-LOAD-RANGE = 99

No threshold applies.

ASSIGN-SCHEDULE = (DEFAULT,  
CHILLER-CTRL,  
DEFAULT) ..

Defaults the heating assignment  
References u-name of cooling ctrl  
Defaults the electrical assignment.

Hourly reports display the relationship of the system's storage capacity with its compressor capacity. With this information for the peak day (and for other near-peak days), you can readily see whether the storage is being depleted prior to the end of the HVAC operating period. Following is a sample input of hourly reports that provide the essential information.

R-SCHED SCH THRU AUG 20 (ALL) (1,24)(0) Assuming Aug 20 to 30 covers peak  
THRU AUG 30 (ALL) (1,24)(1)  
THRU DEC 31 (ALL) (1,24)(0) ..

RB1 = REPORT-BLOCK  
VARIABLE-TYPE = OPEN-REC-CHLR  
VARIABLE-LIST = (1,8,10,16) .. 1 is the chiller load (Btu/hr)  
8 is the chiller capacity ratio  
10 is the chiller part load ratio  
16 is the chiller adjusted EIR

RB2 = REPORT-BLOCK  
VARIABLE-TYPE = CTANK-STORAGE  
VARIABLE-LIST = (1,4,12,14) .. 1 is the storage energy released (Btu/hr)  
4 is the energy stored each hour (Btu/hr)  
12 is the tank loss (Btu/hr)  
14 is the total stored energy (Btu/hr)

REPORT1 = HOURLY-REPORT  
REPORT-SCHEDULE = R-SCHED  
REPORT-BLOCK = (RB1,RB2) ..

END ..

COMPUTE PLANT ..

Supplement - 2.1E Update

Example (2): Partial-storage ice-on-coil system with screw-type chillers

This is a partial-storage ice-on-coil system with storage priority and two screw-type chillers.

INPUT PLANT ..

ICEM = PLANT-EQUIPMENT

TYPE = OPEN-REC-CHLR

SIZE = -999

But curves for a screw-type chiller will be used  
Sized automatically by DOE-2  
based on two chillers of the same size.

INSTALLED-NUMBER = 2 ..

CTANK = PLANT-EQUIPMENT

TYPE = CTANK-STORAGE

SIZE = -999 ..

Sized automatically by DOE-2.

ENERGY-STORAGE

COOL-STORE-RATE = -999

Peak cooling capacity of the chiller;  
sized automatically by DOE-2.

COOL-SUPPLY-RATE = -999

This is the peak cooling capacity of the storage; it  
will be sized by the program.

COOL-STORE-SCH = TANK-CHG This schedules when the cooling tank is a demand  
on the chiller.

CTANK-LOSS-COEF = 100

This is the conduction heat gain to the tank per  
degree temperature difference between storage  
medium and ambient (Btuh/°F).

CTANK-BASE-T = 44

This is the highest temperature of water delivered.

CTANK-T-RANGE = 10

Is the temperature difference expected between  
depleted and full conditions.

CTANK-ENV-T-SCH = TANK-ENV ..

Is the schedule of the ambient temperature sur-  
rounding the tank. If not input, the default is the  
outside air drybulb temperature.

TANK-ENV = SCHEDULE

THRU MAR 15 (ALL) (1,24)(65)

This schedule is meant to simulate an equipment  
room environment.

THRU OCT 15 (ALL) (1,24)(80)

THRU DEC 31 (ALL) (1,24)(65) ..

PLANT-PARAMETERS

TES-TYPE = ICE-ON-COIL

This is type of storage system.

TES-PRIORITY = STORAGE

Is used for sizing purposes.

Supplement -- 2.1E Update

HOURS-CHARGING = 10	Is the number of hours each night that the tank will be charged. This should agree with the charging schedule that follows below.
HOURS-DISCHARGING = 11	Is the number of hours each weekday that the HVAC systems operate and discharge the cold storage.
PERCENT-STORED = 50	Implies a partial storage system.
COMP-MODE-DCHG = RATED-T	The compressor operates during the day at rated temperatures.
COMP-KW/TON-START = .95	Is the energy consumption of the refrigeration compressor at the start of the charging period.
COMP-KW/TON-END = 1.05	Is the energy consumption at the end of the charging period.
REFRIG-T-AT-PC = 26	Is the refrigeration compressor's suction temperature at the start of making ice.
EVAP-DELTA-T = 16	Is the drop in suction temperature from the start to end of building ice on the tubes.
PUMP+AUX-KW = .2 ..	Is the energy consumption of the circulating paddles, which are always on.

To change the Open Reciprocating Chiller into a screw-type chiller, we enter the following curves:

SCREW-CAP-FT = CURVE-FIT TYPE = BI-QUADRATIC  
 COEF = (.568,.0012,.00016,.0049,-.000049,-.0000002) ..

SCREW-EIR-FT = CURVE-FIT TYPE = BI-QUADRATIC  
 COEF = (.0243,-.0094,.00033 ,.0176,.0001,-.0004) ..

SCREW-EIR-FPLR = CURVE-FIT TYPE = QUADRATIC  
 COEF = (.052,.226,.722) ..

EQUIPMENT-QUAD

OPEN-REC-EIR-FPLR = SCREW-EIR-FPLR  
 OPEN-REC-CAP-FT = SCREW-CAP-FT  
 OPEN-REC-EIR-FT = SCREW-EIR-FT ..

These three EQUIPMENT-QUAD instructions replace the default curves for the Open Reciprocating Chiller

PART-LOAD-RATIO

TYPE = OPEN-REC-CHLR E-I-R = .23 ..

The E-I-R is the reciprocal of the COP (4.4) of a screw compressor when operating at RATED-T.



TANK—CHG = SCHEDULE THRU DEC 31 (ALL)

(1,7)(1).  
(8,18)(0)  
(19,24)(1) ..

The u-name TANK—CHG was referenced above by COOL—STORE—SCH. This schedule specifies when the tank is a cooling load.

The tank is charging.  
The tank is not charging.  
The tank is charging.

TANK—DISCHARGING = LOAD—ASSIGNMENT

TYPE = COOLING  
LOAD—RANGE = 99  
PLANT—EQUIPMENT = CTANK  
NUMBER = 1  
  
PLANT—EQUIPMENT = ICEM  
NUMBER = 2 ..

This is used to assign the storage and chillers to meet the cooling load.

Cooling equipment is assigned.  
No threshold applies.  
Placing the tank first in sequence gives a system with storage priority.

The chillers supplement the storage. Reversing the order (making CTANK second and ICEM first, and changing TES—PRIORITY to CHILLER) gives a system with chiller priority.

TANK—CHARGE = LOAD—ASSIGNMENT

TYPE = COOLING  
LOAD—RANGE = 99  
PLANT—EQUIPMENT = ICEM  
NUMBER = 2 ..

This assigns the chillers to store ice. Cooling equipment is assigned. No threshold applies.

CHW—CTRL = DAY—ASSIGN—SCH

(1,7) (TANK—CHARGE)  
(8,21) (TANK—DISCHARGING)  
(22,24) (TANK—CHARGE) ..

This day schedule references the LOAD—ASSIGNMENTs and tells the program when to assign the control strategies during the day.

Simulating an HVAC load ending at 6 p.m. where the on-peak electricity tariff prevents starting charging until 10 p.m. In this case HOURS—DISCHARGING=11 used for sizing does not agree with the schedule values of (8,21).

CHILLER—CTRL = SCHEDULE  
THRU DEC 31  
(ALL) CHW—CTRL ..

This completes the schedule by referencing the day schedule.

LOAD—MANAGEMENT

PRED—LOAD—RANGE = 99  
  
ASSIGN—SCHEDULE = (DEFAULT,  
CHILLER—CTRL,  
DEFAULT) ..

No threshold applies.

Defaults the heating assignment  
References u-name of cooling ctrl  
Defaults the electrical assignment.

Supplement — 2.1E Update

The use of hourly reports displays the relationship of the system's storage capacity with its compressor capacity. With this information for the peak day (and for other near-peak days), you can readily see whether the storage is being depleted prior to the end of the HVAC operating period. The following sample input of hourly reports provides the essential information.

```
R-SCHED = SCH   THRU AUG 20 (ALL) (1,24)(0)   Assuming Aug 20 to 30 covers peak
                THRU AUG 30 (ALL) (1,24)(1)
                THRU DEC 31 (ALL) (1,24)(0) ..
```

```
RB1 =  REPORT-BLOCK
        VARIABLE-TYPE = OPEN-REC-CHLR
        VARIABLE-LIST (1,8,10,16) ..           1 is the code-number for chiller load
                                                8 Is the chiller capacity ratio
                                                10 Is the chiller part load ratio
                                                16 Is the chiller adjusted EIR
```

```
RB2=  REPORT-BLOCK
        VARIABLE-TYPE = CTANK-STORAGE
        VARIABLE-LIST (1,4,12,14) ..           1 is the storage energy released
                                                4 is the energy stored each hour
                                                12 is the heat gain from surroundings
                                                14 is the total stored energy
```

```
REPORT1 =  HOURLY-REPORT
            REPORT-SCHEDULE = R-SCHED
            REPORT-BLOCK = (RB1,RB2) ..
```

```
END ..
```

```
COMPUTE PLANT ..
```

## Supplement — 2.1E Update

### Example (3): Ice harvester system

This is an ice harvester system that provides demand-limited storage for an on-peak utility period of 1 p.m. to 5 p.m. and partial storage for all other HVAC operating hours (i.e., 8 a.m. to 6 p.m.).

INPUT PLANT ..

ICEM = PLANT-EQUIPMENT  
TYPE = OPEN-REC-CHLR  
SIZE = -999 ..

Chiller sized automatically by DOE-2

CTANK = PLANT-EQUIPMENT  
TYPE = CTANK-STORAGE  
SIZE = -999 ..

Tank sized automatically by DOE-2

ENERGY-STORAGE  
COOL-STORE-RATE = -999

The peak cooling capacity of the chiller;  
sized automatically by DOE-2.

COOL-SUPPLY-RATE = -999

The peak cooling capacity of the storage;  
sized automatically by DOE-2.

COOL-STORE-SCH = TANK-CHG

This schedules when the cooling tank is a demand  
on the chiller.

CTANK-LOSS-COEF = 100

The conduction heat gain to the tank per degree  
temperature difference between storage medium  
and ambient (Btuh/°F).

CTANK-BASE-T = 44

This is the highest temperature of brine delivered.

CTANK-T-RANGE = 10

The temperature difference expected between  
empty and full conditions.

CTANK-ENV-T = 65 ..

The ambient temperature of the the storage tank;  
it defaults to the outside air drybulb temperature.

PLANT-PARAMETERS

TES-TYPE = ICE-HARVESTER

Is the type of TES system.

TES-PRIORITY = CHILLER

Is used for sizing. The action is controlled by the  
LOAD-ASSIGNMENT instruction, below.

HOURS-CHARGING = 13

Is the number of hours each night that the tank  
will be charged. This should agree with the  
charging schedule, below.

HOURS-DISCHARGING = 11

Is the number of hours each weekday that the  
HVAC systems operate and discharge the storage  
tank.

PERCENT-STORED = 70

Implies a partial storage system.

Supplement - 2.1E Update

COMP-KW/TON-START = .95      Is the average energy consumption of the refrigeration compressor during charging and shoulder periods.

REFRIG-T-AT-PC = 26      Is the refrigeration compressor's suction temperature while making ice.

ICE-HARVEST-RATIO = .75      Is the fraction of time making ice; the remaining time (.25) is reverse cycle for harvesting.

COMP-MODE-DCHG = DEM-LIM+LOW-T ..  
 Instructs the program to size the COOL-SUPPLY-RATE to maximum load and to operate at LOW-T while discharging.

TANK-CHG = SCHEDULE THRU DEC 31 (ALL)  
 The u-name TANK-CHG was referenced above by COOL-STORE-SCH. This schedule specifies when the tank is a cooling load.

(1,7)(1)      The tank is charging.  
 (8,18)(0)      The tank is not charging.  
 (19,24)(1) ..      The tank is charging.

TANK-CHARGE = LOAD-ASSIGNMENT      Assigns the refrigeration machine's operation.  
 TYPE = COOLING      Cooling equipment is assigned.  
 LOAD-RANGE = 99      No threshold applies.  
 PLANT-EQUIPMENT = ICEM  
 NUMBER = 1 ..

DEMAND-LIMITING = LOAD-ASSIGNMENT  
 This is used to assign the storage to meet the entire cooling load during the "on peak" period.

TYPE = COOLING  
 LOAD-RANGE = 99      No threshold applies.  
 PLANT-EQUIPMENT = CTANK  
 NUMBER = 1 ..

PARTIAL-OPERATION = LOAD-ASSIGNMENT  
 This is used to assign both the chiller and the storage to meet the cooling load during the "shoulder" period.

TYPE = COOLING  
 LOAD-RANGE = 99  
 PLANT-EQUIPMENT = ICEM      The chiller takes priority.  
 NUMBER = 1  
 PLANT-EQUIPMENT = CTANK      Storage supplements the chiller.  
 NUMBER = 1 ..

CHW-CTRL = DAY-ASSIGN-SCH  
 (1,7) (TANK-CHARGE)  
 (8,13) (PARTIAL-OPERATION)  
 (14,17)(DEMAND-LIMITING)  
 This day schedule references the L-A's and tells the program when to assign the control strategies during the day.

(18) (PARTIAL-OPERATION)  
 (19,24) (TANK-CHARGE) ..

CHILLER-CTRL = SCHEDULE THRU DEC 31

This completes the schedule by referencing the day schedule.

(ALL) CHW-CTRL ..

LOAD-MANAGEMENT

PRED-LOAD-RANGE = 99

No threshold applies.

ASSIGN-SCHEDULE = (DEFAULT,  
 CHILLER-CTRL,  
 DEFAULT) ..

Defaults the heating assignment  
 References u-name of cooling control  
 Defaults the electrical assignment.

Hourly reports display the relationship of the system's storage capacity with its compressor capacity. With this information for the peak day (and for other near-peak days), you can readily see whether the storage is being depleted prior to the end of the HVAC operating period. The following sample input of hourly reports provides the essential information.

R-SCHED SCH THRU AUG 20 (ALL) (1,24)(0) Assuming Aug 20 to 30 covers peak  
 THRU AUG 30 (ALL) (1,24)(1)  
 THRU DEC 31 (ALL) (1,24)(0) ..

RB1 = REPORT-BLOCK  
 VARIABLE-TYPE = OPEN-REC-CHLR  
 VARIABLE-LIST (1,8,10,16) ..

1 is the code-number for chiller load  
 8 is the chiller capacity ratio  
 10 is the chiller part load ratio  
 16 is the chiller adjusted EIR

RB2 = REPORT-BLOCK  
 VARIABLE-TYPE = CTANK-STORAGE  
 VARIABLE-LIST (1,4,12,14) ..

1 is the storage energy released  
 4 is the energy stored each hour  
 12 is the heat gain from surroundings  
 14 is the total stored energy

REPORT1 = HOURLY-REPORT  
 REPORT-SCHEDULE = R-SCHED  
 REPORT-BLOCK = (RB1,RB2) ..

END ..

COMPUTE PLANT ..

**Discussion**

The program assumes that the compressor runs at full load and never at part load when refrigeration equipment is charging the storage tank. There are exceptions to this in practice, but predicting when the exceptions occur and the number of hours of occurrence are beyond DOE-2 simulation capabilities. The hermetic refrigeration machines have been reserved for standard operating conditions; however, the program will not do automatic sizing when two types of chillers are input. This was done in case you need to assign machines that operate making ice while others do not. Therefore the open machines, such as OPEN-REC-CHLR and OPEN-CENT-CHLR, are the only ones that are affected by the algorithms that distinguish between rated and low-temperature operation.

**User-specified sizing**

When you input pre-sized capacities or more than one chiller type, the program will expect values for all of the following inputs:

- PLANT-EQUIPMENT    TYPE = OPEN-REC-CHLR  
                           SIZE = (value in MBtuh) at nominal rated conditions of 44°F  
   water (i.e., 38°F evaporator)
- PLANT-EQUIPMENT    TYPE = CTANK-STORAGE  
                           SIZE = (value in MBtuh)
- ENERGY-STORAGE    COOL-SUPPLY-RATE =    (value in MBtuh) This should be set  
   equal to the maximum building cooling  
   load.
- COOL-STORE-RATE =    (value in MBtuh) This should be set  
   equal to the chiller size times number of  
   chillers at the derated capacity.

### Automatic Sizing

We expect that most users will use the automatic sizing feature to obtain a first cut at sizing of TES systems, and then proceed to tune the sizing to their own preferences (e.g., setting the size of the chiller or the storage to nominal sizes available from a manufacturer).

Automatic sizing of the storage tank is based on the *peak integrated daily cooling load*, which is shown in SYSTEMS report SS-J. When there is more than one system, the value displayed on the SS-D report is used. This load is adjusted in SYSTEMS by adding to it distribution losses, pump heat, etc., plus total load unmet (which is the sensible load unmet divided by the sensible heat ratio). The adjusted load is then passed from SYSTEMS to PLANT.

The chiller capacity that results from automatic sizing is reported at normal chiller operating temperatures, resulting in the size of the machine actually purchased. This value of the chiller capacity is then reduced during ice making to account for the lower evaporator temperature (as specified by REFRIG-T-AT-PC). REFRIG-T-AT-PC is also used to determine the capacity reduction at the start of ice making. These relationships are shown in Fig. 4.1.

The sizing of full storage systems is done as follows:

$$\begin{aligned} \text{CTANK-STORAGE(full)} = & \text{System load (i.e., the daily integrated load + unmet loads),} \\ & \text{from SS-J report} \\ & + \text{PUMP+AUX-KW * (scheduled hours) * 3413} \\ & + \text{CTANK-STORAGE(SS-J) * .03 (for heat gain 3\%/day)} \\ & + \text{CTANK-STORAGE(SS-J) * E-I-R * 3413} \\ & + \text{CTANK-STORAGE(SS-J) * CCIRC-LOSS} \\ & + \text{distribution pump heat gains for one day} \end{aligned}$$

where CTANK-STORAGE(SS-J) represents the total daily integrated cooling load passed from SYSTEMS to PLANT. This value is replaced by the sum of all systems when there is more than one system.

The sizing of partial storage systems is done as follows:

$$\text{CTANK-STORAGE(partial)} = \text{CTANK-STORAGE(full)} * \text{PERCENT-STORED}/100$$

The compressor size for charging the storage is calculated as follows:

$$\text{Comp-size} = (\text{CTANK-STORAGE})/(\text{HOURS-CHARGING})$$

The compressor size is then adjusted to normal rating at 38°F refrigerant suction temperature:

1) For ICE-ON-COIL:

$$\text{Cap-Reduct} = (\text{PER-COMP-REDUCT}/F) * [38F - (\text{REFRIG-T-AT-PC}) - .5 * (\text{EVAP-DELTA-T})]$$

2) For ICE-HARVESTER:

$$\text{Cap-Reduct} = (\text{PER-COMP-REDUCT}/F) * \frac{[38F - (\text{REFRIG-T-AT-PC})]}{(\text{ICE-HARVEST-RATIO})}$$

where ICE-HARVEST-RATIO defaults to 0.75 (i.e., 75% of time is spent making ice and 25% is spent reverse-cycle harvesting).

Supplement - 2.1E Update

- 3) For BRINE, ICE-SLURRY or EUTECTIC:

$$\text{Cap-Reduct} = (\text{PER-COMP-REDUCT}/F) * [(38^{\circ}\text{F}-T) - (\text{REFRIG-T-AT-PC})]$$

Adjust to obtain the rated size:

$$\text{Comp-Size-Rated} = \text{Comp-Size} \left[ \frac{1.0 - (\text{Cap-Reduct})}{100} \right]$$

If you input a size, it will be used for Comp-Size-Rated. Calculate COOL-SUPPLY-RATE and chiller size for daytime operation:

- 1) COOL-STORE-RATE = Comp-Size (when charging the storage tank)
- 2) COOL-SUPPLY-RATE = Maximum hourly cooling load (from report SS-J) adjusted for pump heat, for the cases of full storage and when COMP-MODE-DCHG = DEM-LIM+RATED-T or DEM-LIM+LOW-T, or, for partial storage with storage priority,  
= CTANK-STORAGE(partial)/ HOURS-DISCHARGING
- 3) Calculate compressor capacity during daytime hours, for partial storage with storage priority, using the maximum hourly cooling load from the SS-J report.

If TES-PRIORITY = STORAGE, then the storage is base loaded, and

$$\text{Comp-Size-Day} = [\text{Maximum hourly cooling load (from SS-J)}] - (\text{COOL-SUPPLY-RATE})$$

- 4) To calculate the COOL-SUPPLY-RATE for partial storage with chiller priority, we must first size the chiller since it is base loaded.

If TES-PRIORITY = CHILLER, then the chiller is base loaded, and

$$\text{Comp-Size-Day} = \frac{\text{CTANK-STORAGE(full)} * [1 - (\text{PERCENT-STORED})/100]}{\text{HOURS-DISCHARGING}}$$

$$\text{COOL-SUPPLY-RATE} = [\text{Maximum hourly cooling load (SS-J)}] - (\text{Comp-Size-Day})$$

- 5) It is now necessary to compare the compressor size needed to meet the charging load as opposed to that needed to meet the daytime partial load, and then to size the chiller based on the maximum requirement of these two conditions. The size reported on PLANT report PV-A is always the rated size.
- 6) If you have entered SIZE in the PLANT-EQUIPMENT instruction for the chiller, then the program overrides previous sizing calculations. The program will derate this size when the chiller is operating at LOW-T or when making ice.



It is necessary to differentiate between partial storage systems operating a chiller at normal (38°F) temperatures during the day supplementing the storage, from the ICE-HARVESTER and BRINE systems, which usually only make ice while supplementing the storage. This is the purpose of the keyword COMP-MODE-DCHG with code-word RATED-T to indicate a chiller operating normally, and code-word LOW-T for operating while making ice.

The relationship between capacity and refrigerant temperature can be used to establish the capacity of the compressor if operating as an ice harvester or the capacity of that same compressor on other systems. It can also be used to establish the capacity of a compressor of an ICE-ON-COIL system at the start of making ice and at the end point (or any point in between). The essential difference between an ICE-ON-COIL system and others is the compressor, which degrades in capacity and energy consumption while making ice, whereas the others operate at an average point throughout their cycle.

Also, the ICE-ON-COIL system starts with ice on the coil if all the ice is not used the previous day. This is not the case, however, for the BRINE system where the tube is surrounded by water after a partial melt. The relationship above can also be used to determine the capacity of the compressor at this operating point for ICE-ON-COIL:

$$\text{Adjust-dt} = \text{EVAP-DELTA-T} * \frac{(\text{previous day load})}{(\text{storage capacity})}$$

The keywords COMP-KW/TON-START and COMP-KW/TON-END use the unit kW/ton, which is common in the refrigeration industry. The kW/ton rating of the compressor operating at normal 44°F chilled water and 38°F evaporator temperature can be derived from its ELEC-INPUT-RATIO (E-I-R) rating:

$$\text{kW/ton} = (\text{E-I-R}) * \left( \frac{12000}{3413} \right)$$

Plotting these three points (Rated, Start, and End) using REFRIG-T-AT-PC and EVAP-DELTA-T to locate them, gives a piecewise linear relationship to determine the energy use of the compressor for any of the systems. See Fig. 4.2. The start point can be considered as the average operating point of BRINE, ICE-HARVESTER, ICE-SLURRY and EUTECTIC systems. The reaction ice system should be modeled as a BRINE system.

### Pumping

The cool storage systems have different pumping and auxiliary power requirements during ice making and during discharge periods. For example, ICE-ON-COIL needs a stirring paddle or an air bubble system to help the ice form and melt evenly. The keywords PUMP+AUX-KW and PUMP+AUX-SCH (which defaults to always on) can be used to adjust these power requirements. This power is separate from the pumping for distribution to system air-handling-unit coils during discharge of the storage tank, the size of which is set by the CCIRC-DESIGN-T-DROP, CCIRC-HEAD, etc., keywords. When convenient, you may also use the tank ELECT-INPUT-RATIO (E-I-R) to represent pumping power requirements that are related to pumping at the COOL-STORE-RATE and the COOL-SUPPLY-RATE when heat exchangers are used between the building chilled water system and the storage system.

Building chilled water circulating pumps are locked out whenever there is no cooling load passed from SYSTEMS to PLANT.

## Supplement — 2.1E Update

### Curves

The curves that determine chiller capacity and energy consumption as a function of part load ratio, chilled water temperature, and condensing temperature are in effect whenever the chiller is operating at the rated temperature. However, when the chiller is operating at REFRIG-T-AT-PC or lower, only the condensing temperature correction curve is applied.

### Other parameters

The PLANT-PARAMETERS keywords that remain in effect for TES systems and allow you to simulate air-cooled condensing and other control parameters are as follows:

COMP-TO-TWR-WTR  
MIN-COND-AIR-T  
OPEN-CENT-COND-PWR  
OPEN-CENT-COND-TYPE  
OPEN-CENT-MOTOR-EFF  
OPEN-CENT-UNL-RATIO  
OPEN-REC-COND-PWR  
OPEN-REC-COND-TYPE  
OPEN-REC-UNL-RATIO

### Seven-day cycle

Some users may want to size TES based on a seven-day cycle. This can be done by hand by summing up five days of integrated loads using hourly reports, adding the heat gains and pumping energy, and dividing the sum by the total number of hours of charging time, including nights and weekends. This would give the compressor size necessary to meet the five-day integrated load. The size of the storage tank needed to last over the five-day period could then be determined using parametric runs.

## IMPROVED COOLING TOWER MODEL

### Discussion

The cooling tower algorithm in PLANT has been completely rewritten to better simulate open cooling towers. Some of the old keywords are no longer used, or have new meanings. In addition, the use of the performance curves is entirely different. Consequently, all keywords used to model a tower, both existing and new, are summarized below.

While the old algorithm gave reasonable results for wetbulb temperatures above 60°F, results could be in error by more than 500% for a 30°F wetbulb. Consequently, past versions of DOE-2 might predict tower performance reasonably well, provided the tower operated only during the warmer months. During winter months, the program could substantially overestimate the tower electrical consumption and underestimate tower capacity. The new algorithm gives very accurate results for wetbulbs between 30-85°F, ranges of 2-18°F, and approaches of 4-26°F. These are the conditions under which the curves were developed. The curves are stable down to wetbulbs of 0°F and approaches of 80°F at 0°F wetbulb. The program allows the curves to be extrapolated down to 0°F wetbulb. Previous versions of DOE-2 limited the wetbulb to be no less than 30°F. This, coupled with the problem of underestimating tower capacity at low wetbulbs, could result in poor estimates of available free cooling in many winter climates (strainer cycle and/or thermo-cycle systems). The new algorithm will predict substantially better performance for these types of systems. The new algorithm can also simulate variable speed fans. In addition, the default fan power consumption is lower than previously to better reflect the design of modern towers commonly installed in commercial buildings today.

### PLANT-EQUIPMENT

<b>TYPE</b>	specifies the type of cooling tower to be simulated.
<i>OPEN-TWR</i>	simulates an open tower wherein the fluid flowing through the tower is cooled by direct evaporation. This is the type of tower commonly used with water chillers.
<b>SIZE</b>	is the nominal rated output capacity, expressed in units of one million Btu's per hour, of each cell in the cooling tower. The capacity is the capacity of the tower at the TWR-DESIGN-WETBULB, TWR-DESIGN-APPROACH and TWR-DESIGN-RANGE as specified in PLANT-PARAMETERS. If SIZE = -999 is entered, the program will automatically size the tower based on the cooling equipment specified, the MAX-NUMBER-AVAIL of each type of cooling equipment, the design wetbulb and approach temperatures specified in PLANT-PARAMETERS. The range will be determined using the *-TO-TWR-WTR keywords in PLANT-PARAMETERS for the specified cooling equipment. Only one type and size of cooling tower may be entered.

In the left column above, bold-faced words are commands, non-bold words are keywords, and italicized words are code-words.

INSTALLED-NUMBER is the total number of cells of the type and size previously specified. If not entered, the program will determine the number of cells required, based on a maximum load of 15 million Btu/hr per cell

MAX-NUMBER-AVAIL has the same meaning as all other types of equipment.

### PART-LOAD-RATIO

For cooling towers, MIN-RATIO and MAX-RATIO have different meanings than other types of equipment.

TYPE accepts the code-word which identifies the type of equipment to which the part load ratios specified in this instruction are applicable. Code-word for the tower is OPEN-TWR.

MIN-RATIO specifies the smallest allowable fraction of the nominal flow rate for which the cooling tower is still rated. The nominal flow rate is determined at The Cooling Tower Institute (CTI) rating conditions of 95°F entering fluid temperature, 85°F leaving fluid temperature, and 78°F approach (95-85-78). These conditions correspond to a range of 10°F and an approach of 7°F. The default is 0.33. You should refer to TWR-CELL-CTRL in PLANT-PARAMETERS for more information on the meaning of this keyword.

MAX-RATIO specifies the largest allowable ratio of actual flow rate to nominal flow rate determined at the CTI conditions. The default is 2.0. You should refer to TWR-CELL-CTRL in PLANT-PARAMETERS for more information on the meaning of this keyword.

OPERATING-RATIO is not used for the tower simulation.

ELEC-INPUT-RATIO the electric input to nominal capacity ratio for the cooling tower fan is expressed as ratio = (fan electric power in Btu/hr) / (SIZE in Btu/hr) where SIZE is the heat rejection capacity per cell as specified or defaulted in the PLANT-EQUIPMENT command. If not specified, the program will default the fan power consumption of an open tower to 0.0154 HP/gpm at the CTI rating conditions. This corresponds to an ELEC-INPUT-RATIO of approximately 0.0105 Btu/Btu.

PLANT-PARAMETERS

All previous keywords not explicitly listed below are no longer valid, including RFACT-CFM-EXPONENT, TWR-CELL-MAX-GPM, TWR-FAN-CONTROL, and TWR-TEMP-CONTROL. Other keywords have changed in meaning.

**TWR-DESIGN-WETBULB** is the wetbulb temperature used in the cooling tower design calculations. If not specified, the default is 78°F, which corresponds to the point at which towers are nominally rated by the Cooling Tower Institute. Specifying a higher wetbulb with other conditions fixed (including design approach) will cause the program to use a larger tower than otherwise. Energy consumption may then either increase or decrease depending on the method of TWR-CAP-CTRL and the temperature setpoint.

**TWR-DESIGN-APPROACH** is the approach used in the cooling tower design calculations. If not specified, the default is 7°F, which corresponds to the point at which towers are nominally rated by the Cooling Tower Institute. Specifying a higher approach with other conditions fixed (including design wetbulb) will cause the program to use a smaller tower than otherwise. Energy consumption may then either increase or decrease depending on the method of TWR-CAPACITY-CTRL and the temperature setpoint.

**TWR-DESIGN-RANGE** is the range used to calculate the design water flowrate when a SIZE is explicitly entered in the PLANT-EQUIPMENT command. If the SIZE is not entered, then the tower is sized based on nominal chiller capacity, and the water flowrate determined using the \*-TO-TWR-WTR keywords in PLANT-PARAMETERS.

**TWR-SETPT-CTRL** specifies the control for the exiting fluid temperature setpoint. The default is FIXED.

*FIXED*

the default, controls the tower to the fixed setpoint specified by TWR-WTR-SETPOINT. Tower capacity adjusts according to the TWR-CAP-CTRL. To simulate a tower whose temperature floats with the load and wetbulb, simply specify a low setpoint, such as 60°F.

*WETBULB-RESET*

causes the setpoint to drop as the wetbulb drops. This approach recognizes that, as the wetbulb drops, the exiting tower temperature can also drop without any increase in tower energy consumption (although tower energy might otherwise be saved). At design conditions, the tower setpoint will be

$$\text{setpoint} = \text{TWR-DESIGN-WETBULB} + \text{TWR-DESIGN-APPROACH}$$

For a given load, a tower cannot achieve the same approach as the wetbulb drops (the approach will increase). Accordingly, the program will modify the approach as the wetbulb drops as

follows:

$$\begin{aligned} \text{APP} &= (\text{TWR-DESIGN-WB} - \text{TWB}) \\ &\quad * \text{TWR-RESET-RATIO} \\ &\quad + \text{TWR-DESIGN-APP} \end{aligned}$$

Setpoint = TWB + APP, where APP is the achievable approach, and TWB is the current hour's wetbulb temperature.

TWR-SETPT-T

specifies the exiting water temperature setpoint when the TWR-SETPT-CTRL is FIXED; default is 80°F.

TWR-THROTTLE

is the throttling range (default 5°F) of the setpoint defined by TWR-SETPT-T. Often, in centrifugal chillers, the tower temperature controller is set to maintain a fixed temperature at full load and to allow the temperature to drop at partial loads. In that case, this keyword is the difference between the temperature setting at full load and the temperature setting at no load. When a variable speed fan is used, setting this value to a relatively broad range will allow the fan to slowly unload as the tower temperature drops. In many cases, this strategy may result in the best overall system efficiency. TWR-THROTTLE also modifies the setpoint calculated when TWR-SETPT-CTRL is WETBULB-RESET. It has no influence on the setpoint used in the free cooling strategies.

MIN-TWR-WTR-T

specifies the minimum temperature for leaving tower cooling water when TWR-SETPT-CTRL is WETBULB-RESET. This value acts as a lower limit on tower temperature as the wetbulb drops (chiller capacity may be impaired otherwise). The default is 65°F. TWR-RESET-RATIO specifies the ratio of the change in achievable approach with wetbulb. The default is 0.29. The default value is accurate for an open tower at full load. Oftentimes, however, the load may be less at lower wetbulbs since lower wetbulbs often correspond to lower drybulbs and reduced building loads. To take this effect into account, you may want to experiment with other values, such as 0.40.

TWR-CELL-CTRL

in multiple-cell towers, specifies whether the controls attempt to operate only the number of cells needed, or as many cells as possible. Options are:

*MIN-CELLS*

the default, indicates that only the actual number of cells needed will be used. All other cells will be shut down with no water flow. If the tower is controlling to a fixed setpoint, the gallons/minute capacity per cell will increase as the wetbulb drops. The program will attempt to use as few cells as possible to cool the fluid. In no case, however, will the flow per cell be allowed to exceed the MAX-RATIO as specified in the

	PART-LOAD-RATIO command.
<i>MAX-CELLS</i>	indicates that all cells will be used in parallel. In no case, however, will the flow per cell be allowed to drop below the MIN-RATIO as specified in the PART-LOAD-RATIO command (unless only one cell is operating). This strategy will enhance the energy savings associated with two-speed or variable speed fans, and is strongly recommended.
TWR-CAP-CTRL	specifies the control method which regulates the tower exit temperature. The default is ONE-SPEED-FAN, which simulates a one-speed fan cycling on and off. Options are:
<i>FLUID-BYPASS</i>	utilizes a three-way valve to bypass water around the cooling tower. The valve modulates to maintain the tower setpoint. The tower fan runs continuously during all hours that a heat rejection load exists.
<i>ONE-SPEED-FAN</i>	the default, causes the one-speed-fan to cycle to maintain the tower setpoint. Note that DOE-2 assumes the fan can cycle as often as required to maintain the setpoint. In actual practice, fan cycling is usually limited to no more than 4-8 cycles per hour to protect the motor against burnout. This can cause wide fluctuations in the condenser loop temperature, which is not modeled in DOE-2.
<i>TWO-SPEED-FAN</i>	causes the fan to cycle between off, low, and high speeds to maintain the tower setpoint.
<i>VARIABLE-SPEED-FAN</i>	modulates the airflow so that tower capacity exactly matches the load at the desired setpoint. This code-word simulates both variable speed drives as well as variable pitch fans. Power consumption at reduced airflows is calculated using the TWR-FAN-FPLR curve in the EQUIPMENT-QUAD command.
TWR-FAN-OFF-CFM	is the airflow rate through the tower when the fans are off. That is, this is the flow rate caused by natural convection, divided by the flow rate at high speed (design).
TWR-FAN-LOW-CFM	specifies the ratio of airflow through the tower when the fans are on low speed, to the airflow at high speed. This keyword is used only when the TWR-CAP-CTRL is TWO-SPEED.
TWR-FAN-LOW-ELEC	specifies the ratio of the power consumed by the fan at low speed to the power consumed at high speed. This keyword is used only when the TWR-CAP-CTRL is TWO-SPEED.
TWR-MIN-FAN-SPEED	when a variable speed fan is used, specifies the minimum fraction of at nominal fan speed at which the fan can operate. The default is 0.40. If the load is such that the tower will

overcool the fluid at this minimum speed, then the fan will cycle between off and minimum speed. It is possible that the tower fan may reach a "critical speed" as the airflow is reduced. This is because the static pressure capability of the fan will drop as the square of the speed. The static pressure drop of the tower, however, may not fall off as the square of the airflow, as air flowing through falling water does not obey the ideal fan laws. As a result, the fan may enter a "surge region" if the speed is sufficiently low. For specific applications, the tower manufacturer should be consulted.

TWR-PUMP-HEAD	is the pressure head in the tower water circulation loop. This head is used together with the fluid flowrate, impeller efficiency and motor efficiency to determine the power consumption of the condenser pump. Default is 60 ft.
TWR-IMPELLER-EFF	specifies the impeller efficiency of the tower circulation pump. Default is .77.
TWR-MOTOR-EFF	specifies the efficiency of the tower pump motor. Default is .9.
DIRECT-COOL-MODE	accepts a code-word that defines the direct cooling control scheme, if any. In either direct cooling mode, the tower will attempt to control to the DC-TWR-WTR-SETPT. The default for this keyword varies according to mode.
<i>NOT-AVAILABLE</i>	the default
<i>STRAINER-CYCLE</i>	allows cooling tower water to be passed directly (or through a heat exchanger) into the chilled water loop.
<i>THERMO-CYCLE</i>	simulates the use of compression chillers as heat exchangers without electric input into the compressor.
DC-MAX-OAT	specifies the maximum outdoor drybulb temperature for which direct cooling is allowed. Above this temperature, direct cooling is terminated, regardless of whether it could be effective.
DC-MAX-CHILL-WTR-T	specifies the maximum chilled water temperature for which direct cooling is allowed, either strainer cycle or thermo cycle. For strainer cycle systems, this temperature is the maximum allowable temperature leaving the tower. Above this temperature, direct cooling will be terminated. If a heat exchanger is used (not directly modeled by the program), this temperature is the temperature leaving the tower and entering the heat exchanger. As such, its value should be lower than when no heat exchanger is used. For thermo-cycle systems, this temperature is the temperature leaving the chiller. Thermo-cycle cooling will be terminated when the chiller(s) cannot satisfy the load while maintaining this temperature. (The



CHILL-WTR-T and CHILL-WTR-THROTTLE are ignored during direct cooling.)

DC-TWR-WTR-SETPT

is the leaving tower water temperature which the controller will attempt to maintain when using direct cooling. For a STRAINER-CYCLE, the default is 45°F. The tower will attempt to maintain this temperature. If the temperature floats above the DC-MAX-CHILL-WTR-T, then direct cooling will be terminated. For a THERMO-CYCLE, the default is 40°F. The tower will control to this temperature, and the chiller will control to the DC-MAX-CHILL-WTR-T.

DIRECT-COOL-SCH

accepts a u-name of a schedule. When the hourly value specified in the schedule is 1.0, direct cooling is allowed. When the value is 0.0, direct cooling is not allowed.

DIRECT-COOL-KW

specifies the electrical input to direct cooling auxiliary equipment. The default varies according to the direct cooling mode. If DIRECT-COOL-MODE = THERMO-CYCLE, you should specify DIRECT-COOL-KW as kW/ton of operating capacity for the period during which the compression chillers are operating in this mode. The chiller electrical input is assumed to be DIRECT-COOL-KW multiplied by the operating capacity and the fraction of the hour the chiller ran. If DIRECT-COOL-MODE = STRAINER-CYCLE, you should specify DIRECT-COOL-KW as the electrical input to the condenser water pumps (and other added equipment), calculated as kW/ton of SYSTEMS peak cooling load. Usually, this value is zero as the chilled water pumps are assumed to provide all motive energy. If a heat exchanger is used to isolate the tower from the chilled water loop, then this value should be non-zero to model the condenser pumping energy. In this case, the condenser water pumping energy is calculated using the value of DIRECT-COOL-KW as the kW per ton of the design SYSTEMS load. (Fluid flow to the tower is assumed to be the design chilled water flowrate). For both modes of direct cooling, THERMO-CYCLE and STRAINER-CYCLE, the chilled water pumps are assumed to run as usual.

The following two keywords are repeated here as the meaning of CHILL-WTR-THROTTLE is expanded:

CHILL-WTR-T

specifies the chilled water temperature at the middle of the throttling range for chillers. The default is 44°F.

CHILL-WTR-THROTTLE

is the throttling range of the temperature controller on the chiller. The default is 2.5°F. A positive value for this keyword causes the chilled water temperature setpoint to drop as the load drops. This release of the program can now accept a negative value for this keyword. When negative, the chilled

water setpoint *rises* as the load *drops*. This approximates some of the chiller reset optimization strategies commonly used.

EQUIPMENT-QUAD

TWR-FAN-FPLR

accepts the u-name of a CURVE-FIT instruction that defines a cubic equation. That equation will be used to express the tower fan horsepower as the airflow drops as a fraction of the horsepower at full airflow.

TWR-GPM-FRA

accepts the u-name of a CURVE-FIT instruction that defines a bi-quadratic equation. That equation will be used to express an intermediate variable which is a function of the range and approach. The intermediate variable is in turn used in the curve TWR-GPM-FWB.

TWR-GPM-FWB

accepts the u-name of a CURVE-FIT instruction that defines a bi-quadratic equation. That equation defines the current tower capacity relative to the capacity at the CTI design conditions. It is a function of TWR-GPM-FRA, defined above, and the wetbulb temperature.

TC-CHLR-CAP-FT

accepts the u-name of a CURVE-FIT instruction that defines a bi-linear or bi-quadratic equation. that equation will be used to express the compression chiller capacity as a function of condenser and chiller water temperature while operating in the direct cooling, THERMO-CYCLE mode.

## REVISED CIRCULATION PUMP SIMULATIONS

### Introduction

Variable speed circulation pumps and methods of sizing circulation pumps can be specified in DOE-2 with the use of nine PLANT-PARAMETERS keywords. In earlier versions of DOE-2, the simulation of hot and cold water circulation pumps was restricted to fixed speed pumps that were sized to meet the peak demands of the previous SYSTEMS run. Now, options allow for the sizing of the pumps to be based on either the SYSTEMS peak (as before) or the sum of the installed capacities of either the heating equipment or cooling equipment. Once sized, the pumps may be run in either a fixed speed or variable speed mode. For the latter mode, a minimum part-load ratio may be specified to place a floor on the electrical consumption of the pumps. The pipe distribution losses are considered a constant loss with either FIXED-SPEED or VARIABLE-SPEED pumps.

### PLANT-PARAMETERS

#### **CCIRC-SIZE-OPT**

accepts a code-word that indicates the load that the chilled water circulation pumps will be sized to meet. The allowable code-words are SYSTEM-PEAK (the default) and INST-PLANT-EQUIP.

#### *SYSTEM-PEAK*

Specifying SYSTEM-PEAK will result in the pumps being sized to meet the peak load passed from SYSTEMS.

#### *INST-PLANT-EQUIP*

Specifying INST-PLANT-EQUIP will result in the pumps being sized to meet the total installed capacity of PLANT-EQUIPMENT specified (regardless of whether this equipment was specified by default or input by you).

#### **HCIRC-SIZE-OPT**

accepts a code-word that indicates the load that the hot water circulation pumps will be sized to meet. The allowable code-words and definitions are identical to those available for CCIRC-SIZE-OPT.

#### **CCIRC-PUMP-TYPE**

accepts a code-word that specifies whether the chilled water circulation pumps are fixed or variable speed pumps. The allowable code-words are FIXED-SPEED (the default) and VARIABLE-SPEED. If this keyword is set equal to VARIABLE-SPEED, then losses will be determined on the basis of the actual loads being served by the pumps.

#### **HCIRC-PUMP-TYPE**

accepts a code-word that specifies whether the hot water circulation pumps are fixed or variable speed pumps. The allowable code-words and definitions are identical to those available for CCIRC-PUMP-TYPE.

---

In the left column above, bold-faced words are commands, non-bold words are keywords, and italicized words are code-words.

Supplement — 2.1E Update

CCIRC—MIN—PLR accepts a numeric value between 0. and 1. that places a floor on the electricity consumption of the chilled water circulation pumps. It is expressed as a fraction of the full load electricity consumption of the pumps. The default is 0.50, and the range is from 0.+ to 1.0.

HCIRC—MIN—PLR accepts a numeric value between 0. and 1. that places a floor on the electricity consumption of the hot water circulation pumps. It is expressed as fraction of the full load electricity consumption of the pumps. The default is 0.50, and the range is from 0.+ to 1.0.

New keywords have been added to allow the electrical usage of hot-water pumps, chilled-water pumps and miscellaneous pumps to be assigned. They are

HCIRC—ELEC—METER accepts the inputs of M1, M2, M3, M4 or M5. The default is meter M1.

CCIRC—ELEC—METER accepts the inputs of M1, M2, M3, M4 or M5. The default is meter M1.

MISC—ELEC—METER accepts the inputs of M1, M2, M3, M4 or M5. The default is meter M1. Miscellaneous electrical includes the electrical usage of solar systems and component-based thermal energy systems. Meters for conventional storage are specified like other equipment under the PLANT—EQUIPMENT command.

## PLANT EQUIPMENT OPERATING MODES

### Introduction

The 2.1C version of DOE-2 featured an entirely reworked conception of the operation of chillers and, more importantly, electricity-generating prime movers. Earlier versions of the code simply assumed that, in the case of the electricity generators, only the electrical demands of a facility were important to decisions concerning the operation of a central plant. This reasoning stemmed from the fact that utility and regulatory attitudes toward the on-site generation of power often meant that generating power on-site was tantamount to leaving the electric grid entirely. The Public Utilities Regulatory Policy Act of 1978 mandated changes in those attitudes by requiring that utilities abandon discriminatory practices and offer fair rates and prices to cogenerators and small power producers. The outcome of this change is that the actual electrical loads of a facility need not be the only consideration in determining the output of primary energy conversion equipment in a central plant.

The concept embodied in DOE-2 treats the diesel engine and gas turbine as energy conversion devices with two useful outputs — heat and electricity. Accordingly, the choice of which output to use in controlling the operation of these machines has been made an explicit option that you can specify. That is, you can now specify that the machines generate enough heat to meet thermal loads irrespective of the amount of electricity produced and vice-versa.

Please note that the following have been eliminated:

ELEC—GEN—MODE  
 MAX—DIESEL—EXH  
 MAX—GTURB—EXH  
 STURB—SPEED

### PLANT—PARAMETERS

COGEN—TRACK—MODE and COGEN—TRACK—SCH	used to specify the load (thermal or electrical) to be used in controlling the output of either the DIESEL—GEN or GTURB—GEN electrical generators.
MIN—TRACK—LOAD	used to specify the minimum thermal load that will be tracked.
DIESEL—TRACK—MODE	specifies which thermal output(s) (jacket/lube-oil heat, exhaust heat, or both) are to be used for control of thermal-tracking for diesel engines
DBUN—MIN—HEAT	sets the minimum thermal load for heat recovery chillers when operating in tandem with standard chillers. When the DBUN—CHLR is operating alone, it responds to the evaporator load and not the thermal load.

Note: The freedom to choose which loads the central plant equipment is to meet has resulted in a substantial reworking of the equipment allocation routines and the HEAT—RECOVERY links. For example, the default allocation routines now ensure that the thermal and electrical output of

the generators, when coupled with absorption and compression chillers, will be balanced when meeting heating and cooling loads. The input formats to the LOAD-ASSIGNMENT and the HEAT-RECOVERY commands have not changed, although the commands have taken on more capabilities.

### LOAD-ASSIGNMENT and HEAT-RECOVERY

- COGEN-TRACK-MODE** accepts a code-word that specifies the cogeneration scheme to be used in controlling the output of electrical generators equipped with heat recovery equipment. The allowable code-words are TRACK-ELEC (the default value), TRACK-THERMAL, TRACK-LESSER (of the two previous options), its antithesis TRACK-GREATER, MAX-OUTPUT (full-out electrical generating), and DONT-RUN.
- COGEN-TRACK-SCH** accepts the u-name of a schedule of cogeneration schemes. A DAY-SCHEDULE command does not accept code-words, therefore the following values are used to indicate the desired cogeneration scheme:  
DONT-RUN = 0  
TRACK-ELEC = 1  
TRACK-THERMAL = 2  
TRACK-LESSER = 3  
TRACK-GREATER = 4  
MAX-OUTPUT = 5  
An example of such a schedule appears in Example 3, p.4.53.
- MIN-TRACK-LOAD** specifies the minimum thermal load that the generators will attempt to track before shifting down. The default is 0.0 Btu/hr, and it can range from 0.0 to 1000.0.
- DIESEL-TRACK-MODE** accepts a code-word that specifies which diesel engine heat recovery source(s) will be used to control the output of the engine when tracking thermal loads. The allowable code-words are TRACK-EXH (exhaust heat only), TRACK-JAC/LUB (jacket and lube-oil), and TRACK-BOTH (the default).
- DBUN-MIN-HEAT** is the minimum thermal load at which the heat recovery chiller(s) are allowed to operate when in the heat recovery mode and when tracking thermal loads. This keyword will default to 0.0 MBtu/hr. The range is from 0.0 to 1000000.0 MBtu/hr.

**LOAD--ASSIGNMENT**

LOAD--ASSIGNMENTS for electrical generators are always defined in terms of electrical, not thermal, loads. If cogeneration equipment is to be controlled on the basis of thermal loads (COGEN--TRACK--MODE = TRACK--THERMAL) and a LOAD--ASSIGNMENT(s) is to be used to determine which pieces of cogeneration equipment are to run, the program will use the LOAD--ASSIGNMENT as follows: For every electrical LOAD--RANGE you input under the cogeneration LOAD--ASSIGNMENT the program will calculate an equivalent thermal load range that is the sum of the nominal recoverable outputs of all equipment listed under that LOAD--RANGE. Thus, when the program is controlling cogeneration equipment on the basis of a thermal load, it will compare the hourly thermal load to the thermal load ranges corresponding to the electrical LOAD--RANGE(s) that you input. The LOAD--RANGE selected will be the one whose equivalent thermal load range matches the hourly thermal load.

To make this discussion more apparent, consider the comments contained in this example input for diesel generators.

**LOAD--ASSIGNMENT**

·  
·  
·

LOAD--RANGE = 1.0 \$THE DOE-2 EQUIVALENT THERMAL LOAD RANGE IS ~1.2 MBTUH\$

PLANT--EQUIPMENT = 300KW--GEN NUMBER = 1

LOAD--RANGE = 2.6 \$THE DOE-2 EQUIVALENT THERMAL LOAD RANGE IS ~3.2 MBTUH\$

PLANT--EQUIPMENT = 750KW--GEN NUMBER = 1 ..

The thermal load ranges are calculated by the program; you do not input them. At peak capacity (100% part load ratio), the diesel generator is operating at 35% efficiency with a 20% exhaust heat efficiency and 23% jacket/lube-oil heat efficiency (the defaults). Therefore, the thermal load range at that full load condition is equal to the electric load range times  $(20 + 23) / 35$  (or 1.22). This relationship changes as the generator loading drops, which lowers the efficiency of the diesel engine. This results in a consequent increase in the ratio of recoverable energy to electrical output. Notice that the thermal load range of a gas turbine at full load (using the default efficiencies) is  $55 / 19$  (or 2.89) times the electrical output.

**Note on the Default Operation of Chillers**

If you don't define the operation of chillers through use of the LOAD--ASSIGNMENT and LOAD--MANAGEMENT commands, the default algorithms use information from the keyword SOURCE--SITE--EFF under the ENERGY--RESOURCE command (as well as the EIRs and HIRs of the equipment) to determine whether a heat-driven chiller is more efficient than an electrically-driven one on the basis of source Btu consumption. A cogeneration plant, of course, produces electricity more efficiently than does a central plant, provided the waste heat is utilized. Therefore, SOURCE--SITE--EFF for RESOURCE = ELECTRICITY should be revised to, say, 0.5 (implying a net heat rate of about 6800 Btu/kWh). The disadvantage of this modification, however, is that the source Btu number in the BEPS report will be inconsistent with the generally agreed upon figures.

## HEAT-RECOVERY

Associated with the previous PLANT-PARAMETERS keywords are the following rules for the HEAT-RECOVERY command:

### Rules:

- 1) If a diesel is to thermal track, the exhaust heat and jacket heat should not be entered at the same heat recovery supply level unless the diesel is to track both the exhaust *and* jacket heat. If the diesel is to track on the basis of the exhaust at  $\sim 600^{\circ}\text{F}$  or the jacket at  $\sim 240^{\circ}\text{F}$ , the two supplies should be input at different levels.
- 2) If diesels and gas turbines are in the same plant and exhaust heat is to be recovered from both, the exhaust supplies should be entered at the same level.
- 3) If diesels and gas turbines are in the same plant, and the diesels are to thermal track, they should not be allowed to track on the basis of jacket heat; they should track either on exhaust heat, or both exhaust and jacket heat.
- 4) The program assumes that cogeneration equipment with heat recovery will not coexist in a plant with double-bundle chillers. If this situation does exist, you should control the operation of equipment with LOAD-ASSIGNMENTS.
- 5) When both absorption and compression chillers are in the same plant with cogeneration equipment, and the program is to optimize the cooling operation, you should exercise care in the assignment of the heat recovery linkages. Normally, space heating and other thermal demands should be input before absorption demands so that the absorption chillers will be given only enough of the cooling load needed to use up the excess waste heat. The compression chillers will then be used to satisfy the remainder of the cooling load. This sequence will prevent the boilers from operating unnecessarily. See Example 1, next page.
- 6) The default operation of the double-bundle chiller is one of tracking the thermal heating loads whenever standard chiller(s) are operated in tandem with double-bundle chillers. When the standard chiller(s) shut down for lack of a sufficient minimum part-load, the double-bundle chiller must track the cooling load. You should input a LOAD-ASSIGNMENT if both standard and double-bundle chillers are to be loaded evenly with respect to their evaporators.



## Examples of Plant Equipment Operating Modes

### Example 1: Chillers, Gas Turbine, and Boiler

We begin the examples with a complete input for a plant with a two-stage absorption chiller, a compression chiller, a gas turbine, and a boiler. Subsequent examples will build upon and modify this input. In this example, you want the gas turbine to run full out at all times. By omitting any specification of a LOAD-ASSIGNMENT for the chillers the program will balance the distribution of the cooling load between the absorption and compression chiller to minimize wasting heat.

```

BOIL          = PLANT-EQUIPMENT  TYPE = STM-BOILER
              SIZE                = 5.0 MAX-NUMBER-AVAIL = 1  ..

ELEC-CHLR     = PLANT-EQUIPMENT  TYPE = OPEN-CENT-CHLR
              SIZE                = 2.0 MAX-NUMBER-AVAIL = 1  ..

STM-CHLR      = PLANT-EQUIPMENT  TYPE = ABSOR2-CHLR
              SIZE                = 3.0 MAX-NUMBER-AVAIL 1  ..

TWR           = PLANT-EQUIPMENT  TYPE = COOLING-TWR
              SIZE                = -999  ..

ELEC-GENR     = PLANT-EQUIPMENT  TYPE = GTURB-GEN
              SIZE                = 3.0 MAX-NUMBER-AVAIL 1  ..
    
```

#### PLANT-PARAMETERS

```

COGEN-TRACK-MODE = MAX-OUTPUT  ..
    
```

#### HEAT-RECOVERY

```

SUPPLY-1 = (GTURB-GEN)           $ SPACE HEAT HAS PRIORITY
DEMAND-1 = (SPACE-HEAT)         $ ON WASTE HEAT. ABSORPTION
SUPPLY-2 = (GTURB-GEN)           $ CHILLER ONLY GETS THE
DEMAND-2 = (ABSOR2-CHLR)        $ EXCESS. CENTRIFUGAL WILL
                                  $ PICK UP THE REST OF COOLING
                                  $ LOAD. THIS MINIMIZES
                                  $ BOILER OPERATION.
    ..
    
```

Supplement — 2.1E Update

**Example 2: Chillers, Diesel Generator, and Boiler**

In this example, diesel generators of 300kW and 750kW replace the gas turbine in Example 1. A LOAD—ASSIGNMENT is used to stage the generators. The 300kW diesel is to be run first, followed by the 750kW diesel, but never both (or else the facility will violate air quality standards). You want the diesels to be controlled by heating loads, and both the jacket and exhaust heat are recoverable for space heating but the recovered heat is not at a high enough temperature for a two-stage absorption chiller so it is changed to single-stage machine ABSOR1—CHLR. The thermal outputs at full load are 1.2 and 3.2MBtuh respectively. The revised input, replacing ELEC—GENR in the previous example, is:

```

300KW—GEN      =   PLANT—EQUIPMENT      TYPE = DIESEL—GEN SIZE = 1.0
                                           SIZE = 1.0
                                           MAX—NUMBER—AVAIL = 1 ..

750KW—GEN      =   PLANT—EQUIPMENT      TYPE = DIESEL—GEN
                                           SIZE = 2.6
                                           MAX—NUMBER—AVAIL = 1 ..

                PLANT—PARAMETERS      COGEN—TRACK—MODE = TRACK—THERMAL
                                           DIESEL—TRACK—MODE = TRACK—BOTH ..

                HEAT—RECOVERY          SUPPLY—1 = (DIESEL—GEN,DIESEL—JACKET)
                                           DEMAND—1 = (SPACE—HEAT)
                                           SUPPLY—2 = (DIESEL—GEN,DIESEL—JACKET)
                                           DEMAND—2 = (ABSOR1—CHLR) ..

COGEN           =   LOAD—ASSIGNMENT      TYPE = ELECTRIC
                                           LOAD—RANGE = 1.0
                                           PLANT—EQUIPMENT = 300KW—GEN
                                           NUMBER = 1
                                           LOAD—RANGE = 3.0
                                           PLANT—EQUIPMENT = 750KW—GEN
                                           NUMBER = 1 ..

                LOAD—MANAGEMENT        PRED—LOAD—RANGE = 999
                                           LOAD—ASSIGNMENT = (DEFAULT,DEFAULT,COGEN) ..
    
```

The SIZES of the cogeneration equipment are in terms of electrical capacity, and so are the LOAD—RANGES. When the cogeneration equipment is thermal tracking, the program will convert the LOAD—RANGES to equivalent thermal load ranges, which are based on the full load thermal output of the equipment listed under the load range (see the discussion of how the operation of LOAD—ASSIGNMENTS is modified above).

**Example 3: Scheduling of Cogeneration Modes**

This example demonstrates the use of the keyword that allows cogeneration modes to be scheduled and would be an insert at the PLANT-PARAMETERS command in Example 2. A contractual agreement with the utility requires that the full capacity of the electrical plant be on-line during the on-peak hours of the utility. During the off-peak hours the machines revert to the thermal tracking mode to ensure that the fuel consumed by the generators will be utilized fully. A similar input to the one shown below is also featured in the *Sample Run Book (2.1E)*, Run 5 of the 31 Story Office Building and coordinates the operation of the PLANT with the utility rates input in ECONOMICS.

```

                PLANT-PARAMETERS    DIESEL-TRACK-MODE = TRACK-BOTH
                COGEN-TRACK-SCH = UTL-CONTRCT ..

WINTER-WD      =  DAY-SCHEDULE      (1,8) (2) $ TRACK-THERMAL IS CODE 2
                (9,22) (5) $ MAX-OUTPUT IS CODE 5
                (23,24) (2) ..

WINTER-WEH     =  DAY-SCHEDULE      (1,24) (0) $ DONT-RUN IS CODE 0 $ ..

SUMMER-WD      =  DAY-SCHEDULE      (1,8) (2) (9,20) (5) (21,24) (2) ..

SUMMER-WED     =  DAY-SCHEDULE      (1,24) (0) ..

UTL-CONTRCT   =  SCHEDULE    THRU MAY 15  (WD) WINTER-WD
                                (WEH) WINTER-WEH
                                THRU SEP 15  (WD) SUMMER-WD
                                (WEH) SUMMER-WEH
                                THRU DEC 31  (WD) WINTER-WD
                                (WEH) WINTER-WEH ..
    
```

## ELECTRICAL GENERATOR SIMULATIONS

### Introduction

The algorithms used to model the performance of electrical generators have been modified to permit easier translation of manufacturer's information to actual simulations. The modifications take the form of simpler transfer functions relating the inputs and outputs of the equipment being modeled. A PLANT-PARAMETERS command specifies the full load conversion efficiency of an input to an output. The EQUIPMENT-QUAD command is then used to relate the full load performance to operations at fractions of full load. The default values for the part load operation of the generators have also been changed. Finally, there are hourly report variables for the Diesel (DIESEL-GEN, 11 through 17), Gas Turbine (GTURB-GEN, 10 through 13), and Steam Turbine (STURB-GEN, 8 through 13). See Appendix A for full descriptions.

### PLANT-PARAMETERS

The following have been eliminated: MAX-DIESEL-EXH, MAX-GTURB-EXH, and STURB-SPEED.

DIESEL-GEN-EFF	specifies the diesel engine conversion efficiency of fuel to electricity at full load. The unloading curve is given by DIESEL-I/O-FPLR. The default is 0.35, and the range is from 0.+ to 1.0.
DIESEL-EXH-EFF	specifies the diesel engine conversion efficiency of fuel to recovered energy from exhaust gasses at full load. The unloading curve is given by DIESEL-EXH-FPLR. The default is 0.23, and the range is from 0.+ to 1.0.
DIESEL-J/L-EFF	specifies the diesel engine conversion efficiency of fuel to recovered energy from the jacket and lube-oil at full load. The unloading curve is given by DIESEL-JCLB-FPLR. The default is 0.20, and the range is from 0.+ to 1.0.
GTURB-GEN-EFF	specifies the gas turbine conversion efficiency of fuel to electricity at full load. The unloading curve is given by GTURB-I/O-FPLR. The default is 0.19, and the range is from 0.+ to 1.0.
GTURB-EXH-EFF	specifies the gas turbine conversion efficiency of fuel to recovered energy from exhaust gasses at full load. The unloading curve is given by GTURB-EXH-FPLR. The default is 0.55, and the range is from 0.+ to 1.0.
STURB-MECH-EFF	specifies the mechanical efficiency of the steam turbine in converting theoretical work (defined as an isentropic enthalpy drop through the turbine; see discussion under EQUIPMENT-QUAD) to an electrical output at full load. The unloading curve is STURB-I/O-FPLR. The default is

0.10, and the range is from 0.+ to 1.0.

STEAM-SATURATION-T remains unchanged in its definition, but is no longer used by the diesel and gas turbine simulation routines to calculate the amount of heat recoverable from exhaust gas.

### EQUIPMENT-QUAD

The following curves have been eliminated: DIESEL-JAC-FPLR, DIESEL-LUB-FPLR, DIESEL-STACK-FU, GTURB-EXH-FT, GTURB-I/O-FT, GTURB-STACK-FU and GTURB-TEX-FT.

Also, the functional form of ABSOR1-HIR-FPLR has been changed to a linear or quadratic equation from a cubic one. Table 4.3 contains a list of the default values for the curves described below, as well as changes in some existing ones. Table 4.2 contains a list of the default values for the minimum, maximum, and optimum PART-LOAD-RATIOS for the electrical generators.

#### Diesel

DIESEL-I/O-FPLR accepts the u-name of a CURVE-FIT instruction that defines a linear or quadratic equation. This equation correlates full load fuel consumption to the fraction of that consumption consumed at other loads (expressed as part load ratios). In conjunction with the PLANT-PARAMETERS instruction DIESEL-GEN-EFF, the equation is used to calculate the amount of diesel fuel energy required to generate a given electrical load.

DIESEL-EXH-FPLR accepts the u-name of a CURVE-FIT instruction that defines a linear or quadratic equation. This equation correlates the full load exhaust heat recovery to the fraction of that recovery recovered at other loads (expressed as part load ratios). In conjunction with the PLANT-PARAMETERS instruction DIESEL-EXH-EFF, the equation is used to calculate the amount of exhaust heat recovered at a given electrical load.

DIESEL-JCLB-FPLR accepts the u-name of a CURVE-FIT instruction that defines a linear or quadratic equation. This equation correlates the full load jacket and lube oil heat recovery to the fraction of that recovery recovered at other loads (expressed as part load ratios). In conjunction with the PLANT-PARAMETERS instruction DIESEL-J/L-EFF, the equation is used to calculate the amount of jacket and lube oil heat recovered at a given electrical load.

DIESEL-TEX-FPLR accepts the u-name of a CURVE-FIT instruction that defines a linear or quadratic equation. This equation correlates the temperature of the exhaust gasses to the load being met (expressed as a part load ratio).

Gas Turbine

GTURB—CAP—FT

accepts the u-name of a CURVE—FIT instruction that defines a linear or quadratic equation. This equation adjusts the nominal capacity rating of a gas turbine as a function of outdoor drybulb temperature. The adjustment takes the form of a value for RMAX corresponding to the ratio of highest generating capacity attainable, given the outdoor drybulb temperature, to the nominal rating.

GTURB—I/O—FPLR

accepts the u-name of a CURVE—FIT instruction that defines a linear or quadratic equation. This equation correlates full load fuel consumption to the fraction of that consumption consumed at other loads (expressed as part load ratios). In conjunction with the PLANT—PARAMETERS instruction GTURB—GEN—EFF, the equation is used to calculate the gas turbine fuel energy required to generate a given electrical load.

GTURB—EXH—FPLR

accepts the u-name of a CURVE—FIT instruction that defines a linear or quadratic equation. This equation correlates full load exhaust heat recovery to the fraction of that recovery recovered at other loads (expressed as part load ratios). In conjunction with the PLANT—PARAMETERS instruction GTURB—EXH—EFF, the equation is used to calculate exhaust heat recovered at a given electrical load.

GTURB—TEX—FPLR

accepts the u-name of a CURVE—FIT instruction that defines a linear or quadratic equation. This equation correlates the temperature of the exhaust gasses to the load being met (expressed as a part load ratio).

**Steam Turbine**

**STURB-ENTH-FPIX**

accepts the u-name of a CURVE-FIT instruction that defines a bi-quadratic equation. This equation correlates inlet and exhaust pressures to an isentropic enthalpy drop, which is expressed as a theoretical steam rate (lbs/kWh).

Note: When performing curve-fits for STURB-ENTH-FPIX, you are cautioned to ensure consistency between the enthalpy of the inlet pressure implied by the PLANT-PARAMETERS keywords STURB-T and STURB-PRES, and the isentropic enthalpy drop derived from tables of theoretical steam rates.

**STURB-I/O-FPLR**

accepts the u-name of a CURVE-FIT instruction that defines a linear or quadratic equation. This equation expresses the electrical output of a steam turbine at part loads as a function of full load. In conjunction with STURB-MECH-EFF, this curve will determine the fraction of the theoretical steam rate (calculated with STURB-ENTH-FPIX) that is converted to electricity.

Table 4.2			
Default Values for PART-LOAD-RATIO			
Plant-Equipment	MIN	MAX	OPT
DIESEL-GEN	0.15	1.1	0.95
GTURB-GEN	0.30	1.1	1.0
STURB-GEN	0.10	1.1	1.0

Table 4.3

## Default Performance Curves for EQUIPMENT-QUAD

Equations are assumed to take the form:

$$F = a + bx + cx^2 + dy + ey^2 + fxy \text{ or } F = a + bx + cx^2 + dx^3$$

Keyword	Independent Var(s)	Default Curve Coefficients						Curve u-name
		a	b	c	d	e	f	
<b>Diesel</b>								
DIESEL-I/O-FPLR	PLR	0.107000	0.8930000	—	—	—	—	FUELD
DIESEL-EXH-FPLR	PLR	0.024516	0.3323871	0.6430968	—	—	—	THMHI
DIESEL-JCLB-FPLR	PLR	0.287936	1.0204516	-0.3083871	—	—	—	THMLO
DIESEL-TEX-FPLR	PLR	383.3300	466.67000	—	—	—	—	EXTEMP
<b>Gas Turbine</b>								
GTURB-CAP-FT	ODB	1.240000	-0.0041000	—	—	—	—	GTCAP
GTURB-I/O-FPLR	PLR	0.442979	0.3974000	0.1569621	—	—	—	FUELG
GTURB-EXH-FPLR	PLR	0.295626	0.4930194	0.2113548	—	—	—	THMXH
GTURB-TEX-FPLR	PLR	442.0910	255.73000	144.00000	—	—	—	EXTMP
<b>Steam Turbine</b>								
STURB-ENTH-FPIX	Pin,Pout	38.79236	-0.2113856	0.00052878	1.0200875	0.0009166	-0.00349944	KEENAN
STURB-I/O-FPLR	PLR	0.488308	0.994154	-0.482462	—	—	—	TURBD
<b>Absorption-Chiller</b>								
ABSOR1-HIR-FPLR	PLR	0.877733	0.7449211	0.1673056	—	—	—	HIRPLR1



## PLANT OPERATING STRATEGIES

### Introduction

Most building plants are composed of one or more heating boilers, one or more chillers, a service hot water heater, and a cooling tower (or air-cooled condenser). In addition there are chilled-water and condenser-water pumps, gas or oil burners, and fans for the tower and burners. Usually the equipment is of one type (e.g., the chillers are either reciprocating or centrifugal) and all heating equipment is fired with the same fuel type. In this case, the DOE-2 PLANT input is simple and the program has no difficulty sizing the equipment automatically and simulating optimal performance.

However, many plants may be complex. An example is a retrofit where one of the two original absorption chillers is to be replaced by a new centrifugal chiller, and where the owner wants to base load the centrifugal using the remaining absorption chiller on peak days. To model this situation we have to specify the "load management" strategy that determines how the two different chillers are to be operated.

Even more complicated plants are possible, such as those with cogeneration or thermal energy storage systems. Often, the key to operating such plants effectively is to coordinate the operation to the time-of-use rate periods established by the utility company. Again, load management has to be specified in DOE-2.

### Examples:

Following are annotated examples to help you prepare inputs for a variety of common plant configurations and operating strategies. The examples are presented in order of increasing complexity:

- 1) No plant - all heating and cooling is done by packaged units in SYSTEMS.
- 2) A simple plant with boiler, chiller, and domestic hot water heater.
- 3) Heat recovery from a double bundle chiller.
- 4) Heat recovery from an engine driven chiller.
- 5) Sequencing of two differently sized boilers.
- 6) Lead/lag operation of two differently sized chillers.
- 7) Using an absorption chiller for peak shaving of electric demand.
- 8) Using a natural-gas engine generator for peak shaving by scheduling it on during the utility's on-peak periods.
- 9) Sequencing the operation of a gas turbine and diesel engine so that the gas turbine part load never drops below 50%.
- 10) Recovering heat from a diesel generator engine jacket to heat both the building and domestic hot water using instantaneous heat exchangers. The generator only operates from 7 a.m. to 10 p.m.
- 11) A cogeneration system that recovers heat from a gas turbine generator and provides it to a two-stage absorption chiller, with the remaining heat available for heating the building and domestic hot water.

Supplement — 2.1E Update

- 12) A cogeneration system that recovers heat from a gas turbine generator and diesel generator engine exhaust and provides it to a two-stage absorption chiller. The remaining recovered heat is available for heating the building and domestic hot water. Both generators track the electric load except that from 1 p.m. to 5 p.m. during summer months the generators run at maximum output and the excess electricity is sold back to the utility. The gas turbine fuel is diesel oil and the turbine does not run below a 0.5 part load ratio.

Input Descriptions for Typical Plant Configurations\*

1) No plant - all heating and cooling by packaged units in SYSTEMS

INPUT PLANT ..

A plant must be input in order for plant reports to be printed. A plant is also needed to pass fuel and electric energy consumption to the ECONOMICS section of DOE-2.

DHWH = PLANT-EQUIPMENT  
TYPE = DHW-HEATER  
SIZE = -999 ..

When there is no domestic hot water load input in LOADS, you should input TYPE = COOLING-TWR as a dummy since the program requires at least one type of equipment.

END ..  
COMPUTE PLANT ..

---

\* DOE-2 input is shown on the left-hand side and notes to individual lines of input are given on the right-hand side.

Supplement — 2.1E Update

2) A simple plant with boiler, chiller, and domestic hot water heater

INPUT PLANT ..

HWG = PLANT-EQUIPMENT

TYPE = HW-BOILER

SIZE = -999

Boiler will be sized automatically. Whenever the actual size of equipment is known, the simulation accuracy will be improved by using that information in the input.

The installed number defaults to one.

INSTALLED-NUMBER = 1 ..

CHW = PLANT-EQUIPMENT

TYPE = HERM-REC-CHLR

SIZE = -999

Chillers will be sized automatically and load split evenly between two units.

INSTALLED-NUMBER = 2 ..

DHW = PLANT-EQUIPMENT

TYPE = DHW-HEATER

SIZE = -999 ..

PLANT-PARAMETERS

BOILER-FUEL = FUEL-OIL

DHW-HEATER-FUEL = FUEL-OIL ..

Demonstrates how to change the fuel type (defaults : to NATURAL-GAS for domestic hot water heaters).

END ..

COMPUTE PLANT ..

3) Heat recovery from a double bundle chiller

INPUT PLANT ..

HWG = PLANT-EQUIPMENT  
TYPE = HW-BOILER  
SIZE = -999 ..

The boiler will supplement the recovered heat from the double bundle chiller.

CHW = PLANT-EQUIPMENT  
TYPE = DBUN-CHLR  
SIZE = -999 ..

HEAT-RECOVERY  
SUPPLY-1 = (DBUN-CHLR)  
DEMAND-1 = (SPACE-HEAT) ..

This is the default for HEAT-RECOVERY and is therefore not required input.

(or)

HEAT-RECOVERY  
SUPPLY-1 = (DBUN-CHLR)  
DEMAND-1 = (SPACE-HEAT,  
PROCESS-HEAT) ..

Specifies that heat recovered from the double-bundle chiller be assigned to both space heating and domestic water heating, with space heating (SPACE-HEAT) taking precedence over domestic hot water heating (PROCESS-HEAT). If a *domestic hot water heater* is input, it will take precedence over heat recovery, not supplement it.

END ..  
COMPUTE PLANT ..

4) Heat recovery from an engine driven chiller

INPUT PLANT ..

HWG = PLANT-EQUIPMENT  
TYPE = HW-BOILER  
SIZE = -999 ..

The program will size the boiler for the peak heating load. The boiler will supplement the heat recovery.

ECH = PLANT-EQUIPMENT  
TYPE = ENG-CHLR  
SIZE = 2.0 ..

The manufacturers recommend that an engine chiller be sized at less than the peak cooling load so that it will operate in an overload condition at peak load. Therefore you should manually size the unit.

HEAT-RECOVERY  
SUPPLY-1 = (ENG-CHLR)  
DEMAND-1 = (SPACE-HEAT,  
PROCESS-HEAT) ..

Engine heat-exchanger furnished with the unit. Space heating takes precedence over domestic hot water.

Note that if a domestic hot water heater is input, it will take precedence over heat recovery, not supplement it.

END ..  
COMPUTE PLANT ..

5) Sequencing of two differently-sized boilers

INPUT PLANT ..

HWG1 = PLANT-EQUIPMENT  
TYPE = HW-BOILER  
SIZE = 2.0  
INSTALLED-NUMBER = 1 ..

2 million Btu/hr output capacity.  
Manual sizing is required for this situation.

HWG2 = PLANT-EQUIPMENT  
TYPE = HW-BOILER  
SIZE = 3.0  
INSTALLED-NUMBER = 1 ..

3 million Btu/hr output capacity.

BOILER-CTRL = LOAD-ASSIGNMENT  
TYPE = HEATING  
OPERATION-MODE = RUN-NEEDED  
LOAD-RANGE = 5.0  
PLANT-EQUIPMENT = HWG1  
NUMBER = 1  
PLANT-EQUIPMENT = HWG2  
NUMBER = 1 ..

This input overrides program optimization routines.  
Identifies the function of the equipment involved.  
The boilers will run in sequence.  
Maximum anticipated combined load.  
The 1st boiler to run in this load range.  
The number of units is mandatory input.  
The 2nd boiler to run in this load range.

LOAD-MANAGEMENT  
PRED-LOAD-RANGE = 99

Required input. A large value signifies that no threshold applies.

LOAD-ASSIGNMENT = (BOILER-CTRL,  
DEFAULT,  
DEFAULT) ..

BOILER-CTRL is the u-name of the heating load assignment. The load assignment u-names for cooling and electric are defaulted, which means the program will control any cooling equipment and source of electricity.

END ..  
COMPUTE PLANT ..

Supplement — 2.1E Update

6) Lead-lag operation of two differently-sized chillers

INPUT PLANT ..

CHW1 = PLANT-EQUIPMENT  
TYPE = HERM-REC-CHLR  
SIZE = 2.0

2 million Btu/hr output capacity. Manual sizing is required for this situation.

INSTALLED-NUMBER = 1 ..

CHW2 = PLANT-EQUIPMENT  
TYPE = HERM-REC-CHLR  
SIZE = 3.0  
INSTALLED-NUMBER = 1 ..

3 million Btu/hr output capacity.

CHILLER-CTRL = LOAD-ASSIGNMENT  
TYPE = COOLING  
OPERATION-MODE = RUN-NEEDED  
LOAD-RANGE = 4.0  
PLANT-EQUIPMENT = CHW1  
    N = 1  
PLANT-EQUIPMENT = CHW2 N = 1  
LOAD-RANGE = 99  
PLANT-EQUIPMENT = CHW2 N = 1  
PLANT-EQUIPMENT = CHW1  
    N = 1 ..

This input overrides program optimization routines. We are assigning cooling equipment. The chillers will run in sequence. Chiller CHW1 will lead CHW2 up to 4.0 MBtuh. The 1st chiller to run in this range. The abbreviation for NUMBER = 1. The 2nd chiller to run in this range. From 4.0 to 99 MBtuh chiller CHW2 will lead CHW1: The 1st chiller to run in this range. The 2nd chiller to run in this range.

LOAD-MANAGEMENT  
PRED-LOAD-RANGE = 99

No threshold applies.

LOAD-ASSIGNMENT = (DEFAULT,  
                  CHILLER-CTRL,  
                  DEFAULT) ..

CHILLER-CTRL is the u-name of the cooling load assignment.

END ..  
COMPUTE PLANT ..



7) Using an absorption chiller for peak shaving electric demand.

INPUT PLANT ..

STM = PLANT-EQUIPMENT  
 TYPE = STM-BOILER  
 SIZE = 4.5 ..

The size of the steam boiler is matched to the absorption chiller, i.e.  $4.5 = 3.0 / (.66 \text{ COP})$ .

ABS = PLANT-EQUIPMENT  
 TYPE = ABSOR1-CHLR  
 SIZE = 3.0 ..

Chiller sizes must be entered; automatic sizing is not consistent with two different units, both of which are full sized.

CHW = PLANT-EQUIPMENT  
 TYPE = HERM-CENT-CHLR  
 SIZE = 3.0 ..

Chiller sizes must be entered; automatic sizing is not consistent with two different units, both of which are full sized.

OFF-PEAK = LOAD-ASSIGNMENT  
 TYPE = COOLING  
 LOAD-RANGE = 3  
 PLANT-EQUIPMENT = CHW  
 NUMBER = 1 ..

This assignment allows a centrifugal chiller to run.

PEAK-DEMAND = LOAD-ASSIGNMENT  
  
 TYPE = COOLING  
 LOAD-RANGE = 3  
 PLANT-EQUIPMENT = ABS  
 NUMBER = 1 ..

This assignment allows an absorption chiller to run, thus lowering the electric demand.

LOAD-MANAGEMENT  
 HEAT-MULTIPLIER = 0.0

The contribution of heating to summer peak demand is estimated at 0.0.

COOL-MULTIPLIER = .20

The contribution of cooling to summer peak is primarily compressor energy.

ELEC-MULTIPLIER = 1.0

The total contribution of lights and equipment, fans, etc., to electric demand is 100%.

PRED-LOAD-RANGE = \*\*\*

Your estimate of the threshold electric demand (in MBtuh) below which the centrifugal is allowed to run.

LOAD-ASSIGNMENT = (DEFAULT,

Supplement – 2.1E Update

OFF-PEAK, DEFAULT)

OFF-PEAK is the load assignment that references the centrifugal chiller.

PRED-LOAD-RANGE = 99

An electric demand (in MBtuh) between \*\*\* and 99 will cause the absorption chiller to run.

LOAD-ASSIGNMENT = (DEFAULT,  
PEAK-DEMAND, DEFAULT) ..

PEAK-DEMAND is the load assignment that references the absorption chiller. The u-name is in the cooling position since cooling demand when converted to electric demand is being addressed.

END ..  
COMPUTE PLANT ..

Supplement - 2.1E Update

- 8) Using a natural-gas engine generator for peak shaving by scheduling it on during the utility's on-peak periods.

INPUT PLANT ..

GGEN = PLANT-EQUIPMENT  
TYPE = DIESEL-GEN  
SIZE = .34 ..

Fuel defaults to natural gas  
Capacity of a 100kW gas engine generator expressed in MBtuh.

PLANT-PARAMETERS  
DIESEL-FUEL = NATURAL-GAS  
DIESEL-GEN-EFF = .28 ..

Changes fuel type from diesel to natural gas. The default.  
To reset efficiency representing a naturally aspirated gas engine.

OFF-PEAK = LOAD-ASSIGNMENT  
TYPE = ELECTRICAL  
LOAD-RANGE = 99  
PLANT-EQUIPMENT = UTILITY  
NUMBER = 99 ..

A large number representing maximum anticipated load.  
UTILITY represents purchased electricity.  
NUMBER when used for a UTILITY must be the maximum demand in MBtuh.

ON-PEAK = LOAD-ASSIGNMENT  
TYPE = ELECTRICAL  
LOAD-RANGE = 99  
PLANT-EQUIPMENT = GGEN  
NUMBER = 1  
PLANT-EQUIPMENT = UTILITY  
NUMBER = 99 ..

No threshold applies.  
Referencing the gas generator first makes it base loaded.

The utility picks up any load above that satisfied by the gas engine generator.

WD-P-HRS = DAY-ASSIGN-SCH  
(1,12) (OFF-PEAK)  
(13,18) (ON-PEAK)  
(19,24) (OFF-PEAK) ..

Reference the OFF-PEAK load assignment.  
Reference the ON-PEAK load assignment.  
Reference the OFF-PEAK load assignment.

WEH-HRS = DAY-ASSIGN-SCH  
(1,24) (OFF-PEAK) ..

Again we reference the OFF-PEAK load assignment for use on weekends and holidays.

DEMAND-CTRL = SCHEDULE THRU DEC 31

Supplement — 2.1E Update

(WD) WD-P-HRS  
(WEH) WEH-HRS ..

WD stands for weekdays.  
WEH stands for weekends and holidays.

LOAD-MANAGEMENT

PRED-LOAD-RANGE = 99  
ASSIGN-SCHEDULE = (DEFAULT,  
                  DEFAULT,  
                  DEMAND-CTRL) ..

No threshold applies.

Here we reference the DEMAND-CTRL schedule,  
which has the generator on from noon to 6  
p.m. during the week and off at all other times.

END ..  
COMPUTE PLANT ..

- 9) Sequencing the operation of a gas turbine and diesel engine so that the gas turbine part load never drops below 50%. Both the diesel engine and gas turbine operate on diesel fuel.

INPUT PLANT ..

TURB = PLANT-EQUIPMENT  
TYPE = GTURB-GEN

SIZE = 6.8

FUEL-METER = M2  
INSTALLED-NUMBER = 1 ..

A characteristic of gas turbines is that they do not operate efficiently at part loads less than 50%. Always size generators in MBtuh; here the electrical output is 2000 kW \* 3413 = 6.8 MBtuh.

DGEN = PLANT-EQUIPMENT  
TYPE = DIESEL-GEN

SIZE = 3.4

FUEL-METER = M2  
INSTALLED-NUMBER = 2  
MAX-NUMBER-AVAIL = 1 ..

The diesel engine unloads more efficiently and will be used to trim the electric load.  
The size is 1000 kW

Only one of two diesel generators will be used; the other provides standby capacity during maintenance.

GEN-CTRL = LOAD-ASSIGNMENT

TYPE = ELECTRICAL  
LOAD-RANGE = 3.4  
PLANT-EQUIPMENT = DGEN  
N = 1

LOAD-RANGE = 9.8

PLANT-EQUIPMENT = TURB  
N = 1

PLANT-EQUIPMENT = DGEN  
N = 1 ..

The type of equipment is electrical.  
Up to 1000 kW only one diesel generator will run.

From 1000 kW to 3000 kW the generators will be sequenced.

The gas turbine is the first on and will start at 1000 kW or 50% load.

From 2000 kW to 3000 kW both units will run.

LOAD-MANAGEMENT

PRED-LOAD-RANGE = 99  
LOAD-ASSIGNMENT = (DEFAULT,

No threshold applies.

ENERGY-RESOURCE

RESOURCE = DIESEL-FUEL  
FUEL-METERS = (M2) ..  
DEFAULT, GEN-CTRL) ..

END ..

COMPUTE PLANT ..

Supplement — 2.1E Update

- 10) Recovering heat from a diesel generator engine jacket to heat both the building and domestic hot water using instantaneous heat exchangers. The generator operates only from 7 a.m. to 10 p.m.

INPUT PLANT ..

HWG = PLANT-EQUIPMENT  
TYPE = HW-BOILER  
SIZE = -999 ..

This sizes the boiler to maximum heating load.

DGEN = PLANT-EQUIPMENT  
TYPE = DIESEL-GEN  
SIZE = .34 ..

A 100 kW diesel engine generator is installed that uses diesel oil.

HEAT-RECOVERY  
SUPPLY-1 = (DIESEL-JACKET)  
DEMAND-1 = (SPACE-HEAT,  
PROCESS-HEAT) ..

Only heat from the engine jacket is recovered.

Building heat is first to be satisfied and any excess goes to domestic hot water.

DGEN-ON = LOAD-ASSIGNMENT  
  
TYPE = ELECTRICAL  
LOAD-RANGE = .34  
  
PLANT-EQUIPMENT = DGEN  
NUMBER = 1 ..

This load assignment is used to schedule the diesel generator.

Up to 100 kW (.34 MBtuh), the diesel generator is base loaded.

The utility supplements the diesel as the default condition.

DGEN-OFF = LOAD-ASSIGNMENT  
  
TYPE = ELECTRICAL  
LOAD-RANGE = 99  
P-E = UTILITY N = 99 ..

This load assignment covers the period that the generator is not operating.

N = 99 (NUMBER = 99) is the peak anticipated electrical load.

DGEN-SCH = DAY-ASSIGN-SCH  
(1,7) (DGEN-OFF)  
(8,22) (DGEN-ON)  
(23,24) (DGEN-OFF) ..

This schedule controls the daily generator operation, which requires use of the DAY-ASSIGN-SCH instruction.

DGEN-CTRL = SCHEDULE  
THRU DEC 31 (ALL)  
DGEN-SCH ..

ALL means all days of the week.  
The DAY-ASSIGN-SCH is referenced.

Supplement — 2.1E Update

LOAD-MANAGEMENT

PRED-LOAD-RANGE = 99

ASSIGN-SCHEDULE = (DEFAULT,  
DEFAULT,  
DGEN-CTRL) ..

Heating and cooling are defaulted;  
u-name of the schedule is  
referenced for electrical.

END ..

COMPUTE PLANT ..

Supplement - 2.1E Update

- 11) A cogeneration system that recovers heat from a gas turbine generator for use by a two stage absorption chiller, with the remaining heat available for heating the building and domestic hot water.

INPUT PLANT ..

ABS = PLANT-EQUIPMENT  
TYPE = ABSOR2-CHLR  
SIZE = -999 ..

A two stage absorption chiller with automatic sizing. Approximately 19.7 MBtuh is recoverable from the gas turbine.

STMB = PLANT-EQUIPMENT  
TYPE = STM-BOILER  
SIZE = -999 ..

A steam boiler to supplement the heat recovered from the gas turbine. You should adjust capacity of boiler to insure that it meets the total requirements of absorption chiller minus recoverable heat.

GTUR = PLANT-EQUIPMENT  
TYPE = GTURB-GEN  
SIZE = 6.8 ..

A gas turbine electric generator of 2000 kW capacity (6.8 MBtuh) has a peak efficiency of 0.19. Therefore its input energy is  $6.8/0.19 = 35.8$  and approximately 55% of this heat may be recovered.

HSTO = PLANT-EQUIPMENT  
TYPE = HTANK-STORAGE  
SIZE = 167 ..

A storage tank to store hot water for building heat and domestic hot water. The SIZE is MBtu stored, not the physical size. In this case  $500 \text{ K gal} * 8.33 \text{ lb/gal} * 40\text{F dt} = 167 \text{ MBtu}$  stored heat.

HEAT-RECOVERY

SUPPLY-1=(GTURB-GEN)

Heat source is exhaust gas from the gas turbine.

DEMAND-1=(ABSOR2-CHLR)

The first priority for heat at the highest temperature level is the absorption chiller, which requires 125-lb steam.

SUPPLY-2=(GTURB-GEN,HTANK-STORAGE)

The source for SUPPLY-2 is turbine exhaust but the absorption chiller has first priority. The HTANK-STORAGE is a supplier since the tank has stored heat as a DEMAND-3.

DEMAND-2=(SPACE-HEAT,PROCESS-HEAT)

The order in which the demands occur sets their priority over each other.

SUPPLY-3=(GTURB-GEN)

All remaining heat goes to storage.

DEMAND-3=(HTANK-STORAGE) ..

Here the HTANK-STORAGE is a demand.



Supplement -- 2.1E Update

GGEN-OP = SCHEDULE THRU DEC 31 (ALL) (1,24) (1) ..	This schedule controls when heat is recoverable for charging the storage.
ENERGY-STORAGE	
HEAT-STORE-RATE = 19.7	This is the maximum rate only when there is no other demand.
HEAT-SUPPLY-RATE = ***	You must set this to match the building heating load.
HEAT-STORE-SCH = GGEN-OP	References the schedule for when heat can be recovered.
HTANK-LOSS-COEF = 200	The tank's UA value (the heat loss from the surface of the tank per degree temperature difference between the environment and the storage medium (Btuh/F)); you must calculate this.
HTANK-BASE-T = 140	Is the return water temperature of the building heating system.
HTANK-T-RANGE = 40	Is the temperature drop of the heating water loop.
HTANK-ENV-T = 70 ..	Is the average ambient temperature surrounding the tank.
HRCVY = LOAD-ASSIGNMENT	Whenever ENERGY-STORAGE is used, the program requires a LOAD-ASSIGNMENT to tie the storage tank and supplemental heating equipment together.
TYPE = HEATING	
LOAD-RANGE = 99	No threshold applies.
PLANT-EQUIPMENT = HSTO	References the u-name of the storage.
NUMBER = 1	
PLANT-EQUIPMENT = STMB	References the u-name of the boiler supplementing the storage.
NUMBER = 1 ..	
ELEC = LOAD-ASSIGNMENT	This assignment controls operation of the gas turbine, which is always on.
TYPE = ELECTRICAL	
LOAD-RANGE = 6.8	The capacity of the gas turbine.
PLANT-EQUIPMENT = GTUR	References the u-name of the gas turbine.
NUMBER = 1 ..	
LOAD-MANAGEMENT	
PRED-LOAD-RANGE = 99	No threshold applies.
LOAD-ASSIGNMENT = (HRCVY, DEFAULT,ELEC) ..	The u-name of the heating load assignment. ELEC is the u-name of the electric load assignment.
END ..	
COMPUTE PLANT ..	

Supplement - 2.1E Update

- 12) A cogeneration system that provides recovered heat from a gas turbine generator and a diesel generator's engine exhaust to a two-stage absorption chiller. The remaining recoverable heat from the diesel generator's jacket is available through storage for heating the building and domestic hot water. Both generators track the electric load, except that from 1 p.m. to 5 p.m. during summer months the generators run at maximum output and excess electricity is sold to the utility. The entire plant operates on diesel oil; the turbine does not run below a 0.5 part load ratio.

INPUT PLANT ..

ABS = PLANT-EQUIPMENT  
TYPE = ABSOR2-CHLR

A two stage absorption chiller with automatic sizing.

SIZE = -999  
INSTALLED-NUMBER = 2 ..

STMB = PLANT-EQUIPMENT  
TYPE = STM-BOILER  
SIZE = -999

A steam boiler to supplement the heat recovered from the gas turbine. You should adjust capacity of boiler to insure that it meets the total requirements of absorption chiller minus recoverable heat.

FUEL-METER = M2 ..

GTURB = PLANT-EQUIPMENT  
TYPE = GTURB-GEN  
SIZE = 6.8

A gas turbine electric generator of 2000 kW capacity (6.8 MBtuh) has a peak efficiency of 0.19. Therefore its input energy is  $6.8/.19 = 35.8$  MBtuh; approximately 55% of this heat may be recovered.

FUEL-METER = M2 ..

GGEN = PLANT-EQUIPMENT  
TYPE = DIESEL-GEN  
SIZE = 3.4

A diesel engine generator of 1000 kW capacity (3.4 MBtuh) has a peak efficiency of 0.35. Therefore its input energy is  $3.4/.35 = 9.7$  MBtuh; approximately 23% of this heat may be recovered from the exhaust and another 20% from the jacket/lube oil.

FUEL-METER = M2 ..

HSTO = PLANT-EQUIPMENT  
TYPE = HTANK-STORAGE  
SIZE = 167 ..

A storage tank to store hot water for building heat and domestic hot water. The SIZE is MBtu stored, not the physical size. In this case  $500 \text{ K gal} * 8.33 \text{ lb/gal} * 40\text{F dt} = 167 \text{ MBtu}$  stored heat.

Supplement — 2.1E Update

HEAT-RECOVERY

SUPPLY-1 = (GTURB-GEN;  
DIESEL-GEN)

The source of high temperature heat is exhaust gas from the gas turbine and diesel engine.

DEMAND-1 = (ABSOR2-CHLR)

The first priority for heat at the highest temperature level is the absorption chiller which requires 125-lb steam.

SUPPLY-2 = (GTURB-GEN,  
DIESEL-GEN,  
HTANK-STORAGE)

SUPPLY-2 is heat remaining from turbine and diesel exhaust after the absorption chillers are satisfied. The diesel jacket and lube oil heat occurs at lower temperatures and can be used only for building heat and domestic hot water. HTANK-STORAGE is a supplier since the tank has stored any remaining heat at DEMAND-3.

DEMAND-2 = (SPACE-HEAT,  
PROCESS-HEAT)

SUPPLY-3 = (GTURB-GEN,  
DIESEL-GEN,  
DIESEL-JACKET)

SUPPLY-3 is heat remaining including jacket heat of the diesel generator.

DEMAND-3 = (HTANK-STORAGE) ..

The storage tank is heated by any heat left over after the building and domestic hot water loads are satisfied. Here the HTANK-STORAGE is a demand.

GGEN-OP = SCHEDULE  
THRU DEC 31 (ALL)  
(1,24) (1) ..

This schedule controls when the storage is seen by the simulation as a heating load.

ENERGY-STORAGE

HEAT-STORE-RATE = 23.8

This is the maximum combined rate only when there is no other demand.

HEAT-SUPPLY-RATE = \*\*\*

You must set this to match the building heating load.

HEAT-STORE-SCH = GGEN-OP

References the schedule for when heat can be recovered.

HTANK-LOSS-COEF = 200

Is the heat loss from the surface of the tank per degree temperature difference between its environment and stored medium (Btuh/F). It must be calculated by you.

HTANK-BASE-T = 140

Is the return water temperature of the building heating system.

HTANK-T-RANGE = 40

Is the temperature drop of the heating water loop.

HTANK-ENV-T = 70 ..

Is the average ambient temperature surrounding the tank.

Supplement - 2.1E Update

HRCVY = LOAD-ASSIGNMENT

TYPE = HEATING  
LOAD-RANGE = 99  
PLANT-EQUIPMENT = HSTO  
NUMBER = 1  
PLANT-EQUIPMENT = STMB  
NUMBER = 1 ..

Whenever ENERGY-STORAGE is used, the program requires a load assignment to tie the storage tank and supplemental heating equipment together.

No threshold applies.  
References the u-name of the storage.

References the u-name of the boiler supplementing the storage.

ELEC = LOAD-ASSIGNMENT

TYPE = ELECTRICAL  
LOAD-RANGE = 3.4  
PLANT-EQUIPMENT = GGEN  
NUMBER = 1  
LOAD-RANGE = 99  
PLANT-EQUIPMENT = GTURB  
N = 1  
PLANT-EQUIPMENT = GGEN  
N = 1 ..

This assignment controls operation of the gas turbine and diesel which are always on.

Up to this capacity the diesel generator will run.  
References the u-name of the diesel generator.

From 3.4 to maximum capacity both generators will run.

The order in which the units appear specifies how they are sequenced.

SELL-E = DAY-SCHEDULE  
(1,13) (1)  
(14,17) (5)  
(18,24) (1) ..

A value of 1 signifies track electric and a value of 5 signifies run at max output to sell electricity from 1 p.m. to 5 p.m.

NO-SELL = DAY-SCHEDULE (1,24) (1) ..

For all other days of the year track the electric demand.

GEN-CTRL = SCHEDULE

THRU JUN 1 (ALL) NO-SELL

SEP 1 (WD) SELL-E     The contract with the utility is to sell electric during summer months on weekdays (WD).

DEC 31 (ALL) NO-SELL ..

PLANT-PARAMETERS

COGEN-TRACK-SCH = GEN-CTRL ..

This references the schedule that determines how the generators are loaded.

LOAD-MANAGEMENT

References u-name of heating load assignment, cooling defaults, and u-name of electrical load assignment.

PRED-LOAD-RANGE = 99

No threshold applies.

LOAD-ASSIGNMENT = (HRCVY,  
                  DEFAULT,  
                  ELEC) ..

ENERGY-RESOURCE

RESOURCE = DIESEL-FUEL

FUEL-METERS = (M2) ..

END ..

COMPUTE PLANT ..

## PLANT Reports

Report PS-B, "Monthly Utility and Fuel Use Summary", has been modified to individually list each electrical and fuel meter that has non-zero energy consumption for the simulation period. Energy and demand are now reported in the units specified in the ENERGY-RESOURCE command. If cogeneration equipment is present, an additional column is provided for generated power. Depending on the number of meters, this report may require 1-3 pages.

In DOE-2.1E, in the BEPS report, "Building Energy Performance Summary", the categories of use now correspond to the end uses (Area Lights, Space Heat, Space Cool, Vent Fans, etc.) defined in "Metering and Reporting of Energy End Uses", p.3.4.

There are three new PLANT reports in DOE-2.1E:

PS-E "Monthly Energy End Use Summary"  
summarizes the monthly energy use and peak by electrical and fuel end uses (Area Lights, Space Heat, Space Cool, etc.).

PS-F "Energy-Resource Peak Breakdown by End-Use"  
shows the end-use components of the peak demand for each ENERGY-RESOURCE (electricity, natural gas, etc.).

BEPU "Building Energy Performance Summary (Utility Units)"  
is identical to the BEPS report except that the end use breakdown for each ENERGY-RESOURCE is given in the actual units of consumption, such as kWh or therms.

See Appendix C for a more detailed description of these new reports.

EQUIPMENT-QUAD DEFAULT CURVES

EQUIPMENT-QUAD DEFAULT CURVES

Equations are assumed to take the form:

Linear:  $z = a + bx$

Bi-Linear:  $z = a + bx + dy$

Quadratic:  $z = a + bx + cx^2$

Bi-Quadratic:  $z = a + bx + cx^2 + dy + ey^2 + fxy$

Cubic:  $z = a + bx + cx^2 + dx^3$

Keyword	Independent Variables	a	b	c	d	e	f	Default Curve U-Name	Type of Curve
<b>COOLING EQUIPMENT: Absorption Chillers</b>									
ABSOR1-CAP-FT	TOUT,TIN	0.723412	0.079006	-0.000897	-0.025285	-0.000048	0.000276	ACAPT1	BI-QUAD
ABSOR1-HR-FPLR	PLR	0.098585	0.583850	0.560658	-0.243093	0.000000	0.000000	HIRPLR1	CUBIC
ABSOR1-HR-FT	TOUT,TIN	0.652273	0.000000	0.000000	-0.000545	0.000055	0.000000	HIRT1	BI-QUAD
ABSOR2-CAP-FT	TOUT,TIN	-0.816039	-0.038707	0.000450	0.071491	-0.000636	0.000312	ACAPT2	BI-QUAD
ABSOR2-HR-FPLR	PLR	0.013994	1.240449	-0.914883	0.660441	0.000000	0.000000	HIRPLR2	CUBIC
ABSOR2-HR-FT	TOUT,TIN	1.658750	0.000000	0.000000	-0.029000	0.000250	0.000000	HIRT2	BI-QUAD
ABSORG-HR-FT	TOUT	4.42871284	-0.13298607	0.00125331	-	-	-	HIRT3	QUAD
ABSORG-HIR1-FT1	TIN	0.86173749	-0.00708917	0.0010251	-	-	-	HIRT11	QUAD
ABSORG-HR-FPLR	PLR	0.13551150	0.61798084	0.24651277	-	-	-	HIRPLR3	QUAD
ABSORG-CAP-FT	TOUT,TIN	1.0	0.	0.	0.	0.	0.	ACAPT3	BI-QUAD
ABSG-HCAP-FQC	CL	0.863599	-1.30495346	0.44135284	-	-	-	HCAPQC	QUAD
<b>COOLING EQUIPMENT: Compression Chillers</b>									
HERM-CENT-CAP-FT	TOUT,TIN	-1.742040	0.029292	-0.000067	0.048054	-0.000291	-0.000106	CCAPT3	BI-QUAD
HERM-CENT-ER-FPLR	PLR	0.222903	0.313387	0.463710	-	-	-	EIRPLR3	QUAD
HERM-CENT-ER-FT	TOUT,TIN	3.117500	-0.109236	0.001389	0.003750	0.000150	-0.000375	EIRT3	BI-QUAD
HERM-REC-CAP-FT	TOUT,TIN	-4.161461	0.207050	-0.000193	0.004723	-0.000040	-0.000087	CCAPT4	BI-QUAD
HERM-REC-ER-FPLR	PLR	0.088065	1.137742	-0.225806	-	-	-	EIRPLR4	QUAD
HERM-REC-ER-FT	TOUT,TIN	4.720965	-0.187504	0.092192	0.009209	0.000098	-0.000322	EIRT4	BI-QUAD
OPEN-CENT-CAP-FT	TOUT,TIN	-1.742040	0.029292	-0.000067	0.048054	-0.000291	-0.000106	CCAPT1	BI-QUAD
OPEN-CENT-ER-FPLR	PLR	0.222903	0.313387	0.463710	-	-	-	EIRPLR1	QUAD
OPEN-CENT-ER-FT	TOUT,TIN	3.117500	-0.109236	0.001389	0.003750	0.000150	-0.000375	EIRT1	BI-QUAD

EQUIPMENT-QUAD DEFAULT CURVES

Keyword	Independent Variables	a	b	c	d	e	f	Default Curve U-Name	Type of Curve
OPEN-REC-CAP-FT	TOUT,TIN	-4.161461	0.207050	-0.001931	0.004723	-0.000040	-0.000087	CCAPT2	BI-QUAD
OPEN-REC-EIR-FPLR	PLR	0.088065	1.137742	-0.225806	-	-	-	EIRPLR2	QUAD
OPEN-REC-EIR-FT	TOUT,TIN	4.720965	-0.187504	0.002192	0.009209	0.000098	-0.000322	EIRT2	BI-QUAD
ENG-CH-COP-FT	TOUT,TIN	1.23624	0.0168923	0.	-0.0115235	0.	0.	ECCOPT	BI-QUAD
ENG-CH-COP-FTS	TOUT,TIN	1.08815	0.0141064	0.	-0.00833923	0.	0.	ECCOPT	BI-QUAD
ENG-CH-COP-FPLR1	PLR	1.14336	0.0228899	-	-	-	-	ECCOPPLR1	LINEAR
ENG-CH-COP-FPLR2	PLR	1.38861	-0.388614	-	-	-	-	ECCOPPLR2	LINEAR
ENG-CH-COP-FPLRS	PLR	0.3802	2.3609	-	-	-	-	ECCOPPLRS	LINEAR
ENG-CH-HREJ-FT	TIN	0.705841	0.0034607	-	-	-	-	ECHREJT	LINEAR
ENG-CH-HREJ-FPLR	PLR	1.05270	-0.0526991	-	-	-	-	ECHREJPLR	LINEAR
ENG-CH-CAP-FT	TOUT,TIN	0.573597	0.0186802	0	-0.00465325	-	-	ECCAPT	BI-LINEAR
<b>COOLING EQUIPMENT: Double-Bundle Chillers</b>									
DBUN-CAP-FT	TOUT,TIN	1.000000	0.000000	0.000000	0.000000	0.000000	0.000000	DBCAPT	BI-QUAD
DBUN-CAP-FTRISE	Tdiff	1.000000	0.000000	0.000000	-	-	-	DBCAPREC	QUAD
DBUN-EIR-FPLR	PLR	0.349032	0.263871	0.387097	-	-	-	DBEIRPLR	QUAD
DBUN-EIR-FT	TOUT,TIN	-0.714258	0.000000	0.000000	0.025103	-0.000058	0.000000	DBEIRT	BI-QUAD
DBUN-EIR-FTRISE	Tdiff	1.000000	0.000800	0.000360	-	-	-	DBEIRREC	QUAD
<b>HEATING EQUIPMENT</b>									
DHW-HIR-FPLR	PLR	0.021826	0.977630	0.000543	-	-	-	-	QUAD
FURNACE-HIR-FPLR	PLR	0.018610	1.094209	-0.112819	-	-	-	-	QUAD
HW-BOILER-HIR-FPLR	PLR	0.082597	0.998764	-0.079361	-	-	-	-	QUAD
STM-BOILER-HIR-FPLR	PLR	0.082597	0.998764	-0.079361	-	-	-	-	QUAD
<b>COOLING TOWER</b>									
TWR-FAN-FPLR	AIRCEL	0.33162901	-0.88567609	0.60556507	0.94848233	0.00000000	0.00000000	TWRFAN	CUBIC
TWR-GPM-FRA	RNG,FRA	-2.22388899	0.16679543	-0.01410247	0.03222333	0.18560214	0.24251871	GPMRA	BI-QUAD
TWR-GPM-FRB	FRA,OWB	0.60531402	-0.03554536	0.00804083	0.02860259	0.00024972	0.00490857	GPMRB	BI-QUAD
TC-CHLR-CAP-FT	T <sub>cond</sub> ,T <sub>cw</sub>	-0.351443	0.056583	-0.600054	-0.045625	-0.000043	-0.000012	CCAPT5	BI-QUAD
<b>ELECTRIC GENERATING EQUIPMENT: Diesel</b>									
DIESEL-EXH-FPLR	PLR	0.314400	-0.135300	0.097260	-	-	-	REXD	QUAD



EQUIPMENT-QUAD DEFAULT CURVES

Keyword	Independent Variables	a	b	c	d	e	f	Default Curve U-Name	Type of Curve
DIESEL-I/O-FPLR	PLR	0.097550	0.631800	-0.416500	-	-	-	RELD	QUAD
DIESEL-JAC-FPLR	PLR	0.392200	-0.436700	0.277960	-	-	-	RJACD	QUAD
DIESEL-LUB-FPLR	PLR	0.088300	-0.137100	0.080300	-	-	-	RLUBD	QUAD
DIESEL-STACK-FU	KW <sub>out</sub>	0.019026	0.900000	0.000000	-	-	-	UACD	QUAD
DIESEL-TEX-FPLR	PLR	720.000000	60.000000	0.000000	-	-	-	TEXD	QUAD
<b>ELECTRIC GENERATING EQUIPMENT: Gas Turbine</b>									
GTURB-EXH-FTO	ODB	0.018226	0.000029	0.000000	-	-	-	FEXG	QUAD
GTURB-I/O-FPLR	PLR	7.683000	-13.480000	8.000000	-	-	-	FUEL1G	QUAD
GTURB-I/O-FTO	ODB	1.882200	-0.004330	0.000014	-	-	-	FUEL2G	QUAD
GTURB-STACK-FU	KW <sub>out</sub>	0.038051	0.900000	0.000000	-	-	-	UACG	QUAD
GTURB-TEX-FPLR	PLR	1.000000	0.384500	0.028150	-	-	-	TEX1G	QUAD
GTURB-TEX-FTO	ODB	408.960000	0.631700	0.000224	-	-	-	TEX2G	QUAD
<b>ELECTRIC GENERATING EQUIPMENT: Steam Turbine</b>									
STURB-I/O-FPLR	PLR	1.000000	0.000000	0.000000	-	-	-	RFSTUR	QUAD

APP	=	approach temperature (°F)	T <sub>cond</sub>	=	temperature of condenser water (°F)
CL	=	cooling load (Btu/hr)	T <sub>cw</sub>	=	temperature of chilled water (°F)
NTU	=	number of tower units per cell	T <sub>diff</sub>	=	difference between exit water temperatures with and without heat recovery (°F)
ODB	=	outside drybulb temperature (°F)	T <sub>IN</sub>	=	entering condenser water temperature (°F)
OWB	=	outside wet-bulb temperature (°F)	T <sub>OUT</sub>	=	leaving chilled water temperature (°F)
kW <sub>out</sub>	=	electrical output (kW)			
PLR	=	part-load ratio (fraction)			
RF	=	rating factor			

# E C O N O M I C S

## Table of Contents

---

---

<b>UTILITY RATE ENHANCEMENTS</b> .....	5.2
Introduction .....	5.2
Sequence of Operation .....	5.3
Discussion of UTILITY-RATE Command.....	5.3
Discussion of RATCHET Command .....	5.3
Discussion of BLOCK-CHARGE Command.....	5.4
<b>ECONOMICS Commands and Keywords Related to Utility Rates</b> .....	5.6
<b>UTILITY-RATE Command</b> .....	5.6
Cogeneration.....	5.15
<b>BLOCK-CHARGE Command</b> .....	5.16
<b>Yearly, Seasonal, and Time of Use BLOCK-CHARGES</b> .....	5.20
Example of a Yearly Rate.....	5.20
Example of a Seasonal Rate.....	5.20
Example of Time of Use Rates .....	5.22
<b>RATCHET Command</b> .....	5.27
Use of Ratchets.....	5.29
<b>Examples</b> .....	5.30
1: Basic Tariff.....	5.30
2: Simple Block Tariff for Energy.....	5.30
3: Seasonal Block Tariffs .....	5.31
4: Demand Charges and Ratchets .....	5.32
5: Rate Qualifiers and kWh/kW Blocks .....	5.33
6: Time of Use Energy Charges, Seasonal Demand Charges.....	5.36
7: Time of Use Energy and Demand Charges.....	5.37
8: Preferential Rate for a Season .....	5.40
9: kWh Blocks with Time of Use Demand .....	5.41
10: kWh/kW Blocks with 70% Winter Ratchet.....	5.43
11: kWh Blocks with Reactive Demand Charges .....	5.45
12: Mixed Energy Block Types .....	5.47
13: Gas Transportation Rate.....	5.49

## UTILITY RATE ENHANCEMENTS

### Introduction

The utility rate structures in DOE-2.1E have been enhanced to allow more flexibility in the types of rates that can be modeled. The new features include:

- improved scheduling for time of use and real time rates;
- a RATCHET command that allows multiple demand ratchets to be defined for any rate;
- rate qualifiers that allow the program to select different rates depending on monthly energy and demand thresholds;
- broader specifications of minimum monthly charges;
- taxes and surcharges on both a percent and per unit basis;
- reactive demand calculations; and
- kWh/kW limits and sum limits in the blocks.

Also, the two-season approach has been expanded to allow any number of seasons for energy charges, demand charges, and ratchets.

Meters have been defined in SYSTEMS and PLANT to allow different energy end-uses to be assigned to any one of five different meters for electricity and five different meters for fuels. For example, LOADS and SYSTEMS electrical consumption can be assigned to meter M1, while the electrical consumption of an ice-making chiller in PLANT can be assigned to meter M2 in order to take advantage of a favorable time of use rate the utility offers for TES systems.

These improvements, particularly the new scheduling methods and the RATCHET command, have caused the BDL input to change. The ENERGY-COST and CHARGE-ASSIGNMENT commands have been renamed to make their new functions clearer. Many keywords have been added, and others removed. As a result, you will have to modify input files designed to run on program releases up to and including DOE-2.1D.

The following commands have been renamed or eliminated:

<b>ENERGY-COST</b>	renamed to <b>UTILITY-RATE</b> Most keywords are different.
<b>CHARGE-ASSIGNMENT</b>	renamed to <b>BLOCK-CHARGE</b> Most keywords are different.
<b>COST-PARAMETERS</b>	Eliminated
<b>DAY-CHARGE-SCH</b>	Eliminated

In the following we give a brief overview of what the rate structure commands do and discuss the sequence of calculations; then the individual keywords are described.

---

This section was rewritten by Steven D. Gates under contract to Hirsch & Associates, with support from ElectroCom GARD, Ltd. of Niles, IL, and the Gas Research Institute of Chicago, IL.

**Sequence of Operation**

Four commands (UTILITY-RATE, BLOCK-CHARGE, RATCHET and SCHEDULE) are used in ECONOMICS for the calculation of energy costs. On an hourly basis all energy usage in LOADS, SYSTEMS and PLANT is assigned to the specified meters. This hourly data is summed in PLANT for report PS-B, and also passed to ECONOMICS. The interactions among these commands is summarized as follows:

**UTILITY-RATE** (see p. 5.6)

This command contains the most basic features of a tariff: units, uniform energy and demand cost rates, reactive demands, monthly charges, minimum charges, taxes, etc. One UTILITY-RATE command is entered for each type of energy or fuel used in the previous PLANT run. When more than one rate is used for an energy type, or the specific rate that will apply is not known, more than one UTILITY-RATE may be defined.

UTILITY-RATE also allows costs to be defined for energy that varies by time, but not by quantity. For charges that vary by quantity, such as blocks of energy with different costs, this command references one or more BLOCK-CHARGE commands.

When energy is billed in a time of use format a UTILITY-RATE keyword accepts the u-name of a schedule which defines these charges for the entire year. Time of use demand charges are more complicated and must be defined using the BLOCK-CHARGE command.

On an hourly basis, each UTILITY-RATE defined in ECONOMICS sums the energy from the specified meters and accumulates the data into total and peak values for each billing period. If a time of use energy charge schedule has been defined, the hourly values are multiplied by the scheduled value and summed for the billing period. The UTILITY-RATE also passes the hourly data to the associated BLOCK-CHARGES and RATCHETs. During each billing cycle, the UTILITY-RATE adjusts the metered energy and demand values for any minimum quantities required, and adjusts demands by any RATCHETs specified. These adjusted billing quantities are then used as the basis for the energy cost calculations. Block costs computed by any associated BLOCK-CHARGES are then added. The costs are then adjusted by any minimum monthly charges and/or rate limitations. Applicable taxes and surcharges are then computed and added to the total.

It is possible to define more than one UTILITY-RATE for the same resource or meters, and allow the program to select the correct rate to use on the basis of qualifiers you define. These qualifiers include minimum and maximum energy and demand quantities for each billing period, and also a schedule. You can also specify whether the same UTILITY-RATE must be used all year, or whether UTILITY-RATES can be switched during the course of the year.

**RATCHET** (see p. 5.27)

This command defines demand ratchets to be used in calculating billing demands. These ratchets can be referenced by both the UTILITY-RATE and BLOCK-CHARGE commands. The time period over which the RATCHET is calculated is defined by a schedule, and more than one RATCHET can be used to establish a billing demand.

RATCHETs take the hourly metered values as calculated in the parent UTILITY-RATE and determine a peak quantity for each billing period. If a schedule is specified, the RATCHET

may compute the demand for a specific season, such as summer, or for a particular time period, such as on-peak or off-peak. The ratchet may include a sliding window (such as the maximum demand over the last 3 months). In addition, the ratcheted demand may be adjusted by an offset or multiplied by a fraction. A value is calculated for each billing period for use in associated UTILITY-RATEs and BLOCK-CHARGEs.

When a RATCHET is defined with a length of one month, the ratcheted value is substituted for the actual monthly demand. This allows calculations to be made for monthly billing demands defined in formats such as "\$5.00 per kW for 80% of all kW above the first 20kW". Multiple ratchets can be defined for charges such as "the actual monthly demand, 50% of the peak winter demand, or 80% of the peak summer demand, whichever is the largest".

#### **BLOCK-CHARGE** (see p. 5.16)

This command is used to define energy or demand charges that vary according to the amount used. The time period over which a BLOCK-CHARGE is used is defined in a schedule so that different rates can be used at different times of the year. When a time of use demand charge is being assessed, this schedule allows demands to be billed for different times of the day and season.

BLOCK-CHARGEs allow costs that vary with quantity to be computed, such as \$0.05 for the first 5000 kWh, \$0.035 for the next 10000 kWh, etc. BLOCK-CHARGEs for energy and demand take the metered values for the billing period as determined in the parent UTILITY-RATE. These are adjusted by any minimum quantities and ratchets to determine the billing quantities. Block costs are calculated on the basis of the billing quantities. If a seasonal change in a schedule causes BLOCK-CHARGEs to be switched in the middle of the billing period, the calculated costs are prorated between the two BLOCK-CHARGEs on the basis of the number of hours each was active.

BLOCK-CHARGEs for time of use demands, such as on-peak and off-peak, are slightly different. Instead of taking the peak demand for the billing period as determined in the parent UTILITY-RATE, the BLOCK-CHARGE directly determines the demand for the time periods defined in its schedule. This demand is then adjusted by any associated RATCHETs (which may also be defined strictly for the same time period). This billing charge is then used in the cost calculations.

Each time of use demand period must be defined in a separate BLOCK-CHARGE. If on-peak, shoulder, and off-peak demands are calculated for two seasons, a total of 6 BLOCK-CHARGEs are required. If seasons change in the middle of a billing period, then the BLOCK-CHARGEs associated with each season must be linked to each other so that the correct demand for the billing period is computed. Costs are then based on the maximum demand found in the billing period, and are prorated on the basis of the number of hours each was active.

#### **SCHEDULE**

This command, along with DAY-SCHEDULE and WEEK-SCHEDULE, is used to coordinate the operation of the UTILITY-RATEs, BLOCK-CHARGEs and RATCHETs. Because a utility's rate structure may be complex, a SCHEDULE may need to coordinate a large number of different items. For this purpose, SCHEDULEs may be provided with user-defined flag values which are used to activate different rates, blocks, or ratchets at different times of the day or season.

You are already familiar with schedule flags. For example, the FAN-SCHEDULE in SYSTEMS uses the flag values of 0 and 1; 0 means the fan is off, and 1 means the fan is on. In ECONOMICS, 1 may represent the winter season, and 2 the summer. Similarly, for time of use demand pricing, 1.1, 1.2 and 1.3 may represent the peak, shoulder, and off-peak demand periods in winter, while 2.1, 2.2, and 2.3 are for the summer. Using flags, a time of use demand schedule can be defined as follows.

```

TOU-SCHEDULE = SCHEDULE  THRU MAR 31  (WD)      (1,6) (1.3)
                                     (7,12) (1.2)
                                     (13,18) (1.1)
                                     (19,24) (1.3)
                                     (WEH)      (1,24) (1.3)

                                     THRU OCT 15  (WD)      (1,6) (2.3)
                                     (7,12) (2.2)
                                     (13,18) (2.1)
                                     (19,24) (2.3)
                                     (WEH)      (1,24) (2.3)

                                     THRU DEC 31  (WD)      (1,6) (1.3)
                                     (7,12) (1.2)
                                     (13,18) (1.1)
                                     (19,24) (1.3)
                                     (WEH)      (1,24) (1.3) ..
    
```

Each BLOCK-CHARGE, and/or RATCHET associated with one of these periods references the schedule, and also references a specific flag. For example, the BLOCK-CHARGE and RATCHETs defined with the peak summer period would reference the flag value 2.1. Note that you define the flag values; any numbers acceptable by the SCHEDULE commands are acceptable.

Previous versions of DOE-2 were limited to two seasons for all charges. The new scheduling format used in 2.1E allows any number of seasons to be defined.

#### LIKE

The LIKE keyword can be very useful in ECONOMICS. When one UTILITY-RATE is LIKE another, all associated BLOCK-CHARGES and RATCHETs are also automatically copied; they do not need to be respecified unless they are different. This is different from the LOADS program; when one SPACE is like another, all walls, windows, etc. must be redefined.

## ECONOMICS Commands and Keywords Related to Utility Rates

The following ECONOMICS command and keyword definitions include new and existing keywords that are related to specifying utility rate structures. Prior to reading the detailed descriptions of the new commands and keywords, it is suggested that you briefly review some of the simpler examples starting on p.5.30. These examples provide a general overview of how the commands work together and should help provide perspective.

### UTILITY-RATE

**u-name** required so that each rate can be listed in the summary reports. Up to 15 different UTILITY-RATEs may be defined.

**RESOURCE** is a required keyword that determines which fuel or energy type is being valued. The code-words associated with this keyword are the same as in PLANT: STEAM, CHILLED-WATER, ELECTRICITY, NATURAL-GAS, LPG, DIESEL-OIL, FUEL-OIL, COAL, METHANOL, or OTHER-FUEL. When OTHER-FUEL is referenced, the OTHER-FUEL-NAME as defined in PLANT will be used in all reports as the RESOURCE.

Two other code-words are available for cogeneration: ELEC-NET-SALE and ELEC-BUY/SELL. See "Cogeneration" on p.5.15.

**METERS** accepts a list in parentheses of up to five meters that will be assigned to this utility rate. Acceptable code-words are M1, M2, M3, M4 or M5. If no meter is specified, the default is all meters defined in PLANT matching the RESOURCE. If no PLANT RESOURCEs are specified, NATURAL-GAS will be the default fuel and METERS will default to all five meters. In the case of ELECTRICITY, the default is always all five meters.

This keyword applies to ELECTRICITY and fossil-fuel resources only; STEAM and CHILLED-WATER are always on a single meter each.

**MONTH-CHGS** accepts a list in parentheses of up to 12 numeric values that add a fixed monthly charge to each billing cycle. Many utilities refer to this as a customer charge. This value can range from 0.0 to 100,000 \$/month and defaults to 0.0.

If a single value is entered, the value will be used for all 12 billing periods. If fewer than 12 are entered, the last value entered will be used for all remaining billing periods. This is true of all numeric lists in ECONOMICS.

ENERGY-CHG

accepts a numeric value that allows you to specify an energy charge that is constant with time and quantity. The units are \$/UNIT and can range from \$0.0 to \$100,000,000/UNIT. In the absence of any other charges, this keyword will default in accordance with Table 5.1. The UNIT value is the unit as defined or defaulted in the ENERGY-RESOURCE command of PLANT.

RESOURCE	VALUE	\$/UNIT
STEAM	1,000,000 Btu/unit	13.00
CHILLED-WATER	12,000 Btu/ton	0.12
ELECTRICITY	3,412.97 Btu/kWh	0.07
NATURAL-GAS	100,000 Btu/therm	0.50
LPG	95,500 Btu/gal	0.97
FUEL-OIL	138,700 Btu/gal	1.19
DIESEL-OIL	138,700 Btu/gal	1.05
COAL	24,580,000 Btu/ton	30.00
METHANOL	63,500 Btu/gal	1.13
OTHER-FUEL	1,000,000 Btu/unit	0.95
ELEC-NET-SALE	3,412.97 Btu/kWh	0.05
ELEC-BUY/SELL	3,412.97 Btu/kWh	0.05

ENERGY-CHG-SCH

accepts the u-name of a SCHEDULE which specifies an ENERGY-CHG that varies by time of day, week and/or season. The units in the schedule should be \$/UNIT. This schedule is used for all time of use energy billing (demand time of use billing is more complex, and requires the use of multiple BLOCK-CHARGE(s)). If both an ENERGY-CHG and ENERGY-CHG-SCH are defined, the values will add.

DEMAND-CHGS

accepts a list in parentheses of 12 values that allows you to specify a demand charge that is constant with quantity but may vary by billing period. The units are \$/peak-UNIT and can range from \$0.0 to \$100,000,000/peak-UNIT. The default is 0.0. As with other lists, as few as one value may be entered in the list, and the last value will be used for the remaining billing periods.



The billing demand will be based on the largest of:

1. The actual monthly demand; or
2. A RATCHET(s) demand, if defined; or
3. The minimum DEMAND-QUALS. For DEMAND-QUALS to be used, it must be specified and USE-MIN-QUALS must be YES.

#### DEMAND-RATCHETS

accepts a list in parentheses of up to five u-names of RATCHETs. These ratchets will be used to modify the billing demands for all demand charges. When RATCHETs are listed, the billing demand will be the larger of:

1. The actual monthly demand; or
2. A RATCHET(s) demand, if defined; or
3. The minimum DEMAND-QUALS. For DEMAND-QUALS to be used, it must be specified and USE-MIN-QUALS must be YES.

#### BLOCK-CHARGE

accepts a list in parentheses of up to 10 u-names of BLOCK-CHARGEs. These BLOCK-CHARGEs can be used to calculate either energy or demand charges that vary according to quantity. In addition, time of use demand charges are calculated using the BLOCK-CHARGE format.

#### MIN-MON-CHGS

accepts a list in parentheses of 12 values that place a floor on the cost of a fuel or utility for each billing period in which costs are calculated. This value can range from \$0.0 to \$100,000,000.00 per month and defaults to \$0.0. As with other lists, not all 12 values need be entered; the last value entered will be used for all remaining billing periods. Note that the minimum charge excludes any customer charge, taxes, surcharges, or energy cost adjustments.

#### MIN-MON-DEM-CHGS

accepts a list in parentheses of up to 12 values that specify a variable minimum monthly charge calculated on the basis of billing demand. The value entered has units of \$/kW, and the default is 0. The billing demand is the largest of:

1. The actual monthly demand; or
2. A RATCHET(s) demand, if defined; or
3. The minimum DEMAND-QUAL. For DEMAND-QUALS to be used, it must be specified and USE-MIN-QUALS must be YES.

Some utilities do not charge directly for demand, but embed demand charges in kWh/kW rate structures. This keyword allows demand charges to be levied in the event actual demand is exceptionally high relative to total energy use. The total minimum month charges will be the sum of the constant and

variable minimum charges as specified by MIN-MON-CHGs and MIN-MON-DEM-CHGs.

#### RATE-LIMITATION

accepts a numeric value in dollars per unit that places a ceiling on the maximum effective rate that will be assessed on a utility or fuel for any month. This value can range from \$0.0 to \$100,000,000/UNIT and defaults to \$100,000,000/UNIT.

The RATE-LIMITATION excludes MONTH-CHGs and charges arising from ENERGY-COST-ADJUSTMENTS. In addition, the RATE-LIMITATION cannot cause the total bill to drop below the fixed MIN-MON-CHGs plus the MIN-MON-DEM-CHGs.

#### BILLING-DAYS

In the UTILITY-RATE command, BILLING-DAYS accepts a list in parentheses of up to 12 values. If you input less than 12, the last value entered will be the default for all unentered values. The default is 31, or the last day of the month. All costs, etc. reported in output reports will be based on the billing-day. For example, if the billing-day is 17, energy usage for each month listed in the reports will be from the 18th day of the previous month, through the 17th day of the current month. You may elect to explicitly enter the billing day for each month when it is desired to closely match existing utility bills. This may be important if the meter is not regularly read on the same day each month.

The next five keywords are qualifiers used to define whether and how this UTILITY-RATE will be used as monthly energy and demand varies through out the simulation period. Based on total and/or peak consumption, the qualifiers can be used to determine whether a particular UTILITY-RATE is used in place of another. In addition, the qualifiers can set the minimum contract billing quantities for energy and demand.

#### ENERGY-QUALS

designates a list of the (Minimum, Maximum) monthly energy usages that qualify this rate. These qualifiers will be used to select whether this UTILITY-RATE will be used in place of another. Alternately, the minimum can be used to establish a minimum quantity of energy that will be billed (see USE-MIN-QUALS).

If a value of 0.0 is listed for the maximum, then there is no maximum qualifier.

#### DEMAND-QUALS

designates a list of the (Minimum, Maximum) monthly demands that qualify this rate. These qualifiers will be used to select whether this UTILITY-RATE will be used in place of another. Alternately, the minimum can be used to establish a minimum demand that will be billed (see USE-MIN-QUALS).

If a value of 0.0 is listed for the maximum, then there is no

maximum qualifier.

If both ENERGY-QUALS and DEMAND-QUALS are defined, the rate must qualify on the basis of both.

**USE-MIN-QUALS**

*YES*

Accepts the code-words YES or NO. The default is YES.

energy and demand charges will be calculated on the basis of the greater of either the actual monthly energy and demand charges, or the minimum amounts specified under ENERGY-QUALIFIER and DEMAND-QUALIFIER keywords above.

*NO*

there is no minimum charge calculation for either energy or demand.

**QUALIFY-RATE**

accepts the following code-words which define how the ENERGY-QUALS and DEMAND-QUALS are used in determining whether how UTILITY-RATE will be used.

*ALL-MONTHS*

the default, means this UTILITY-RATE will be used all months of the year, regardless of the values of the ENERGY-QUALS and DEMAND-QUALS. If ALL-MONTHS is not specified, it is assumed that you will specify other UTILITY-RATEs having appropriate qualifiers to cover all circumstances. If not, the output reports may show zero costs some months, and report ES-D will include a warning message.

*ONE-MONTH-MIN*

implies that the usage in at least one month must exceed either the energy or demand minimum as specified in ENERGY-QUALS and DEMAND-QUALS. Either the energy or demand minimum limit must be exceeded to qualify for this rate, but both do not. In addition, no month may exceed the maximum energy or demand qualifiers. As described previously, an entry of 0.0 for the maximum value causes the maximum limits to be disregarded.

*ALL-MONTHS-MIN*

implies that the usage in every month must exceed both the energy and demand minimums specified in the ENERGY-QUALS and DEMAND-QUALS. Both minimums must be exceeded to qualify for this rate. In addition, at least one month must be under the maximum energy or demand qualifiers. As described previously, an entry of 0.0 for the maximum value causes the maximum limits to be disregarded.

*MONTH-BY-MONTH*

implies that this rate will be used any month that both the energy and demand minimums are exceeded as specified in ENERGY-QUALS and DEMAND-QUALS, and neither maximum is exceeded. Note that this implies that rates can be switched on a monthly basis; this is not usually the case.

---

In the left column above, bold-faced words are commands, non-bold words are keywords, and italicized words are code-words.

## QUAL-SCH

accepts the u-name of a schedule which defines the period(s) during which this UTILITY-RATE will be used. This keyword will usually be used only when there are METERS that must be associated with different rates on a seasonal basis. QUAL-SCH, if specified, will determine the months during which the above qualification parameters will be tested.

For example, chiller energy may be broken out separately during the summer to take advantage of a favorable thermal energy storage rate offered only during the summer. All other times of the year, chiller energy is grouped with all other energy end uses. See Example 8.

UTILITY-RATEs cannot be switched in the middle of a billing period. Therefore, the program evaluates the value of the schedule only during the first hour of the BILLING-DAYS. All other schedule values are ignored.

## SCH-FLAG

specifies the flag value in the QUAL-SCH which will activate this utility-rate. The default is 1.0.

## ENERGY-COST-ADJS

accepts a list in parentheses of 12 values that specify an energy cost adjustment factor for each billing period. These factors have units of \$/UNIT and default to \$0.0/UNIT. If less than 12 values are entered, the last value entered will be used for all remaining billing periods.

The total monthly energy usage is multiplied by this factor, and the sum is added to all other energy costs. It is assumed that energy cost adjustments will be in addition to any minimum charges defined, and are not subject to the RATE-LIMITATION, if specified.

## DEMAND-WINDOW

accepts a code-word that determines the window in which the peak demand is calculated. Acceptable values are HOUR and DAY, with the default being HOUR. Most electrical utilities calculate demand over a 15 minute or 30 minute interval, which may be either fixed or sliding. However, DOE-2 is an hourly simulation program so the minimum time period over which a demand can be calculated is an HOUR. DAY should be specified if demand is calculated on the basis of maximum daily consumption. This is true for some gas and steam utilities.

The DEMAND-WINDOW will be used for all demand calculations, including demands calculated in associated BLOCK-CHARGEs and RATCHETs.

POWER-FACTOR

is the fraction of peak kVA that is due to real power. The default is 0.8. Reactive demand is calculated as

$$\text{kVAR} = (\text{Real kW}) * (1/\text{PF} - 1)$$

where (Real kW) is the demand calculated by DOE-2. Note that DOE-2 calculates kW only, so that all reactive demands and charges are rough approximations.

EXCESS-KVAR-FRAC

specifies the fraction of real kW above which a charge is levied on kVAR. The default is 0.3.

If the excess reactive fraction is ER:

$$\text{Excess kVAR} = \text{kVAR} - [(\text{Real kW}) * \text{ER}]$$

or

$$\text{Excess kVAR} = (\text{Real kW}) * (1/\text{PF} - 1 - \text{ER})$$

Given the DOE-2 defaults of  $\text{PF} = 0.8$  and  $\text{ER} = 0.3$ , there will be no excess reactive demand.

EXCESS-KVAR-CHG

is the charge in \$/kVAR for excess reactive demand. The default is \$0.00.

ESCALATION

accepts a numeric input in percent that specifies the annual rate of "real" escalation (relative to the general inflation rate) to be used in life-cycle cost calculations. This value can range from 0.0% to 100%. The default is 5% for all energy types.

MIN-MON-RATCHETS

specifies a list in parentheses of up to five u-named RATCHETS. The defaults are the ratchets listed in DEMAND-RATCHETS. When MIN-MON-RATCHET(s) are listed, these ratchets will be used in determining the demand for the MIN-MON-DEM-CHGS.

This next group of keywords defines how taxes and surcharges are levied. In general, both taxes and surcharges may be levied on a percentage basis of dollar charges, or by unit of energy consumed. Taxes and surcharges may be either on a flat rate basis, or in a progressive structure where the charges vary based on the total amount.

**PCT-TAX-DATA**

Specifies a list in parentheses of up to three sets of charges upon which a tax is levied on a percentage basis. Each set consists of a pair of numbers, so that a maximum of six values can be entered. The first number in each set is the maximum size of the block of money upon which this tax will be levied. The second number is the tax in percent. When a utility uses a progressive tax structure, the second and third sets define the successive money blocks and percent taxes for each block. The format is as follows:

(Size-1, Pct-1, Size-2, Pct-2, Size-3, Pct-3)

Not all sets need be entered, but data must be entered in pairs. All remaining charges will be taxed at the rate specified in the last set entered. For example: A municipality charges a tax of 5% on the first \$1000 of charges, 4% on the next \$5000, and 2% on all remaining charges. Acceptable input could be:

	\$SIZE, PCT	
PCT-TAX-DATA=	(1000, 5,	\$ SET #1
	5000, 4,	\$ SET #2
	1, 2)	\$ SET #3
Note that the value of the last block quantity may be set to any value as all remaining charges will be taxed at the rate of the last set entered.		

**PCT-TAXES-APPLY**

accepts a list in parentheses of up to three code-words which specify which charges are taxed. The code-words are:

*BASE*

The default; energy cost adjustments and surcharges are not taxed. Includes all customer, energy and demand charges.

*ECA*

Energy cost adjustments

*SURCHARGES*

Surcharges

**UNIT-TAX-DATA**

Specifies a list in parentheses of up to three sets of energy usage upon which a tax is levied on a per energy UNIT basis. Each set consists of a pair of numbers, so that a maximum of six values can be entered. The first number of each set is the maximum size of the block of energy upon which this tax will

In the left column above, bold-faced words are commands, non-bold words are keywords, and italicized words are code-words.

be levied. The second number is the tax in dollars/unit. The use of this keyword is identical to PCT-TAX-DATA. The total taxes are the sum of values calculated by PCT-TAX-DATA and UNIT-TAX-DATA.

PCT-SRCHG-DATA

Specifies a list in parentheses of up to three sets of charges upon which a surcharge is levied on a percentage basis. Each set consists of a pair of numbers, so that a maximum of 6 values can be entered. The first number of each set is the maximum size of the block of money upon which this tax will be levied. The second number is the surcharge in percent. The use of this keyword is identical to PCT-TAX-DATA.

PCT-SRCHGS-APPLY

accepts a list in parentheses of up to three code-words which specify which charges are assessed. The code-words are:

*BASE*

The default; energy cost adjustments and surcharges are not taxed. Includes all customer, energy and demand charges.

*ECA*

Energy cost adjustments

*TAXES*

Taxes

The program assumes that if percent surcharges are levied on percent taxes, that percent taxes will not also be levied on percent surcharges.

UNIT-SRCHG-DATA

Specifies a list in parentheses of up to three sets of energy usage upon which a surcharge is levied on a per energy UNIT basis. Each set consists of a pair of numbers, so that a maximum of six values can be entered. The first number of each set is the maximum size of the block of energy upon which this surcharge will be levied. The second number is the surcharge in dollars/unit. The use of this keyword is identical to PCT-TAX-DATA. The total surcharges are the sum of values calculated by PCT-SRCHG-DATA and UNIT-SRCHG-DATA.

**Cogeneration**

Energy sold to a utility by on-site generating equipment is treated the same as any other UTILITY-RATE. The value of the energy sold can be computed using any of the keywords, and may also include BLOCK-CHARGE<sub>s</sub> or RATCHET<sub>s</sub>. All numbers should be entered as positive values; the program will change the total sales to a negative number so that it can be properly integrated into the rest of the ECONOMICS calculations.

**RESOURCE**

From the RESOURCE keyword, two code-words cause cogenerated power to be handled differently; they are ELEC-BUY/SELL and ELEC-NET-SALE:

*ELEC-BUY/SELL*

causes all of the power to be sold, so that all of the power consumed on-site must be bought through other UTILITY-RATE<sub>s</sub>.

*ELEC-NET-SALE*

will cause generated power to be consumed on-site, and only the surplus will be sold. When using this option, the METERS keyword will determine which of the electrical meters will use generated power. If no meters are specified, then generated power will be applied toward all meters, starting with meter #1. If one or more meters are specified, then only the specified meters will receive generated power. Generated power will reduce the meter quantities in the order that the meters are listed. Power purchased for those meters through other UTILITY-RATE<sub>s</sub> will be reduced by a corresponding amount.

Since generated power is sold through a UTILITY-RATE, reports ES-D, ES-E, and ES-F are available for summarizing the power sales.

---

In the left column above, bold-faced words are commands, non-bold words are keywords, and italicized words are code-words.



**BLOCK-CHARGE**

BLOCK-CHARGEs are used to calculate energy or demand costs that vary according to the amount consumed. BLOCK-CHARGEs are also used for time of use demand charges. Up to 30 BLOCK-CHARGEs may be defined, and up to 10 may be referenced by each UTILITY-RATE. The same BLOCK-CHARGE may be referenced by more than one UTILITY-RATE; the program automatically makes as many working copies as are required. Also, please read the description of RATCHETs on p.5.26.

**u-name** is a unique user-defined name that must be entered to identify this command.

**BLOCK-SCH** accepts the u-name of a SCHEDULE which defines the period over which energy or demand from the METERS specified in the parent UTILITY-RATE is accumulated. For all energy charges, the schedule is used only for seasonal changes in block charges, such as winter vs. summer rates; time of use rates should be defined directly in the UTILITY-RATE via the ENERGY-CHG-SCH. It is not necessary for seasons to begin and end on the BILLING-DAYS; the program will prorate charges when a seasonal change occurs in the middle of the billing period. You should be careful, however, to ensure that one or more other BLOCK-CHARGEs are defined for the periods in which this BLOCK-CHARGE is inactive.

Previous versions of DOE-2 were limited to two seasons. In DOE-2.1E, this schedule may be used to define as many seasons as may be required. For conventional block demand charges, seasonal changes are handled identically to energy block charges. For demand charges levied on a time of use basis, such as peak, shoulder, and off-peak, this schedule may vary on an hourly and daily basis, as well as seasonal basis.

**SCH-FLAG** specifies the flag value in the BLOCK-SCH that indicates when this BLOCK-CHARGE is active. The default is 1.0

**BLOCK1-TYPE** accepts a code-word used to define the type of block calculation that will follow.

*ENERGY* the default; used when the cost calculations will be done on a per unit basis of energy consumption.

*KWH/KW* is used to specify calculations for energy consumption where each block size is defined as a multiplier on demand. When the number of kWh that can be in a given kWh/kW block is limited to a maximum value, a limit can be specified (see BLOCK-DATA). See Example 5 for the use of this code-word.

---

In the left column above, bold-faced words are commands, non-bold words are keywords, and italicized words are code-words.

*KWH/KW-LIMITSUM*

is used when the sum of the kWh in a series of ENERGY blocks is limited by a kWh/kW value. The maximum value is specified in the BLOCK-DATA. See Example 12 for the use of this code-word.

*DEMAND*

specifies that this set of BLOCK-CHARGE<sub>s</sub> will be used for calculating demand charges.

BLOCK1-DATA

accepts a list enclosed by parentheses of up to 10 sets of data. For ENERGY and DEMAND blocks, each set consists of two entries in the order (block-size, cost/unit). For KWH/KW and KWH/KW-LIMITSUM types, each set consists of three entries in the order (block-size, cost/unit, limit).

The first entry of each set indicates the size of the block to which the cost/unit will be applied. Blocks are increments; hence each successive BLOCK-DATA entry covers the next size block and its cost. Rates written as "up to X" must be translated. The range is from 0.0 to 100,000,000 and there is no default.

The second entry of each set indicates the cost/unit to be applied against the energy or demand falling within this block.

For KWH/KW and KWH/KW-LIMITSUM types, the third entry is the limit. An entry of 0.0 means there is no limit.

1. When the BLOCK-UNIT is KWH/KW, the limit has units of kWh and is the maximum quantity of energy that can be charged in this block.
2. When the BLOCK-UNIT is KWH/KW-LIMITSUM, this entry has units of kWh/kW and, when multiplied by demand, is the maximum sum of all energy that can be charged in this block and all previous blocks. Usually, one limit will apply to a series of blocks. In this case, the same limit should be entered for each of the affected blocks.

Example: A utility charges \$0.05 for the first 5,000 kWh, \$0.04 for the next 10,000 kWh, and \$0.035 for the remainder. Input is as follows:

BLOCK1-TYPE	=ENERGY	
	\$kWh, COST	
BLOCK1-DATA	=( 5000, .05,	\$ SET #1
	10000, .04,	\$ SET #2
	1, .035)	\$ SET #3

Assuming that the BLOCK1-DATA is not followed by an entry for BLOCK2-DATA, all remaining energy will go into the last block; therefore, its size does not matter. Note also that, while this format is easy to read, it is not mandatory.

All data could have been entered on a single line.

BLOCK2-TYPE

When energy calculations are being made, this keyword allows the type of energy calculation to change. For example, a utility may start with a series of ENERGY blocks and then change to kWh/kW blocks. Alternatively, energy blocks may switch to demand.

BLOCK2-DATA

This keyword is used in an identical fashion to BLOCK1-DATA. When BLOCK2-TYPE is the same as BLOCK1-TYPE, this keyword allows an additional 10 sets of data to be entered. If the previous example also contained kWh/kW blocks, input might be as follows:

BLOCK1-TYPE =	ENERGY		
	\$kWh	COST	
BLOCK1-DATA =	( 5000	.05	\$ SET #1
	10000	.04	\$ SET #2
	30000	.035)	\$ SET #3
BLOCK2-TYPE =	KWH/KW		
	\$kWh/kW	COST	MAX kWh
BLOCK2-DATA =	(100	.03	40000
	200	.02	0
	1	.015	0 )
Note that data for kWh/kW is entered in sets of three, with the third entry being the limit. The limit must be specified, even if it is zero (no limit).			

BLOCK3-TYPE

Same

BLOCK3-DATA

Same

DEMAND-RATCHETS

Specifies a list enclosed in parentheses of up to five u-named RATCHETS. The default are the ratchets listed in the parent UTILITY-RATE in DEMAND-RATCHETS. The billing demand used in the BLOCK-CHARGE is the largest of:

1. The actual monthly demand; or
2. A RATCHET(s) demand, if defined; or
3. The minimum DEMAND-QUAL. For DEMAND-QUAL to be used, it must be specified and USE-MIN-QUALS must be YES.

This billing demand is used both for demand calculations well as for KWH/KW and KWH/KW-LIMITSUM calculations. Ratchets listed here have no other effect on either the parent UTILITY-RATE or other BLOCK-CHARGEs.

## TOU-SEASON-LINKS

This keyword is used only with a time of use rate where different BLOCK-CHARGE<sub>s</sub> are used at different times of the day, and is required only when seasonal changes in rates occur on a day which does not coincide with the billing-day. In this case, the two BLOCK-CHARGE<sub>s</sub> overlap in the same billing period and must be linked so that the correct energy and/or demand charges can be determined for both blocks. (Charges for each block must be based on the same use period, such as on-peak, and then prorated based on the number of hours each block was active during the billing period. See the section on Yearly, Seasonal, and Time of Use BLOCK-CHARGE<sub>s</sub> for more information).

Input is a list of u-name(s) in parenthesis of the linked BLOCK-CHARGE(s) which share the same billing period. Both BLOCK-CHARGE<sub>s</sub> must reference each other via this keyword. If only two seasons are used, this BLOCK-CHARGE will overlap with only one other BLOCK-CHARGE, so that only one u-name is entered. If more than two seasons are used, such as winter, spring, summer and fall, this BLOCK-CHARGE will overlap with two other BLOCK-CHARGE<sub>s</sub>. For example, a BLOCK-CHARGE representing spring will overlap with both winter and summer BLOCK-CHARGE<sub>s</sub>. In this case, the u-names of the winter and summer BLOCK-CHARGE<sub>s</sub> are input.

If a UTILITY-RATE has a block structure for both energy and demand charges, the same BLOCK-CHARGE may be used to model both. When modeling both, the energy and demand BLOCK-TYPE keywords may be specified in any order. Alternatively, separate BLOCK-CHARGE<sub>s</sub> can be used for energy and demand. This may be useful when the BLOCK-SCH for the energy and demand charges do not coincide. As previously described, each UTILITY-RATE can reference up to 10 BLOCK-CHARGE<sub>s</sub>.

While KWH/KW, KWH/KW-LIMITSUM and DEMAND are normally used for electrical rates, they may be used for any fuel or utility. In this case, the meaning of KWH/KW would be (UNIT consumption)/(peak UNIT consumption). The same is also true of demand ratchets; they may in principal be applied to any fuel or utility. Note also that the demand period may be changed from 1 hour to 1 day via the DEMAND-WINDOW in the parent UTILITY-RATE.

**Yearly, Seasonal, and Time of Use BLOCK-CHARGEs**

BLOCK-CHARGEs can be used to model yearly, seasonal, or time of use (i.e., time of day) rates:

**Example of a Yearly Rate**

A yearly rate is very straightforward to model. One or more BLOCK-CHARGEs are defined without defining a BLOCK-SCH. The rate will then be used all year. For example, the following input models a yearly rate:

```
ELEC-TARIFF = UTILITY-RATE
              RESOURCE      = ELECTRICITY
              BLOCK-CHARGES = ( INVBLK ) ..
```

```
INVBLK      = BLOCK-CHARGE
              BLOCK1-TYPE   = ENERGY
                               $SIZE  COST
              BLOCK1-DATA   = ( 500   .0535
                               400   .0725
                               1    .1245 ) ..
```

**Example of a Seasonal Rate**

A seasonal rate is also straightforward. As before, one or more BLOCK-CHARGEs are defined, and a BLOCK-SCH is also defined to indicate when each BLOCK-CHARGE is actively used. The following is an example of a seasonal rate:

```
ELEC-TARIFF = UTILITY-RATE
              RESOURCE      = ELECTRICITY
              BILLING-DAYS  = ( 31 )
              BLOCK-CHARGES = ( WINTER-BLK,
                               SUMMER-BLK ) ..
```

```
WINTER-BLK  = BLOCK-CHARGE
              BLOCK-SCH    = SEASONS-SCH
              SCH-FLAG     = 1
              BLOCK1-TYPE  = ENERGY
                               $SIZE  COST
              BLOCK1-DATA  = ( 1000  .07
                               1    .10 ) ..
```

```
SUMMER-BLK  = BLOCK-CHARGE
              BLOCK-SCH    = SEASONS-SCH
              SCH-FLAG     = 2
              BLOCK1-TYPE  = ENERGY
                               $SIZE  COST
              BLOCK1-DATA  = ( 500   .06
                               1    .09 ) ..
```

SEASONS-SCH = SCHEDULE	THRU MAY 15	(ALL)	(1, 24)	(1)
	THRU SEP 15	(ALL)	(1, 24)	(2)
	THRU DEC 31	(ALL)	(1, 24)	(1) ..

Note that in this example, the season changes from winter to summer on May 15, but the billing day is at the end of the month. This means that, during the month of May, the winter block-charge is used in the first half of the month, and the summer block-charge is used for the latter half. In this case, DOE-2 prorates the costs between the two block-charges in the same way that most utilities do:

- a. Costs for each BLOCK-CHARGE are computed using all of the energy consumed during the entire billing period. For example, the cost for the WINTER-BLOCK is computed using the energy billed for the entire month of May, not just the energy metered for the first half of the month.
- b. The costs are then prorated based on the number of hours each BLOCK-CHARGE was active. For example, the cost computed for WINTER-BLOCK is multiplied by 15/31 days.

The above example is for an energy type BLOCK-CHARGE (BLOCK1-TYPE = ENERGY, KWH/KW, or KWH/KW-LIMITSUM). DEMAND type blocks are handled similarly:

- a. The cost for each DEMAND type BLOCK-CHARGE is computed using the maximum demand (including any RATCHETs) found in the entire billing period.
- b. The costs are then prorated based on the number of hours each BLOCK-CHARGE was active.

Both DOE-2 and the utility companies prorate charges based on the number of days rather than on actual energy consumed because the standard utility meter accumulates a single value of energy and a single value of demand for the billing period; information on the distribution of energy and demand usage is not available. Report ES-F shows how the proration is done. For each BLOCK-CHARGE, the "metered energy" is the energy metered during the period defined by the BLOCK-SCH. The "billing energy" is the energy metered during the entire billing period (i.e., the month). The billing energy is the amount used to compute the cost. Usually, the metered energy and the billing energy will be the same except when the season changes in the middle of a billing period. In this case, the "prorate factor" is used to adjust the actual charges. Logically, the prorate factors of two seasonal BLOCK-CHARGEs sharing the same billing period will add up to 1.0

**Example of Time of Use Rates**

Time of use rates are somewhat more complex because energy and/or demand charges vary according to the time of day and day of week. Accordingly, the BLOCK-SCH must be defined to switch from one BLOCK-CHARGE to another on an hourly basis. The following is an example of a time of use rate:

```

TIME-OF-USE = UTILITY-RATE
              RESOURCE           = ELECTRICITY
              BILLING-DAYS       = ( 31 )
              BLOCK-CHARGES     = (WIN-PK,WIN-OFFPK,
                                = SUM-PK,SUM-OFFPK) ..
    
```

```

WIN-PK      = BLOCK-CHARGE
              BLOCK-SCH         = SCH-BLOCK
              SCH-FLAG          = 1.2
              BLOCK1-TYPE       = KWH/KW
                                $SIZE COST LIMIT
              BLOCK1-DATA       = ( 100 .05  0
                                =   0 .04  0 ) ..
    
```

```

WIN-OFFPK   = BLOCK-CHARGE
              BLOCK-SCH         = SCH-BLOCK
              SCH-FLAG          = 1.1
              BLOCK1-TYPE       = KWH/KW
                                $SIZE COST LIMIT
              BLOCK1-DATA       = ( 100 .04  0
                                =   0 .03  0 ) ..
    
```

```

SUM-PK      = BLOCK-CHARGE
              BLOCK-SCH         = SCH-BLOCK
              SCH-FLAG          = 2.2
              BLOCK1-TYPE       = KWH/KW
                                $SIZE COST LIMIT
              BLOCK1-DATA       = ( 100 .09  0
                                =   0 .08  0 ) ..
    
```

```
SUM-OFFPK = BLOCK-CHARGE
          BLOCK-SCH      = SCH-BLOCK
          SCH-FLAG       = 2.1
          BLOCK1-TYPE    = KWH/KW
                      $ SIZE COST LIMIT
          BLOCK1-DATA    = ( 100 .05  0
                          0 .04  0) ..
```

```
SCH-BLOCK = SCHEDULE THRU APR 30 (WD)      (1,6) (1.1)
                                     (7,18) (1.2)
                                     (19,24) (1.1)
                                     (WEH) (1,24) (1.1)
          THRU OCT 30 (WD)      (1,12) (2.1)
                                     (12,18) (2.2)
                                     (19,24) (2.1)
                                     (WEH) (1,24) (2.1)
          THRU DEC 31 (WD)      (1,6) (1.1)
                                     (7,18) (1.2)
                                     (19,24) (1.1)
                                     (WEH) (1,24) (1.1) ..
```

For a customer to utilize a time of use rate, the utility must provide a meter which is capable of recording the distribution of energy (and demand) consumption, not just the total amount used in the billing period. DOE-2 reflects this; in the above example, the costs for each block charge will be computed using only the energy consumed during the period defined by the BLOCK-SCH.

In the above example, energy costs are computed using kWh/kW blocks. The actual size of the block is therefore based on demand. By default, the demand used for each BLOCK-CHARGE is the maximum demand encountered during the block's active period, as defined by its BLOCK-SCH. It is possible to base the block size on other demands through the use of the RATCHET command (see RATCHET). For example, the demand used for calculating the size of the SUMOFFPK energy blocks could be based on the on-peak demand as follows:

```
SUM-OFFPK = BLOCK-CHARGE
          BLOCK-SCH      = SCH-BLOCK
          SCH-FLAG       = 2.1
          DEMAND-RATCHETS = (RAT-SUM-ONPK)
          BLOCK1-TYPE    = KWH/KW
                      $ SIZE COST LIMIT
          BLOCK1-DATA    = ( 100 .05  0
                          0 .04  0) ..
```

```
RAT-SUM-ONPK = RATCHET
              NUM-MONTHS      = 1
              RATCHET-SCH     = SCH-BLOCK
              SCH-FLAG        = 2.2
```



## Supplement – 2.1E Update

By setting NUM-MONTHS = 1, the actual peak during SUM-OFFPK period is disregarded and the ratcheted value (i.e, the on-peak value) is used instead. (Verify this by reviewing report ES-F.)

In the above time of use examples, the BILLING-DAYS and the SCH-BLOCK were defined so that the winter season changed to summer on the billing day. What happens when the season changes in the middle of the billing period? Usually, the utility will compute the charges for each peak (or off-peak) BLOCK-CHARGE using the energy consumed during the entire on-peak time of the billing period (i.e., the energy used in the computation for each on-peak BLOCK-CHARGE is the sum of the energy used in both the winter and summer on-peak blocks). The utility will then prorate the costs between the winter and summer BLOCK-CHARGEs as described previously.

Supplement — 2.1E Update

For this seasonal change to computed properly, how does DOE-2 know which summer and winter blocks share the on-peak (or mid-peak, off-peak, etc.) periods? It does this through the TOU-SEASON-LINK keyword. The following example illustrates how seasonal blocks can be linked together. This is the same example as before, except that the BILLING-DAYS = (15) so that the billing day and the seasonal change no longer coincide. For clarity, the changes have been underlined>:

```

TIME-OF-USE = UTILITY-RATE
              RESOURCE           = ELECTRICITY
              BILLING-DAYS       = (15)
              -----
              BLOCK-CHARGES     = (WIN-PK, WIN-OFFPK,
                                  SUM-PK, SUM-OFFPK) ..

WIN-PK       = BLOCK-CHARGE
              BLOCK-SCH        = SCH-BLOCK
              SCH-FLAG         = 1.2
              TOU-SEASON-LINKS = (SUM-PK)
              -----
              BLOCK1-TYPE      = KWH/KW
                                $SIZE  COST  LIMIT
              BLOCK1-DATA     = ( 100   .05   0
                                0     .04   0) ..

WIN-OFFPK    = BLOCK-CHARGE
              BLOCK-SCH        = SCH-BLOCK
              SCH-FLAG         = 1.1
              TOU-SEASON-LINKS = (SUM-OFFPK)
              -----
              BLOCK1-TYPE      = KWH/KW
                                $SIZE  COST  LIMIT
              BLOCK1-DATA     = ( 100   .04   0
                                0     .03   0) ..

SUM-PK       = BLOCK-CHARGE
              BLOCK-SCH        = SCH-BLOCK
              SCH-FLAG         = 2.2
              TOU-SEASON-LINKS = (WIN-PK)
              -----
              BLOCK1-TYPE      = KWH/KW
                                $ SIZE  COST  LIMIT
              BLOCK1-DATA     = ( 100   .09   0
                                0     .08   0) ..
    
```

Supplement - 2.1E Update

```

SUM-OFFPK   = BLOCK-CHARGE
             BLOCK-SCH       = SCH-BLOCK
             SCH-FLAG        = 2.1
             TOU-SEASON-LINKS = (WIN-OFFPK)
-----
BLOCK1-TYPE = KWH/KW
             $ SIZE COST LIMIT
BLOCK1-DATA = ( 100 .05 0
              0 .04 0) ..

SCH-BLOCK = SCHEDULE THRU APR 30 (WD)      (1,6) (1.1)
                                     (7,18) (1.2)
                                     (19,24) (1.1)
                                     (WEH) (1,24) (1.1)
                                     THRU OCT 30 (WD) (1,12) (2.1)
                                     (12,18) (2.2)
                                     (19,24) (2.1)
                                     (WEH) (1,24) (2.1)
                                     THRU DEC 31 (WD) (1,6) (1.1)
                                     (7,18) (1.2)
                                     (19,24) (1.1)
                                     (WEH) (1,24) (1.1) ..
    
```

To summarize, the TOU-SEASON-LINKS keyword is required only when a time of use rate is being simulated and the BILLING-DAYS does not coincide with the change in season. In this case, report ES-F will report the "metered energy" for each BLOCK-CHARGE as the energy metered during the period defined by the BLOCK-SCH, the "billing energy" as the sum of the energy metered for this block and its linked block, and the "prorate factor" as the number of hours that this block was active relative to its linked block (i.e., prorate factor = Hours1/(Hours1+Hours2) where Hours1 is the number of active hours of this block, and Hours2 is the number of active hours of the linked block). As for a non time of use seasonal change, the prorate factors of two linked blocks should always add up to 1.0

How does DOE-2 know whether a BLOCK-CHARGE is being used in a yearly, seasonal, or time of use format? It does this by looking at the number of times the BLOCK-SCH changes during the course of the year. If the schedule never changes, the block must be yearly. If it changes no more than once in each billing period, it is seasonal. If it changes more than once in any billing period, it is considered to be a time of use block. Report ES-F indicates whether each BLOCK-CHARGE is yearly, seasonal, or time of use. You should always review this report to confirm that the program is modeling your BLOCK-CHARGES as intended.

RATCHET

A new command has been added that allows up to 30 RATCHETs to be defined. Each RATCHET may be referenced by any number of UTILITY-RATEs or BLOCK-CHARGEs; the program automatically makes working copies of the ratchet for each reference. RATCHETs can be specified in both the UTILITY-RATE and the BLOCK-CHARGE commands. There are important differences in the effect a RATCHET has on the billing demands when specified at these two different levels:

1. When specified at the BLOCK-CHARGE level, the ratchet(s) are used in the billing demand calculation for that BLOCK-CHARGE only; the ratchet does not affect any other BLOCK-CHARGE, nor does it affect its parent UTILITY-RATE.
2. When specified at the UTILITY-RATE level, the ratchet(s) are used in the billing demand calculation for the UTILITY-RATE.

In addition, by default, a BLOCK-CHARGE associated with the UTILITY-RATE will also use those ratchet(s), provided that no ratchets are explicitly listed in the BLOCK-CHARGE command. If ratchets are listed in the BLOCK-CHARGE command, then the UTILITY-RATE ratchets will be disregarded. In this fashion, ratchets may act globally (at the UTILITY-RATE level), or locally (at the BLOCK-CHARGE level). These rules are reflected in reports ES-E (for the UTILITY-RATE) and ES-F (for the BLOCK-CHARGEs). Report ES-E displays the billing demand for the UTILITY-RATE. This billing demand will not include any ratchets defined in one or more BLOCK-CHARGEs, only the UTILITY-RATE ratchets. The billing demands for each BLOCK-CHARGE listed in report ES-F will include any local ratchets. If no local ratchets are defined, then any UTILITY-RATE ratchets defined will be used. For example, when a utility uses the same RATCHET for both summer and winter BLOCK-CHARGEs (either kWh/kW or demand blocks), the RATCHETs should be specified in the UTILITY-RATE command so that they can be globally used by all associated BLOCK-CHARGEs. In this case, it is not necessary to specify any RATCHETs directly in the BLOCK-CHARGE commands. If, however, different RATCHETs apply to the summer and winter BLOCK-CHARGEs, then the RATCHETs should be specified at the BLOCK-CHARGE level and not in the UTILITY-RATE.

u-name	Specifies a unique user-defined name for this ratchet.
NUM-MONTHS	<p>Specifies the period over which the ratchet is calculated; default is 12.</p> <p>A value of 1 implies the ratchet is to be calculated on the basis of the current month only; the current month's peak will have no impact on subsequent months. When this type of ratchet is used, the current month's peak is ignored, and the ratchet value is used in its place. In this case, the demand is usually adjusted by an OFFSET and/or FRACTION, defined below, so that the billing demand for the current month is an adjusted demand rather than the peak demand.</p> <p>A value of 2 to 11 specifies the number of months that will be used in calculating a "sliding" ratchet. For example, if the current month's billing demand is the maximum of this month's peak, or the peak in any of the 3 previous months, this value should be set to 4.</p>

A value of 12 implies that the ratchet will be calculated over all months of the year. The maximum demand encountered during the year will be the basis of the ratchet.

**RATCHET-SCH**

accepts a u-name for a SCHEDULE which defines the period over which the ratchet will be calculated. This keyword is useful when one ratchet applies to winter demand, and a different ratchet to summer demand. On-peak/off-peak ratchets can also be defined.

The ratcheted demand will be the maximum demand encountered during the scheduled period. If NUM-MONTHS is less than the period defined in the RATCHET-SCH, then a "sliding" ratchet will occur during the scheduled period. For example, assume RATCHET-SCH is defined to be active from April through October, and NUM-MONTHS is 4. If the current month is June, then the billing demand will be the maximum of the current month's peak, May's, April's, or October's.

**SCH-FLAG**

specifies the flag value in the RATCHET-SCH that indicates when this ratchet is active. The default is 1.0

**TYPE**

accepts a code-word that identifies how the demand is calculated in this ratchet.

*HIGHEST-PEAK*

the default, causes the RATCHET to be calculated on the basis of the highest monthly peak of the ratchet period.

*AVERAGE*

causes the RATCHET to be calculated on the basis of the average of the monthly peaks of the ratchet period. Note that when NUM-MONTHS is one, HIGHEST and AVERAGE give the same result.

**OFFSET**

accepts a numeric value between -1,000,000 and 1,000,000 that is added to the demand. The default is 0.0. OFFSET, if used, is typically negative so that the value of the ratcheted demand is reduced. The adjusted ratcheted demand is limited to be not less than 0.0. When NUM-MONTHS is 1, a negative value for OFFSET effectively creates a threshold below which no demand charges will be calculated.

**FRACTION**

accepts a numeric value between 0.0 and 1.0 that is multiplied against the demand. The demand is adjusted by the OFFSET before FRACTION is applied. The default value is 1.0.

The adjusted demand is:

$$\text{Adj. Demand} = (\text{Peak Demand} - \text{OFFSET}) * \text{FRACTION}$$

This adjusted demand is used in place of the peak demand for each month in the RATCHET period.

---

In the left column above, bold-faced words are commands, non-bold words are keywords, and italicized words are code-words.

### Use of Ratchets

By default, hourly demands are used in a ratchet. Daily demands may be used instead by specifying DEMAND-WINDOW = DAY in the parent UTILITY-RATE.

The RATCHET-SCH and SCH-FLAG determine when the ratchet is actively calculating the maximum demand. If no schedule is defined, the ratchet is always active, and computes demands for each billing period ending with the BILLING-DAYS as defined in the parent UTILITY-RATE.

The combination of the RATCHET-SCH and NUM-MONTHS determines how a ratchet is used throughout the year. If NUM-MONTHS = 12, then the peak value is found for the hours defined in the schedule, and this peak is used in all 12 billing periods. When NUM-MONTHS < 12, the peak value is found in the same way as before. However, this peak is used only in the months in which the schedule is active, the ratchet value for all other months is zero. In addition, if NUM-MONTHS is less than the length of the scheduled active period, then the ratchet will also slide. These concepts are best illustrated by example:

		Use of Ratchets												
		Period Demand	Jan	Feb	Mar	Apr	May	Jun	Jul	Aug	Sep	Oct	Nov	Dec
			10	20	30	40	50	60	70	60	50	40	30	20
Schedule	Months	Ratchet Value for Each Billing Period												
None	1	10	20	30	40	50	60	70	60	50	40	30	20	
None	4	40	30	30	40	50	60	70	70	70	70	60	50	
None	12	70	70	70	70	70	70	70	70	70	70	70	70	70
Apr-Sep	1	0	0	0	40	50	60	70	60	50	0	0	0	
Apr-Sep	4	0	0	0	70	60	60	70	70	70	0	0	0	
Apr-Sep	8	0	0	0	70	70	70	70	70	70	0	0	0	
Apr-Sep	12	70	70	70	70	70	70	70	70	70	70	70	70	70
Jan-Mar	12	30	30	30	30	30	30	30	30	30	30	30	30	30
Jan-Mar	4	30	30	30	0	0	0	0	0	0	0	0	0	0

As this table shows, NUM-MONTHS should be left at 12 if a ratchet is to be used all year. NUM-MONTHS < 12 implies a sliding window used only when the schedule is active. Note also that if NUM-MONTHS is longer than the scheduled period (Apr-Sep 8 months), then the sliding window effectively "disappears" and the peak value found is used for all months defined by the schedule.

Note also that these values are for this ratchet only; other ratchets may be used to capture other values. When multiple ratchets are referenced by a UTILITY-RATE or BLOCK-CHARGE, the billing demand for each billing period is the largest ratchet value corresponding to that period.

When a set of BLOCK-CHARGE is using kWh/kW type blocks and one or more RATCHETS is listed under the DEMAND-RATCHETS keyword, these ratchets will be used in determining the basis of the kWh/kW blocks.

**Examples**

To illustrate the use of the ECONOMICS commands and keywords, a series of examples are presented. The examples are for various electricity and gas tariffs commonly found in the United States. These examples can be extended to other fuels and utilities. Some of these examples are identical to the examples in previous versions of the program, but have been revised to illustrate the new commands and keywords. Most utility rates have a form similar to Examples 1, 2, 3, or 4. More complicated rates involving kWh/kW blocks are illustrated by Example 5. Example 6 demonstrates the implementation of a time of use rate. The first six examples were adapted from the examples given for the previous version of the ECONOMICS program. Examples 7 through 12 were adapted from actual rates (interpreted from descriptions found in "Electric and Gas Rates for the Residential, Commercial, and Industrial Sectors, 1991", prepared by Casazza, Schultz, and Associates for the Gas Research Institute) that were difficult or impossible to implement in the previous versions of ECONOMICS.

**Example 1: Basic Tariff**

The most basic tariff is a uniform charge levied on all units consumed in a month. For this example, all kilowatt-hours cost \$0.05 and there is a monthly customer charge of \$15.00. The minimum bill is \$17.00 and there are no demand charges.

```
ELEC-TARIFF = UTILITY-RATE
              RESOURCE      = ELECTRICITY $required
              MONTH-CHGS    = ( 15. )
              ENERGY-COST  = .05
              MIN-MON-CHGS  = ( 17. ) ..
```

Since no METERS were specified, meters 1-5 will be used. MONTH-CHGS and MIN-MON-CHGS take lists specifying the charges for 12 months. Since only a single value was entered, this value will be used for all 12 months.

**Example 2: Simple Block Tariff for Energy**

Although block rates have been used for years, many of them now incorporate marginal-cost and equity-related concerns. A recent example of the latter, currently in wide usage among residential customers, are inverted block rates. The basic idea is that increased consumption is discouraged by increased per unit costs. A simple inverted block has three tiers. In this example, the first 500 kWh of consumption (sometimes referred to a "baseline" or "life line" quantity) are charged at \$.0535 per kWh. All kWh consumed in excess of 500 kWh, but less than 900 kWh, are charged at \$.0725 per kWh. The third tier covers all consumption in excess of 900 kWh at a charge of \$.1245 per kWh. There is no seasonal variation in this rate and we will ignore minimum and fixed monthly charges in this example.

```
ELEC-TARIFF = UTILITY-RATE  RESOURCE      = ELECTRICITY $required
                                BLOCK-CHARGES = ( INVBLK ) ..

INVBLK      = BLOCK-CHARGE  BLOCK1-TYPE  = ENERGY
                                                $SIZE  COST
                                BLOCK1-DATA  = ( 500  .0535
                                                400  .0725
                                                1   .1245 ) ..
```

Note that the size of the last block can be any number. Since BLOCK1-DATA is not followed by BLOCK2-DATA, all remaining energy will be assessed at the rate in the last set.

**Example 3: Seasonal Block Tariffs**

Most utilities are faced with demands for electricity that are not evenly distributed throughout the year. They reflect the fact that changing levels of demand result in differing costs of service by introducing seasonal variations in the rates for electricity. These variations may have different size blocks associated with them, as well. In this next example, there is a winter season that lasts from October to May and a summer season that lasts from June to September. This utility is winter-peaking, but recognizes the need for increased life line allowances at this time of year.

```
ELEC-TARIFF = UTILITY-RATE
              RESOURCE      = ELECTRICITY  $REQUIRED
              BLOCK-CHARGES = (WINTER-BLK, SUMMER-BLK) ..
```

```
WINTER-BLK = BLOCK-CHARGE
            BLOCK-SCH      = SEASONS-SCH
            SCH-FLAG       = 1
            BLOCK1-TYPE    = ENERGY  $REQUIRED
                          $ SIZE  COST
            BLOCK1-DATA    = ( 1000 .07
                          1 .10 ) ..
```

```
SUMMER-BLK = BLOCK-CHARGE
            BLOCK-SCH      = SEASONS-SCH
            SCH-FLAG       = 2
            BLOCK1-TYPE    = ENERGY
                          $ SIZE  COST
            BLOCK1-DATA    = ( 500 .06
                          1 .09) ..
```

```
SEASONS-SCH = SCHEDULE  THRU MAY 31  (ALL)  (1,24) (1)
                       THRU SEP 30  (ALL)  (1,24) (2)
                       THRU DEC 31  (ALL)  (1,24) (1) ..
```

Note how the use of the SCH-FLAG keyword allowed both BLOCK-CHARGEs to reference the same schedule.



**Example 4: Demand Charges and Ratchets**

The most significant difference between residential and commercial electricity tariffs is the inclusion of demand charges. Typically, the highest measured demand (integrated over some fraction of an hour) is compared against a “ratchet” chosen or calculated from some set of previous highest demands, and the larger of the two is taken to be the billing demand. These tariffs can also include rate limitation features to ensure that when the charges are all totaled, the effective rate per kWh is less than or equal to a specified amount. We first present an example in which the ratchet is taken to be 90% of the highest demand recorded in the previous 12 months, and the charge is \$12/kW. There is a flat charge on energy of \$0.05/kWh, but in no circumstance can the effective rate (i.e., including the demand charges) exceed \$.07/kWh.

```

ELEC-TARIFF  =  UTILITY-RATE
                RESOURCE      =  ELECTRICITY
                ENERGY-CHGS   =  ( 0 . 0 5 )
                DEMAND-CHGS    =  ( 1 2 . 0 0 )
                DEMAND-RATCHETS =  ( RATCHET-90 )
                RATE-LIMITATION =  0 . 0 7  ..
    
```

```

RATCHET-90   =  RATCHET
                NUM-MONTHS     =  1 2  $DEFAULT
                FRACTION       =  . 9  ..
    
```

**Example 5: Rate Qualifiers and KWH/KW Blocks**

Some block rate structures partition energy use by blocks, whose size is determined by demands (kW). There may also be instances where it is not clear which such schedule of charges to apply because this decision is determined by, say, the unknown kW demand. In this example, the DEMAND-QUALS are used to decide which UTILITY-RATE schedule to use. For this utility, a demand greater than 50 kW means using one schedule of charges, while a demand of less than or equal to 50 kW requires using another. The schedules are identical in the manner in which the blocks are sized, but the charges differ:

Charges	<50kW	>50kW
First 1000 kWh	.050	.060
Next 4000 kWh	.045	.055
Next 200 kWh/kW	.040	.050
All remaining kWh	.035	.045

The larger schedule must be used if the demand exceeds 50 kW any time during the year; the utility will not allow rates to be switched on a monthly basis.

The smaller schedule has a customer charge of \$15; the larger schedule has a \$20 customer charge and includes a minimum demand of 50kW. Neither schedule includes any ratcheted demands.

```
BELOW-50KW = UTILITY-RATE
             RESOURCE = ELECTRICITY
             DEMAND-QUALS = (0, 50)
             USE-MIN-QUALS = NO
             QUALIFY-RATE = ALL-MONTHS
             MONTH-CHGS = (15)
             BLOCK-CHARGES = (SMALL-BLOCK) ..
```

```
SMALL-BLOCK = BLOCK-CHARGE
             BLOCK1-TYPE = ENERGY
                   $ SIZE COST
             BLOCK1-DATA = (1000 .05
                   4000 .045)
             BLOCK2-TYPE = KWH/KW
                   $ SIZE COST LIMIT
             BLOCK2-DATA = ( 200 .040 0
                   1 .035 0) ..
```

```
ABOVE-50KW = UTILITY-RATE
             RESOURCE = ELECTRICITY
             DEMAND-QUALS = (50, 0)
             USE-MIN-QUALS = YES
             QUALIFY-RATE = ALL-MONTHS
             MONTH-CHGS = (20)
             BLOCK-CHARGES = (LARGE-BLOCK) ..
```

Supplement - 2.1E Update

```

LARGE-BLOCK = BLOCK-CHARGE  BLOCK1-TYPE = ENERGY
                                $ SIZE COST
                                BLOCK1-DATA = ( 1000 .06
                                                4000 .055 )
                                BLOCK2-TYPE = KWH/KW
                                $ SIZE COST LIMIT
                                BLOCK2-DATA = ( 200 .05 0
                                                1 .045 0 ) ..
    
```

In this example, the size of the kWh/kW blocks will be determined monthly on the basis of the peak demand that month. Note that kWh/kW blocks are input in sets of 3, with the third entry being the limit on maximum kWh that can be placed in the block. An entry of 0 for the limit implies that there is no limit. If no more than 20,000 kWh can be placed in the first KWH/KW block, input is modified as follows:

```

LARGE-BLOCK = BLOCK-CHARGE  BLOCK1-TYPE = ENERGY
                                $ SIZE COST
                                BLOCK1-DATA = ( 1000 .06
                                                4000 .055 )
                                BLOCK2-TYPE = KWH/KW
                                $ SIZE COST LIMIT
                                BLOCK2-DATA = ( 200 .05 20000
                                                1 .045 0 ) ..
    
```

If, in addition, the larger rate schedule were to include ratchets equal to 80% of the peak summer demand, or 50% of the peak winter demand, the input is modified as follows:

```

ABOVE-50KW = UTILITY-RATE  RESOURCE = ELECTRICITY
                                DEMAND-QUALS = ( 50, 0 )
                                USE-MIN-QUALS = YES
                                QUALIFY-RATE = ALL-MONTHS
                                MONTH-CHGS = ( 20 )
                                BLOCK-CHARGES = ( LARGE-BLOCK ) ..
    
```

```

LARGE-BLOCK = BLOCK-CHARGE  DEMAND-RATCHETS = (WIN-RATCHET,
                                                SUM-RATCHET)
                                BLOCK1-TYPE = ENERGY
                                $ SIZE COST
                                BLOCK1-DATA = ( 1000 .06
                                                4000 .055 )
                                BLOCK2-TYPE = KWH/KW
                                $ SIZE COST LIMIT
                                BLOCK2-DATA = ( 200 .05 20000
                                                1 .045 0 ) ..
    
```

```

WIN-RATCHET = RATCHET      NUM-MONTHS      = 12
                           RATCHET-SCH      = SEASONS
                           SCH-FLAG        = 1
                           FRACTION        = 0.50 ..
    
```

```

SUM-RATCHET = RATCHET      NUM-MONTHS      = 12
                           RATCHET-SCH      = SEASONS
                           SCH-FLAG        = 2
                           FRACTION        = 0.80 ..
    
```

```

SEASONS = SCHEDULE THRU APR 30 (ALL) (1,24) (1)
                THRU OCT 30 (ALL) (1,24) (2)
                THRU DEC 31 (ALL) (1,24) (1) ..
    
```

Setting NUM-MONTHS = 12 causes the ratchet to be used all twelve months, even though it is calculated over a shorter period. Please refer to the RATCHET command for a detailed discussion of the effect that RATCHET-SCH and NUM-MONTHS have on the ratchet values for each billing period.

The ratchets could have been entered in the UTILITY-RATE via the DEMAND-RATCHETS keyword. If so, they would have applied to all BLOCK-CHARGE<sub>s</sub> referenced by the UTILITY-RATE (only 1 was referenced in this example).

**Example 6: Time of Use Energy Charges, Seasonal Demand Charges**

The most recent innovation in rate design has been the introduction of time of use rates wherein the time of day, week, and year that energy is consumed get broken into different costing periods and have different charges assigned to them. The charges, moreover, can be for demand and energy, and for each of these the definition of the periods can change. In this example, there is a winter and summer season. Energy charges vary by season and also by on-peak and off-peak. Demand charges vary by season only, and are charged at \$5.00/kW during the winter (Oct-Mar) and \$8.00/kW during the summer.

TIME-OF-USE = UTILITY-RATE  
 RESOURCE = ELECTRICITY  
 ENERGY-CHG-SCH = ENERGY-SCH  
 DEMAND-CHGS = ( 5, 5, 5, 8, 8, 8, 8, 8, 8, 8,  
 5, 5, 5) ..

ENERGY-SCH = SCHEDULE THRU MAR 31 (WD) (1, 8) (.04)  
 (9, 22) (.06)  
 (23, 24) (.04)  
 (WEH) (1, 24) (.04)  
 THRU SEP 31 (WD) (1, 8) (.05)  
 (9, 20) (.07)  
 (21, 24) (.05)  
 (WEH) (1, 24) (.05)  
 THRU DEC 31 (WD) (1, 8) (.04)  
 (9, 22) (.06)  
 (23, 24) (.04)  
 (WEH) (1, 24) (.04) ..

Shoulder periods are those times during the day when the utility experiences moderate use. Shoulder periods are easily incorporated by including additional times in the ENERGY-SCH. In previous versions of DOE-2, time of use rates required a large number of CHARGE-ASSIGNMENTS, one for each different energy cost. With the new structure in DOE-2.1E, this requirement is eliminated (for energy only, not for demand; see next example). Note also that the ENERGY-SCH could be expanded to simulate the "real-time pricing" that some utilities are investigating.

**Example 7: Time of Use Energy and Demand Charges**

This example builds upon Example 6 to show how time of use demand charges are assessed. These are the most difficult charges to input, as they require a BLOCK-CHARGE for each TOU demand period. Assume demand charges are assessed as:

Demand Charges		
	Summer	Winter
On-peak	8	5
Off-peak	3	2

In addition, assume that the demand charge in the off-peak period is only for the demand in excess of that which occurs on-peak (this is very common). If so, another way of stating the charges is:

Revised Demand Charges		
	Summer	Winter
On-peak	5	3
24-hr Peak	3	2

Here, the off-peak demand is replaced with a 24-hour peak demand (which, if the daily peak occurs on-peak, is the same as the on-peak demand), and the on-peak charges are reduced.

The following demonstrates that these two methods give identical results.

Time	\$/kW	Demand,kW	Cost	Total Cost
<b>Example 1:</b>				
<b>Daytime Peak</b>				
Peak	\$8	\$100	\$800	
Off-Peak	\$3*	\$ 50	\$ 0	\$800
<b>Revised Equivalent</b>				
Peak	\$5	\$100	\$500	
24-Hour	\$3	\$100	\$300	\$800
<b>Example 2:</b>				
<b>Nighttime Peak</b>				
Peak	\$8	\$100	\$800	
Off-Peak	\$3*	\$150	\$150	\$950
<b>Revised Equivalent</b>				
Peak	\$5	\$100	\$500	
24-Hour	\$3	\$150	\$450	\$950
* in excess of peak				

Supplement — 2.1E Update

In addition, let us assume that on-peak charges are ratcheted by 80% of the maximum on-peak summer demand (Apr 15 through Oct 15), or 50% of the maximum on-peak winter demand. Off peak charges are not ratcheted. The billing day is the 21st of each month. Energy is charged in the same time of use fashion as Example 6. The input is as follows:

TIME-OF-USE = UTILITY-RATE  
 RESOURCE = ELECTRICITY  
 BILLING-DAYS = (21)  
 ENERGY-CHG-SCH = ENERGY-SCH  
 BLOCK-CHARGES = (WIN-DEM-PK, WIN-DEM-24,  
 SUM-DEM-PK, SUM-DEM-24) ..

ENERGY-SCH = SCHEDULE THRU APR 15 (WD) (1,8) (.04)  
 (9,22) (.06)  
 (23,24) (.04)  
 (WEH) (1,24) (.04)  
 THRU OCT 15 (WD) (1,8) (.05)  
 (9,20) (.07)  
 (21,24) (.05)  
 (WEH) (1,24) (.05)  
 THRU DEC 31 (WD) (1,8) (.04)  
 (9,22) (.06)  
 (23,24) (.04)  
 (WEH) (1,24) (.04) ..

WIN-DEM-PK = BLOCK-CHARGE BLOCK-SCH = SCH-PEAK  
 SCH-FLAG = 1  
 DEMAND-RATCHETS = (WIN-50, SUM-80)  
 TOU-SEASON-LINKS = (SUM-DEM-PK)  
 BLOCK1-TYPE = DEMAND  
 \$ SIZE COST  
 BLOCK1-DATA = ( 1 3.00) ..

WIN-DEM-24 = BLOCK-CHARGE BLOCK-SCH = SCH-24  
 SCH-FLAG = 1  
 TOU-SEASON-LINKS = (SUM-DEM-24)  
 BLOCK1-TYPE = DEMAND  
 \$ SIZE COST  
 BLOCK1-DATA = ( 1 2.00) ..

SUM-DEM-PK = BLOCK-CHARGE BLOCK-SCH = SCH-PEAK  
 SCH-FLAG = 2  
 DEMAND-RATCHETS = (WIN-50, SUM-80)  
 TOU-SEASON-LINKS = (WIN-DEM-PK)  
 OCK1-TYPE = DEMAND  
 \$ SIZE COST  
 BLOCK1-DATA = ( 1 5.00) ..

SUM-DEM-24 = BLOCK-CHARGE BLOCK-SCH = SCH-24  
 SCH-FLAG = 2  
 TOU-SEASON-LINKS = (WIN-DEM-24)

Supplement - 2.1E Update

```

                                BLOCK1-TYPE      = DEMAND
                                                $ SIZE COST
                                BLOCK1-DATA      = ( 1 3.00) ..

WIN-50 = RATCHET  NUM-MONTHS = 12
                RATCHET-SCH = SCH-PEAK
                SCH-FLAG    = 1
                FRACTION    = .50 ..

SUM-80 = RATCHET  NUM-MONTHS = 12
                RATCHET-SCH = SCH-PEAK
                SCH-FLAG    = 2
                FRACTION    = .80 ..

SCH-24 = SCHEDULE THRU APR 15 (ALL) (1,24) (2)
                THRU OCT 15 (ALL) (1,24) (1)
                THRU DEC 31 (ALL) (1,24) (2) ..

SCH-PEAK = SCHEDULE THRU APR 15 (WD) (1,12) (0)
                (12,18) (1)
                (19,24) (0)
                (WEH) (1,24) (0)

                THRU OCT 15 (WD) (1,12) (0)
                (12,18) (2)
                (19,24) (0)
                (WEH) (1,24) (0)

                THRU DEC 31 (WD) (1,12) (0)
                (12,18) (1)
                (19,24) (0)
                (WEH) (1,24) (0) ..

```

In this example, the ratchets must be entered at the BLOCK-CHARGE level; if they were entered at the UTILITY-RATE level they would affect the 24-hour demands as well as the peak demands. Note also how the SCH-PEAK is used to control the active periods of both the on-peak BLOCK-CHARGES and RATCHETs. In this schedule, the flag value of 1 activates the winter block and ratchet, 2 activates the summer, and 0 does not activate anything.

The TOU-SEASON-LINKS are required because the seasons change on the 15th of April and October while the billing day is the 21st.



**Example 8: Preferential Rate for a Season**

This example illustrates how a preferential rate can be given for TES systems, winter electric heating, etc. A chiller will be modeled in PLANT, and assigned to a separate meter. A preferential rate will be given to the chiller June through August. All other months, chiller energy will be charged in the same rate as the rest of the building.

INPUT PLANT ..

ICE-MAKER = P-E SIZE = 2.5  
 INSTALLED-NUMBER = 1  
 ELEC-METER = M2 ..  
 \$ALL OTHER EQUIPMENT ON METER #1

ETC, ETC.

COMPUTE PLANT ..

INPUT ECONOMICS ..

NORMAL-RATE = UTILITY-RATE  
 RESOURCE = ELECTRICITY  
 METERS = (M1, M2)  
 QUAL-SCH = SEASONS  
 SCH-FLAG = 1  
 ETC. ..

SUMMER-BLDG = UTILITY-RATE  
 RESOURCE = ELECTRICITY  
 METERS = (M1)  
 QUAL-SCH = SEASONS  
 SCH-FLAG = 2  
 ETC. ..

SUMMER-CHLR = UTILITY-RATE  
 RESOURCE = ELECTRICITY  
 METERS = (M2)  
 QUAL-SCH = SEASONS  
 SCH-FLAG = 2  
 ETC. ..

SEASONS = SCHEDULE THRU MAY 31 (ALL) (1, 24) (1)  
 THRU AUG 31 (ALL) (1, 24) (2)  
 THRU DEC 31 (ALL) (1, 24) (1) ..

The following are examples of actual utility rates used in the United States.

**Example 9: KWH/KW Blocks with Time of Use Demand**

This first example shows varying demand charges, on-peak vs. off-peak. To model this, a BLOCK-CHARGE must be used for each of the TOU demand periods. Assume the summer on-peak demand charge is \$7.20/kW, and there is an additional \$3.08/kW on the off-peak demand in excess of the peak demand. The on-peak period is 7 a.m. to 11 p.m. Mon-Fri. Assume also that a ratchet applies to the excess peak demand based on the maximum on-peak or off-peak demand incurred during the past 5 months.

Mathematically, this rate is identical to a \$3.08/kW charge applied to the 24-hour peak, and a  $(\$7.20 - \$3.08) = \$4.12/\text{kW}$  charge applied to the on-peak period.

In addition to the charges above, there is a \$287.53 customer charge, an average energy cost adjustment of \$0.00544 in the winter and \$0.00387 in the summer, an 8% tax with the first \$150 exempt, a surcharge (credit) of \$-0.00099 in the winter and \$-0.00157 in the summer, two KWH/KW energy blocks, and a minimum demand charge based on 50kW.

DOE-2.1E cannot model surcharges that vary by season. Therefore an average surcharge of \$.00128 will be used. (Alternatively, the energy-cost adjustments could be modified to incorporate the surcharge credit, or the surcharge could be entered into the ENERGY-CHGS keyword).

```
ECON-EX-9 = UTILITY-RATE
            RESOURCE = ELECTRICITY
            DEMAND-QUALS = (50, 0)
            USE-MIN-QUALS = YES $FOR 50kW MIN
            QUALIFY-RATE = ALL-MONTHS $DEFAULT
            MONTH-CHGS = (287.53)
            BLOCK-CHARGES = (ENERGY-BLOCK, DEMAND-24-HR,
                             DEMAND-ON-PK)
            ENERGY-COST-ADJS = (.00544, .00544, .00544, .00544,
                                  .00387, .00387, .00387, .00387,
                                  .00387, .00387, .00544, .00544)
            PCT-TAX-DATA = (150, 0.0,
                           1, 8.0)
            PCT-TAXES-APPLY = (BASE, ECA, SRCHGS)
            UNIT-SRCHG-DATA = (1, -0.00128) ..
```

```
ENERGY-BLOCK = BLOCK-CHARGE
              BLOCK1-TYPE = KWH/KW
              BLOCK1-DATA = (400, 0.05597, 0
                             1, 0.04585, 0) ..
```

```
DEMAND-24-HR = BLOCK-CHARGE
              BLOCK1-TYPE = DEMAND
              BLOCK1-DATA = (1, 3.08)
              DEMAND-RATCHETS = (FIVE-MONTH) ..
```

Supplement - 2.1E Update

DEMAND-ON-PK = BLOCK-CHARGE  
BLOCK-SCH = ON-PEAK-SCH  
SCH-FLAG = 1 \$DEFAULT  
BLOCK1-TYPE = DEMAND  
BLOCK1-DATA = (1, 4.12) ..

ON-PEAK-SCH = SCHEDULE THRU DEC 31 (ALL) (1,7) (0)  
(8,23) (1)  
(24) (0) ..

FIVE-MONTH = RATCHET  
NUM-MONTHS 5 ..

**Example 10: kWh/kW Blocks with 70% Winter Ratchet**

This example has a minimum charge equal to the demand charge, however the demand charge is calculated explicitly, so in effect there is no separate minimum charge to specify. Energy charges are calculated in four blocks, with no difference in cost between summer and winter:

Energy Charges				
Block	Type	Size	Limit	Charge
1	kWh/kW	120	6,000 kWh	0.06490
2	kWh/kW	180	N/A	0.05438
3	kWh/kW	180	N/A	0.04543
4	kWh/kW	>>	N/A	0.03626

Energy is charged in kWh/kW blocks which are affected by demand. In the summer, the demand is the maximum peak monthly demand. In the winter, it is only 70% of the peak.

Demand charges are calculated in five blocks, with no difference between summer and winter block sizes or charges. In the summer, demand is the maximum demand of any 30-minute interval in the billing period (although DOE-2 must assume that this is represented by the hourly demand). In the winter, only 70% of the highest demand in each billing period is charged. Minimum billing demand is 10kW:

Demand Charges		
Block	Size	Charge
1	10	7.375
2	50	7.162
3	60	5.170
4	280	4.711
5	>>	3.928

Gross Receipts Tax is calculated as follows:

Base bill less than or equal to \$3,780; divide base bill by .9 and subtract base bill for GRT revenue.

Base bill greater than \$3,780; divide base bill by .94, add \$178.72 and subtract base bill for GRT revenue.

This is a complicated way of saying that the tax on bills \$3,780 and below is 11.1111%, and the tax for all amounts above \$3,780 is 6.383%:

Gross Receipts Tax		
Block	Size	Tax
1	\$ 3,780	11.1111%
2	>3,780	6.383 %

Supplement - 2.1E Update

DOE-2.1E input is as follows:

ECON-EX-10 = UTILITY-RATE  
 RESOURCE = ELECTRICITY  
 DEMAND-QUALS = (10,1000000)  
 USE-MIN-QUALS = YES  
 QUALIFY-RATE = ALL-MONTHS \$DEFAULT  
 BLOCK-CHARGES = (ENERGY-WIN, ENERGY-SUM,  
 DEMAND-WIN, DEMAND-SUM)  
 \$ SIZE PCT  
 PCT-TAX-DATA = (3780 11.1111  
 1 6.383) ..

ENERGY-SUM = BLOCK-CHARGE  
 BLOCK-SCH = SEASONS  
 SCH-FLAG = 2  
 BLOCK1-TYPE = KWH/KW  
 \$ SIZE COST LIMIT  
 BLOCK1-DATA = (120 0.06490 6000  
 180 0.05438 0  
 180 0.04543 0  
 1 0.03626 0) ..

ENERGY-WIN = BLOCK-CHARGE LIKE ENERGY-SUM  
 SCH-FLAG = 1  
 DEMAND-RATCHETS = (WIN-70) ..

DEMAND-SUM = BLOCK-CHARGE  
 BLOCK-SCH = SEASONS  
 SCH-FLAG = 2  
 BLOCK1-TYPE = DEMAND  
 BLOCK1-DATA = ( 10, 7.375,  
 50, 7.162,  
 60, 5.170,  
 280, 4.711,  
 1, 3.928 )  
 \$NO RATCHET SPECIFIED. DEMAND WILL BE MONTHLY PEAK\$ ..

DEMAND-WIN = BLOCK-CHARGE LIKE DEMAND-SUM  
 SCH-FLAG = 1  
 DEMAND-RATCHETS = (WIN-70) ..

WIN-70 = RATCHET  
 NUM-MONTHS = 1 \$ CURRENT ONLY  
 FRACTION = 0.7  
 \$RATCHET IS FOR CURRENT-MONTH ONLY,  
 \$NO NEED TO INPUT A SCHEDULE ..

SEASONS = SCHEDULE THRU APR 30 (ALL) (1,24) (1)  
 THRU OCT. 30 (ALL) (1,24) (2)  
 THRU DEC 31 (ALL) (1,24) (1) ..

**Example 11: kWh Blocks with Reactive Demand Charge**

This example has a minimum charge equal to the sum of \$25 plus the Energy Cost Adjustment; effectively the minimum charge is \$25. Energy charges are calculated in three blocks, with costs that vary from winter to summer:

Block	Type	Size	Limit	Winter	Summer
1	kWh	40,000	N/A	0.0505	0.0560
2	kWh	60,000	N/A	0.0359	0.0403
3	kWh	>>	N/A	0.0333	0.0358

There is also an average energy cost adjustment factor of \$0.014108 in the winter, and \$0.015576 in the summer. If usage is very low, the rate will be limited to \$0.20 per kWh, excluding energy cost adjustments.

Demand charges are calculated in two blocks, with costs that vary from winter to summer. Minimum billing demand is 30kW:

Block	Size	Winter	Summer
1	50	10.61	11.76
2	>>	9.67	10.73

There is a reactive demand charge of \$0.20 per kVAR of reactive billing demand.

```

COMMERCIAL = UTILITY-RATE
              RESOURCE = ELECTRICITY
              DEMAND-QUALS = (30, 0)
              USE-MIN-QUALS = YES
              QUALIFY-RATE = ALL-MONTHS
              MIN-MON-CHGS = (25.00) $plus ECA
              ENERGY-COST-ADJS = (.014108, .014108, .014108,
                                     .014108, .015576, .015576,
                                     .015576, .015576, .015576,
                                     .015576, .014108, .014108)
    
```

```

              BLOCK-CHARGES = (ENERGY-WIN, ENERGY-SUM,
                                DEMAND-WIN, DEMAND-SUM)
    
```

```

              UNIT-SRCHG-DATA = (1, 0.000305)
              POWER-FACTOR = 0.8
              EXCESS-KVAR-FRAC = 0.0
              EXCESS-KVAR-CHG = 0.2
              RATE-LIMITATION = 0.2 ..
    
```

```

ENERGY-WIN = BLOCK-CHARGE
              BLOCK-SCH = SEASONS
              SCH-FLAG = 1
              BLOCK1-TYPE = ENERGY
              BLOCK1-DATA = ( 40000, 0.0505,
                              600000, 0.0359,
                              1, 0.0333) ..
    
```

Supplement - 2.1E Update

ENERGY-SUM = BLOCK-CHARGE  
 BLOCK-SCH = SEASONS  
 SCH-FLAG = 2  
 BLOCK1-TYPE = ENERGY  
 BLOCK1-DATA = ( 40000, 0.0560,  
 600000, 0.0403,  
 1, 0.0358) ..

DEMAND-WIN = BLOCK-CHARGE  
 BLOCK-SCH = SEASONS  
 SCH-FLAG = 1  
 BLOCK1-TYPE = DEMAND  
 BLOCK1-DATA = (50, 10.61, 1, 9.67) ..  
 \$NO DEMAND RATCHET

DEMAND-SUM = BLOCK-CHARGE  
 BLOCK-SCH = SEASONS  
 SCH-FLAG = 2  
 BLOCK1-TYPE = DEMAND  
 BLOCK1-DATA = (50, 11.76, 1, 10.73) ..  
 \$ NO DEMAND RATCHET

SEASONS = SCHEDULE THRU APR 30 (ALL) (1,24) (1)  
 THRU OCT 30 (ALL) (1,24) (2)  
 THRU DEC 31 (ALL) (1,24) (1) ..

**Example 12: Mixed Energy Block Types with Complex Demand Ratchets**

This example has a minimum charge equal to the customer charge (\$16) plus \$7.75 per kW of demand. Winter demand is calculated as the greater of:

1. 95% of the greatest summer month; or
2. 60% of the greatest winter month, including 60% of the current month.

Summer demand is calculated as the greater of:

1. 100% of the demand in the current month; or
2. 95% of the demand in any previous summer month; or
3. 60% of the demand in any winter month

The minimum demand charge is 500kW. There is a tax of 5%, and a surcharge credit of 0.717260%

Energy charges are calculated in seven blocks, with costs that are constant all year:

Block	Type	Size	Limit	Winter	Summer
1	kWh	3,000	200 kWh/kW	.1057	.1057
2	kWh	7,000	for	.0963	.0963
3	kWh	190,000	these	.0820	.0820
4	kWh	200,000	4 blocks	.0638	.0638
5	kWh/kW	200	N/A	.01093	.01093
6	kWh/kW	200	N/A	.00865	.00865
7	kWh/kW	>>	N/A	.00755	.00755

There is also an energy cost adjustment factor of \$0.016045 which is constant throughout the year, and a reactive demand charge of \$.27 applied to the kVA in excess of one-third of measured actual kW in current month.

DOE-2.1E input is as follows:

```

ECON-EX-12 = UTILITY-RATE
              RESOURCE           = ELECTRICITY
              DEMAND-QUALS       = (500,0)
              USE-MIN-QUALS      = YES
              QUALIFY-RATE       = ALL-MONTHS
              MONTH-CHGS         = (16.00)
              MIN-MON-CHGS       = (16.00)
              MIN-MON-DE-CHGS    = (7.75) $PER kW DEMAND
              MIN-MON-RATCHETS   = (MON-RATCHET,WIN-60,SUM-95)
              ENERGY-COST-ADJS  = (0.016045)
              BLOCK-CHARGES      = (WINTER, SUMMER)
              PCT-TAX-DATA       = (1, 5)
              PCT-TAXES-APPLY    = (BASE, ECA)
              PCT-SRCHG-DATA     = (1, -0.71726)
              PCT-SRCHGS-APPLY   = (BASE)
              POWER-FACTOR       = 0.7 $WILD GUESS
              EXCESS-KVAR-FRAC   = 0.3 $OF ACTUAL kW
              EXCESS-KVAR-CHG    = 0.27 ..
    
```





**Example 13: Gas Transportation Rate**

It is possible to buy gas at the well-head, and pay a local utility a transportation charge for the use of their pipelines. This is an example of a transportation rate having both energy and demand charges which vary by month. Demand is the maximum daily demand. Since this is a transportation rate, a second rate must be specified for the well-head gas, assumed to cost 2.50 per million Btu.

This rate is in terms of millions of Btu, while the default for natural gas is therms. The ENERGY-RESOURCE command must be used in PLANT to define these units.

\$ ( IN PLANT )

```
ENERGY-RESOURCE RESOURCE      = NATURAL-GAS
                    ENERGY/UNIT = 1000000
                    UNIT-NAME     = MMBTU
                    DEM-UNIT-NAME = MMBTU/DY ..
```

\$ ( IN ECONOMICS )

```
ECON-EX-13 = UTILITY-RATE
              RESOURCE      = NATURAL-GAS
              MONTH-CHGS    = ( 400.07 )
              ENERGY-CHG-SCH = ENERGY-SCH
              DEMAND-CHGS    = ( 24.370, 14.008, 14.564, 11.451,
                               8.206, 8.206, 8.206, 8.206,
                               8.206, 9.199, 10.393, 16.133 )
              DEMAND-WINDOW = DAY ..
```

```
ENERGY-SCH = SCHEDULE THRU JAN 31 (ALL) (1,24) (0.196)
                THRU FEB 29 (ALL) (1,24) (0.185)
                THRU MAR 31 (ALL) (1,24) (0.186)
                THRU APR 30 (ALL) (1,24) (0.163)
                THRU MAY 31 (ALL) (1,24) (0.155)
                THRU JUN 30 (ALL) (1,24) (0.130)
                THRU JUL 31 (ALL) (1,24) (0.141)
                THRU AUG 31 (ALL) (1,24) (0.151)
                THRU SEP 30 (ALL) (1,24) (0.167)
                THRU OCT 31 (ALL) (1,24) (0.201)
                THRU NOV 30 (ALL) (1,24) (0.224)
                THRU DEC 31 (ALL) (1,24) (0.191) ..
```

```
WELLHEAD = UTILITY-RATE
            RESOURCE      = NATURAL-GAS
            ENERGY-CHG   = 2.50 ..
```

In this example, two utility rates have been defined referencing the same RESOURCE and using the same meter, M1 (the default). Each rate will address the entire gas consumption of the facility, and the costs will be additive.

# APPENDIX A

## HOURLY-REPORT VARIABLE LIST

This appendix describes each of the hourly report variables that you can have printed from LOADS, SYSTEMS, and PLANT (hourly reports are not available for ECONOMICS). For information on how to use hourly reports, please refer to the following:

p.1.25 in this manual;

p.II.30 of the *Reference Manual (2.1A)*; and

the "Daylighting Example" in the *Sample Run Book (2.1E)*.

Descriptions of the hourly variables that are more detailed than those given in this appendix can be found in the *Engineers Manual (2.1A)*.

The units shown here are English units; for metric output runs, the corresponding metric units that will be printed can be determined from the DOE-2 Units Table (see the "Metric Option", on p.1.28 of this manual).

## LOADS

VARIABLE-TYPE = GLOBAL

Variable- List Number	Variable in FORTRAN Code	Description
1	CLRNES	Atmospheric clearness number
2	TGNDR	Ground temperature (Rankine)
3	WBT	Outside wet bulb temperature (°F)
4	DBT	Outside dry bulb temperature (°F)
5	PATM	Atmospheric pressure (in. Hg)
6	CLDAMT	Cloud amount, 0 to 10 (0 = clear, 10 = overcast)
7	ISNOW	Snow flag (1 = snowfall); not used in simulation
8	IRAIN	Rain flag (1 = rainfall); not used in simulation
9	IWNDDR	Wind direction (0-15) (0=north, 4=east, 8=south, 12=west)
10	HUMRAT	Humidity ratio (lb H <sub>2</sub> O/lb air)
11	DENSTY	Outside air density (lb/ft <sup>3</sup> )
12	ENTHAL	Specific enthalpy of outside air (Btu/lb)
13	DIFSOL	Diffuse horizontal solar radiation from the weather file; zero when no solar on weather file (Btu/hr-ft <sup>2</sup> ). [Used only in France]
14	DIRSOL	Direct normal solar radiation from the weather file; zero when no solar on weather file (Btu/hr-ft <sup>2</sup> )
15	SOLRAD	Total horizontal solar radiation from the weather file; if non-solar weather file, = calculated total horizontal solar radiation (direct plus diffuse) (Btu/hr-ft <sup>2</sup> )
16	ICLDTY	Cloud type (0=cirrus, 1=stratus, 2=halfway between cirrus and stratus)
17	WNDSPD	Wind speed at weather station (knots)
18	DPT	Dew-point temp (°F)
19	WNDDRR	Wind direction in radians (clockwise from North)
20	CLDCOV	Cloud cover multiplier
21	RDNCC	Direct normal solar radiation. If non-solar weather tape, = clear day direct normal solar radiation times CLDCOV. If solar tape, = measured direct normal solar radiation (DIRSOL) (Btu/hr-ft <sup>2</sup> )
22	BSCC	Diffuse horizontal solar radiation from the sky. If non-solar weather tape, = clear day diffuse horizontal solar radiation times CLDCOV. If solar tape, = measured diffuse horizontal solar (total horizontal minus direct horizontal) (Btu/hr-ft <sup>2</sup> )
23	-	Unused
24	DBTR	Outside dry bulb temperature (Rankine)
25	ISUNUP	Sun up flag (= 1 if sun is up; = 0 if down)

## LOADS

### VARIABLE-TYPE = GLOBAL (continued)

Variable-List Number	Variable in FORTRAN Code	Description
26	GUNDOG	Hour angle of sunrise for the day (radians)
27	HORANG	Current hour angle (radians)
28	TDECLN	Tangent of solar declination angle
29	EQTIME	Value of the solar equation of time (hr)
30	SOLCON	Fitted "solar constant" (Btu/hr-ft <sup>2</sup> ). See <i>Engineers Manual (2.1A)</i> , p.III.24.
31	ATMEXT	Atmospheric extinction coefficient
32	SKYDFP	Sky diffusivity factor
33	RAYCOS(1)	Solar direction cosine (x) in building coordinate system
34	RAYCOS(2)	Solar direction cosine (y) in building coordinate system
35	RAYCOS(3)	Solar direction cosine (z) in building coordinate system
36	RDN	Direct normal solar radiation intensity on a clear day [calculated] (Btu/hr-ft <sup>2</sup> )
37	BSUN	Diffuse solar intensity on a horizontal surface on a clear day [calculated] (Btu/hr-ft <sup>2</sup> )
38	IYR	Year
39	IMON	Month
40	IDAY	Day
41	IHR	Hour (local time; with Daylight Saving Time if appropriate)
42	IDOY	Day of year (1-365)
43	IDOW	Day of week (1-7) (1 = Sunday, 2 = Monday, ...)
44	ISCHR	Schedule hour (DST corrected, IHR + IDSTF)
45	ISCDAY	Schedule day (Day of week; 1 = Sunday, 2 = Monday, ..., 8 = Holiday)
46	IDSTF	Daylight saving time flag (1 if daylight saving in effect, 0 if not)
47	PTWV	Pressure caused by wind velocity (inches of water)
48	ATMTUR(IMO)	Atmospheric turbidity factor according to Angstrom
49	ATMMOI(IMO)	Atmospheric moisture (inches of precipitable water)
50	PHSUND	Solar altitude (degrees above horizon)

## LOADS

### VARIABLE-TYPE = GLOBAL (continued)

Variable-List Number	Variable in FORTRAN Code	Description
51	THSNHR	Solar azimuth (degrees) measured clockwise from North
52	ETACLD	Cloudiness factor; ranges from 0 for overcast sky to 1.0 for clear sky
53	CHISKF	Exterior horizontal illuminance from clear part of sky (footcandles)
54	OHISKF	Exterior horizontal illuminance from overcast part of sky (footcandles)
55	HISUNF	Exterior horizontal illuminance from direct sun (footcandles).
56	ALFAD	Ratio of exterior horizontal illuminance calculated from insolation and luminous efficacy to exterior horizontal illuminance calculated from theoretical CIE sky luminance distributions
57	CDIRLW	Luminance efficacy of direct solar radiation (lumens/watt)
58	CDIFLW	Luminance efficacy of diffuse solar radiation from clear part of sky (lumens/watt)
59	ODIFLW	Luminance efficacy of diffuse solar radiation from overcast part of sky (lumens/watt)

## LOADS

### VARIABLE-TYPE = BUILDING

For each hour, entries are summed for all spaces with a heating load that hour and appear in BLDDTH (1-18), VARIABLE-LIST numbers 1-18; similarly, entries are summed for all zones with a cooling load and appear in BLDDTC (1-18), VARIABLE-LIST numbers 19-36. For example, if a building has three spaces, S1, S2, and S3, and for a given hour, S1 and S2 each have a net heating load, and S3 has a net cooling load, then: (1) the sensible heating load for S1 and S2 appears in VARIABLE-LIST number 1, the latent heating load appears in VARIABLE-LIST number 2, etc.; (2) the sensible cooling load for S3 appears in VARIABLE-LIST number 19, the latent cooling load for S3 appears in VARIABLE-LIST number 20, etc. All loads are in Btu/hr, including electric. "Sensible load" is heat extraction from space air required to maintain constant air temperature; "sensible loads" are obtained from corresponding instantaneous heat gains by application of weighting factors that account for heat storage and release by building mass. "Walls" below are exterior surfaces with tilt  $\geq 45^\circ$ ; "roofs" are exterior surfaces with tilt  $< 45^\circ$ . (All gains and loads reported here are calculated at constant space air temperatures. Corrections for variable space temperature are made in the SYSTEMS calculation.)

Variable-List Number	Variable in FORTRAN Code	Description
1	BLDDTH(1)	Building heating load (sensible)
2	BLDDTH(2)	Building heating load (latent)
3	BLDDTH(3)	Building heating load from wall conduction
4	BLDDTH(4)	Building heating load from roof conduction
5	BLDDTH(5)	Building heating load from window conduction
6	BLDDTH(6)	Building heating load from solar radiation through windows
7	BLDDTH(7)	Building sensible heating load from infiltration
8	BLDDTH(8)	Building heating load from interior wall conduction
9	BLDDTH(9)	Building heating load from conduction through underground walls and floors
10	BLDDTH(10)	Building lighting heating load
11	BLDDTH(11)	Building heating load from doors
12	BLDDTH(12)	Building equipment (electrical) heating load (sensible)
13	BLDDTH(13)	Building source heating load (sensible)
14	BLDDTH(14)	Building people heating load (sensible)
15	BLDDTH(15)	Building people heating load (latent)

## LOADS

### VARIABLE-TYPE = BUILDING (continued)

Variable- List Number	Variable in FORTRAN Code	Description
16	BLDDTH(16)	Building equipment (electrical) heating load (latent)
17	BLDDTH(17)	Building source heating load (latent)
18	BLDDTH(18)	Building infiltration heating load (latent)
19	BLDDTC(1)	Building cooling load (sensible)
20	BLDDTC(2)	Building cooling load (latent)
21	BLDDTC(3)	Building cooling load from wall conduction
22	BLDDTC(4)	Building cooling load from roof conduction
23	BLDDTC(5)	Building cooling load from window conduction
24	BLDDTC(6)	Building cooling load from solar radiation through windows
25	BLDDTC(7)	Building cooling sensible infiltration load
26	BLDDTC(8)	Building cooling load from conduction through interior walls
27	BLDDTC(9)	Building cooling load from conduction through underground walls and floors
28	BLDDTC(10)	Building lighting cooling load
29	BLDDTC(11)	Building cooling load from door conduction
30	BLDDTC(12)	Building equipment (electrical) cooling load (sensible)
31	BLDDTC(13)	Building source cooling load (sensible)
32	BLDDTC(14)	Building people cooling load (sensible)
33	BLDDTC(15)	Building people cooling load (latent)
34	BLDDTC(16)	Building equipment (electrical) cooling load (latent)
35	BLDDTC(17)	Building source cooling load (latent)
36	BLDDTC(18)	Building infiltration cooling load (latent)
37	QBELEC	Building electric total
38	QBGAS	Building gas total
39	QBHW	Building hot water total
40	QBEQEL	Building equipment electric total
41	QBLTEL	Building lighting electric total



## LOADS

VARIABLE-TYPE = u-name of SPACE

All space gains and loads are in Btu/hr, including electric. "Sensible gain" means the instantaneous heat gain before application of weighting factors. "Sensible load" is the heat extraction from space air required to maintain constant air temperature; "loads" are obtained from corresponding gains by application of weighting factors that account for heat storage and release by building mass. "Walls" below are exterior surfaces with tilt greater than or equal to 45°; "roofs" are exterior surfaces with tilt less than 45°. (All sensible gains and loads reported here are calculated at constant space air temperatures. Corrections for variable space temperature are made in the SYSTEMS calculation.)

Variable- List Number	Variable in FORTRAN Code	Description
1	QWALQ	Quick wall conduction gain
2	QCELQ	Quick roof conduction gain
3	QWINC	Window conduction gain
4	QWALD	Delayed wall conduction gain
5	QCELD	Delayed roof conduction gain
6	QINTW	Interior wall conduction gain
7	QUGF	Underground floor conduction gain
8	QUGW	Underground wall conduction gain
9	QDOOR	Door conduction gain
10	QEQPS	Electrical equipment sensible gain
11	QEQPS2	Source sensible gain
12	QPPS	People sensible gain
13	QTSKL	Task light gain
14	QSOL	Glass solar gain
15	QPLENUM	Light heat gain to return air
16	QWALD	Quick wall conduction load
17	QCELQ	Quick roof conduction load
18	QWINC	Window conduction load
19	QWALD	Delayed wall conduction load
20	QCELD	Delayed roof conduction load

## LOADS

VARIABLE-TYPE = u-name of SPACE (continued)

Variable- List Number	Variable in FORTRAN Code	Description
21	QINTW	Interior wall conduction load
22	QUGF	Underground floor conduction load
23	QUGW	Underground wall conduction load
24	QDOOR	Door conduction load
25	QEQPS	Equipment sensible load
26	QEQPS2	Source sensible load
27	QPPS	People sensible load
28	QPPL	People latent gain
29	QEQPL	Equipment latent gain
30	QEQPL2	Source latent gain
31	QINFL	Infiltration latent gain
32	QTSKL	Task lighting load
33	QSOL	Glass solar load
34	ZLTOTH	Light heat gain to other space
35	QLITE	Light gain
36	QLITEW	Light load
37	QINFS	Infiltration sensible gain
38	QELECT	Electric load for space
39	CFMINF	Infiltration flowrate (cfm)
40	QSUMW	Sum of all weighted loads except infiltration and latent
41	ZCOND	Space conductance (Btu/hr-°F)
42	QZS	Space sensible load
43	QZL	Space latent load
44	QZTOT	Space total load
45	QZLTEL	Space electric from lights

## LOADS

VARIABLE-TYPE = u-name of SPACE (continued)

Variable-List Number	Variable in FORTRAN Code	Description
46	QZEQEL	Space electric from equipment
47	QZGAS	Space gas
48	QZHW	Space hot water
49	RDAYIL(1)	Daylight illuminance at LIGHT-REF-POINT1 (footcandles)
50	RDAYIL(2)	Daylight illuminance at LIGHT-REF-POINT2 (footcandles)
51	BACLUM(1)	Background luminance (footlamberts) for glare calculation at LIGHT-REF-POINT1.
52	BACLUM(2)	Background luminance (footlamberts) for glare calculation at LIGHT-REF-POINT2.
53	GLRNDX(1)	Daylight glare index at LIGHT-REF-POINT1 calculated after window management (if any) has been employed as a response to MAX-GLARE, MAX-SOLAR-SCH, and/or CONDUCT-TMIN-SCH.
54	GLRNDX(2)	Daylight glare index at LIGHT-REF-POINT2 calculated after window management (if any) has been employed as a response to MAX-GLARE, MAX-SOLAR-SCH, and/or CONDUCT-TMIN-SCH.
55	FPHRP(1)	Multiplier, due to daylighting, on electric lighting power for the lighting zone at LIGHT-REF-POINT1 (varies from 1.0 if no lighting energy reduction to 0.0 if lighting energy reduced to zero).
56	FPHRP(2)	Multiplier, due to daylighting, on electric lighting power for the lighting zone at LIGHT-REF-POINT2 (varies from 1.0 if no lighting energy reduction to 0.0 if lighting energy reduced to zero).
57	<POWER-RED-FAC>	Net multiplier, due to daylighting, on electric lighting power for the entire space $= \text{FPHRP}(1) * \text{ZONE-FRACTION1} + \text{FPHRP}(2) * \text{ZONE-FRACTION2} + [1 - (\text{ZONE-FRACTION1}) - (\text{ZONE-FRACTION2})]$
58	WNDSPZ	Free-stream windspeed at the location of the space (knots). This is the weather station windspeed (Variable #17, VARIABLE-TYPE = GLOBAL) corrected for terrain, shielding, and space height effects.

## LOADS

VARIABLE-TYPE = u-name of EXTERIOR-WALL

Variable-List Number	Variable in FORTRAN Code	Description
1	SOLI	Total solar radiation on wall (direct and diffuse) after shading (Btu/hr-ft <sup>2</sup> )
2	XGOLGE	Fraction of the wall that is shaded from direct solar radiation
3	FILMU	Outside air film U-value, radiative plus convective (Btu/hr-ft <sup>2</sup> -°F)
4	PCO	Pressure difference across wall caused by wind velocity and stack effect (in. of water)
5	Q	Heat transfer from the wall to the zone, unweighted (Btu/hr)
6	T	Outside surface temperature (Rankine)
7	CFM	Crack method air flow for wall (cfm)
8	C2	} Used in response factor determination of Q and T for delayed walls
9	C3	
10	SUMXDT	
11	SUMYDT	
12	DT	
13	XSXCMP	
14	XSQCMP	
15	ETA	Cosine of the angle between the direction of the sun and the surface outward normal
16	BG	Solar radiation reflected from ground (Btu/hr-ft <sup>2</sup> ) [total horizontal solar radiation × ground reflectance]
17	RDIR	Intensity of direct solar radiation on the surface, <i>before</i> shading (Btu/hr-ft <sup>2</sup> )
18	RDIF	Intensity of diffuse solar radiation on the surface, <i>after</i> shading (Btu/hr-ft <sup>2</sup> )

## LOADS

VARIABLE-TYPE = u-name of WINDOW

Except as noted, the following variables are applicable to both exterior windows (WINDOW in EXTERIOR-WALL) and interior windows (WINDOW in INTERIOR-WALL between a sunspace and a non-sunspace).

1	UAVE	Area-weighted average of glass plus frame U-value (glass U-value is multiplied by CONDUCT-SCHEDULE if defined). Includes inside and outside film coefficients (Btu/hr-ft <sup>2</sup> -°F).
2	TDIR	Direct radiation transmission coefficient of all panes of glass in window.
3	ADIRO	Direct radiation absorption coefficient (outer pane).
4	TDIF	Net diffuse radiation transmission coefficient of all panes of glass in window.
5	ADIFO	Diffuse radiation absorption coefficient (outer pane).
6	ADIRI	Direct radiation absorption coefficient (inner pane).
7	ADIFI	Diffuse radiation absorption coefficient (inner pane).
8	FI	Inward flowing fraction of heat from solar radiation absorbed by inner pane.
9	FO	Inward flowing fraction of heat from solar radiation absorbed by outer pane.
10	AGOLGE	Fraction of window area that is shaded from direct solar radiation. [Exterior WINDOW only]
11	QDIR	Direct solar radiation incident on window (after shading by set-back, overhang, etc.), divided by total window area (Btu/hr-ft <sup>2</sup> ).
12	QDIF	Diffuse solar radiation incident on window (after shading by set-back, overhang, etc.) divided by total window area (Btu/hr-ft <sup>2</sup> ).

## LOADS

VARIABLE-TYPE = u-name of WINDOW (continued)

Variable-List Number	Variable in FORTRAN Code	Description
13	QTRANS	Direct and diffuse solar energy transmitted through glass (after shading by setback, overhang, etc.) divided by glass area (Btu/hr-ft <sup>2</sup> ), before multiplication by glass shading coefficient, if applicable, and by SHADING-SCHEDULE value. [Exterior WINDOW only]
14	QABS	Direct and diffuse solar energy absorbed by glass (after shading by setback, overhang, etc.), and conducted into the space, divided by glass area (Btu/hr-ft <sup>2</sup> ), before multiplication by glass shading coefficient, if applicable, and by SHADING-SCHEDULE value. [Exterior WINDOW only]
15	QSOLG+QABSG	Transmitted plus recondacted solar heat gain through window (glass plus frame) (after shading by setback, overhang, etc.)(Btu/hr). For exterior WINDOW: [(QTRANS+QABS) * (glass area) * (shading coefficient of glass) * (SHADING-SCHEDULE value if defined and shade is in place)] + [direct and diffuse solar energy absorbed by frame and conducted into space]. Shading coefficient is 1.0 if GLASS-TYPE-CODE is used.
16	GSHACO	Shading coefficient of glass. Used only if SHADING-COEF is specified. 1.0 if GLASS-TYPE-CODE is ≤ 11.
17	QCON+QCONFR	Conduction heat gain through window (glass plus frame) (Btu/hr): = UAVE * (glass area + frame area) * (outside DBT - zone temp) - (exterior IR radiation correction) [exterior WINDOW only; for interior WINDOWS, see Variable #58, VARIABLE-TYPE = ZONE, in SYSTEMS ].
18	SWFAC	Switching factor. 0.0 = unswitched; 1.0 = fully switched. [Exterior WINDOW only]
19	SHMULT	Value by which solar heat gain of glazing is multiplied when glass is covered by a shading device. Determined by SHADING-SCHEDULE.

## LOADS

VARIABLE-TYPE = u-name of WINDOW (continued)

Variable-List Number	Variable in FORTRAN Code	Description
20	SOLGMX	Transmitted direct solar gain threshold for activation of glass shading device (Btu/ft <sup>2</sup> ). Determined by MAX-SOLAR-SCH.
21	none	Visible transmittance of glazing (excluding shading device) for direct solar radiation. [Exterior WINDOW only]
22	TAU1	Value by which visible transmittance of glazing is multiplied when glass is covered by a shading device. Determined by VIS-TRANS-SCH. [Exterior WINDOW only]
23	<SHADING-FLAG>	Disposition of window shading device: 0 = no shade assigned to window; 1 = shade assigned but open this hour; 2 = shade assigned and closed this hour due to solar-gain, outside-dry bulb-temperature, or glare test, or for daylit spaces, because WIN-SHADE-TYPE = FIXED-INTERIOR or FIXED-EXTERIOR; 3 = shade assigned and closed this hour but no solar-gain, outside-dry bulb-temperature, or glare test requested (preset schedule control).
24	<ILLUMW> <sub>1</sub>	Contribution of window to daylight illuminance at LIGHT-REF-POINT1 with no shading device on glass (footcandles). [Exterior WINDOW only]
25	<ILLUMW> <sub>2</sub>	Contribution of window to daylight illuminance at LIGHT-REF-POINT2 with no shading device on window (footcandles). [Exterior WINDOW only]
26	<ILLUMW> <sub>3</sub>	Contribution of window to daylight illuminance at LIGHT-REF-POINT1 with glass covered by shading device (footcandles). [Exterior WINDOW only]
27	<ILLUMW> <sub>4</sub>	Contribution of window to daylight illuminance at LIGHT-REF-POINT2 with glass covered by shading device (footcandles). [Exterior WINDOW only]

## LOADS

VARIABLE-TYPE = u-name of DOOR

Variable- List Number	Variable in FORTRAN Code	Description
1	FILMU	Outside air film U-value, radiative plus convective (Btu/hr-ft <sup>2</sup> -°F)
2	DRGOLG	Fraction of door shaded from direct solar radiation
3	SOLID	Solar radiation incident on door (Btu/hr-ft <sup>2</sup> )
4	TSOLD	Outside surface temperature (°R)
5	QD	Heat flow through door (Btu/hr-ft <sup>2</sup> -°F)
6	CFMD	Crack method infiltration air flow (cfm)



## LOADS

### VARIABLE--TYPE = END--USE

A default has been provided for the specification of the VARIABLE-LIST items. If VARIABLE-LIST=(99) the list defaults to: 5, 6, 9, 8, 1, 2, 20, 12, 10, 3, 21, 15, 16, 18, 14, 22. The following end-use variables can also be printed in SYSTEMS and PLANT. In LOADS, only variable-list numbers 1 through 4 can be non-zero. See "Energy End-Uses and Meters", p.3.4 for a more complete description of these variables.

Variable- List Number	Variable in FORTRAN Code	Description
1	LITEKW	Area Lighting Electric (kW)
2	TASKKW	Task Lighting Electric (kW)
3	EQKW	Equipment Electric (kW)
4	SRCKWS	Source Electric (kW)
5	HEATKW	Heating Electric (kW)
6	COOLKW	Cooling Electric (kW)
7	HTRJKW	Heat Rejection Electric (kW)
8	AUXKW	Auxiliary Electric (pumps) (kW)
9	VENTKW	Ventilation Electric (kW)
10	REFGKW	Refrigeration Electric (kW)
11	SUPPKW	HP Supplementary Heating Electric (kW)
12	DHWKW	DHW Electric (kW)
13	ADD1E	Unused
14	SRCFL	Source Fuel (Btu/hr)
15	HEATFL	Heating Fuel (Btu/hr)
16	COOLFL	Cooling Fuel (Btu/hr)
17	SUPPFL	HP Supplementary Heating Fuel (Btu/hr)
18	DHWFL	DHW Fuel (Btu/hr)
19	ADD1FL	Unused
20	EXLTKW	Exterior Lighting Electric (kW)
21	EXMCKW	Exterior Miscellaneous Electric (kW)
22	EXFL	Exterior Miscellaneous Fuel (Btu/hr)

## SYSTEMS

### VARIABLE-TYPE = GLOBAL

Variable-List Number	Variable in FORTRAN Code	Description
1	IYR	Year of simulation run
2	IMO	Month of simulation run
3	IDAY	Day of simulation run
4	IHR	Hour of simulation run
5	ISCDAY	Day-of-the-week for simulation run: 1-7 = Sunday through Saturday 8 = holiday
6	ISCHR	Current hour of simulation run plus daylight saving time flag (hour of schedule to be used)
7	WBT	Outdoor wet bulb temperature (°F)
8	DBT	Outdoor dry bulb temperature (°F)
9	PATM	Outdoor atmospheric pressure (in-Hg)
10	HUMRAT	Outdoor humidity ratio (lb H <sub>2</sub> O/lb dry air)
11	DENSTY	Outdoor air density (lb/ft <sup>3</sup> )
12	ENTHAL	Outdoor air enthalpy (Btu/lb)

The above variables are appropriate to all SYSTEM-TYPES

## SYSTEMS

VARIABLE-TYPE = u-name of ZONE

Variable-List Number	Variable in FORTRAN Code	Description
1	<QS>	Sensible load at constant zone temperature (from LOADS) (Btu/hr)
2	<QL>	Latent load at constant zone temperature, excluding infiltration (from LOADS) (Btu/hr)
3	<ZKW>	Zone electrical load (from LOADS) (kW)
4	<QP>	Light heat to return air (from LOADS) (Btu/hr)
5	<CFMINF>	Outdoor air infiltration rate (from LOADS) (cfm)
6	<TNOW>	Current hour zone temp (°F)
7	<TSET>	Current hour zone thermostat setting; a diagnostic variable not meaningful when <TNOW> is outside the throttling range of either HEAT-TEMP-SCH or COOL-TEMP-SCH (°F)
8	<QNOW>	Current hour heat extraction rate; a diagnostic variable not meaningful when <TNOW> is outside the throttling range of either HEAT-TEMP-SCH or COOL-TEMP-SCH (°F). Excludes heat extraction due to interzone convection across interior wall between sunspace and non-sunspace. For sunspaces, excludes heat extraction due to venting.
9	<CONDUCHR>	Sum of exterior wall + interior wall thermal conductances from LOADS (Btu/hr-°F)
10	-	Unused
11	EXCFM	Exhaust air flow rate (cfm)
12	FH	Hot air flow rate (cfm)
13	FC	Cold air flow rate (cfm)
14	CFMZ	Zone design supply air flow rate (cfm)
15	QHBZ	Baseboard heat output to zone (Btu/hr)

## SYSTEMS

VARIABLE-TYPE = u-name of ZONE (continued)

Variable-List Number	Variable in FORTRAN Code	Description
16	QOVER	Amount of extra heat extraction needed to hold set point if load not met (Btu/hr)
17	THZ	Thermostat set point for heating (°F)
18	TCZ	Thermostat set point for cooling (°F)
19	ERMAX	Maximum heat extraction rate (meaningful only within the current thermostat band) (Btu/hr)
20	ERMIN	Minimum heat extraction rate (meaningful only within the current thermostat band) (Btu/hr)
21	TRY	Trial zone temperature (if no zone coil activity) (°F)
22	FTD	F in temperature variation calculation (TEMDEV subroutine) (Btu/hr)
23	CORINT	A part of the correction in SYSTEMS for the contribution to the zone load due to conduction from adjacent zones (partially calculated in LOADS) (Btu/hr)
24	G0	} Air temperature weighting factors (Btu/hr-°F)
25	G1	
26	G2	
27	G3	
28	SIGMAG	G0 + G1 + G2 + G3 (Btu/hr-°F)
29	TL	Induced air temperature for TPIU, FPIU, SZCI (°F)
30	ZQHR	Portion of reheat load that would bring the supply temperature to the zone temperature (Btu/hr)
31	TAVE	The average zone air temperature during this hour (°F). This is the value used for the energy calculation
32	ZQH	Zone coil heating (Btu/hr)
33	ZQC	Zone coil cooling (Btu/hr)

Note: Variables 34 through 48 apply only to the systems indicated

	TPFC FPFC	HP	UHT	UVT	PTAC	
34 FCHPS (1)	TC	TS	—	TS	TS	Cold deck temp (°F)
35 FCHPS (2)	QH	ZQH	ZQH	ZQH	ZQH	Zone heating (Btu/hr)
36 FCHPS (3)	QC	ZQC	—	—	ZQC	Zone cooling (Btu/hr)
37 FCHPS (4)	SFKW+RFKW	ZFANKW	ZFANKW	ZFANKW	ZFANKW	Zone fan energy (Btu/hr)
38 FCHPS (5)	TM	TM	—	TM	TM	Mixed air temp (°F)
39 FCHPS (6)	WR	TC	—	—	TC	WR = return humidity ratio TC = coil leaving temp
40 FCHPS (7)	WM	WM	—	—	WM	Mixed air humidity ratio (lb H <sub>2</sub> O/lb dry air)
41 FCHPS (8)	WCOIL	WCOIL	—	—	WCOIL	Humidity ratio of air leaving cooling coil (lb H <sub>2</sub> O/lb dry air)
42 FCHPS (9)	PO	PO	—	PO	PO	Ratio of outside air to total supply air
43 FCHPS(10)	QCLAT	QCLATZ	—	—	QCLATZ	Latent load (Btu/hr)
44 FCHPS(11)	PLRC	PLRC	—	—	PLRC	Cap. part load ratio (clg)
45 FCHPS(12)	—	PLRH	—	—	PLRH	Cap. part load ratio (htg)
46 FCHPS(13)	—	EIR	—	—	EIR	Electric input ratio
47 FCHPS(14)	WBTZ	WBTZ	—	—	WBTZ	Zone wet bulb temp (°F)
48 FCHPS(15)	—	—	—	—	EIRM3	Supplemental heat load for zone's heat pump this hour (Btu/hr)
49 ACFM						Weighted plenum flowrate (cuft/min)
50 ZKW						Total zone elec (kW)
51 TCMINZ						Minimum supply air temperature for zone (°F)
52 THMAXZ						Maximum supply air temperature for zone (°F)
53 ERMAXM		All air systems				Extraction rate, top of deadband (Btu/hr)
54 ERMINM		All air systems				Extraction rate, bottom of deadband (Btu/hr)
55 THR		All air systems				(THROTTLING-RANGE)/2 (°F)

## SYSTEMS

### VARIABLE-TYPE = u-name of ZONE (continued)

In the following descriptions, "sunspace" is a SPACE with SUNSPACE = YES; and "room" is a SPACE with SUNSPACE = NO (the default) that is adjacent to a sunspace.

Variable- List Number	Variable in FORTRAN Code	Description
56	<SGIW0>	For room only: total heat gain (unweighted) due to solar radiation coming from adjacent sunspaces through interior windows (Btu/hr).
57	<SLIW0>	For room only: total solar load (weighted) through interior windows from all adjacent sunspaces (Btu/hr).
58	QGWIN	For room or sunspace: heat gain by conduction (unweighted) through interior windows (Btu/hr), calculated with the air temperature of the zone in question fixed at the LOADS calculation temperature and actual previous-hour temperatures for adjacent zones.
59	QSNABT	For room or sunspace: solar radiation absorbed on the sunspace side (opaque part) of interior walls (Btu/hr).
60	QGOPWL	For room or sunspace: heat gain by conduction (unweighted) through opaque part of interior walls (Btu/hr), calculated with the air temperature of the zone in question fixed at the LOADS calculation temperature and actual previous-hour temperatures for adjacent zones.
61	QGVFC	For room or sunspace: heat extraction from convection across interior wall. For room, includes contribution from fan heat if AIR-FLOW-TYPE = FORCED-RECIRC (Btu/hr).
62	CFMFCVT	For room or sunspace: average airflow due to convection across interior wall (cfm).
63	<CFMVNT>	For sunspace only: average airflow due to venting (cfm).
64	<QGVNT>	For sunspace only: heat extraction due to venting (Btu/hr)

## SYSTEMS

VARIABLE-TYPE = u-name of ZONE (continued)

Variable- List Number	Variable in FORTRAN Code	Description
<hr/>		
Items 65-69 below are for SYSTEM-TYPE=HP only		
65	GPMZ	Flow through unit condenser (gal/min)
66	GPMHZ	Flow during unit heating (gal/min)
67	GPMCZ	Flow during unit cooling (gal/min)
68	QHLUPZ	Heat taken from loop (Btu/hr)
69	QCLUPZ	Heat added to loop (Btu/hr)

VARIABLES BY SYSTEM-TYPE FOR  
VARIABLE-TYPE = u-name of ZONE

V-L No.	1	2	3	4	5	6	7	8	9	10	11
SYSTEM- TYPE	SENS LOAD -IN	LATENT LOAD -IN	ELEC LOAD -IN	PLENUM LOAD -IN	INFIL. CFM	ZONE TEMP	THERMO- STAT SET- POINT	EXTRAC- TION RATE	TOT UA FOR HR	UN- USED	EXH CFM
SUM	A	A	A	A	A	A	A	A	A	N	N
SZRH	A	A	A	A	A	A	A	A	A	N	A
MZS	A	A	A	A	A	A	A	A	A	N	A
DDS	A	A	A	A	A	A	A	A	A	N	A
SZCI	A	A	A	A	A	A	A	A	A	N	A
UHT	A	A	A	A	A	A	A	A	A	N	N
UVT	A	A	A	A	A	A	A	A	A	N	N
FPH	A	A	A	A	A	A	A	A	A	N	N
TPFC	A	A	A	A	A	A	A	A	A	N	A
FPFC	A	A	A	A	A	A	A	A	A	N	A
TPIU	A	A	A	A	A	A	A	A	A	N	A
FPIU	A	A	A	A	A	A	A	A	A	N	A
VAVS	A	A	A	A	A	A	A	A	A	N	A
PIU	A	A	A	A	A	A	A	A	A	N	A
RHFS	A	A	A	A	A	A	A	A	A	N	A
HP	A	A	A	A	A	A	A	A	A	N	A
HVSYS	A	A	A	A	A	A	A	A	A	N	A
CBVAV	A	A	A	A	A	A	A	A	A	N	A
RESYS	A	A	A	A	A	A	A	A	A	N	N
PSZ	A	A	A	A	A	A	A	A	A	N	A
PMZS	A	A	A	A	A	A	A	A	A	N	A
PVAVS	A	A	A	A	A	A	A	A	A	N	A
PTAC	A	A	A	A	A	A	A	A	A	N	N
PVVT	A	A	A	A	A	A	A	A	A	N	N
RESVVT											

Legend:

- A = Appropriate
- D = Used for program code debugging only
- N = Not appropriate
- S = System (or configuration) dependent
- X = Unused



VARIABLES BY SYSTEM-TYPE FOR

VARIABLE-TYPE = u-name of ZONE

V-L No.	12	13	14	15	16	17	18	19	20	21	22
SYSTEM-TYPE	HOT DECK CFM	COLD DECK CFM	SUPPLY CFM	BASE BOARD HEAT RATE	LOAD NOT MET	HEAT SET-POINT	COOL SET-POINT	MAX COOLING	MAX HEATING	FLOAT TEMP	F IN TEM-DEV
SUM	N	N	N	A	A	A	A	A	A	A	D
SZRH	N	N	A	A	A	A	A	A	A	A	D
MZS	A	A	A	A	A	A	A	A	A	A	A
DDS	A	A	A	A	A	A	A	A	A	A	D
SZCI	N	N	A	A	A	A	A	A	A	A	D
UHT	A	N	A	A	A	A	A	A	A	A	D
UVT	A	N	A	A	A	A	A	A	A	A	D
FPH	N	N	N	A	A	A	A	A	A	A	D
TPFC	N	N	A	A	A	A	A	A	A	A	D
FPFC	N	N	A	A	A	A	A	A	A	A	D
TPIU	N	N	A	A	A	A	A	A	A	A	D
FPIU	N	N	A	A	A	A	A	A	A	A	D
VAVS	N	N	A	A	A	A	A	A	A	A	D
PIU	N	N	A	A	A	A	A	A	A	A	D
RHFS	N	N	A	A	A	A	A	A	A	A	D
HP	A	A	A	A	A	A	A	A	A	A	D
HVSYS	N	N	A	A	A	A	A	A	A	A	D
CBVAV	N	N	A	A	A	A	A	A	A	A	D
RESYS	N	N	N	A	A	A	A	A	A	A	D
PSZ	N	N	A	A	A	A	A	A	A	A	D
PMZS	A	A	A	A	A	A	A	A	A	A	D
PVAVS	N	N	A	A	A	A	A	A	A	A	D
PTAC	A	A	A	A	A	A	A	A	A	A	D
PVVT	N	N	A	A	A	A	A	A	A	A	D
RESVVT											

Legend:

- A = Appropriate
- D = Used for program code debugging only
- N = Not appropriate
- S = System (or configuration) dependent
- X = Unused

VARIABLES BY SYSTEM-TYPE FOR  
VARIABLE-TYPE = u-name of ZONE

V-L No.	23	24	25	26	27	28	29	30	31	32	33
SYSTEM- TYPE	INT TRAN TO ZONE	TEM DEV VAR G0	TEM DEV VAR G1	TEM DEV VAR G2	TEM DEV VAR G3	TEM DEV- SIG- MAG	IND UNIT AIR TEMP	HEAT TO ZONE T	COOL TO ZONE T	HEAT ING BY COILS	COOL ING BY COILS
SUM	A	D	D	D	D	D	N	N	N	N	N
SZRH	A	D	D	D	D	D	N	A	N	A	N
MZS	D	D	D	D	D	D	N	N	N	N	N
DDS	A	D	D	D	D	D	N	N	N	N	N
SZCI	A	D	D	D	D	D	N	A	N	A	N
UHT	A	D	D	D	D	D	N	N	N	A	A
UVT	A	D	D	D	D	D	N	N	N	A	A
FPH	A	D	D	D	D	D	N	N	N	A	N
TPFC	A	D	D	D	D	D	N	N	N	A	A
FPFC	A	D	D	D	D	D	N	N	N	A	A
TPIU	A	D	D	D	D	D	A	N	N	A	N
FPIU	A	D	D	D	D	D	A	N	N	A	N
VAVS	A	D	D	D	D	D	N	A	N	A	N
PIU	A	D	D	D	D	D	N	A	N	A	N
RHFS	A	D	D	D	D	D	N	A	N	A	N
HP	A	D	D	D	D	D	N	N	N	A	A
HVSYS	A	D	D	D	D	D	N	A	N	A	N
CBVAV	A	D	D	D	D	D	N	A	N	A	N
RESYS	A	D	D	D	D	D	N	N	N	N	N
PSZ	A	D	D	D	D	D	N	A	N	A	N
PMZS	A	D	D	D	D	D	N	N	N	N	N
PVAVS	A	D	D	D	D	D	N	A	N	A	N
PTAC	A	D	D	D	D	D	N	N	N	A	A
PVVT	A	D	D	D	D	D	N	A	N	A	A
RESVVT											

Legend:

- A = Appropriate
- D = Used for program code debugging only
- N = Not appropriate
- S = System (or configuration) dependent
- X = Unused

VARIABLES BY SYSTEM-TYPE FOR  
VARIABLE-TYPE = u-name of ZONE

V-L No.	34	35	36	37	38	39	40	41	42	43	44
SYSTEM-TYPE	UNIT SUP TEMP	UNIT HEATING	UNIT COOLING	UNIT FAN KW	UNIT MIX TEMP	UNIT WR or TC	UNIT MIX HUM	UNIT COIL HUM	UNIT OA-RATIO	UNIT LAT COOL	UNIT COOL PLR
SUM	N	N	N	N	N	N	N	N	N	N	N
SZRH	N	N	N	N	N	N	N	N	N	N	N
MZS	N	N	N	N	N	N	N	N	N	N	N
DDS	N	N	N	N	N	N	N	N	N	N	N
SZCI	N	N	N	N	N	N	N	N	N	N	N
UHT	A	A	A	A	A	S	A	A	A	A	A
UVT	A	A	A	A	A	S	A	A	A	A	A
FPH	N	N	N	N	N	N	N	N	N	N	N
TPFC	A	A	A	A	A	S	A	A	A	A	A
FPFC	A	A	A	A	A	S	A	A	A	A	A
TPIU	N	N	N	N	N	N	N	N	N	N	N
FPIU	N	N	N	N	N	N	N	N	N	N	N
VAVS	N	N	N	N	N	N	N	N	N	N	N
PIU	N	N	N	N	N	N	N	N	N	N	N
RHFS	N	N	N	N	N	N	N	N	N	N	N
HP	A	A	A	A	A	A	A	A	A	A	A
HVSYS	N	N	N	N	N	N	N	N	N	N	N
CBVAV	N	N	N	N	N	N	N	N	N	N	N
RESYS	N	N	N	N	N	N	N	N	N	N	N
PSZ	N	N	N	N	N	N	N	N	N	N	N
PMZS	N	N	N	N	N	N	N	N	N	N	N
PVAVS	N	N	N	N	N	N	N	N	N	N	N
PTAC	A	A	A	A	A	S	A	A	A	A	A
PVVT	N	N	N	N	N	N	N	N	N	N	N
RESVVT											

Legend:

- A = Appropriate
- D = Used for program code debugging only
- N = Not appropriate
- S = System (or configuration) dependent
- X = Unused

VARIABLES BY SYSTEM-TYPE FOR  
VARIABLE-TYPE = u-name of ZONE

V-L No.	45	46	47	48	49	50	51	52	53	54	55
SYSTEM-TYPE	UNIT HEAT PLR	UNIT EIR	UNIT WET BULB	UNIT DE-FROST	WEIGHTED CFM	TOT ELEC	MIN COOL T	MAX HEAT T	DEAD BAND MAX EXTR	DEAD BAND MIN EXTR	THROT OVER TWO
SUM	N	N	N	N	N	A	N	N	N	N	N
SZRH	N	N	N	N	A	A	A	A	A	A	A
MZS	N	N	N	N	A	A	A	A	A	A	A
DDS	N	N	N	N	A	A	A	A	A	A	A
SZCI	N	N	N	N	A	A	A	A	A	A	A
UHT	A	A	A	N	N	A	A	A	A	A	A
UVT	A	A	A	N	N	A	A	A	A	A	A
FPH	N	N	N	N	N	A	N	N	N	N	N
TPFC	A	A	A	N	N	A	A	A	A	A	A
FPFC	A	A	A	N	N	A	A	A	A	A	A
TPIU	N	N	N	N	A	A	A	A	A	A	A
FPIU	N	N	N	N	A	A	A	A	A	A	A
VAVS	N	N	N	N	A	A	A	A	A	A	A
PIU	N	N	N	N	A	A	A	A	A	A	A
RHFS	N	N	N	N	A	A	A	A	A	A	A
HP	A	A	A	A	N	A	A	A	A	A	A
HVSYS	N	N	N	N	A	A	A	A	A	A	A
CBVAV	N	N	N	N	A	A	A	A	A	A	A
RESYS	N	N	N	N	N	A	A	A	A	A	A
PSZ	N	N	N	N	A	A	A	A	A	A	A
PMZS	N	N	N	N	A	A	A	A	A	A	A
PVAVS	N	N	N	N	A	A	A	A	A	A	A
PTAC	A	A	A	A	N	A	A	A	A	A	A
PVVT	N	N	N	N	A	A	A	A	A	A	A
RESVVT											

Legend:

- A = Appropriate
- D = Used for program code debugging only
- N = Not appropriate
- S = System (or configuration) dependent
- X = Unused

VARIABLES BY SYSTEM-TYPE FOR

VARIABLE-TYPE = u-name of ZONE

V-L No.	56	57	58	59	60	61	62	63	64
SYSTEM-TYPE	COM WIN SOL GAIN BTU/HR	COM WIN SOL LOAD BTU/HR	COM WIN CON- DUC- TION BTU/HR	COM WIN ABSD SOL BTU/HR	COM WALL CON- DUC- TION BTU/HR	CON- VEC HEAT GAIN BTU/HR	CON- VEC AIR FLOW CFM	SUN- SPACE FAN PWR KW	SUN- SPACE VENT FLOW CFM
SUM	A	A	A	A	A	A	A	A	A
SZRH	A	A	A	A	A	A	A	A	A
MZS	A	A	A	A	A	A	A	A	A
DDS	A	A	A	A	A	A	A	A	A
SZCI	A	A	A	A	A	A	A	A	A
UHT	A	A	A	A	A	A	A	A	A
UVT	A	A	A	A	A	A	A	A	A
FPH	A	A	A	A	A	A	A	A	A
TPFC	A	A	A	A	A	A	A	A	A
FPFC	A	A	A	A	A	A	A	A	A
TPIU	A	A	A	A	A	A	A	A	A
FPIU	A	A	A	A	A	A	A	A	A
VAVS	A	A	A	A	A	A	A	A	A
PIU	A	A	A	A	A	A	A	A	A
RHFS	A	A	A	A	A	A	A	A	A
HP	A	A	A	A	A	A	A	A	A
HVSYS	A	A	A	A	A	A	A	A	A
CBVAV	A	A	A	A	A	A	A	A	A
RESYS	A	A	A	A	A	A	A	A	A
PSZ	A	A	A	A	A	A	A	A	A
PMZS	A	A	A	A	A	A	A	A	A
PVAVS	A	A	A	A	A	A	A	A	A
PTAC	A	A	A	A	A	A	A	A	A
PVVT	A	A	A	A	A	A	A	A	A
RESVVT									

Legend:

- A = Appropriate
- D = Used for program code debugging only
- N = Not appropriate
- S = System (or configuration) dependent
- X = Unused

## SYSTEMS

VARIABLE-TYPE = u-name of SYSTEM

Variable- List Number	Variable in FORTRAN Code	Description
1	TH	Temperature of air leaving heating coil - hot deck temp (°F)
2	TC	Temperature of air leaving cooling coil - cold deck temp (°F)
3	TM	Temperature of air entering coil (°F)
4	TR	Return air temperature on the downstream side of the return fan and plenums (°F)
5	QH	Total central heating coil energy input (Btu/hr)
6	QC	Total central cooling coil energy input (Btu/hr)
7	QHZ	Total zone heating energy input (Btu/hr)
8	QCZ	For SYSTEM-TYPE = RESYS this is the cooling by natural ventilation
T}		
9	QHB	Total baseboard heating energy input (Btu/hr)
10	QHP	Total preheat coil energy input (Btu/hr)
11	QHUM	Humidification energy input (for RESYS and RESVVT: electrical resistance heat load) (Btu/hr)
12	QDHUM	Sensible dehumidification reheat input (for RESYS and RESVVT: defrost load) (Btu/hr)
13	TCMIN	Minimum temperature air handler could supply (°F)
14	THMAX	Maximum temperature air handler could supply (°F)
15	QLSUM	Total system latent heat load from LOADS (Btu/hr)
16	QPSUM	Total system light heat to return (Btu/hr)
17	CFM	Total system supply air flow rate (cfm)
18	CFMH	Total system hot supply air flow rate (DDS, MZS, PMZS) (cfm)
19	CFMC	Total system cold supply air flow rate (DDS, MZS, PMZS) (cfm)
20	RCFM	Total system return air flow rate (cfm)

## SYSTEMS

VARIABLE-TYPE = u-name of SYSTEM (continued)

Variable-List Number	Variable in FORTRAN Code	Description
21	ECFM	Total system exhaust air flow rate (cfm)
22	CINF	Outside air infiltration rate (cfm)
23	FON	Fan on/off flag (1 = on, 0 = off, -1 = cannot cycle on for NIGHT-CYCLE-CTRL)
24	HON	Heating on/off flag (1 = on, 0 = off)
25	CON	Cooling on/off flag (1 = on, 0 = off)
26	BON	Baseboard heater on-off flag (ratio from RESET-SCHEDULE)
27	CONS(1)	In the equation $Q = \text{CONS}(1) * \text{CFM} * \Delta T$ , $\text{CONS}(1) = (.24 + .44 * \text{HUMRAT}) * 60.0 / V(\text{DBT}, \text{HUMRAT}, \text{PATM}) = 1.08$ at standard conditions
28	CONS(2)	In the equation $Q = \text{CONS}(2) * \text{CFM} * DW$ , $\text{CONS}(2) = 1061.0 * 60.0 / V(\text{DBT}, \text{HUMRAT}, \text{PATM}) = 4790$ at standard conditions
29	CONS(3)	Conversion factor for fan pressure to kW; $\text{CONS}(3) = .3996 / \text{CONS}(1), = .363$ at standard conditions
30	PH	For dual duct systems: ratio of hot duct cfm to total cfm
31	PC	For dual duct systems: ratio of cold duct cfm to total cfm
32	SKW	Hourly total electrical consumption (kW)
33	FANKW	Total of supply fan, return fan, and exhaust fan electrical consumption (kW)
34	DTREC	Makeup air temperature obtainable from recovery system (°F)
35	WR	Return air humidity ratio (lb H <sub>2</sub> O/lb dry air)
36	WM	Mixed air humidity ratio (lb H <sub>2</sub> O/lb dry air)
37	WCOIL	Humidity ratio of air leaving cooling coil (lb H <sub>2</sub> O/lb dry air)
38	WW	Moisture added or removed from air for (de)humidification (lb H <sub>2</sub> O/lb dry air)
39	PO	Ratio of outside air flow to total supply air flow
40	D	Density of air x 60 min/hr (lb/ft <sup>3</sup> x min/hr)

## SYSTEMS

VARIABLE-TYPE = u-name of SYSTEM (continued)

Variable-List Number	Variable in FORTRAN Code	Description
41	FTEMP	Temperature of circulating fluid for HP system (°F)
42	TCR	Effect of controller on cooling coil set point (°F)
43	QHR	Adjusted capacity of heat pump this hour for RESYS, RESVVT and PTAC (Btu/hr)
44	QCR	Unused
45	SGAS	Total gas heating (Btu/hr)
46	SKWQH	Electrical input to heating (kW)
47	SKWQC	Electrical input to cooling (kW)
48	QCLAT	Latent part of total cooling (Btu/hr)
49	SFKW	Supply fan electrical (kW)
50	RFKW	Return fan electrical (kW)
51	FONNGT	If system can be cycled on at night, = -1 for heating, = 0 for no cycle, = +1 for cooling
52	WSURF	Humidity ratio at saturation at coil surface temperature
53	WSURFM	WSURF for coil temperature TSURFM
54	TSURF	coil surface temperature at supply set point (°F)
55	TSURFM	Minimum obtainable surface temp for humidity control (°F)
56	CBF	Coil bypass factor: (COIL-BF) * CBF1 * CBF2
57	CBF1	Temperature correction to COIL-BF
58	CBF2	Cfm correction to COIL-BF
59	SOIL	Oil consumption by system (Btu/hr)
60	PLRCFM	(Current hour cfm)/(design cfm)
61	PLRC	Capacity part load ratio for cooling
62	PLRH	Capacity part load ratio for heating
63	QCM1	Temperature correction to COOLING-CAPACITY
64	QCM2	Temperature correction to COOL-SH-CAP
65	QHM1	Temperature correction to HEATING-CAPACITY



## SYSTEMS

VARIABLE-TYPE = u-name of SYSTEM (continued)

Variable-List Number	Variable in FORTRAN Code	Description
66	EIRM1	Temperature correction to COOLING-EIR
67	EIRM2	Part load correction to COOLING-EIR
68	EIR	(COOLING-EIR) * EIRM1 * EIRM2 (Btu/Btu)
69	OFKW	Outside fan power (kW)
70	QCT	Total cooling capacity (Btu/hr)
71	QCS	Sensible cooling capacity (Btu/hr)
72	WRMAX	Maximum humidity set point (lb H <sub>2</sub> O/lb)
73	WRMIN	Minimum humidity set point (dry air)
74	CFMRAT	Maximum ratio of zone cfm that can be obtained this hour (mainly for COINCIDENT-sized fans)
75	PCH	For DDS, MZS, and PMZS: the current hour value of HCOIL-WIPE-FCFM. For RESYS: 1 indicates venting; 0 indicates no venting
76	unused	
77	unused	
78*	QHT	The total heating capacity (Btu/hr)
79*	TPOMIN	The mixed air temperature for minimum OA damper position (°F)
80*	POMIN	The minimum OA damper position (°F)
*These variables do not apply to SUM, FPH, or any zonal SYSTEM-TYPE.		
81	QHSUP	The total supplemental heat load for RESYS, RESVVT, PSZ and PTAC (Btu/hr)
82	QRSENS	Sensible heat gain to zone from refrigerated casework (PSZ only) (Btu/hr)
83	QRLAT	Latent heat gain to zone from refrigerated casework (PSZ only) (Btu/hr)
84	QRREC	Energy recovered from condenser and used for space heating in heat recovery mode (PSZ only) (Btu/hr)
85	QRREJ	Energy rejected from condenser (PSZ only) (Btu/hr)

## SYSTEMS

VARIABLE-TYPE = u-name of SYSTEM (continued)

Variable- List Number	Variable in FORTRAN Code	Description
86	RCOMKW	Electrical energy consumed by compressors (PSZ only) (kW)
87	RDEFKW	Electrical energy consumed by defrosters (PSZ only) (kW)
88	RAUXKW	Electrical energy consumed by lights, fans, and anti-sweat heaters in refrigerated casework (PSZ only) (kW)
89	ECFMP	Plenum exhaust flow rate (cfm)
90	SCGAS	Gas used for cooling (Btu/hr)
91	QREG	Regeneration energy (Btu/hr)
92	WBR	Return air wet bulb temperature (°F)
93-98		Debug variables for PTGSD
99	EFF	Direct evaporative cooler effectiveness
100	DTON	Fraction of hour on
101-111		Debug variables for PTGSD
112	DBOA	dry bulb temperature of air leaving desiccant or evaporative supplemental cooling unit (°F)
113	WOA	humidity ratio of air leaving desiccant or evaporative supplemental unit (lb H <sub>2</sub> O/lb air)
114	DGAS	gas used to desiccate the air for integrated (supplemental) units (Btu/hr)
115	DKW	auxiliary electricity used by the integrated (supplemental) desiccant unit (kW)
116	TCOND	temperature of water sent to condenser (DUBLSORB) (°F)
117	QCDTOT	total cooling done by desiccant unit (Btu/hr)
118	QCDS	sensible cooling done by desiccant unit (Btu/hr)
119	QC DL	latent cooling done by desiccant unit (Btu/hr)
120	POA	ratio of air flowing through supplemental desiccant or evaporative unit to total supply air
121	EVKW	auxiliary electricity used by the supplemental evaporative cooler (kW)
122	QCEVT	total cooling done by the evaporative cooling unit (Btu/hr)
123	QCEVS	sensible cooling by the evaporative cooling unit (Btu/hr)
124	QCEVL	latent cooling by the evaporative cooling unit (Btu/hr)
125	HPDefE	heat pump defrost energy (Btu)

## SYSTEMS

VARIABLE-TYPE = u-name of SYSTEM (continued)

Variable-List Number	Variable in FORTRAN Code	Description
126	SHWht	Water heating by service hot water heat pump (Btu/hr)
127	SHWzc	Zone cooling by service hot water heat pump (Btu/hr)
128	SHWen	Energy consumed by service hot water heat pump (Btu/hr)
Items 129-150 for SYSTEM-TYPE=HP and CONDENSER-TYPE=WATER-COOLED only		
129	GPMS	Condenser water flow (gal/min)
130	GPMHS	Condenser flow for heating (gal/min)
131	GPMCS	Condenser flow for cooling (gal/min)
132	QHLUPS	Heat taken from loop (Btu/hr)
133	QCLUPS	Heat added to loop (Btu/hr)
134	WSEGPS	Water-side economizer flow for cooling (not HP) (gal/min)
135	QCWSES	Water-side economizer heat added to loop (Btu/hr)
136-138	—	Unused
139	CAPAIR	Heat cap of water-side economizer (Btu/hr-°F)
140	CAPWTR	Heat cap of air-side of economizer (Btu/hr-°F)
141	QCWSEM	Max possible water-side economizer exchange (Btu/hr)
142	QCWSE	Actual water-side economizer exchange (Btu/hr)
143	WSEDTA	Temperature change of air (°F)
144	WSEDTW	Temperature change of water (°F)
145	WSEXEF	Water-side economizer heat-exchanger effectiveness
146	WSENTU	Unused
147	WSEUA	Unused
148	WSEQMX	Unused
149	WSEPLR	Fraction of water-side economizer max flow used
150	WSEDT	Air/water temperature difference
151-154	—	Unused
Items 155-213 below are for HEAT-SOURCE = GAS-HEAT-PUMP or COMPRESSOR-TYPE = VARIABLE-SPEED		
155	QCRUN	→ Cooling Mode: Run time of compressor (hours)
156	QCLOAD	Output of unit (Btu/hr)

## SYSTEMS

VARIABLE-TYPE = u-name of SYSTEM (continued)

Variable- List Number	Variable in FORTRAN Code	Description
157	QCGAS	Gas or electricity consumed by unit for cooling (Btu/hr)
158	QCAUX	Fans/Pumps/Aux energy (Btu/hr)
159	QCGSLD	Unmet cooling load (Btu/hr)
160	QCGSUP	Unused
161	QCWAS	Waste heat generated (Btu/hr)
162	QCWASU	Waste heat used (Btu/hr)
163	QCGSAV1	Unused
164	QCFAN	Indoor fan energy (Btu/hr)
165	QHRUN	→ Heating Mode: Run time of compressor (hours)
166	QHLOAD	Output of Unit (Btu/hr)
167	QHGAS	Gas or electricity consumed by unit for heating (Btu/hr)
168	QHAUX	Fans/Pumps/Aux energy (Btu/hr)
169	QHGSLD	Load on supp heat (Btu/hr)
170	QHGSUP	Energy input to supp (Btu/hr)
171	QHWAS	Waste heat generated (Btu/hr)
172	QHWASU	Waste heat used (Btu/hr)
173	QHGDFR	Defrost imposed heat (Btu/hr)
174	QHFAN	Indoor fan energy (Btu/hr)
175	COIL-BF-FPLR	Value of COIL-BF-FPLR used this hour
176-177	-	Unused
178	COOL-EIR-FRPMT	Value of COOL-EIR-FRPMT used this hour
179	COOL-RPM-FPLR	Value of COOL-RPM-FPLR used this hour
180	COOL-WH-FT	Value of COOL-WH-FT used this hour
181	COOL-WH-FRPMT	Value of COOL-WH-FRPMT used this hour
182	COOL-CFM-FPLR	Value of COOL-CFM-FPLR used this hour
183	OUTSIDE-FAN-CFLT	Value of OUTSIDE-FAN-CFLT used this hour
184	HEAT-EIR-FRPMT	Value of HEAT-EIR-FRPMT used this hour
185	HEAT-RPM-FPLR	Value of HEAT-RPM-FPLR used this hour

## SYSTEMS

VARIABLE--TYPE = u-name of SYSTEM (continued)

Variable- List Number	Variable in FORTRAN Code	Description
186	HEAT-WH-FT	Value of HEAT-WH-FT used this hour
187	HEAT-WH-FRPMT	Value of HEAT-WH-FRPMT used this hour
188	HEAT-CFM-FPLR	Value of HEAT-CFM-FPLR used this hour
189	OUTSIDE-FAN-HFLT	Value of OUTSIDE-FAN-HFLT used this hour
190	HEAT-LOS-FPLR	Value of HEAT-LOS-FPLR used this hour
191	COOL-LOS-FPLR	Value of COOL-LOS-FPLR used this hour
192	DEFROST-FRAC-FT	Ratio of defrost/heating time
193	DEFROST-CAP-FT	Heating fraction for defrost
194	DEFROST-PWR-FT	EIR in defrost mode
195	COOL-CAP-FRPMT	Value of COOL-CAP-FRPMT curve used this hour
196	HEAT-CAP-FRPMT	Value of HEAT-CAP-FRPMT curve used this hour
197-203	-	Unused
204	GCAP(1)	Capacity at maximum RPM (Btu/hr)
205	GCAP(2)	Capacity at minimum RPM (Btu/hr)
206	GEDB	Entering mixed air temperature (°F)
207	QHDFRG	Gas or electricity used in defrost mode (Btu/hr)
208	GRPM	Speed of compressor (RPM)
209	PLRSUP	PLR of supplemental heating unit
210	PLRCC	PLR in cooling mode
211	CLPLR	Cycling loss PLR
212	CFMVVT	Flow fraction for PVVT
213	QHZHP	Total zone heating load for gas heat pump (Btu/hr)
214	EDB	Condenser entering temperature (evaporative pre-cooler exit temperature) (°F)

VARIABLES BY SYSTEM-TYPE FOR VARIABLE-TYPE = u-name of SYSTEM

V-L No.	1	2	3	4	5	6	7	8	9	10
SYSTEM-TYPE	HTG COIL AIR TEMP	CLG COIL AIR TEMP	MIX AIR TEMP	RET AIR TEMP	TOT HTG COIL BTU	TOT CLG COIL BTU	TOT ZONE HTG BTU	TOT ZONE CLG BTU	TOT BASE-BOARD ENERGY	TOT PRE-HEAT ENERGY
SUM	N	N	N	N	A	A	N	N	N	N
SZRH	N	A	A	A	A	A	A	A	A	A
MZS	A	A	A	A	A	A	N	N	A	A
DDS	A	A	A	A	A	A	N	N	A	A
SZCI	N	A	A	A	A	A	A	A	A	A
UHT	N	N	N	N	A	A	A	N	A	N
UVT	N	N	N	N	A	A	A	N	A	N
FPH	N	N	N	N	A	N	A	N	A	N
TPFC	N	N	N	N	A	A	A	A	A	N
FPFC	N	N	N	N	A	A	A	A	A	N
TPIU	N	A	A	A	A	A	A	A	A	A
FPIU	N	A	A	A	A	A	A	A	A	A
VAVS	N	A	A	A	A	A	A	A	A	A
PIU	N	A	A	A	A	A	A	A	A	A
RHFS	N	A	A	A	A	A	A	A	A	A
HP	N	N	N	N	A	A	A	A	A	N
HVSY	A	N	A	A	A	N	A	N	A	A
CBVAV	N	A	A	A	A	A	A	A	A	A
RESYS	A	A	A	A	A	A	A	A	A	A
PSZ	N	A	A	A	A	A	A	A	A	A
PMZS	A	A	A	A	A	A	N	N	A	A
PVAVS	N	A	A	A	A	A	A	A	A	A
PTAC	A	N	N	N	A	A	A	A	A	N
PTGSD	N	D	A	A	A	A	N	N	A	N
PVVT	N	A	A	A	A	A	A	A	A	A
RESVVT										

Legend:

- A = Appropriate
- D = Used for program code debugging only
- N = Not appropriate
- S = System (or configuration) dependent
- X = Unused

VARIABLES BY SYSTEM-TYPE FOR VARIABLE-TYPE = u-name of SYSTEM

V-L No.	11	12	13	14	15	16	17	18	19	20
SYSTEM-TYPE	HUMIDCN HEAT- ING	DE HUMID RE- HEAT	MIN SUP T	MAX SUP T	SUM ZONE LAT HEAT	SUM ZONE PLN HEAT	TOT SYS CFM	TOT HOT CFM	TOT COLD CFM	RET CFM
SUM	N	N	N	N	A	A	N	N	N	N
SZRH	A	A	A	A	A	A	A	N	N	A
MZS	A	A	A	A	A	A	A	A	A	A
DDS	A	A	A	A	A	A	A	A	A	A
SZCI	A	A	A	A	A	A	A	N	N	A
UHT	N	N	N	N	N	N	N	N	N	N
UVT	N	N	N	N	N	N	N	N	N	N
FPH	N	N	N	N	N	N	N	N	N	N
TPFC	A	A	N	N	N	N	N	N	N	N
FPFC	A	A	N	N	N	N	N	N	N	N
TPIU	A	A	A	A	A	A	A	N	N	A
FPIU	A	A	A	A	A	A	A	N	N	A
VAVS	A	A	A	A	A	A	A	N	N	A
PIU	A	A	A	A	A	A	A	N	N	A
RHFS	A	A	A	A	A	A	A	N	N	A
HP	N	N	N	N	N	N	N	N	N	A
HVSYS	A	N	A	A	A	A	A	N	N	A
CBVAV	A	A	A	A	A	A	A	N	N	A
RESYS	S	S	A	A	A	A	A	N	N	A
PSZ	A	A	A	A	A	A	A	N	N	A
PMZS	A	A	A	A	A	A	A	A	A	A
PVAVS	A	A	A	A	A	A	A	N	N	A
PTAC	N	N	N	N	N	N	N	N	N	A
PTGSD	N	N	A	A	A	A	A	N	N	A
PVVT	A	A	A	A	A	A	A	N	N	A
RESVVT										

Legend:

- A = Appropriate
- D = Used for program code debugging only
- N = Not appropriate
- S = System (or configuration) dependent
- X = Unused

VARIABLES BY SYSTEM-TYPE FOR VARIABLE-TYPE = u-name of SYSTEM

V-L No.	21	22	23	24	25	26	27	28	29	30
SYSTEM-TYPE	EX-HAUST CFM	IN-FIL CFM	FANS ON/ OFF	HEAT ON/ OFF	COOL ON/ OFF	BASE-BOARD SCH RATIO	CON-STANT (1.08)	CON-STANT (.689)	CON-STANT (.363)	HOT AIR FRAC-TION
SUM	N	A	A	A	A	N	N	N	N	N
SZRH	A	A	A	A	A	A	A	A	A	N
MZS	A	A	A	A	A	A	A	A	A	A
DDS	A	A	A	A	A	A	A	A	A	A
SZCI	A	A	A	A	A	A	A	A	A	N
UHT	N	N	A	A	A	A	A	A	A	N
UVT	N	N	A	A	A	A	A	A	A	N
FPH	N	N	N	A	N	A	N	N	N	N
TPFC	N	N	A	A	A	A	A	A	A	N
FPFC	N	N	A	A	A	A	A	A	A	N
TPIU	A	A	A	A	A	A	A	A	A	N
FPIU	A	A	A	A	A	A	A	A	A	N
VAVS	A	A	A	A	A	A	A	A	A	N
PIU	A	A	A	A	A	A	A	A	A	N
RHFS	A	A	A	A	A	A	A	A	A	N
HP	N	N	A	A	A	A	A	A	A	N
HVSYS	A	A	A	A	A	A	A	A	A	N
CBVAV	A	A	A	A	A	A	A	A	A	N
RESYS	N	A	A	A	A	A	A	A	A	N
PSZ	A	A	A	A	A	A	A	A	A	N
PMZS	A	A	A	A	A	A	A	A	A	A
PVAVS	A	A	A	A	A	A	A	A	A	N
PTAC	N	N	A	A	A	A	A	A	A	N
PTGSD	A	A	A	A	N	A	A	A	A	N
PVVT	A	A	A	A	A	A	A	A	A	N
RESVVT										

Legend:

- A = Appropriate
- D = Used for program code debugging only
- N = Not appropriate
- S = System (or configuration) dependent
- X = Unused



VARIABLES BY SYSTEM-TYPE FOR VARIABLE-TYPE = u-name of SYSTEM

V-L No.	31	32	33	34	35	36	37	38	39	40
SYSTEM-TYPE	COLD AIR FRAC	TOTAL ELEC KW	TOTAL FAN ELEC	DELTA T RE-COV	RET HUMID	MIX HUMID	HUMIDITY LVG COIL	MOIST CHANGE	OUT-SIDE/TOT CFM	DENSITY (AIR*60)
SUM	N	A	N	N	N	N	N	N	N	N
SZRH	N	A	A	A	A	A	A	A	A	A
MZS	A	A	A	A	A	A	A	A	A	A
DDS	A	A	A	A	A	A	A	A	A	A
SZCI	N	A	A	A	A	A	A	A	A	A
UHT	N	A	A	N	N	N	N	N	N	N
UVT	N	A	A	N	N	N	N	N	N	N
FPH	N	A	N	N	N	N	N	N	N	N
TPFC	N	A	A	N	N	N	N	N	N	N
FPFC	N	A	A	N	N	N	N	N	N	N
TPIU	N	A	A	A	A	A	A	A	A	A
FPIU	N	A	A	A	A	A	A	A	A	A
VAVS	N	A	A	A	A	A	A	A	A	A
PIU	N	A	A	A	A	A	A	A	A	A
RHFS	N	A	A	A	A	A	A	A	A	A
HP	N	A	A	N	N	N	N	N	N	N
HVSYS	N	A	A	A	A	A	A	A	A	A
CBVAV	N	A	A	A	A	A	A	A	A	A
RESYS	N	A	A	N	N	A	A	A	N	N
PSZ	N	A	A	A	A	A	A	A	A	A
PMZS	A	A	A	A	A	A	A	A	A	A
PVAVS	N	A	A	A	A	A	A	A	A	A
PTAC	N	A	A	N	N	N	N	N	N	N
PTGSD	N	A	A	N	A	A	A	A	A	A
PVVT	N	A	A	A	A	A	A	A	A	A
RESVVT										

Legend:

- A = Appropriate
- D = Used for program code debugging only
- N = Not appropriate
- S = System (or configuration) dependent
- X = Unused

VARIABLES BY SYSTEM-TYPE FOR VARIABLE-TYPE = u-name of SYSTEM

V-L No.	41	42	43	44	45	46	47	48	49	50
SYSTEM-TYPE	TEMP OF FLUID	COOL-CTR EFFECT	QHR	QCR	HEATING GAS	HEATING ELEC	COOLING ELEC	LATENT COOLING	SPLY ELEC	RET ELEC
SUM	N	N	N	N	A	A	N	N	N	N
SZRH	N	A	A	N	A	A	A	A	A	A
MZS	N	A	N	N	A	A	A	A	A	A
DDS	N	A	N	N	A	A	A	A	A	A
SZC	N	A	A	N	A	A	A	A	A	A
UHT	N	N	N	N	A	A	N	N	N	N
UVT	N	N	N	N	A	A	N	N	N	N
FPH	N	N	N	N	N	A	N	N	N	N
TPFC	N	N	N	N	A	A	N	A	N	N
FPFC	N	N	N	N	A	A	N	A	N	N
TPIU	N	A	N	N	A	A	N	A	A	A
FPIU	N	A	N	N	A	A	N	A	A	A
VAVS	N	A	A	N	A	A	N	A	A	A
PIU	N	A	A	N	A	A	N	A	A	A
RHFS	N	A	A	N	A	A	N	A	A	A
HP	A	N	N	N	N	A	A	A	A	N
HVSYS	N	N	N	N	A	A	N	N	A	A
CBVAV	N	A	A	N	A	A	N	A	A	A
RESYS	N	N	N	N	A	A	A	A	A	N
PSZ	N	A	A	N	A	A	A	A	A	A
PMZS	N	A	A	N	A	A	A	A	A	A
PVAVS	N	A	A	N	A	A	A	A	A	A
PTAC	N	N	N	N	A	A	A	A	N	N
PTGSD	N	A	N	N	A	N	N	A	A	A
PVVT	N	A	A	A	A	A	A	A	A	A
RESVVT										

Legend:

- A = Appropriate
- D = Used for program code debugging only
- N = Not appropriate
- S = System (or configuration) dependent
- X = Unused

VARIABLES BY SYSTEM-TYPE FOR VARIABLE-TYPE = u-name of SYSTEM

V-L No.	51	52	53	54	55	56	57	58	59	60
SYSTEM-TYPE	CYCLE ON/H OFF/C	SURFACE HUMIDITY	SURFACE MIN HUM	SURFACE TEMP	SURFACE MIN TEMP	BY-PASS FACTOR	CBF F (WB, DB)	CBF F CFM	HEATING OIL	PLR CFM
SUM	A	N	N	N	N	N	N	N	X	N
SZRH	A	A	A	A	A	A	A	A	X	A
MZS	A	A	A	A	A	A	A	A	X	A
DDS	A	A	A	A	A	A	A	A	X	A
SZC	A	A	A	A	A	A	A	A	X	A
UHT	A	N	N	N	N	N	N	N	X	N
UVT	A	N	N	N	N	N	N	N	X	N
FPH	A	N	N	N	N	N	N	N	X	N
TPFC	A	N	N	N	N	N	N	N	X	N
FPFC	A	N	N	N	N	N	N	N	X	N
TPIU	A	A	A	A	A	A	A	A	X	A
FPIU	A	A	A	A	A	A	A	A	X	A
VAVS	A	A	A	A	A	A	A	A	X	A
PIU	A	A	A	A	A	A	A	A	X	A
RHFS	A	A	A	A	A	A	A	A	X	A
HP	A	N	N	N	N	N	N	N	X	N
HVSYS	A	N	N	N	N	N	N	N	X	N
CBVAV	A	A	A	A	A	A	A	A	X	A
RESYS	A	A	A	A	A	A	A	A	X	A
PSZ	A	A	A	A	A	A	A	A	X	A
PMZS	A	A	A	A	A	A	A	A	X	A
PVAVS	A	A	A	A	A	A	A	A	X	A
PTAC	A	N	N	N	N	N	N	N	X	N
PTGSD	A	N	N	N	N	N	N	N	X	A
PVVT	A	A	A	A	A	A	A	A	X	A
RESVVT										

Legend:

- A = Appropriate
- D = Used for program code debugging only
- N = Not appropriate
- S = System (or configuration) dependent
- X = Unused

VARIABLES BY SYSTEM-TYPE FOR VARIABLE-TYPE = u-name of SYSTEM

V-L No.	61	62	63	64	65	66	67	68	69	70
SYSTEM-TYPE	PLR COOL- ING	PLR HEAT- ING	COOL- CAP F (WB, DB)	COOL- SH F (WB, DB)	HEAT- CAP F (TEMP)	EIR F (WB, DB)	EIR F (PLR)	EIR	OUT- SIDE FAN KW	COOL- ING CAPA- CITY
SUM	N	N	N	N	N	N	N	N	N	N
SZRH	A	N	A	A	N	N	N	N	N	A
MZS	A	N	A	A	N	N	N	N	N	A
DDS	A	N	A	A	N	N	N	N	N	A
SZC	A	N	A	A	N	N	N	N	N	A
UHT	N	N	N	N	N	N	N	N	N	N
UVT	N	N	N	N	N	N	N	N	N	N
FPH	N	N	N	N	N	N	N	N	N	N
TPFC	N	N	N	N	N	N	N	N	N	N
FPFC	N	N	N	N	N	N	N	N	N	N
TPIU	A	N	A	A	N	N	N	N	N	A
FPIU	A	N	A	A	N	N	N	N	N	A
VAVS	A	N	A	A	N	N	N	N	N	A
PIU	A	N	A	A	N	N	N	N	N	A
RHFS	A	N	A	A	N	N	N	N	N	A
HP	N	N	N	N	N	N	N	N	N	N
HVSYS	N	N	N	N	N	N	N	N	N	A
CBVAV	A	N	A	A	N	N	N	N	N	A
RESYS	A	A	A	A	A	A	A	A	A	A
PSZ	A	A	A	A	A	A	A	A	A	A
PMZS	A	N	A	A	N	A	A	A	A	A
PVAVS	A	A	A	A	N	A	A	A	A	A
PTAC	N	N	N	N	N	N	N	N	N	A
PTGSD	N	N	N	N	N	N	N	N	N	A
PVVT	A	A	A	A	A	A	A	A	A	A
RESVVT										

Legend:

- A = Appropriate
- D = Used for program code debugging only
- N = Not appropriate
- S = System (or configuration) dependent
- X = Unused

VARIABLES BY SYSTEM-TYPE FOR VARIABLE-TYPE = u-name of SYSTEM

V-L No.	71	72	73	74	75	76	77	78	79	80
SYSTEM-TYPE	SEN-SIBLE CAPA-CITY	MAX-HUMD SET-POINT	MIN-HUMD SET-POINT	VAV MAX CFM RATE	ITEM	NOT USED	NOT USED	HEAT-ING CAPA-CITY	TEMP AT MIN OA	MIN OA EST
SUM	N	N	N	N	N	X	X	N	N	N
SZRH	A	A	A	A	N	X	X	A	A	A
MZS	A	A	A	A	S	X	X	A	A	A
DDS	A	A	A	A	S	X	X	A	A	A
SZCI	A	A	A	N	N	X	X	A	A	A
UHT	N	N	N	N	N	X	X	N	N	N
UVT	N	N	N	N	N	X	X	N	N	N
FPH	N	N	N	N	N	X	X	N	N	N
TPFC	N	N	N	N	N	X	X	N	N	N
FPFC	N	N	N	N	N	X	X	N	N	N
TPIU	A	A	A	N	N	X	X	A	A	A
FPIU	A	A	A	N	N	X	X	A	A	A
VAVS	A	A	A	A	N	X	X	A	A	A
PIU	A	A	A	A	N	X	X	A	A	A
RHFS	A	A	A	A	N	X	X	A	A	A
HP	N	N	N	N	N	X	X	N	N	N
HVSYS	A	A	A	N	N	X	X	A	A	A
CBVAV	A	A	A	N	N	X	X	A	A	A
RESYS	A	A	A	N	A	X	X	N	N	N
PSZ	A	A	A	A	N	X	X	A	A	A
PMZS	A	A	A	A	S	X	X	A	A	A
PVAVS	A	A	A	A	N	X	X	A	A	A
PTAC	A	A	A	N	N	X	X	N	N	N
PTGSD	A	A	N	N	N	X	X	N	N	A
PVVT	A	A	A	A	N	X	X	A	A	A
RESVVT										

Legend:

- A = Appropriate
- N = Not appropriate
- S = System (or configuration) dependent
- X = Unused

VARIABLES BY SYSTEM-TYPE FOR VARIABLE-TYPE = u-name of SYSTEM

V-L No.	81	82	83	84	85	86	87	88
SYSTEM- TYPE-	HP SUPP HEAT	REFG ZONE SENS HT	REFG ZONE LAT HT	REFG SYS REC HT	REFG SYS REJ HT	REFG SYS COMP KW	REFG SYS DEF KW	REFG SYS AUX KW
SUM	N	N	N	N	N	N	N	N
SZRH	N	N	N	N	N	N	N	N
MZS	N	N	N	N	N	N	N	N
DDS	N	N	N	N	N	N	N	N
SZC	N	N	N	N	N	N	N	N
UHT	N	N	N	N	N	N	N	N
UVT	N	N	N	N	N	N	N	N
FPH	N	N	N	N	N	N	N	N
TPFC	N	N	N	N	N	N	N	N
FPFC	N	N	N	N	N	N	N	N
TPIU	N	N	N	N	N	N	N	N
FPIU	N	N	N	N	N	N	N	N
VAVS	N	N	N	N	N	N	N	N
PIU	N	N	N	N	N	N	N	N
RHFS	N	N	N	N	N	N	N	N
HP	N	N	N	N	N	N	N	N
HVSY	N	N	N	N	N	N	N	N
CBVAV	N	N	N	N	N	N	N	N
RESYS	A	N	N	N	N	N	N	N
PSZ	A	A	A	A	A	A	A	A
PMZS	N	N	N	N	N	N	N	N
PVAVS	A	N	N	N	N	N	N	N
PTAC	A	N	N	N	N	N	N	N
PTGSD	N	N	N	N	N	N	N	N
PVVT	A	N	N	N	N	N	N	N
RESVVT								

Legend:

- A = Appropriate
- D = Used for program code debugging only
- N = Not appropriate
- S = System (or configuration) dependent
- X = Unused

VARIABLES BY SYSTEM-TYPE FOR VARIABLE-TYPE = u-name of SYSTEM

V-L No.	89	90	91	92	93	94
SYSTEM-TYPE-	PLEN EXH FLOW RATE	COOL GAS	REGEN POWER	RETURN WB TEMP	WB8	T8
SUM	N	N	N	N	N	N
SZRH	A	N	N	N	N	N
MZS	A	N	N	N	N	N
DDS	A	N	N	N	N	N
SZC	A	N	N	N	N	N
UHT	N	N	N	N	N	N
UVT	N	N	N	N	N	N
FPH	N	N	N	N	N	N
TPFC	N	N	N	N	N	N
FPFC	N	N	N	N	N	N
TPIU	A	N	N	N	N	N
FPIU	A	N	N	N	N	N
VAVS	A	N	N	N	N	N
PIU	A	N	N	N	N	N
RHFS	A	N	N	N	N	N
HP	N	N	N	N	N	N
HVSYS	A	N	N	N	N	N
CBVAV	A	N	N	N	N	N
RESYS	N	N	N	N	N	N
PSZ	A	N	N	N	N	N
PMZS	A	N	N	N	N	N
PVAVS	A	N	N	N	N	N
PTAC	N	N	N	N	N	N
PTGSD	A	N	A	A	A	A
PVVT	A	N	N	N	N	N
RESVVT						

Legend:

- A = Appropriate
- D = Used for program code debugging only
- N = Not appropriate
- S = System (or configuration) dependent
- X = Unused

VARIABLES BY SYSTEM-TYPE FOR VARIABLE-TYPE = u-name of SYSTEM

V-L No.	95	96	97	98	99	100	101	102	103
SYSTEM-TYPE	W8	WB9	T9	W9	EFF	DTON	MODE1	MODE2	MODE3
SUM	N	N	N	N	N	N	N	N	N
SZRH	N	N	N	N	N	N	N	N	N
MZS	N	N	N	N	N	N	N	N	N
DDS	N	N	N	N	N	N	N	N	N
SZC	N	N	N	N	N	N	N	N	N
UHT	N	N	N	N	N	N	N	N	N
UVT	N	N	N	N	N	N	N	N	N
FPH	N	N	N	N	N	N	N	N	N
TPFC	N	N	N	N	N	N	N	N	N
FPFC	N	N	N	N	N	N	N	N	N
TPIU	N	N	N	N	N	N	N	N	N
FPIU	N	N	N	N	N	N	N	N	N
VAVS	N	N	N	N	N	N	N	N	N
PIU	N	N	N	N	N	N	N	N	N
RHFS	N	N	N	N	N	N	N	N	N
HP	N	N	N	N	N	N	N	N	N
HVSYs	N	N	N	N	N	N	N	N	N
CBVAV	N	N	N	N	N	N	N	N	N
RESYS	N	N	N	N	N	N	N	N	N
PSZ	N	N	N	N	N	N	N	N	N
PMZS	N	N	N	N	N	N	N	N	N
PVAVS	N	N	N	N	N	N	N	N	N
PTAC	N	N	N	N	N	N	N	N	N
PTGSD	A	A	A	A	A	A	A	A	A
PVVT	N	N	N	N	N	N	N	N	N
RESVVT									

Legend:

- A = Appropriate
- D = Used for program code debugging only
- N = Not appropriate
- S = System (or configuration) dependent
- X = Unused



VARIABLES BY SYSTEM-TYPE FOR VARIABLE-TYPE = u-name of SYSTEM

V-L No.	104	105	106	107	108	109	110	111
SYSTEM-TYPE	MODE4	MODE5	MODE6	MODE7	ERMAX4	ERMAX5	ERMAX6	MODE4
SUM	N	N	N	N	N	N	N	N
SZRH	N	N	N	N	N	N	N	N
MZS	N	N	N	N	N	N	N	N
DDS	N	N	N	N	N	N	N	N
SZC	N	N	N	N	N	N	N	N
UHT	N	N	N	N	N	N	N	N
UVT	N	N	N	N	N	N	N	N
FPH	N	N	N	N	N	N	N	N
TPFC	N	N	N	N	N	N	N	N
FPFC	N	N	N	N	N	N	N	N
TPIU	N	N	N	N	N	N	N	N
FPIU	N	N	N	N	N	N	N	N
VAVS	N	N	N	N	N	N	N	N
PIU	N	N	N	N	N	N	N	N
RHFS	N	N	N	N	N	N	N	N
HP	N	N	N	N	N	N	N	N
HVSYS	N	N	N	N	N	N	N	N
CBVAV	N	N	N	N	N	N	N	N
RESYS	N	N	N	N	N	N	N	N
PSZ	N	N	N	N	N	N	N	N
PMZS	N	N	N	N	N	N	N	N
PVAVS	N	N	N	N	N	N	N	N
PTAC	N	N	N	N	N	N	N	N
PTGSD	A	A	A	A	A	A	A	A
PVVT	N	N	N	N	N	N	N	N
RESVVT								

Legend:

- A = Appropriate
- D = Used for program code debugging only
- N = Not appropriate
- S = System (or configuration) dependent
- X = Unused

## SYSTEMS

VARIABLE-TYPE = u-name of PLANT-ASSIGNMENT

Variable- List Number	Variable in FORTRAN Code	Description
1	<QCPL>	Total cooling load (Btu/hr)
2	<QHPL>	Total heating load (Btu/hr)
3	<PKW>	Total electrical load (kW)
4	<PGAS>	Total gas load (Btu/hr)
5	<PKWQH>	Portion of <PKW> used for heating (kW)
6	<PKWQC>	Portion of <PKW> used for cooling (kW)
7	<PFANKW>	Portion of <PKW> used for fans (kW)
8	<POIL>	Total oil load (Btu/hr)
9-10	-	unused
11	QHMP	Main coil heating load (Btu/hr)
12	TMP	Main coil average entering temperature (°F)
13	CFMP	Main coil flowrate (cfm)
14	QHPP	Preheat coil heating load (Btu/hr)
15	CFMPP	Preheat coil flowrate (if in outside air duct) (cfm)
16	QHZP	Zone coil load (Btu/hr)
17	TZP	Zone coil average entering temperature (°F). Loop temperature for HP or zone temperature for RESYS.
18	CFMZP	Zone coil flowrate (cfm)
19	QHBP	Baseboard load (Btu/hr); includes HP load for loop.
20	-	unused
21	QRECP	Desiccant unit regeneration energy (Btu/hr).
22	TCONDP	Desiccant unit condenser temperature (°F).

## SYSTEMS

VARIABLE-TYPE = u-name of PLANT-ASSIGNMENT (continued)

Variable- List Number	Variable in FORTRAN Code	Description
<hr/>		
Items 23-39 are water loop variables for SYSTEM-TYPE=HP		
23	GMPM	Total loop flow (gal/min)
24	GPMHP	Total loop flow for heating (gal/min)
25	GPMCP	Total loop flow for cooling (gal/min)
<hr/>		
26	PLRP	Pump part load (flow) ratio
27	PLRPP	Pump part load (power) ratio
28	PUMPKW	Pump electric (kW)
29	PMPKWH	Pump electric for heating (kW)
30	PMPKWC	Pump electric for cooling (kW)
<hr/>		
31	PHGAIN	Pump heat gain (Btu/hr)
32	QHLUPP	Total loop heat taken by units (Btu/hr)
33	QCLUPP	Total loop heat added by units (Btu/hr)
34-35	-	Unused
<hr/>		
36	FTEMP	Loop temperature entering units (°F).
37	PON	Pump on flag (0=off/1=on)
38	ETEMP	Loop return temperature from units (°F).
39	PONCYC	Pump cycle on flag (0=no/1=yes)
40-42	-	Unused
<hr/>		
Items 43-59 are boiler variables for SYSTEM-TYPE=HP		
43	BCAP	Boiler operating capacity (Btu/hr)
44	BLOAD	Load on boiler (Btu/hr)
45	BFUEL	Fuel used by boiler (Btu/hr)
<hr/>		
46	BELEC	Electric used by boiler (kW)
47	BAUXE	Auxiliary electric used by boiler (kW)
48	BPLR	Boiler part load ratio
49	BFRAC	Fraction of hour boiler operates
50	BHIRC	Heat input ratio PLR correction
<hr/>		

## SYSTEMS

VARIABLE-TYPE = u-name of PLANT-ASSIGNMENT (continued)

Variable-List Number	Variable in FORTRAN Code	Description
51	BLOSS	Boiler losses (Btu/hr)
52	BCAPMX	Boiler maximum capacity (Btu/hr)
53	BCAPMN	Boiler minimum capacity (Btu/hr)
54	BLRT	Boiler supply temp setpoint (°F)
55	TBLR	Estimated boiler supply temp (°F)
56	BLRON	Boiler on flag (0=off/1=on)
57	BLRGAS	Boiler fuel use (Btu/hr)
58	-	Unused
59	BEXTRA	Load to heat loop to boiler supply temperature
60-62	-	Unused
Items 63-90 are cooling tower variables for SYSTEM-TYPE=HP		
63	TLOAD	Net heat gain (loss) to the loop (Btu)
64	TCAP	Maximum tower capacity at current conditions (Btu/hr)
65	TWRREJ	Heat actually rejected by tower (Btu)
66	TELEC	Total tower electrical use (kW)
67	TGPM	Fluid flow rate to tower (gal/min)
68	TTOWR	Fluid temperature leaving tower (°F)
69	TSET	Fluid temperature setpoint (°F)
70	TTOWER	Fluid temperature setpoint, adjusted for throttling range (°F)
71	RANGE	Temperature drop through tower (°F)
72	APP	Fluid approach to wetbulb temperature (°F)
73	FRA	Variable common between range/approach performance curve and wetbulb/gpm curve
74	GPMRAT	Ratio of actual flow at current conditions to flow at 95-85-78 CTI rating conditions
75	GPMCAP	flow capacity per cell at current load, setpoint, and wetbulb (units/gal/min)
76	GPMCEL	The actual flowrate per cell (units/gal/min)
77	NCELL	Number of cells running
78	MINCEL	Minimum number of cells that can handle load

## SYSTEMS

VARIABLE--TYPE = u-name of PLANT--ASSIGNMENT (continued)

Variable- List Number	Variable in FORTRAN Code	Description
79	MAXCEL	Maximum number of cells that can handle load
80	TTOP	Temperature at top of throttling range (°F)
81	GPMTOP	flow capacity at top of throttling range (units/gal/min)
82	TBOT	Temperature at bottom of throttling range (°F)
83	GPMBOT	flow capacity at bottom of throttling range (units/gal/min)
84	AIRCEL	Fraction of design airflow need to handle load
85	EFRAC	Fraction of design fan energy at current airflow
86	TFRAC	Fraction of hour the tower not floating
87	EFAN	Tower fan energy (kW)
88	EPUMP	Tower pump energy (kW)
89	TWRON	Schedule flag
90	MODETP	Tower pump mode
91-95	-	Unused
Items 96-100 give building resource energy use as determined by the indicated keywords of the PLANT--ASSIGNMENT command		
96	(BRGAS)	Resource fuel consumption (Btu/hr) [based on the INT--FUEL-- and EXT--FUEL-- keywords]
97	(BRKW)	Resource electrical consumption (kWh) [based on the INT--ELEC--, EXT--ELEC--, and EXT--LIGHT-- keywords]
98	(BRDHW)	Resource domestic (service) hot water (Btu/hr) [based on the DHW-- keywords]
99	(BRHW)	Resource process hot water (Btu/hr) [based on the PROCESS--HW-- keywords]
100	(BRCHW)	Resource process chilled water (Btu/hr) [based on the PROCESS--CHW-- keywords]

## SYSTEMS

VARIABLE-TYPE = u-name of PLANT-ASSIGNMENT (continued)

Variable- List Number	Variable in FORTRAN Code	Description
<hr/>		
Items 101-120 are for gas heat pumps or variable speed electric heat pumps		
→ Cooling Mode:		
101	QCRUN	Total run time of all compressors (hr)
102	QCLOAD	Output of all units (Btu/hr)
103	QCGAS	Gas consumed by all units (Btu/hr)
104	QCAUX	Fans/Pumps/Auxiliary energy (kW)
105	QCGLSD	Unmet cooling loads (Btu/hr)
<hr/>		
106	QCGSUP	Unused
107	QCWAS	Waste heat generated (Btu/hr)
108	QCWASU	Waste heat used (Btu/hr)
109	QCGSAV1	Unused
110	QCGFAN	Total indoor fan energy (Btu/hr)
<hr/>		
→ Heating Mode:		
111	QHRUN	Total run time of all compressors (hr)
112	QHLOAD	Output of all units (Btu/hr)
113	QH GAS	Gas consumed by all units (Btu/hr)
114	QHAUX	Fans/Pumps/Auxiliary energy (kW)
115	QH GSLD	Load on all supp heat units (Btu/hr)
<hr/>		
116	QHGSUP	Energy input to all supplementary heating units (Btu/hr)
117	QHWAS	Waste heat generated (Btu/hr)
118	QHWASU	Waste heat used (Btu/hr)
119	QH GDFR	Total defrost imposed heat load (Btu/hr)
120	QHGFAN	Total indoor fan energy (Btu/hr)

The following hourly report variables can be printed at the PLANT-ASSIGNMENT level for the domestic hot water heater and tank in SYSTEMS.

### SYSTEMS

VARIABLE-TYPE = u-name of PLANT-ASSIGNMENT (continued)

Variable-List Number	Variable in FORTRAN Code	Description
121	HTTHOT	Tank temperature (°F)
122	EHSTOR	Energy stored in tank (Btu)
123	HTGIVE	Energy available from tank this hour (Btu)
124	HTASK	Energy tank can accept this hour (Btu)
125	HTFILL	Energy needed to fill tank this hour (Btu)
126	HSUPRT	Maximum rate at which energy can be supplied by the tank this hour (Btu/hr)
127	HSTRRT	Maximum rate at which energy can be stored in the tank this hour (Btu/hr)
128	DHWWST	Waste heat available for meeting the domestic hot water load or filling the tank this hour (Btu)
129	DHWWSU	Waste heat used for meeting the domestic hot water load or filling the tank this hour (Btu)
130	HTTIN	Temperature of inlet water to tank (°F)
131	DHWLD	Domestic hot water load this hour (Btu)
132	DHWLDR	Domestic hot water load not satisfied this hour (Btu). If nonzero this remaining load will be passed to PLANT
133	DHWPLR	Part load ratio of the burner or heater (fraction)
134	DHWHRT	Capacity of the burner, heater, or dhw heat-pump this hour (Btu/hr)
135	DHHRFT	Outside temperature dependence of the dhw heat pump capacity this hour (fraction)
136	DHERFT	Outside temperature dependence of the dhw heat pump energy input ratio this hour (fraction)
137	DHERFP	Part load ratio dependence of the energy input ratio for heat pump supplied and gas/fuel fired dhw units (fraction)
138	HTCAP	Energy storage capacity of the tank relative to the inlet temperature (Btu)
139	HTLOSS	Energy lost by the tank this hour (Btu)
140	DHWEIR	Energy input ratio for the dhw unit this hour (Btu/Btu)

VARIABLES BY SYSTEM-TYPE FOR VARIABLE-TYPE = u-name of PLANT-ASSIGNMENT

V-L No.	1	2	3	4	5	6	7	8	9	10
SYSTEM-TYPE	COOL- ING LOAD	HEAT- ING LOAD	ELEC KW LOAD	HEAT- ING GAS	HEAT- ING ELEC KW	COOL- ING ELEC KW	FANS ELEC KW	HEAT- ING OIL	UN- USED	UN- USED
SUM	A	A	A	A	A	N	N	X	X	X
SZRH	A	A	A	A	A	N	A	X	X	X
MZS	A	A	A	A	A	N	A	X	X	X
DDS	A	A	A	A	A	N	A	X	X	X
SZC	A	A	A	A	A	N	A	X	X	X
UHT	A	A	A	A	A	N	A	X	X	X
UVT	A	A	A	A	A	N	A	X	X	X
FPH	A	A	A	A	A	N	A	X	X	X
TPFC	A	A	A	A	A	N	A	X	X	X
FPFC	A	A	A	A	A	N	A	X	X	X
TPIU	A	A	A	A	A	N	A	X	X	X
FPIU	A	A	A	A	A	N	A	X	X	X
VAVS	A	A	A	A	A	N	A	X	X	X
PIU	A	A	A	A	A	N	A	X	X	X
RHFS	A	A	A	A	A	N	A	X	X	X
HP	A	A	A	A	A	A	A	X	X	X
HVSYS	A	A	A	A	A	N	A	X	X	X
CBVAV	A	A	A	A	A	N	A	X	X	X
RESYS	A	A	A	A	A	A	A	X	X	X
PSZ	A	A	A	A	A	A	A	X	X	X
PMZS	A	A	A	A	A	A	A	X	X	X
PVAVS	A	A	A	A	A	A	A	X	X	X
PTAC	A	A	A	A	A	A	A	X	X	X
PVVT	A	A	A	A	A	A	A	X	X	X
RESVVT	A	A	A	A	A	A	A	X	X	X

Legend:

- A = Appropriate
- D = Used for program code debugging only
- N = Not appropriate
- S = System (or configuration) dependent
- X = Unused



VARIABLES BY SYSTEM-TYPE FOR VARIABLE-TYPE = u-name of PLANT-ASSIGNMENT

V-L No.	11	12	13	14	15	16	17	18	19
SYSTEM-TYPE	MAIN HC CBS LOAD	MAIN HC CBS TEMP	MAIN HC CBS CFM	PRE-HEAT CBS LOAD	PRE-HEAT CBS CFM	ZONE HEAT CBS LOAD	ZONE HEAT CBS TEMP	ZONE HEAT CBS CFM	BASE-BOARD CBS LOAD
SUM	X	X	X	X	X	X	X	X	X
SZRH	X	X	X	X	X	X	X	X	X
MZS	X	X	X	X	X	X	X	X	X
DDS	X	X	X	X	X	X	X	X	X
SZC	X	X	X	X	X	X	X	X	X
UHT	X	X	X	X	X	X	X	X	X
UVT	X	X	X	X	X	X	X	X	X
FPH	X	X	X	X	X	X	X	X	X
TPFC	X	X	X	X	X	X	X	X	X
FPFC	X	X	X	X	X	X	X	X	X
TPIU	X	X	X	X	X	X	X	X	X
FPIU	X	X	X	X	X	X	X	X	X
VAVS	X	X	X	X	X	X	X	X	X
PIU	X	X	X	X	X	X	X	X	X
RHFS	X	X	X	X	X	X	X	X	X
HP	X	X	X	X	X	X	X	X	X
HVSYS	X	X	X	X	X	X	X	X	X
CBVAV	X	X	X	X	X	X	X	X	X
RESYS	X	X	X	X	X	X	X	X	X
PSZ	X	X	X	X	X	X	X	X	X
PMZS	X	X	X	X	X	X	X	X	X
PVAVS	X	X	X	X	X	X	X	X	X
PTAC	X	X	X	X	X	X	X	X	X
PVVT	X	X	X	X	X	X	X	X	X
RESVVT									

Legend:

- A = Appropriate
- D = Used for program code debugging only
- N = Not appropriate
- S = System (or configuration) dependent
- X = Unused

## SYSTEMS

### VARIABLE-TYPE = END-USE

A default has been provided for the specification of the VARIABLE-LIST items. If VARIABLE-LIST=(99) the list defaults to: 5, 6, 9, 8, 1, 2, 20, 12, 10, 3, 21, 15, 16, 18, 14, 22. In SYSTEMS, there may be up to four PLANT-ASSIGNMENTS to which these end-uses and meters apply. Note, however, that there is no mechanism within the REPORT-BLOCK command to specify to which PLANT-ASSIGNMENT these variables apply. Accordingly, these variables are repeated in the following sets:

PLANT-ASSIGNMENT #1: 1-32  
 PLANT-ASSIGNMENT #2: 33-64  
 PLANT-ASSIGNMENT #3: 65-96  
 PLANT-ASSIGNMENT #4: 97-128

For example, the variable for task lighting in the third PLANT-ASSIGNMENT is 66. These multiple sets apply to the SYSTEMS module only. The following end-use variables can also be printed in PLANT. See "Energy End-Uses and Meters", p.3.4 for a more complete description of these variables.

Variable-List Number	Variable in FORTRAN Code	Description
1	LITEKW	Area Lighting Electric (kW)
2	TASKKW	Task Lighting Electric (kW)
3	EQKW	Equipment Electric (kW)
4	SRCKWS	Source Electric (kW)
5	HEATKW	Heating Electric (kW)
6	COOLKW	Cooling Electric (kW)
7	HTRJKW	Heat Rejection Electric (kW)
8	AUXKW	Auxiliary Electric (pumps) (kW)
9	VENTKW	Ventilation Electric (kW)
10	REFGKW	Refrigeration Electric (kW)
11	SUPPKW	HP Supplementary Heating Electric (kW)
12	DHWKW	DHW Electric (kW)
13	ADD1E	Unused
14	SRCFL	Source Fuel (Btu/hr)
15	HEATFL	Heating Fuel (Btu/hr)
16	COOLFL	Cooling Fuel (Btu/hr)
17	SUPPFL	HP Supplementary Heating Fuel (Btu/hr)

## SYSTEMS

VARIABLE-TYPE = END-USE (continued)

Variable- List Number	Variable in FORTRAN Code	Description
18	DHWFL	DHW Fuel (Btu/hr)
19	ADD1FL	Unused
20	EXLTKW	Exterior Lighting Electric (kW)
21	EXMCKW	Exterior Miscellaneous Electric (kW)
22	EXFL	Exterior Miscellaneous Fuel (Btu/hr)
23	ELMTR	Electric Meter #1 (kW)
24		Electric Meter #2 (kW)
25		Electric Meter #3 (kW)
26		Electric Meter #4 (kW)
27		Electric Meter #5 (kW)
28	FLMTR	Fuel Meter #1 (Btu/hr)
29		Fuel Meter #2 (Btu/hr)
30		Fuel Meter #3 (Btu/hr)
31		Fuel Meter #4 (Btu/hr)
32		Fuel Meter #5 (Btu/hr)

PLANT

VARIABLE-TYPE = GLOBAL

Variable- List Number	Variable in FORTRAN Code	Description
1	TAIR	Outside dry bulb temperature (°F)
2	TWET	Outside wet bulb temperature (°F)

## PLANT

### VARIABLE-TYPE = PLANT

Variable- List Number	Variable in FORTRAN Code	Description
1	ENGYLD(1,IHR)	Heating load from SYSTEMS (Btu/hr)
2	ENGYLD(2,IHR)	Cooling load from SYSTEMS (Btu/hr)
3	ENGYLD(3,IHR)	Electric load from SYSTEMS (Btu/hr)
4	IHON	Standby heating flag
5	ICON	Standby cooling flag
6	ENGYLD(17,IHR)	Regeneration load passed to PLANT from SYSTEMS (Btu/hr)
7	—	—
8	PDEM(1)	Total heating load to be met by PLANT (Btu/hr)
9	PDEM(2)	Total cooling load to be met by PLANT (Btu/hr)
10	PDEM(3)	Total electric load to be met by PLANT (Btu/hr)
11	—	—
12	Note 1	Total PLANT fuel use (Btu/hr). Variable 12 now includes engine chiller and gas absorption chiller fuel use.
13	—	Unused
14	LATYPE(1)	Heating LOAD-ASSIGNMENT pointer
15	LATYPE(2)	Cooling LOAD-ASSIGNMENT pointer
16	LATYPE(3)	Electric LOAD-ASSIGNMENT pointer
17	GAS+OIL	Gas and oil resource consumed elsewhere than PLANT (Btu/hr)
18	HWTR(1HR)	Hot water resource consumed elsewhere than PLANT (Btu/hr)
19	HPELEC(1HR)	Hot water loop pump electricity consumption (Btu/hr)
20	HHGAIN	Hot water loop pump heat gain (Btu/hr)
21	CPELEC	Cold water loop pump electric consumption (Btu/hr)
22	CHGAIN	Cold water loop pump heat gain (Btu/hr)

Note 1.  $EQDEM(4,1) + EQDEM(4,2) + EQDEM(4,5) +$   
 $EQDEM(4,6) + EQDEM(4,22) + EQDEM(4,21)$

## PLANT

### VARIABLE-TYPE = END-USE

A default has been provided for the specification of the VARIABLE-LIST items. If VARIABLE-LIST=(99) the list defaults to: 5, 6, 9, 8, 1, 2, 20, 12, 10, 3, 21, 15, 16, 18, 14, 22. The following end-use variables can also be printed in SYSTEMS. See "Energy End-Uses and Meters", p.3.4 for a more complete description of these variables.

Variable- List Number	Variable in FORTRAN Code	Description
1	LITEKW	Area Lighting Electric (kW)
2	TASKKW	Task Lighting Electric (kW)
3	EQKW	Equipment Electric (kW)
4	SRCKWS	Source Electric (kW)
5	HEATKW	Heating Electric (kW)
6	COOLKW	Cooling Electric (kW)
7	HTRJKW	Heat Reject Electric (kW)
8	AUXKW	Auxiliary Electric (pumps) (kW)
9	VENTKW	Ventilation Electric (kW)
10	REFGKW	Refrigeration Electric (kW)
11	SUPPKW	HP Supplementary Heating Electric (kW)
12	DHWKW	DHW Electric (kW)
13	ADD1E	Unused
14	SRCFL	Source Fuel (Btu/hr)
15	HEATFL	Heating Fuel (Btu/hr)
16	COOLFL	Cooling Fuel (Btu/hr)
17	SUPPFL	HP Supplementary Heating Fuel (Btu/hr)
18	DHWFL	DHW Fuel
19	ADD1FL	Unused
20	EXLTKW	Exterior Lighting Electric (kW)
21	EXMCKW	Exterior Miscellaneous Electric (kW)
22	EXFL	Exterior Miscellaneous Fuel (Btu/hr)
23	ELMTR	Electric Meter #1 (kW)
24		Electric Meter #2 (kW)
25		Electric Meter #3 (kW)

PLANT

VARIABLE-TYPE = END-USE (continued)

Variable- List Number	Variable in FORTRAN Code	Description
26		Electric Meter #4 (kW)
27		Electric Meter #5 (kW)
28	FLMTR	Fuel Meter #1 (units as defined in ENERGY-RESOURCE command)
29		Fuel Meter #2 (units as defined in ENERGY-RESOURCE command)
30		Fuel Meter #3 (units as defined in ENERGY-RESOURCE command)
31		Fuel Meter #4 (units as defined in ENERGY-RESOURCE command)
32		Fuel Meter #5 (units as defined in ENERGY-RESOURCE command)
33	SUTLTY	Purchased steam meter (units as defined in ENERGY-RESOURCE command)
34	CUTLTY	Purchased chilled water meter (units as defined in ENERGY-RESOURCE command)
35	EGEN	Cogeneration meter

PLANT

VARIABLE-TYPE = HEAT-RECOVERY

Variable-List Number	Variable in FORTRAN Code	Description
1	Note 1	Demand at level 1 (Btu/hr)
2	Note 2	Demand at level 2 (Btu/hr)
3	Note 3	Demand at level 3 (Btu/hr)
4	Note 4	Demand at level 4 (Btu/hr)
5	Note 5	Demand at level 5 (Btu/hr)
6	EHEAT	Heating load to be addressed by HEAT-RECOVERY
7	EBOILR	Heating load after heat recovery contribution, but before the contribution of hot water storage tank (Btu/hr)
8	ERECVR	Total recovered energy from all levels (Btu/hr)
9	EREJ	Total recoverable energy wasted (Btu/hr)
10	DBLEFT	Wasted recoverable double-bundle chiller heat (reject to tower) (Btu/hr)
11	STORED	Recovered energy stored in hot water storage tank this hour (Btu/hr)
12	HTREQD(19)	Energy demanded from boiler by hot water storage tank (Btu/hr)
13	-	Unused
14	-	Unused
15	-	Unused
16	-	Unused

Note 1.  $HTREQD(KEY(1,2,1)) + HTREQD(KEY(2,2,1)) + HTREQD(KEY(3,2,1))$

Note 2.  $HTREQD(KEY(1,2,2)) + HTREQD(KEY(2,2,2)) + HTREQD(KEY(3,2,2))$

Note 3.  $HTREQD(KEY(1,2,3)) + HTREQD(KEY(2,2,3)) + HTREQD(KEY(3,2,3))$

Note 4.  $HTREQD(KEY(1,2,4)) + HTREQD(KEY(2,2,4)) + HTREQD(KEY(3,2,4))$

Note 5.  $HTREQD(KEY(1,2,5)) + HTREQD(KEY(2,2,5)) + HTREQD(KEY(3,2,5))$



## PLANT

VARIABLE-TYPE = STM-BOILER (EQTYP = 1)

or HW-BOILER (EQTYP = 2)

Variable-List Number	Variable in FORTRAN Code	Description
1	EQDEM(1,IEQTYP)	Heating load (Btu/hr)
2	—	—
3	EQDEM(3,IEQTYP)	Electric input (Btu/hr)
4	EQDEM(4,IEQTYP)	Fuel input (Btu/hr)
5	—	—
6	ISIZE	Sizes running
7	OPCAP(IEQTYP)	Nominal capacity (Btu/hr)
8	PLR	Average part-load ratio
9	FRAC	Fraction of hour boiler was on
10	HIRCOR	Fuel consumption correction factor

PLANT

VARIABLE-TYPE = ELEC-STM-BOILER (IEQTYP = 3),

ELEC-HW-BOILER (IEQTYP = 4),

or ELEC-DHW-HEATER (IEQTYP = 7)

Variable- List Number	Variable in FORTRAN Code	Description
1	EQDEM(1,IEQTYP)	Heating load (Btu/hr)
2	—	—
3	EQDEM(3,IEQTYP)	Electric energy consumption (Btu/hr)
4	—	—
5	—	—
6	ISIZE	Sizes running
7	OPCAP(IEQTYP)	Nominal capacity (Btu/hr)
8	LOSS	Losses from machine (Btu/hr)

PLANT

VARIABLE-TYPE = ABSOR1-CHLR (IEQTYP = 13)

or ABSOR2-CHLR (IEQTYP = 14)

Variable-List Number	Variable in FORTRAN Code	Description
1	EQDEM(1,IEQTYP)	Cooling load (Btu/hr)
2	—	—
3	EQDEM(3,IEQTYP)	Electric energy consumed (Btu/hr)
4	EQDEM(4,IEQTYP)	Steam energy input (Btu/hr)
5	EQDEM(5,IEQTYP)	Cooling tower load (Btu/hr)
6	ISIZE	Sizes running
7	OPCAP(IEQTYP)	Nominal capacity (Btu/hr)
8	RCAP	Available capacity ratio (Btu/Btu)
9	CAP	Available capacity (Btu/hr)
10	PL	Average part-load ratio
11	PLR	Operating part-load ratio
12	TTOWR	Entering condenser temperature (°F)
13	CHWT	Leaving chilled water temperature (°F)
14	HIR1	Heat input ratio temperature correction
15	HIR2	Heat input ratio part-load correction
16	HIR	Adjusted heat input ratio
17	—	Unused

## PLANT

VARIABLE-TYPE = OPEN-CENT-CHLR (IEQTYP = 8),

OPEN-REC-CHLR (IEQTYP = 9),

HERM-CENT-CHLR (IEQTYP = 10),

HERM-REC-CHLR (IEQTYP = 11)

Variable- List Number	Variable in FORTRAN Code	Description
1	EQDEM(1,IEQTYP)	Cooling load (Btu/hr)
2	EQDEM(2,IEQTYP)	False load (Btu/hr)
3	EQDEM(3,IEQTYP)	Electric energy consumed (Btu/hr)
4	—	—
5	EQDEM(5,IEQTYP)	Cooling tower load (Btu/hr)
6	ISIZE	Sizes running
7	OPCAP(IEQTYP)	Nominal capacity (Btu/hr)
8	RCAP	Available capacity ratio
9	CAP	Available capacity (Btu/hr)
10	PLR	Operating part-load ratio
11	FRAC	Fraction of hour machine ran
12	ECT	Entering condenser temperature (°F)
13	CHWT	Leaving chilled water temperature (°F)
14	EIR1	Electric input ratio temperature correction
15	EIR2	Electric input ratio part-load correction
16	EIRN	Adjusted electric input ratio
17	ELECH	Rejected electrical heat (Btu/hr)
18	FANE	Condenser fan energy (Btu/hr)

## PLANT

VARIABLE-TYPE = ABSORG-CHLR (IEQTYP = 15)

Variable-List Number	Variable in FORTRAN Code	Description
1	EQDEM(1,IEQTYP)	Cooling load (Btu/hr)
2	—	—
3	EQDEM(3,IEQTYP)	Electric energy consumed(Btu/hr)
4	EQDEM(4,IEQTYP)	Fuel input (cooling) (Btu/hr)
5	EQDEM(5,IEQTYP)	Cooling tower load (Btu/hr)
6	ISIZE	Sizes running
7	OPCAP(IEQTYP)	Nominal capacity (Btu/hr)
8	RCAPI	Available capacity ratio (cooling) (Btu/Btu)
9	CAP	Available capacity (cooling) (Btu/hr)
10	PL	Average part-load ratio (cooling)
11	PLR	Operating part-load ratio (cooling)
12	TC	Entering condenser temperature (°F)
13	CHWT	Leaving chilled water temperature (°F)
14	HIR1	Heat input ratio chilled water correction
15	HIR2	Heat input ratio part-load correction
16	HIR3	Heat input ratio condenser temperature correction
17	HIR	Heat input ratio
18	HEAT	Heat input (cooling) (Btu/hr)
19	QCOND	Desiccant regeneration heat from condenser (Btu/hr)
20	QSUPL	Supplemental desiccant regeneration heat (Btu/hr)
21	QREG	Desiccant regeneration load (Btu/hr)
22	GABQC	Cooling Output (Btu/hr)
23	GABQH	Heating Output (Btu/hr)
24	GABFC	Fuel use (cooling); includes fuel used for regeneration
25	GABFH	Fuel use (heating) (Btu/hr)

## PLANT

VARIABLE-TYPE = ABSORG-CHLR (IEQTYP = 15) (continued)

Variable- List Number	Variable in FORTRAN Code	Description
26	GABQSH	Heat output for space heating (Btu/hr)
27	GABQDH	Heat output for domestic hot water (Btu/hr)
28	GABFSH	Fuel used for space heating (Btu/hr)
29	GABFDH	Fuel used for domestic hot water (Btu/hr)
30	CAPH	Heating capacity (Btu/hr)
31	LOADH	Heating load (Btu/hr)

PLANT

VARIABLE-TYPE = ENG-CHLR (IEQTYP = 16)

Variable-List Number	Variable in FORTRAN Code	Description
1	EQDEM(1,IEQTYP)	Cooling load (Btu/hr)
2	—	—
3	EQDEM(3,IEQTYP)	Electric energy consumed (Btu/hr)
4	EQDEM(4,IEQTYP)	Fuel input (Btu/hr)
5	EQDEM(5,IEQTYP)	Cooling tower load (Btu/hr)
6	ISIZE	Sizes running
7	OPCAP(IEQTYP)	Nominal capacity (Btu/hr)
8	RCAPI	Available capacity ratio
9	OPCAP*RCAPI	Available capacity (Btu/hr)
10	PLR	Operating part-load ratio
11	FRAC	Fraction of hour chiller ran
12	ECT	Entering condenser temperature (°F)
13	CHWT	Leaving chilled water temperature (°F)
14	COP1	COP temperature correction
15	COP2	COP part-load correction
16	COP	COP
17	ECFUEL	Fuel used (Btu/hr)
18	HREJ1	Recoverable heat efficiency temperature correction (Btu/hr)
19	HREJ2	Recoverable heat efficiency part load correction (Btu/hr)
20	HREJ	Recoverable heat (Btu/hr)

## PLANT

VARIABLE-TYPE = DBUN-CHLR (IEQTYP = 12)

Variable- List Number	Variable in FORTRAN Code	Description
1	EQDEM(1,IEQTYP)	Cooling load (Btu/hr)
2	EQDEM(2,IEQTYP)	False load (Btu/hr)
3	EQDEM(3,IEQTYP)	Electric energy consumption (Btu/hr)
4	—	—
5	EQDEM(5,IEQTYP)	Cooling tower load (Btu/hr)
6	ISIZE	Sizes running
7	OPCAP(IEQTYP)	Nominal capacity (Btu/hr)
8	RCAP	Available capacity ratio
9	CAP	Available capacity (Btu/hr)
10	PLR	Operating part-load ratio
11	FRAC	Fraction of hour machine ran
12	ECT	Entering condenser water temperature (°F)
13	CHWT	Leaving chilled water temperature (°F)
14	EIR1	Electric input ratio temperature correction factor
15	EIR2	Electric input ratio part-load correction factor
16	EIR3	Electric input ratio heat recovery correction factor
17	EIRW	Corrected electric input ratio (Btu/Btu)
18	HTREC	Recoverable heat (Btu/hr)



PLANT

VARIABLE-TYPE = OPEN-TWR (ITOWR = 17)

or CLOSED-TWR (ITOWR = 18)

Variable-List Number	Variable in FORTRAN Code	Description
1	LOAD	Total tower load, including pump heat (Btu/hr)
2	-	Unused
3	ELEC	Total electrical, including pumps (kW)
4-5	-	Unused
6	NCELL	Number of cells running
7	OPCAP(ITOWR)	Nominal operating capacity (Btu/hr)
8	GPM	Total fluid flow through tower (gal/min)
9	RANGE	Temperature drop through tower (°F)
10	APP	Fluid approach to wetbulb temperature (°F)
11	TTOWR	Leaving tower temperature (°F)
12	NCELL	Number of cells running
13	FRA	Variable common between range/approach performance curve and wetbulb/gpm curve
14	GPMRAT	Ratio of actual flow at current conditions to flow at 95-85-78 CTI rating conditions
15	GPMCAP	flow capacity per cell at current load, setpoint and wetbulb (gal/min)
16	GPMCEL	Current flow rate per cell (gal/min)
17	AIRCEL	Ratio of required airflow at current conditions to maximum airflow (design airflow)
18	EFRAC	Fraction of nominal fan energy this hour
19	FRACHI	Fraction of hour the fan runs at higher speed
20	EFAN	Fan energy consumption (Btu/hr)
21	EPUMP	Pump energy consumption (Btu/hr)
22	MINCEL	Minimum number of cells that can handle load
23	MAXCEL	Maximum number of cells that can handle load
24	NDCSCH	Direct cooling schedule value
25	IFC	Direct cooling: 0 = not used, 1 = used this hour

PLANT

VARIABLE-TYPE = DIESEL-GEN (IEQTYP = 21)

Variable-List Number	Variable in FORTRAN Code	Description
1	EQDEM(1,IEQTYP)	Electric load (Btu/hr)
2	—	—
3	—	—
4	EQDEM(4,IEQTYP)	Fuel energy consumed (Btu/hr)
5	—	—
6	ISIZE	Sizes running
7	OPCAP(IEQTYP)	Nominal capacity (Btu/hr)
8	ELECD	Operating load (Btu/hr)
9	PLR	Part load ratio
10	ELECFD	Efficiency of diesel engine (Btu/Btu)
11	THLOF	Ratio of jacket/lube-oil heat to fuel (Btu/Btu)
12	EJLD	Jacket/lube oil heat recovered (Btu/hr)
13	THHIF	Ratio of exhaust heat recovered to fuel (Btu/Btu)
14	EEXHD	Exhaust heat recovered (Btu/hr)
15	TEXD	Temperature of the exhaust (°F)
16	THTOF	Ratio of total heat recovered to fuel (Btu/Btu)
17	ETOT	Total heat recovered (Btu/hr)
18	—	—
19	—	—
20	—	—
21	—	—
22	—	—

PLANT

VARIABLE-TYPE = GTURB-GEN (IEQTYP = 22)

Variable-List Number	Variable in FORTRAN Code	Description
1	EQDEM(1,IEQTYP)	Electric load (Btu/hr)
2	—	—
3	—	—
4	EQDEM(4,IEQTYP)	Fuel energy consumed (Btu/hr)
5	—	—
6	ISIZE	Sizes running
7	OPCAP(IEQTYP)	Nominal capacity (Btu/hr)
8	ELECG	Operating load (Btu/hr)
9	PLR	Part load ratio
10	ELECFG	Efficiency of the gas turbine (Btu/Btu)
11	EEXHG	Exhaust heat recovered (Btu/hr)
12	EXHF	Ratio of exhaust heat recovered to fuel (Btu/Btu)
13	TEXG	Temperature of the exhaust (°F)
14	—	—

## PLANT

VARIABLE-TYPE = STURB-GEN (IEQTYP = 23)

Variable- List Number	Variable in FORTRAN Code	Description
1	EQDEM(1,IEQTYP)	Electric load (Btu/hr)
2	—	—
3	—	—
4	EQDEM(4,IEQTYP)	Steam energy input (Btu/hr)
5	—	—
6	ISIZE	Sizes running
7	OPCAP(IEQTYP)	Nominal capacity (Btu/hr)
8	PLR	Part load ratio
9	TURBF	Internal turbine efficiency (Btu/Btu)
10	ELEFF	Efficiency of the steam turbine (Btu/Btu)
11	ENREC	Ratio of recovered heat to steam input (Btu/Btu)
12	FSLOSS	Condenser losses (Btu/hr)
13	WASTE	Recovered heat (Btu/hr)

PLANT

VARIABLE-TYPE = HTANK-STORAGE (IEQTYP = 19)

Variable-List Number	Variable in FORTRAN Code	Description
1	EQDEM(1,IEQTYP)	Energy delivered (Btu/hr)
2	—	—
3	EQDEM(3,IEQTYP)	Electric energy consumed (Btu/hr)
4	EQDEM(4,IEQTYP)	Energy stored (Btu/hr)
5	—	—
6	ISIZE	Sizes running
7	OPCAP(IEQTYP)	Operating capacity (Btu/hr)
8	HTGIVE	Heat available to be given out (Btu/hr)
9	HTASK	Heat requested for storage (Btu/hr)
10	HFREEZ-CFREEZ	Heat needed to prevent freezing (Btu/hr)
11	ISTORH	Storage demand flag
12	TEMPH	Tank temperature (°F)
13	HLOSS	Tank loss (Btu/hr)
14	REALHT	Heat in tank (relative to 0°F) (Btu/hr)
15	EHSTOR	Useful heat in tank (Btu/hr)

## PLANT

VARIABLE-TYPE = CTANK-STORAGE (IEQTYP = 20)

Variable- List Number	Variable in FORTRAN Code	Description
1	EQDEM(1,IEQTYP)	Cooling energy delivered (Btu/hr)
2	—	—
3	EQDEM(3,IEQTYP)	Electric energy consumed (Btu/hr)
4	EQDEM(4,IEQTYP)	Cooling energy stored (Btu/hr)
5	—	—
6	ISIZE	Sizes running
7	OPCAP(IEQTYP)	Operating capacity (Btu/hr)
8	CDGIVE	Cooling energy available to be given out (Btu/hr)
9	CDASK	Cooling energy requested for storage (Btu/hr)
10	CFREEZ	Heat needed to prevent freezing (Btu/hr)
11	TEMPL	Tank temperature (°F)
12	CLOSS	Tank loss (Btu/hr)
13	REALCD	Heat in tank (relative to 0°F) (Btu)
14	ECSTOR	Useful cold in tank (Btu)

# PLANT

## VARIABLE-TYPE = FURNACE

Variable- List Number	Variable in FORTRAN Code	Description
1	EQDEM(1,5)	Space heating load (Btu/hr)
2	—	—
3	EQDEM(3,5)	Electric energy consumed (Btu/hr)
4	EQDEM(4,5)	Fuel consumed (Btu/hr)
5	—	—
6	ISIZE	Sizes running
7	OPCAP(5)	Operating capacity (Btu/hr)
8	PLR	Average part load ratio
9	HIRCOR	Fuel consumption correction factor

PLANT

VARIABLE-TYPE = DHW-HEATER

Variable- List Number	Variable in FORTRAN Code	Description
1	EQDEM(1,6)	Process or domestic hot water load (Btu/hr)
2	—	—
3	EQDEM(3,6)	Electricity consumed (Btu/hr)
4	EQDEM(4,6)	Fuel consumed (Btu/hr)
5	—	—
6	ISIZE	Sizes running
7	OPCAP(6)	Operating capacity (Btu/hr)
8	PLR	Part-load ratio
9	HIRCOR	Fuel consumption correction factor



# APPENDIX B

## INPUT FUNCTIONS

### LOADS and SYSTEMS FLOWCHARTS

This appendix shows flowcharts of the LOADS and SYSTEMS programs. Points at which user-input functions are called are indicated by bold-face arrows. See "Input Functions in LOADS and SYSTEMS", on p.1.1 for directions on how to use the input functions in BDL to either override or supplement the regular program calculations.

NOTES :

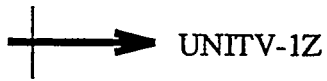

means there is a SUBR-FUNCTION named UNITV-1Z.

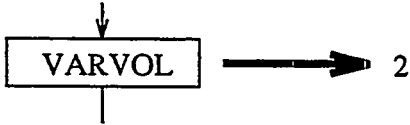

means there is a separate flowchart for subroutine VARVOL, and 2 is the level of the flowchart.



means there is a SUBR-FUNCTION named EBAL-1 in subroutine EBAL. But the separate flowchart for this subroutine is omitted.



means the name of the subroutine is VARVOL , and its flowchart level is 2 .

## LOADS FLOWCHARTS

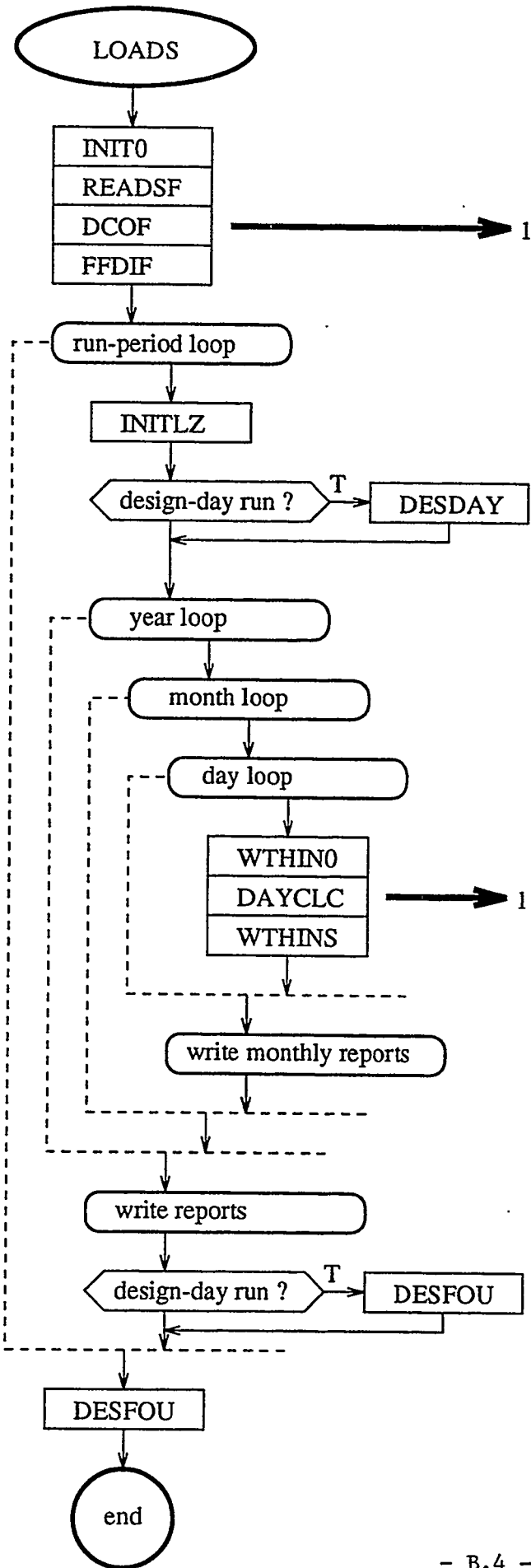

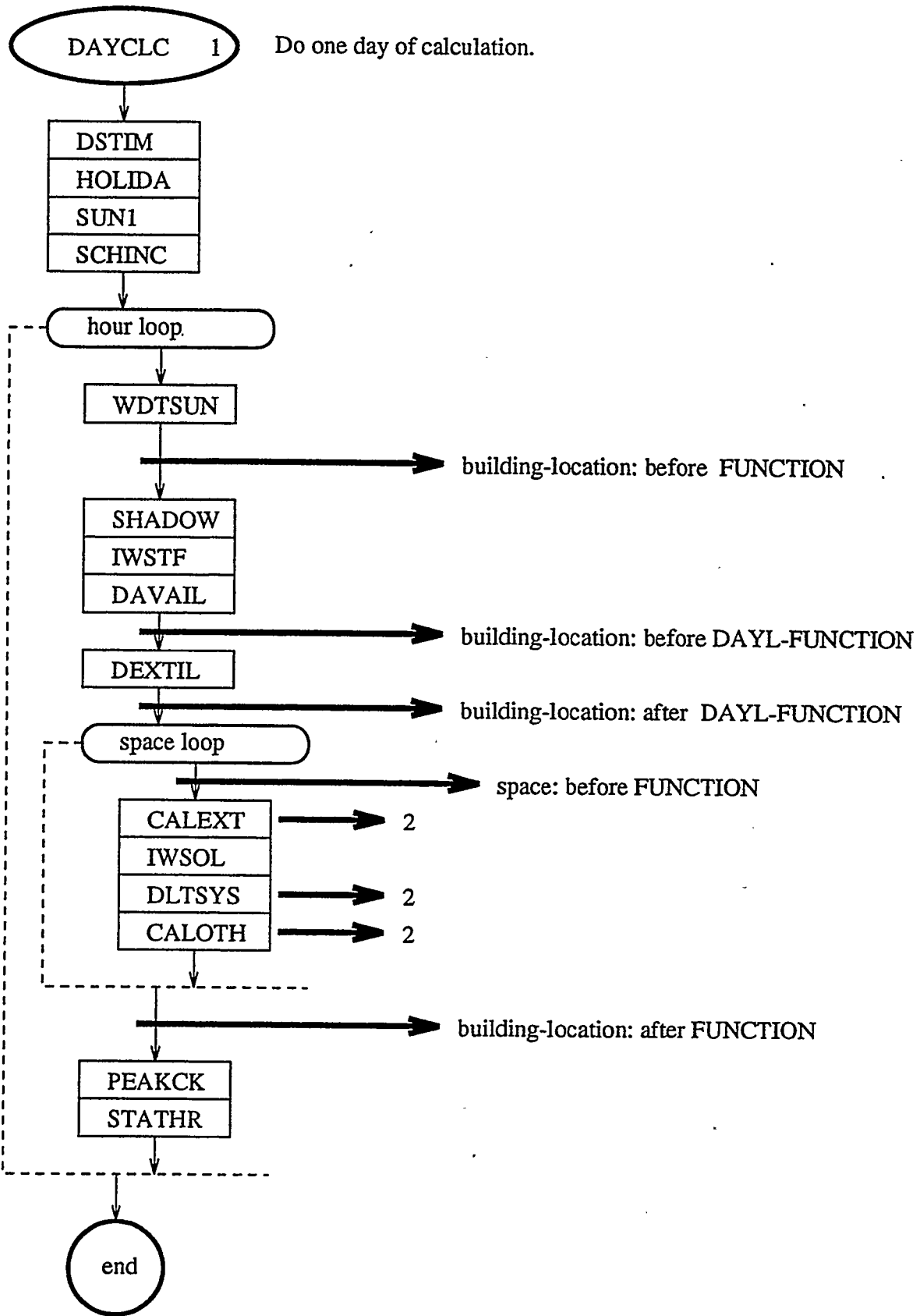

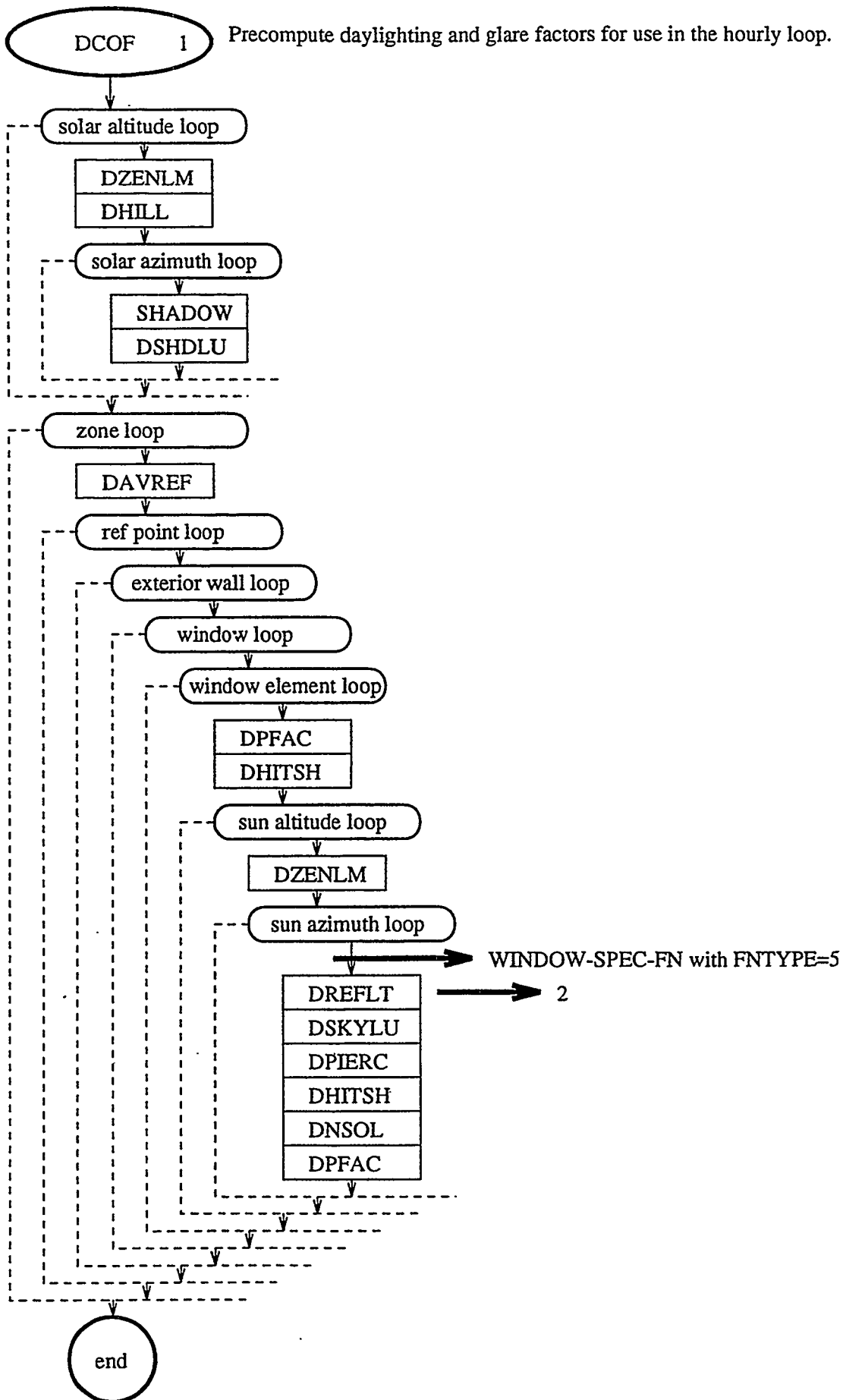

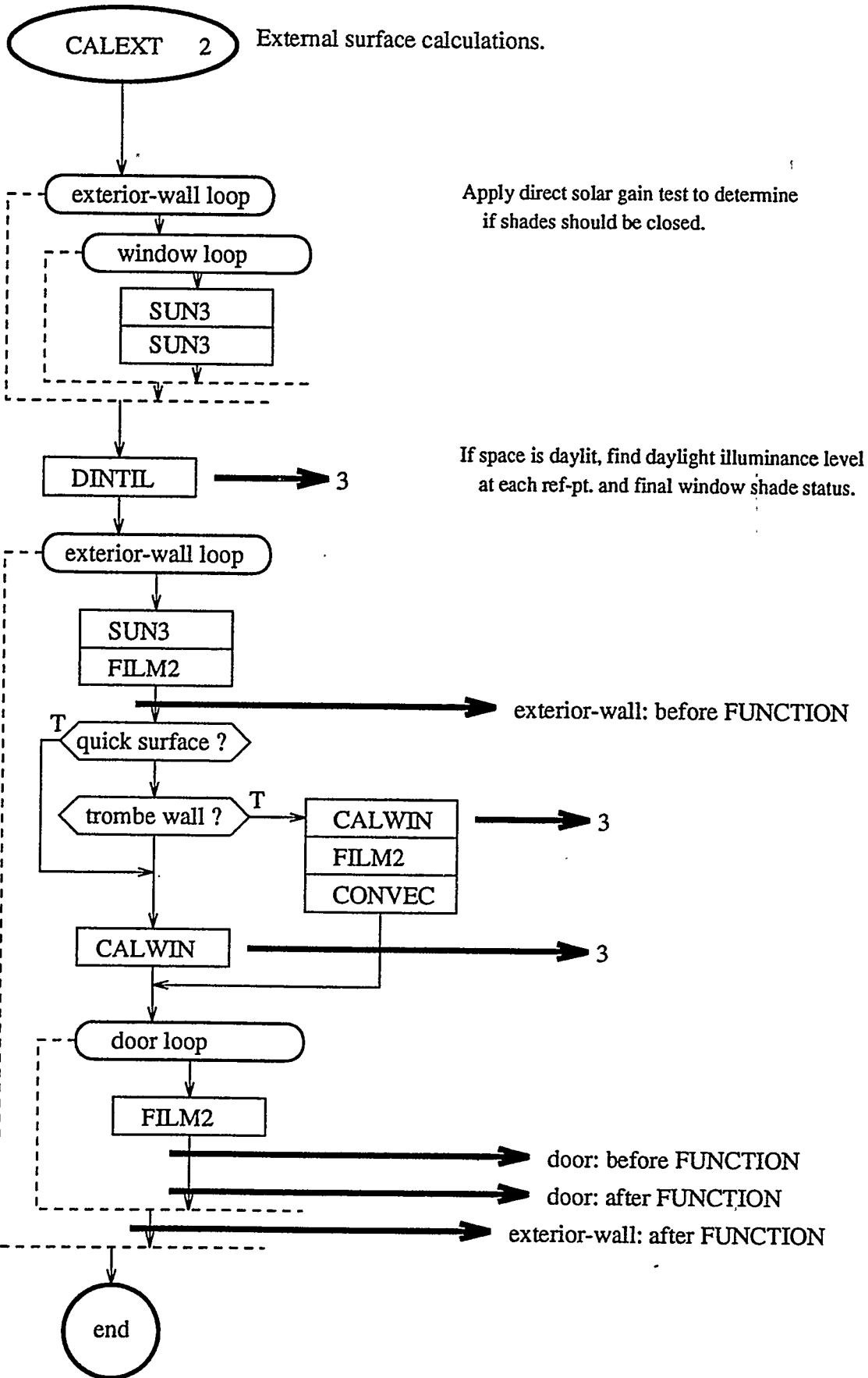

CALOTH 2

Calculate zone other loads and do weighting.



underground: before FUNCTION

calc. zone underground-wall, floor loads



underground: after FUNCTION

calc. zone occupancy, equipment, light, task-light loads.

if space is adjacent to a sunspace, add solar gain from radiation passing through interior windows.

Transfer unweighted variables to the report-block buffer.



space: after FUNCTION with FNTYPE=1

do weighting.

calc. infiltration loads.



space: FUNCTION with FNTYPE=2

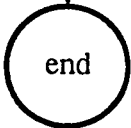



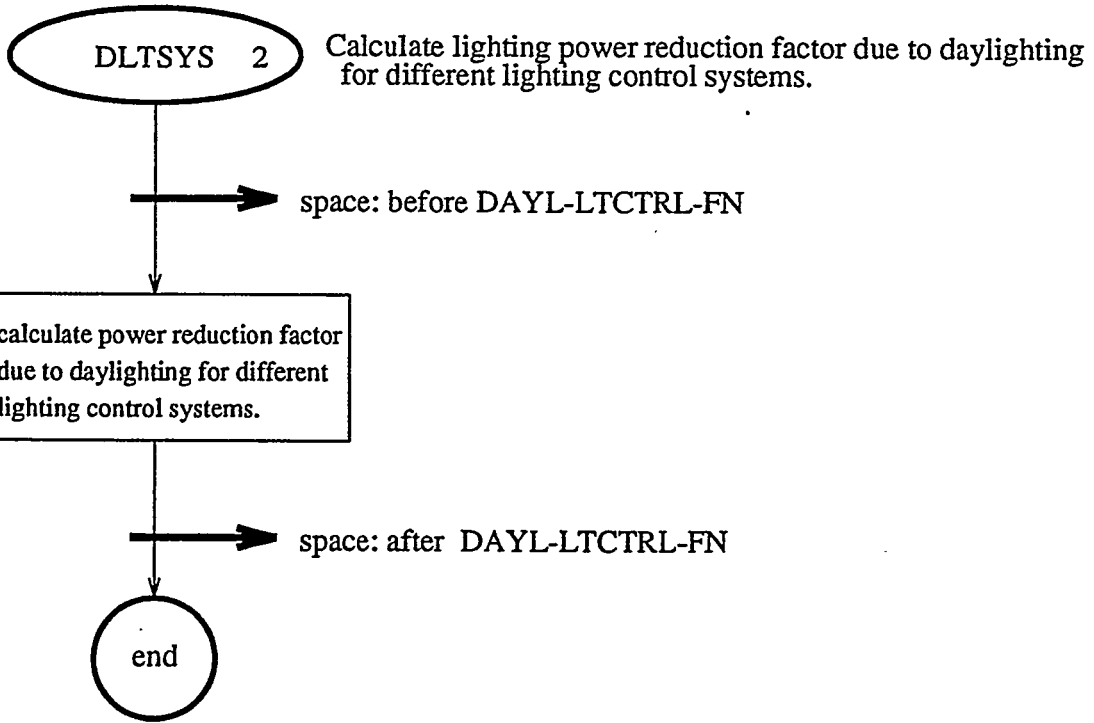

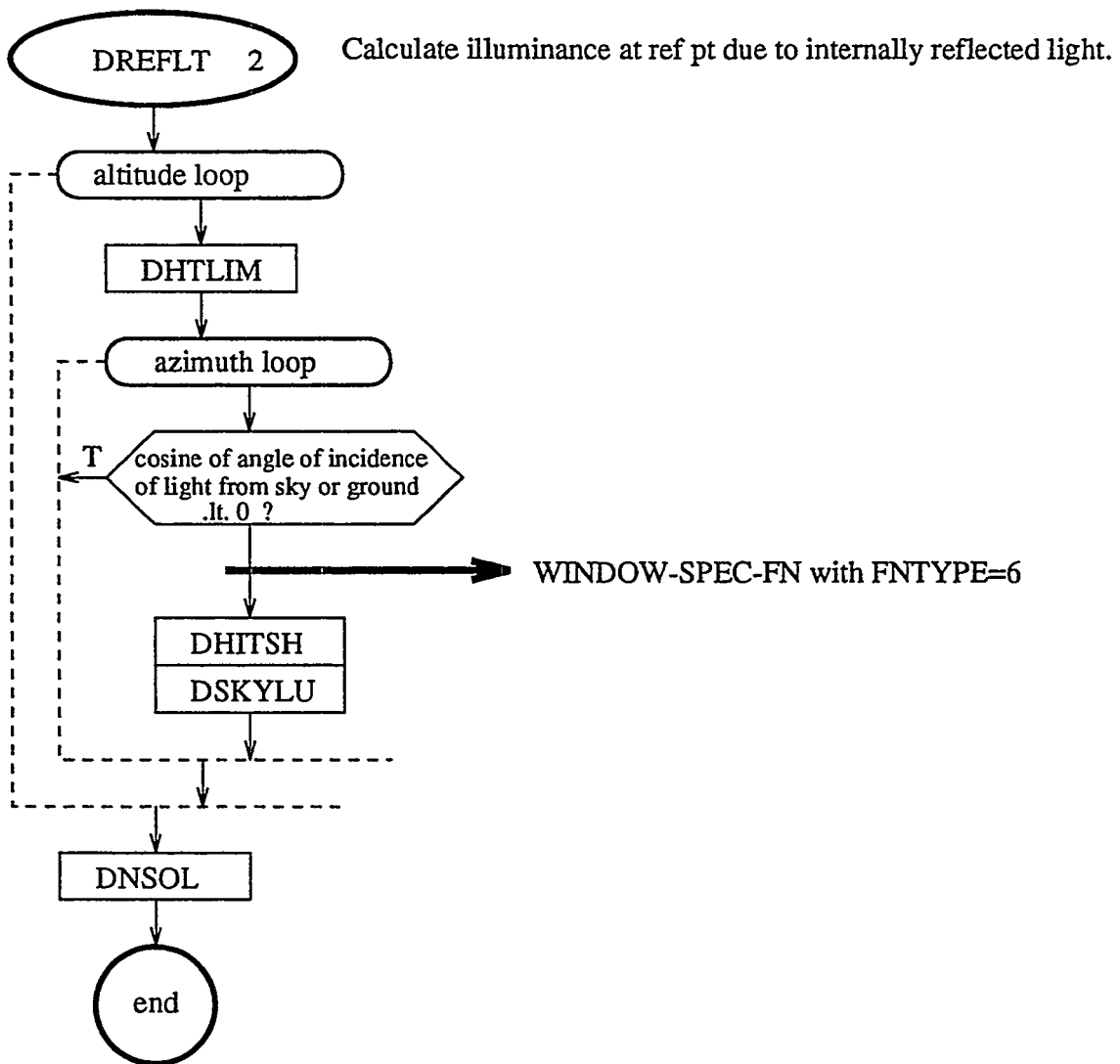

CALWIN 3

Calculate energy flow through windows.

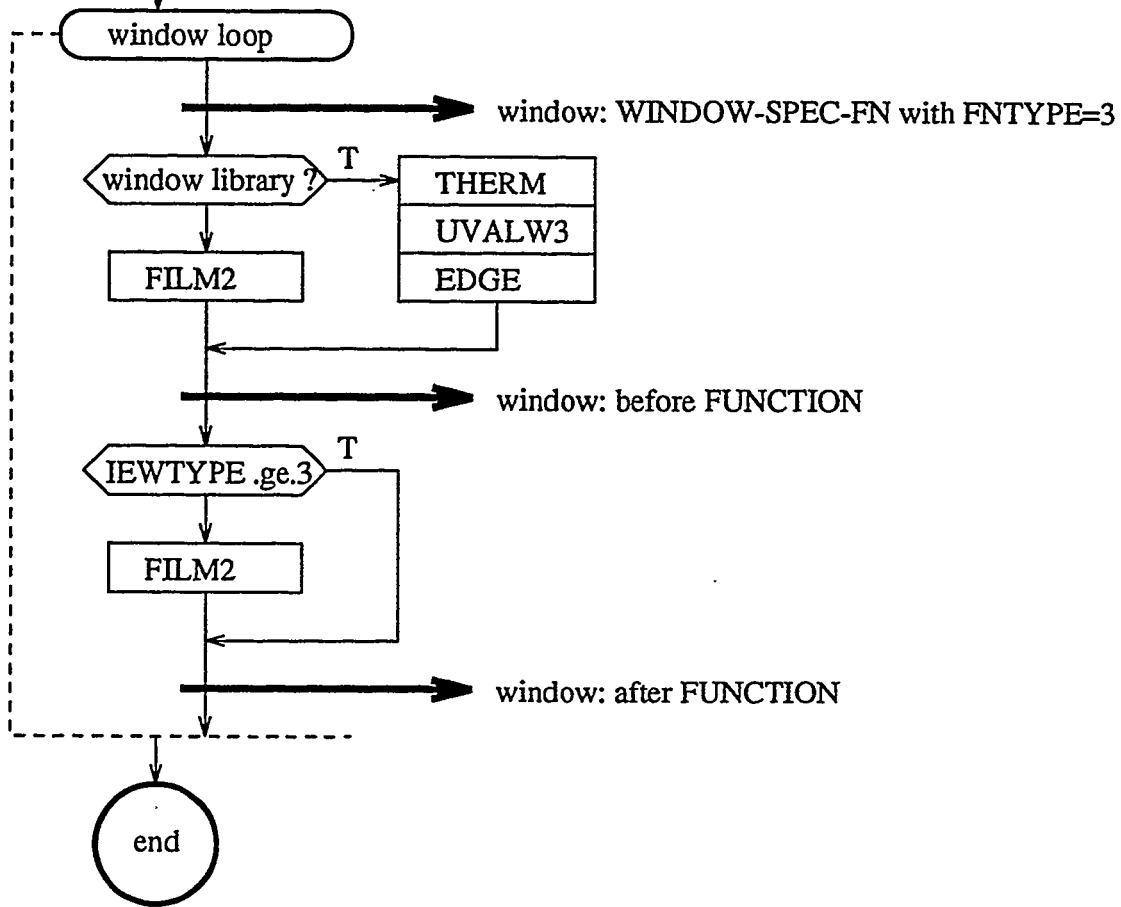

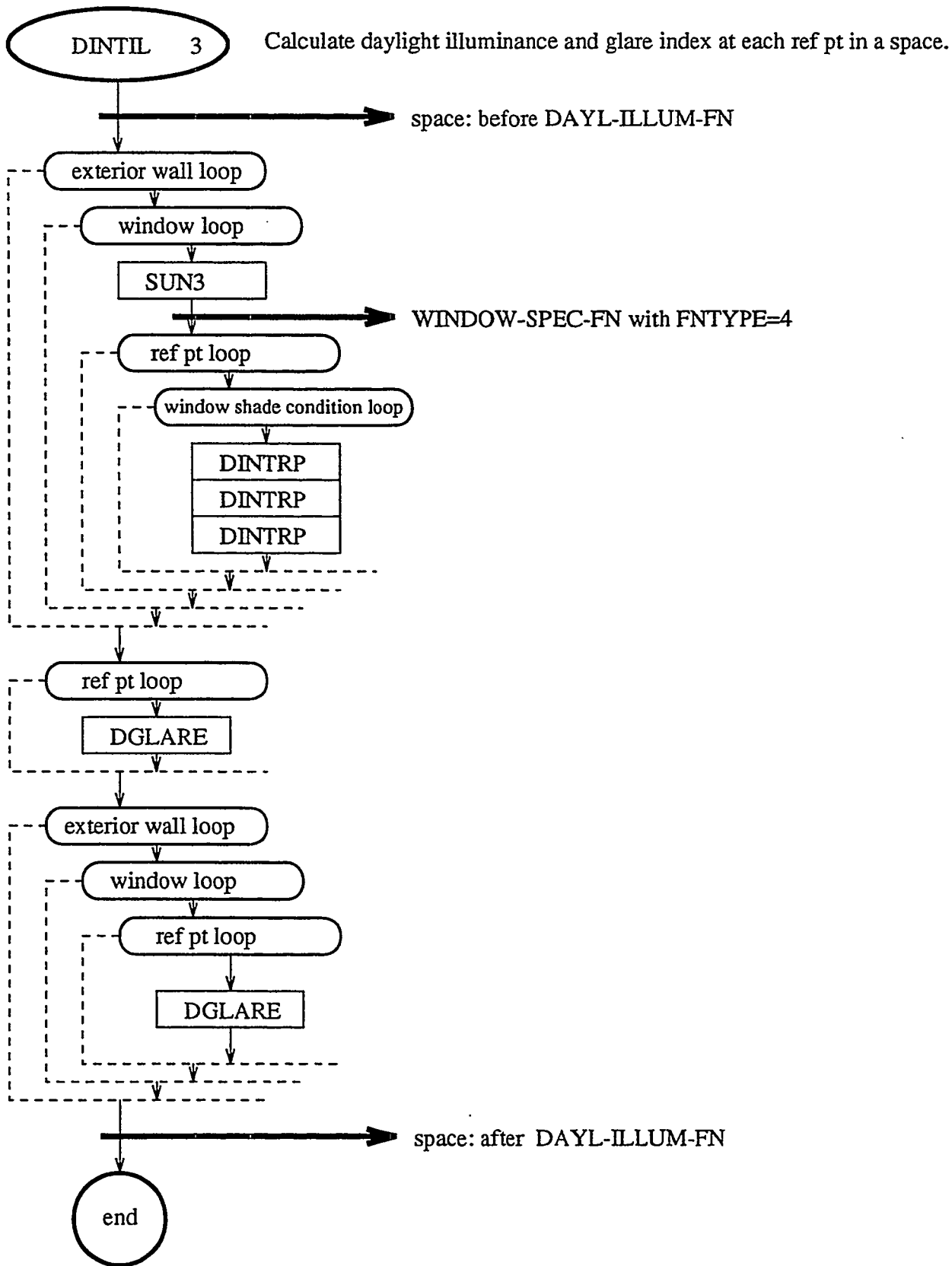

**SYSTEMS FLOWCHARTS**

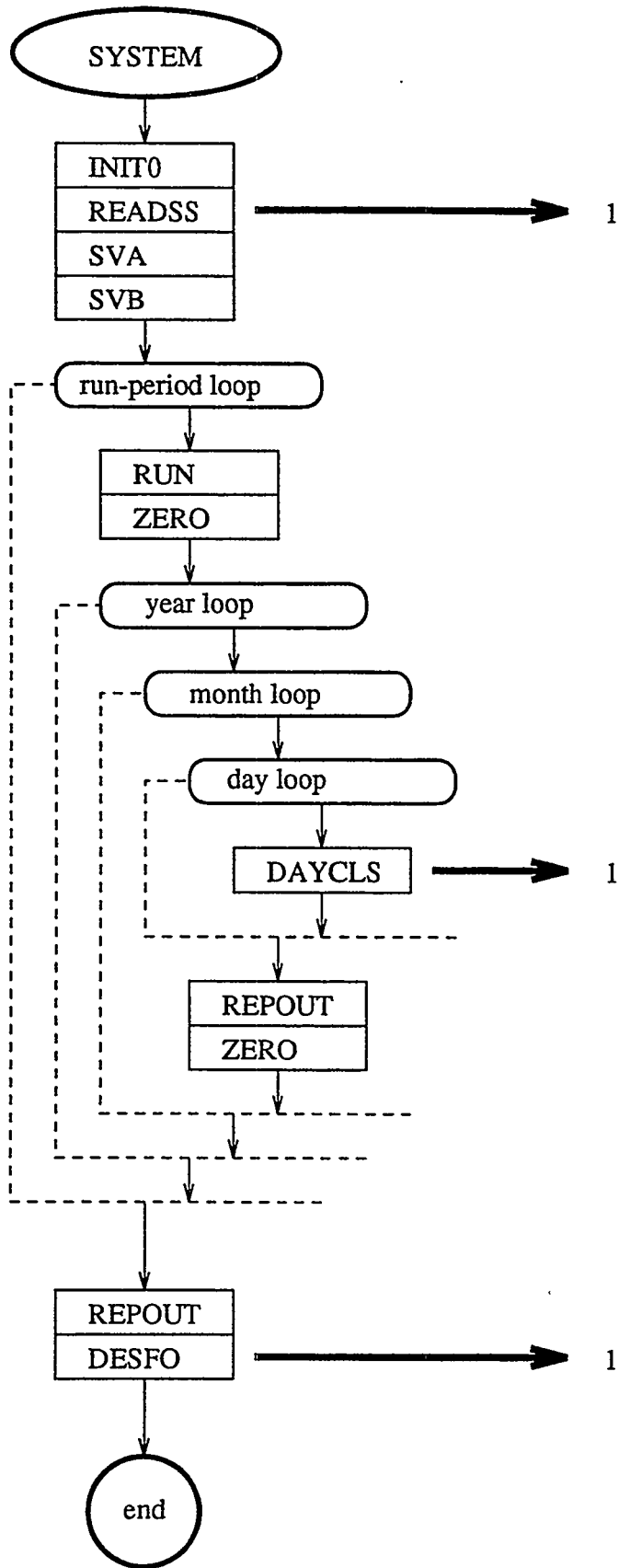

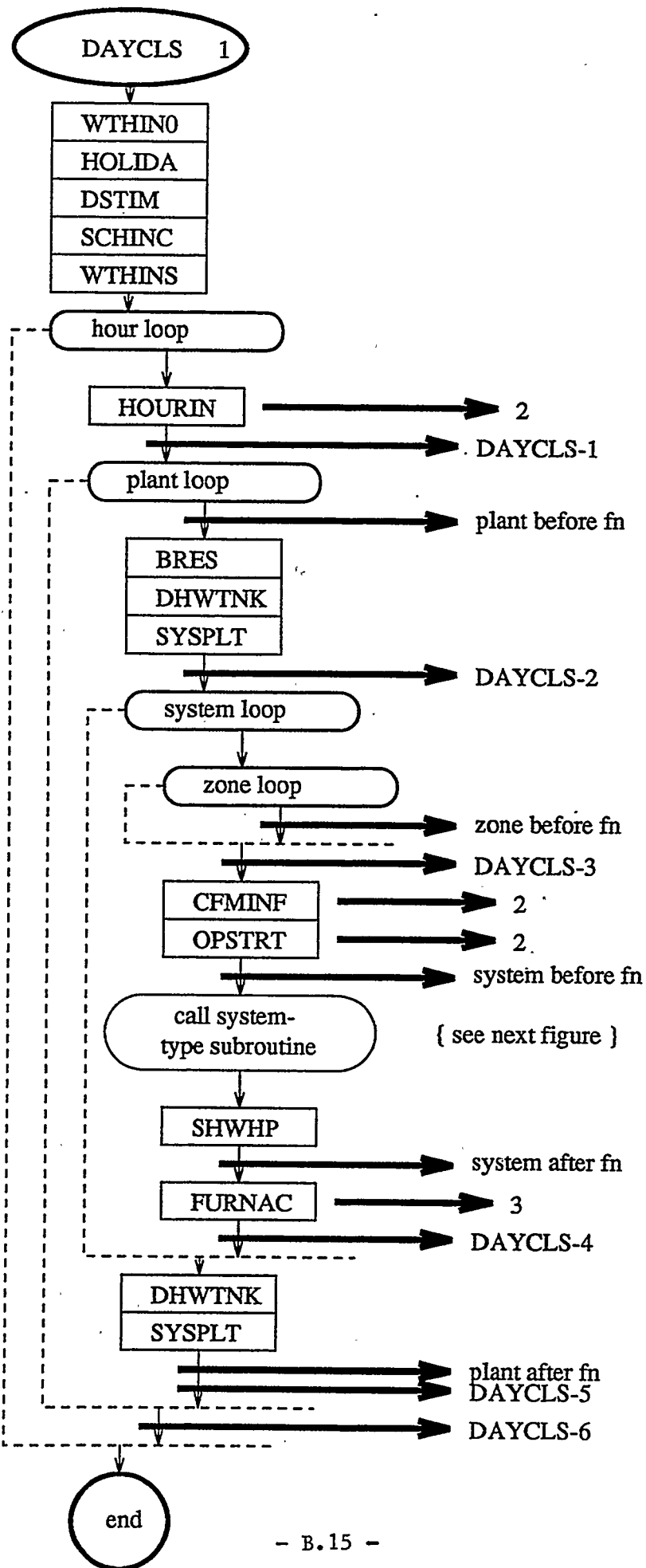

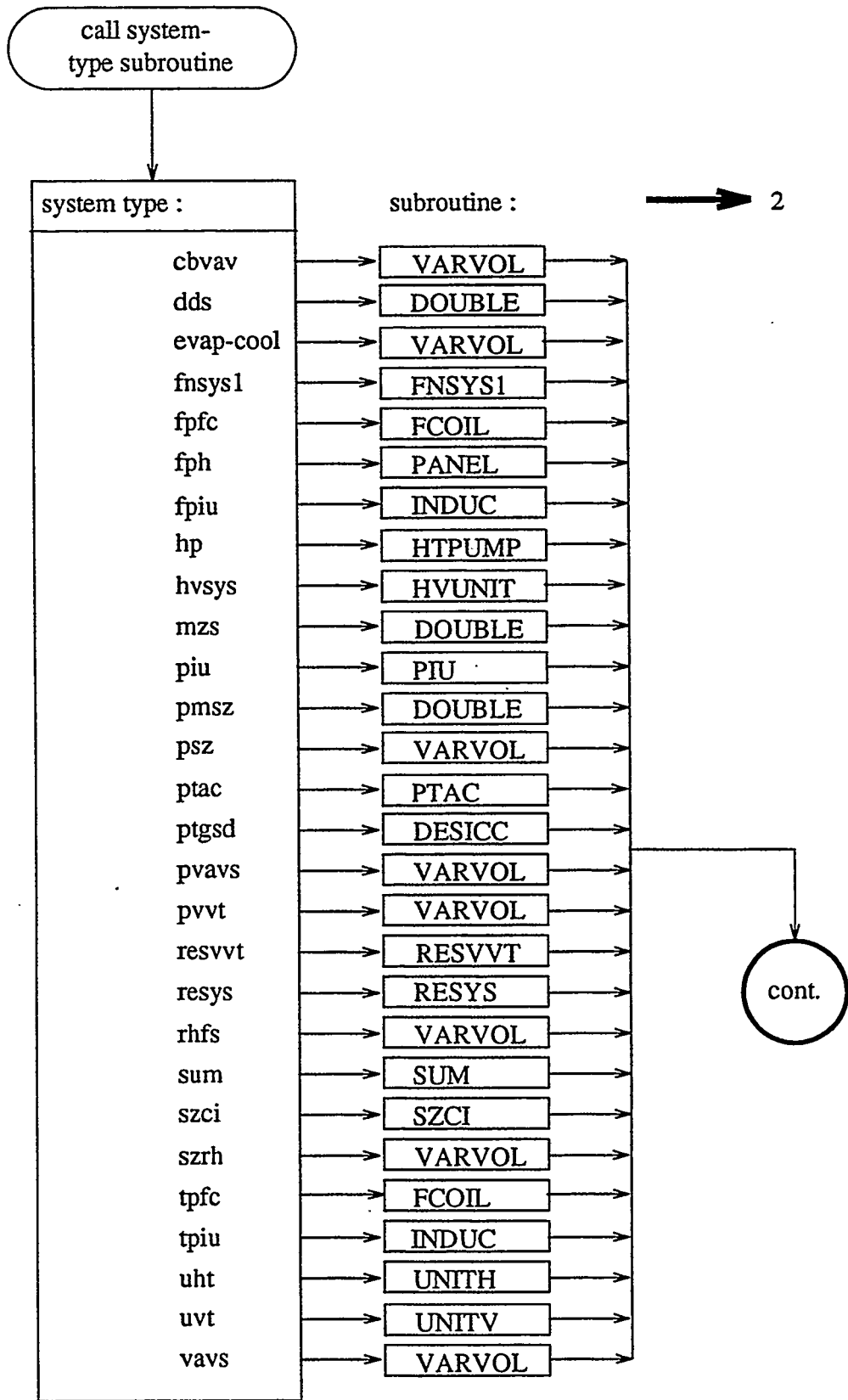



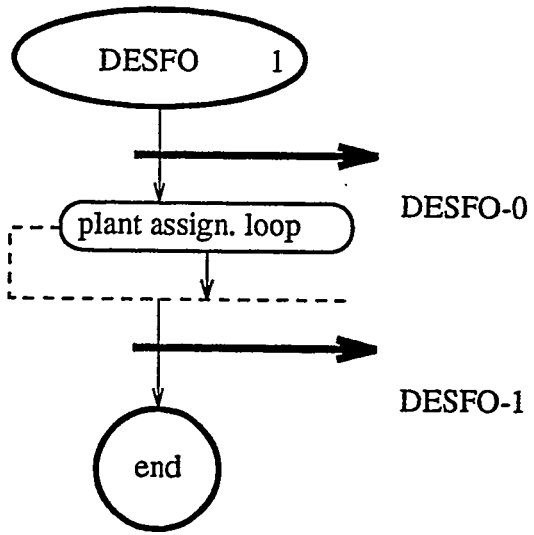

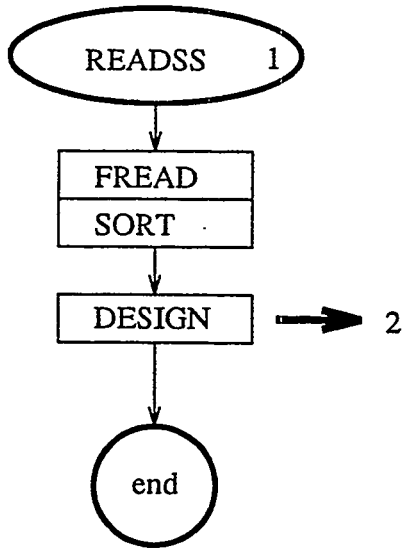

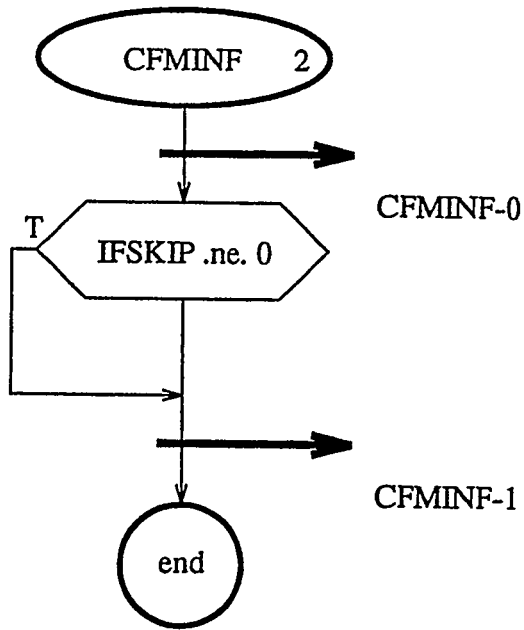

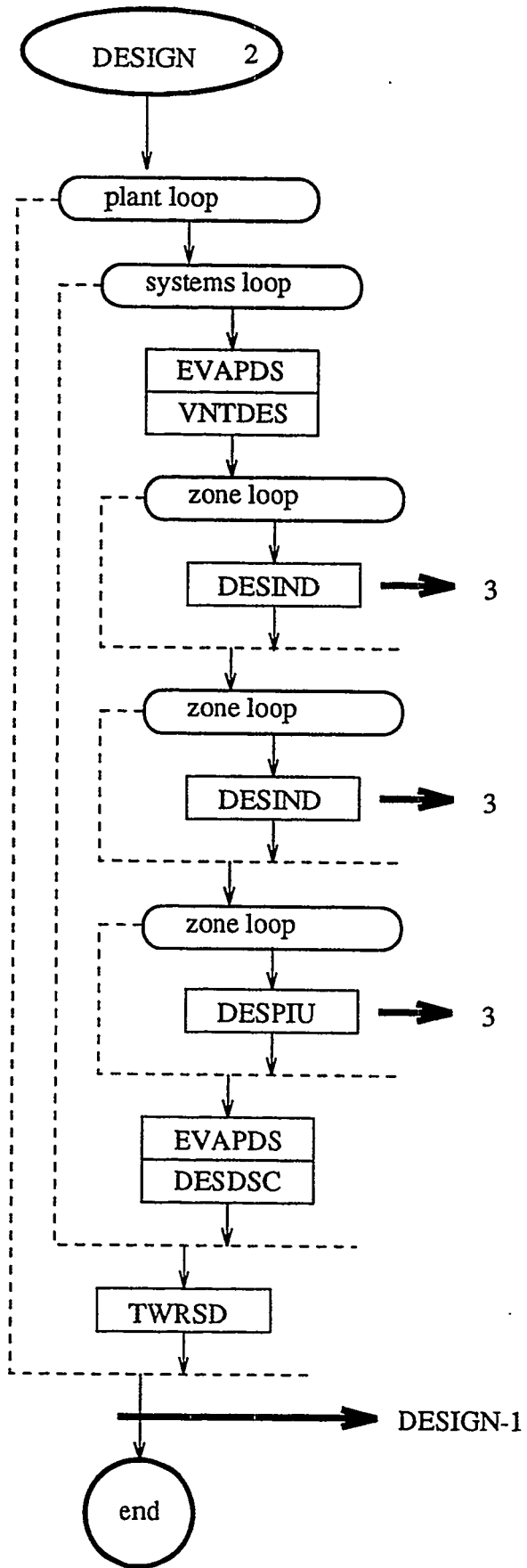

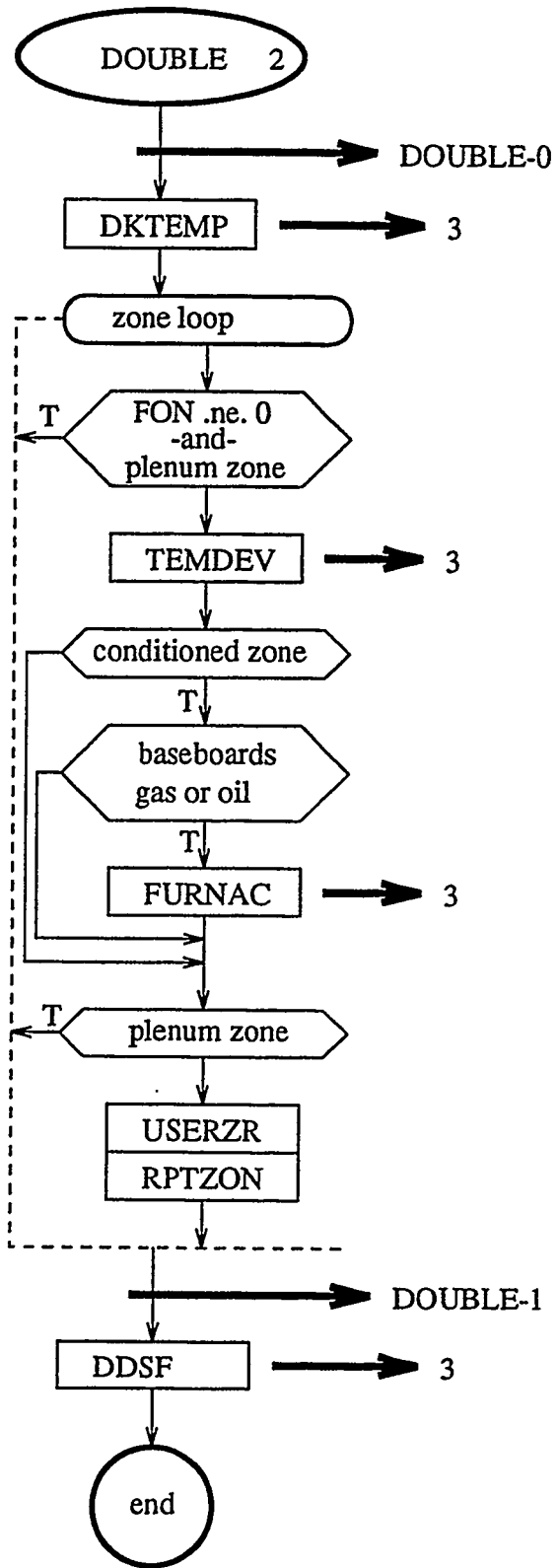

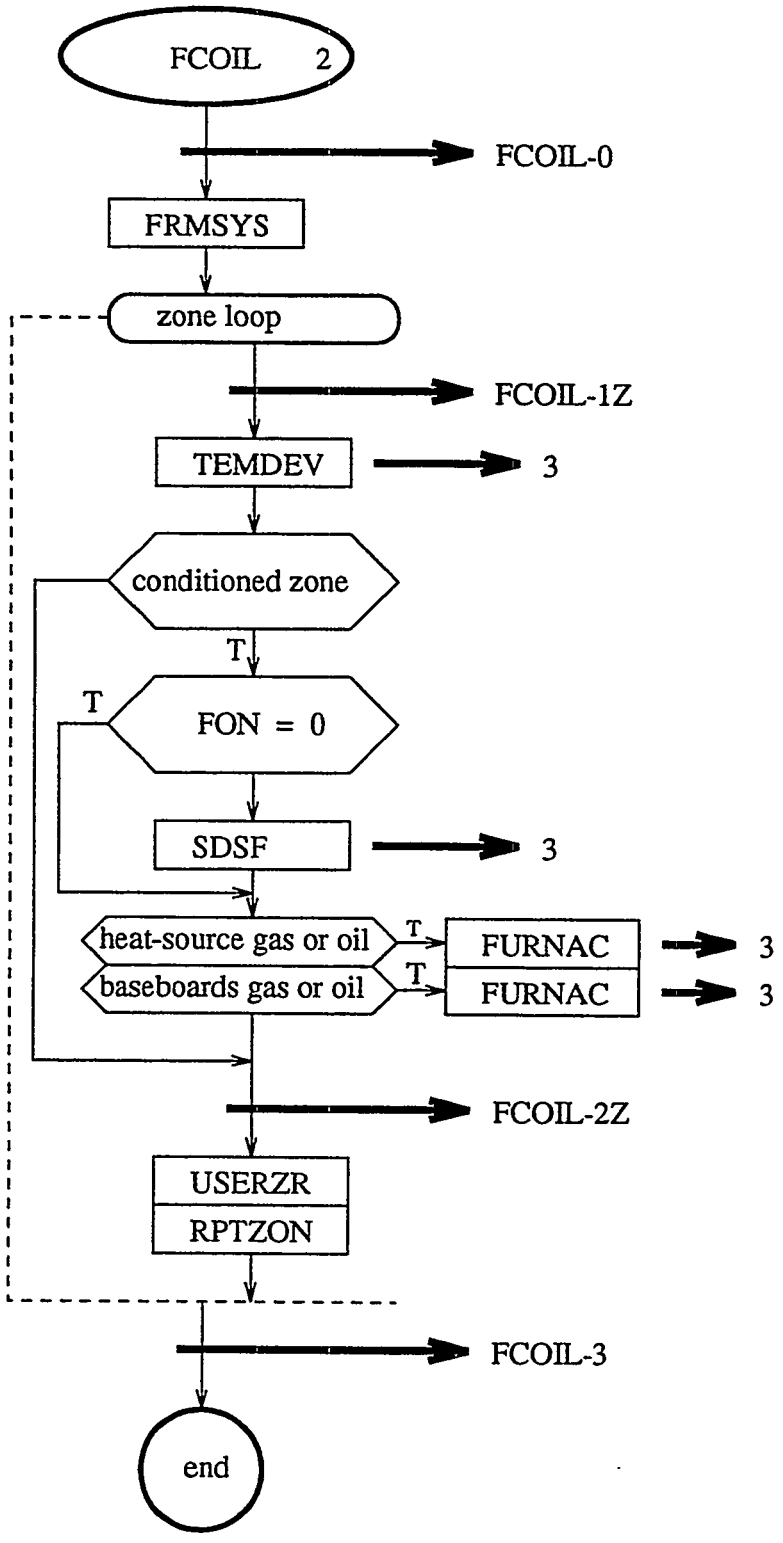

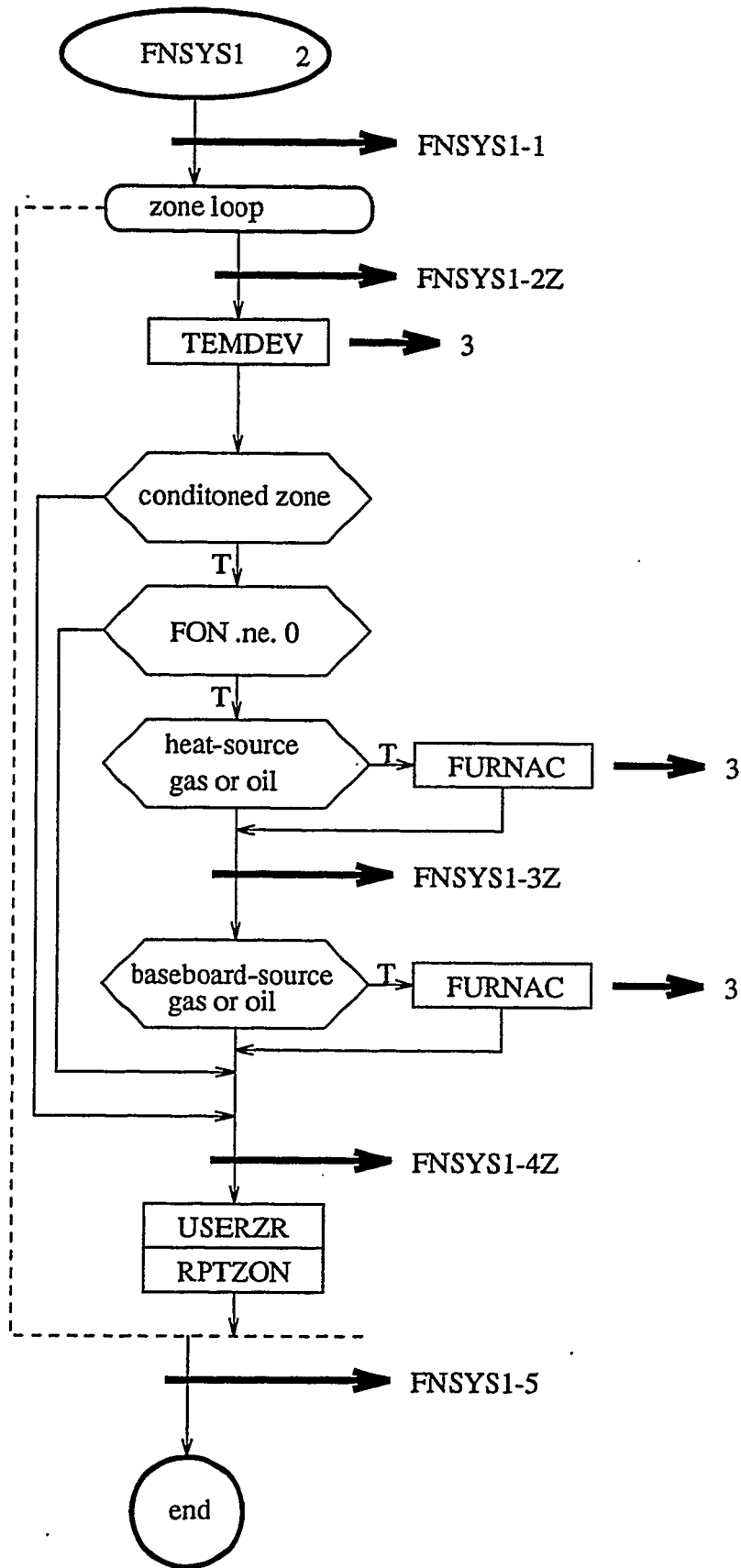





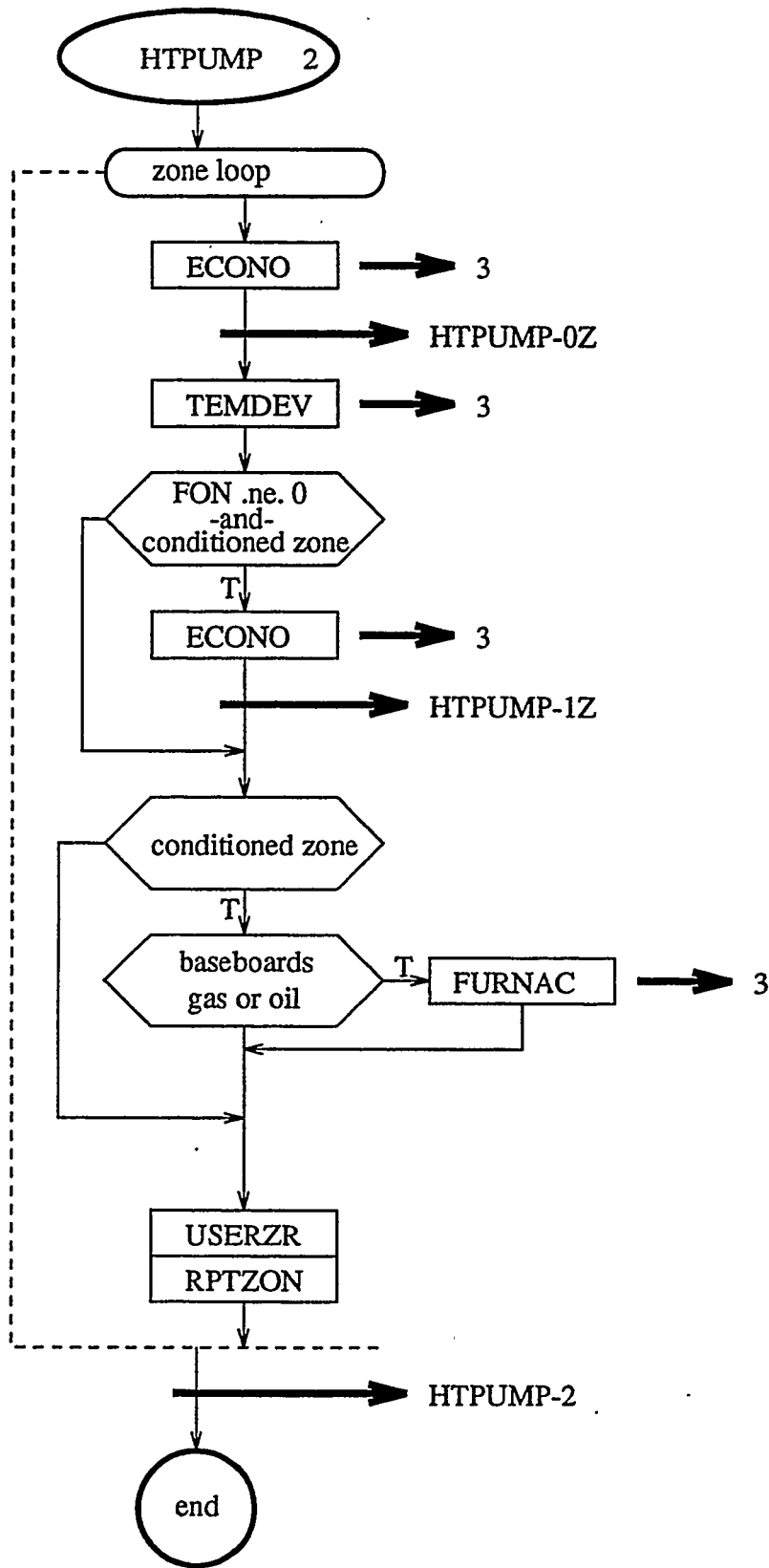

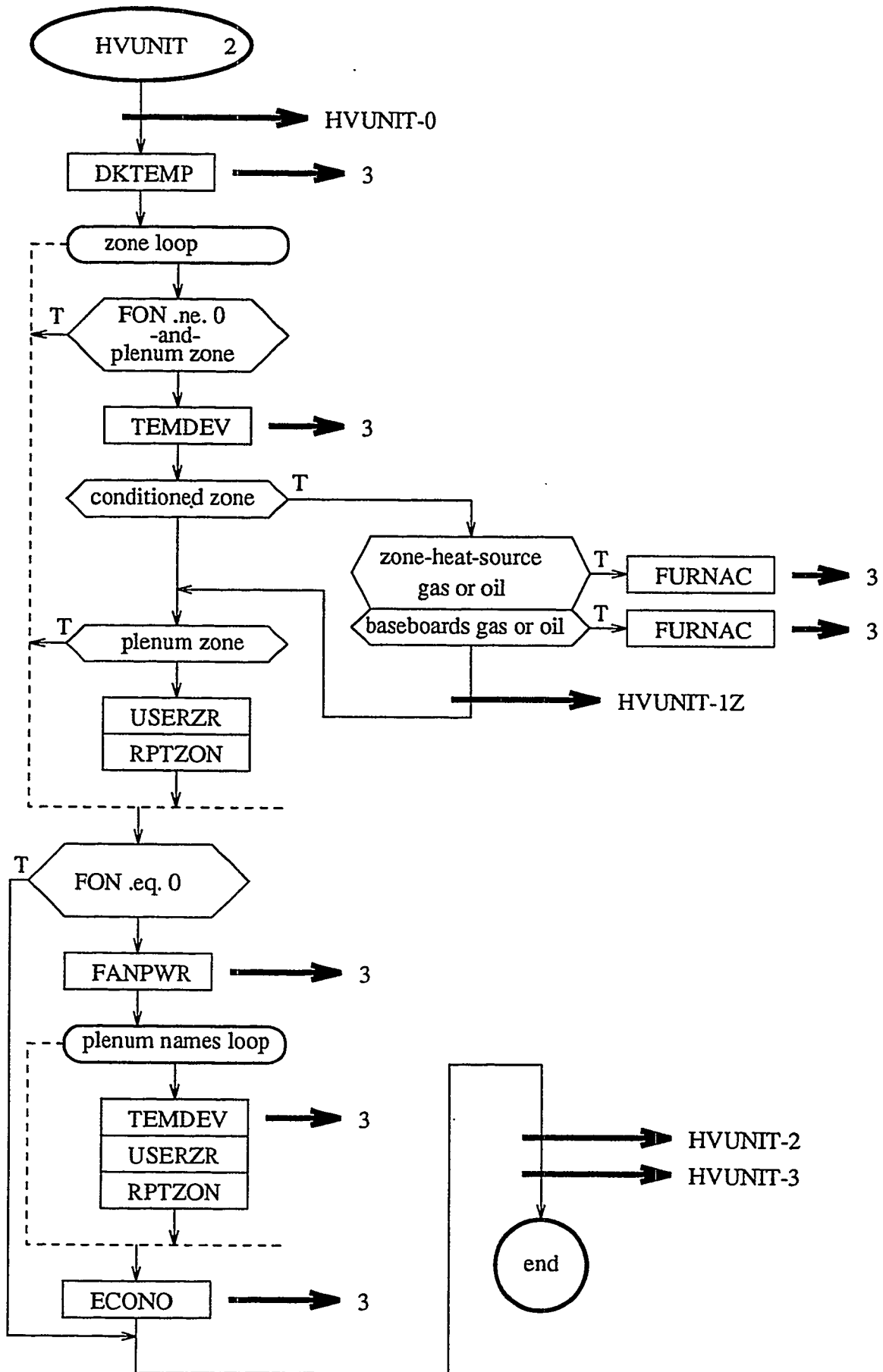

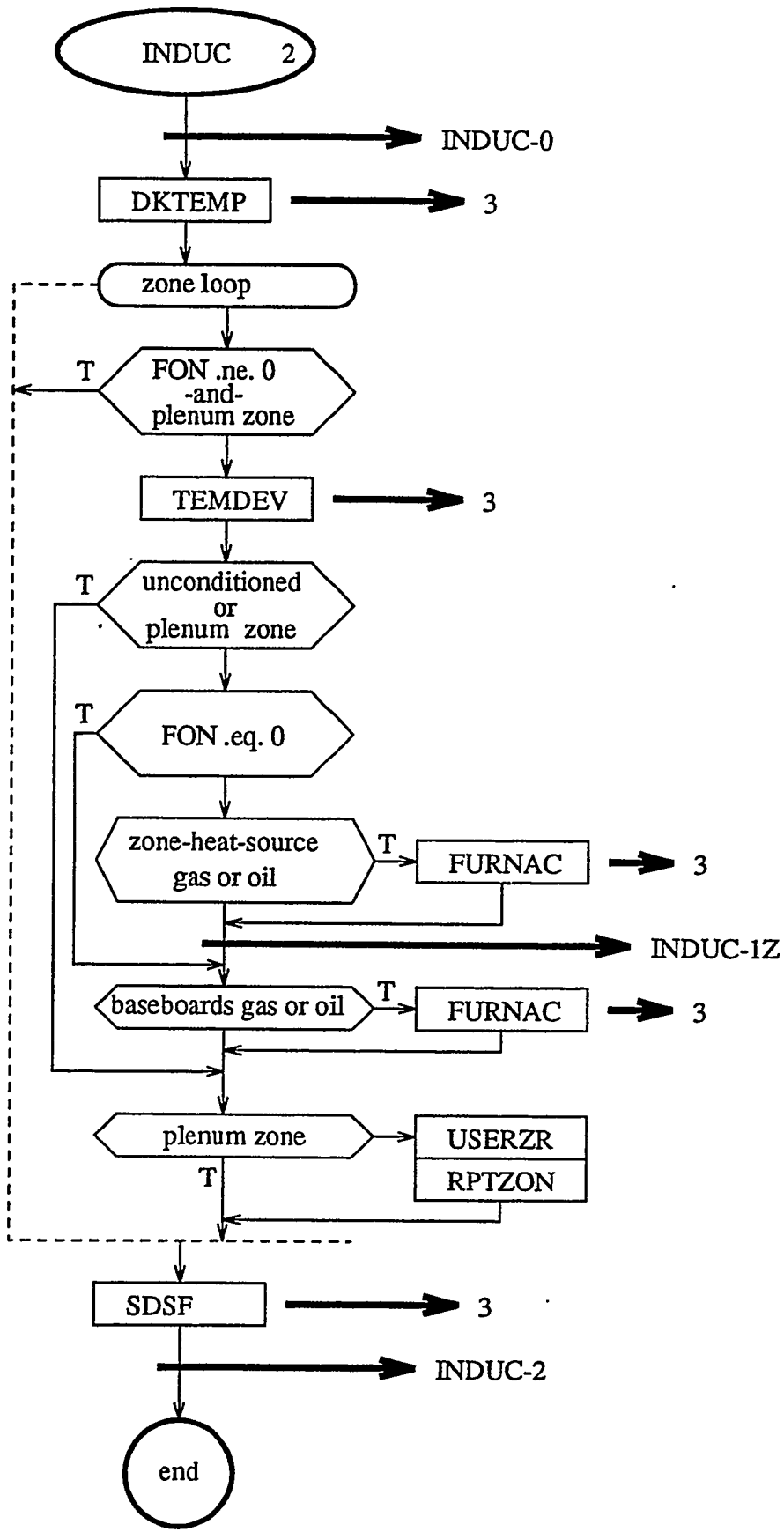

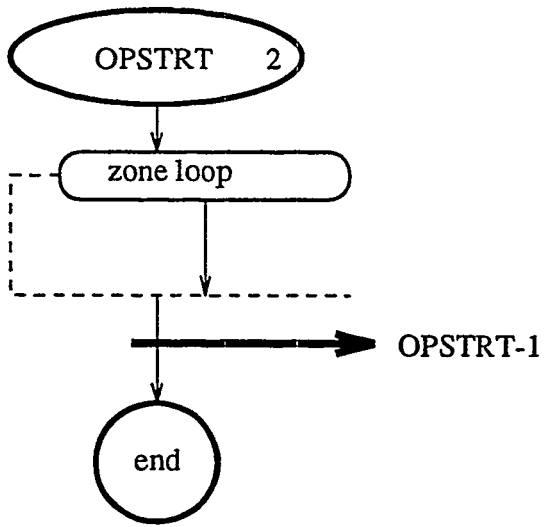

## APPENDIX C

### Verification and Summary Reports for for LOADS, SYSTEMS, PLANT, and ECONOMICS

This appendix shows examples of the verification, summary, and hourly reports printed by the DOE-2 LOADS, SYSTEMS, PLANT, and ECONOMICS programs. A description of the contents of each summary report and selected verification reports is given. The corresponding input for these reports can be found in the *Sample Run Book (2.1E)* for the building indicated in the first line of the report title. The sample reports in this appendix are in English units. For metric runs the corresponding units can be determined from the DOE-2 Units Table (see "Metric Option", p.1.35).

# REPORT LV-A

## GENERAL PROJECT AND BUILDING INPUT

SIMPLE STRUCTURE RUN 3, CHICAGO      DIVIDE INTO ZONES; ADD PLENUM      DOE-2.1E-001 Thu Nov 4 15:19:02 1993LDL RUN 3  
 DESIGN-DAY SIZING OF VAV SYSTEM      SHOW ALL REPORTS  
 REPORT- LV-A GENERAL PROJECT AND BUILDING INPUT      WEATHER FILE- TRY CHICAGO

---

### PERIOD OF STUDY

STARTING DATE	ENDING DATE	NUMBER OF DAYS
3 AUG 1974	5 AUG 1974	3
5 JAN 1974	7 JAN 1974	3
6 APR 1974	8 APR 1974	3
1 JAN 1974	31 DEC 1974	365

### SITE CHARACTERISTIC DATA

STATION NAME	LATITUDE (DEG)	LONGITUDE (DEG)	ALTITUDE (FT)	TIME ZONE	BUILDING AZIMUTH (DEG)
TRY CHICAGO	42.0	88.0	610.	6 CST	30.0

# REPORT LV-B

## SUMMARY OF SPACES OCCURRING IN THE PROJECT

SIMPLE STRUCTURE RUN 3, CHICAGO                      DIVIDE INTO ZONES; ADD PLENUM                      DOE-2.1E-001 Thu Nov 4 15:19:02 1993LDL RUN 3  
 DESIGN-DAY SIZING OF VAV SYSTEM                      SHOW ALL REPORTS  
 REPORT- LV-B SUMMARY OF SPACES OCCURRING IN THE PROJECT                      WEATHER FILE- TRY CHICAGO

---

NUMBER OF SPACES    6                      EXTERIOR    5                      INTERIOR    1

SPACE	SPACE*FLOOR MULTIPLIER	SPACE TYPE	AZIMUTH	LIGHTING	PEOPLE	EQUIP	INFILTRATION METHOD	AIR CHANGES PER HOUR	AREA (SQFT )	VOLUME (CUFT )
				(WATT / SQFT )		(WATT / SQFT )				
PLENUM-1	1.0	EXT	0.0	0.00	0.0	0.00	NO-INFILT.	0.00	5000.00	10000.00
SPACE1-1	1.0	EXT	0.0	1.50	11.0	1.00	AIR-CHANGE	0.25	1056.00	8448.00
SPACE2-1	1.0	EXT	0.0	1.50	5.0	1.00	AIR-CHANGE	0.25	456.00	3648.00
SPACE3-1	1.0	EXT	0.0	1.50	11.0	1.00	AIR-CHANGE	0.25	1056.00	8448.00
SPACE4-1	1.0	EXT	0.0	1.50	5.0	1.00	AIR-CHANGE	0.25	456.00	3648.00
SPACE5-1	1.0	INT	0.0	1.50	20.0	1.00	AIR-CHANGE	0.25	1976.00	15808.00
BUILDING TOTALS					52.0				10000.00	50000.00

# REPORT LV-C

## DETAILS OF SPACE

SIMPLE STRUCTURE RUN 3, CHICAGO  
 DESIGN-DAY SIZING OF VAV SYSTEM  
 REPORT- LV-C DETAILS OF SPACE

DIVIDE INTO ZONES; ADD PLENUM  
 SHOW ALL REPORTS  
 SPACE1-1

DOE-2.1E-001 Thu Nov 4 15:19:02 1993LDL RUN 3

WEATHER FILE- TRY CHICAGO

DATA FOR SPACE SPACE1-1

LOCATION OF ORIGIN IN  
 BUILDING COORDINATES

XB (FT)	YB (FT)	ZB (FT)	SPACE AZIMUTH (DEG)	SPACE*FLOOR MULTIPLIER	HEIGHT (FT)	AREA (SQFT)	VOLUME (CUFT)
0.00	0.00	0.00	0.00	1.0	8.00	1056.00	8448.00

TOTAL NUMBER OF SURFACES	NUMBER OF EXTERIOR SURFACES	NUMBER OF INTERIOR SURFACES	NUMBER OF UNDERGROUND SURFACES	DAYLIGHTING	SUNSPACE
6	1	4	1	NO	NO

NUMBER OF SUBSURFACES

TOTAL	EXTERIOR WINDOWS	DOORS	INTERIOR WINDOWS
2	2	0	0

FLOOR WEIGHT (LB/SQFT)	CALCULATION TEMPERATURE (F)
70.0	70.0

INFILTRATION

SCHEDULE	INFILTRATION CALCULATION METHOD	FLOW RATE (CFM/SQFT)	AIR CHANGES PER HOUR	HEIGHT TO NEUTRAL ZONE (FT)
INFIL-SCH	AIR-CHANGE	0.00	0.25	0.0

PEOPLE

SCHEDULE	NUMBER	AREA PER PERSON (SQFT)	PEOPLE ACTIVITY (BTU/HR)	PEOPLE SENSIBLE (BTU/HR)	PEOPLE LATENT (BTU/HR)
OCCUPY-1	11.0	96.0	400.0	0.0	0.0



LIGHTING

SCHEDULE	LIGHTING TYPE	LOAD (WATTS/ SQFT )	LOAD (KW)	FRACTION OF LOAD TO SPACE
LIGHTS-1	REC-FLUOR-RV	1.50	0.00	0.80

ELECTRICAL EQUIPMENT

SCHEDULE	ELEC LOAD (WATTS/ SQFT )	ELEC LOAD (KW)	FRACTION OF LOAD TO SPACE	
			SENSIBLE	LATENT
EQUIP-1	1.00	0.00	1.00	0.00

INTERIOR SURFACES (U-VALUE INCLUDES BOTH AIR FILMS)

SURFACE	AREA (SQFT )	CONSTRUCTION	U-VALUE (BTU/HR-SQFT-F)	ADJACENT SPACE	SURFACE-TYPE	
					QUICK	STANDARD
C1-1	1056.00	CLNG-1	0.270	PLENUM-1	QUICK	STANDARD
SB12	135.76	SB-U	1.500	SPACE2-1	QUICK	AIR
SB14	135.76	SB-U	1.500	SPACE4-1	QUICK	AIR
SB15	608.00	SB-U	1.500	SPACE5-1	QUICK	AIR

EXTERIOR SURFACES (U-VALUE EXCLUDES OUTSIDE AIR FILM)

SURFACE	MULTIPLIER	AREA (SQFT )	WIDTH (FT)	HEIGHT (FT)	CONSTRUCTION	U-VALUE (BTU/HR-SQFT-F)	SURFACE TYPE

SURFACE	AZIMUTH (DEG)	TILT (DEG)	LOCATION OF ORIGIN IN BUILDING COORDINATES			LOCATION OF ORIGIN IN SPACE COORDINATES		
			XB (FT)	YB (FT)	ZB (FT)	X (FT)	Y (FT)	Z (FT)
FRONT-1	180.0	90.0	0.00	0.00	0.00	0.00	0.00	0.00

UNDERGROUND SURFACES (U-VALUE INCLUDES INSIDE AIR FILM)

SURFACE	MULTIPLIER	AREA (SQFT )	CONSTRUCTION	U-VALUE (BTU/HR-SQFT-F)
F1-1	1.0	1056.00	FLOOR-1	0.05

SIMPLE STRUCTURE RUN 3, CHICAGO  
 DESIGN-DAY SIZING OF VAV SYSTEM  
 REPORT- LV-C DETAILS OF SPACE

DIVIDE INTO ZONES; ADD PLENUM  
 SHOW ALL REPORTS  
 SPACE1-1

DOE-2.1E-001 Thu Nov 4 15:19:02 1993LDL RUN 3

WEATHER FILE- TRY CHICAGO

(CONTINUED)

EXTERIOR WINDOWS (U-VALUE INCLUDES OUTSIDE AIR FILM)

WINDOW	MULTIPLIER	GLASS AREA (SQFT )	GLASS SHADING COEFF	NUMBER OF PANES	GLASS TYPE CODE	SET- BACK (FT)	GLASS WIDTH (FT)	GLASS HEIGHT (FT)	CENTER-OF- GLASS U-VALUE (BTU/HR-SQFT-F)	GLASS VISIBLE TRANS
WF-1	1.0	180.00	1.00	2	3	0.00	45.00	4.00	0.490	0.900
DF-1	1.0	64.00	1.00	1	5	0.00	8.00	8.00	1.021	0.900

WINDOW	LOCATED IN SURFACE	LOCATION OF ORIGIN IN BUILDING COORDINATES			LOCATION OF ORIGIN IN SURFACE COORDINATES	
		XB (FT)	YB (FT)	ZB (FT)	X (FT)	Y (FT)
WF-1	FRONT-1	10.00	0.00	3.00	10.00	3.00
DF-1	FRONT-1	70.00	0.00	0.00	70.00	0.00

Page left intentionally blank

# REPORT LV-D

## DETAILS OF EXTERIOR SURFACES IN THE PROJECT

SIMPLE STRUCTURE RUN 3, CHICAGO      DIVIDE INTO ZONES; ADD PLENUM      DOE-2.1E-001 Thu Nov 4 15:19:02 1993LDL RUN 3  
 DESIGN-DAY SIZING OF VAV SYSTEM      SHOW ALL REPORTS  
 REPORT- LV-D DETAILS OF EXTERIOR SURFACES IN THE PROJECT      WEATHER FILE- TRY CHICAGO

---

NUMBER OF EXTERIOR SURFACES    9      RECTANGULAR    9      OTHER    0  
 (U-VALUE INCLUDES OUTSIDE AIR FILM; WINDOW INCLUDES FRAME, IF DEFINED)

SURFACE	SPACE	- - - W I N D O W S - - -		- - - - W A L L - - - -		- W A L L + W I N D O W S -		AZIMUTH
		U-VALUE (BTU/HR-SQFT-F)	AREA (SQFT)	U-VALUE (BTU/HR-SQFT-F)	AREA (SQFT)	U-VALUE (BTU/HR-SQFT-F)	AREA (SQFT)	
WALL-1PB	PLENUM-1	0.000	0.00	0.067	200.00	0.067	200.00	NORTH
BACK-1	SPACE3-1	0.565	229.00	0.067	571.00	0.210	800.00	NORTH
RIGHT-1	SPACE2-1	0.467	100.00	0.067	300.00	0.167	400.00	EAST
WALL-1PR	PLENUM-1	0.000	0.00	0.067	100.00	0.067	100.00	EAST
WALL-1PF	PLENUM-1	0.000	0.00	0.067	200.00	0.067	200.00	SOUTH
FRONT-1	SPACE1-1	0.587	244.00	0.067	556.00	0.226	800.00	SOUTH
WALL-1PL	PLENUM-1	0.000	0.00	0.067	100.00	0.067	100.00	WEST
LEFT-1	SPACE4-1	0.467	100.00	0.067	300.00	0.167	400.00	WEST
TOP-1	PLENUM-1	0.000	0.00	0.168	5000.00	0.168	5000.00	ROOF
F1-1	SPACE1-1	0.000	0.00	0.050	1056.00	0.050	1056.00	UNDERGRND
F2-1	SPACE2-1	0.000	0.00	0.050	456.00	0.050	456.00	UNDERGRND
F3-1	SPACE3-1	0.000	0.00	0.050	1056.00	0.050	1056.00	UNDERGRND
F4-1	SPACE4-1	0.000	0.00	0.050	456.00	0.050	456.00	UNDERGRND
F5-1	SPACE5-1	0.000	0.00	0.050	1976.00	0.050	1976.00	UNDERGRND

SIMPLE STRUCTURE RUN 3, CHICAGO  
 DESIGN-DAY SIZING OF VAV SYSTEM  
 REPORT- LV-D DETAILS OF EXTERIOR SURFACES IN THE PROJECT

DIVIDE INTO ZONES; ADD PLENUM  
 SHOW ALL REPORTS

DOE-2.1E-001 Thu Nov 4 15:19:02 1993LDL RUN 3

WEATHER FILE- TRY CHICAGO

----- (CONTINUED) -----

	AVERAGE U-VALUE/WINDOWS (BTU/HR-SQFT-F)	AVERAGE U-VALUE/WALLS (BTU/HR-SQFT-F)	AVERAGE U-VALUE WALLS+WINDOWS (BTU/HR-SQFT-F)	WINDOW AREA (SQFT)	WALL AREA (SQFT)	WINDOW+WALL AREA (SQFT)
NORTH	0.565	0.067	0.181	229.00	771.00	1000.00
EAST	0.467	0.067	0.147	100.00	400.00	500.00
SOUTH	0.587	0.067	0.194	244.00	756.00	1000.00
WEST	0.467	0.067	0.147	100.00	400.00	500.00
ROOF	0.000	0.168	0.168	0.00	5000.00	5000.00
ALL WALLS	0.544	0.067	0.174	673.00	2327.00	3000.00
WALLS+ROOFS	0.544	0.136	0.170	673.00	7327.00	8000.00
UNDERGRND	0.000	0.050	0.050	0.00	5000.00	5000.00
BUILDING	0.544	0.101	0.124	673.00	12327.00	13000.00

# REPORT LV-E

## DETAILS OF UNDERGROUND SURFACES IN THE PROJECT

SIMPLE STRUCTURE RUN 3, CHICAGO                      DIVIDE INTO ZONES; ADD PLENUM                      DOE-2.1E-001 Thu Nov 4 15:19:02 1993LDL RUN 3  
 DESIGN-DAY SIZING OF VAV SYSTEM                      SHOW ALL REPORTS  
 REPORT- LV-E DETAILS OF UNDERGROUND SURFACES IN THE PROJECT                      WEATHER FILE- TRY CHICAGO

---

NUMBER OF UNDERGROUND SURFACES 5

SURFACE NAME	MULTIPLIER	AREA (SQFT )	CONSTRUCTION NAME	U-VALUE (BTU/HR-SQFT-F)
F1-1	1.0	1056.00	FLOOR-1	0.050
F2-1	1.0	456.00	FLOOR-1	0.050
F3-1	1.0	1056.00	FLOOR-1	0.050
F4-1	1.0	456.00	FLOOR-1	0.050
F5-1	1.0	1976.00	FLOOR-1	0.050

# REPORT LV-F

## DETAILS OF INTERIOR SURFACES IN THE PROJECT

SIMPLE STRUCTURE RUN 3, CHICAGO                      DIVIDE INTO ZONES; ADD PLENUM                      DOE-2.1E-001 Thu Nov 4 15:19:02 1993LDD RUN 3  
 DESIGN-DAY SIZING OF VAV SYSTEM                      SHOW ALL REPORTS  
 REPORT- LV-F DETAILS OF INTERIOR SURFACES IN THE PROJECT                      WEATHER FILE- TRY CHICAGO

---

NUMBER OF INTERIOR SURFACES 13  
 (U-VALUE INCLUDES BOTH AIR FILMS)

SURFACE NAME	AREA (SQFT )	CONSTRUCTION NAME	SURFACE TYPE	U-VALUE (BTU/HR-SQFT-F)	ADJACENT SPACES	
					SPACE-1	SPACE-2
C1-1	1056.00	CLNG-1	QUICK STANDARD	0.270	SPACE1-1	PLENUM-1
SB12	135.76	SB-U	QUICK AIR	1.500	SPACE1-1	SPACE2-1
SB14	135.76	SB-U	QUICK AIR	1.500	SPACE1-1	SPACE4-1
SB15	608.00	SB-U	QUICK AIR	1.500	SPACE1-1	SPACE5-1
C2-1	456.00	CLNG-1	QUICK STANDARD	0.270	SPACE2-1	PLENUM-1
SB23	135.76	SB-U	QUICK AIR	1.500	SPACE2-1	SPACE3-1
SB25	208.00	SB-U	QUICK AIR	1.500	SPACE2-1	SPACE5-1
C3-1	1056.00	CLNG-1	QUICK STANDARD	0.270	SPACE3-1	PLENUM-1
SB34	135.80	SB-U	QUICK AIR	1.500	SPACE3-1	SPACE4-1
SB35	608.00	SB-U	QUICK AIR	1.500	SPACE3-1	SPACE5-1
C4-1	456.00	CLNG-1	QUICK STANDARD	0.270	SPACE4-1	PLENUM-1
SB45	208.00	SB-U	QUICK AIR	1.500	SPACE4-1	SPACE5-1
C5-1	1976.00	CLNG-1	QUICK STANDARD	0.270	SPACE5-1	PLENUM-1

# REPORT LV-G

## DETAILS OF SCHEDULES OCCURRING IN THE PROJECT

SIMPLE STRUCTURE RUN 3, CHICAGO                      DIVIDE INTO ZONES; ADD PLENUM                      DOE-2.1E-001 Thu Nov 4 15:19:02 1993LDL RUN 3  
 DESIGN-DAY SIZING OF VAV SYSTEM                      SHOW ALL REPORTS  
 REPORT- LV-G DETAILS OF SCHEDULES OCCURRING IN THE PROJECT                      WEATHER FILE- TRY CHICAGO

---

NUMBER OF SCHEDULES 5                      ( NON DIMENSIONLESS SCHEDULES ARE GIVEN IN ENGLISH UNITS )

### SCHEDULE OCCUPY-1

THROUGH 31 12

FOR DAYS SUN SAT HOL

HOUR	1	2	3	4	5	6	7	8	9	10	11	12	13	14	15	16	17	18	19	20	21	22	23	24
	0.00	0.00	0.00	0.00	0.00	0.00	0.00	0.00	0.00	0.00	0.00	0.00	0.00	0.00	0.00	0.00	0.00	0.00	0.00	0.00	0.00	0.00	0.00	0.00

FOR DAYS MON TUE WED THU FRI

HOUR	1	2	3	4	5	6	7	8	9	10	11	12	13	14	15	16	17	18	19	20	21	22	23	24
	0.00	0.00	0.00	0.00	0.00	0.00	0.00	0.00	1.00	1.00	1.00	0.80	0.40	0.80	1.00	1.00	1.00	1.00	0.50	0.10	0.10	0.00	0.00	0.00

### SCHEDULE LIGHTS-1

THROUGH 31 12

FOR DAYS SUN SAT HOL

HOUR	1	2	3	4	5	6	7	8	9	10	11	12	13	14	15	16	17	18	19	20	21	22	23	24
	0.05	0.05	0.05	0.05	0.05	0.05	0.05	0.05	0.05	0.05	0.05	0.05	0.05	0.05	0.05	0.05	0.05	0.05	0.05	0.05	0.05	0.05	0.05	0.05

FOR DAYS MON TUE WED THU FRI

HOUR	1	2	3	4	5	6	7	8	9	10	11	12	13	14	15	16	17	18	19	20	21	22	23	24
	0.05	0.05	0.05	0.05	0.05	0.05	0.05	0.05	0.90	0.95	1.00	0.95	0.80	0.90	1.00	1.00	1.00	1.00	0.60	0.20	0.20	0.05	0.05	0.05

### SCHEDULE EQUIP-1

THROUGH 31 12



FOR DAYS SUN SAT HOL

HOUR	1	2	3	4	5	6	7	8	9	10	11	12	13	14	15	16	17	18	19	20	21	22	23	24
	0.02	0.02	0.02	0.02	0.02	0.02	0.02	0.02	0.02	0.02	0.02	0.02	0.02	0.02	0.02	0.02	0.02	0.02	0.02	0.02	0.02	0.02	0.02	0.02

FOR DAYS MON TUE WED THU FRI

HOUR	1	2	3	4	5	6	7	8	9	10	11	12	13	14	15	16	17	18	19	20	21	22	23	24
	0.02	0.02	0.02	0.02	0.02	0.02	0.02	0.02	0.80	0.80	0.80	0.80	0.80	0.80	0.80	0.70	0.50	0.50	0.30	0.30	0.02	0.02	0.02	0.02

SCHEDULE INFIL-SCH

THROUGH 31 3

FOR DAYS SUN MON TUE WED THU FRI SAT HOL

HOUR	1	2	3	4	5	6	7	8	9	10	11	12	13	14	15	16	17	18	19	20	21	22	23	24
	1.00	1.00	1.00	1.00	1.00	1.00	1.00	1.00	1.00	1.00	1.00	1.00	1.00	1.00	1.00	1.00	1.00	1.00	1.00	1.00	1.00	1.00	1.00	1.00

THROUGH 31 10

FOR DAYS SUN MON TUE WED THU FRI SAT HOL

HOUR	1	2	3	4	5	6	7	8	9	10	11	12	13	14	15	16	17	18	19	20	21	22	23	24
	0.00	0.00	0.00	0.00	0.00	0.00	0.00	0.00	0.00	0.00	0.00	0.00	0.00	0.00	0.00	0.00	0.00	0.00	0.00	0.00	0.00	0.00	0.00	0.00

THROUGH 31 12

FOR DAYS SUN MON TUE WED THU FRI SAT HOL

HOUR	1	2	3	4	5	6	7	8	9	10	11	12	13	14	15	16	17	18	19	20	21	22	23	24
	1.00	1.00	1.00	1.00	1.00	1.00	1.00	1.00	1.00	1.00	1.00	1.00	1.00	1.00	1.00	1.00	1.00	1.00	1.00	1.00	1.00	1.00	1.00	1.00

SCHEDULE HR-SCH-1

THROUGH 4 8

SIMPLE STRUCTURE RUN 3, CHICAGO  
 DESIGN-DAY SIZING OF VAV SYSTEM  
 REPORT- LV-G DETAILS OF SCHEDULES OCCURRING IN THE PROJECT

DOE-2.1E-001 Thu Nov 4 15:19:02 1993LDL RUN 3

WEATHER FILE- TRY CHICAGO

(CONTINUED)

FOR DAYS SUN MON TUE WED THU FRI SAT HOL

HR	1	2	3	4	5	6	7	8	9	10	11	12	13	14	15	16	17	18	19	20	21	22	23	24
	0.00	0.00	0.00	0.00	0.00	0.00	0.00	0.00	0.00	0.00	0.00	0.00	0.00	0.00	0.00	0.00	0.00	0.00	0.00	0.00	0.00	0.00	0.00	0.00

THROUGH 5 8

FOR DAYS SUN MON TUE WED THU FRI SAT HOL

HR	1	2	3	4	5	6	7	8	9	10	11	12	13	14	15	16	17	18	19	20	21	22	23	24
	1.00	1.00	1.00	1.00	1.00	1.00	1.00	1.00	1.00	1.00	1.00	1.00	1.00	1.00	1.00	1.00	1.00	1.00	1.00	1.00	1.00	1.00	1.00	1.00

THROUGH 31 12

FOR DAYS SUN MON TUE WED THU FRI SAT HOL

HR	1	2	3	4	5	6	7	8	9	10	11	12	13	14	15	16	17	18	19	20	21	22	23	24
	0.00	0.00	0.00	0.00	0.00	0.00	0.00	0.00	0.00	0.00	0.00	0.00	0.00	0.00	0.00	0.00	0.00	0.00	0.00	0.00	0.00	0.00	0.00	0.00

# REPORT LV-H

## DETAILS OF WINDOWS OCCURRING IN THE PROJECT

SIMPLE STRUCTURE RUN 3, CHICAGO  
 DESIGN-DAY SIZING OF VAV SYSTEM  
 REPORT- LV-H DETAILS OF WINDOWS OCCURRING IN THE PROJECT

DIVIDE INTO ZONES; ADD PLENUM  
 SHOW ALL REPORTS

DOE-2.1E-001 Thu Nov 4 15:19:02 1993LDL RUN 3

WEATHER FILE- TRY CHICAGO

NUMBER OF WINDOWS 6      RECTANGULAR 6      OTHER 0

### RECTANGULAR WINDOWS (U-VALUES INCLUDE OUTSIDE AIR FILM)

WINDOW NAME	MULTIPLIER	GLASS AREA (SQFT)	GLASS HEIGHT (FT)	GLASS WIDTH (FT)	LOCATION OF ORIGIN IN SURFACE COORDINATES		FRAME AREA (SQFT)	FRAME U-VALUE (BTU/HR-SQFT-F)
					X (FT)	Y (FT)		
WF-1	1.0	180.00	4.00	45.00	10.00	3.00	0.00	0.384
DF-1	1.0	64.00	8.00	8.00	70.00	0.00	0.00	0.384
WR-1	1.0	100.00	4.00	25.00	12.50	3.00	0.00	0.384
WB-1	1.0	180.00	4.00	45.00	10.00	3.00	0.00	0.384
DB-1	1.0	49.00	7.00	7.00	70.00	0.00	0.00	0.384
WL-1	1.0	100.00	4.00	25.00	12.50	3.00	0.00	0.384

WINDOW NAME	SETBACK (FT)	X-DIVISIONS	GLASS SHADING COEFF	NUMBER OF PANES	GLASS TYPE CODE	INFILTRATION FLOW COEFF	CENTER-OF-GLASS U-VALUE (BTU/HR-SQFT-F)	GLASS VISIBLE TRANS
WF-1	0.00	10	1.00	2	3	0.0	0.490	0.900
DF-1	0.00	10	1.00	1	5	0.0	1.021	0.900
WR-1	0.00	10	1.00	2	3	0.0	0.490	0.900
WB-1	0.00	10	1.00	2	3	0.0	0.490	0.900
DB-1	0.00	10	1.00	1	5	0.0	1.021	0.900
WL-1	0.00	10	1.00	2	3	0.0	0.490	0.900

# REPORT LV-I

## DETAILS OF CONSTRUCTIONS OCCURRING IN THE PROJECT

SIMPLE STRUCTURE RUN 3, CHICAGO                      DIVIDE INTO ZONES; ADD PLENUM                      DOE-2.1E-001 Thu Nov 4 15:19:02 1993LDL RUN 3  
 DESIGN-DAY SIZING OF VAV SYSTEM                      SHOW ALL REPORTS  
 REPORT- LV-I DETAILS OF CONSTRUCTIONS OCCURRING IN THE PROJECT                      WEATHER FILE- TRY CHICAGO

---

NUMBER OF CONSTRUCTIONS    5                      DELAYED    2                      QUICK    3

CONSTRUCTION NAME	U-VALUE (BTU/HR-SQFT-F)	SURFACE ABSORPTANCE	SURFACE ROUGHNESS INDEX	SURFACE TYPE	NUMBER OF RESPONSE FACTORS
WALL-1	0.069	0.70	3	DELAYED	9
ROOF-1	0.180	0.70	3	DELAYED	5
CLNG-1	0.270	0.70	3	QUICK	0
SB-U	1.500	0.70	3	QUICK	0
FLOOR-1	0.050	0.70	3	QUICK	0

REPORT LV-J  
DETAILS OF BUILDING SHADES OCCURRING IN THE PROJECT

SIMPLE STRUCTURE RUN 3, CHICAGO            DIVIDE INTO ZONES; ADD PLENUM            DOE-2.1E-001 Thu Nov 4 15:19:02 1993LDEL RUN 3  
DESIGN-DAY SIZING OF VAV SYSTEM            SHOW ALL REPORTS  
REPORT- LV-J DETAILS OF BUILDING SHADES IN THE PROJECT            WEATHER FILE- TRY CHICAGO

---

NUMBER OF BUILDING SHADES    0            RECTANGULAR    0            OTHER    0

## REPORT LV-K WEIGHTING FACTOR SUMMARY

This report is automatically produced by a LIBRARY-INPUT LOADS run in which a Custom Weighting Factor library is created; it is also printed in an INPUT LOADS run if VERIFICATION = (LV-K) is specified in the LOADS-REPORT instruction. In the latter case, the entries in this report can be a combination of ASHRAE weighting factors, automatically calculated Custom Weighting Factors (for SPACES with FLOOR-WEIGHT = 0), and Custom Weighting Factors from a previously created user library.

At the top of the report is the u-name of each SPACE (SP NAME) along with the u-name of the set of weighting factors for that space (WF NAME). WF NAME will be blank except for library creation runs and for those SPACES in a LOADS run that use Custom Weighting Factors from a user library.

Down the left side of the report are six groupings of variable names that label the six types of weighting factors:

- solar
- general lighting
- task lighting
- people/equipment
- conduction
- air temperature

The weighting factors V0, V1, V2, W1, V2, G0\*, G1, G2, G3, P1, and P2 are defined in the *Engineers Manual (2.1A)*, p.II.67ff.

SIMPLE STRUCTURE RUN 3, CHICAGO  
 DESIGN-DAY SIZING OF VAV SYSTEM  
 REPORT- LV-K WEIGHTING FACTOR SUMMARY

DIVIDE INTO ZONES; ADD PLENUM  
 SHOW ALL REPORTS

Thu Nov 4 16:29:40 1993LDL RUN 3

SP NAME-- WF NAME--	PLENUM-1	SPACE1-1	SPACE2-1	SPACE3-1	SPACE4-1	SPACE5-1
<b>SOLAR</b>						
V0	0.50123	0.19700	0.19700	0.19700	0.19700	0.19700
V1	0.19470	-0.06700	-0.06700	-0.06700	-0.06700	-0.06700
V2	0.00000	0.00000	0.00000	0.00000	0.00000	0.00000
W1	0.30408	0.87000	0.87000	0.87000	0.87000	0.87000
W2	0.00000	0.00000	0.00000	0.00000	0.00000	0.00000
<b>GENERAL LIGHTING</b>						
V0	0.70580	0.59000	0.59000	0.59000	0.59000	0.59000
V1	-0.00988	-0.46000	-0.46000	-0.46000	-0.46000	-0.46000
V2	0.00000	0.00000	0.00000	0.00000	0.00000	0.00000
W1	0.30408	0.87000	0.87000	0.87000	0.87000	0.87000
W2	0.00000	0.00000	0.00000	0.00000	0.00000	0.00000
<b>TASK LIGHTING</b>						
V0	0.68697	0.50000	0.50000	0.50000	0.50000	0.50000
V1	0.00895	-0.37000	-0.37000	-0.37000	-0.37000	-0.37000
V2	0.00000	0.00000	0.00000	0.00000	0.00000	0.00000
W1	0.30408	0.87000	0.87000	0.87000	0.87000	0.87000
W2	0.00000	0.00000	0.00000	0.00000	0.00000	0.00000
<b>PEOPLE-EQUIPMENT</b>						
V0	0.80413	0.68100	0.68100	0.68100	0.68100	0.68100
V1	-0.10821	-0.55100	-0.55100	-0.55100	-0.55100	-0.55100
V2	0.00000	0.00000	0.00000	0.00000	0.00000	0.00000
W1	0.30408	0.87000	0.87000	0.87000	0.87000	0.87000
W2	0.00000	0.00000	0.00000	0.00000	0.00000	0.00000
<b>CONDUCTION</b>						
V0	0.80413	0.68100	0.68100	0.68100	0.68100	0.68100
V1	-0.10821	-0.55100	-0.55100	-0.55100	-0.55100	-0.55100
V2	0.00000	0.00000	0.00000	0.00000	0.00000	0.00000
W1	0.30408	0.87000	0.87000	0.87000	0.87000	0.87000
W2	0.00000	0.00000	0.00000	0.00000	0.00000	0.00000
<b>AIR TEMP (BTU/HR-SQFT-F )</b>						
G0*	1.11200	1.81000	1.81000	1.81000	1.81000	1.81000
G1*	-1.12493	-1.89000	-1.89000	-1.89000	-1.89000	-1.89000
G2*	0.01293	0.08000	0.08000	0.08000	0.08000	0.08000
G3*	0.00000	0.00000	0.00000	0.00000	0.00000	0.00000
P1	-0.30408	-0.87000	-0.87000	-0.87000	-0.87000	-0.87000
P2	0.00000	0.00000	0.00000	0.00000	0.00000	0.00000

## REPORT LV-L

### DAYLIGHT FACTOR SUMMARY

This report is printed for each combination of window and reference point in a daylit space. The first section of the report summarizes some of the daylighting-related input information for the space, window, and reference point. The second section lists the daylight factors which were calculated by the daylighting preprocessor for 20 values of solar altitude and azimuth covering the annual range of sun positions at the location being analyzed.

#### Section 1

##### Space-Related Quantities

1. SPACE  
is the u-name of space.
2. AREA  
is the floor area of space (before multiplication by space multiplier).
3. AV REFL  
is the area-weighted average inside surface visible reflectance of space, which is calculated from INSIDE-VIS-REFL values for EXTERIOR-WALL, INTERIOR-WALL, UNDERGROUND-FLOOR, UNDERGROUND-WALL, and WINDOW.
4. MAX-GLARE  
is the threshold for closing window shades to control glare (MAX-GLARE keyword value; defaults to 100, which means no glare control).
5. VW-AZ  
(view azimuth) is the azimuth angle, measured clockwise from north, of the occupant's direction of view; used to calculate the daylight glare index. It is entered (relative to the SPACE y-axis) with the VIEW-AZIMUTH keyword.

##### Window-Related Quantities

6. WINDOW  
is the window u-name.
7. SH-COEF  
is the shading coefficient of the glazing (1.0 if GLASS-TYPE-CODE $\leq$ 12).
8. VIS-TRANS  
is the visible transmittance of the window glazing at normal incidence.
9. H is the height of the glazing.
10. W is the width of the glazing.
11. AZIM and TILT  
are the azimuth and tilt angle, respectively, of the window outward normal in the building coordinate system. AZIM is measured clockwise from the building y-axis.
12. DAY-X-DIV and DAY-Y-DIV  
are the number of elements into which the window is divided along its WIDTH and HEIGHT, respectively, for the integration which determines the daylight reaching the reference point from the window. DAY-X-DIV and DAY-Y-DIV are automatically determined



by the program to insure an accurate integration.

13. X, Y, Z  
are the coordinates of the glazing origin in the space coordinate system. For vertical windows, Z is the sill height.
14. WIN-SHADE-TYPE  
is the type of shading device on the window, if any, as entered with the WIN-SHADE-TYPE keyword.

#### Reference Point-Related Quantities

15. REF PT NO.  
is the number of reference point (1 or 2)
16. X,Y,Z  
are the coordinates of reference point in the space coordinate system.
17. ZONE-FRACTION  
is the fraction of the space floor area controlled by the lighting system at this reference point (value of ZONE-FRACTION1 or ZONE-FRACTION2 keyword).
18. LTG-SET-POINT  
is the illuminance set point as entered with keyword LIGHT-SET-POINT1 for reference point 1, or with LIGHT-SET-POINT2 for reference point 2.
19. LTG-CTRL-TYPE  
is the lighting control type as entered with keyword LIGHT-CTRL-TYPE1 for reference point 1, or with or LIGHT-CTRL-TYPE2 for reference point 2.

## Section 2

### Calculated Daylight Factors

20. SUN POS NO.  
(sun position number) is the sun-position index corresponding to different pairs of solar altitude and azimuth values (see SUN ALT and SUN AZIM, below).
21. DAY TYP  
(day type) is 1 for clear sky and 2 for overcast sky. For the latter, the daylight factors for only one sun position are calculated.
22. WIN SHD IND  
(window shade index) is 1 for bare window (shading device off), and 2 for window with shading device on. Visible transmittance of shade is taken to be 1.0 for daylight factor calculation.
23. SUN ALT  
is the altitude of sun above the horizon. It has four equally-spaced values ranging from 10° to the maximum altitude the sun can reach at the location being analyzed.
24. SUN AZIM  
is the azimuth of sun measured clockwise from North.

25. EXT ILL -SKY  
is the exterior horizontal illuminance due to diffuse light from sky (excludes direct sun).
26. EXT ILL -SUN  
is the exterior horizontal illuminance due to direct sun.
27. EXT ILL -SKY and EXT ILL -SUN  
are calculated for standard CIE skies using, for clear sky, the atmospheric turbidity and moisture for the month of May.

The following quantities relate to the interior of the space. For WIN SHD IND = 2 (window with shade), the shade is assumed to have 100% transmittance; the actual shade transmittance is taken into account in the hourly loads calculation.

28. DIR ILL -SKY  
(direct illuminance -sky) is the direct horizontal illuminance at the reference point produced by light which originates in the sky and reaches the reference point without reflection from the interior surfaces of the space. For an unshaded window (WIN SHD IND = 1), this includes the light coming directly from the sky or by reflection of sky light from exterior BUILDING-SHADES. For a window with shade (WIN SHD IND = 2 and WIN-SHADE-TYPE other than NO-SHADE), the light source is the shade itself, a diffusely transmitting surface illuminated by direct light from the sky, sky light reflected from the ground, and sky light reflected from exterior obstructions.
29. REFL ILL -SKY  
(reflected illuminance -sky) is the illuminance at the reference point produced by daylight which originates in the sky and reaches the reference point after reflecting from the interior surfaces of the space.
30. DIR ILL -SUN  
(direct illuminance -sun): for an unshaded window (WIN SHD IND = 1), this is the direct horizontal illuminance at the reference point produced by light from the sun reaching the reference point without reflection from the interior surfaces of the space. For a window with shade (WIN SHD IND = 2), the light source is the shade illuminated by direct sunlight and by sunlight reflected by the ground and exterior obstructions.
31. REFL ILL -SUN  
(reflected illuminance -sun) is the indirect horizontal illuminance at the reference point produced by sunlight which reflects from interior surfaces before reaching the reference point.
32. DAY ILL FAC -SKY  
(daylight illuminance factor -sky) is the ratio  
 $(DIR ILL -SKY + REFL ILL -SKY)/(EXT ILL -SKY)$ .
33. DAY ILL FAC -SUN  
(daylight illuminance factor -sun) is the ratio  
 $(DIR ILL -SUN + REFL ILL -SUN)/(EXT ILL -SUN)$ .
34. WIN LUM FAC -SKY  
(window luminance factor -sky) is the average luminance of the window (as seen from the reference point) due to light originating in the sky, divided by EXT ILL -SKY. It has units footlamberts/footcandle (English) or candelas/m<sup>2</sup>/lux (metric).

35. WIN LUM FAC -SUN  
(window luminance factor -sun) is the ratio between the average luminance of the window (as seen from the reference point) due to light originating at the sun, divided by EXT ILL -SUN. This quantity is not calculated for an unshaded window.
36. BACKG LUM FAC -SKY  
(background luminance factor -sky) is the average luminance of interior surfaces due to light originating in the sky, divided by EXT ILL -SKY. It has units footlamberts/footcandle (English) or candelas/m<sup>2</sup>/lux (metric).
37. BACKG LUM FAC -SUN  
(background luminance factor -sun) is the average luminance of interior surfaces due to light originating at the sun, divided by EXT ILL -SUN.
38. GLARE INDEX  
is the daylight glare index at the reference point due to this window. (It assumes 100% shade transmittance for a shaded window (WIN SHD IND = 2). The actual glare index in the hourly calculation will generally be lower for shade transmittance < 100%.)

DAYLIGHTING EXAMPLE

FLOOR OF OFFICE BUILDING IN CHICAGO

Fri Oct 15 15:57:42 1993LDDL RUN 1

30-FT DEEP PERIM OFFS DAYLIT TO 15 FT AUTO SHADE MANAGEMENT FOR SUN CONTROL  
 REPORT- LV-L DAYLIGHT FACTOR SUMMARY FOR SOUTHZONE

SPACE--SOUTHZONE WINDOW--SOUTHWIND REF PT NO.--1  
 AREA (SQFT) 600.0 SC 0.83 GTC 1 VIS-TRANS 0.68 X(FT) 10.0 Y(FT) 10.0 Z(FT) 2.5  
 AV REFL 0.46 H(FT) 3.0 W(FT) 20.0 ZONE-FRACTION 0.50  
 MAX-GLARE 100.0 AZIM(DEG) 180.0 TILT(DEG) 90.0 LTG-SET-POINT(FC) 50.0  
 VW-AZ(DEG) 270.0 DAY-X-DIV 8 DAY-Y-DIV 8 LTG-CTRL-TYPE CONTINUOUS  
 X(FT) 0.0 Y(FT) 0.0 Z(FT) 4.0  
 WIN-SHADE-TYPE MOVABLE-INTERIOR

SUN	WIN	SUN	SUN	EXT	EXT	DIR	REFL	DIR	REFL	DAY	DAY	WIN	WIN	BACKG	BACKG		
POS	DAY	SHD	ALT	ILL	ILL	ILL	ILL	ILL	ILL	ILL	ILL	LUM	LUM	LUM	LUM		
NO.	TYP	IND	(DEG)	(FC)	(FC)	(FC)	(FC)	(FC)	(FC)	(FC)	(FC)	(FC)	(FC)	(FC)	(FC)	GLARE	
				(FC)	(FC)	(FC)	(FC)	(FC)	(FC)	(FC)	(FC)	(FC)	(FC)	(FC)	(FC)	INDEX	
1	1	1	10.	290.	1331.8	164.6	43.1	14.3	0.0	0.5	0.0431	0.0029	1.1282	0.0000	0.0050	0.0013	13.7
1	1	2	10.	290.	1331.8	164.6	23.2	18.1	0.5	0.4	0.0311	0.0050	0.5635	0.0909	0.0063	0.0010	10.9
1	2	1	10.	290.	366.9	0.0	7.5	3.2	0.0	0.0	0.0291	0.0000	0.6355	0.0000	0.0041	0.0000	4.9
1	2	2	10.	290.	366.9	0.0	5.1	4.0	0.0	0.0	0.0246	0.0000	0.4461	0.0000	0.0050	0.0000	2.9
2	1	1	10.	235.	1331.8	164.6	90.7	25.7	0.0	8.8	0.0874	0.0535	2.5584	0.0000	0.0089	0.0248	16.5
2	1	2	10.	235.	1331.8	164.6	44.5	34.8	16.0	12.5	0.0595	0.1731	1.0793	3.1409	0.0121	0.0352	14.6
3	1	1	10.	180.	1331.8	164.6	197.8	36.4	164.1	15.9	0.1758	1.0938	4.4036	0.0000	0.0126	0.0448	18.1
3	1	2	10.	180.	1331.8	164.6	64.3	50.3	29.3	22.9	0.0860	0.3167	1.5609	5.7454	0.0175	0.0643	15.8
4	1	1	10.	125.	1331.8	164.6	90.7	25.7	0.0	8.8	0.0874	0.0535	2.5584	0.0000	0.0089	0.0248	16.5
4	1	2	10.	125.	1331.8	164.6	44.5	34.8	16.0	12.5	0.0595	0.1731	1.0793	3.1409	0.0121	0.0352	14.6
5	1	1	10.	70.	1331.8	164.6	43.1	14.3	0.0	0.5	0.0431	0.0029	1.1282	0.0000	0.0050	0.0013	13.7
5	1	2	10.	70.	1331.8	164.6	23.2	18.1	0.5	0.4	0.0311	0.0050	0.5635	0.0909	0.0063	0.0010	10.9
6	1	1	31.	290.	2104.9	2160.2	57.2	20.2	0.0	6.2	0.0367	0.0029	0.9412	0.0000	0.0044	0.0013	14.7
6	1	2	31.	290.	2104.9	2160.2	32.2	25.2	6.1	4.7	0.0273	0.0050	0.4949	0.0909	0.0055	0.0010	12.9
7	1	1	31.	235.	2104.9	2160.2	115.1	34.5	0.0	37.7	0.0711	0.0175	1.9308	0.0000	0.0076	0.0081	16.8
7	1	2	31.	235.	2104.9	2160.2	58.8	46.0	64.7	50.6	0.0498	0.0534	0.9034	0.9679	0.0101	0.0108	16.5
8	1	1	31.	180.	2104.9	2160.2	229.9	47.0	0.0	66.1	0.1316	0.0306	3.1907	0.0000	0.0103	0.0142	18.2
8	1	2	31.	180.	2104.9	2160.2	82.1	64.2	117.5	91.8	0.0695	0.0969	1.2605	1.7581	0.0141	0.0197	17.8
9	1	1	31.	125.	2104.9	2160.2	115.1	34.5	0.0	37.7	0.0711	0.0175	1.9308	0.0000	0.0076	0.0081	16.8
9	1	2	31.	125.	2104.9	2160.2	58.8	46.0	64.7	50.6	0.0498	0.0534	0.9034	0.9679	0.0101	0.0108	16.5
10	1	1	31.	70.	2104.9	2160.2	57.2	20.2	0.0	6.2	0.0367	0.0029	0.9412	0.0000	0.0044	0.0013	14.7
10	1	2	31.	70.	2104.9	2160.2	32.2	25.2	6.1	4.7	0.0273	0.0050	0.4949	0.0909	0.0055	0.0010	12.9
11	1	1	51.	290.	2565.4	4622.3	62.4	23.1	0.0	13.3	0.0333	0.0029	0.8317	0.0000	0.0042	0.0013	14.9
11	1	2	51.	290.	2565.4	4622.3	36.4	28.4	13.0	10.2	0.0253	0.0050	0.4585	0.0909	0.0051	0.0010	13.9
12	1	1	51.	235.	2565.4	4622.3	99.4	33.4	0.0	41.3	0.0518	0.0089	1.2972	0.0000	0.0060	0.0041	16.1
12	1	2	51.	235.	2565.4	4622.3	55.7	43.5	65.1	50.9	0.0387	0.0251	0.7013	0.4550	0.0079	0.0051	16.5
13	1	1	51.	180.	2565.4	4622.3	145.2	41.7	0.0	72.7	0.0729	0.0157	1.7541	0.0000	0.0075	0.0073	16.8
13	1	2	51.	180.	2565.4	4622.3	71.2	55.6	123.6	96.6	0.0494	0.0477	0.8964	0.8645	0.0100	0.0097	17.7
14	1	1	51.	125.	2565.4	4622.3	99.4	33.4	0.0	41.3	0.0518	0.0089	1.2972	0.0000	0.0060	0.0041	16.1
14	1	2	51.	125.	2565.4	4622.3	55.7	43.5	65.1	50.9	0.0387	0.0251	0.7013	0.4550	0.0079	0.0051	16.5
15	1	1	51.	70.	2565.4	4622.3	62.4	23.1	0.0	13.3	0.0333	0.0029	0.8317	0.0000	0.0042	0.0013	14.9
15	1	2	51.	70.	2565.4	4622.3	36.4	28.4	13.0	10.2	0.0253	0.0050	0.4585	0.0909	0.0051	0.0010	13.9
16	1	1	72.	290.	3143.7	6245.4	74.3	28.0	0.0	18.0	0.0325	0.0029	0.7923	0.0000	0.0041	0.0013	15.5
16	1	2	72.	290.	3143.7	6245.4	44.1	34.5	17.6	13.7	0.0250	0.0050	0.4534	0.0909	0.0051	0.0010	14.7
17	1	1	72.	235.	3143.7	6245.4	91.7	33.3	0.0	27.8	0.0398	0.0044	0.9617	0.0000	0.0049	0.0021	16.0
17	1	2	72.	235.	3143.7	6245.4	54.0	42.2	35.7	27.9	0.0306	0.0102	0.5556	0.1850	0.0062	0.0021	15.7
18	1	1	72.	180.	3143.7	6245.4	105.0	36.8	0.0	43.2	0.0451	0.0069	1.0806	0.0000	0.0054	0.0032	16.1
18	1	2	72.	180.	3143.7	6245.4	60.6	47.3	64.4	50.3	0.0343	0.0184	0.6226	0.3333	0.0070	0.0037	16.6
19	1	1	72.	125.	3143.7	6245.4	91.7	33.3	0.0	27.8	0.0398	0.0044	0.9617	0.0000	0.0049	0.0021	16.0
19	1	2	72.	125.	3143.7	6245.4	54.0	42.2	35.7	27.9	0.0306	0.0102	0.5556	0.1850	0.0062	0.0021	15.7
20	1	1	72.	70.	3143.7	6245.4	74.3	28.0	0.0	18.0	0.0325	0.0029	0.7923	0.0000	0.0041	0.0013	15.5
20	1	2	72.	70.	3143.7	6245.4	44.1	34.5	17.6	13.7	0.0250	0.0050	0.4534	0.0909	0.0051	0.0010	14.7

NOTE -- ABOVE VALUES ASSUME VISIBLE TRANSMITTANCE = 1.0 FOR WINDOW GLASS AND SHADING DEVICE.  
 ACTUAL TRANSMITTANCES ARE USED IN THE HOURLY CALCULATION.

Page left intentionally blank

# REPORT LV-M

## DOE-2 ENGLISH/METRIC CONVERSION TABLE

DOE-2 UNITS TABLE

	ENGLISH	MULTIPLIED BY	GIVES	METRIC	MULTIPLIED BY	GIVES	ENGLISH
1			1.000000			1.000000	
2			1.000000			1.000000	
3	BTU		0.293000	WH		3.412969	BTU
4	BTU/HR		0.293000	WATT		3.412969	BTU/HR
5	BTU/LB-F	4183.830078	0.830078	J/KG-K		0.000239	BTU/LB-F
6	BTU/HR-SQFT-F		5.674460	W/M2-K		0.176228	BTU/HR-SQFT-F
7	DEGREES		1.000000	DEGREES		1.000000	DEGREES
9	SQFT		0.092903	M2		10.763915	SQFT
10	CUFT		0.028317	M3		35.314724	CUFT
11	LB/HR		0.453592	KG/HR		2.204624	LB/HR
12	LB/CUFT		16.018459	KG/M3		0.062428	LB/CUFT
13	MPH		0.447040	M/S		2.236936	MPH
14	BTU/HR-F		0.527178	W/K		1.896893	BTU/HR-F
15	FT		0.304800	M		3.280840	FT
16	BTU/HR-FT-F		1.729600	W/M-K		0.578168	BTU/HR-FT-F
17	BTU/HR- SQFT		3.152480	WATT /M2		0.317211	BTU/HR- SQFT
18	IN		2.540000	CM		0.393701	IN
19	UNITS/IN		0.393700	UNITS/CM		2.540005	UNITS/IN
20	UNITS		1.000000	UNITS		1.000000	UNITS
21	LB		0.453592	KG		2.204624	LB
22	FRAC.OR MULT.		1.000000	FRAC.OR MULT.		1.000000	FRAC.OR MULT.
23	HOURS		1.000000	HRS		1.000000	HOURS
24	PERCENT-RH		1.000000	PERCENT-RH		1.000000	PERCENT-RH
25	CFM		1.699010	M3/H		0.588578	CFM
26	IN-WATER		25.400000	MM-WATER		0.039370	IN-WATER
27	LB/SQFT		4.882400	KG/M2		0.204817	LB/SQFT
28	KW		1.000000	KW		1.000000	KW
29	W/SQFT		10.763920	W/M2		0.092903	W/SQFT
30	THERMS		25.000000	THERMIES		0.040000	THERMS
31	KNOTS		0.514440	M/SEC		1.943861	KNOTS
32	HR-SQFT-F /BTU		0.176228	M2-K /W		5.674467	HR-SQFT-F /BTU
33	\$DOLLARS		1.000000	\$DOLLARS		1.000000	\$DOLLARS
34	MBTU/HR		0.293000	MWATT		3.412969	MBTU/HR
35	YEARS		1.000000	YEARS		1.000000	YEARS
36	\$/HR		1.000000	\$/HR		1.000000	\$/HR
37	HRS/YEARS		1.000000	HRS/YEARS		1.000000	HRS/YEARS
38	PERCENT		1.000000	PERCENT		1.000000	PERCENT
39	\$/MONTH		1.000000	\$/MONTH		1.000000	\$/MONTH
40	GALLONS/MIN/TON		1.078000	LITERS/MIN/KW		0.927644	GALLONS/MIN/TON
41	BTU/LB		0.645683	WH/KG		1.548748	BTU/LB
42	LBS/SQIN-GAGE		68.947571	MBAR-GAGE		0.014504	LBS/SQIN-GAGE
43	\$/UNIT		1.000000	\$/UNIT		1.000000	\$/UNIT
44	BTU/HR/PERSON		0.293000	W/PERSON		3.412969	BTU/HR/PERSON
45	LBS/LB		1.000000	KGS/KG		1.000000	LBS/LB
46	BTU/BTU		1.000000	KWH/KWH		1.000000	BTU/BTU
47	LBS/KW		0.453590	KG/KW		2.204634	LBS/KW
48	REV/MIN		1.000000	REV/MIN		1.000000	REV/MIN
49	KW/TON		1.000000	KW/TON		1.000000	KW/TON
50	MBTU		0.293000	MWH		3.412969	MBTU
51	GAL		3.785410	LITER		0.264172	GAL
52	GAL/MIN		3.785410	LITERS/MIN		0.264172	GAL/MIN
53	BTU/F		1897.800049	J/K		0.000527	BTU/F

54	UNITS/HR	1.000000	UNITS/HR	1.000000	UNITS/HR
55	\$/UNIT-HR	1.000000	\$/UNIT-HR	1.000000	\$/UNIT-HR
56	KW/CFM	0.588500	KW/M3/HR	1.699235	KW/CFM
57	BTU/SQFT-F	20428.400391	J/M2-K	0.000049	BTU/SQFT-F
58	HR/HR	1.000000	HR/HR	1.000000	HR/HR
59	BTU/FT-F	6226.479980	J/M-K	0.000161	BTU/FT-F
60	R	0.555556	K	1.799999	R
61	INCH MER	33.863800	MBAR	0.029530	INCH MER
62	UNITS/GAL/MIN	0.264170	UNITS/LITER/MIN	3.785441	UNITS/GAL/MIN
63	(HR-SQFT-F/BTU) 2	0.031056	(M2-K /W) 2	32.199585	(HR-SQFT-F/BTU) 2
64	KBTU/HR	0.293000	KW	3.412969	KBTU/HR
65	KBTU	0.293000	KWH	3.412969	KBTU
66	CFM	0.471900	L/S	2.119093	CFM
67	CFM/SQFT	18.288000	M3/H-M2	0.054681	CFM/SQFT
68	1/R	1.799900	1/R	0.555586	1/R
69	1/KNOT	1.943860	SEC/M	0.514440	1/KNOT
70	FOOTCANDLES	10.763910	LUX	0.092903	FOOTCANDLES
71	FOOTLAMBERT	3.426259	CANDELA/M2	0.291864	FOOTLAMBERT
72	LUMEN / WATT	1.000000	LUMEN / WATT	1.000000	LUMEN / WATT
73	KBTU/SQFT-YR	3.152480	KWH/M2-YR	0.317211	KBTU/SQFT-YR

## REPORT LS-A SPACE PEAK LOADS SUMMARY

This report lists each space by u-name and shows the number of times each space is repeated (based on the keywords MULTIPLIER and FLOOR-MULTIPLIER) on the left of the report.

The individual space peak sensible cooling load with the month, day and hour it occurred is reported in the center. The sum of the cooling loads for all spaces (which is the non-coincident building peak load) is also reported.

The *coincident* building peak cooling load (the "block" load) is reported directly below the non-coincident peak, but it does not include the plenum load. The outside dry-bulb and wet-bulb temperatures are also reported for the time of the peak load in each space and for the building. All hours are given in *standard time*.

The heating peak loads are treated similarly on the right.

A "load" here is defined as the amount of heat that must be added or removed from the space air per hour to maintain a *constant* air temperature equal to the TEMPERATURE keyword value in SPACE-CONDITIONS. These loads are modified in the SYSTEMS program to account for time-varying air temperatures.



SIMPLE STRUCTURE RUN 3, CHICAGO  
 DESIGN-DAY SIZING OF VAV SYSTEM  
 REPORT- LS-A SPACE PEAK LOADS SUMMARY

DIVIDE INTO ZONES; ADD PLENUM  
 SHOW ALL REPORTS

DOE-2.1E-001 Thu Nov 4 15:19:02 1993LDL RUN 3

WEATHER FILE- TRY CHICAGO

SPACE NAME	MULTIPLIER SPACE FLOOR	COOLING LOAD (KBTU/HR)	TIME OF PEAK	DRY- BULB	WET- BULB	HEATING LOAD (KBTU/HR)	TIME OF PEAK	DRY- BULB	WET- BULB
PLENUM-1	1. 1.	71.342	JUL 7 4 PM	90.F	72.F	-72.382	JAN 12 8 AM	-7.F	-7.F
SPACE1-1	1. 1.	33.718	NOV 8 3 PM	60.F	49.F	-14.429	JAN 12 8 AM	-7.F	-7.F
SPACE2-1	1. 1.	13.418	AUG 30 12 NOON	75.F	60.F	-5.455	JAN 7 5 AM	2.F	2.F
SPACE3-1	1. 1.	20.153	JUL 9 4 PM	94.F	74.F	-14.299	JAN 1 4 AM	3.F	2.F
SPACE4-1	1. 1.	11.901	JUN 27 7 PM	77.F	61.F	-5.834	JAN 12 8 AM	-7.F	-7.F
SPACE5-1	1. 1.	15.332	AUG 30 3 PM	82.F	64.F	-7.166	MAR 24 4 AM	12.F	11.F
SUM		165.863				-119.564			
BUILDING PEAK		80.443	AUG 19 6 PM	90.F	71.F	-44.428	MAR 24 6 AM	8.F	7.F

## REPORT LS-B

### SPACE PEAK LOAD COMPONENTS

This report gives a breakdown of cooling and heating peak loads, according to the source of the load, for each space. A "load" here is defined as the amount of heat that must be added or removed from the space air per hour to maintain a *constant* air temperature equal to the TEMPERATURE keyword value in SPACE-CONDITIONS. These loads are modified in the SYSTEMS program to account for time-varying air temperatures.

1. WALL CONDUCTION

is the load due to conduction through exterior walls ( $TILT \geq 45^\circ$ ).

2. ROOF CONDUCTION

is the load due to conduction through roof sections (exterior walls with  $TILT < 45^\circ$ ).

3. WINDOW GLASS+FRM COND

is the load due to  $UA\Delta T$  heat gain through all the exterior windows (glass plus frames) *plus* solar energy absorbed by the glass and frames and conducted into the space.

4. WINDOW GLASS SOLAR

is the load caused by direct and diffuse solar radiation transmitted by the window glass into the space. Note that all sensible loads are calculated as *delayed in time with weighting factors* so that it is possible to have load contributions from WINDOW GLASS SOLAR at night.

5. DOOR CONDUCTION

is the load due to conduction through external doors in the space.

6. INTERNAL SURFACE COND

is the load due to conduction through INTERIOR-WALLS such as partitions and drop ceilings. These loads will be zero in this report if you choose the same LOADS calculation temperature for all spaces.

7. UNDERGROUND SURF COND

is the load due to conduction through basement floors and walls or slabs on grade.

8. The next five entries are the loads due to

*occupants*

(resulting from user-supplied entries for keywords PEOPLE-SCHEDULE, NUMBER-OF-PEOPLE, AREA-PERSON, and PEOPLE-HEAT-GAIN),

*electric lighting*

(keywords LIGHTING-SCHEDULE, LIGHTING-TYPE, LIGHTING-W/SQFT, TASK-LT-W/SQFT, etc.),

*equipment*

(keywords EQUIP-SCHEDULE, EQUIPMENT-W/SQFT, etc.),

*process*

(keywords SOURCE-SCHEDULE, SOURCE-TYPE, SOURCE-BTU/HR, etc.), and

*infiltration of outside air*

(keywords INF-SCHEDULE, INF-METHOD, AIR-CHANGES/HR, etc.).

9. The RUN number in the upper right hand corner refers to the number of the pass through the LOADS program. For example, if you were doing parametric runs as part of the same job, successive passes through LOADS would be recorded as RUN 1, RUN 2, RUN 3, etc.

SPACE SPACE1-1

MULTIPLIER 1.0 FLOOR MULTIPLIER 1.0  
 FLOOR AREA 1056 SQFT 98 M2  
 VOLUME 8448 CUFT 239 M3

TIME	COOLING LOAD		HEATING LOAD	
	NOV 8	3PM	JAN 12	8AM
DRY-BULB TEMP	60F	16C	-7F	-22C
WET-BULB TEMP	49F	9C	-7F	-22C

	SENSIBLE		LATENT		SENSIBLE	
	(KBTU/H)	( KW )	(KBTU/H)	( KW )	(KBTU/H)	( KW )
WALL CONDUCTION	1.700	0.498	0.000	0.000	-2.726	-0.799
ROOF CONDUCTION	0.000	0.000	0.000	0.000	0.000	0.000
WINDOW GLASS+FRM COND	1.936	0.567	0.000	0.000	-9.976	-2.923
WINDOW GLASS SOLAR	22.696	6.650	0.000	0.000	0.775	0.227
DOOR CONDUCTION	0.000	0.000	0.000	0.000	0.000	0.000
INTERNAL SURFACE COND	0.000	0.000	0.000	0.000	0.000	0.000
UNDERGROUND SURF COND	-0.950	-0.278	0.000	0.000	-1.584	-0.464
OCCUPANTS TO SPACE	2.335	0.684	1.433	0.420	0.120	0.035
LIGHT TO SPACE	3.598	1.054	0.000	0.000	0.464	0.136
EQUIPMENT TO SPACE	2.538	0.744	0.000	0.000	0.188	0.055
PROCESS TO SPACE	0.000	0.000	0.000	0.000	0.000	0.000
INFILTRATION	-0.136	-0.040	0.000	0.000	-1.689	-0.495
<b>TOTAL</b>	<b>33.718</b>	<b>9.879</b>	<b>1.433</b>	<b>0.420</b>	<b>-14.429</b>	<b>-4.228</b>
<b>TOTAL LOAD</b>	<b>35.151 KBTU/H</b>		<b>10.299 KW</b>		<b>-14.429 KBTU/H</b>	<b>-4.228 KW</b>
<b>TOTAL LOAD / AREA</b>	<b>33.29BTU/H.SQFT</b>		<b>104.981 W / M2</b>		<b>13.664BTU/H.SQFT</b>	<b>43.093 W / M2</b>

```

*****
*
* NOTE 1)THE ABOVE LOADS EXCLUDE OUTSIDE VENTILATION AIR
* ---- LOADS
* 2)TIMES GIVEN IN STANDARD TIME FOR THE LOCATION
* IN CONSIDERATION
*
*****

```

## REPORT LS-C

### BUILDING PEAK LOAD COMPONENTS

This report is similar in format to LS-B. The major difference is that LS-C is generated at the "building level", i.e., the space loads are summed each hour to give the building coincident load and the peak values of this load are shown here.

"Floor area" in this report is that of conditioned spaces only (ZONE-TYPE=CONDITIONED); it *excludes* plenums and other unconditioned spaces (ZONE-TYPE=PLENUM or UNCONDITIONED). "Volume" is that of conditioned spaces and plenums; it *excludes* ZONE-TYPE = UNCONDITIONED.

The building coincident peak load does not include plenums (ZONE-TYPE=PLENUM) or other unconditioned spaces (ZONE-TYPE=UNCONDITIONED).

Although no infiltration is indicated for the peak cooling load in this example, the user should realize how DOE-2 treats infiltration loads. The sensible portion is treated as an instantaneous heat gain or loss. The latent portion is reported in LOADS, but is passed to SYSTEMS as a CFM with the calculated humidity ratio for each hour. The contribution of the latent heat (negative or positive in relation to room humidity) is then calculated from a mass balance of moisture in the space, to determine the return air humidity ratio. In dry climates the infiltration may actually result in a decreased space latent load and thus a decreased total SYSTEMS load. The opposite is true in humid climates where infiltration acts to increase the SYSTEMS load.

The heat gain or loss that occurs in plenums, including heat due to lights, is accounted for in the SYSTEMS simulation and causes a temperature change in the return air flowing through the plenum. Therefore, you should **not** specify plenums unless they are actually return air plenums. Unconditioned, non-return-air spaces should be specified in the SPACE command with ZONE-TYPE = UNCONDITIONED.

\*\*\* BUILDING \*\*\*

FLOOR AREA 5000 SQFT 465 SQMT  
 VOLUME 50000 CUFT 1416 CUMT

TIME	COOLING LOAD		HEATING LOAD	
	AUG 19	6PM	MAR 24	6AM
DRY-BULB TEMP	90F	32C	8F	-13C
WET-BULB TEMP	71F	22C	7F	-14C

	SENSIBLE		LATENT		SENSIBLE	
	(KBTU/H)	( KW )	(KBTU/H)	( KW )	(KBTU/H)	( KW )
WALL CONDUCTION	4.297	1.259	0.000	0.000	-6.888	-2.018
ROOF CONDUCTION	0.000	0.000	0.000	0.000	0.000	0.000
WINDOW GLASS+FRM COND	8.963	2.626	0.000	0.000	-22.096	-6.474
WINDOW GLASS SOLAR	29.977	8.783	0.000	0.000	1.992	0.584
DOOR CONDUCTION	0.000	0.000	0.000	0.000	0.000	0.000
INTERNAL SURFACE COND	0.000	0.000	0.000	0.000	0.000	0.000
UNDERGROUND SURF COND	-1.000	-0.293	0.000	0.000	-7.750	-2.271
OCCUPANTS TO SPACE	11.607	3.401	6.776	1.985	0.026	0.008
LIGHT TO SPACE	17.920	5.251	0.000	0.000	1.079	0.316
EQUIPMENT TO SPACE	8.679	2.543	0.000	0.000	0.367	0.107
PROCESS TO SPACE	0.000	0.000	0.000	0.000	0.000	0.000
INFILTRATION	0.000	0.000	0.000	0.000	-11.157	-3.269
<b>TOTAL</b>	<b>80.443</b>	<b>23.570</b>	<b>6.776</b>	<b>1.985</b>	<b>-44.428</b>	<b>-13.017</b>
<b>TOTAL LOAD</b>	<b>87.218 KBTU/H</b>		<b>25.555 KW</b>		<b>-44.428 KBTU/H</b>	<b>-13.017 KW</b>
<b>TOTAL LOAD / AREA</b>	<b>17.44BTU/H.SQFT</b>		<b>55.014 W /SQMT</b>		<b>8.886BTU/H.SQFT</b>	<b>28.023 W /SQMT</b>

\*\*\*\*\*  
 \*  
 \* NOTE 1)THE ABOVE LOADS EXCLUDE OUTSIDE VENTILATION AIR  
 \* ---- LOADS  
 \* 2)TIMES GIVEN IN STANDARD TIME FOR THE LOCATION  
 \* IN CONSIDERATION  
 \*  
 \*\*\*\*\*

**REPORT LS-D**  
**BUILDING MONTHLY LOADS SUMMARY**

This report gives a summary of monthly cooling, heating, and electrical requirements plus annual total energy requirements and maximum monthly peak loads. Unconditioned spaces (ZONE-TYPE = UNCONDITIONED or PLENUM) are not included in this report's monthly load.

Once again, you should be aware that these loads are based on a constant temperature within each SPACE (that is, no setback, no floating, and no other temperature variations within the SPACE). Additionally, these loads do not account for conditioning of outside ventilation air. Later, in SYSTEMS, these items will be accounted for.

1. COOLING, HEATING, and ELEC  
are the three sections of this building level report.
2. COOLING ENERGY  
(millions of Btu) is the monthly sensible cooling load for all SPACES in the building.
3. MAXIMUM COOLING LOAD  
(thousands of Btu/hr) is the peak sensible space cooling load. To the left of this column are the day and hour of the peak cooling load along with the outside dry-bulb and wet-bulb temperatures at the time of the peak.
4. HEATING ENERGY  
(millions of Btu) is the monthly heating load.
5. MAXIMUM HEATING LOAD  
(thousands of Btu/hr) is the peak space heating load. To the left of this column are the day and hour of the peak heating load along with the outside dry-bulb and wet-bulb temperatures at the time of the peak.
6. ELECTRICAL ENERGY (kWh)  
is the monthly electrical consumption for lights, convenience outlets, and non-HVAC equipment.
7. MAXIMUM ELEC LOAD (kW)  
is the monthly peak electrical consumption in a one-hour period for lights, convenience outlets, and miscellaneous equipment input as SOURCE.
8. TOTAL  
is the annual total for the cooling load, heating load, and electrical load of the building.
9. MAX  
is the highest monthly peak cooling load, heating load, and electrical load.

SIMPLE STRUCTURE RUN 3, CHICAGO  
 DESIGN-DAY SIZING OF VAV SYSTEM  
 REPORT- LS-D BUILDING MONTHLY LOADS SUMMARY

DIVIDE INTO ZONES; ADD PLENUM  
 SHOW ALL REPORTS

DOE-2.1E-001 Thu Nov 4 15:19:02 1993LDL RUN 3

WEATHER FILE- TRY CHICAGO

MONTH	C O O L I N G					H E A T I N G					E L E C	
	COOLING ENERGY (MBTU)	TIME OF MAX DY HR	DRY- BULB TEMP	WET- BULB TEMP	MAXIMUM COOLING LOAD (KBTU/HR)	HEATING ENERGY (MBTU)	TIME OF MAX DY HR	DRY- BULB TEMP	WET- BULB TEMP	MAXIMUM HEATING LOAD (KBTU/HR)	ELEC- TRICAL ENERGY (KWH)	MAXIMUM ELEC LOAD (KW)
JAN	4.78164	25 16	48.F	42.F	49.888	-11.550	12 8	-7.F	-7.F	-44.074	2821.	11.500
FEB	4.43467	15 16	31.F	26.F	51.672	-10.628	4 6	7.F	6.F	-44.237	2451.	11.500
MAR	6.38896	5 17	57.F	46.F	51.477	-7.794	24 6	8.F	7.F	-44.428	2709.	11.500
APR	12.44952	26 15	78.F	61.F	68.359	-2.422	8 6	32.F	29.F	-21.366	2810.	11.500
MAY	15.49518	20 15	77.F	68.F	68.505	-1.047	6 5	39.F	35.F	-12.132	2821.	11.500
JUN	19.14147	20 15	90.F	77.F	75.856	-0.233	23 5	52.F	48.F	-5.822	2585.	11.500
JUL	24.68539	9 15	94.F	74.F	80.255	-0.006	1 1	63.F	54.F	-0.240	2821.	11.500
AUG	22.43433	19 17	90.F	71.F	80.443	-0.009	5 5	55.F	54.F	-2.692	2821.	11.500
SEP	16.82664	26 16	82.F	61.F	77.270	-0.537	22 6	35.F	31.F	-12.155	2585.	11.500
OCT	13.10616	10 16	68.F	53.F	71.816	-1.883	21 6	30.F	29.F	-17.395	2821.	11.500
NOV	6.53109	8 15	60.F	49.F	66.382	-6.602	15 6	28.F	26.F	-28.497	2473.	11.500
DEC	4.46447	10 15	41.F	35.F	52.291	-10.857	8 20	18.F	16.F	-37.581	2709.	11.500
TOTAL	150.740					-53.568					32429.	
MAX					80.443					-44.428		11.500

**REPORT LS-E**  
**SPACE MONTHLY LOAD COMPONENTS IN MBtu**

This report gives a breakdown of loads for each space on a monthly basis, according to the source of the load. All entries are in millions of Btu/month. Each load is broken down into three types: heating (HEATNG), sensible cooling (SEN CL), and latent cooling (LAT CL). Latent cooling loads are accumulated only for those hours in each month that have a net sensible cooling load. Positive entries correspond to heat gain, negative entries correspond to heat loss, and all sensible loads are calculated as *delayed in time with weighting factors*.

The load sources, listed across the top of the report, are described below. The corresponding headings from Report LS-B are given in brackets.

1. WALLS [WALLS plus DOOR]  
is the heat conduction through exterior walls with TILT greater than 45°, plus conduction through doors located in exterior walls.
2. ROOFS [ROOFS]  
is the heat conduction through exterior walls with TILT less than 45°.
3. INT SUR [INTERNAL SURFACES]  
is the heat conduction through interior walls. This entry will be non-zero only if there are one or more adjoining spaces with a loads calculation temperature that is different from that of the space being reported.
4. UND SUR [UNDERGROUND SURFACES]  
is the heat conduction through underground surfaces.
5. INFIL [INFILTRATION]  
is the load due to air infiltration.
6. WIN CON [WINDOW CONDUCTION]  
is the sum of the  $UA\Delta T$  load through the windows (glass plus frames) plus solar energy absorbed by the glass and frames and conducted into the space.
7. WIN SOL [WINDOW SOLAR] is the load from direct and diffuse solar radiation transmitted by the window glass.
8. OCCUP [OCCUPANTS TO SPACE]  
is the heat gain from occupants.
9. LIGHTS [LIGHT TO SPACE]  
is the heat gain from lights.
10. EQUIP [EQUIPMENT TO SPACE]  
is the load resulting from equipment. These values are calculated from user-supplied entries for EQUIP-SCHEDULE, EQUIPMENT-KW, EQUIPMENT-W/SQFT, EQUIP-SENSIBLE and EQUIP-LATENT.



11. SOURCE [PROCESS TO SPACE]

is the load resulting from internal heating loads other than people, lights, or equipment. These values are calculated from the user-supplied entries for SOURCE-SCHEDULE, SOURCE-TYPE, SOURCE-BTU/HR, SOURCE-SENSIBLE, and SOURCE-LATENT.

The LS-E Report is printed once for the combined DESIGN-DAY intervals (if one or more DESIGN-DAYS are specified) and once for the combined RUN-PERIOD intervals that use the weather file. For DESIGN-DAYS, the months will be printed in the same order as they appear in the DESIGN-DAY RUN-PERIOD intervals.

To illustrate how the entries in this report are accumulated, consider a sequence of four hours in January in which the load components (in MBtu) from conduction through walls and heat from lights are as follows (the other load components are assumed to be zero):

	Walls	Lights
hour 1:	-0.01	0.03
hour 2:	-0.02	0.03
hour 3:	-0.04	0.03
hour 4:	-0.05	0.03

In hours 1 and 2 the net loads are  $(-0.01 + 0.03) = 0.02$ , and  $(-0.02 + 0.03) = 0.01$ , respectively. Thus, both these hours have a net (sensible) cooling load. In hours 3 and 4, on the other hand, the net loads are  $(-0.04 + 0.03) = -0.01$  and  $(-0.05 + 0.03) = -0.02$ , respectively. Thus, these hours have a net heating load. The entries in the LS-E Report for January would then be (assuming all other hours have zero loads):

		WALLS	LIGHTS	TOTAL
	HEATNG	-0.09	0.06	-0.03 ( from hours 3 and 4 )
JAN	SEN CL	-0.03	0.06	0.03 ( from hours 1 and 2 )
	LAT CL	0.	0.	0.

(UNITS=MBTU)		WALLS	ROOFS	INT SUR	UND SUR	INFIL	WIN CON	WIN SOL	OCCUP	LIGHTS	EQUIP	SOURCE	TOTAL
JAN	HEATNG	-0.883	0.000	0.000	-0.838	-0.385	-3.068	1.041	0.219	0.477	0.261	0.000	-3.176
	SEN CL	-0.195	0.000	0.000	-0.341	-0.166	-0.926	1.803	0.370	0.616	0.398	0.000	1.561
	LAT CL					0.000			0.214		0.000	0.000	0.214
FEB	HEATNG	-0.739	0.000	0.000	-0.810	-0.487	-2.700	1.070	0.186	0.407	0.223	0.000	-2.851
	SEN CL	-0.161	0.000	0.000	-0.361	-0.180	-0.813	1.917	0.326	0.548	0.350	0.000	1.627
	LAT CL					0.000			0.186		0.000	0.000	0.186
MAR	HEATNG	-0.518	0.000	0.000	-0.711	-0.378	-1.961	1.053	0.089	0.262	0.120	0.000	-2.044
	SEN CL	-0.200	0.000	0.000	-0.507	-0.245	-0.953	2.107	0.479	0.799	0.516	0.000	1.995
	LAT CL					0.006			0.277		0.000	0.000	0.282
APR	HEATNG	-0.224	0.000	0.000	-0.329	0.000	-0.840	0.522	0.038	0.129	0.053	0.000	-0.651
	SEN CL	-0.089	0.000	0.000	-0.661	0.000	-0.657	3.133	0.552	0.959	0.604	0.000	3.842
	LAT CL					0.000			0.306		0.000	0.000	0.306
MAY	HEATNG	-0.129	0.000	0.000	-0.181	0.000	-0.478	0.369	0.020	0.080	0.032	0.000	-0.286
	SEN CL	-0.035	0.000	0.000	-0.566	0.000	-0.508	3.179	0.572	1.018	0.629	0.000	4.289
	LAT CL					0.000			0.306		0.000	0.000	0.306
JUN	HEATNG	-0.031	0.000	0.000	-0.037	0.000	-0.113	0.109	0.004	0.020	0.008	0.000	-0.040
	SEN CL	0.143	0.000	0.000	-0.421	0.000	0.116	3.468	0.537	0.992	0.598	0.000	5.433
	LAT CL					0.000			0.278		0.000	0.000	0.278
JUL	HEATNG	0.000	0.000	0.000	0.000	0.000	-0.001	0.001	0.000	0.000	0.000	0.000	0.000
	SEN CL	0.393	0.000	0.000	-0.236	0.000	0.852	3.862	0.590	1.093	0.659	0.000	7.214
	LAT CL					0.000			0.306		0.000	0.000	0.306
AUG	HEATNG	-0.003	0.000	0.000	-0.001	0.000	-0.012	0.011	0.000	0.002	0.001	0.000	-0.003
	SEN CL	0.296	0.000	0.000	-0.156	0.000	0.530	3.849	0.594	1.101	0.662	0.000	6.876
	LAT CL					0.000			0.306		0.000	0.000	0.306
SEP	HEATNG	-0.069	0.000	0.000	-0.030	0.000	-0.257	0.161	0.006	0.033	0.013	0.000	-0.144
	SEN CL	0.069	0.000	0.000	-0.198	0.000	-0.223	4.091	0.530	0.971	0.590	0.000	5.829
	LAT CL					0.000			0.278		0.000	0.000	0.278
OCT	HEATNG	-0.184	0.000	0.000	-0.127	0.000	-0.675	0.387	0.019	0.087	0.034	0.000	-0.458
	SEN CL	-0.074	0.000	0.000	-0.305	0.000	-0.633	3.488	0.572	1.010	0.626	0.000	4.684
	LAT CL					0.000			0.306		0.000	0.000	0.306
NOV	HEATNG	-0.485	0.000	0.000	-0.411	-0.319	-1.795	0.683	0.093	0.263	0.123	0.000	-1.847
	SEN CL	-0.148	0.000	0.000	-0.272	-0.164	-0.778	2.091	0.421	0.707	0.455	0.000	2.313
	LAT CL					0.003			0.242		0.000	0.000	0.245
DEC	HEATNG	-0.764	0.000	0.000	-0.704	-0.459	-2.762	0.635	0.153	0.383	0.193	0.000	-3.324
	SEN CL	-0.209	0.000	0.000	-0.277	-0.153	-0.884	1.174	0.410	0.667	0.438	0.000	1.166
	LAT CL					0.000			0.243		0.000	0.000	0.243
TOT	HEATNG	-4.029	0.000	0.000	-4.179	-2.028	-14.661	6.042	0.827	2.144	1.061	0.000	-14.824
	SEN CL	-0.209	0.000	0.000	-4.299	-0.907	-4.876	34.163	5.952	10.481	6.525	0.000	46.830
	LAT CL					0.009			3.247		0.000	0.000	3.256

Page left intentionally blank

## REPORT LS-F

### BUILDING MONTHLY LOAD COMPONENTS IN MBtu

This report gives a breakdown of loads on a monthly basis for the entire building, according to the source of the load. The loads in unconditioned spaces (ZONE-TYPE = UNCONDITIONED or PLENUM) are not included; all entries are in millions of Btu/month.

Like Report LS-E, three types of loads are shown: heating (HEATNG), sensible cooling (SEN CL), and latent cooling (LAT CL). The reported sources of the load (WALLS, ROOFS, etc.) are defined in the LS-E report description.

For multizone buildings, the load components are obtained by summing the corresponding load components for each conditioned space after multiplication by the space MULTIPLIER or FLOOR-MULTIPLIER. For example, consider a building with two spaces, Z-1 and Z-2, with space MULTIPLIERS of 2 and 3, respectively. If the heating load components in January due to glass conduction are -5.90 MBtu for Z-1 and -2.30 MBtu for Z-2, then the corresponding building load component is  $2 \times (-5.90) + 3 \times (-2.30) = -18.70$  MBtu.

The total monthly heating and sensible cooling loads in the last column of this report are the same as those given in Report LS-D, Building Monthly Loads Summary, under the headings HEATING ENERGY and COOLING ENERGY.

(UNITS=MBTU)		WALLS	ROOFS	INT SUR	UND SUR	INFIL	WIN CON	WIN SOL	OCCUP	LIGHTS	EQUIP	SOURCE	TOTAL
JAN	HEATNG	-3.041	0.000	0.000	-3.899	-1.817	-8.700	2.023	0.855	1.987	1.042	0.000	-11.550
	SEN CL	-0.579	0.000	0.000	-1.681	-0.790	-2.000	2.634	1.932	3.188	2.077	0.000	4.782
	LAT CL					0.000			1.129		0.000	0.000	1.129
FEB	HEATNG	-2.551	0.000	0.000	-3.940	-2.252	-7.698	2.351	0.751	1.782	0.929	0.000	-10.628
	SEN CL	-0.482	0.000	0.000	-1.602	-0.904	-1.756	2.990	1.666	2.739	1.784	0.000	4.435
	LAT CL					0.000			0.978		0.000	0.000	0.978
MAR	HEATNG	-1.726	0.000	0.000	-3.607	-1.870	-5.408	2.584	0.405	1.270	0.557	0.000	-7.794
	SEN CL	-0.650	0.000	0.000	-2.160	-1.080	-2.358	4.155	2.278	3.752	2.453	0.000	6.389
	LAT CL					0.013			1.335		0.000	0.000	1.348
APR	HEATNG	-0.735	0.000	0.000	-1.879	0.000	-2.315	1.402	0.177	0.660	0.268	0.000	-2.422
	SEN CL	-0.329	0.000	0.000	-2.804	0.000	-1.719	7.351	2.612	4.494	2.844	0.000	12.450
	LAT CL					0.000			1.444		0.000	0.000	1.444
MAY	HEATNG	-0.382	0.000	0.000	-1.036	0.000	-1.207	0.940	0.085	0.398	0.156	0.000	-1.047
	SEN CL	-0.139	0.000	0.000	-2.502	0.000	-1.371	9.018	2.714	4.802	2.974	0.000	15.495
	LAT CL					0.000			1.446		0.000	0.000	1.446
JUN	HEATNG	-0.084	0.000	0.000	-0.361	0.000	-0.275	0.261	0.016	0.155	0.056	0.000	-0.233
	SEN CL	0.452	0.000	0.000	-1.804	0.000	0.310	10.194	2.539	4.637	2.814	0.000	19.141
	LAT CL					0.000			1.314		0.000	0.000	1.314
JUL	HEATNG	0.000	0.000	0.000	-0.075	0.000	-0.002	0.003	0.000	0.051	0.017	0.000	-0.006
	SEN CL	1.220	0.000	0.000	-1.045	0.000	2.217	11.276	2.788	5.128	3.103	0.000	24.685
	LAT CL					0.000			1.446		0.000	0.000	1.446
AUG	HEATNG	-0.011	0.000	0.000	-0.005	0.000	-0.036	0.033	0.001	0.007	0.002	0.000	-0.009
	SEN CL	0.848	0.000	0.000	-0.740	0.000	1.268	9.901	2.808	5.213	3.137	0.000	22.434
	LAT CL					0.000			1.446		0.000	0.000	1.446
SEP	HEATNG	-0.274	0.000	0.000	-0.215	0.000	-0.869	0.505	0.030	0.208	0.078	0.000	-0.537
	SEN CL	0.073	0.000	0.000	-0.863	0.000	-0.689	8.484	2.505	4.544	2.773	0.000	16.827
	LAT CL					0.000			1.314		0.000	0.000	1.314
OCT	HEATNG	-0.726	0.000	0.000	-0.697	0.000	-2.217	1.009	0.101	0.466	0.182	0.000	-1.883
	SEN CL	-0.345	0.000	0.000	-1.345	0.000	-1.589	6.014	2.696	4.729	2.946	0.000	13.106
	LAT CL					0.000			1.445		0.000	0.000	1.445
NOV	HEATNG	-1.642	0.000	0.000	-1.997	-1.479	-5.002	1.489	0.368	1.147	0.514	0.000	-6.602
	SEN CL	-0.543	0.000	0.000	-1.238	-0.808	-1.956	3.345	2.060	3.446	2.226	0.000	6.531
	LAT CL					0.011			1.182		0.000	0.000	1.193
DEC	HEATNG	-2.497	0.000	0.000	-3.197	-2.097	-7.448	1.349	0.619	1.621	0.794	0.000	-10.856
	SEN CL	-0.667	0.000	0.000	-1.448	-0.802	-2.153	1.946	2.042	3.354	2.194	0.000	4.464
	LAT CL					0.000			1.199		0.000	0.000	1.199
TOT	HEATNG	-14.259	0.000	0.000	-21.578	-10.248	-43.058	14.630	3.462	9.964	4.692	0.000	-56.396
	SEN CL	-1.002	0.000	0.000	-19.593	-4.474	-11.701	79.850	28.933	50.572	31.662	0.000	154.248
	LAT CL					0.024			15.848		0.000	0.000	15.872

REPORT LS-G  
SPACE DAYLIGHTING SUMMARY

This report gives monthly-average lighting energy reduction, illuminance, and glare for each daylight space. If only one lighting reference point is specified, the entries under REF PT 2 will be zero. Task lighting energy, as determined by TASK-LIGHTING-KW or TASK-LT-W/SQFT, is not considered.

1. PERCENT LIGHTING ENERGY REDUCTION BY DAYLIGHTING (ALL HOURS)  
gives the percentage by which electric lighting energy is reduced, due to daylighting, for the entire space (TOTAL ZONE), and for the lighting zones at each lighting reference point (REF PT 1 and REF PT 2). In this section of the report, all hours of the day are taken into account, including nighttime hours when the lighting energy reduction due to daylighting is zero.
2. PERCENT LIGHTING ENERGY REDUCTION BY DAYLIGHTING (REPORT SCHEDULE HOURS)  
gives the percentage by which electric lighting energy is reduced, due to daylighting, for the entire space (TOTAL ZONE), and for the lighting zones at each lighting reference point (REF PT 1 and REF PT 2). In this section of the report, only those hours are taken into account for which the value of DAYLIGHT-REP-SCH for this space is non-zero (the default). If DAYLIGHT-REP-SCH is not defined the entries will be the same as those in Part 1 above.

In the following four sections, only those hours are taken into account for which *the sun is up* and the value of DAYLIGHT-REP-SCH is non-zero (the default).

3. AVERAGE DAYLIGHT ILLUMINANCE  
gives the average illuminance due to daylight at each lighting reference point.
4. PERCENT HOURS DAYLIGHT ILLUMINANCE ABOVE SETPOINT  
gives the percentage of hours that the illuminance from daylight exceeds the required illuminance level as specified by LIGHT-SET-POINT1 at REF PT 1 and LIGHT-SET-POINT2 at REF PT 2. (See Report LS-J for the frequency of occurrence distribution for daylight illuminance.)
5. AVERAGE GLARE INDEX  
gives the average daylight glare index at each lighting reference point (REF PT 1 and REF PT 2).
6. PERCENT HOURS GLARE TOO HIGH  
gives the percentage of hours at each lighting reference point that the daylight glare index exceeds the MAX-GLARE value (or a value of 22, the maximum recommended for general office work, if MAX-GLARE has not been specified).

SPACE SOUTHZONE

-----REPORT SCHEDULE HOURS WITH SUN UP-----

MONTH	PERCENT LIGHTING ENERGY REDUCTION BY DAYLIGHTING (ALL HOURS)			PERCENT LIGHTING ENERGY REDUCTION BY DAYLIGHTING (REPORT SCHEDULE HOURS)			AVERAGE DAYLIGHT ILLUMINANCE (FOOTCANDLES)		PERCENT HOURS DAYLIGHT ILLUMINANCE ABOVE SETPOINT		AVERAGE GLARE INDEX		PERCENT HOURS GLARE TOO HIGH	
	TOTAL ZONE	REF PT 1	REF PT 2	TOTAL ZONE	REF PT 1	REF PT 2	REF PT 1	REF PT 2	REF PT 1	REF PT 2	REF PT 1	REF PT 2	REF PT 1	REF PT 2
	-----	-----	-----	-----	-----	-----	-----	-----	-----	-----	-----	-----	-----	-----
JAN	15.9	31.7	0.0	20.5	41.1	0.0	33.6	0.0	22.2	0.0	8.6	0.0	0.0	0.0
FEB	21.6	43.1	0.0	27.7	55.4	0.0	40.6	0.0	26.2	0.0	10.3	0.0	0.0	0.0
MAR	24.7	49.4	0.0	31.1	62.2	0.0	48.2	0.0	38.4	0.0	11.5	0.0	0.0	0.0
APR	27.4	54.7	0.0	33.4	66.7	0.0	67.4	0.0	65.2	0.0	12.7	0.0	0.0	0.0
MAY	29.0	58.1	0.0	34.4	68.9	0.0	87.0	0.0	77.8	0.0	13.8	0.0	0.0	0.0
JUN	29.9	59.7	0.0	34.7	69.5	0.0	84.4	0.0	70.0	0.0	13.5	0.0	0.0	0.0
JUL	29.7	59.3	0.0	34.3	68.6	0.0	72.5	0.0	60.2	0.0	12.6	0.0	0.0	0.0
AUG	29.2	58.5	0.0	34.6	69.1	0.0	81.2	0.0	84.2	0.0	13.6	0.0	0.0	0.0
SEP	27.7	55.4	0.0	33.7	67.3	0.0	59.4	0.0	62.2	0.0	12.2	0.0	0.0	0.0
OCT	24.0	48.1	0.0	30.4	60.9	0.0	47.8	0.0	38.7	0.0	11.1	0.0	0.0	0.0
NOV	17.2	34.4	0.0	22.1	44.2	0.0	37.9	0.0	28.9	0.0	9.0	0.0	0.0	0.0
DEC	14.1	28.2	0.0	18.2	36.4	0.0	26.3	0.0	14.0	0.0	7.5	0.0	0.0	0.0
ANNUAL	24.3	48.5	0.0	29.7	59.4	0.0	57.3	0.0	49.1	0.0	11.4	0.0	0.0	0.0

## REPORT LS-H

### PERCENT LIGHTING ENERGY REDUCTION BY DAYLIGHT, <space>

For each daylit space this report gives the monthly lighting energy reduction due to daylighting for each hour of the day, and for all hours of the day combined (including nighttime hours). HOUR OF DAY is given in standard time, even if DAYLIGHT-SAVINGS = YES. Hour 1 is 12 pm to 1 am, hour 2 is 1 am to 2 am, etc. The schedule DAYLIGHT-REP-SCH has no effect on this report. Task lighting energy, as determined by TASK-LIGHTING-KW or TASK-LT-W/SQFT, is not considered.

See Report LS-I for lighting energy reduction vs. hour of day for the entire building.



SPACE SOUTHZONE

MONTH	HOUR OF DAY																								ALL HOURS
	1	2	3	4	5	6	7	8	9	10	11	12	13	14	15	16	17	18	19	20	21	22	23	24	
JAN	0	0	0	0	0	0	0	1	11	21	28	30	31	28	24	13	1	0	0	0	0	0	0	0	16
FEB	0	0	0	0	0	0	0	8	22	30	33	34	34	33	30	24	10	0	0	0	0	0	0	0	22
MAR	0	0	0	0	0	0	4	19	28	33	34	35	35	34	33	30	19	3	0	0	0	0	0	0	25
APR	0	0	0	0	0	2	17	30	33	34	35	35	35	35	34	33	26	11	0	0	0	0	0	0	27
MAY	0	0	0	0	0	9	26	32	34	35	35	35	35	35	34	29	17	3	0	0	0	0	0	0	29
JUN	0	0	0	0	1	13	26	35	35	34	35	35	35	35	34	31	23	8	0	0	0	0	0	0	30
JUL	0	0	0	0	0	10	28	33	35	34	35	35	35	35	32	33	27	9	0	0	0	0	0	0	30
AUG	0	0	0	0	0	3	23	33	34	35	35	35	35	35	34	32	20	2	0	0	0	0	0	0	29
SEP	0	0	0	0	0	0	16	31	32	35	35	35	35	35	34	32	26	5	0	0	0	0	0	0	28
OCT	0	0	0	0	0	0	5	23	31	33	34	35	35	33	30	25	7	0	0	0	0	0	0	0	24
NOV	0	0	0	0	0	0	0	8	23	28	30	32	31	27	20	10	0	0	0	0	0	0	0	0	17
DEC	0	0	0	0	0	0	0	2	13	21	26	28	28	25	18	6	0	0	0	0	0	0	0	0	14
ANNUAL	0	0	0	0	0	4	16	27	28	31	33	33	34	33	30	26	15	7	2	0	0	0	0	0	24

NOTE- THE ENTRIES IN THIS REPORT ARE NOT SUBJECT TO THE DAYLIGHTING REPORT SCHEDULE

## REPORT LS-I

### PERCENT LIGHTING ENERGY REDUCTION BY DAYLIGHT, BUILDING

For the building as a whole this report gives the monthly lighting energy reduction due to daylighting for each hour of the day and for all hours of the day combined (including nighttime hours). HOUR OF DAY is given in standard time, even if DAYLIGHT-SAVINGS = YES. Hour 1 is 12 pm to 1 am, hour 2 is 1 am to 2 am, etc. All spaces in the building are included in this report, even those which are not daylit (i.e. have DAYLIGHTING = NO). This report is not affected by DAYLIGHT-REP-SCH. Task lighting energy, as determined by TASK-LIGHTING-KW or TASK-LT-W/SQFT, is not considered.

See Report LS-H for lighting energy reduction vs. hour of day for individual daylit spaces.

\*\*\* BUILDING \*\*\*

MONTH	HOUR OF DAY																								ALL HOURS
	1	2	3	4	5	6	7	8	9	10	11	12	13	14	15	16	17	18	19	20	21	22	23	24	
JAN	0	0	0	0	0	0	0	0	4	7	9	10	10	9	8	4	0	0	0	0	0	0	0	0	5
FEB	0	0	0	0	0	0	0	2	7	9	11	11	11	11	10	8	3	0	0	0	0	0	0	0	7
MAR	0	0	0	0	0	0	1	6	10	11	11	12	12	11	11	10	6	1	0	0	0	0	0	0	8
APR	0	0	0	0	0	1	6	10	11	12	12	12	12	12	12	11	11	9	4	0	0	0	0	0	9
MAY	0	0	0	0	0	4	9	11	12	12	12	12	12	12	12	12	10	6	1	0	0	0	0	0	10
JUN	0	0	0	0	0	5	9	12	12	12	12	12	12	12	12	12	11	8	4	0	0	0	0	0	10
JUL	0	0	0	0	0	4	9	11	12	12	12	12	12	12	12	11	11	9	4	0	0	0	0	0	10
AUG	0	0	0	0	0	2	8	11	12	12	12	12	12	12	12	12	10	7	1	0	0	0	0	0	10
SEP	0	0	0	0	0	0	5	9	10	12	12	12	12	12	11	10	8	2	0	0	0	0	0	0	9
OCT	0	0	0	0	0	0	2	7	10	11	11	11	11	11	10	8	2	0	0	0	0	0	0	0	8
NOV	0	0	0	0	0	0	0	3	7	9	10	11	10	9	7	3	0	0	0	0	0	0	0	0	6
DEC	0	0	0	0	0	0	0	1	4	7	9	9	10	8	6	2	0	0	0	0	0	0	0	0	5
ANNUAL	0	0	0	0	0	2	5	9	9	11	11	11	11	11	10	9	5	3	1	0	0	0	0	0	8

NOTE- THE ENTRIES IN THIS REPORT ARE NOT SUBJECT TO THE DAYLIGHTING REPORT SCHEDULE

## REPORT LS-J

### DAYLIGHT ILLUMINANCE FREQUENCY OF OCCURRENCE

For each daylight space this report gives the monthly daylight-illuminance frequency-of-occurrence distribution at each lighting reference point. If only one lighting reference point is specified, the entries under REF PT 2 will be zero.

1. PERCENT OF HOURS IN ILLUMINANCE RANGE

gives the percentage of hours (with sun up and DAYLIGHT-REP-SCH value non-zero) that the daylight illuminance falls in the indicated range: 0-10, 10-20, ....., 70-80, and greater than 80 footcandles. Note: because of roundoff, the sum of these percentages for any given month may not be exactly 100.

2. PERCENT OF HOURS ILLUMINANCE LEVEL EXCEEDED

gives the percentage of hours (with sun up and DAYLIGHT-REP-SCH value non-zero) that the daylight illuminance is higher than the indicated illuminance level.

SPACE SOUTHZONE

		PERCENT OF HOURS IN ILLUMINANCE RANGE										PERCENT OF HOURS ILLUMINANCE LEVEL EXCEEDED								
		ILLUMINANCE RANGE (FOOTCANDLES)										ILLUMINANCE LEVEL (FOOTCANDLES)								
MONTH	REF PT	0	10	20	30	40	50	60	70	80	-ABOVE	0	10	20	30	40	50	60	70	80
JAN	-1-	20	15	25	16	3	3	7	3	10		100	80	66	41	25	22	19	13	10
	-2-	0	0	0	0	0	0	0	0	0		0	0	0	0	0	0	0	0	0
FEB	-1-	7	11	16	19	21	6	9	5	6		100	93	83	66	47	26	20	11	6
	-2-	0	0	0	0	0	0	0	0	0		0	0	0	0	0	0	0	0	0
MAR	-1-	0	6	11	26	18	13	9	5	11		100	100	93	82	56	38	25	16	11
	-2-	0	0	0	0	0	0	0	0	0		0	0	0	0	0	0	0	0	0
APR	-1-	0	1	9	12	14	18	12	5	30		100	100	99	91	79	65	47	35	30
	-2-	0	0	0	0	0	0	0	0	0		0	0	0	0	0	0	0	0	0
MAY	-1-	0	1	2	8	12	12	9	4	53		100	100	99	97	90	78	66	57	53
	-2-	0	0	0	0	0	0	0	0	0		0	0	0	0	0	0	0	0	0
JUN	-1-	0	0	0	13	17	11	10	6	43		100	100	100	100	87	70	59	49	43
	-2-	0	0	0	0	0	0	0	0	0		0	0	0	0	0	0	0	0	0
JUL	-1-	0	0	2	11	26	17	10	4	29		100	100	100	97	86	60	43	33	29
	-2-	0	0	0	0	0	0	0	0	0		0	0	0	0	0	0	0	0	0
AUG	-1-	0	0	1	7	8	20	17	6	40		100	100	100	99	92	84	64	47	40
	-2-	0	0	0	0	0	0	0	0	0		0	0	0	0	0	0	0	0	0
SEP	-1-	0	1	7	13	17	16	20	13	14		100	100	99	92	80	62	46	26	14
	-2-	0	0	0	0	0	0	0	0	0		0	0	0	0	0	0	0	0	0
OCT	-1-	3	7	10	21	20	9	13	9	9		100	97	91	80	59	39	30	18	9
	-2-	0	0	0	0	0	0	0	0	0		0	0	0	0	0	0	0	0	0
NOV	-1-	19	11	21	16	5	4	7	4	14		100	81	70	50	34	29	24	18	14
	-2-	0	0	0	0	0	0	0	0	0		0	0	0	0	0	0	0	0	0
DEC	-1-	24	21	24	15	2	4	3	2	5		100	76	56	31	16	14	10	7	5
	-2-	0	0	0	0	0	0	0	0	0		0	0	0	0	0	0	0	0	0
ANNUAL	-1-	6	6	11	15	13	11	10	5	22		100	94	88	77	63	49	38	28	22
	-2-	0	0	0	0	0	0	0	0	0		0	0	0	0	0	0	0	0	0

NOTE- THE HOURS CONSIDERED IN THIS REPORT ARE THOSE WITH SUN UP AND DAYLIGHTING REPORT SCHEDULE ON

## REPORT LS-K

### SPACE INPUT FUELS SUMMARY

This report gives monthly summaries of the fuel inputs required by each space for lighting, equipment, and processes. Following the reports for each space is a separate building level report that gives the sum of the input fuels for the building as a whole.

Lighting, equipment, and process are the three major sections of this report, which is printed once for each space and once for the building as a whole.

1. **TASK LIGHTING**  
(kilowatt hours) is the electricity used by the space for all task lighting.
2. **TOTAL LIGHTING**  
(kilowatt hours) is the electricity used by the space for all lighting including task and overhead.
3. **GENERAL EQUIPMENT**  
(kilowatt hours) is the electricity used by the space for running all equipment (i.e., computers, typewriters, etc.). For the building report, this includes building equipment such as elevators which may not be included in any space.
4. **PROCESS ELECTRIC**  
(kilowatt hours) is all electricity used to maintain any of the processes in the space.
5. **PROCESS GAS**  
(millions of Btu) is all gas used to maintain any of the processes in the space.
6. **PROCESS HOT WATER**  
(millions of Btu) is the total hot water used in all processes in the space.

SPACE SPACE1-1

MONTH	L I G H T I N G		E Q U I P M E N T		P R O C E S S	
	TASK LIGHTING (KWH)	TOTAL LIGHTING (KWH)	GENERAL EQUIPMENT (KWH)	PROCESS ELECTRIC (KWH)	PROCESS GAS (MBTU)	PROCESS HOT WATER (MBTU)
JAN	0.00	402.18	193.67	0.00	0.0000	0.0000
FEB	0.00	349.67	167.88	0.00	0.0000	0.0000
MAR	0.00	386.57	185.58	0.00	0.0000	0.0000
APR	0.00	400.28	193.16	0.00	0.0000	0.0000
MAY	0.00	402.18	193.67	0.00	0.0000	0.0000
JUN	0.00	369.07	176.99	0.00	0.0000	0.0000
JUL	0.00	402.18	193.67	0.00	0.0000	0.0000
AUG	0.00	402.18	193.67	0.00	0.0000	0.0000
SEP	0.00	369.07	176.99	0.00	0.0000	0.0000
OCT	0.00	402.18	193.67	0.00	0.0000	0.0000
NOV	0.00	353.47	168.90	0.00	0.0000	0.0000
DEC	0.00	386.57	185.58	0.00	0.0000	0.0000
ANNUAL	0.00	4625.43	2223.36	0.00	0.0000	0.0000

## REPORT LS-L MANAGEMENT AND SOLAR SUMMARY FOR SPACE

The following report gives monthly summaries of window shade management and solar radiation into the space.

1. Column 1 is the count of the number of hours that window shade management would be employed in the space for each month. Management is employed under any of the following conditions:
  - a) The shading schedule specifies management.
  - b) If the transmitted direct solar gain into the space exceeds a pre-specified value MAX-SOLAR-SCH, then, with probability SUN-CTRL-PROB, shades will be in effect.
  - c) If daylighting is requested (DAYLIGHTING=YES) and the daylight glare exceeds a pre-specified value MAX-GLARE, then the shades will be in effect.
2. Column 2 is the average solar radiation into the space through all glazing areas in Btu per day.
3. Column 3 is the maximum solar radiation into the space through all glazing areas for all hours in the month. The unit of measure is Btu per hour.

The entries in this report are solar heat gains, not solar loads; i.e., weighting factors to convert heat gains into delayed loads have *not* been applied. The solar heat gain is due to solar radiation transmitted through windows plus solar radiation absorbed by the windows and re-conducted into the space.



SIMPLE STRUCTURE RUN 3, CHICAGO  
 DESIGN-DAY SIZING OF VAV SYSTEM  
 REPORT- LS-L MANAGEMENT AND SOLAR SUMMARY FOR SPACE

DIVIDE INTO ZONES; ADD PLENUM  
 SHOW ALL REPORTS  
 SPACE1-1

DOE-2.1E-001 Thu Nov 4 15:19:02 1993LDL RUN 3  
 WEATHER FILE- TRY CHICAGO

DATA FOR SPACE SPACE1-1

MONTH	NUMBER OF HOURS MANAGEMENT WOULD BE EMPLOYED	AVERAGE DAILY SOLAR RADIATION INTO SPACE (BTU/DAY )	MAXIMUM HOURLY SOLAR RADIATION INTO SPACE (BTU/HR )
JAN	0.	91833.594	44721.133
FEB	0.	106403.789	44042.688
MAR	0.	101484.391	40590.414
APR	0.	121678.523	32228.947
MAY	0.	114414.562	25011.039
JUN	0.	119506.453	19855.189
JUL	0.	124538.578	22544.020
AUG	0.	124817.953	28443.521
SEP	0.	141770.906	36432.680
OCT	0.	124279.734	41222.324
NOV	0.	92218.547	43065.477
DEC	0.	58324.055	42647.609
-----			
ANNUAL	0.	110041.141	44721.133

## HOURLY REPORTS

Hourly reports are user-designed; you choose the variables to be displayed from lists in Appendix A. See the *Reference Manual (2.1A)*, Chap. II, for instructions on setting up hourly reports using the HOURLY-REPORT, REPORT-BLOCK and SCHEDULE commands.

Hourly reports can be printed from the LOADS, SYSTEMS and PLANT programs. The example shown here is from LOADS. The u-name of the HOURLY-REPORT command associated with the report is shown at the beginning of the third line. The first column of the report, headed by MMDDHH, gives the month, day, and hour (in *standard* time, even if DAYLIGHT-SAVINGS = YES). Succeeding columns give the following:

- variable type (GLOBAL, u-name of SPACE, etc.);
- variable name (DRY BULB TEMP, etc.);
- units (F, BTU/HR, etc.);
- variable-list number, in parentheses, chosen from Appendix A; and
- the values of the variable for hours 1 to 24.

Statistical summaries are printed at the bottom of the page. DAILY SUMMARY displays the minimum (MN), maximum (MX), sum (SM), and average (AV) values over the day for each variable. A MONTHLY SUMMARY and YEARLY SUMMARY are printed if this is the last scheduled day of the month and RUN-PERIOD, respectively. It is important to note that the MONTHLY SUMMARY includes only those days that satisfy three conditions:

- (1) in the month indicated,
- (2) in the RUN-PERIOD, *and*
- (3) in the REPORT-SCHEDULE.

Similarly, YEARLY SUMMARY includes only the days that are

- (1) in the RUN-PERIOD, *and*
- (2) in the REPORT-SCHEDULE.

You may suppress printing of hourly data, and print only the DAILY, MONTHLY or YEARLY Summary by using REPORT-FREQUENCY (see "Hourly Report Frequencies and Summaries", p.1.29).

Hourly values may be written to files in different formats for display by spreadsheet programs and other post-processor software. See "Saving Files of Hourly Output for Postprocessing", p.1.30.

	GLOBAL	GLOBAL	SPACE1-1	SPACE1-1	SPACE1-1	SYST-1	SYST-1	SYST-1
	DRY BULB TEMP F	WET BULB TEMP F	THERMOST SETPOINT F	ZONE TEMP F	EXTRACTN RATE BTU/HR	CLG COIL AIR TEMP F	RETURN AIR TEMP F	TOT CLG COIL PWR BTU/HR
	----( 8)	----( 7)	----( 7)	----( 6)	----( 8)	----( 2)	----( 4)	----( 6)
8 5 1	61.0	59.0	-999.0	80.5	0.	0.0	0.0	0.
8 5 2	59.0	58.0	-999.0	80.1	0.	0.0	0.0	0.
8 5 3	57.0	56.0	-999.0	79.6	0.	0.0	0.0	0.
8 5 4	57.0	56.0	-999.0	79.2	0.	0.0	0.0	0.
8 5 5	55.0	54.0	-999.0	78.7	0.	0.0	0.0	0.
8 5 6	52.0	50.0	-999.0	78.4	0.	0.0	0.0	0.
8 5 7	57.0	54.0	-999.0	78.3	0.	0.0	0.0	0.
8 5 8	62.0	58.0	78.0	77.1	11085.	58.5	71.4	11565.
8 5 9	68.0	61.0	78.0	77.1	12717.	57.3	74.8	52275.
8 510	72.0	63.0	78.0	77.3	14571.	57.9	77.4	70249.
8 511	74.0	64.0	78.0	77.5	16788.	57.8	80.4	86804.
8 512	76.0	63.0	78.0	77.7	18073.	57.8	83.1	92040.
8 513	77.0	63.0	78.0	77.9	21113.	57.6	84.9	108793.
8 514	78.0	63.0	78.0	78.2	23954.	57.7	85.7	120845.
8 515	77.0	62.0	78.0	78.3	25580.	57.8	86.0	124485.
8 516	76.0	62.0	78.0	78.3	25080.	57.9	85.9	119886.
8 517	77.0	62.0	78.0	78.2	23640.	57.9	85.2	114577.
8 518	76.0	61.0	-999.0	83.2	0.	0.0	0.0	0.
8 519	75.0	61.0	-999.0	83.7	0.	0.0	0.0	0.
8 520	72.0	59.0	-999.0	83.7	0.	0.0	0.0	0.
8 521	69.0	58.0	-999.0	83.2	0.	0.0	0.0	0.
8 522	68.0	57.0	-999.0	82.8	0.	0.0	0.0	0.
8 523	67.0	58.0	-999.0	82.5	0.	0.0	0.0	0.
8 524	66.0	57.0	-999.0	82.0	0.	0.0	0.0	0.
DAILY SUMMARY (AUG 5)								
MN	52.0	50.0	-999.0	77.1	0.	0.0	0.0	0.
MX	78.0	64.0	78.0	83.7	25580.	58.5	86.0	124485.
SM	1628.0	1419.0	-13206.0	1913.5	192601.	578.1	814.8	901518.
AV	67.8	59.1	-550.2	79.7	8025.	24.1	33.9	37563.
MONTHLY SUMMARY (AUG)								
MN	52.0	50.0	-999.0	77.1	0.	0.0	0.0	0.
MX	78.0	64.0	78.0	83.7	25580.	58.5	86.0	124485.
SM	1628.0	1419.0	-13206.0	1913.5	192601.	578.1	814.8	901518.
AV	67.8	59.1	-550.2	79.7	8025.	24.1	33.9	37563.
YEARLY SUMMARY								
MN	52.0	50.0	-999.0	77.1	0.	0.0	0.0	0.
MX	78.0	64.0	78.0	83.7	25580.	58.5	86.0	124485.
SM	1628.0	1419.0	-13206.0	1913.5	192601.	578.1	814.8	901518.
AV	67.8	59.1	-550.2	79.7	8025.	24.1	33.9	37563.

## HOURLY REPORT PLOT

The following example is an HOURLY-REPORT in graphic form. The month, day, and hours appear in the left-hand column. The next entry to the right is the first *possible* value. A period (.) indicates that there is no value at or below this value; an asterisk (\*) indicates that two or more values occupy this position. The numerical values appearing on the plot are correlated to the symbol numbers in the table above the plot. Component name, in the table, is the VARIABLE-TYPE of which the variable is a part. If a value appears at the last possible position on the right it means either that the value is at this point or that the value is higher than this point.

The original input that created the following sample plot is repeated here

```

PLOT1  =REPORT-BLOCK
        VARIABLE-TYPE   = GLOBAL
        VARIABLE-LIST   = (15) .. $GLOBAL HORIZONTAL SOLAR$

PLOT2  =REPORT-BLOCK
        VARIABLE-TYPE   = SOUTHZONE
        VARIABLE-LIST   = (49) .. $DAYL ILLUM, REF PT 1$

PLOTD  =HOURLY-REPORT
        REPORT-SCHEDULE = PLTSCH
        REPORT-BLOCK    = (PLOT1,PLOT2)
        OPTION          = PLOT
        AXIS-ASSIGN     = (1,2)
        AXIS-TITLES     = (*EXTERIOR SOLAR, *INTERIOR DAYLITE*)
        AXIS-MAX        = (500, 100)
        AXIS-MIN        = (0,0)
        DIVIDE          = (1,1) ..
```

For more information on specifying this type of report see HOURLY-REPORT in Chap. III of the *Reference Manual (2.1A)*.

SYMBOL	COMPONENT NAME	(NO.)	DESCRIPTION	AXIS	UNIT
1	GLOBAL	(15)	GLOBAL SOLAR	1	BTU/HR- SQFT
2	SOUTHZONE	(49)	DAYL ILLREF PT 1 2		FOOTCANDLES

		INTERIOR DAYLITE					
		0.00000E+00	0.20000E+02	0.40000E+02	0.60000E+02	0.80000E+02	0.10000E+03
		I.....	I.....	I.....	I.....	I.....	I.....
		EXTERIOR SOLAR					
		0.00000E+00	0.10000E+03	0.20000E+03	0.30000E+03	0.40000E+03	0.50000E+03
		I.....	I.....	I.....	I.....	I.....	I.....
1 2 7 *							
1 2 8 12							
1 2 9 . 1 2							
1 2 10 . 1 2							
1 2 11 . 1 2							
1 2 12 . 1 2							
1 2 13 . 1 2							
1 2 14 . 1 2							
1 2 15 . 1 2							
1 2 16 . 1 2							
1 2 17 *							
1 2 18 *							
1 2 19 *							
		I.....	I.....	I.....	I.....	I.....	I.....

## REPORT SV-A

### SYSTEM DESIGN PARAMETERS

This report echoes your input to the program as interpreted by the SYSTEMS design routines. See Section IV.D of the *Reference Manual (2.1A)* and "System Sizing", p.3.130. for a discussion of SYSTEMS design calculations. The report is divided into two sections: System-Level Design Values and Zone-Level Design Values.

Note: the quantities in this report have been adjusted for altitude even though DOE-2 requires that any CFMs you enter in SYSTEMS be at sea level.

#### System-Level Design Values

1. **SYSTEM NAME**  
is the u-name of the system.
2. **SYSTEM TYPE**  
is the code-word identifying the type of system. See "Applicability of Commands and Keywords to System Types" in the *BDL Summary (2.1E)* for a list of allowed system types.
3. **ALTITUDE MULTIPLIER**  
is the altitude adjustment factor for air flows; it multiplies air flows at sea level to get air flows at the actual altitude of the building.
4. **FLOOR AREA**  
is the total floor area of all zones served by the system that have ZONE-TYPE = CONDITIONED or UNCONDITIONED, or, for ZONE-TYPE = PLENUM, have non-zero occupancy.
5. **MAX PEOPLE**  
is the maximum number of people in all of the zones served by the system that have ZONE-TYPE = CONDITIONED or UNCONDITIONED, or, for ZONE-TYPE = PLENUM, that have non-zero occupancy. (The maximum number of people in a zone is determined by the NUMBER-OF-PEOPLE or AREA/PERSON keywords in the SPACE-CONDITIONS command in LOADS; any variation in occupancy resulting from PEOPLE-SCHEDULE is ignored in calculating MAX PEOPLE.)
6. **SUPPLY FAN (CFM)**  
is the calculated system design air flow rate. It should be equal to the user-input SUPPLY-CFM multiplied by the value of ALTITUDE MULTIPLIER. If not user-specified, the value will be calculated from the peak loads. For a constant volume system or if SIZING-OPTION = NON-COINCIDENT, the number will be the sum of the design cfm's for the zones on the system. If the system is a variable-air-volume system, SIZING-OPTION = COINCIDENT, and this is the only system in the PLANT-ASSIGNMENT, the value is calculated from the building coincident peak load.
7. **ELEC (KW)**  
is the electrical energy consumed by the central system supply fan at design flow. It will be calculated from the value in column 1 and the user input (or default) for SUPPLY-KW or from the ratio of SUPPLY-STATIC and SUPPLY-EFF.

8. DELTA-T (F)  
is the value of SUPPLY-DELTA-T, the rise in temperature of the air caused by the supply fan.
9. The next three entries, RETURN FAN (CFM), ELEC (KW), AND DELTA-T (F) are the corresponding values for the return air fan. In the sample report these are all zero because no return fan has been specified.
10. OUTSIDE AIR RATIO  
is the ratio of outside air flow to supply air flow at design conditions for central systems. Its value is either the user input value of MIN-OUTSIDE-AIR or is calculated by SYSTEMS from the ventilation or exhaust input at the zone level divided by the supply fan cfm in column 1. This is a design quantity and so does not reflect values entered through the MIN-AIR-SCH keyword. For zonal systems, this value will be zero.  
  
When OUTSIDE AIR RATIO is determined from zone ventilation rates, it is the sum of the values under OUTSIDE AIR FLOW (in column 6 opposite the zone u-names) divided by the value under SUPPLY FAN. This outside air ratio is what the program will use as the minimum outside air ratio. It is assumed that the outside air is brought in at the main system fan and is distributed to the individual zones in proportion to the supply air to each zone.  
  
Note: The SYSTEMS design routine does not examine the values entered in schedules. Consequently, if you specify the outside air ratio through MIN-AIR-SCH but want SYSTEMS to size the equipment, you should also specify MIN-OUTSIDE-AIR.
11. COOLING CAPACITY (KBTU/HR)  
is either the value you enter for the keyword COOLING-CAPACITY at the system level or is computed by SYSTEMS from the peak (sensible plus latent) cooling load. If the cfm chosen for the system is different from the user-specified value of RATED-CFM, COOLING CAPACITY may reflect a correction for off-rated performance.
12. SENSIBLE (SHR)  
is the sensible heat ratio, i.e., the fraction of the total cooling capacity that is sensible cooling capacity at the peak or design condition, adjusted for RATED-CFM. If you have not entered COOL-SH-CAP at the system level for a central system, this value is calculated from a simulation of the conditions at peak loads, adjusted for RATED-CFM.
13. HEATING CAPACITY (KBTU/HR)  
is the maximum value for heating; it reflects either the user input or a calculation from peak loads. Like COOLING CAPACITY, this value will be zero for zonal systems, where the capacity is shown at the zone level.
14. COOLING EIR and HEATING EIR (BTU/BTU)  
are the electric input ratios for cooling and heating, respectively. Values are taken from user input or are default values. Values may be modified if the supply cfm differs from the RATED-CFM.

### Zone-Level Design Values

The following quantities 15-21 apply to the base zone and have *not* been multiplied by the number of identical zones (as given by the product of MULTIPLIER and FLOOR-MULTIPLIER).

15. SUPPLY FLOW

is the calculated or user-specified supply cfm for each zone. Only if you have specified a value for the ASSIGNED-CFM keyword in the ZONE-AIR command will the value here correspond to your input. The ZONE-AIR keywords AIR-CHANGES/HR and CFM/SQFT will be accepted by SYSTEMS only if they are consistent with the user-supplied HEATING-CAPACITY and COOLING-CAPACITY, and are equivalent to a cfm larger than that of the exhaust from or the ventilation to the zone. The ALTITUDE MULTIPLIER will be applied.

16. FAN (KW)

is the total of the zone supply and exhaust fan electrical consumption at design conditions. This is zero in the example because there are no zone fans.

17. MINIMUM FLOW RATIO

reflects the your input for MIN-CFM-RATIO, unless that input is in conflict with exhaust or ventilation requirements. In the absence of user input, SYSTEMS will calculate the minimum cfm ratio for VAV systems from the minimum cfm needed to meet the the minimum ventilation requirements and the required heating capacity.

18. OUTSIDE AIR FLOW

reflects the user-specified outside air quantity entered at the zone level. If OUTSIDE-AIR-CFM is specified, its value is multiplied by the ALTITUDE MULTIPLIER and reported here. Otherwise the reported value is the maximum of the cfm-equivalent values of OA-CHANGES and OA-CFM/PER, multiplied by ALTITUDE MULTIPLIER. For the actual amount of outside air delivered to the zone for central systems, see OUTSIDE AIR RATIO above.

19. COOLING CAPACITY (KBTU/HR),

at the zone level, will be zero for central systems. For zonal systems it will either be the value you specify for COOLING-CAPACITY or it will be calculated by SYSTEMS to meet the peak loads at the rated conditions for HP, PTAC, TPFC, and FPFC systems or at any conditions for FPIU and TPIU systems. This is done similarly for HEATING CAPACITY for the above-mentioned systems and for UVT and UHT systems.

20. SENSIBLE (SHR)

is the sensible part of the cooling capacity for zonal systems.

21. EXTRACTION RATE (KBTU/HR)

is the extraction rate (cooling) at design conditions. This is not the value used in the simulation; that value is recalculated hourly and depends upon the loads, the conditions, the thermostat type, and the thermostatic throttling range. ADDITION RATE (heating) is treated similarly.

22. MULTIPLIER

is the user-specified number of identical zones (product of MULTIPLIER and FLOOR-MULTIPLIER for the zone).



SYST-1

WEATHER FILE- TRY CHICAGO

SYSTEM NAME	SYSTEM TYPE		ALTITUDE MULTIPLIER	FLOOR AREA (SQFT)		MAX PEOPLE						
SYST-1	VAVS		1.020	5000.0		52.						
	SUPPLY FAN (CFM)	ELEC (KW)	DELTA-T (F)	RETURN FAN (CFM)	ELEC (KW)	DELTA-T (F)	OUTSIDE AIR RATIO	COOLING CAPACITY (KBTU/HR)	SENSIBLE (SHR)	HEATING CAPACITY (KBTU/HR)	COOLING EIR (BTU/BTU)	HEATING EIR (BTU/BTU)
	6354.	7.311	3.6	0.	0.000	0.0	0.167	195.964	0.770	-44.161	0.00	0.37
ZONE NAME	SUPPLY FLOW (CFM)	EXHAUST FLOW (CFM)	FAN (KW)	MINIMUM FLOW RATIO	OUTSIDE AIR FLOW (CFM)	COOLING CAPACITY (KBTU/HR)	SENSIBLE (SHR)	EXTRACTION RATE (KBTU/HR)	HEATING CAPACITY (KBTU/HR)	ADDITION RATE (KBTU/HR)	MULTIPLIER	
SPACE5-1	1454.	0.	0.000	0.300	408.	0.00	0.00	25.13	-91.09	-75.39	1.0	
SPACE1-1	1909.	0.	0.000	0.300	224.	0.00	0.00	32.99	-119.59	-98.98	1.0	
SPACE2-1	887.	0.	0.000	0.300	102.	0.00	0.00	15.33	-55.58	-46.00	1.0	
SPACE3-1	1268.	0.	0.000	0.300	224.	0.00	0.00	21.92	-79.45	-65.75	1.0	
SPACE4-1	835.	0.	0.000	0.300	102.	0.00	0.00	14.42	-52.28	-43.26	1.0	
PLENUM-1	0.	0.	0.000	0.000	0.	0.00	0.00	0.00	0.00	0.00	1.0	

**REPORT SV-A**  
**SYSTEM DESIGN PARAMETERS ( REFRIGERATED EQUIPMENT IN**  
**<space> )**

When refrigerated equipment is input, an alternate SV-A report is printed. The top half of the report is identical to that as previously described. The bottom half, titled REFRIGERATED EQUIP IN <space>, covers the design parameters for three categories: ZONE, COMPRESSOR, and CONDENSER.

1. **UNIT**  
identifies the units input in the list of up to three entries of REFG-ZONE-LOAD.
2. **DISCHARGE TEMP**  
is the temperature inside the cases.
3. **SENSIBLE LOADS TEMP**  
is the sensible cooling effect to the space from air spilling from the case (rated at the temperatures of the space and inside the case).
4. **SENSIBLE HEAT TEMP**  
is the sensible cooling effect minus the heat of auxiliaries such as lights, fans, and anti-sweat heaters.
5. **SENSIBLE COOL TEMP**  
is the sensible cooling effect multiplied by REFG-SENS-SCH hourly values.
6. **COMPRESSOR CAPACITY**  
is the rated compressor capacity at a standard suction temperature of approximately 30°F depending on the manufacturer. Notice that when two or more compressors are multiplexed (using keyword REFG-COMP-GROUP), their combined capacity is indicated for the unit at the lowest evaporator temperature.
7. **COMPRESSOR EFFICIENCY**  
is the compressor EER (Energy Efficiency Ratio).
8. **DESIGN HEAT REJ**  
is the combined condenser heat rejection of all the compressors input.
9. **FAN ENERGY**  
is the tower fan or air cooled condenser fan rating.
10. **PUMP ENERGY**  
is the tower condenser pump rating; it is zero for air cooled applications.

SYSTEM NAME	SYSTEM TYPE	ALTITUDE MULTIPLIER	FLOOR AREA (SQFT)	MAX PEOPLE								
FS-SYS1	PSZ	1.020	1800.0	6.								
	SUPPLY FAN (CFM)	ELEC (KW)	DELTA-T (F)	RETURN FAN (CFM)	ELEC (KW)	DELTA-T (F)	OUTSIDE AIR RATIO	COOLING CAPACITY (KBTU/HR)	SENSIBLE (SHR)	HEATING CAPACITY (KBTU/HR)	COOLING EIR (BTU/BTU)	HEATING EIR (BTU/BTU)
	2213.	1.697	2.4	0.	0.000	0.0	0.307	86.897	0.628	-120.101	0.36	0.37
	ZONE NAME	SUPPLY FLOW (CFM)	EXHAUST FLOW (CFM)	FAN (KW)	MINIMUM FLOW RATIO	OUTSIDE AIR FLOW (CFM)	COOLING CAPACITY (KBTU/HR)	SENSIBLE (SHR)	EXTRACTION RATE (KBTU/HR)	HEATING CAPACITY (KBTU/HR)	ADDITION RATE (KBTU/HR)	MULTIPLIER
AT21		2213.	0.	0.000	1.000	678.	0.00	0.00	45.40	0.00	-71.69	1.0

REFRIGERATED EQUIP IN AT21

UNIT	Z O N E				C O M P R E S S O R		C O N D E N S E R		
	DISCHARGE TEMP (F)	SENSIBLE LOADS TEMP (KBTU/HR)	SENSIBLE HEAT TEMP (KBTU/HR)	SENSIBLE COOL TEMP (KBTU/HR)	COMPRESSOR CAPACITY (KBTU/HR)	COMPRESSOR EFFICIENCY (BTU/WATT)	DESIGN HEAT REJ (KBTU/HR)	FAN ENERGY (KW)	PUMP ENERGY (KW)
1	-10.0	-8.894	-8.471	-8.894	14.547	3.8	51.693	0.271	0.064
2	23.0	-3.923	-3.615	-3.923	16.390	7.0			
3	30.0	-5.280	-4.800	-5.280	0.000	7.3			

**REPORT SV-B**  
**ZONE FAN DATA FOR <system>**

This report is produced whenever Powered Induction Units (PIUs) are specified.

1. The u-name of the HVAC system is given after ZONE FAN DATA.
2. ZONE NAME  
is the zone u-name.
3. FAN FLOW  
is the calculated (or input) capacity of the PIU box fan.
4. SUPPLY FLOW  
is the flow rate of air delivered by the central system.
5. MIN FLOW RATIO  
is the minimum stop position of primary air supply to the PIU box.
6. REHEAT-DELTA-T  
is the temperature rise of the reheat coil in the PIU box.
7. FAN-DELTA-T  
is the temperature rise due to the PIU box's fan motor.
8. FAN KW  
is the PIU box's fan motor electrical requirement.

ZONE NAME	FAN FLOW (CFM )	SUPPLY FLOW (CFM )	MIN FLOW RATIO	REHEAT DELTA-T (F)	FAN DELTA-T (F)	FAN KW
RZ1	0.	10924.	0.500	50.0	0.00	0.000
TZ1	0.	8497.	0.500	50.0	0.00	0.000
PLEN1	0.	0.	0.000	0.0	0.00	0.000
PLEN2	0.	0.	0.000	0.0	0.00	0.000
RZ2	687.	859.	0.200	50.0	1.02	0.227
RZ3	547.	498.	0.200	50.0	1.02	0.181
RZ4	675.	844.	0.200	50.0	1.02	0.223
RZ5	822.	1028.	0.200	50.0	1.02	0.271
TZ2	675.	843.	0.200	50.0	1.02	0.223
TZ3	483.	439.	0.200	50.0	1.02	0.159
TZ4	659.	824.	0.200	50.0	1.02	0.218
TZ5	799.	999.	0.200	50.0	1.02	0.264

## SYSTEMS SUMMARY REPORTS: OVERVIEW

Report SS-A is *always* printed for each system input. In the following, we describe the reports in alphabetical order (except for special report REFG for refrigerated casework, which is described last). However, we caution you to be aware that in a DOE-2 run, SYSTEMS reports are not printed alphabetically, but are grouped according to a plant, system, and zone hierarchy (see, for example, the output of Simple Structure Run 3 in the *Sample Run Book (2.1E)*). The report hierarchy follows; the most often used reports are preceded by an asterisk.

### Plant Level:

- \*SS-D PLANT MONTHLY LOADS SUMMARY
- SS-E PLANT MONTHLY LOAD HOURS
- SS-M FAN ELECTRIC ENERGY FOR PLANT

### System level:

- \*SS-A SYSTEM MONTHLY LOADS SUMMARY (always printed)
- SS-B SYSTEM MONTHLY LOADS SUMMARY
- SS-C SYSTEM MONTHLY LOAD HOURS
- \*SS-H SYSTEM MONTHLY LOADS SUMMARY
- SS-I SYSTEM MONTHLY SOURCE-LATENT SUMMARY
- \*SS-J SYSTEM PEAK HEATING AND COOLING DAYS
- SS-K SPACE TEMPERATURE SUMMARY
- SS-L FAN ELECTRIC ENERGY
- SS-N RELATIVE HUMIDITY SCATTER PLOT
- SS-P LOAD, ENERGY AND PART LOAD HEATING AND COOLING IN [u-name of system]
- SS-Q HEAT PUMP COOLING AND HEATING SUMMARY FOR [u-name of system or plant-assignment]

### Zone level:

- SS-G ZONE LOADS SUMMARY
- SS-F ZONE DEMAND SUMMARY
- \*SS-O TEMPERATURE SCATTER PLOT

The following reports are related and their formats are identical at the Plant, System and Zone levels.

<u>Plant</u>	<u>System</u>	<u>Zone</u>
SS-D	SS-A	SS-G
SS-E	SS-C	None
SS-M	SS-L	None

**Page left intentionally blank**

## REPORT SS-A SYSTEM MONTHLY LOADS SUMMARY

This report is always printed by the program for each HVAC system modeled. It shows monthly cooling, heating, and electrical loads. The loads shown are the sum of zone-level loads and central air-handling-unit loads. (Zone-level loads are shown separately in Report SS-G.). This report is for comparison of monthly cooling and heating needs for the HVAC system. DX cooling loads are reported here (for PSZ, PMZS, PVAVS, PTAC, PVVT, RESVVT and RESYS systems) but are not passed to the PLANT program.

1. The title of the report shows the user name of the HVAC system being summarized (SYST-1).
2. COOLING, HEATING, and ELEC are the three sections of this system-level report.
3. COOLING ENERGY  
(millions of Btu) is the monthly sum of energy (sensible and latent) extracted by the HVAC system during the operation hours of the system and passed as a load to PLANT.
4. MAXIMUM COOLING LOAD  
(thousands of Btu/hr) includes sensible and latent space cooling loads, ventilation air, and fan heat. The peak cooling load shown here is often the start-up load after the system has been shut down overnight. Notice, however, that when the system size is inadequate to meet the start-up load there is no indication of this problem on the report. You should first inspect the PLANT program BEPS report, which shows the "Percent of Hours Any System Zone Outside of Throttling Range", for a macro view, and Report SS-O or SS-F for a zonal report of where "Loads not met" conditions prevail.  
To the left of the MAXIMUM COOLING LOAD column are the day and hour of the peak cooling load along with the outside dry-bulb and wet-bulb temperatures at the time of the peak.
5. HEATING ENERGY  
(millions of Btu) is the monthly sum of heat delivered by the secondary HVAC system during the operation hours of the system and passed as a load to PLANT.
6. MAXIMUM HEATING LOAD  
(thousands of Btu/hr) includes space heating loads, ventilation, and humidification. Again, the peak heating load is often due to start-up conditions after the system has been shut down overnight. To the left of this column are the day and hour of the peak heating load along with the outside dry-bulb and wet-bulb temperatures at the time of the peak.
7. ELECTRICAL ENERGY (kWh)  
is the monthly electrical consumption for lights, convenience outlets, supply and return fans, and energy consumed by packaged HVAC units. The electrical consumption by the pumps is reported in the PLANT program.
8. MAXIMUM ELEC LOAD (kW)  
is the monthly peak electrical consumption in a one-hour period for lights, convenience outlets, energy consumed by packaged HVAC units, and fans for the zones served by the HVAC system.



MONTH	C O O L I N G					H E A T I N G					E L E C	
	COOLING ENERGY (MBTU)	TIME OF MAX DY HR	DRY- BULB TEMP	WET- BULB TEMP	MAXIMUM COOLING LOAD (KBTU/HR)	HEATING ENERGY (MBTU)	TIME OF MAX DY HR	DRY- BULB TEMP	WET- BULB TEMP	MAXIMUM HEATING LOAD (KBTU/HR)	ELEC- TRICAL ENERGY (KWH)	MAXIMUM ELEC LOAD (KW)
JAN	0.00000				0.000	-32.540	7 8	-1.F	-1.F	-441.109	3078.	12.721
FEB	0.00000				0.000	-25.221	4 8	7.F	6.F	-419.194	2665.	12.701
MAR	0.00000				0.000	-15.190	25 8	14.F	12.F	-377.563	2904.	12.371
APR	1.52664	29 18	69.F	65.F	68.311	-3.705	8 8	30.F	27.F	-246.024	2992.	13.298
MAY	5.10064	21 14	85.F	75.F	132.661	-0.420	9 9	43.F	39.F	-40.320	3085.	14.424
JUN	14.55954	20 16	90.F	77.F	178.041	0.000				0.000	3054.	15.339
JUL	28.78266	8 16	92.F	74.F	214.902	0.000				0.000	3779.	18.322
AUG	23.67940	19 16	90.F	71.F	183.011	0.000				0.000	3545.	17.242
SEP	9.23581	11 16	86.F	72.F	138.083	-0.227	23 8	36.F	34.F	-99.033	2932.	15.530
OCT	2.26933	4 17	78.F	61.F	49.778	-2.190	21 8	30.F	29.F	-258.277	2994.	12.617
NOV	0.35773	1 16	72.F	59.F	54.561	-12.995	25 8	27.F	25.F	-325.673	2644.	13.017
DEC	0.00000				0.000	-25.768	26 8	15.F	15.F	-393.064	2940.	12.345
TOTAL	85.512					-118.258					36610.	
MAX					214.902					-441.109		18.322

**REPORT SS-B**  
**SYSTEM MONTHLY LOADS SUMMARY**

This is a summary of the heating and cooling required by all the zones (combined) served by the HVAC system. The items summarized are zone-level cooling, zone-level heating, zone baseboard heating, and preheat energy. In addition, this report lists the preheat energy required and the peak preheat load. The preheat coils raise the temperature of the mixed air to a specified temperature. When you specify baseboard heating in a zone the heating supplied is reported under the heading BASEBOARD HEATING ENERGY.

1. The u-name of the HVAC system (SYST-1) is printed on the title line.
2. COOLING BY ZONE COILS OR NAT. VENTIL (millions of Btu)  
and  
MAXIMUM COOLING BY ZONE COILS OR NAT VENTIL (thousands of Btu/hr)  
are, respectively, the monthly total and peak sensible plus latent cooling supplied by coils located in the zone(s) or, for RESYS system only, by natural ventilation. (The cooling of the primary supply air in the system is summarized in Report SS-A.) Loads met by DX units are reported here and an electrical demand is passed to PLANT.
3. HEATING BY ZONE COILS OR FURNACE (millions of Btu)  
and  
MAXIMUM HEATING BY ZONE COILS OR FURNACE (thousands of Btu/hr)  
are the monthly total heating and peak heating, respectively, supplied by coils or a furnace (oil- or gas-fired) in the zones. The furnace loads, met here in SYSTEMS, are not passed to PLANT but rather a utility demand for oil or gas is passed to PLANT. Baseboard heating is not included. In this example, the zone coils are electric resistance coils and the electrical demand will be passed to PLANT. For RESYS system only, these columns report the heating load on the furnace.
4. BASEBOARD HEATING ENERGY (millions of Btu)  
and  
MAXIMUM BASEBOARD HEATING ENERGY (thousands of Btu/hr)  
are, respectively, the monthly total heating and peak heating supplied by baseboard heaters in all the zones served by the system. These loads are passed to PLANT unless BASEBOARD-SOURCE is set equal to ELECTRIC, GAS-FURNACE, or OIL-FURNACE, in which case the load is met here in SYSTEMS and a utility demand is passed to PLANT.
5. PREHEAT COIL ENERGY OR ELEC FOR FURN FAN (millions of Btu)  
and  
MAXIMUM PREHEAT COIL ENERGY OR ELEC FOR FURN FAN (thousands of Btu/hr)  
are, respectively, the monthly total heating and peak heating supplied by the preheat coil(s) to raise the temperature of the mixed air (return air plus makeup air) to a specified value, PREHEAT-T or, for RESYS system only, the monthly and peak electricity use by the furnace fan. The preheat loads are passed to PLANT unless PREHEAT-SOURCE is set equal to ELECTRIC, GAS-FURNACE, or OIL-FURNACE, in which case the load is met here in SYSTEMS and a utility demand is passed to PLANT.

MONTH	- ZONE COOLING -		- ZONE HEATING -		BASEBOARD HEATING ENERGY (MBTU)	- - PREHEAT OR FURN FAN ELEC - -		
	COOLING BY ZONE COILS OR NAT VENTIL (MBTU)	MAXIMUM COOLING BY ZONE COILS OR NAT VENTIL (KBTU/HR)	HEATING BY ZONE COILS OR FURNACE (MBTU)	MAXIMUM HEATING BY ZONE COILS OR FURNACE (KBTU/HR)		MAXIMUM BASEBOARD HEATING ENERGY (KBTU/HR)	PREHEAT COIL ENERGY OR ELEC FOR FURN FAN (MBTU)	MAXIMUM PREHEAT COIL ENERGY OR ELEC FOR FURN FAN (KBTU/HR)
JAN	0.00000	0.000	-17.82038	-297.637	0.00000	0.000	-4.75593	-67.279
FEB	0.00000	0.000	-14.18888	-294.461	0.00000	0.000	-2.92867	-51.287
MAR	0.00000	0.000	-8.90534	-273.295	0.00000	0.000	-0.85343	-49.556
APR	0.00000	0.000	-2.10489	-209.516	0.00000	0.000	-0.02173	-8.605
MAY	0.00000	0.000	-0.07233	-20.454	0.00000	0.000	0.00000	0.000
JUN	0.00000	0.000	0.00000	0.000	0.00000	0.000	0.00000	0.000
JUL	0.00000	0.000	0.00000	0.000	0.00000	0.000	0.00000	0.000
AUG	0.00000	0.000	0.00000	0.000	0.00000	0.000	0.00000	0.000
SEP	0.00000	0.000	-0.09337	-63.534	0.00000	0.000	-0.00095	-0.948
OCT	0.00000	0.000	-1.16098	-195.242	0.00000	0.000	-0.02610	-7.933
NOV	0.00000	0.000	-8.25455	-257.724	0.00000	0.000	-0.21340	-15.096
DEC	0.00000	0.000	-15.28043	-282.811	0.00000	0.000	-1.52668	-42.234
TOTAL	0.000		-67.881		0.000		-10.327	
MAX		0.000		-297.637		0.000		-67.279

## REPORT SS-C

### SYSTEM MONTHLY LOAD HOURS

The number of cooling and heating hours and fan operating hours for each month are reported for the system. Included are the hours when both heating and cooling are required. In addition, this report gives the heating and electrical loads at the time of the cooling peak. Note: the hour counts in this report are incremented by 1.0 when the relevant condition (e.g., "fans on") applies for all or *part* of the hour.

1. HOURS COOLING LOAD  
and  
HOURS HEATING LOAD  
give the total hours in each month when the HVAC system is operating with a cooling load or a heating load, respectively.
2. HOURS COINCIDENT COOL-HEAT LOAD  
gives the number of hours in each month when the HVAC system is operating with simultaneous heating and cooling loads.

The above numbers do not include hours when the only load was from pilot lights or crankcase heating.

3. HOURS FLOATING  
is the total number of hours that no heating or cooling was provided (with the fans on or off).
4. HOURS HEATING AVAIL  
is the number of hours that heating equipment is available, as determined by HEATING-SCHEDULE.
5. HOURS COOLING AVAIL  
is the number of hours that cooling equipment is available, as determined by COOLING-SCHEDULE.
6. HOURS FANS ON  
is the number of hours that fans are in operation, including cycling of fans on to maintain night setback or setup temperature setpoint.
7. HOURS FANS CYCLE ON  
is the number of hours fans were cycled on to maintain night setback or setup temperature setpoint.
8. HOURS NIGHT VENTING  
is the number of hours fans were on to maintain the night venting set point.
9. HOURS FLOATING WHEN FANS ON  
is the number of hours that no heating or cooling was provided (with the fans on).

10. HEATING LOAD AT COOLING PEAK  
is the heating load at the time of maximum cooling. It provides an assessment of oversizing for simultaneous heating/cooling systems (e.g., reheat systems).
11. ELECTRIC LOAD AT COOLING PEAK  
is the demand of all electric equipment calculated in LOADS and SYSTEMS at the time of maximum cooling.

----- N U M B E R   O F   H O U R S -----											--COINCIDENT LOADS--	
MONTH	HOURS COOLING LOAD	HOURS HEATING LOAD	HOURS COINCIDENT COOL-HEAT LOAD	HOURS FLOATING	HOURS HEATING AVAIL.	HOURS COOLING AVAIL.	HOURS FANS ON	HOURS FANS CYCLE ON	HOURS NIGHT VENTING	HOURS FLOATING WHEN FANS ON	HEATING LOAD AT COOLING PEAK (KBTU/HR)	ELECTRIC LOAD AT COOLING PEAK (KW)
JAN	0	305	0	439	744	0	305	63	0	0	0.000	0.475
FEB	0	256	0	416	672	0	256	47	0	0	0.000	0.475
MAR	0	240	0	504	711	29	248	17	0	8	0.000	0.475
APR	69	102	0	549	504	204	229	0	0	58	0.000	11.735
MAY	115	40	0	589	452	259	220	0	0	65	0.000	13.348
JUN	203	0	0	517	147	549	207	0	0	4	0.000	15.156
JUL	241	0	0	503	2	737	241	0	0	0	0.000	17.942
AUG	238	0	0	506	30	701	238	0	0	0	0.000	16.987
SEP	155	13	0	552	314	374	205	0	0	37	0.000	14.658
OCT	99	86	1	560	494	233	225	0	0	41	0.000	11.103
NOV	12	186	0	522	676	34	209	1	0	11	0.000	12.583
DEC	0	276	0	468	744	0	276	45	0	0	0.000	0.475
ANNUAL	1132	1504	1	6125	5490	3120	2859	173	0	224		

Page left intentionally blank

## REPORT SS-D

### PLANT MONTHLY LOADS SUMMARY

Multiple central plants that serve the building's HVAC systems can be simulated. The PLANT-ASSIGNMENT command assigns HVAC systems to central plants. The name of the plant is reported in the title line. In this example, no u-name was specified, and so a default name (DEFAULT-PLANT) is printed. The cooling, heating, and electrical energy required by the systems and zones served by the plant are reported monthly along with the peak cooling, heating, and electrical loads for the combined systems, and the time of occurrence. Note that these peak loads may result from startup after the building has been shut down overnight. Cooling done in SYSTEMS by DX units is not included here in cooling loads but in electrical loads.

1. COOLING ENERGY

(millions of Btu) is the sensible and latent monthly cooling required by the HVAC systems from the central plant specified in the PLANT-ASSIGNMENT command. For water loop heat pump systems the value reported here is the heat rejected to the plant's cooling tower.

2. TIME OF MAX

gives the day and hour that the maximum cooling load occurs.

3. DRY-BULB TEMP and WET-BULB TEMP

are the outside dry-bulb wet-bulb temperatures during the peak cooling load.

4. MAXIMUM COOLING LOAD

(thousands of Btu/hr) gives the peak cooling load for each month and for the year.

5. HEATING ENERGY

(millions of Btu) is the total monthly heating required by the HVAC systems from the specified central plant. For water loop heat pump systems the value reported here is the supplementary heat from the plant's hot water boiler.

6. TIME OF MAX

shows the day and hour of maximum heating load.

7. DRY-BULB TEMP and WET-BULB TEMP

are the outside dry-bulb wet-bulb temperatures during the peak heating load.

8. MAXIMUM HEATING LOAD

(thousands of Btu/hr) gives the peak heating load for each month and for the year.

9. ELECTRICAL ENERGY

(kWh) is the monthly electrical requirement for lights and convenience outlets for the building zones served by the plant. In addition, the electrical energy contains the fan energy requirement for the HVAC systems and electric energy for cooling and heating in packaged units. It does *not* include the electrical energy associated with pumps, cooling towers and chillers. These are reported in the PLANT program.

10. MAXIMUM ELEC LOAD

(kW) gives the monthly peak electrical consumption in a one-hour period for the items in 9 (ELECTRICAL ENERGY).

11. Bottom of Report

At the bottom of SS-D are shown the integrated cooling loads for the peak day for both the design day run (if any) and the annual run. These numbers are used by PLANT to size cold storage systems.



- - - - - C O O L I N G - - - - -						- - - - - H E A T I N G - - - - -					- - - E L E C - - -	
MONTH	COOLING ENERGY (MBTU)	TIME OF MAX DY HR	DRY-BULB TEMP	WET-BULB TEMP	MAXIMUM COOLING LOAD (KBTU/HR)	HEATING ENERGY (MBTU)	TIME OF MAX DY HR	DRY-BULB TEMP	WET-BULB TEMP	MAXIMUM HEATING LOAD (KBTU/HR)	ELEC-TRICAL ENERGY (KWH)	MAXIMUM ELEC LOAD (KW)
JAN	0.00000				0.000	-32.540	7 8	-1.F	-1.F	-441.109	3078.	12.721
FEB	0.00000				0.000	-25.221	4 8	7.F	6.F	-419.194	2665.	12.701
MAR	0.00000				0.000	-15.190	25 8	14.F	12.F	-377.563	2904.	12.371
APR	1.52664	29 18	69.F	65.F	68.311	-3.705	8 8	30.F	27.F	-246.024	2992.	13.298
MAY	5.10064	21 14	85.F	75.F	132.661	-0.420	9 9	43.F	39.F	-40.320	3085.	14.424
JUN	14.55954	20 16	90.F	77.F	178.041	0.000				0.000	3054.	15.339
JUL	28.78266	8 16	92.F	74.F	214.902	0.000				0.000	3779.	18.322
AUG	23.67940	19 16	90.F	71.F	183.011	0.000				0.000	3545.	17.242
SEP	9.23581	11 16	86.F	72.F	138.083	-0.227	23 8	36.F	34.F	-99.033	2932.	15.530
OCT	2.26933	4 17	78.F	61.F	49.778	-2.190	21 8	30.F	29.F	-258.277	2994.	12.617
NOV	0.35773	1 16	72.F	59.F	54.561	-12.995	25 8	27.F	25.F	-325.673	2644.	13.017
DEC	0.00000				0.000	-25.768	26 8	15.F	15.F	-393.064	2940.	12.345
TOTAL	85.512					-118.258					36610.	
MAX					214.902					-441.109		18.322

MAXIMUM DAILY INTEGRATED COOLING LOAD (DES DAY )      2274.994 (KBTU)  
 MAXIMUM DAILY INTEGRATED COOLING LOAD (WTH FILE)      2147.572 (KBTU)

**REPORT SS-E**  
**PLANT MONTHLY LOAD HOURS**

Just as the monthly load hours are reported for an HVAC system in Report SS-C, the combined load hours for all of the HVAC systems served by the central plant are shown in this report. Heating and electrical loads for the plant at the time of the cooling peak are also reported. Note: the hour counts in this report were incremented by 1.0 when the relevant condition (e.g., "fans on") applies for all or *part* of the hour.

1. **HOURS COOLING LOAD HOURS**  
and  
**HOURS HEATING LOAD HOURS**  
are the required operation hours of the central plant for supplying cooling or heating, respectively, to the HVAC systems served.
2. **HOURS COINCIDENT COOL-HEAT LOAD**  
gives the number of hours in each month when the central plant is operating with simultaneous heating and cooling loads.
3. **HOURS FLOATING**  
is the total hours (with fans on or off) that space temperatures are not at thermostat set-points.
4. **HOURS HEATING AVAIL**  
is the number of hours that heating equipment is available, as determined by **HEATING-SCHEDULE**.
5. **HOURS COOLING AVAIL**  
is the number of hours that cooling equipment is available, as determined by **COOLING-SCHEDULE**.
6. **HOURS FANS ON**  
is the number of fan operating hours, including cycling of fans on, needed to maintain the night setback or setup temperature setpoint or for night venting.
7. **HOURS FANS CYCLE ON**  
is the number of hours fans were cycled on for night setback or setup temperature setpoint.
8. **HOURS NIGHT VENTING**  
is the number of hours fans were on to maintain the night venting set point.
9. **HOURS FLOATING WHEN FANS ON**  
is the number of hours (with the fans on) that no heating or cooling was provided.
10. **HEATING LOAD AT COOLING PEAK**  
is the heating load at the time of maximum cooling. It provides an assessment of oversizing for simultaneous heating/cooling systems (e.g., reheat systems).
11. **ELECTRIC LOAD AT COOLING PEAK**  
is the electric demand of all electric equipment calculated in **LOADS** and **SYSTEMS** at the time of maximum cooling.

----- N U M B E R   O F   H O U R S -----      --COINCIDENT LOADS--

MONTH	HOURS COOLING LOAD	HOURS HEATING LOAD	HOURS COINCIDENT COOL-HEAT LOAD	HOURS FLOATING	HOURS HEATING AVAIL.	HOURS COOLING AVAIL.	HOURS FANS ON	HOURS FANS CYCLE ON	HOURS NIGHT VENTING	HOURS FLOATING WHEN FANS ON	HEATING LOAD AT COOLING PEAK (KBTU/HR)	ELECTRIC LOAD AT COOLING PEAK (KW)
JAN	0	305	0	439	744	0	305	63	0	0	0.000	0.475
FEB	0	256	0	416	672	0	256	47	0	0	0.000	0.475
MAR	0	240	0	504	715	29	248	17	0	8	0.000	0.475
APR	69	102	0	549	516	204	229	0	0	58	0.000	11.735
MAY	115	40	0	589	485	259	220	0	0	65	0.000	13.348
JUN	203	0	0	517	171	549	207	0	0	4	0.000	15.156
JUL	241	0	0	503	7	737	241	0	0	0	0.000 <sup>s</sup>	17.942
AUG	238	0	0	506	43	701	238	0	0	0	0.000	16.987
SEP	155	13	0	552	346	374	205	0	0	37	0.000	14.658
OCT	99	86	1	560	511	233	225	0	0	41	0.000	11.103
NOV	12	186	0	522	686	34	209	1	0	11	0.000	12.583
DEC	0	276	0	468	744	0	276	45	0	0	0.000	0.475
ANNUAL	1132	1504	1	6125	5640	3120	2859	173	0	224		

## REPORT SS-F

### ZONE DEMAND SUMMARY

This report gives monthly values of eight different zone-related quantities. The user-name of the zone is given in the title of the report, along with the name of the HVAC system that serves this zone. Found in this report are the monthly sums for zone heating and cooling demands from the HVAC system, minimum and maximum zone air temperatures, and the number of hours the loads are not met in the zone. The report is presented zone-by-zone.

1. HEAT EXTRACTION ENERGY  
and  
HEAT ADDITION ENERGY (millions of Btu)  
are the sensible cooling energy and heating energy requirements, respectively, of this zone during the HVAC system operation hours. For RESYS systems, the heat extraction may include natural ventilation. For plenums, these values are for heat removed from or added to the return air. For unconditioned zones, these values should be zero.
2. BASEBOARD ENERGY (millions of Btu)  
and  
MAXIMUM BASEBOARD LOAD (thousands of Btu/hr)  
When the keyword BASEBOARD-RATIO is used, the zone heating is supplied by baseboards. Monthly heating energy requirements for these baseboards are reported in addition to the peak heating requirement.
3. MAXIMUM ZONE TEMPERATURE (°F)  
and  
MINIMUM ZONE TEMPERATURE (°F).  
The monthly maximum and minimum air temperatures in this zone during system operation (when fans are operating) are reported for checking space temperature variations.
4. HOURS UNDERHEATED  
and  
HOURS UNDERCOOLED  
If the capacity of the HVAC system is less than the hourly heat extraction or heat addition load for this zone, a load-not-met condition is recorded as either an underheated or undercooled hour. The number of hours reported as underheated or undercooled may be start-ups after a night shutdown of the HVAC system.

- - - D E M A N D S - - - - - B A S E B O A R D S - - - - - T E M P E R A T U R E S - - - - - L O A D S N O T M E T - -								
MONTH	HEAT EXTRACTION ENERGY (MBTU)	HEAT ADDITION ENERGY (MBTU)	BASEBOARD ENERGY (MBTU)	MAXIMUM BASEBOARD LOAD (KBTU/HR)	MAXIMUM ZONE TEMP (F)	MINIMUM ZONE TEMP (F)	HOURS UNDER HEATED	HOURS UNDER COOLED
JAN	0.32026	-3.393	0.00000	0.000	76.3	55.8	0	0
FEB	0.31210	-2.703	0.00000	0.000	76.1	55.8	0	0
MAR	0.62230	-1.443	0.00000	0.000	75.4	55.9	0	0
APR	1.70057	-0.336	0.00000	0.000	77.7	67.0	7	0
MAY	2.46513	-0.006	0.00000	0.000	77.9	70.9	0	0
JUN	3.35010	0.000	0.00000	0.000	78.3	75.1	0	0
JUL	5.25626	0.000	0.00000	0.000	79.1	76.7	0	0
AUG	4.63841	0.000	0.00000	0.000	78.9	76.5	0	0
SEP	3.21619	-0.015	0.00000	0.000	78.6	70.7	0	0
OCT	1.96739	-0.144	0.00000	0.000	77.9	70.3	0	0
NOV	0.62700	-1.258	0.00000	0.000	77.9	55.9	0	0
DEC	0.16774	-2.819	0.00000	0.000	75.2	55.8	0	0

**REPORT SS-G**  
**ZONE LOADS SUMMARY**

Zone cooling, heating, and electrical requirements are reported in this monthly summary. The user name of the zone is in the title line with the name of the HVAC system serving the zone. The cooling and heating energy reported is supplied *only at the zone level* (such as for reheat coils). Often heating and cooling loads are reported as zero in this report when the central HVAC system (e.g., a dual duct system) provides all the heating and cooling.

1. **COOLING ENERGY**  
and  
**HEATING ENERGY**

(millions of Btu). This is the monthly energy delivered by zone coils and baseboards during scheduled operation hours.

2. **MAXIMUM COOLING LOAD**  
and  
**MAXIMUM HEATING LOAD**

(thousands of Btu/hr). The peak energy delivered by zone coils and baseboards for cooling and heating, respectively. Includes sensible and latent space cooling loads, ventilation air, and fan heat. The peak cooling load shown here is often the start-up load after the system has been shut down overnight. Notice, however, that when the system size is inadequate to meet the start-up load there is no indication of this problem on the report. You should first inspect the PLANT program BEPS or BEPU report, which shows the "Percent of Hours Any System Zone Outside of Throttling Range", for a macro view, and at SS-O or SS-F for a zonal report of where "loads not met" conditions prevail. To the left of these columns are the day and hour of the peak cooling load along with the outside dry-bulb and wet-bulb temperatures at the time of the peak.

3. **TIME OF MAX (DY, HR) DRY-BULB TEMP**  
and  
**WET-BULB TEMP**

The day and hour of the peak zone coil loads are reported; these times may be for startup loads. The temperatures reported are the outdoor air temperatures at the time of the peak zone coil plus baseboard loads.

4. **ELECTRICAL ENERGY**  
and  
**MAXIMUM ELECTRICAL LOAD (kWh)**

The monthly total and peaks of electrical energy use in this zone, including lights, fans, and compressors and electric coils in packaged HVAC units.

MONTH	C O O L I N G					H E A T I N G					E L E C	
	COOLING ENERGY (MBTU)	TIME OF MAX DY HR	DRY- BULB TEMP	WET- BULB TEMP	MAXIMUM COOLING LOAD (KBTU/HR)	HEATING ENERGY (MBTU)	TIME OF MAX DY HR	DRY- BULB TEMP	WET- BULB TEMP	MAXIMUM HEATING LOAD (KBTU/HR)	ELEC- TRICAL ENERGY (KWH)	MAXIMUM ELEC LOAD (KW)
JAN	0.00000				0.000	-1.833	7 8	-1.F	-1.F	-33.294	257.	1.049
FEB	0.00000				0.000	-1.383	4 8	7.F	6.F	-32.993	223.	1.049
MAR	0.00000				0.000	-0.787	18 8	32.F	30.F	-27.981	247.	1.049
APR	0.00000				0.000	-0.157	1 8	43.F	39.F	-20.941	256.	1.049
MAY	0.00000				0.000	-0.006	9 9	43.F	39.F	-3.124	257.	1.049
JUN	0.00000				0.000	0.000				0.000	236.	1.049
JUL	0.00000				0.000	0.000				0.000	257.	1.049
AUG	0.00000				0.000	0.000				0.000	257.	1.049
SEP	0.00000				0.000	-0.005	23 8	36.F	34.F	-5.325	236.	1.049
OCT	0.00000				0.000	-0.068	21 8	30.F	29.F	-20.095	257.	1.049
NOV	0.00000				0.000	-0.834	18 8	34.F	34.F	-25.152	226.	1.049
DEC	0.00000				0.000	-1.567	26 8	15.F	15.F	-30.723	247.	1.049
TOTAL	0.000					-6.641					2957.	
MAX					0.000					-33.294		1.049

**REPORT SS-H**  
**SYSTEM MONTHLY LOADS SUMMARY**

This report gives monthly values of electrical energy for fans, gas/oil energy for heating and cooling, and electrical energy for heating and cooling for an HVAC system. The name of the system (SYST-1) is shown in the title.

1. **FAN ELEC**  
shows the total and maximum hourly electrical consumption of the supply, return, exhaust, and zonal fans.
2. **FUEL HEAT**  
shows the total oil and gas consumption by packaged systems for heating, in Btu-equivalents. This will be zero unless you have made at least one of the heat sources FURNACE.
3. **FUEL COOL**  
shows the total oil and gas consumption by packaged systems for cooling, in Btu-equivalents.
4. **ELEC HEAT**  
shows the electrical consumption for heating. This will include electric baseboards and reheat coils as well as the electrical load attributable to the heating cycle of a heat pump.
5. **ELEC COOL**  
shows the electrical consumption and hourly maxima for cooling.



MONTH	- FAN ELEC - - -		- FUEL HEAT - -		- FUEL COOL - -		- ELEC HEAT - -		- ELEC COOL - -	
	FAN ENERGY (KWH)	MAXIMUM FAN LOAD (KW)	GAS OIL ENERGY (MBTU)	MAXIMUM GAS OIL LOAD (KBTU/HR)	GAS OIL ENERGY (MBTU)	MAXIMUM GAS OIL LOAD (KBTU/HR)	ELECTRIC ENERGY (KWH)	MAXIMUM ELECTRIC LOAD (KW)	ELECTRIC ENERGY (KWH)	MAXIMUM ELECTRIC LOAD (KW)
JAN	256.	3.984	0.000	0.000	0.000	0.000	0.	0.000	0.	0.000
FEB	215.	3.878	0.000	0.000	0.000	0.000	0.	0.000	0.	0.000
MAR	195.	3.320	0.000	0.000	0.000	0.000	0.	0.000	0.	0.000
APR	182.	2.198	0.000	0.000	0.000	0.000	0.	0.000	0.	0.000
MAY	263.	2.955	0.000	0.000	0.000	0.000	0.	0.000	0.	0.000
JUN	469.	4.156	0.000	0.000	0.000	0.000	0.	0.000	0.	0.000
JUL	958.	7.304	0.000	0.000	0.000	0.000	0.	0.000	0.	0.000
AUG	724.	5.987	0.000	0.000	0.000	0.000	0.	0.000	0.	0.000
SEP	346.	4.123	0.000	0.000	0.000	0.000	0.	0.000	0.	0.000
OCT	173.	1.794	0.000	0.000	0.000	0.000	0.	0.000	0.	0.000
NOV	171.	3.021	0.000	0.000	0.000	0.000	0.	0.000	0.	0.000
DEC	231.	3.543	0.000	0.000	0.000	0.000	0.	0.000	0.	0.000
TOTAL	4181.		0.000		0.000		0.		0.	
MAX		7.304		0.000		0.000		0.000		0.000

**REPORT SS-I**  
**SYSTEM MONTHLY SENSIBLE-LATENT SUMMARY**

This is a summary of the monthly cooling and heating energy provided by each HVAC system. The quantities shown are the sum of zone-level loads and central air-handling-unit loads. Shown are sensible cooling, latent cooling, maximum cooling (sensible plus latent) with the corresponding sensible heat ratio, and the day and hour the maximum cooling occurs. Also shown are sensible heating, latent heating, and maximum heating (sensible plus latent).

1. **SENSIBLE COOLING ENERGY**  
(millions of Btu) is the monthly sum of sensible energy extracted by the HVAC system.
2. **LATENT COOLING ENERGY**  
(millions of Btu) is the monthly sum of latent energy extracted by the HVAC system.  
The sum of 1 and 2 should equal COOLING ENERGY in SS-A.
3. **MAX TOTAL COOLING ENERGY**  
(thousands of Btu/hr) is the hourly peak energy (sensible plus latent) extracted by the system during the month.
4. **SENSIBLE HEAT RATIO AT MAX**  
is the sensible heat ratio (sensible cooling/total cooling) for the hour that the maximum total cooling occurs.
5. **TIME OF MAX DY HR**  
is the day and hour during which the total peak cooling load occurred.
6. **SENSIBLE HEATING ENERGY**  
(millions of Btu) is the monthly sum of sensible energy added by the HVAC system.
7. **LATENT HEATING ENERGY**  
(millions of Btu) is the monthly sum of latent energy extracted by the HVAC system.  
The sum of 6 and 7 should equal HEATING ENERGY in SS-A.

MONTH	SENSIBLE COOLING ENERGY (MBTU)	LATENT COOLING ENERGY (MBTU)	MAX TOTAL COOLING ENERGY (KBTU/HR)	SENSIBLE HEAT RATIO AT MAX	TIME OF MAX DY HR	SENSIBLE HEATING ENERGY (MBTU)	LATENT HEATING ENERGY (MBTU)	MAX TOTAL HEATING ENERGY (KBTU/HR)
JAN	0.00000	0.00000	0.000			-32.54049	0.00000	-441.10925
FEB	0.00000	0.00000	0.000			-25.22139	0.00000	-419.19385
MAR	0.00000	0.00000	0.000			-15.18957	0.00000	-377.56302
APR	1.46930	0.05734	68.311	0.848	29 18	-3.70518	0.00000	-246.024
MAY	4.54812	0.55252	132.661	0.777	21 14	-0.42017	0.00000	-40.320
JUN	13.34809	1.21146	178.041	0.793	20 16	0.00000	0.00000	0.000
JUL	25.94250	2.84016	214.902	0.883	8 16	0.00000	0.00000	0.000
AUG	21.18397	2.49544	183.011	0.919	19 16	0.00000	0.00000	0.000
SEP	8.60116	0.63464	138.083	0.849	11 16	-0.22747	0.00000	-99.033
OCT	2.17180	0.09753	49.778	1.000	4 17	-2.19046	0.00000	-258.277
NOV	0.35701	0.00072	54.561	1.000	1 16	-12.99550	0.00000	-325.673
DEC	0.00000	0.00000	0.000			-25.76809	0.00000	-393.06366
TOTAL	77.622	7.890				-118.258	0.000	
MAX			214.902	0.883				-441.109

## REPORT SS-J

### SYSTEM PEAK HEATING AND COOLING DAYS

For each HVAC system, this report gives an hourly profile of three types of peak day that occur during the RUN-PERIOD:

- Under -- COOLING --, the day that contains the hour with the maximum (sensible plus latent) cooling energy.
- Under -- HEATING --, the day that contains the hour with the maximum heating energy.
- Under DAY COOLING PEAK, the day whose *integrated* cooling load (i.e., load summed over 24 hours) is maximum. This day can be used to size thermal energy storage systems; however, to insure that the peak integrated load shown here is truly represented, you should examine reports SS-O and SS-F, which show the number of hours that cooling loads are *not* met.

#### 1. HOUR

gives the hour of the day, ranging from hour 1 (midnight to 1 am) to hour 24 (11 pm to midnight). Even if DAYLIGHT-SAVINGS = YES, summer hours will *not* reflect daylight saving time.

#### 2. HOURLY COOLING LOAD (thousands of Btu)

is the total hourly energy, sensible plus latent, extracted by the HVAC system. The cooling load is followed by an asterisk when the system is unable to meet the cooling demand for that hour. This means that in at least one zone served by this system there is an unmet cooling load *and* the zone temperature is outside the throttling range.

#### 3. SENSIBLE HEAT RATIO

is the ratio of sensible to total cooling energy for the given hour.

#### 4. DRY-BULB TEMP and WET-BULB TEMP

are the outside dry-bulb and wet-bulb temperatures, respectively, for the given hour.

#### 5. HOURLY HEATING LOAD (thousands of Btu)

is the hourly heating energy delivered by the HVAC system. For SYSTEM-TYPE = RESYS and RESVVT, this includes baseboard heating energy. The heating load is followed by an asterisk when the system is unable to meet the heating demand for that hour. This means that in at least one zone served by the system, there is an unmet heating load *and* the zone temperature is outside the throttling range.

#### 6. A separate report is provided whenever a DESIGN-DAY is input in the LOADS section.

#### 7. Bottom of Report

Some additional information is shown at the bottom of the SS-J report.

##### SYSTEM-TYPE

is the DOE-2 code-word for the type of this HVAC system.

##### SQFT/TON

is the area served by this system divided by the peak cooling in tons.

COOLING PEAK (Btu/hr-ft<sup>2</sup>)

is the peak cooling divided by the area served by this system.

HEATING PEAK (Btu/hr-ft<sup>2</sup>)

is the peak heating divided by the area served by this system.

SUPPLY AIR PEAK FLOW (cfm/ft<sup>2</sup>)

is the design supply air flow divided by area served by this system.

MIN-OA/PERSON (cfm)

is the design minimum outside air flow divided by the maximum number of people in all the zones served by this system.

OA FRAC AT HTG PEAK

is the outside air fraction (outside air flow relative to supply flow) at the peak heating hour.

OA FRAC AT CLG PEAK

is the outside air fraction at the peak cooling hour.

- - - - COOLING - - - -					- - - HEATING - - -			DAY COOLING PEAK			
JUL 8					JAN 7			JUL 8			
HOURLY	COOLING	SENSIBLE	DRY-	WET-	HOURLY	DRY-	WET-	HOURLY	SENSIBLE	DRY-	WET-
LOAD	LOAD	HEAT	BULB	BULB	HEATING	BULB	BULB	COOLING	HEAT	BULB	BULB
(KBTU)	(KBTU)	RATIO	TEMP	TEMP	(KBTU)	TEMP	TEMP	(KBTU)	RATIO	TEMP	TEMP
1	0.000	0.000	76.F	68.F	0.000	6.F	6.F	0.000	0.000	76.F	68.F
2	0.000	0.000	76.F	68.F	-146.914	4.F	4.F	0.000	0.000	76.F	68.F
3	0.000	0.000	75.F	68.F	0.000	2.F	2.F	0.000	0.000	75.F	68.F
4	0.000	0.000	74.F	68.F	-155.152	2.F	2.F	0.000	0.000	74.F	68.F
5	0.000	0.000	73.F	67.F	0.000	2.F	2.F	0.000	0.000	73.F	67.F
6	0.000	0.000	72.F	67.F	-163.423	1.F	1.F	0.000	0.000	72.F	67.F
7	164.625 *	0.913	72.F	67.F	0.000	0.F	0.F	164.625 *	0.913	72.F	67.F
8	184.814 *	0.860	77.F	70.F	-441.109	-1.F	-1.F	184.814 *	0.860	77.F	70.F
9	182.204 *	0.855	83.F	72.F	-287.347	0.F	0.F	182.204 *	0.855	83.F	72.F
10	193.900 *	0.841	86.F	74.F	-233.795	2.F	1.F	193.900 *	0.841	86.F	74.F
11	196.262 *	0.865	89.F	74.F	-198.142	4.F	3.F	196.262 *	0.865	89.F	74.F
12	193.265 *	0.901	90.F	73.F	-167.741	6.F	5.F	193.265 *	0.901	90.F	73.F
13	202.205 *	0.898	91.F	73.F	-149.663	8.F	6.F	202.205 *	0.898	91.F	73.F
14	208.722 *	0.900	92.F	73.F	-128.669	9.F	7.F	208.722 *	0.900	92.F	73.F
15	214.902 *	0.883	92.F	74.F	-112.424	10.F	8.F	214.902 *	0.883	92.F	74.F
16	205.470	0.905	93.F	73.F	-106.730	9.F	7.F	205.470	0.905	93.F	73.F
17	201.179	0.903	93.F	73.F	-107.148	8.F	6.F	201.179	0.903	93.F	73.F
18	0.000	0.000	92.F	73.F	-115.849	5.F	4.F	0.000	0.000	92.F	73.F
19	0.000	0.000	90.F	72.F	0.000	4.F	3.F	0.000	0.000	90.F	72.F
20	0.000	0.000	83.F	70.F	0.000	2.F	1.F	0.000	0.000	83.F	70.F
21	0.000	0.000	82.F	68.F	0.000	3.F	2.F	0.000	0.000	82.F	68.F
22	0.000	0.000	82.F	70.F	0.000	4.F	3.F	0.000	0.000	82.F	70.F
23	0.000	0.000	82.F	70.F	0.000	4.F	3.F	0.000	0.000	82.F	70.F
24	0.000	0.000	80.F	69.F	0.000	5.F	4.F	0.000	0.000	80.F	69.F
SUM											
MAX	214.902				-441.109			2147.547			

SYSTEM-TYPE	VAVS	SQFT/TON	279.2
COOLING PEAK	42.98 (BTU/HR- SQFT)	HEATING PEAK	-88.22 (BTU/HR- SQFT)
SUPPLY AIR PEAK FLOW	1.27 (CFM/SQFT)	MIN-OA/PERSON	20.40 (CFM )
OA FRAC AT CLG PEAK	0.172	OA FRAC AT HTG PEAK	0.230

\* ASTERISKS INDICATE HOURS LOADS NOT MET

Page left intentionally blank

**REPORT SS-K**  
**SPACE TEMPERATURE SUMMARY**

This report gives a monthly summary of various temperature quantities for the spaces served by the HVAC system shown in the report title. This report is intended to help you to determine the potential for night ventilation as a cooling strategy. Blank entries indicate that no hours existed in a particular category.

1. **AVERAGE SPACE TEMP ALL HOURS**  
gives the temperature averaged over all hours in the run.
2. **AVERAGE SPACE TEMP COOLING HOURS**  
gives the temperature only in hours when cooling was required.
3. **AVERAGE SPACE TEMP HEATING HOURS**  
gives the average temperature only in hours when heating was required.
4. **AVERAGE SPACE TEMP FAN ON HOURS**  
gives the average temperature only when the fans are running.
5. **AVERAGE SPACE TEMP FAN OFF HOURS**  
gives the average temperature only when the fans are not running.
6. **AVERAGE TEMPERATURE DIFFERENCE BETWEEN OUTDOOR & ROOM AIR, ALL HOURS**  
takes the sum of (outdoor temperature - room air temperature) over all hours and divides this quantity by the number of hours.
7. **AVERAGE TEMPERATURE DIFFERENCE BETWEEN OUTDOOR & ROOM AIR, FAN ON HOURS**  
takes the sum of (outdoor temperature - room air temperature) over hours when the fans are on and divides this quantity by the number of hours the fans are on.
8. **AVERAGE TEMPERATURE DIFFERENCE BETWEEN OUTDOOR & ROOM AIR, FAN OFF HOURS**  
takes the sum of (outdoor temperature - room air temperature) over hours when the fans are off and divides this quantity by the number of hours the fans are off.
9. **SUMMED TEMP DIFFERENCE BETWEEN OUTDOOR & ROOM AIR, HEATING HOURS**  
takes the sum of the absolute value of (outdoor temperature - room air temperature) over all hours when heating is required and divides by 24.
10. **SUMMED TEMP DIFFERENCE BETWEEN OUTDOOR & ROOM AIR, ALL HOURS**  
takes the sum of the absolute value of (outdoor temperature - room air temperature) over all hours in the run and divides by 24.



Note: 9 and 10 above are "degree-day"-like quantities.

11. HUMIDITY RATIO DIFFERENCE BETWEEN OUTDOOR & ROOM AIR  
gives the average of (outdoor humidity ratio - room air humidity ratio) over all hours in the run.

MONTH	AVERAGE SPACE TEMP					AVERAGE TEMPERATURE DIFFERENCE			SUMMED TEMP DIFFERENCE		HUMIDITY RATIO DIFFERENCE BETWEEN OUTDOOR AND ROOM AIR (FRAC.OR MULT. )
	ALL HOURS (F)	COOLING HOURS (F)	HEATING HOURS (F)	FAN ON HOURS (F)	FAN OFF HOURS (F)	BETWEEN OUTDOOR& ROOM AIR ALL HOURS (F)	BETWEEN OUTDOOR& ROOM AIR FAN ON HOURS (F)	BETWEEN OUTDOOR& ROOM AIR FAN OFF HOURS (F)	BETWEEN OUTDOOR& ROOM AIR HEATING HOURS (F)	BETWEEN OUTDOOR& ROOM AIR ALL HOURS (F)	
JAN	62.16		65.65	65.65	59.74	-36.82	-40.46	-34.29	514.20	1141.49	-0.00103
FEB	62.36		66.19	66.19	60.00	-34.84	-38.08	-32.85	406.20	975.57	-0.00091
MAR	65.34		68.59	68.71	63.66	-26.97	-30.75	-25.09	311.82	840.66	-0.00110
APR	71.74	74.21	70.63	72.68	71.31	-20.15	-19.85	-20.29	116.27	607.26	-0.00082
MAY	75.54	77.37	71.89	75.96	75.36	-18.76	-15.96	-19.94	41.85	583.60	-0.00072
JUN	79.66	78.22		78.16	80.27	-12.57	-6.37	-15.07		387.11	-0.00075
JUL	82.88	79.19		79.19	84.65	-7.31	-1.39	-10.15		289.98	0.00127
AUG	80.77	78.62		78.62	81.79	-8.93	-2.62	-11.89		310.85	0.00056
SEP	77.10	77.70	71.08	76.84	77.21	-15.72	-9.76	-18.09	12.59	482.64	-0.00109
OCT	71.86	74.74	70.77	73.07	71.34	-18.22	-15.71	-19.30	86.06	564.90	-0.00107
NOV	66.11	76.39	69.27	69.92	64.54	-25.16	-29.14	-23.53	240.00	754.84	-0.00068
DEC	62.48		66.48	66.48	60.13	-30.75	-34.66	-28.45	398.62	953.37	-0.00099
ANNUAL	71.55	77.78	67.66	72.23	71.23	-21.27	-21.42	-21.20	2127.60	7892.27	-0.00061

Page left intentionally blank

## REPORT SS-L

### FAN ELECTRIC ENERGY FOR <system>

This report gives a breakdown of monthly electric energy for fans (central and zone-level) and fan part load operation for an HVAC system.

The energy quantities on the left-hand side of the report are given for heating hours only, cooling hours only, simultaneous heating and cooling hours, and floating hours.

1. FAN ELECTRIC ENERGY DURING HEATING  
gives the total electric energy used by the fans in all hours when only heating is required.
2. FAN ELECTRIC ENERGY DURING COOLING  
gives the total electric energy used by the fans in all hours when only cooling is required.
3. FAN ELECTRIC ENERGY DURING HEATING-COOLING  
gives the total electric energy used by the fans in all hours when both heating and cooling are required.
4. FAN ELECTRIC ENERGY DURING FLOATING  
gives the total electric energy used by the fans when neither heating nor cooling is provided.

The right-hand side of the report shows the part-load operation of the fans. The number of operating hours within each percentage part load band (0-10%, 0-20% , etc.) is given as well as the total hours of operation. If the fan operates during an hour, its part load in percent is determined as  $100 * (\text{total flow}) / (\text{design SUPPLY-CFM})$ .

MONTH	FAN ELEC DURING HEATING (KWH)	FAN ELEC DURING COOLING (KWH)	FAN ELEC DURING HEAT & COOL (KWH)	FAN ELEC DURING FLOATING (KWH)	Number of hours within each PART LOAD range											TOTAL RUN HOURS
					00 10	10 20	20 30	30 40	40 50	50 60	60 70	70 80	80 90	90 100	100 +	
JAN	256.361	0.000	0.000	0.000	0	0	0	286	10	4	4	1	0	0	0	305
FEB	214.658	0.000	0.000	0.000	0	0	0	239	10	3	3	1	0	0	0	256
MAR	188.892	0.000	0.000	5.833	0	0	0	242	3	1	2	0	0	0	0	248
APR	77.282	59.311	0.000	45.241	0	0	0	216	11	2	0	0	0	0	0	229
MAY	29.165	172.787	0.000	61.428	0	0	0	144	45	27	4	0	0	0	0	220
JUN	0.000	465.212	0.000	3.377	0	0	0	23	49	80	51	4	0	0	0	207
JUL	0.000	957.790	0.000	0.000	0	0	0	1	9	35	72	66	29	28	1	241
AUG	0.000	723.851	0.000	0.000	0	0	0	9	24	62	91	40	12	0	0	238
SEP	9.505	303.856	0.000	32.739	0	0	0	88	45	37	32	3	0	0	0	205
OCT	63.882	77.672	0.729	31.766	0	0	0	224	1	0	0	0	0	0	0	225
NOV	148.524	13.215	0.000	8.918	0	0	0	200	5	2	2	0	0	0	0	209
DEC	230.728	0.000	0.000	0.000	0	0	0	259	11	0	6	0	0	0	0	276
ANNUAL	1218.994	2773.703	0.729	189.301	0	0	0	1931	223	253	267	115	41	28	1	2859

**REPORT SS-M**  
**FAN ELECTRIC ENERGY FOR PLANT**

This report gives a breakdown of fan electric energy for each month passed to PLANT. The quantities are given for heating hours only, cooling hours only, simultaneous heating and cooling hours, and floating hours. The quantities are calculated by summing the individual space quantities.

1. **FAN ELECTRIC ENERGY DURING HEATING**  
gives the total electric energy used by the fans in all hours when only heating is required.
2. **FAN ELECTRIC ENERGY DURING COOLING**  
gives the total electric energy used by the fans in all hours when only cooling is required.
3. **FAN ELECTRIC ENERGY DURING HEATING-COOLING**  
gives the total electric energy used by the fans in all hours when both heating and cooling are required.
4. **FAN ELECTRIC ENERGY DURING FLOATING**  
gives the total electric energy used by the fans when neither heating nor cooling is provided.

SIMPLE STRUCTURE RUN 3, CHICAGO  
 DESIGN-DAY SIZING OF VAV SYSTEM  
 REPORT- SS-M FAN ELECTRIC ENERGY FOR PLANT

DIVIDE INTO ZONES; ADD PLENUM  
 SHOW ALL REPORTS  
 DEFAULT-PLANT

DOE-2.1E-001 Thu Nov 4 15:19:02 1993SDL RUN 1  
 WEATHER FILE- TRY CHICAGO

MONTH	FAN ELECTRIC ENERGY DURING HEATING (KWH)	FAN ELECTRIC ENERGY DURING COOLING (KWH)	FAN ELECTRIC ENERGY DURING HEATING-COOLING (KWH)	FAN ELECTRIC ENERGY DURING FLOATING (KWH)
JAN	256.361	0.000	0.000	0.000
FEB	214.658	0.000	0.000	0.000
MAR	188.892	0.000	0.000	5.833
APR	77.282	59.311	0.000	45.241
MAY	29.165	172.787	0.000	61.428
JUN	0.000	465.212	0.000	3.377
JUL	0.000	957.790	0.000	0.000
AUG	0.000	723.851	0.000	0.000
SEP	9.505	303.856	0.000	32.739
OCT	63.882	77.672	0.729	31.766
NOV	148.524	13.215	0.000	8.918
DEC	230.728	0.000	0.000	0.000
ANNUAL	1218.994	2773.703	0.729	189.301

**REPORT SS-N**  
**RELATIVE HUMIDITY SCATTER PLOT**

In this scatter plot, the ordinate, appearing in the left column, shows relative humidity bins. The abscissa, shown at the top, gives hours of the day. Entered in each cell of the plot is the number of hours during the RUN-PERIOD for which the relative humidity of the system return air was in the particular relative humidity bin for this particular hour of the day. Only hours for which the fans are on are counted in this plot.

The column at the far right is the sum of the entries in each row. It shows the frequency of relative humidity values for the RUN-PERIOD. (Because the relative humidity counts are made only for hours when the fans are on, summing the totals column will not sum to the number of hours in the run.)

Note: If fans are on due to NIGHT-CYCLE-CTRL, the hours will not be counted in the plot.



SIMPLE STRUCTURE RUN 3, CHICAGO  
 DESIGN-DAY SIZING OF VAV SYSTEM  
 REPORT- SS-N RELATIVE HUMIDITY SCATTER PLOT FOR

DIVIDE INTO ZONES; ADD PLENUM  
 SHOW ALL REPORTS  
 SYST-1

DOE-2.1E-001 Thu Nov 4 15:19:02 1993SDL RUN 1  
 WEATHER FILE- TRY CHICAGO

TOTAL HOURS AT RELATIVE HUMIDITY LEVEL AND TIME OF DAY

HOUR	1AM	2	3	4	5	6	7	8	9	10	11	12	1PM	2	3	4	5	6	7	8	9	10	11	12	TOTAL
80-100	0	0	0	0	0	0	0	0	0	0	0	0	0	0	1	0	0	0	0	0	0	0	0	0	1
70-80	0	0	0	0	0	0	0	0	0	1	0	0	0	1	0	1	1	0	0	0	0	0	0	0	4
60-70	0	0	0	0	0	0	0	6	5	5	5	4	4	2	2	3	3	3	0	0	0	0	0	0	42
50-60	0	0	0	0	0	0	0	45	58	57	53	32	33	29	28	34	35	4	0	0	0	0	0	0	408
40-50	0	0	0	0	0	0	0	42	43	45	41	60	61	69	66	59	61	9	0	0	0	0	0	0	556
30-40	0	0	0	0	0	0	0	26	62	61	57	49	38	48	52	55	51	27	0	0	0	0	0	0	526
0-30	0	0	0	0	0	0	0	7	83	84	96	107	116	103	103	100	101	83	0	0	0	0	0	0	983
====																									

**REPORT SS-O**  
**TEMPERATURE SCATTER PLOT**

In this scatter plot, the ordinate, appearing in the left column, shows temperature bins. The abscissa, shown at the top, gives hours of the day. Entered in each cell of the plot is the number of hours during the RUN-PERIOD for which the zone air temperature was in the particular bin for this particular hour of the day. Only hours for which the fans are on are counted in this plot.

The column at the far right is the sum of the entries in each row. It shows the frequency of temperature values for the RUN-PERIOD. (Because the temperature counts are only made for hours when the fans are on, summing the totals column will not sum to the number of hours in the run.)

Note: If fans are on due to NIGHT-CYCLE-CTRL, the hours will not be counted in the plot.

SIMPLE STRUCTURE RUN 3, CHICAGO  
 DESIGN-DAY SIZING OF VAV SYSTEM  
 REPORT- SS-0 TEMPERATURE SCATTER PLOT

DIVIDE INTO ZONES; ADD PLENUM  
 SHOW ALL REPORTS  
 SYST-1 FOR SPACE1-1

DOE-2.1E-001 Thu Nov 4 15:19:02 1993SDL RUN 1  
 WEATHER FILE- TRY CHICAGO

TOTAL HOURS AT TEMPERATURE LEVEL AND TIME OF DAY

HOUR	1AM	2	3	4	5	6	7	8	9	10	11	12	1PM	2	3	4	5	6	7	8	9	10	11	12	TOTAL
ABOVE 85	0	0	0	0	0	0	0	0	0	0	0	0	0	0	0	0	0	0	0	0	0	0	0	0	0
80-85	0	0	0	0	0	0	0	0	0	0	0	0	0	0	0	0	0	0	0	0	0	0	0	0	0
75-80	0	0	0	0	0	0	0	88	90	96	100	106	119	132	141	144	139	15	0	0	0	0	0	0	1170
70-75	0	0	0	0	0	0	0	38	162	156	152	145	132	119	110	107	112	110	0	0	0	0	0	0	1343
65-70	0	0	0	0	0	0	0	0	0	0	0	1	1	1	1	1	1	1	1	0	0	0	0	0	7
60-65	0	0	0	0	0	0	0	0	0	0	0	0	0	0	0	0	0	0	0	0	0	0	0	0	0
BELOW 60	0	0	0	0	0	0	0	0	0	0	0	0	0	0	0	0	0	0	0	0	0	0	0	0	0

## REPORT SS-P (for SYSTEM)

LOAD, ENERGY AND PART LOAD HEATING IN [u-name of SYSTEM]

LOAD, ENERGY AND PART LOAD COOLING IN [u-name of SYSTEM]

Report SS-P is produced at both the SYSTEM and PLANT-ASSIGNMENT levels. The following description is for the SYSTEMS-level report. See "REPORT SS-P (for PLANT-ASSIGNMENT)", following, for a description of the PLANT-ASSIGNMENT level.

Two SS-P reports are produced for each unit or system: one for heating operation and one for cooling operation. These reports are provided for:

- (1) each PSZ, PVAVS, RESYS, RESVVT, or PTAC system if SS-H is requested
- (2) each zone in a PTAC or HP system if either SS-H or SS-L is requested in the SYSTEMS-REPORT command.

### 1. UNIT TYPE

is the DOE-2 code-word for this HVAC system.

### 2. COOLING-CAPACITY

COOLING-EIR

HEATING-CAPACITY

HEATING-EIR

SUPPLY-FLOW

are as reported on SV-A for this system.

### 3. UNIT LOAD

is the total and peak heating/cooling load on the unit.

### 4. ENERGY USE

is the total and peak electric energy used by the unit. This includes the compressor, outdoors fans, pumps, auxiliaries (UNIT-AUX-KW), crankcase heat and evaporative precooler.

### 5. COMPRESSOR

is the total and electric energy used by the engine/motor, not including the crankcase heat.

### 6. FAN ENERGY

is the total and peak fan energy during the time the unit is in the heating/cooling mode.

### 7. Number of hours within each PART LOAD range

shows the number of hours that the unit (top line) or indoor fan (bottom line) spend in the various part load ranges when in the heating/cooling mode. If the unit is on during the hour, and the operation is within the specified range, the count of hours is incremented by 1.

SINGLE FAMILY RESIDENCE  
 CUSTOM WEIGHTING FACTORS  
 REPORT- SS-P LOAD, ENERGY AND PART LOAD HEATING IN SYS-1

CONVENTIONAL DESIGN  
 2 zones - living & sleeping

DOE-2.1E-001 Thu Nov 4 15:07:28 1993SDL RUN 1  
 RUN 1: RESYS with on/off heat pump  
 WEATHER FILE- TRY CHICAGO

UNIT TYPE is RESYS HEATING-CAPACITY = -26.902 (KBTU/HR) HEATING-EIR = 0.306 (BTU/BTU) SUPPLY-FLOW = 700. (CFM )

MONTH	UNIT LOAD SUM (MBTU) PEAK (KBTU/HR) DAY/HR	ENERGY USE (KWH) (KW)	COMPRESSOR (KWH) (KW)	FAN ENERGY (KWH) (KW)	Number of hours within each PART LOAD range											TOTAL RUN HOURS
					00 10	10 20	20 30	30 40	40 50	50 60	60 70	70 80	80 90	90 100	100 +	
JAN	SUM -8.435 PEAK -26.016 DAY/HR 5/ 8	1776.244 7.031 0/ 0	936.988 2.611 18/ 8	40.019 0.090 0/ 0	CMP 14 FAN 16	23 31	47 93	87 87	58 77	54 83	79 29	38 34	21 35	34 21	138 213	593 719
FEB	SUM -7.162 PEAK -25.750 DAY/HR 25/ 8	1252.991 7.031 0/ 0	949.996 2.520 22/ 8	35.432 0.090 0/ 0	CMP 17 FAN 21	32 36	68 83	43 56	48 62	63 56	37 59	45 67	58 55	61 51	152 105	624 651
MAR	SUM -4.952 PEAK -26.144 DAY/HR 25/ 8	833.268 7.031 0/ 0	711.649 2.533 29/ 8	21.055 0.090 0/ 0	CMP 54 FAN 52	78 78	97 145	101 154	118 90	71 35	29 14	11 10	13 8	7 6	48 43	627 635
APR	SUM -1.741 PEAK -19.285 DAY/HR 8/ 8	292.476 3.084 0/ 0	277.148 2.210 9/ 8	7.099 0.080 0/ 0	CMP 100 FAN 94	69 88	71 88	48 39	27 25	19 8	1 2	7 2	2 1	1 0	2 0	347 347
MAY	SUM -0.603 PEAK -14.396 DAY/HR 6/ 8	97.248 1.849 0/ 0	90.321 1.837 6/ 8	3.514 0.052 0/ 0	CMP 97 FAN 90	45 53	24 23	4 7	3 3	3 2	0 0	2 0	0 0	0 0	0 0	178 178
JUN	SUM -0.024 PEAK -3.626 DAY/HR 1/ 8	5.123 0.544 0/ 0	4.955 0.501 1/ 8	7.585 0.058 0/ 0	CMP 10 FAN 10	4 4	0 0	0 0	0 0	0 0	0 0	0 0	0 0	0 0	0 0	14 14
JUL	SUM 0.000 PEAK 0.000 DAY/HR 31/ 1	0.000 0.000 0/ 0	0.000 0.000 0/ 0	17.734 0.072 0/ 0	CMP 0 FAN 0	0 0	0 0	0 0	0 0	0 0	0 0	0 0	0 0	0 0	0 0	0 0
AUG	SUM 0.000 PEAK 0.000 DAY/HR 31/ 1	0.000 0.000 0/ 0	0.000 0.000 0/ 0	13.182 0.057 0/ 0	CMP 0 FAN 0	0 0	0 0	0 0	0 0	0 0	0 0	0 0	0 0	0 0	0 0	0 0
SEP	SUM -0.273 PEAK -14.430 DAY/HR 22/ 8	47.516 2.111 0/ 0	44.323 2.102 23/ 8	4.816 0.056 0/ 0	CMP 37 FAN 36	27 27	7 8	2 4	2 1	1 1	0 1	0 0	2 0	0 0	0 0	78 78
OCT	SUM -1.252 PEAK -17.532 DAY/HR 21/ 8	217.553 3.016 0/ 0	205.063 2.380 21/ 8	4.778 0.074 0/ 0	CMP 112 FAN 110	93 104	40 41	23 21	8 11	8 5	4 2	4 1	1 2	1 0	3 0	297 297
NOV	SUM -4.124 PEAK -20.693 DAY/HR 26/ 8	679.801 3.919 0/ 0	648.998 2.495 30/ 8	17.037 0.090 0/ 0	CMP 58 FAN 58	91 105	102 127	82 102	69 81	75 54	42 28	23 13	15 3	5 3	15 3	577 577
DEC	SUM -6.934 PEAK -25.461 DAY/HR 9/ 8	1254.878 6.284 0/ 0	1154.847 2.611 13/ 8	31.495 0.090 0/ 0	CMP 11 FAN 15	19 28	48 107	102 136	90 109	100 125	109 53	76 47	39 29	29 19	86 41	709 709
YR	SUM -35.500 PEAK -26.144 MON/DAY 0/ 0	6457.068 7.031 0/ 0	5024.282 2.611 12/13	203.749 0.090 0/ 0	CMP 510 FAN 502	481 554	504 715	492 606	423 459	394 369	301 188	206 174	151 133	138 100	444 405	4044 4205

SINGLE FAMILY RESIDENCE  
 CUSTOM WEIGHTING FACTORS  
 REPORT- SS-P LOAD, ENERGY AND PART LOAD COOLING IN SYS-1

CONVENTIONAL DESIGN  
 2 zones - living & sleeping

DOE-2.1E-001 Thu Nov 4 15:07:28 1993SDL RUN 1  
 RUN 1: RESYS with on/off heat pump  
 WEATHER FILE- TRY CHICAGO

UNIT TYPE is RESYS COOLING-CAPACITY = 24.000 (KBTU/HR) COOLING-EIR = 0.343 (BTU/BTU) SUPPLY-FLOW = 700. (CFM)

MONTH	UNIT LOAD SUM (MBTU) PEAK (KBTU/HR) DAY/HR	ENERGY USE (KWH) (KW)	COMPRESSOR (KWH) (KW)	FAN ENERGY (KWH) (KW)	Number of hours within each PART LOAD range											TOTAL RUN HOURS	
					00	10	20	30	40	50	60	70	80	90	100		
JAN	SUM 0.000 PEAK 0.000 DAY/HR 31/24	0.600 0.025 0/0	0.000 0.000 0/0	40.019 0.090 0/0	0	0	0	0	0	0	0	0	0	0	0	0	0
FEB	SUM 0.000 PEAK 0.000 DAY/HR 28/24	0.500 0.025 0/0	0.000 0.000 0/0	35.432 0.090 0/0	0	0	0	0	0	0	0	0	0	0	0	0	0
MAR	SUM 0.000 PEAK 0.000 DAY/HR 31/24	1.475 0.025 0/0	0.000 0.000 0/0	21.055 0.090 0/0	0	0	0	0	0	0	0	0	0	0	0	0	0
APR	SUM 0.117 PEAK 5.487 DAY/HR 28/15	22.790 0.678 0/0	21.440 0.678 28/15	7.099 0.080 0/0	27	21	2	0	0	0	0	0	0	0	0	0	50
MAY	SUM 0.313 PEAK 10.998 DAY/HR 21/14	49.293 1.165 0/0	47.693 1.165 21/14	3.514 0.052 0/0	43	32	18	3	2	0	0	0	0	0	0	0	98
JUN	SUM 1.493 PEAK 13.441 DAY/HR 20/18	200.083 1.442 0/0	199.958 1.442 20/18	7.585 0.058 0/0	87	112	96	38	4	5	0	0	0	0	0	0	342
JUL	SUM 3.616 PEAK 15.402 DAY/HR 13/17	441.365 1.743 0/0	441.365 1.743 13/18	17.734 0.072 0/0	104	118	141	133	62	25	7	0	0	0	0	0	590
AUG	SUM 2.676 PEAK 12.303 DAY/HR 26/17	336.878 1.393 0/0	336.878 1.393 26/17	13.182 0.057 0/0	104	130	145	87	43	3	0	0	0	0	0	0	512
SEP	SUM 0.751 PEAK 10.882 DAY/HR 11/15	108.297 1.182 0/0	107.197 1.182 11/15	4.816 0.056 0/0	69	68	37	18	6	0	0	0	0	0	0	0	198
OCT	SUM 0.051 PEAK 2.916 DAY/HR 5/16	16.477 0.468 0/0	14.752 0.468 5/16	4.778 0.074 0/0	42	2	0	0	0	0	0	0	0	0	0	0	44
NOV	SUM 0.035 PEAK 4.121 DAY/HR 2/13	7.546 0.556 0/0	6.046 0.556 2/13	17.037 0.090 0/0	6	8	0	0	0	0	0	0	0	0	0	0	14
DEC	SUM 0.000 PEAK 0.000 DAY/HR 31/24	0.775 0.025 0/0	0.000 0.000 0/0	31.495 0.090 0/0	0	0	0	0	0	0	0	0	0	0	0	0	0
YR	SUM 9.052 PEAK 15.402 MON/DAY 0/0	1186.083 1.743 0/0	1175.328 1.743 7/13	203.749 0.090 0/0	482	491	439	279	117	33	7	0	0	0	0	0	1848

Page left intentionally blank

**REPORT SS-P (for PLANT-ASSIGNMENT)**

**LOAD, ENERGY AND PART LOAD PUMP OPERATION FOR [u-name of PLANT-ASSIGNMENT]**

**LOAD, ENERGY AND PART LOAD BOILER OPERATION FOR [u-name of PLANT-ASSIGNMENT]**

**LOAD, ENERGY AND PART LOAD COOLING TOWER OPERATION FOR [u-name of PLANT-ASSIGNMENT]**

**LOAD, ENERGY AND PART LOAD WATER-SIDE ECONO OPERATION FOR [u-name of PLANT-ASSIGNMENT]**

**LOAD, ENERGY AND PART LOAD DHW TANK OPERATION FOR [u-name of PLANT-ASSIGNMENT]**

A report is produced for:

- (1) each boiler, cooling tower, and loop circulation pumps in a PLANT-ASSIGNMENT that contains one or more water loop heat pump (HP) systems;
- (2) each cooling tower, circulation pump(s), and water-side economizer in a PLANT-ASSIGNMENT that contains one or more systems with CONDENSER-TYPE = WATER-COOLED (SYSTEM-TYPE = PSZ, PVAVS, or PVVT); and
- (3) each domestic hot water heating unit.

These reports are produced automatically if the equipment is present for the simulation unless PLANT-REPORTS = NO for the PLANT-ASSIGNMENT.

**-- PUMP REPORT --**

**CIRC PUMP SIZE**

is the rated total flow of the pump(s).

**POWER**

is the power draw at rated flow.

**HEAT GAIN**

is the heat added to the loop per hour due to pumping, at rated flow.

**MIN PLR**

is the minimum flow fraction.

**Monthly and Annual Values**

**HEAT GAIN**

is the heat added to the loop by the pump(s).

**ENERGY USE**

is the pumping electrical energy.

**HEAT MODE**

is the pumping electrical during loop net heating.

**COOL MODE**

is the pumping electrical during loop net cooling.



**-- BOILER REPORT --**

**BOILER SIZE**

is the rated capacity.

**EIR**

is (rated electric input)/capacity.

**HIR**

is (rated fuel input)/capacity.

**Monthly and Annual Values**

**UNIT LOAD**

is the heat supplied by the boiler to the loop.

**ENERGY USE**

is the boiler electrical consumption.

**FUEL USE**

is the boiler fuel consumption.

**AUX ENERGY**

is the boiler auxiliary energy (fans, pumps, etc.)

**-- COOLING TOWER REPORT --**

**TOWER SIZE**

is the rated heat rejection capacity.

**FAN**

is the fan electrical consumption.

**PUMP (first instance)**

is the spray pump motor electrical consumption.

**PUMP (second instance)**

is the spray pump water flow.

**Monthly and Annual Values**

**UNIT LOAD**

is the heat rejected by the tower.

**ENERGY USE**

is the tower electrical use (fans and pumps).

**FAN ENERGY**

is the tower fan(s) electrical use.

**PUMP ENERGY**

is the tower spray pump(s) electrical use.

**-- WATER SIDE ECONOMIZER REPORT --**

**WSE TOWER SIZE**

is not currently used.

**POWER**

is not currently used.

**PUMP**

is the maximum water flow through the units.

**Monthly and Annual Values**

**UNIT LOAD**

is the total heat rejection cooling done by the water side economizer coils in all units connected to this PLANT-ASSIGNMENT.

**ENERGY USE**

is currently unused.

**-- DHW REPORT --**

**TANK SIZE**

is the tank water volume in gallons or liters.

**HEATER CAP**

is the rated amount of energy per hour the heater can supply to the tank water.

**FLOW RATE**

is the rated water flow rate from the tank.

**PUMP**

is the tank water pump rated electrical power.

**Monthly and Annual Values**

**UNIT LOAD**

is the energy content of the hot water provided by the tank.

**ENERGY USE**

is the energy consumed by the tank heater.

**RCV EN USE**

is the recovered energy added to the tank water.

**PUMP ENERGY**

is the tank water pump electrical consumption.

**-- FOR ALL REPORTS --**

**NUMBER OF HOURS WITHIN EACH PART LOAD RANGE**

This set of 12 columns shows the number of hours that the equipment spent in the various part load ranges. If the unit is on during the hour, and the operation is within the specified range, the count of hours is incremented by 1. For the boiler, cooling tower and domestic hot water heater, the value used to calculate the range for the hour is the load divided by the operating capacity. For the pumps the range is calculated using the loop flow divided by the pump(s) rated capacity. For the water side economizer the range is calculated using the total flow through all units WSE coils during the hour divided by the maximum WSE coil flow.

CIRC PUMP SIZE is 221.6 (GAL/MIN ) POWER = 3.56 (KW) HEAT GAIN = 10946. (BTU/HR) or 0.1 (DEG F) MIN PLR = 0.50

MONTH	SUM PEAK DAY/HR	HEAT GAIN	ENERGY USE	HEAT MODE	COOL MODE	Number of hours within each PART LOAD range										TOTAL RUN HOURS	
		(MBTU)	(KWH)	(KWH)	(KWH)	00	10	20	30	40	50	60	70	80	90		100
		(KBTU/HR)	(KW)	(KW)	(KW)	10	20	30	40	50	60	70	80	90	100		+
JAN	SUM PEAK DAY/HR	3.643 10.935 30/21	1185.962 3.560 30/21	1175.030 3.560 30/21	10.931 0.475 30/ 8	0	0	0	0	0	23	0	0	0	0	327	350
FEB	SUM PEAK DAY/HR	3.337 10.935 27/21	1086.284 3.560 27/21	1075.352 3.560 27/21	10.931 0.475 27/ 8	0	0	0	0	0	23	0	0	0	0	299	322
MAR	SUM PEAK DAY/HR	3.867 10.935 31/21	1258.993 3.560 31/21	1245.209 3.560 31/21	13.783 0.475 31/ 8	0	0	0	0	0	29	6	0	0	0	343	378
APR	SUM PEAK DAY/HR	3.614 10.935 30/21	1176.510 3.560 30/21	1052.566 3.560 28/17	123.942 1.780 30/21	0	0	0	0	0	38	11	0	0	0	315	364
MAY	SUM PEAK DAY/HR	3.448 10.935 29/21	1122.506 3.560 29/21	848.640 3.560 29/18	273.866 1.780 29/21	0	0	0	0	0	41	9	0	0	0	300	350
JUN	SUM PEAK DAY/HR	3.624 10.935 30/21	1179.844 3.560 30/21	663.765 3.560 30/10	516.079 1.780 30/21	0	0	0	0	0	29	22	0	0	0	313	364
JUL	SUM PEAK DAY/HR	3.724 10.935 31/21	1212.264 3.560 31/21	631.051 3.560 31/10	581.212 1.780 31/21	0	0	0	0	0	25	10	0	0	0	329	364
AUG	SUM PEAK DAY/HR	3.676 10.935 31/21	1196.832 3.560 31/21	664.275 3.560 31/19	532.557 1.780 31/21	0	0	0	0	0	26	17	0	0	0	321	364
SEP	SUM PEAK DAY/HR	3.455 10.935 30/21	1124.839 3.560 30/21	688.745 3.560 30/21	436.094 1.780 28/21	0	0	0	0	0	38	12	0	0	0	300	350
OCT	SUM PEAK DAY/HR	3.463 10.935 30/21	1127.448 3.560 30/21	1003.065 3.560 28/14	124.383 1.780 30/21	0	0	0	0	0	37	12	0	0	0	301	350
NOV	SUM PEAK DAY/HR	3.415 10.935 30/21	1111.808 3.560 30/21	1054.952 3.560 30/21	56.856 1.780 2/21	0	0	0	0	0	26	9	0	0	0	301	336
DEC	SUM PEAK DAY/HR	3.627 10.935 30/21	1180.743 3.560 30/21	1168.861 3.560 30/21	11.882 0.475 30/ 8	0	0	0	0	0	25	0	0	0	0	325	350
YR	SUM PEAK MON/DAY	42.895 10.935 12/30	13963.502 3.560 12/30	11271.005 3.560 12/30	2692.509 1.780 11/ 2	0	0	0	0	0	360	108	0	0	0	3774	4242

BOILER SIZE is -0.6098 (MBTU/HR) EIR = 0.0200 HIR = 1.250

MONTH	UNIT LOAD SUM (MBTU) PEAK (KBTU/HR) DAY/HR	ENERGY USE (KWH) (KW)	FUEL USE (MBTU) (KBTU/HR)	AUX ENERGY (KWH) (KW)	----- Number of hours within each PART LOAD range -----											TOTAL RUN HOURS
					00	10	20	30	40	50	60	70	80	90	100	
					10	20	30	40	50	60	70	80	90	100	+	
JAN	SUM -110.683 PEAK -1359.261 DAY/HR 12/13	1055.125 3.573 30/11	144.363 1455.959 12/13	1055.125 3.573 30/11	0	0	165	43	9	14	13	10	8	7	57	326
FEB	SUM -85.352 PEAK -1319.901 DAY/HR 11/ 9	1006.353 3.573 27/13	117.867 1424.074 11/ 9	1006.353 3.573 27/13	0	0	136	80	13	7	6	13	17	14	27	313
MAR	SUM -50.692 PEAK -1280.542 DAY/HR 24/13	954.361 3.573 31/ 9	77.561 1391.685 24/13	954.361 3.573 31/ 9	0	0	296	24	12	3	2	4	0	1	4	346
APR	SUM -19.799 PEAK -271.916 DAY/HR 8/ 9	457.749 3.573 9/ 9	32.232 389.724 8/ 9	457.749 3.573 9/ 9	0	0	220	1	1	0	0	0	0	0	0	222
MAY	SUM -10.608 PEAK -132.187 DAY/HR 10/ 9	248.650 3.098 10/ 9	17.335 216.012 10/ 9	248.650 3.098 10/ 9	0	0	161	0	0	0	0	0	0	0	0	161
JUN	SUM -0.652 PEAK -65.622 DAY/HR 24/ 9	15.280 1.538 24/ 9	1.065 107.235 24/ 9	15.280 1.538 24/ 9	0	0	20	0	0	0	0	0	0	0	0	20
JUL	SUM 0.000 PEAK 0.000 DAY/HR 31/ 1	0.000 0.000 31/ 1	0.000 0.000 31/ 1	0.000 0.000 31/ 1	0	0	0	0	0	0	0	0	0	0	0	0
AUG	SUM 0.000 PEAK 0.000 DAY/HR 31/ 1	0.000 0.000 31/ 1	0.000 0.000 31/ 1	0.000 0.000 31/ 1	0	0	0	0	0	0	0	0	0	0	0	0
SEP	SUM -7.025 PEAK -105.678 DAY/HR 23/ 9	164.663 2.477 23/ 9	11.480 172.693 23/ 9	164.663 2.477 23/ 9	0	0	113	0	0	0	0	0	0	0	0	113
OCT	SUM -17.745 PEAK -192.320 DAY/HR 21/ 9	413.945 3.573 21/ 9	28.960 296.562 21/ 9	413.945 3.573 21/ 9	0	0	237	2	0	0	0	0	0	0	0	239
NOV	SUM -42.219 PEAK -557.426 DAY/HR 26/11	833.155 3.573 30/21	65.852 706.934 26/11	833.155 3.573 30/21	0	0	262	22	3	6	6	4	1	1	0	305
DEC	SUM -79.213 PEAK -1214.943 DAY/HR 9/ 9	1116.614 3.573 30/13	113.840 1336.584 9/ 9	1116.614 3.573 30/13	0	0	186	73	10	14	22	9	6	14	11	345
YR	SUM -423.986 PEAK -1359.261 MON/DAY 1/12	6265.896 3.573 12/30	610.555 1455.959 1/12	6265.896 3.573 12/30	0	0	1796	245	48	44	49	40	32	37	99	2390

TOWER SIZE is 1.225 (MBTU/HR) FAN = 3.66 (KW) PUMP = 1.20 (KW) PUMP = 221.57 (GAL/MIN )

MONTH	SUM PEAK DAY/HR	UNIT LOAD	ENERGY USE	FAN ENERGY	PUMP ENERGY	----- Number of hours within each PART LOAD range -----											TOTAL RUN HOURS	
		(MBTU)	(KWH)	(KWH)	(KWH)	00	10	20	30	40	50	60	70	80	90	100		+
		(KBTU/HR)	(KW)	(KW)	(KW)	10	20	30	40	50	60	70	80	90	100			
JAN	SUM 2.243 PEAK 378.301 DAY/HR 8/ 8	63.976 1.676 30/16	14.583 0.472 30/16	49.393 1.205 30/21	13	21	3	3	1	0	0	0	0	0	0	0	41	
FEB	SUM 1.165 PEAK 139.217 DAY/HR 25/10	64.872 1.625 27/21	14.275 0.420 27/21	50.597 1.205 27/21	27	14	0	1	0	0	0	0	0	0	0	0	42	
MAR	SUM 10.975 PEAK 394.537 DAY/HR 25/ 8	248.917 1.780 2/14	62.255 0.575 2/14	186.661 1.205 31/17	46	46	19	17	28	0	0	0	0	0	0	0	156	
APR	SUM 60.897 PEAK 569.546 DAY/HR 27/17	546.262 2.165 27/17	150.793 0.960 27/17	395.472 1.205 30/21	12	31	32	55	179	21	0	0	0	0	0	0	330	
MAY	SUM 98.644 PEAK 852.670 DAY/HR 21/13	616.264 3.478 21/13	201.684 2.273 21/13	414.582 1.205 29/21	2	18	20	34	176	89	5	3	0	0	0	0	347	
JUN	SUM 180.367 PEAK 1041.354 DAY/HR 21/16	751.460 3.373 21/18	322.672 2.168 21/18	428.791 1.205 30/21	2	4	12	18	85	155	82	5	0	0	0	0	363	
JUL	SUM 272.506 PEAK 1115.039 DAY/HR 19/12	972.118 4.440 13/13	537.429 3.235 13/13	434.691 1.205 31/21	0	0	6	16	12	81	169	56	21	3	0	0	364	
AUG	SUM 232.257 PEAK 1062.108 DAY/HR 16/12	857.705 3.689 26/17	425.691 2.484 26/17	432.016 1.205 31/21	0	3	6	12	37	131	146	28	1	0	0	0	364	
SEP	SUM 113.299 PEAK 901.351 DAY/HR 11/16	637.064 3.001 11/16	220.041 1.796 11/16	417.025 1.205 30/21	2	16	22	24	169	98	19	0	0	0	0	0	350	
OCT	SUM 47.454 PEAK 352.851 DAY/HR 30/16	539.542 1.897 13/21	146.225 0.692 13/21	393.319 1.205 30/21	16	43	23	69	178	0	0	0	0	0	0	0	329	
NOV	SUM 20.475 PEAK 602.232 DAY/HR 1/12	270.878 2.244 1/12	77.862 1.039 1/12	193.016 1.205 30/ 8	42	44	17	13	25	21	0	0	0	0	0	0	162	
DEC	SUM 0.928 PEAK 162.244 DAY/HR 9/10	44.368 1.573 15/ 8	9.431 0.368 15/ 8	34.936 1.205 30/16	15	13	0	1	0	0	0	0	0	0	0	0	29	
YR	SUM 1041.210 PEAK 1115.039 MON/DAY 7/19	5613.422 4.440 7/13	2182.943 3.235 7/13	3430.384 1.205 12/30	177	253	160	263	890	596	421	92	22	3	0	0	2877	

WSE TOWER SIZE is 0.0000 (MBTU/HR) POWER = 0.00 (KW) PUMP = 32.63 (GAL/MIN )

MONTH	UNIT LOAD SUM (MBTU) PEAK (KBTU/HR) DAY/HR	ENERGY USE (KWH) (KW)	Number of hours within each PART LOAD range											TOTAL RUN HOURS		
			00	10	20	30	40	50	60	70	80	90	100			
			10	20	30	40	50	60	70	80	90	100	+			
JAN	SUM PEAK DAY/HR	0.000 0.000 31/24	0.000 0.000 31/24	0	0	0	0	0	0	0	0	0	0	0	0	0
FEB	SUM PEAK DAY/HR	0.000 0.000 28/24	0.000 0.000 28/24	0	0	0	0	0	0	0	0	0	0	0	0	0
MAR	SUM PEAK DAY/HR	0.100 22.266 3/17	0.000 0.000 31/24	2	1	0	0	0	1	1	0	1	0	3	9	
APR	SUM PEAK DAY/HR	1.333 24.376 26/15	0.000 0.000 30/ 1	20	16	12	9	3	13	13	4	3	1	36	130	
MAY	SUM PEAK DAY/HR	1.534 24.512 23/15	0.000 0.000 31/ 1	26	37	17	16	15	16	7	5	4	2	42	187	
JUN	SUM PEAK DAY/HR	4.829 29.525 26/20	0.000 0.000 30/ 1	29	21	22	20	24	25	19	20	13	17	171	381	
JUL	SUM PEAK DAY/HR	4.173 23.922 12/12	0.000 0.000 31/ 1	6	10	11	6	13	11	15	9	13	13	231	338	
AUG	SUM PEAK DAY/HR	4.534 25.767 31/13	0.000 0.000 31/ 1	9	12	9	15	15	13	15	17	22	16	222	365	
SEP	SUM PEAK DAY/HR	2.764 24.713 6/18	0.000 0.000 30/ 1	22	22	18	15	20	23	17	12	8	15	66	238	
OCT	SUM PEAK DAY/HR	1.344 23.806 4/17	0.000 0.000 31/24	13	9	17	18	10	8	10	9	4	3	23	124	
NOV	SUM PEAK DAY/HR	0.461 23.395 1/17	0.000 0.000 30/24	3	2	3	3	5	0	2	0	3	0	14	35	
DEC	SUM PEAK DAY/HR	0.000 0.000 31/24	0.000 0.000 31/24	0	0	0	0	0	0	0	0	0	0	0	0	
YR	SUM PEAK MON/DAY	21.073 29.525 6/26	0.000 0.000 12/31	130	130	109	102	105	110	99	76	71	67	808	1807	

SINGLE FAMILY RESIDENCE  
 CUSTOM WEIGHTING FACTORS  
 REPORT- SS-P LOAD, ENERGY AND PART LOAD DHW TANK OPERATION FOR PLANT1

CONVENTIONAL DESIGN  
 2 zones - living & sleeping

DOE-2.1E-001 Thu Nov 4 15:07:28 1993SDL RUN 1  
 RUN 1: RESYS with on/off heat pump  
 WEATHER FILE- TRY CHICAGO

TANK SIZE is 30.0 ( GAL ) HEATER CAP = 25.774 (KBTU/HR) FLOW RATE = 0.375 (GAL/MIN ) PUMP = 0.000 (KW)

MONTH	UNIT LOAD SUM (MBTU) PEAK (KBTU/HR) DAY/HR	ENERGY USE (KWH) (KW)	RCV EN USE (KWH) (KW)	PUMP ENERGY (KWH) (KW)	Number of hours within each PART LOAD range											TOTAL RUN HOURS
					00	10	20	30	40	50	60	70	80	90	100	
					10	20	30	40	50	60	70	80	90	100	+	
JAN	SUM 2.781 PEAK 18.767 DAY/HR 31/ 9	978.461 5.719 31/ 9	0.000 0.000 31/24	0.000 0.000 31/24	558	0	0	0	0	124	0	62	0	0	0	744
FEB	SUM 2.587 PEAK 19.330 DAY/HR 28/ 9	910.286 5.890 28/ 9	0.000 0.000 28/24	0.000 0.000 28/24	504	0	0	0	0	112	0	56	0	0	0	672
MAR	SUM 2.809 PEAK 18.955 DAY/HR 31/ 9	988.242 5.776 31/ 9	0.000 0.000 31/24	0.000 0.000 31/24	558	0	0	0	0	124	0	62	0	0	0	744
APR	SUM 2.584 PEAK 18.017 DAY/HR 30/ 9	909.023 5.490 30/ 9	0.000 0.000 30/ 1	0.000 0.000 30/ 1	540	0	0	0	120	0	0	60	0	0	0	720
MAY	SUM 2.475 PEAK 16.703 DAY/HR 31/ 9	870.824 5.090 31/ 9	0.000 0.000 31/ 1	0.000 0.000 31/ 1	558	0	0	0	124	0	62	0	0	0	0	744
JUN	SUM 2.207 PEAK 15.389 DAY/HR 30/ 9	776.454 4.689 30/ 9	0.000 0.000 30/ 1	0.000 0.000 30/ 1	540	0	0	0	120	0	60	0	0	0	0	720
JUL	SUM 2.114 PEAK 14.263 DAY/HR 31/ 9	743.631 4.346 31/ 9	0.000 0.000 31/ 1	0.000 0.000 31/ 1	558	0	0	124	0	62	0	0	0	0	0	744
AUG	SUM 2.058 PEAK 13.888 DAY/HR 31/ 9	724.058 4.232 31/ 9	0.000 0.000 31/ 1	0.000 0.000 31/ 1	558	0	0	124	0	62	0	0	0	0	0	744
SEP	SUM 2.045 PEAK 14.263 DAY/HR 30/ 9	719.643 4.346 30/ 9	0.000 0.000 30/ 1	0.000 0.000 30/ 1	540	0	0	120	0	60	0	0	0	0	0	720
OCT	SUM 2.253 PEAK 15.201 DAY/HR 31/ 9	792.550 4.632 31/ 9	0.000 0.000 31/24	0.000 0.000 31/24	558	0	0	0	124	0	62	0	0	0	0	744
NOV	SUM 2.368 PEAK 16.515 DAY/HR 30/ 9	833.267 5.033 30/ 9	0.000 0.000 30/24	0.000 0.000 30/24	540	0	0	0	120	0	60	0	0	0	0	720
DEC	SUM 2.642 PEAK 17.829 DAY/HR 31/ 9	929.540 5.433 31/ 9	0.000 0.000 31/24	0.000 0.000 31/24	558	0	0	0	124	0	0	62	0	0	0	744
YR	SUM 28.922 PEAK 19.330 MON/DAY 2/28	10175.467 5.890 2/28	0.000 0.000 12/31	0.000 0.000 12/31	6570	0	0	368	732	544	244	302	0	0	0	8760

## REPORT SS-Q

### HEAT PUMP COOLING AND HEATING SUMMARY FOR [u-name of SYSTEM or PLANT-ASSIGNMENT]

Two reports, one for heating operation and one for cooling operation, are produced for each PLANT-ASSIGNMENT or SYSTEM that contains an electric or gas heat pump or a furnace. These reports are provided for each PSZ, PVAVS, RESYS, RESVVT, and PTAC system if SS-A is requested, or for each PLANT-ASSIGNMENT if SS-D is requested in the SYSTEMS-REPORT command. The PLANT-ASSIGNMENT reports contain the sum of the values from all the SYSTEM reports.

1. UNIT RUN TIME (hours)  
is the total run time for all the gas heat pumps, or the sum of the hourly part load ratios for all the furnaces and electric heat pumps in the SYSTEM or PLANT-ASSIGNMENT. If a system serves several zones, each of which has a separate heat pump, the run time is the total run time of all the heat pumps. For example, if, in a particular hour, each of the heat pumps in three zones runs for 0.5 hours, then "UNIT RUN TIME" is incremented by  $3 \times 0.5 = 1.5$ .
2. TOTAL LOAD ON UNIT (MBtu)  
is the total heating/cooling load on all the units (including the defrost load for heat pumps) in the SYSTEM or PLANT-ASSIGNMENT.
3. ENERGY INTO UNIT (MBtu)  
is the electric or fuel energy into all of the units to provide heating or cooling; doesn't include auxiliaries for the unit except those included in the base EIR or HIR.
4. AUXILIARY ENERGY (MBtu)  
is the energy for outdoor fans, evaporative precoolers, auxiliary electrical, or pumps for the units.
5. SUP UNIT LOAD (MBtu)  
is the total load on the supplemental heating units. This includes time when the supplemental unit is operating alone or in conjunction with the heat pump.
6. SUP UNIT ENERGY (MBtu)  
is the energy into the supplemental heating units.
7. WASTE HEAT GENERATED (MBtu)  
is the recoverable waste heat generated by the units.
8. WASTE HEAT USE (MBtu)  
is the amount of waste heat used to meet the domestic hot water loads.
9. DEFROST LOAD (MBtu)  
is the heating load imposed when running in defrost mode.



10. INDOOR FAN ENERGY (MBtu)  
is the electric consumption of the indoor fans during the heating/cooling mode.
  
11. CSPF (WITH PARASITICS), CSPF (WITHOUT PARASITICS), HSPF (WITH PARASITICS), HSPF (WITHOUT PARASITICS)  
are the cooling and heating season performance factors as computed with and without parasitics. The value *without* parasitics is the total load (main and supplemental) divided by the total energy consumed (main plus supplemental). The value *with* parasitics adds all the auxiliaries (pumps, fans, etc.) to the energy consumed and subtracts the indoor fan heat from the load (increases heating load and decreases cooling load).

SINGLE FAMILY RESIDENCE  
 CUSTOM WEIGHTING FACTORS  
 REPORT- SS-Q HEAT PUMP COOLING SUMMARY FOR SYS-1

CONVENTIONAL DESIGN  
 2 zones - living & sleeping

DOE-2.1E-001 Thu Nov 4 15:07:28 1993SDL RUN 1  
 RUN 1: RESYS with on/off heat pump  
 WEATHER FILE- TRY CHICAGO

UNIT RUN TIME (HOURS)	TOTAL LOAD ON UNIT (MBTU)	ENERGY IN TO UNIT (MBTU)	AUXILIARY ENERGY (MBTU)	SUP UNIT LOAD (MBTU)	SUP UNIT ENERGY (MBTU)	WASTE HEAT GENERATED (MBTU)	WASTE HEAT USE (MBTU)	INDOOR FAN ENERGY (MBTU)
JAN	0.	0.000	0.000	0.002	0.000	0.000	0.000	0.019
FEB	0.	0.000	0.000	0.002	0.000	0.000	0.000	0.004
MAR	0.	0.000	0.000	0.005	0.000	0.000	0.000	0.001
APR	5.	0.117	0.073	0.005	0.000	0.000	0.000	0.002
MAY	13.	0.313	0.163	0.005	0.000	0.000	0.000	0.005
JUN	62.	1.493	0.682	0.000	0.000	0.000	0.000	0.026
JUL	151.	3.616	1.506	0.000	0.000	0.000	0.000	0.061
AUG	111.	2.676	1.150	0.000	0.000	0.000	0.000	0.045
SEP	31.	0.751	0.366	0.004	0.000	0.000	0.000	0.013
OCT	2.	0.051	0.050	0.006	0.000	0.000	0.000	0.001
NOV	1.	0.035	0.021	0.005	0.000	0.000	0.000	0.001
DEC	0.	0.000	0.000	0.003	0.000	0.000	0.000	0.000
ANNUAL	377.	9.052	4.011	0.037	0.000	0.000	0.000	0.177

CSPF (WITH PARASITICS) = 2.14 (BTU/BTU)

CSPF (WITHOUT PARASITICS) = 2.26 (BTU/BTU)

SINGLE FAMILY RESIDENCE  
 CUSTOM WEIGHTING FACTORS  
 REPORT- SS-Q HEAT PUMP HEATING SUMMARY FOR SYS-1

CONVENTIONAL DESIGN  
 2 zones - living & sleeping

DOE-2.1E-001 Thu Nov 4 15:07:28 1993SDL RUN 1  
 RUN 1: RESYS with on/off heat pump  
 WEATHER FILE- TRY CHICAGO

UNIT RUN TIME (HOURS)	TOTAL LOAD ON UNIT (MBTU)	ENERGY IN TO UNIT (MBTU)	AUXILIARY ENERGY (MBTU)	SUP UNIT LOAD (MBTU)	SUP UNIT ENERGY (MBTU)	WASTE HEAT GENERATED (MBTU)	WASTE HEAT USE (MBTU)	DEFROST LOAD (MBTU)	INDOOR FAN ENERGY (MBTU)	
JAN	405.	-5.578	3.198	0.046	-2.974	2.812	0.000	0.000	-0.117	0.118
FEB	433.	-6.132	3.242	0.039	-1.123	0.991	0.000	0.000	-0.093	0.117
MAR	280.	-4.557	2.429	0.064	-0.452	0.340	0.000	0.000	-0.058	0.071
APR	91.	-1.695	0.946	0.040	-0.067	0.004	0.000	0.000	-0.021	0.022
MAY	24.	-0.583	0.308	0.021	-0.021	0.000	0.000	0.000	-0.001	0.007
JUN	1.	-0.024	0.017	0.001	0.000	0.000	0.000	0.000	0.000	0.000
JUL	0.	0.000	0.000	0.000	0.000	0.000	0.000	0.000	0.000	0.000
AUG	0.	0.000	0.000	0.000	0.000	0.000	0.000	0.000	0.000	0.000
SEP	12.	-0.270	0.151	0.010	-0.004	0.000	0.000	0.000	-0.002	0.003
OCT	62.	-1.228	0.700	0.037	-0.038	0.004	0.000	0.000	-0.014	0.015
NOV	244.	-4.068	2.215	0.062	-0.125	0.036	0.000	0.000	-0.069	0.057
DEC	475.	-6.693	3.941	0.052	-0.411	0.278	0.000	0.000	-0.170	0.107
ANNUAL	2027.	-30.828	17.148	0.372	-5.217	4.464	0.000	0.000	-0.545	0.518

HSPF (WITH PARASITICS) = 1.60 (BTU/BTU)

HSPF (WITHOUT PARASITICS) = 1.64 (BTU/BTU)

Page left intentionally blank

## REPORT SUPL

### SYSTEM SUPPLEMENTAL EVAPORATIVE OR DESICCANT COOLING

This report is printed for each system that has a desiccant or evaporative cooling unit to supplement the mechanical cooling. These are systems for which the user has specified DESICCANT = LIQ-VENT-AIR-1, LIQ-VENT-AIR-2, or SOL-VENT-AIR-1; or EVAP-CL-TYPE = INDIRECT or INDIRECT-DIRECT. This report will not be printed for stand-alone desiccant or evaporative cooling systems (SYSTEM-TYPE = PTGSD or EVAP-COOL). In this case the usual SYSTEMS reports are used.

1. TOTAL COOLING ENERGY (MBtu)  
is the monthly sum of the energy (sensible and latent) removed by the supplemental unit from the supply air before it reaches the cooling coil.
2. SENSIBLE COOLING ENERGY (MBtu)  
is the monthly sum of the sensible energy removed by the supplemental unit.
3. LATENT COOLING ENERGY (MBtu)  
is the monthly sum of the latent energy removed by the supplemental unit.
4. HOURS ON  
is the total number of hours the unit was operating during the month.
5. ELECTRIC ENERGY (MBtu)  
is the monthly electrical consumption by the supplemental unit.
6. GAS OIL ENERGY (MBtu)  
is the fuel consumed by the supplemental unit for the month.

SMALL BAR/LOUGE  
 NEW FEATURES IN DOE2.1E RUN 2  
 REPORT- SUPL SYSTEM SUPPLEMENTAL EVAPORATIVE OR DESICCANT COOLING FOR SYS1

DEMO DESICCANT & EVAPORATIVE COOLING  
 SYSTEM 2: PKG ROOFTOP PSZ AC UNIT

DOE-2.1E-001 Fri Nov 5 09:23:28 1993SDL RUN 2  
 DESICCANT COOLING OF MIN OA  
 WEATHER FILE- TRY CHICAGO

MONTH	TOTAL COOLING ENERGY (MBTU)	SENSIBLE COOLING ENERGY (MBTU)	LATENT COOLING ENERGY (MBTU)	HOURS ON	ELECTRIC ENERGY (KWH)	GAS OIL ENERGY (MBTU)
JAN	0.00000	0.00000	0.00000	0	0.	0.00000
FEB	0.00000	0.00000	0.00000	0	0.	0.00000
MAR	0.44183	0.12643	0.31541	29	17.	1.15190
APR	2.96209	1.60152	1.36056	204	116.	6.79351
MAY	3.90973	0.96668	2.94304	249	144.	9.95194
JUN	8.92682	2.58435	6.34247	533	307.	20.52970
JUL	13.88187	0.88956	12.99232	705	411.	31.03108
AUG	12.53177	0.90114	11.63064	671	391.	29.44838
SEP	5.70114	2.40156	3.29958	360	205.	12.66627
OCT	3.29700	1.76097	1.53603	226	128.	7.46790
NOV	0.52543	0.22485	0.30058	34	19.	1.22540
DEC	0.00000	0.00000	0.00000	0	0.	0.00000
TOTAL	52.17781	11.45708	40.72067	3011	1739.	120.26609

**REPORT REFG**  
**REFRIGERATION EQUIPMENT SUMMARY**

This report gives monthly energy use for each system in which there is refrigerated case work.

1. **ZONAL SENSIBLE ENERGY (MBtu)**  
is the sensible heat gain to the zone from the refrigerated case work.
2. **ZONAL LATENT ENERGY (MBtu)**  
is the latent heat gain to the zone from the refrigerated case work.
3. **CONDENSER RECOVERED ENERGY (MBtu)**  
is the energy recovered from the condensers and used for space heating in the heat recovery mode.
4. **CONDENSER REJECTED ENERGY (MBtu)**  
is the energy rejected from the condensers.
5. **ELECTRIC COMPRESSOR ENERGY (KWH)**  
is the electrical energy consumed by the compressors.
6. **ELECTRIC DEFROST ENERGY (KWH)**  
is the electrical energy consumed by the defrosters.
7. **ELECTRIC AUXILIARY ENERGY (KWH)**  
is the electrical energy consumed by lights, fans, and anti-sweat heaters in the refrigerated cases.
8. **ELECTRIC TOTAL ENERGY (KWH)**  
is the total electric energy used by the refrigerated case work.

	- - - Z O N A L - - -		- C O N D E N S E R -		- - - - - E L E C T R I C - - - - -			
MONTH	SENSIBLE ENERGY (MBTU)	LATENT ENERGY (MBTU)	RECOVERED ENERGY (MBTU)	REJECTED ENERGY (MBTU)	COMPRESSOR ENERGY (KWH)	DEFROST ENERGY (KWH)	AUXILIARY ENERGY (KWH)	TOTAL ENERGY (KWH)
JAN	-8.046	-0.205	6.908	8.424	1794.952	35.595	424.873	2255.411
FEB	-7.333	-0.140	6.189	7.695	1625.032	28.059	363.958	2017.043
MAR	-8.388	-0.384	6.469	9.744	1878.904	58.981	507.071	2444.946
APR	-8.307	-0.608	3.170	13.050	1838.841	84.077	515.206	2438.115
MAY	-8.486	-0.894	2.027	14.932	1908.457	114.999	521.514	2544.957
JUN	-8.731	-1.099	0.117	17.577	1978.629	136.252	516.831	2631.697
JUL	-9.055	-1.266	0.000	18.882	2171.682	154.469	528.234	2854.374
AUG	-9.021	-1.288	0.000	18.730	2129.554	156.808	528.234	2814.581
SEP	-8.483	-0.886	0.728	16.082	1871.787	113.571	510.110	2495.458
OCT	-8.397	-0.700	2.804	13.678	1861.111	94.430	520.973	2476.498
NOV	-7.875	-0.458	5.471	9.854	1767.375	67.653	481.192	2316.209
DEC	-8.047	-0.262	6.998	8.443	1807.848	46.465	467.373	2321.676
TOTAL	-100.170	-8.190	40.883	157.091	22634.170	1091.359	5885.571	29610.965



# REPORT PV-A EQUIPMENT SIZES

SIMPLE STRUCTURE RUN 3, CHICAGO  
DESIGN-DAY SIZING OF VAV SYSTEM  
REPORT- PV-A EQUIPMENT SIZES

DIVIDE INTO ZONES; ADD PLENUM  
SHOW ALL REPORTS

DOE-2.1E-001 Thu Nov 4 15:19:02 1993PDL RUN 1

WEATHER FILE- TRY CHICAGO

EQUIPMENT	NUMBER		NUMBER		NUMBER		NUMBER		NUMBER		NUMBER	
	SIZE (MBTU/H)	INSTD AVAIL	SIZE (MBTU/H)	INSTD AVAIL	SIZE (MBTU/H)	INSTD AVAIL	SIZE (MBTU/H)	INSTD AVAIL	SIZE (MBTU/H)	INSTD AVAIL	SIZE (MBTU/H)	INSTD AVAIL
HW-BOILER	0.457	1 1										
HEM-REC-CHLR	0.222	1 1										

REPORT PV-B  
 COST REFERENCE DATA

SIMPLE STRUCTURE RUN 3, CHICAGO                      DIVIDE INTO ZONES; ADD PLENUM                      DOE-2.1E-001 Thu Nov 4 15:19:02 1993PDL RUN 1  
 DESIGN-DAY SIZING OF VAV SYSTEM                      SHOW ALL REPORTS  
 REPORT- PV-B COST REFERENCE DATA (USED FOR DEFAULT COSTS)                      WEATHER FILE- TRY CHICAGO

EQUIPMENT	SIZE (MBTU )	UNIT COST (K\$)	INSTALD COST FACTOR	CONSUM- ABLES (\$/HR)	MAINTA- NANCE (HRS/YR)	EQPMT LIFE (HRS)	HOURS ALREADY USED	HRS TO MINOR OVHAUL	MINOR OVHAUL COST (\$)	HRS TO MAJOR OVHAUL	MAJOR OVHAUL COST (\$)
HW-BOILER	40.000	300.000	1.400	0.000	8.0	220000.	0.	10000.	2000.	50000.	25000.
HERM-REC-CHLR	12.000	100.000	1.200	0.000	16.0	100000.	0.	20000.	5000.	50000.	15000.

# REPORT PV-C EQUIPMENT COSTS

SIMPLE STRUCTURE RUN 3, CHICAGO  
DESIGN-DAY SIZING OF VAV SYSTEM  
REPORT- PV-C EQUIPMENT COSTS

DIVIDE INTO ZONES; ADD PLENUM  
SHOW ALL REPORTS

DOE-2.1E-001 Thu Nov 4 15:19:02 1993PDL RUN 1

WEATHER FILE- TRY CHICAGO

EQUIPMENT	SIZE (MBTU)	UNIT COST (K\$)	INSTALD COST FACTOR	CONSUM- ABLES (\$/HR)	MAINTA- NANCE (HRS/YR)	EQPMT LIFE (HRS)	HOURS ALREADY USED	HRS TO MINOR OVHAUL	MINOR OVHAUL COST (\$)	HRS TO MAJOR OVHAUL	MAJOR OVHAUL COST (\$)
HW-BOILER	0.457	15.003	1.400	0.000	3.3	140687.	0.	4089.	100.	20447.	1250.
HERM-REC-CHLR	0.222	6.911	1.200	0.000	7.2	67112.	0.	9008.	346.	22520.	1037.

# REPORT PV-E EQUIPMENT LOAD RATIOS

SIMPLE STRUCTURE RUN 3, CHICAGO  
DESIGN-DAY SIZING OF VAV SYSTEM  
REPORT- PV-E EQUIPMENT LOAD RATIOS

DIVIDE INTO ZONES; ADD PLENUM  
SHOW ALL REPORTS

DOE-2.1E-001 Thu Nov 4 15:19:02 1993PDL RUN 1

WEATHER FILE- TRY CHICAGO

EQUIPMENT	PART LOAD RATIOS			ELECTRIC INPUT TO NOMINAL CAPACITY RATIO (BTU/BTU)
	MINIMUM	MAXIMUM	OPTIMUM	
HW-BOILER	0.2500	1.2000	1.0000	0.0220
HERM-REC-CHLR	0.2500	1.0000	1.0000	0.2740

# REPORT PV-G EQUIPMENT QUADRATICS

SIMPLE STRUCTURE RUN 3, CHICAGO  
DESIGN-DAY SIZING OF VAV SYSTEM  
REPORT- PV-G EQUIPMENT QUADRATICS

DIVIDE INTO ZONES; ADD PLENUM  
SHOW ALL REPORTS

DOE-2.1E-001 Thu Nov 4 15:19:02 1993PDL RUN 1

WEATHER FILE- TRY CHICAGO

N A M E	COEFF 1	COEFF 2	COEFF 3	COEFF 4	COEFF 5	COEFF 6
STM-BOILER-HIR-F	0.082597	0.996764	-0.079361	0.000000	0.000000	0.000000
HW-BOILER-HIR-FP	0.082597	0.996764	-0.079361	0.000000	0.000000	0.000000
FURNACE-HIR-FPLR	0.018610	1.094209	-0.112819	0.000000	0.000000	0.000000
DHW-HIR-FPLR	0.021826	0.977630	0.000543	0.000000	0.000000	0.000000
OPEN-CENT-CAP-FT	-1.742040	0.029292	-0.000067	0.048054	-0.000291	-0.000106
OPEN-REC-CAP-FT	-4.161461	0.207050	-0.001931	0.004723	-0.000040	-0.000087
HERM-CENT-CAP-FT	-1.742040	0.029292	-0.000067	0.048054	-0.000291	-0.000106
HERM-REC-CAP-FT	-4.161461	0.207050	-0.001931	0.004723	-0.000040	-0.000087
OPEN-CENT-EIR-FT	3.117500	-0.109236	0.001389	0.003750	0.000150	-0.000375
OPEN-REC-EIR-FT	4.720965	-0.187504	0.002192	0.009209	0.000098	-0.000322
HERM-CENT-EIR-FT	3.117500	-0.109236	0.001389	0.003750	0.000150	-0.000375
HERM-REC-EIR-FT	4.720965	-0.187504	0.002192	0.009209	0.000098	-0.000322
OPEN-CENT-EIR-FP	0.222903	0.313387	0.463710	0.000000	0.000000	0.000000
OPEN-REC-EIR-FPL	0.088065	1.137742	-0.225806	0.000000	0.000000	0.000000
HERM-CENT-EIR-FP	0.222903	0.313387	0.463710	0.000000	0.000000	0.000000
HERM-REC-EIR-FPL	0.088065	1.137742	-0.225806	0.000000	0.000000	0.000000
DBUN-CAP-FT	-1.742040	0.029292	-0.000067	0.048054	-0.000291	-0.000106
DBUN-EIR-FT	3.117500	-0.109236	0.001389	0.003750	0.000150	-0.000375
DBUN-EIR-FPLR	0.349032	0.263871	0.387097	0.000000	0.000000	0.000000
DBUN-CAP-FTRISE	1.000000	-0.005650	-0.000305	0.000000	0.000000	0.000000
DBUN-EIR-FTRISE	1.000000	0.012250	0.000175	0.000000	0.000000	0.000000
ABSOR1-CAP-FT	0.723412	0.079006	-0.000897	-0.025285	-0.000048	0.000276
ABSOR2-CAP-FT	-0.816039	-0.038707	0.000450	0.071491	-0.000636	0.000312
ABSORG-CAP-FT	1.000000	0.000000	0.000000	0.000000	0.000000	0.000000
ABSORS-CAP-FT	0.000000	0.000000	0.000000	0.000000	0.000000	0.000000
ABSORS-CAP-FTS	0.000000	0.000000	0.000000	0.000000	0.000000	0.000000
ABSOR1-HIR-FT	0.652273	0.000000	0.000000	-0.000545	0.000055	0.000000
ABSOR2-HIR-FT	1.658750	0.000000	0.000000	-0.029000	0.000250	0.000000
ABSORG-HIR-FT	4.428713	-0.132986	0.001253	0.000000	0.000000	0.000000
ABSORS-HIR-FT	0.000000	0.000000	0.000000	0.000000	0.000000	0.000000
ABSORS-HIR-FTS	0.000000	0.000000	0.000000	0.000000	0.000000	0.000000
ABSOR1-HIR-FPLR	0.087773	0.744921	0.167306	0.000000	0.000000	0.000000
ABSOR2-HIR-FPLR	0.135512	0.617981	0.246513	0.000000	0.000000	0.000000
ABSORG-HIR-FPLR	0.135512	0.617981	0.246513	0.000000	0.000000	0.000000
ABSORS-HIR-FPLR	0.000000	0.000000	0.000000	0.000000	0.000000	0.000000
TWR-GPM-FRA	-2.228889	0.166795	-0.014102	0.032223	0.185602	0.242519
TWR-GPM-FWB	0.605314	-0.035545	0.008041	-0.028603	0.000250	0.004909
TWR-FAN-FPLR	0.331629	-0.885676	0.605565	0.948482	0.000000	0.000000
**	0.000000	0.000000	0.000000	0.000000	0.000000	0.000000
DIESEL-I/O-FPLR	0.107000	0.893300	0.000000	0.000000	0.000000	0.000000
DIESEL-EXH-FPLR	0.024516	0.332387	0.643097	0.000000	0.000000	0.000000
DIESEL-JCLB-FPLR	0.287936	1.020452	-0.308387	0.000000	0.000000	0.000000
**	0.000000	0.000000	0.000000	0.000000	0.000000	0.000000
**	0.000000	0.000000	0.000000	0.000000	0.000000	0.000000
**	0.000000	0.000000	0.000000	0.000000	0.000000	0.000000
GTURB-I/O-FPLR	0.442979	0.397400	0.156962	0.000000	0.000000	0.000000
GTURB-EXH-FPLR	0.295626	0.493019	0.211355	0.000000	0.000000	0.000000
**	0.000000	0.000000	0.000000	0.000000	0.000000	0.000000
GTURB-CAP-FT	1.240000	-0.004100	0.000000	0.000000	0.000000	0.000000
**	0.000000	0.000000	0.000000	0.000000	0.000000	0.000000
STURB-ENTH-FPLX	38.792358	-0.211386	0.000529	1.020087	0.000917	-0.003499
STURB-I/O-FPLR	0.488308	0.994154	-0.482462	0.000000	0.000000	0.000000

N A M E	COEFF 1	COEFF 2	COEFF 3	COEFF 4	COEFF 5	COEFF 6
TC-CHLR-CAP-FT	-0.351443	0.056583	-0.000054	-0.045625	-0.000043	-0.000012
ABSORG-HIR1-FTI	0.861737	-0.007089	0.000103	0.000000	0.000000	0.000000
ABSORG-HIR2-FTI	0.814450	0.000824	0.000013	0.000000	0.000000	0.000000
ABSORG-QCOND-FTI	0.640000	-0.001300	0.000000	0.000000	0.000000	0.000000
ABSG-HCAP-FQC	0.863599	-1.304953	0.441353	0.000000	0.000000	0.000000
ENG-CH-CAP-FT	0.573597	0.018680	0.000000	-0.004653	0.000000	0.000000
ENG-CH-COP-FPLR1	1.143357	0.022890	0.000000	0.000000	0.000000	0.000000
ENG-CH-COP-FPLR2	1.388614	-0.388614	0.000000	0.000000	0.000000	0.000000
ENG-CH-COP-FT	1.236238	0.016892	0.000000	-0.011524	0.000000	0.000000
ENG-CH-HREJ-FPLR	1.052699	-0.052699	0.000000	0.000000	0.000000	0.000000
ENG-CH-HREJ-FT	0.705841	0.003461	0.000000	0.000000	0.000000	0.000000
ENG-CH-COP-FPLRS	0.380200	2.360900	0.000000	0.000000	0.000000	0.000000
ENG-CH-COP-FTS	1.088152	0.014106	0.000000	-0.008339	0.000000	0.000000

# REPORT PS-A

## PLANT ENERGY UTILIZATION SUMMARY

PS-A gives site and source energy use in MBtu( $10^6$  Btu) for thermal quantities and MWh( $10^6$ Wh) for electrical quantities.

In DOE-2.1E, PS-A was modified so that electrical consumption is displayed in units of MWh; the second line showing electrical consumption for each month has been eliminated. Numbers shown in this report may be different than shown in earlier program releases. Previously, energy consumed in SYSTEMS for electrical and fuel usage for heating and cooling did not appear under the heating and cooling categories, only in the total categories; this has been corrected. Also, the figures for total site and source energy were incorrect when a cogeneration plant is a net exporter of electricity; this has been corrected.

1. MONTH
2. TOTAL HEAT LOAD  
Total heating energy = load from SYSTEMS + load from PLANT (absorption chillers + steam turbines + heat dissipated from storage tanks + domestic hot water + heat stored in tanks but not used) + circulation loop losses. The values here are identical to those in the HEATING ENERGY column of the SYSTEMS SS-D report except that the heat energy delivered to an absorption chiller, steam turbine, domestic hot water, and circulation losses is included. Also included is the heat input to a storage tank from a boiler.
3. TOTAL COOLING LOAD  
This is the total of the values shown in the SS-D report plus tank and circulation loop losses; it represents the cooling energy needed each month.
4. TOTAL ELECTRIC LOAD  
This is the total electrical energy consumed by lights, equipment, and system fans plus the additional energy consumed by chiller motors, pumps, cooling towers, and any other electrical site use including energy entered into the program under BUILDING-RESOURCE.
5. RECOVERED ENERGY  
These values are recovered heat used to reduce heating loads. This is waste heat from turbines, diesels, and double-bundle chillers, and solar energy delivered to the load via HEAT-RECOVERY.
6. WASTED RECOVERABLE ENERGY  
The values in this column represent the heat that *could* have been recovered, had there been a need for it.
7. FUEL INPUT COOLING  
The fuel used to drive engine chillers and gas fired absorption chiller/heaters, and regeneration fuel for desiccant cooling systems.

8. ELEC INPUT COOLING

The electric energy used to drive chillers and to supply power for peripheral cooling equipment, such as circulation pumps, cooling towers, and cold storage tanks.

9. FUEL INPUT HEATING

This column reports the fuel used for heating by boilers, furnaces, and hot water heaters.

10. ELEC INPUT HEATING

The electrical energy used in association with supplying heating, including the electrical consumption by draft fans, circulation pumps, electric boilers, and hot water storage pumps.

11. FUEL INPUT ELEC

The fuel used by diesel and gas turbine generators.

12. TOTAL FUEL INPUT

The sum of fossil fuels use.

13. TOTAL SITE ENERGY

The sum of purchased fossil fuel, electricity, chilled water and steam.

14. TOTAL SOURCE ENERGY

The energy used at the source. For each RESOURCE, the energy consumption at the site is divided by the corresponding SOURCE-SITE-EFF to arrive at the energy consumed and transmitted by the generating station; the results are summed.



S I T E E N E R G Y													SOURCE
	2	3	4	5	6	7	8	9	10	11	12	13	14
MONTH	TOTAL HEAT LOAD (MBTU)	TOTAL COOLING LOAD (MBTU)	TOTAL ELECTR LOAD (MWH)	RCVRED ENERGY (MBTU)	WASTED RCVRABL ENERGY (MBTU)	FUEL INPUT COOLING (MBTU)	ELEC INPUT COOLING (MWH)	FUEL INPUT HEATING (MBTU)	ELEC INPUT HEATING (MWH)	FUEL INPUT ELECT (MBTU)	TOTAL FUEL INPUT (MBTU)	TOTAL SITE ENERGY (MBTU)	TOTAL SOURCE ENERGY (MBTU)
JAN	33.5	0.0	3.9	0.0	0.0	0.0	0.0	51.6	0.8	0.0	51.6	64.9	91.7
FEB	26.0	0.0	3.3	0.0	0.0	0.0	0.0	40.2	0.7	0.0	40.2	51.5	74.3
MAR	15.9	0.0	3.4	0.0	0.0	0.0	0.0	25.0	0.5	0.0	25.0	36.5	59.6
APR	4.0	1.8	3.4	0.0	0.0	0.0	0.3	6.4	0.1	0.0	6.4	18.0	41.4
MAY	0.5	5.6	3.9	0.0	0.0	0.0	0.7	0.9	0.0	0.0	0.9	14.0	40.4
JUN	0.0	15.4	4.9	0.0	0.0	0.0	1.9	0.0	0.0	0.0	0.0	16.8	50.5
JUL	0.0	29.8	7.0	0.0	0.0	0.0	3.2	0.0	0.0	0.0	0.0	23.9	71.6
AUG	0.0	24.7	6.4	0.0	0.0	0.0	2.8	0.0	0.0	0.0	0.0	21.7	65.0
SEP	0.3	9.9	4.2	0.0	0.0	0.0	1.3	0.4	0.0	0.0	0.4	14.8	43.4
OCT	2.5	2.7	3.5	0.0	0.0	0.0	0.4	3.9	0.1	0.0	3.9	15.9	40.0
NOV	13.6	0.4	3.1	0.0	0.0	0.0	0.1	21.3	0.4	0.0	21.3	31.9	53.0
DEC	26.6	0.0	3.7	0.0	0.0	0.0	0.0	41.5	0.7	0.0	41.5	53.9	78.9
TOTAL	122.8	90.5	50.6	0.0	0.0	0.0	10.7	191.1	3.4	0.0	191.1	363.9	709.7

**Page left intentionally blank**

REPORT PS-B  
MONTHLY PEAK AND TOTAL ENERGY USE

This report shows the monthly total consumption and peak hourly consumption (demand) of up to five of the following purchased fuels:

ELECTRICITY  
CHILLED-WATER  
STEAM  
NATURAL-GAS  
LPG  
FUEL-OIL  
DIESEL-OIL  
COAL  
METHANOL  
OTHER-FUEL

Usage is displayed in the actual units of consumption (kWh, therms, etc.).

The final section of the report gives, for each "fuel", the total energy use for the run period (ONE YEAR USE), and, below this, the peak hourly energy use (PEAK) for the run period.

SIMPLE STRUCTURE RUN 3, CHICAGO  
 DESIGN-DAY SIZING OF VAV SYSTEM  
 REPORT- PS-B MONTHLY UTILITY AND FUEL USE SUMMARY

DIVIDE INTO ZONES; ADD PLENUM  
 SHOW ALL REPORTS

DOE-2.1E-001 Thu Nov 4 15:19:02 1993PDL RUN 1

WEATHER FILE- TRY CHICAGO

MONTH	BTU/UNIT:	ELECTRICITY	NATURAL-GAS
		METER-1 3413./KWH	METER-1 100000./THERMS
-----			
JAN			
	ENERGY CONSUMPTION (UNITS/MO)	3918.1	515.5
	PEAK DEMAND (UNITS/HR OR DAY)	16.2	5.6
	PEAK DAY/HR	7/ 9	7/ 8
FEB			
	ENERGY CONSUMPTION (UNITS/MO)	3333.6	401.5
	PEAK DEMAND (UNITS/HR OR DAY)	16.1	5.3
	PEAK DAY/HR	4/ 9	4/ 8
MAR			
	ENERGY CONSUMPTION (UNITS/MO)	3377.5	250.2
	PEAK DEMAND (UNITS/HR OR DAY)	15.8	4.9
	PEAK DAY/HR	25/ 9	25/ 8
APR			
	ENERGY CONSUMPTION (UNITS/MO)	3417.1	63.8
	PEAK DEMAND (UNITS/HR OR DAY)	22.2	3.4
	PEAK DAY/HR	29/15	8/ 8
MAY			
	ENERGY CONSUMPTION (UNITS/MO)	3857.1	8.8
	PEAK DEMAND (UNITS/HR OR DAY)	28.4	0.7
	PEAK DAY/HR	21/14	9/ 9
JUN			
	ENERGY CONSUMPTION (UNITS/MO)	4933.9	0.0
	PEAK DEMAND (UNITS/HR OR DAY)	33.8	0.0
	PEAK DAY/HR	20/16	0/ 0
JUL			
	ENERGY CONSUMPTION (UNITS/MO)	6989.9	0.0
	PEAK DEMAND (UNITS/HR OR DAY)	39.2	0.0
	PEAK DAY/HR	8/15	0/ 0
AUG			
	ENERGY CONSUMPTION (UNITS/MO)	6351.4	0.0
	PEAK DEMAND (UNITS/HR OR DAY)	36.0	0.0
	PEAK DAY/HR	19/16	0/ 0
SEP			
	ENERGY CONSUMPTION (UNITS/MO)	4196.0	4.4
	PEAK DEMAND (UNITS/HR OR DAY)	30.7	1.7
	PEAK DAY/HR	11/15	23/ 8
OCT			
	ENERGY CONSUMPTION (UNITS/MO)	3519.4	39.2
	PEAK DEMAND (UNITS/HR OR DAY)	19.8	3.6
	PEAK DAY/HR	31/15	21/ 8
NOV			
	ENERGY CONSUMPTION (UNITS/MO)	3098.8	212.8
	PEAK DEMAND (UNITS/HR OR DAY)	21.1	4.3
	PEAK DAY/HR	1/15	25/ 8
DEC			
	ENERGY CONSUMPTION (UNITS/MO)	3651.2	414.6
	PEAK DEMAND (UNITS/HR OR DAY)	15.8	5.1
	PEAK DAY/HR	9/11	26/ 8
-----			
TOTAL			
	ENERGY CONSUMPTION (UNITS/YR)	50644.1	1910.8
	PEAK DEMAND (UNITS/HR OR DAY)	39.2	5.6

## REPORT PS-C

### EQUIPMENT PART LOAD OPERATION

For each plant equipment type, this report shows the hours spent in each part load ratio range, in increments of 10%. If equipment is oversized, the equipment will never indicate any hours in the 100 to 110+ range.

The TOTAL HOURS entry differs from the total hours in other reports. Here, TOTAL HOURS refers to the hours during which one or more units of a given equipment type are operating. This sum is independent of the *number* of units operating. For example, if three boilers are operating during a given hour, TOTAL HOURS is increased by one rather than three.

1. ANNUAL LOAD  
is the useful load handled by the equipment.
2. FALSE LOAD  
is reported when a piece of equipment is forced to operate at its minimum unload ratio when the demand is less than this.
3. ELEC USED  
is the total electrical energy used by the indicated equipment type.
4. THERMAL USED  
refers either to the fuel consumed or the heat required for operation, from wherever it arises.

When there is more than one piece of equipment of the same type, staged for availability, the first line of HOURS AT PERCENT PART LOAD RATIO (for each type) is the hours spent in the partial load ratio range for the capacity of the equipment of that type which is *operating*. The second line is hours spent (for each type) in the partial load ratio range for the *total installed* capacity. Obviously, when only one piece of equipment is installed, the operating capacity and the total installed capacity are identical. (For example, if there are two 4-MBtuh hot-water boilers and only one is operating, then the "operating capacity" is 4 MBtuh and the "installed capacity" is 8 MBtuh.)

EQUIPMENT	HOURS AT PERCENT PART LOAD RATIO											TOTAL HOURS	ANNUAL LOAD (MBTU)	FALSE LOAD (MBTU)	ELEC USED (KWH)	THERMAL USED (MBTU)
	0 --	10 --	20 --	30 --	40 --	50 --	60 --	70 --	80 --	90 --	100 -					
HW-BOILER	482	507	309	99	50	23	13	13	5	3	0	1504	122.8	0.0	2636.	191.1
	482	507	309	99	50	23	13	13	5	3	0					
HEM-REC-CHLR	194	164	136	178	180	126	80	40	25	9	0	1132	90.5	0.0	9851.	0.0
	194	164	136	178	180	126	80	40	25	9	0					

HOT LOOP CIRCULATION PUMP ELECTRICAL USE = 743. KWH  
 COLD LOOP CIRCULATION PUMP ELECTRICAL USE = 805. KWH  
 CONDENSER WATER PUMP ELECTRICAL USE = 0. KWH  
 TOWER OR CONDENSER FAN ELECTRICAL USE = 1661. KWH

NOTES TO TABLE

- 1) THE FIRST PART LOAD ENTRY FOR EACH PIECE OF EQUIPMENT IS THE HOURLY LOAD DIVIDED BY THE HOURLY OPERATING CAPACITY
- 2) THE SECOND PART LOAD ENTRY FOR EACH PIECE OF EQUIPMENT IS THE HOURLY LOAD DIVIDED BY THE TOTAL INSTALLED CAPACITY

**REPORT PS-D**  
**PLANT LOADS SATISFIED**

This report flags those situations where the plant is not able to meet the loads imposed by both systems and other plant equipment. This is of special importance when equipment is intentionally undersized to improve part load performance or to reduce costs.

**MBTU SUPPLIED**

is the output energy from each piece of equipment.

**PCT OF TOTAL LOAD**

is the following ratio (in percent): MBTU SUPPLIED divided by TOTAL LOAD ON PLANT. This will be 100% only if all of the load is satisfied.

When a hot or cold storage tank is included, additional entries are given at the bottom of the first page which describe the contribution to the heating and cooling demands made by the storage tank(s).

**TOTAL LOAD ON PLANT**

for heating (cooling) is the sum of the demand from SYSTEMS, the consumption by PLANT, the loss from the storage tank and the heat (cold) remaining in the storage tank at the end of the run. The last, of course, is still recoverable and is reported as RESIDUAL (not shown in this example; see the PS-D report for the 31-story Office Building, Run 2 in the *Sample Run Book (2.1E)*).

In the second part of this report, "SUMMARY OF LOADS MET", TOTAL OVERLOAD is that portion of a load that requires equipment to operate above its nominal rated capacity. PEAK OVERLOAD is the largest hourly overload.

SIMPLE STRUCTURE RUN 3, CHICAGO  
 DESIGN-DAY SIZING OF VAV SYSTEM  
 REPORT- PS-D PLANT LOADS SATISFIED

DIVIDE INTO ZONES; ADD PLENUM  
 SHOW ALL REPORTS

DOE-2.1E-001 Thu Nov 4 15:19:02 1993PDL RUN 1

WEATHER FILE- TRY CHICAGO

HEATING LOADS	MBTU SUPPLIED	PCT OF TOTAL LOAD
-----	-----	-----
HW-BOILER	122.8	100.0
	=====	=====
LOAD SATISFIED	122.8	100.0
TOTAL LOAD ON PLANT	122.8	
COOLING LOADS	MBTU SUPPLIED	PCT OF TOTAL LOAD
-----	-----	-----
HERM-REC-CHLR	90.5	100.0
	=====	=====
LOAD SATISFIED	90.5	100.0
TOTAL LOAD ON PLANT	90.5	
ELECTRICAL LOADS	KWH SUPPLIED	PCT OF TOTAL LOAD
-----	-----	-----
ELECTRICITY	50644.1	100.0
	=====	=====
LOAD SATISFIED	50644.1	100.0
TOTAL LOAD ON PLANT	50642.9	



SIMPLE STRUCTURE RUN 3, CHICAGO  
DESIGN-DAY SIZING OF VAV SYSTEM  
REPORT- PS-D PLANT LOADS SATISFIED

DIVIDE INTO ZONES; ADD PLENUM  
SHOW ALL REPORTS

DOE-2.1E-001 Thu Nov 4 15:19:02 1993PDL RUN 1

WEATHER FILE- TRY CHICAGO

(CONTINUED)

SUMMARY OF LOADS MET

TYPE OF LOAD	TOTAL LOAD (MBTU)	LOAD SATISFIED (MBTU)	TOTAL OVERLOAD (MBTU)	PEAK OVERLOAD (MBTU)	HOURS OVERLOADED
HEATING LOADS	122.8	122.8	0.000	0.000	0
COOLING LOADS	90.5	90.5	0.000	0.000	0
ELECTRICAL LOADS	172.8	172.8	0.000	0.000	0

**Page left intentionally blank**

**REPORT PS-E**  
**MONTHLY ENERGY END USE SUMMARY**

This report summarizes the monthly energy usage by end use. The breakdown is in terms of ELECTRICITY and FUEL. The end uses are defined in "Metering and Reporting of Energy End Uses", p.3.4. For each month, the report lists the total electrical and fuel usage, the peak usage, and the day/hour during which the peak occurred. For readability, only end uses that have non-zero yearly consumption are itemized. This report does not distinguish between the various fuel types that may be present, or different electrical meters. In addition, this report does not attempt to allocate fuel consumed by cogeneration equipment to electrical end uses.

ELECTRICAL END-USES IN KWH

	JAN	FEB	MAR	APR	MAY	JUN	JUL	AUG	SEP	OCT	NOV	DEC	TOTAL
AREA LIGHTS	1904.	1656.	1830.	1895.	1904.	1748.	1904.	1904.	1748.	1904.	1674.	1830.	21902.
MAX KW	7.5	7.5	7.5	7.5	7.5	7.5	7.5	7.5	7.5	7.5	7.5	7.5	7.5
DAY/HR	2/11	1/11	1/11	1/11	1/11	3/11	1/11	1/11	3/11	1/11	1/11	2/11	
MISC EQUIPMT	917.	795.	879.	915.	917.	838.	917.	917.	838.	917.	800.	879.	10528.
MAX KW	4.0	4.0	4.0	4.0	4.0	4.0	4.0	4.0	4.0	4.0	4.0	4.0	4.0
DAY/HR	2/ 9	1/ 9	1/ 9	1/ 9	1/ 9	3/ 9	1/ 9	1/ 9	3/ 9	1/ 9	1/ 9	2/ 9	
SPACE HEAT	690.	542.	355.	93.	14.	0.	0.	0.	7.	58.	301.	575.	2636.
MAX KW	2.9	2.9	2.9	2.9	1.1	0.0	0.0	0.0	2.6	2.9	2.9	2.9	2.9
DAY/HR	1/ 1	1/ 8	1/ 8	1/ 8	9/ 9	0/ 0	0/ 0	0/ 0	23/ 8	15/ 8	4/ 8	2/ 8	
SPACE COOL	0.	0.	0.	178.	522.	1419.	2612.	2221.	928.	270.	41.	0.	8189.
MAX KW	0.0	0.0	0.0	6.7	12.5	16.2	18.7	16.5	13.0	5.8	5.9	0.0	18.7
DAY/HR	0/ 0	0/ 0	0/ 0	29/18	21/14	20/16	8/16	19/16	11/15	4/17	1/16	0/ 0	
HEAT REJECT	0.	0.	0.	55.	135.	317.	428.	416.	213.	85.	13.	0.	1661.
MAX KW	0.0	0.0	0.0	1.8	1.8	1.8	1.8	1.8	1.8	1.7	1.8	0.0	1.8
DAY/HR	0/ 0	0/ 0	0/ 0	26/15	16/17	3/12	1/ 9	1/11	4/18	4/17	1/16	0/ 0	
PUMPS & MISC	151.	126.	119.	99.	101.	144.	171.	169.	117.	113.	100.	136.	1547.
MAX KW	0.5	0.5	0.5	0.7	0.7	0.7	0.7	0.7	0.7	1.2	0.7	0.5	1.2
DAY/HR	1/ 1	1/ 8	1/ 8	1/13	1/10	3/ 9	1/ 8	1/ 8	3/12	16/13	1/ 9	1/ 9	
VENT FANS	256.	215.	195.	182.	263.	469.	958.	724.	346.	173.	171.	231.	4181.
MAX KW	4.0	3.9	3.3	2.2	3.0	4.2	7.3	6.0	4.1	1.8	3.0	3.5	7.3
DAY/HR	7/ 8	4/ 8	25/ 8	1/ 8	21/16	20/16	15/ 9	19/16	9/16	21/ 8	18/ 8	26/ 8	
TOTAL KWH	3918.	3334.	3377.	3417.	3857.	4934.	6990.	6351.	4196.	3519.	3099.	3651.	50644.

FUEL END-USES IN MBTU

	JAN	FEB	MAR	APR	MAY	JUN	JUL	AUG	SEP	OCT	NOV	DEC	TOTAL
SPACE HEAT	51.6	40.2	25.0	6.4	0.9	0.0	0.0	0.0	0.4	3.9	21.3	41.5	191.1
MAX MBTU	0.558	0.535	0.490	0.344	0.071	0.000	0.000	0.000	0.167	0.358	0.433	0.507	0.558
DAY/HR	7/ 8	4/ 8	25/ 8	8/ 8	9/ 9	0/ 0	0/ 0	0/ 0	23/ 8	21/ 8	25/ 8	26/ 8	
TOTAL MBTU	51.6	40.2	25.0	6.4	0.9	0.0	0.0	0.0	0.4	3.9	21.3	41.5	191.1

## REPORT PS-F

### ENERGY RESOURCE PEAK BREAKDOWN BY END USE

This report is an extension of the PLANT program BEPS report. For each of the end uses and fuels in BEPS, this report lists the monthly peak consumption of each resource, the time the peak occurred, and the contribution toward the peak of each of the end uses. The end uses are defined in "Metering and Reporting of Energy End Uses", p.3.4. The resources are those specified in the ENERGY-RESOURCE command in PLANT. The end use contribution is listed in terms of both the total amount and the percentage. Only end uses with a non-zero yearly consumption are listed. The report repeats for each of the resources.

For cogeneration systems, this report will apportion the fuel consumed to each of the electrical end uses. If the system is a net power producer, an additional line will indicate the portion of the power that is exported and the fuel consumed.

The energy flow associated with charging and discharging a hot water tank is ignored in this report. The reasons for this are somewhat complex. Briefly, when charging the hot water tank, it is not possible to apportion the energy to the end uses, as the end uses are not yet known (a hot water tank can be used for space heating, absorption cooling, or domestic hot water.) End-uses could be apportioned at the time of discharge (as they are in BEPS), but this would then create artificial peaks at the time of use.

SIMPLE STRUCTURE RUN 3, CHICAGO  
 DESIGN-DAY SIZING OF VAV SYSTEM  
 REPORT- PS-F ENERGY-RESOURCE PEAK BREAKDOWN BY END-USE

DIVIDE INTO ZONES; ADD PLENUM  
 SHOW ALL REPORTS

DOE-2.1E-001 Thu Nov 4 15:19:02 1993PDL RUN 1

WEATHER FILE- TRY CHICAGO

ENERGY-RESOURCE: ELECTRICITY  
 UNITS: KWH

	JAN	FEB	MAR	APR	MAY	JUN	JUL	AUG	SEP	OCT	NOV	DEC
PEAK DEMAND:	16.2	16.1	15.8	22.2	28.4	33.8	39.2	36.0	30.7	19.8	21.1	15.8
DAY/HR:	7/ 9	4/ 9	25/ 9	29/15	21/14	20/16	8/15	19/16	11/15	31/15	1/15	9/11
BREAKDOWN												
AREA LIGHTS:	6.75	6.75	6.75	7.50	6.75	7.50	7.50	7.50	7.50	7.50	7.50	7.50
(%):	41.76	41.81	42.68	33.83	23.78	22.16	19.14	20.84	24.45	37.84	35.62	47.50
MISC EQUIPMT:	4.00	4.00	4.00	4.00	4.00	3.50	4.00	3.50	4.00	4.00	4.00	4.00
(%):	24.75	24.78	25.29	18.04	14.09	10.34	10.21	9.73	13.04	20.18	19.00	25.34
SPACE HEAT:	2.95	2.95	2.95	0.00	0.00	0.00	0.00	0.00	0.00	0.00	0.00	2.95
(%):	18.24	18.27	18.65	0.00	0.00	0.00	0.00	0.00	0.00	0.00	0.00	18.68
SPACE COOL:	0.00	0.00	0.00	6.34	12.51	16.16	18.33	16.46	13.02	5.16	5.59	0.00
(%):	0.00	0.00	0.00	28.58	44.05	47.73	46.78	45.74	42.46	26.03	26.53	0.00
HEAT REJECT:	0.00	0.00	0.00	1.82	1.82	1.82	1.82	1.82	1.82	1.56	1.74	0.00
(%):	0.00	0.00	0.00	8.23	6.43	5.39	4.66	5.07	5.95	7.89	8.28	0.00
PUMPS & MISC:	0.49	0.49	0.49	0.71	0.71	0.71	0.71	0.71	0.71	0.71	0.71	0.49
(%):	3.05	3.06	3.12	3.21	2.50	2.10	1.81	1.98	2.32	3.59	3.38	3.13
VENT FANS:	1.97	1.95	1.62	1.80	2.60	4.16	6.82	5.99	3.61	0.89	1.52	0.85
(%):	12.19	12.08	10.25	8.11	9.15	12.28	17.41	16.64	11.78	4.47	7.20	5.35

SIMPLE STRUCTURE RUN 3, CHICAGO  
 DESIGN-DAY SIZING OF VAV SYSTEM  
 REPORT- PS-F ENERGY-RESOURCE PEAK BREAKDOWN BY END-USE

DIVIDE INTO ZONES; ADD PLENUM  
 SHOW ALL REPORTS

DOE-2.1E-001 Thu Nov 4 15:19:02 1993PDL RUN 1

WEATHER FILE- TRY CHICAGO

(CONTINUED)

ENERGY-RESOURCE: NATURAL-GAS  
 UNITS: THERMS

	JAN	FEB	MAR	APR	MAY	JUN	JUL	AUG	SEP	OCT	NOV	DEC
PEAK DEMAND:	5.6	5.3	4.9	3.4	0.7	0.0	0.0	0.0	1.7	3.6	4.3	5.1
DAY/HR:	7/ 8	4/ 8	25/ 8	8/ 8	9/ 9	0/ 0	0/ 0	0/ 0	23/ 8	21/ 8	25/ 8	26/ 8
BREAKDOWN												
AREA LIGHTS:	0.00	0.00	0.00	0.00	0.00	0.00	0.00	0.00	0.00	0.00	0.00	0.00
(%):	0.00	0.00	0.00	0.00	0.00	0.00	0.00	0.00	0.00	0.00	0.00	0.00
MISC EQUIPMT:	0.00	0.00	0.00	0.00	0.00	0.00	0.00	0.00	0.00	0.00	0.00	0.00
(%):	0.00	0.00	0.00	0.00	0.00	0.00	0.00	0.00	0.00	0.00	0.00	0.00
SPACE HEAT:	5.58	5.35	4.90	3.44	0.71	0.00	0.00	0.00	1.67	3.58	4.33	5.07
(%):	100.00	100.00	100.00	100.00	100.00	0.00	0.00	0.00	100.00	100.00	100.00	100.00
SPACE COOL:	0.00	0.00	0.00	0.00	0.00	0.00	0.00	0.00	0.00	0.00	0.00	0.00
(%):	0.00	0.00	0.00	0.00	0.00	0.00	0.00	0.00	0.00	0.00	0.00	0.00
HEAT REJECT:	0.00	0.00	0.00	0.00	0.00	0.00	0.00	0.00	0.00	0.00	0.00	0.00
(%):	0.00	0.00	0.00	0.00	0.00	0.00	0.00	0.00	0.00	0.00	0.00	0.00
PUMPS & MISC:	0.00	0.00	0.00	0.00	0.00	0.00	0.00	0.00	0.00	0.00	0.00	0.00
(%):	0.00	0.00	0.00	0.00	0.00	0.00	0.00	0.00	0.00	0.00	0.00	0.00
VENT FANS:	0.00	0.00	0.00	0.00	0.00	0.00	0.00	0.00	0.00	0.00	0.00	0.00
(%):	0.00	0.00	0.00	0.00	0.00	0.00	0.00	0.00	0.00	0.00	0.00	0.00

**Page left intentionally blank**



**REPORT PS-G**  
**ELECTRICAL LOAD SCATTER PLOT**

In this scatter plot the ordinate, shown in the left-most column, is the electrical demand divided into 13 bins which range from zero to just above the peak electrical demand. The abscissa shown at the top is the hour of the day. Entered in each cell of the plot is the number of days during the year for which the electrical demand was less than the ordinate shown but larger than the next lower ordinate at that hour of the day.

The right-most column is the sum of the entries in each row and shows the frequency of the electrical demand throughout the run period.

The bottom row shows the distribution of electrical demand for each hour of the average day. The number here is the electrical consumption for the run period for a *particular* hour of the day divided by the total electrical consumption for *all hours of the day* for run period.

The chart at the bottom is a breakdown of the peak electrical demand into the contributing components. The SYSTEMS LOAD includes the lighting and equipment electrical loads from LOADS as well as that from system fans.

TOTAL HOURS AT HOURLY DEMAND AND TIME OF DAY

HOUR	LAM	2	3	4	5	6	7	8	9	10	11	12	1PM	2	3	4	5	6	7	8	9	10	11	12	TOTAL
	40	0	0	0	0	0	0	0	0	0	0	0	0	0	1	1	0	0	0	0	0	0	0	0	2
	37	0	0	0	0	0	0	0	0	2	1	2	2	1	3	6	5	3	3	0	0	0	0	0	28
	34	0	0	0	0	0	0	0	0	0	2	5	4	2	6	8	9	9	6	0	0	0	0	0	51
	31	0	0	0	0	0	0	0	0	4	4	4	5	7	13	23	24	14	13	0	0	0	0	0	111
D	28	0	0	0	0	0	0	0	0	8	11	14	20	15	26	26	27	28	31	0	0	0	0	0	206
E	25	0	0	0	0	0	0	0	2	13	23	33	30	30	22	16	14	22	22	0	0	0	0	0	227
M K	21	0	0	0	0	0	0	0	2	23	21	11	10	17	12	9	8	11	10	0	0	0	0	0	134
A W	18	0	0	0	0	0	0	0	3	19	13	32	17	14	14	14	15	11	9	0	0	0	0	0	161
N	15	0	0	0	0	0	0	0	8	146	151	136	138	99	110	128	111	62	65	0	0	0	0	0	1154
D	12	0	0	0	0	0	0	0	9	37	26	15	26	67	46	21	38	92	93	0	0	0	0	0	470
	9	0	0	0	0	0	0	0	41	0	0	0	0	0	0	0	0	0	0	0	0	0	0	0	41
	6	9	9	14	10	13	11	15	104	5	4	5	5	4	3	4	5	4	4	260	5	6	8	8	523
	3	356	356	351	355	352	354	350	196	108	109	108	108	109	110	109	108	109	109	105	360	359	357	357	5652
PERCENT TOTAL DEMAND	===	===	===	===	===	===	===	===	===	===	===	===	===	===	===	===	===	===	===	===	===	===	===	===	=====
	0.4	0.4	0.4	0.4	0.4	0.4	0.5	2.5	8.1	8.4	8.8	8.8	8.3	8.9	9.5	9.3	8.8	8.7	3.1	1.6	0.9	0.4	0.4	0.4	

PEAK ELECTRICAL LOAD BREAKDOWN

SOURCE	KW	PCT
SYSTEMS LOAD	18.322	46.8
CIRCULATION PUMPS	0.711	1.8
HERM-REC-CHLR	20.155	51.4
=====		
TOTAL	39.188	

## REPORT PS-H

### EQUIPMENT USE STATISTICS

This report gives you an assessment of the appropriateness of the equipment selected.

1. **AVG OPER RATIO**  
is the point, on the average, at which the equipment operates on its part load curve.
2. **MAX LOAD (MBtu) - MON-DAY-HR**  
gives the maximum demand loading and the time of occurrence. This value should compare favorably with the size of the equipment selected.
3. **SIZE (MBtu)**  
is the equipment size selected either automatically by the program or as input by the user.
4. **OPER HRS**  
is the total number of equipment-hours the equipment was "on". If more than one unit is involved there is space to report four more units by size and operating hours. If there are two pieces of equipment of the same size, the value for OPER HRS is the sum of the number of hours that each operates.

SIMPLE STRUCTURE RUN 3, CHICAGO  
 DESIGN-DAY SIZING OF VAV SYSTEM  
 REPORT- PS-H EQUIPMENT USE STATISTICS

DIVIDE INTO ZONES; ADD PLENUM  
 SHOW ALL REPORTS

DOE-2.1E-001 Thu Nov 4 15:19:02 1993PDL RUN 1

WEATHER FILE- TRY CHICAGO

EQUIPMENT	AVG OPER RATIO	MAX LOAD (MBTU)	MON		-----		-----		-----		-----		-----	
			DAY	HR	SIZE (MBTU)	OPER HRS	SIZE (MBTU)	OPER HRS	SIZE (MBTU)	OPER HRS	SIZE (MBTU)	OPER HRS	SIZE (MBTU)	OPER HRS
HW-BOILER	0.178	0.444	1	7 8	0.457	1504								
HEM-REC-CHLR	0.359	0.219	7	8 16	0.222	1132								

## REPORT PS-I EQUIPMENT LIFE CYCLE COSTS

For each piece of equipment the report generates information as follows:

1. Nominal Size in MBtuh
2. Number Installed
3. First Cost of Equipment
4. Annual Cost is the present value of life cycle cost for maintenance and consumables.
5. Cyclical Cost gives the present value of the life cycle cost for major and minor overhauls and for equipment replacement.

You must review Table V.1 in the *Reference Manual (2.1A)* to make sure that equipment-cost-related default values are appropriate. If not, you should enter appropriate values.

The first column of numbers in this report gives the total life cycle cost for each equipment type. The second column gives the components of this total for all pieces of equipment of that type. The remaining column gives the cost components for each size of equipment. If there is only one size, columns two and three will be identical.

SIMPLE STRUCTURE RUN 3, CHICAGO      DIVIDE INTO ZONES; ADD PLENUM  
 DESIGN-DAY SIZING OF VAV SYSTEM      SHOW ALL REPORTS  
 REPORT- PS-I EQUIPMENT LIFE CYCLE COSTS

DOE-2.1E-001 Thu Nov 4 15:19:02 1993PDL RUN 1

WEATHER FILE- TRY CHICAGO

E Q U I P M E N T      T O T A L S

HW-BOILER	23.3		
NOMINAL SIZE (MBTU)		0.457	
NUMBER INSTALLED		1	
FIRST COST (K\$)	21.0	21.0	
ANNUAL COST (K\$)	1.2	1.2	
CYCLICAL COST (K\$)	1.1	1.1	
-----TOTAL----- (K\$)		23.3	
HERM-REC-CHLR	11.7		
NOMINAL SIZE (MBTU)		0.222	
NUMBER INSTALLED		1	
FIRST COST (K\$)	8.3	8.3	
ANNUAL COST (K\$)	2.5	2.5	
CYCLICAL COST (K\$)	0.9	0.9	
-----TOTAL----- (K\$)		11.7	
-----			
EQUIPMENT TOTAL	35.0		

## REPORT BEPS

### BUILDING ENERGY PERFORMANCE SUMMARY

This report makes it possible to quickly review annual building energy use according to energy type (ELECTRICITY, NATURAL-GAS, etc.) and category of use (AREA, LIGHTS, SPACE, HEAT, etc.). The energy types shown are those that you have specified with the ENERGY-RESOURCE command in PLANT (see "Energy Meters in PLANT", p.4.3). The categories of use (also called energy end uses) are defined under "Metering and Reporting of Energy End Uses" in the section "Energy End Uses and Meters" p.3.4.

*Only categories of use with non-zero consumption are shown.*

#### TOTAL SITE ENERGY

is the overall energy use *at the building site* for all energy types and categories of use.

#### TOTAL SOURCE ENERGY

is the energy use at point of production; it is obtained by dividing site energy use by the user-specified SOURCE-SITE-EFF value in the ENERGY-RESOURCE command.

Site and source energy are given per unit of net area (the sum of the floor areas of conditioned zones) and per unit of gross area (the value of GROSS-AREA in the BUILDING-LOCATION command in LOADS, which defaults to net area).

It should be pointed out that this report is not designed to work when there is a steam turbine among the specified plant equipment items. The numbers reported when a steam turbine is present will not be reliable.

When a hot storage tank is present, a note is printed on the BEPS report stating that the hot water storage tank can get energy from many sources. Any time there is residual energy in the storage tanks, the totals in the BEPS report will not agree with those in report PS-B, because the BEPS report includes only the energy used for the above categories, whereas PS-B includes the energy that is left in the tanks as well.

ENERGY TYPE: UNITS: MBTU	ELECTRICITY	NATURAL-GAS
CATEGORY OF USE		
AREA LIGHTS	74.7	0.0
MISC EQUIPMT	35.9	0.0
SPACE HEAT	9.0	191.1
SPACE COOL	27.9	0.0
HEAT REJECT	5.7	0.0
PUMPS & MISC	5.3	0.0
VENT FANS	14.3	0.0
	-----	-----
TOTAL	172.8	191.1

TOTAL SITE ENERGY	363.93 MBTU	72.8 KBTU/SQFT-YR GROSS-AREA	72.8 KBTU/SQFT-YR NET-AREA
TOTAL SOURCE ENERGY	709.67 MBTU	141.9 KBTU/SQFT-YR GROSS-AREA	141.9 KBTU/SQFT-YR NET-AREA

PERCENT OF HOURS ANY SYSTEM ZONE OUTSIDE OF THROTTLING RANGE = 1.7  
 PERCENT OF HOURS ANY PLANT LOAD NOT SATISFIED = 0.0

NOTE: ENERGY IS APPORTIONED HOURLY TO ALL END-USE CATEGORIES.



**REPORT BEPU**  
**BUILDING ENERGY PERFORMANCE SUMMARY (UTILITY UNITS)**

This report is identical to the BEPS report, except that the end use breakdown for each of the energy types is given in the actual units of consumption, such as kWh or therms. In addition, the total *site* energy consumption (TOTAL ELECTRICITY, etc.) is given for each energy type.

As in the BEPS report, only end uses with a non-zero yearly consumption are displayed.

For cogeneration plants, the breakdown of energy usage may be substantially different than shown in versions prior to DOE-2.1E. Previously, the energy consumption of end uses in LOADS and SYSTEMS such as lights and HVAC fans was apportioned on a yearly basis. This is because hourly data was not available. In DOE-2.1E, all energy is apportioned hourly. In addition, the report previously did not handle the case where a cogeneration plant is a net power exporter. In DOE-2.1E, surplus power is shown as an additional line item. This report assumes that generated power will first be used to satisfy on-site demands, and that any surplus power will be sold. Site and source energy are reduced by the amount of power sold, with source energy reduction calculated using the source/site conversion ratio specified for electricity in the ENERGY-RESOURCE command in PLANT.

BEPS and BEPU break down pump consumption differently from PS-A. In BEPS and BEPU, pump consumption is shown as auxiliary power. In PS-A, the hot water pump is grouped with heating electrical, and the chilled water pump is grouped with cooling electrical. In addition, PS-A groups heat rejection energy with cooling.

ENERGY TYPE: SITE UNITS:	ELECTRICITY KWH	NATURAL-GAS THERMS
CATEGORY OF USE -----		
AREA LIGHTS	21902.	0.
MISC EQUIPMT	10527.	0.
SPACE HEAT	2636.	1911.
SPACE COOL	8189.	0.
HEAT REJECT	1661.	0.
PUMPS & MISC	1547.	0.
VENT FANS	4181.	0.
	-----	-----
TOTAL	50644.	1911.

TOTAL ELECTRICITY	50644. KWH	10.129 KWH	/SQFT-YR GROSS-AREA	10.129 KWH	/SQFT-YR NET-AREA
TOTAL NATURAL-GAS	1911. THERMS	0.382 THERMS	/SQFT-YR GROSS-AREA	0.382 THERMS	/SQFT-YR NET-AREA

PERCENT OF HOURS ANY SYSTEM ZONE OUTSIDE OF THROTTLING RANGE = 1.7  
 PERCENT OF HOURS ANY PLANT LOAD NOT SATISFIED = 0.0

NOTE: ENERGY IS APPORTIONED HOURLY TO ALL END-USE CATEGORIES.

## REPORT EV-A

### LIFE-CYCLE COSTING PARAMETERS AND BUILDING COMPONENT COST INPUT DATA

#### LIFE-CYCLE COSTING PARAMETERS

This report section echoes data originally specified by the user in PLANT and automatically passed to the ECONOMICS program.

1. DISCOUNT RATE  
is the rate in percent used in calculating present value.
2. LABOR INFLATION RATE  
is the annual inflation rate (relative to general inflation) of labor cost, in percent. Installation, maintenance, and overhaul costs are inflated at this rate in calculating present values.
3. MATERIALS INFLATION RATE  
is the annual inflation rate (relative to general inflation) of material costs, in percent. Capital replacement costs are inflated at this rate in calculating present values.
4. PROJECT LIFE  
is the period, in years, over which the life cycle cost analysis is performed. This number can range from 1 to 25 years.

#### BUILDING COMPONENT COST INPUT DATA

This report section echoes building (nonplant) component cost data input with each COMPONENT-COST command in ECONOMICS. The costs here are in *current dollars* that is, they correspond to the prices that apply at the start of the analysis period.

1. COST NAME  
is the u-name of the component.
2. NUMBER OF UNITS  
multiplies all costs. Defaults to 1.0 if not specified.
3. UNIT NAME  
is the name assigned to the unit (such as SQFT or CUFT) by the user to identify the size or type of the unit. This name is arbitrary and optional and is for user convenience only.
4. LIFE  
is the life expectancy of the component, in years. It is used in calculating replacement costs. Defaults to 999 years if not specified.
5. UNIT FIRST COST  
is the purchase price of each unit of the component, in dollars, exclusive of installation.
6. UNIT INSTALLATION COST  
is the installation cost for each unit of the component, in dollars.
7. UNIT ANNUAL MAINT COST  
is the yearly maintenance cost of each unit of the component, in dollars.

8. UNIT MINOR OVERHAUL COST  
is the cost, in dollars, of a minor overhaul for each unit of the component.
9. MINOR OVERHAUL INTERVAL  
is the number of years between minor overhauls.
10. UNIT MAJOR OVERHAUL COST  
is the cost, in dollars, of a major overhaul for each unit of the component.
11. MAJOR OVERHAUL INTERVAL  
is the number of years between major overhauls.

LIFE-CYCLE COSTING PARAMETERS

DISCOUNT RATE (PERCENT)	LABOR INFLATION RATE (PERCENT)	MATERIALS INFLATION RATE (PERCENT)	PROJECT LIFE (YRS)
5.0	0.0	0.0	25.0

BUILDING COMPONENT COST INPUT DATA (CURRENT DOLLARS)

COST NAME	NUMBER OF UNITS	UNIT NAME	LIFE (YRS)	UNIT FIRST COST (\$)	UNIT INSTALL -ATION COST (\$)	UNIT ANNUAL MAINT COST (\$)	UNIT MINOR OVERHAUL COST (\$)	MINOR OVERHAUL INTERVAL (YRS)	UNIT MAJOR OVERHAUL COST (\$)	MAJOR OVERHAUL INTERVAL (YRS)
ROOF-INSUL	5000.0	SQFT	999.0	0.80	0.30	0.00	0.00	999.00	0.00	999.00

Page left intentionally blank

## REPORT ES-A

### ANNUAL ENERGY AND OPERATIONS COSTS AND SAVINGS

This report gives the present value of energy and operations costs for each year of the project lifetime. Costs are given both for the baseline and for the building being analyzed in the present run. Operations include costs of annual maintenance and major and minor overhauls. For the building being analyzed in this run, operations costs are given separately for plant equipment and for the building (non plant) components specified using COMPONENT-COST instructions.

The building being analyzed in the example shown is Simple Structure Run 3A; the baseline building is Simple Structure Run 3.

1. ENERGY COST BASELINE  
is the present value of the yearly baseline energy cost. These values echo those input using the BASELINE command.
2. ENERGY COST THIS RUN  
is the present value of the yearly energy cost for the building being analyzed in this run.
3. ENERGY COST SAVINGS  
is the difference between the above two quantities (1 minus 2).
4. OPRNS COST BASELINE  
is the present value of the yearly baseline operations cost.
5. OPRNS COST--THIS RUN  
gives the present value of the yearly operations cost for plant equipment and building components, and for the sum, for the building being analyzed in this run.
6. OPRNS COST SAVINGS  
is OPRNS COST BASELINE minus OPRNS COST--THIS RUN, TOTAL.
7. TOTAL SAVINGS-ENERGY PLUS OPRNS  
is the sum of ENERGY COST SAVINGS and OPRNS COST SAVINGS.

The bottom line of this report (TOTALS) gives the present value of the life cycle energy and operations costs and savings.

Note: The user must enter baseline cost data using the BASELINE command. Otherwise, the "savings" values in this report will not be meaningful.

YEAR	ENERGY ( \$ )			OPERATIONS ( \$ )				TOTAL SAVINGS- ENERGY PLUS OPRNS	
	ENERGY COST	ENERGY COST	ENERGY COST	OPRNS COST	OPRNS COST -- THIS RUN				OPRNS COST
	BASELINE	THIS RUN	SAVINGS	BASELINE	PLANT	BUILDING	TOTAL		SAVINGS
1	4369.	4111.	258.	249.	249.	0.	249.	0.	258.
2	4431.	4173.	258.	238.	238.	0.	238.	0.	259.
3	4493.	4236.	257.	314.	226.	0.	226.	88.	345.
4	4557.	4301.	256.	216.	215.	0.	215.	1.	257.
5	4622.	4366.	256.	205.	205.	0.	205.	0.	256.
6	4688.	4433.	255.	272.	195.	0.	195.	77.	331.
7	4756.	4502.	254.	186.	186.	0.	186.	0.	254.
8	4824.	4571.	253.	412.	177.	0.	177.	235.	488.
9	4894.	4642.	252.	236.	169.	0.	169.	67.	319.
10	4966.	4714.	252.	161.	161.	0.	161.	0.	252.
11	5038.	4788.	250.	212.	153.	0.	153.	59.	309.
12	5113.	4863.	250.	146.	146.	0.	146.	0.	250.
13	5188.	4939.	249.	139.	139.	0.	139.	0.	249.
14	5265.	5017.	248.	828.	132.	0.	132.	696.	944.
15	5344.	5097.	247.	126.	126.	0.	126.	0.	247.
16	5424.	5177.	247.	279.	120.	0.	120.	159.	406.
17	5505.	5260.	245.	159.	114.	0.	114.	45.	290.
18	5588.	5344.	244.	109.	109.	0.	109.	0.	244.
19	5673.	5429.	244.	104.	104.	0.	104.	0.	244.
20	5759.	5517.	242.	531.	99.	0.	99.	432.	675.
21	5847.	5606.	241.	94.	94.	0.	94.	0.	241.
22	5936.	5696.	240.	124.	90.	0.	90.	34.	274.
23	6027.	5789.	238.	85.	85.	0.	85.	0.	238.
24	6120.	5883.	237.	189.	81.	0.	81.	108.	345.
25	6215.	5978.	237.	108.	77.	0.	77.	31.	267.
TOTALS (\$)	130642.	124431.	6211.	5722.	3691.	0.	3691.	2031.	8243.



## REPORT ES-B

### LIFE-CYCLE BUILDING AND PLANT NON-ENERGY COSTS

This report summarizes life cycle costs (other than for energy) for plant equipment and for each building component.

1. **FIRST COST**

is the initial purchase price, including installation.

2. **REPLACEMENTS**

is the present value of the life cycle replacement costs.

3. **OPERATIONS**

is the present value of the life cycle cost for annual maintenance and major and minor overhauls.

4. **TOTAL**

gives the sum of the previous three quantities.

5. **INVESTMENT**

is the sum of the first two quantities, **FIRST COST** and **REPLACEMENTS**. Note that the investment does not include operations or energy costs.

LIFE-CYCLE BUILDING AND PLANT NON-ENERGY COSTS (\$)

COST NAME	FIRST COST (INCLUDING INSTALLATION)	REPLACEMENTS	OPERATIONS	TOTAL	INVESTMENT (FIRST COST PLUS REPLACEMENTS)
ROOF-INSUL	5500.	0.	0.	5500.	5500.
PLANT EQUIPMENT	29273.	0.	3691.	32964.	29273.
TOTALS	34773.	0.	3691.	38464.	34773.

**REPORT ES-C**  
**ENERGY SAVINGS, INVESTMENT STATISTICS, AND OVERALL**  
**LIFE-CYCLE COSTS**

**ENERGY SAVINGS:**

This section summarizes the annual energy use in millions of Btu and megawatt-hours at the site and at the source for the baseline and for the present building.

**INVESTMENT STATISTICS:**

1. **INVESTMENT THIS RUN**  
is the total investment associated with the present building. This number is the same as the total investment in building components and plant equipment given in Report ES-B.

The following quantities are meaningful only if baseline costs and energy use have been specified.

2. **BASELINE REPLACEMENT COSTS**  
gives the present value of life cycle replacement costs for the baseline. This quantity is specified by the keyword REPLACE-COST of the BASELINE command.
3. **INCREMENTAL INVESTMENT**  
is the INVESTMENT THIS RUN minus the sum of BASELINE REPLACEMENT COSTS and BASELINE FIRST COST (as given below under OVERALL LIFE-CYCLE COSTS).
4. **COST SAVINGS**  
is the present value of the life cycle savings in energy and operations costs. This number is also given in Report ES-A.
5. **RATIO OF SAVINGS TO INCREMENTAL INVESTMENT (SIR)**  
gives dollars saved per dollar invested. It is the ratio of COST SAVINGS and INCREMENTAL INVESTMENT. If this ratio is greater than 1.0, the investment may be cost effective.
6. **DISCOUNTED PAYBACK PERIOD**  
is the number of years it takes for the accumulated cost savings to equal the incremental investment. The shorter the payback period, the more cost effective is the investment.
7. **RATIO OF LIFE CYCLE ENERGY SAVINGS (AT SITE) TO INCREMENTAL INVESTMENT**  
gives the life cycle site energy saved per incremental investment dollar.
8. **RATIO OF LIFE CYCLE ENERGY SAVINGS (AT SOURCE) TO INCREMENTAL INVESTMENT**  
gives the life cycle source energy saved (in units of per incremental investment dollar).

**OVERALL LIFE-CYCLE COSTS:**

This section summarizes the life cycle costs and savings for the following categories: first cost (including installation), operations, replacements, energy, and sum of all these.

ENERGY SAVINGS

	ANNUAL ENERGY USE BASELINE (MBTU) (MWH)		ANNUAL ENERGY USE THIS RUN (MBTU) (MWH)		ANNUAL ENERGY SAVINGS (MBTU) (MWH)		ANNUAL ENERGY SAVINGS (PCT)
AT SITE	363.93	106.63	317.85	93.13	46.08	13.50	12.7
AT SOURCE	709.67	207.93	670.40	196.43	39.27	11.51	5.5

INVESTMENT STATISTICS

PROJECT LIFE 25.0 YEARS

INVESTMENT THIS RUN (\$)	BASELINE REPLACEMENT COSTS (\$)	INCREMENTAL INVESTMENT (\$)	COST SAVINGS (\$)	RATIO OF SAVINGS TO INCREMENTAL INVESTMENT (SIR)	DISCOUNTED PAYBACK PERIOD (YEARS)	RATIO OF LIFE CYCLE ENERGY SAVINGS (AT SITE) TO INCREMENTAL INVESTMENT (MBTU/\$)	RATIO OF LIFE-CYCLE ENERGY SAVINGS (AT SOURCE) TO INCREMENTAL INVESTMENT (MWH/\$)	RATIO OF LIFE-CYCLE ENERGY SAVINGS (AT SOURCE) TO INCREMENTAL INVESTMENT (MBTU/\$)	RATIO OF LIFE-CYCLE ENERGY SAVINGS (AT SOURCE) TO INCREMENTAL INVESTMENT (MWH/\$)
34773.	0.	5475.	8243.	1.51	16.18	0.21	0.06	0.18	0.05

OVERALL LIFE-CYCLE COSTS (\$)

	FIRST COST	OPRNS COST	REPLACEMENTS	ENERGY COST	T O T A L
BASELINE	29298.	5722.	0.	130642.	165662.
THIS RUN	34773.	3691.	0.	124431.	162894.
SAVINGS (\$)	-5475.	2031.	0.	6211.	2768.
(PCT)	-18.7	35.5	0.0	4.8	1.7

## REPORT ES-D ENERGY COST SUMMARY

This report summarizes the yearly energy consumption and cost for all UTILITY-RATEs defined.

1. UTILITY-RATE  
lists the u-name of each UTILITY-RATE
2. RESOURCE  
lists the RESOURCE
3. METERS  
lists the meter numbers to which each UTILITY-RATE applies.
4. METERED ENERGY  
is the actual metered energy from PLANT, not adjusted for any minimum energy requirements.
5. TOTAL CHARGE  
is total yearly charge.
6. VIRTUAL RATE  
is the total yearly charge divided by the metered energy.
7. RATE USED ALL YEAR  
if NO, the rate was not used for all 12 billing cycles, either because the rate did not qualify all months, the QUAL-SCH was not active all months, or the run period was less than 12 months.
8. ENERGY COST/ GROSS BLDG AREA  
ENERGY COST/ NET BLDG AREA  
give the energy cost per unit area. Here, gross building area is the value of the keyword GROSS-AREA in the BUILDING-LOCATION command in LOADS. GROSS-AREA defaults to the net building area, which is the sum of the floor areas of the conditioned zones.

The program does a check to ensure that all energy passed from PLANT is accounted for in one or more UTILITY-RATEs. If not, or if double counting of energy has occurred, a warning will be printed at the bottom of this report.

SIMPLE STRUCTURE RUN 3, CHICAGO  
 DESIGN-DAY SIZING OF VAV SYSTEM  
 REPORT- ES-D ENERGY COST SUMMARY

DIVIDE INTO ZONES; ADD PLENUM  
 SHOW ALL REPORTS

DOE-2.1E-001 Thu Nov 4 15:19:02 1993EDL RUN 1

UTILITY-RATE	RESOURCE	METERS	METERED ENERGY UNITS/YR	TOTAL CHARGE (\$)	VIRTUAL RATE (\$/UNIT)	RATE USED ALL YEAR?
ELEC-TARIFF	ELECTRICITY	1 2 3 4 5	50644. KWH	3223.	0.0636	YES
GAS-RATE	NATURAL-GAS	1 2 3 4 5	1911. THERMS	1146.	0.6000	YES

=====  
 4369.

ENERGY COST/GROSS BLDG AREA: 0.87  
 ENERGY COST/NET BLDG AREA: 0.87

## REPORT ES-E

### SUMMARY OF UTILITY-RATE: U-NAME

This report summarizes the key costs for each UTILITY-RATE. The top of the report contains general information regarding the UTILITY-RATE as input by the user or defaulted. The remainder of the report summarizes costs by month.

1. MONTH  
is the billing period ending with the BILLING-DAY.
2. METERED ENERGY  
is the energy in the meters as passed by the PLANT program.
3. BILLING ENERGY  
is the energy used for billing purposes. This amount may be greater than the metered energy if a minimum energy qualifier is used. This amount will be 0.0 if the UTILITY-RATE did not qualify for this month.
4. METERED DEMAND  
is the maximum demand in the meters in this billing period as passed by the PLANT program. The value will be either the hourly or daily demand as specified by the DEMAND-WINDOW.
5. BILLING DEMAND  
is the demand used for billing purposes. This amount may be either greater or less than the metered demand depending on the minimum demand qualifier and/or ratchets. This value will be 0.0 if the UTILITY-RATE did not qualify for this month.
6. ENERGY CHARGE  
are all energy charges, including BLOCK-CHARGES.
7. DEMAND CHARGE  
are all demand charges, including BLOCK-CHARGES.
8. ENERGY CST ADJ  
are the energy cost adjustment.
9. TAXES  
are the sum of per unit and percentage taxes
10. SURCHARGES  
are the sum of per unit and percentage surcharges
11. FIXED CHARGE  
are the MONTH-CHGS defined by the user.

12. **MINIMUM CHARGE**  
is the minimum monthly charge as determined by the MIN-MON-CHG or the MIN-MON-DEM-CHG.
13. **VIRTUAL RATE**  
is the total charge divided by the metered energy. This rate should not exceed the RATE-LIMITATION plus fixed charges.
14. **TOTAL CHARGE**  
is the sum of all charges.



SIMPLE STRUCTURE RUN 3, CHICAGO  
 DESIGN-DAY SIZING OF VAV SYSTEM  
 REPORT- ES-E SUMMARY OF UTILITY-RATE:

DIVIDE INTO ZONES; ADD PLENUM  
 SHOW ALL REPORTS  
 ELEC-TARIFF

DOE-2.1E-001 Thu Nov 4 15:19:02 1993EDL RUN 1

UTILITY-RATE: ELEC-TARIFF

RESOURCE: ELECTRICITY  
 METERS: 1 2 3 4 5  
 POWER-FACTOR: 0.80

DEMAND-WINDOW: HOUR  
 BILLING-DAY: 31  
 EXCESS-KVAR-FRAC: 0.30

3413. BTU/KWH  
 RATE-LIMITATION: 0.0000  
 EXCESS-KVAR-CHG: 0.0000

RATE-QUALIFICATIONS

MIN-ENERGY: 0.0  
 MAX-ENERGY: 0.0  
 MIN-DEMAND: 0.0  
 MAX-DEMAND: 0.0  
 QUALIFY-RATE: ALL-MONTHS  
 USE-MIN-QUAL: NO

BLOCK-CHARGES

DEMAND-RATCHETS

MIN-MON-RATCHETS

MONTH	METERED ENERGY KWH	BILLING ENERGY KWH	METERED DEMAND KW	BILLING DEMAND KW	ENERGY CHARGE (\$)	DEMAND CHARGE (\$)	ENERGY CST ADJ (\$)	TAXES (\$)	SURCHRG (\$)	FIXED CHARGE (\$)	MINIMUM CHARGE (\$)	VIRTUAL RATE (\$/UNIT)	TOTAL CHARGE (\$)
JAN	3918	3918	16.2	16.2	245	0	0	0	0	0	0	0.0624	245
FEB	3334	3334	16.1	16.1	208	0	0	0	0	0	0	0.0625	208
MAR	3378	3378	15.8	15.8	212	0	0	0	0	0	0	0.0629	212
APR	3417	3417	22.2	22.2	218	0	0	0	0	0	0	0.0637	218
MAY	3857	3857	28.4	28.4	247	0	0	0	0	0	0	0.0641	247
JUN	4934	4934	33.8	33.8	318	0	0	0	0	0	0	0.0644	318
JUL	6990	6990	39.2	39.2	448	0	0	0	0	0	0	0.0641	448
AUG	6351	6351	36.0	36.0	408	0	0	0	0	0	0	0.0642	408
SEP	4196	4196	30.7	30.7	270	0	0	0	0	0	0	0.0643	270
OCT	3519	3519	19.8	19.8	225	0	0	0	0	0	0	0.0639	225
NOV	3099	3099	21.1	21.1	196	0	0	0	0	0	0	0.0631	196
DEC	3651	3651	15.8	15.8	229	0	0	0	0	0	0	0.0626	229
TOTAL	50644	50644	39.2		3223	0	0	0	0	0		0.0636	3223

Page left intentionally blank

## REPORT ES-F

### BLOCK-CHARGES AND RATCHET SUMMARY

FOR: < u-name of UTILITY-RATE >

For each UTILITY-RATE this report summarizes the costs associated with each BLOCK-CHARGE, and the monthly RATCHET values. The summary varies somewhat for energy and demand BLOCK-CHARGES.

1. **BLOCK-CHARGES**  
lists the u-name of each BLOCK-CHARGE.
2. **JAN, FEB, etc.**  
is the billing period ending at the BILLING-DAY of the parent UTILITY-RATE.
3. **METERED ENERGY**  
is the metered energy as passed to the BLOCK-CHARGE from the parent UTILITY-RATE for each billing period, and as modified by any BLOCK-SCH for actual activity. This value will be less than the value shown for the parent UTILITY-RATE in report ES-E if the BLOCK-CHARGE was not active the whole billing period.
4. **BILLING ENERGY**  
is the energy used for billing calculations. This value may be larger than the metered energy if a minimum energy qualifier is used. In addition, when costs are to be prorated between two blocks sharing the same billing period (i.e, when the season changes), this value is the total energy for the billing period.
5. **PRORATE FACTOR**  
is shown only if a block is not used for an entire billing period. It is the multiplier used to split the costs between two BLOCK-CHARGES sharing the same billing period. For seasonal changes, it is the ratio of the total hours this BLOCK-CHARGE was active to the total hours in the billing period. For seasonal changes involving seasonal or time of use charges, it is the ratio of the total hours this BLOCK-CHARGE was active to the sum of these hours plus the active hours of the other BLOCK-CHARGE.
6. **CHARGES (\$)**  
are the charges for the billing period. These charges are based on the billing energy, multiplied by any prorate factor shown.
7. **METERED-DEMAND**  
is the metered demand as passed to the BLOCK-CHARGE from the parent UTILITY-RATE for each billing period, and as modified by any BLOCK-SCH for actual activity.
8. **BILLING DEMAND**  
is the demand used for billing calculations. This value includes any minimum demands and also ratchets. For time of use blocks sharing a TOU-SEASON-LINK, the demand will be the maximum demand of either block when both share the same billing period.

9. **TOTAL ENERGY**  
is the total billing energy accounted for in all **BLOCK-CHARGE**s. If this value does not match the quantity shown in report **ES-E** for the parent **UTILITY-RATE**, a warning will be printed indicating whether the **BLOCK-CHARGE**s are undercounting or double counting energy.
10. **TOTAL CHARGES**  
are the total charges for energy and demand **BLOCK-CHARGE**s.
11. **RATCHETS**  
is the u-name of each **RATCHET**.
12. **TYPE**  
is the type of peak load calculation defined; the value is either **PEAK** or **AVERAGE**.
13. **JAN, FEB, etc.**  
is the billing period ending on the **BILLING-DAY**. For each billing period, the value of the ratchet is listed. The user should review these values carefully to ensure that the ratchet is functioning as intended.

REPORT- ES-F BLOCK-CHARGE AND RATCHET SUMMARY FOR: ELEC-RATE

UTILITY-RATE: ELEC-RATE  
 RESOURCE: ELECTRICITY  
 ENERGY-UNITS: KWH  
 DEMAND-UNITS: KW  
 DEMAND-WINDOW: HOUR

BLOCK-CHARGES	JAN	FEB	MAR	APR	MAY	JUN	JUL	AUG	SEP	OCT	NOV	DEC	YEAR
-----													
WINTER-OFF-P	USE: TIME-OF-USE												
METERED ENERGY:	101083	70558	66003	53122	33673	0	0	0	45415	49970	52607	70150	
BILLING ENERGY:	101083	70558	66003	53122	33673	0	0	0	45415	49970	52607	70150	542581
KWH/KW DEMAND:	2404.8	2404.8	2404.8	1532.2	1654.1	0.0	0.0	0.0	1506.2	1567.2	1635.8	2404.8	
ENERGY CHGS(\$):	4043	2822	2640	2125	1347	0	0	0	1817	1999	2104	2806	21703
WINTER-SHOUL	USE: TIME-OF-USE												
METERED ENERGY:	374244	308760	325254	291074	131420	0	0	0	148723	259821	311664	366207	
BILLING ENERGY:	374244	308760	325254	291074	131420	0	0	0	148723	259821	311664	366207	2517167
KWH/KW DEMAND:	5242.9	4465.4	3775.2	2974.2	2612.3	0.0	0.0	0.0	2931.9	2653.2	4896.1	4632.2	
ENERGY CHGS(\$):	16841	13894	14636	13098	5914	0	0	0	6693	11692	14025	16479	113273
WINTER-ON-P	USE: TIME-OF-USE												
METERED ENERGY:	265196	238262	245083	250458	100751	0	0	0	112778	218054	237678	278357	
BILLING ENERGY:	265196	238262	245083	250458	100751	0	0	0	112778	218054	237678	278357	1946618
KWH/KW DEMAND:	3751.9	3584.4	2922.1	3085.4	2303.3	0.0	0.0	0.0	2582.6	2789.8	3505.8	3775.7	
ENERGY CHGS(\$):	13260	11913	12254	12523	5038	0	0	0	5639	10903	11884	13918	97331
SUMMER-OFF-P	USE: TIME-OF-USE												
METERED ENERGY:	0	0	0	0	40643	107781	129078	124020	45544	0	0	0	
BILLING ENERGY:	0	0	0	0	40643	107781	129078	124020	45544	0	0	0	447066
KWH/KW DEMAND:	0.0	0.0	0.0	0.0	2241.4	2865.1	3321.5	3178.9	2135.7	0.0	0.0	0.0	
ENERGY CHGS(\$):	0	0	0	0	1829	4850	5809	5581	2049	0	0	0	20118
SUMMER-SHOUL	USE: TIME-OF-USE												
METERED ENERGY:	0	0	0	0	125871	301229	322381	318381	127532	0	0	0	
BILLING ENERGY:	0	0	0	0	125871	301229	322381	318381	127532	0	0	0	1195393
KWH/KW DEMAND:	0.0	0.0	0.0	0.0	3257.2	3484.0	3811.1	3648.0	3078.0	0.0	0.0	0.0	
ENERGY CHGS(\$):	0	0	0	0	6923	16568	17731	17511	7014	0	0	0	65747
SUMMER-ON-P	USE: TIME-OF-USE												
METERED ENERGY:	0	0	0	0	124028	298808	319915	319553	126927	0	0	0	
BILLING ENERGY:	0	0	0	0	124028	298808	319915	319553	126927	0	0	0	1189231
KWH/KW DEMAND:	0.0	0.0	0.0	0.0	2530.8	2952.3	3162.2	2929.0	2700.4	0.0	0.0	0.0	
ENERGY CHGS(\$):	0	0	0	0	8062	19423	20794	20771	8250	0	0	0	77300
WINTER-DEMAND	USE: TIME-OF-USE												
METERED DEMAND:	3751.9	3584.4	2922.1	3085.4	2303.3	0.0	0.0	0.0	2582.6	2789.8	3505.8	3775.7	
BILLING DEMAND:	3751.9	3584.4	2922.1	3085.4	2530.8	0.0	0.0	0.0	2700.4	2789.8	3505.8	3775.7	
PRORATE FACTOR:	1.0000	1.0000	1.0000	1.0000	0.4545	0.0000	0.0000	0.0000	0.4783	1.0000	1.0000	1.0000	
DEMAND CHGS(\$):	18759	17922	14610	15427	5752	0	0	0	6457	13949	17529	18879	129284
SUMMER-DEMAND	USE: TIME-OF-USE												
METERED DEMAND:	0.0	0.0	0.0	0.0	2530.8	2952.3	3162.2	2929.0	2700.4	0.0	0.0	0.0	
BILLING DEMAND:	0.0	0.0	0.0	0.0	2530.8	2952.3	3162.2	2929.0	2700.4	0.0	0.0	0.0	
PRORATE FACTOR:	0.0000	0.0000	0.0000	0.0000	0.5455	1.0000	1.0000	1.0000	0.5217	0.0000	0.0000	0.0000	
DEMAND CHGS(\$):	0	0	0	0	8283	17714	18973	17574	8453	0	0	0	70997
=====													

# APPENDIX D

## WINDOW-4 Glass Layer Library

## WINDOW-4 Glass Layer Library

### Description

Following is a listing of the WINDOW-4 glass layer library. It is shown here to indicate the properties of the individual glass layers that were used by WINDOW-4 to build the DOE-2 Window Library, whose index is shown in Table 2.12. Each layer entry gives the ID number, name, thickness, solar transmittance, front and back side solar reflectance, visible transmittance, front and back side visible reflectance, thermal infrared transmittance, front and back side thermal infrared hemispherical emissivity, and thermal conductivity (W/m-K). This library is **not** accessible from DOE-2; it is shown here for reference only.

### Index to WINDOW-4 Glass Layer Library

ID	GLASS	d(mm)	Tsol	Rfsol	Rbsol	Tvis	Rfvis	Rbvis	Tir	Emis1	Emis2	k
1	CLEAR	3.000	.850	.075	.075	.901	.081	.081	.033	.853	.853	.900
2	CLEAR	3.000	.837	.075	.075	.898	.081	.081	.000	.840	.840	.900
3	CLEAR	6.000	.775	.071	.071	.881	.080	.080	.000	.840	.840	.900
4	CLEAR	12.000	.653	.064	.064	.841	.077	.077	.000	.840	.840	.900
5	BRONZE	3.000	.645	.062	.062	.685	.065	.065	.000	.840	.840	.900
6	BRONZE	6.000	.482	.054	.054	.534	.057	.057	.000	.840	.840	.900
7	BRONZE	10.000	.326	.048	.048	.379	.050	.050	.000	.840	.840	.900
8	GREY	3.000	.626	.061	.061	.611	.061	.061	.000	.840	.840	.900
9	GREY	6.000	.455	.053	.053	.431	.052	.052	.000	.840	.840	.900
10	GREY	12.000	.217	.044	.044	.187	.045	.045	.000	.840	.840	.900
11	GREEN	3.000	.635	.063	.063	.822	.075	.075	.000	.840	.840	.900
12	GREEN	6.000	.487	.056	.056	.749	.070	.070	.000	.840	.840	.900
13	LOW IRON	2.500	.904	.080	.080	.914	.083	.083	.000	.840	.840	.900
14	LOW IRON	3.000	.899	.079	.079	.913	.082	.082	.000	.840	.840	.900
15	LOW IRON	4.000	.894	.079	.079	.911	.082	.082	.000	.840	.840	.900
16	LOW IRON	5.000	.889	.079	.079	.910	.082	.082	.000	.840	.840	.900
17	BLUE	6.000	.480	.050	.050	.570	.060	.060	.000	.840	.840	.900
200	REF A CLEAR LO	6.000	.066	.341	.493	.080	.410	.370	.000	.840	.400	.900
201	REF A CLEAR MID	6.000	.110	.270	.430	.140	.310	.350	.000	.840	.470	.900
202	REF A CLEAR HI	6.000	.159	.220	.370	.200	.250	.320	.000	.840	.570	.900
210	REF A TINT A LO	6.000	.040	.150	.470	.050	.170	.370	.000	.840	.410	.900
211	REF A TINT A MID	6.000	.060	.130	.420	.090	.140	.350	.000	.840	.470	.900
212	REF A TINT A HI	6.000	.100	.110	.380	.100	.110	.320	.000	.840	.530	.900
220	REF B CLEAR LO	6.000	.150	.220	.380	.200	.230	.330	.000	.840	.580	.900
221	REF B CLEAR HI	6.000	.240	.160	.320	.300	.160	.290	.000	.840	.600	.900
230	LREF B TINT O	6.000	.040	.130	.420	.050	.090	.280	.000	.840	.410	.900
231	MREF B TINT ID	6.000	.100	.110	.410	.130	.100	.320	.000	.840	.450	.900
232	HREF B TINT I	6.000	.150	.090	.330	.180	.080	.280	.000	.840	.600	.900
240	REF C CLEAR LO	6.000	.110	.250	.490	.130	.280	.420	.000	.840	.430	.900
241	REF C CLEAR MID	6.000	.170	.200	.420	.190	.210	.380	.000	.840	.510	.900
242	REF C CLEAR HI	6.000	.200	.160	.390	.220	.170	.350	.000	.840	.550	.900

Index to WINDOW-4 Glass Layer Library

ID	GLASS	d(mm)	Tsol	Rfsol	Rbsol	Tvis	Rfvis	Rbvis	Tir	Emis1	Emis2	k
250	REF C TINT LO	6.000	.070	.130	.490	.080	.130	.420	.000	.840	.430	.900
251	REF C TINT MID	6.000	.100	.100	.420	.110	.100	.380	.000	.840	.510	.900
252	REF C TINT HI	6.000	.120	.090	.390	.130	.090	.350	.000	.840	.550	.900
260	REF D CLEAR	6.000	.429	.308	.379	.334	.453	.505	.000	.840	.820	.900
270	REF D TINT	6.000	.300	.140	.360	.250	.180	.450	.000	.840	.820	.900
300	PYR A CLEAR	3.000	.750	.100	.100	.850	.120	.120	.000	.840	.400	.900
350	PYR B CLEAR	3.000	.740	.090	.100	.820	.110	.120	.000	.840	.200	.900
351	PYR B CLEAR	6.000	.680	.090	.100	.810	.110	.120	.000	.840	.200	.900
400	PYR Low E CLEAR	3.000	.630	.190	.220	.850	.079	.056	.000	.840	.100	.900
401	PYR Low E CLEAR	6.000	.600	.170	.220	.840	.055	.078	.000	.840	.100	.900
451	PYR Low E TINT	6.000	.360	.093	.200	.500	.035	.054	.000	.840	.100	.900
500	SPEC SEL CLEAR	3.000	.450	.340	.370	.780	.070	.050	.000	.840	.040	.900
501	SPEC SEL CLEAR	6.000	.430	.300	.420	.770	.070	.060	.000	.840	.030	.900
550	SPEC SEL TINT	6.000	.260	.140	.410	.460	.060	.040	.000	.840	.030	.900
600	HEAT MIRROR 88	.051	.656	.249	.227	.868	.064	.060	.000	.136	.720	.140
601	HEAT MIRROR 77	.051	.504	.402	.398	.766	.147	.167	.000	.075	.720	.140
602	HEAT MIRROR 66	.051	.403	.514	.515	.658	.256	.279	.000	.057	.720	.140
603	HEAT MIRROR 55	.051	.320	.582	.593	.551	.336	.375	.000	.046	.720	.140
604	HEAT MIRROR 44	.051	.245	.626	.641	.439	.397	.453	.000	.037	.720	.140
700	ecabs-1.blc	6.000	.814	.086	.086	.847	.099	.099	.000	.840	.840	.900
701	ecabs-1.col	6.000	.111	.179	.179	.128	.081	.081	.000	.840	.840	.900
702	ecref-1.blc	6.000	.694	.168	.168	.818	.110	.110	.000	.840	.840	.900
703	ecref-1.col	6.000	.099	.219	.219	.155	.073	.073	.000	.840	.840	.900
704	ecabs-2.blc	6.000	.814	.086	.086	.847	.099	.099	.000	.100	.840	.900
705	ecabs-2.col	6.000	.111	.179	.179	.128	.081	.081	.000	.100	.840	.900
706	ecref-2.blc	6.000	.694	.168	.168	.818	.110	.110	.000	.100	.840	.900
707	ecref-2.col	6.000	.099	.219	.219	.155	.073	.073	.000	.100	.840	.900
708	low-E select	6.000	.406	.288	.353	.780	.060	.050	.000	.840	.040	.900
709	genclear.lbl	6.000	.774	.076	.077	.883	.086	.087	.000	.838	.838	.900



# APPENDIX E

Example Entry from the DOE-2 Window Library

## Example Entry from the Window Library

### Description

This appendix shows an example of an entry from the DOE-2 Window Library. Only the quantities shown in bold face are used in the DOE-2 calculation. Other window-related data (such as glass height and width and frame width) are obtained from your BDL input for the window. In the following line-by-line description of the entry, *pane* refers to a solid layer (glass, plastic, etc.) and *gap* refers to a gas-filled space between panes. Panes are numbered starting with the outside pane, so that for double glazing, for example, pane 1 is the outside pane and pane 2 is the inside pane. Gaps are numbered starting with the outside pane, so that for triple glazing, for example, gap 1 is between panes 1 and 2 and gap 2 is between panes 2 and 3.

### Line Description

3. Units type. All units in this library are SI.
5. Short description of glazing; same descriptor appears in the Index to the Window Library, Table 2.12. "Single Band Calculation" means that the optical properties of the glazing system were calculated by WINDOW-4 using the total (wavelength-integrated) optical properties of the glass layers. "Multiple Band Calculation" means that the properties of the glazing system were calculated wavelength by wavelength using the spectral properties of the layers, and then averaged to give the total properties over the solar, visible, and thermal infrared spectral ranges (see WINDOW-4 documentation).
6. GLASS-TYPE-CODE
7. Tilt angle in degrees for which the U-values, lines 52-55, were calculated; tilt = 90 corresponds to vertical glazing. DOE-2 recalculates U-value for actual tilt of glazing.
8. Number of panes.
9. Frame type ID, frame descriptor, and U-value of frame (which was used to calculate the frame contribution to the overall U-values in lines 52-55). Other frame U-values besides the one indicated can be specified in the DOE-2 input.
10. SPACER-TYPE-CODE, spacer descriptor, and spacer coefficients. Used to calculate the edge-of-glass contribution to the overall U-values in lines 52-55. Other SPACER-TYPE-CODEs can be entered in the DOE-2 input.
- 11-14. Overall height and width of window including frame; height and width of glazed portion of window, excluding frame. Used to calculate overall U-values in lines 52-55, but not used by DOE-2. Actual frame and glazing dimensions must be separately specified in the DOE-2 input for the window.
- 17-21. Thermophysical properties of the gap gas fill. For double glazing, only gap 1 (line 17) is relevant. For triple glazing, only gaps 1 and 2 are relevant. In this example there is one gap and the gas fill is argon. Given are gap width (mm), conductivity (W/m-K), temperature derivative of conductivity (W/m-K<sup>2</sup> x 10<sup>-5</sup>), viscosity (kg/m-s x 10<sup>-5</sup>), temperature

derivative of viscosity ( $\text{kg/m-s-K} \times 10^{-7}$ ), density ( $\text{kg/m}^3$ ), temperature derivative of density ( $\text{kg/m}^3\text{-K}$ ), Prandtl number, and temperature derivative of Prandtl number ( $1/\text{K}$ ).

- 23-35. Center-of-glass solar-optical properties of the glazing for angles of incidence between  $0^\circ$  (normal incidence) and  $90^\circ$ , and for hemispherical diffuse radiation:

Tsol = overall solar transmittance of glazing assembly.

AbsN = solar absorptance of pane N, i.e., the fraction of incident solar absorbed in pane N.

Rfsol = overall solar reflectance of the glazing assembly for radiation incident from the front, i.e., from the outside. Not used by DOE-2.

Rbsol = overall solar reflectance for radiation incident from the back, i.e., from the inside.

Tvis = overall visible transmittance of the glazing assembly.

Rfvis, Rbvis = the overall visible reflectance for radiation incident from the front and back, respectively.

SHGC = the solar heat gain coefficient, which is the fraction of the solar radiation incident on the glazing that enters the room as heat. Calculated by WINDOW-4 for ASHRAE summer conditions (95F outside temperature, 75F room temperature, 7.5 mph windspeed, and near-normal incident solar radiation of  $248 \text{ Btu/h-ft}^2$ ). Not used by DOE-2.

36. Center-of-glass shading coefficient, which is the solar heat gain through the center of the glazing divided by the solar heat gain through 1/8-in, double-strength clear glass. Calculated by WINDOW-4 for ASHRAE summer conditions. (Note: the version of WINDOW-4 available at the time of this writing (Feb 1993) calculates this as the *overall* shading coefficient [glazing plus frame], rather than the center-of-glass shading coefficient. This has no effect on DOE-2 results since DOE-2 does not use the shading coefficient value from the Window Library.)

- 40-46. Thermophysical data for each pane. Layer ID# = identification number from the WINDOW-4 Glass Layer Library, Appendix D.

Tir = thermal infrared transmittance.

Emis F, Emis B = thermal emissivity of front and back surface, respectively.

Cond = conductance ( $\text{W/m}^2\text{-K}$ ),

Spectral File = name of file containing transmittance and reflectance values at different wavelengths for each glass layer for multiband calculation of overall solar-optical properties of the glazing assembly (see WINDOW-4 documentation).

- 48-51. Headings for the table in lines 52-55.

- 52-55. Summary table of U-values for overall window (including edge of glass and frame) and for center of glass, as a function of incident solar radiation, windspeed, and outdoor

temperature. All values shown are as calculated by WINDOW-4. (These values are recalculated each hour by DOE-2.) hcout and hrou are convective and radiative outside air film conductances, respectively (hrou assumes the outside surface radiates to a black body). hin is the combined convective plus radiative inside air film conductance (assuming the inside surface radiates to a black body). Column pairs beneath each outside temperature give overall and center-of-glass U-values.

For example, 1.46W/m<sup>2</sup>-K is the center-of-glass U-value for outdoor temperature = -17.8°C (0°F), incident solar radiation = 0, and windspeed = 6.71 m/s (15 mph). The bold faced quantities here are used only in the DOE-2 Custom Weighting Factor calculation.

### Sample Entry from the DOE-2 Window Library

(Note: Bold faced numbers are used in the DOE-2 calculation. Italicized numbers are defaults that are used in the DOE-2 calculation if not specified in the input.)

1. WINDOW 4 Data File : Single Band Calculation											
2.											
3. Unit System : SI											
4. Name : DOE2 WINDOW LIB											
5. Desc : LOW-E (e2=.1) CLEAR IG											
6. Window ID : <b>2835</b>											
7. Tilt : 90.0											
8. Glazings : 2											
9. Frame : 3 Alum, flush <i>9.970</i>											
10. Spacer : 1 Aluminum <i>1.310 0.736 0.000</i>											
11. Total Height : 1828.8 mm											
12. Total Width : 1219.2 mm											
13. Glass Height : 1714.5 mm											
14. Glass Width : 1104.9 mm											
15. Mullion : None											
16. Gap		Thick	Cond	dCond	Vis	dVis	Dens	dDens	Pr	dPr	
17. 1 Argon		<b>12.7</b>	<b>0.01620</b>	<b>5.000</b>	<b>2.110</b>	<b>6.300</b>	<b>1.700</b>	<b>-0.0060</b>	<b>0.680</b>	<b>0.00066</b>	
18. 2 Air		0.	0.	0.	0.	0.	0.	0.	0.	0.	
19. 3 Air	0	.	0.	0.	0.	0.	0.	0.	0.	0.	
20. 4 Air	0	.	0.	0.	0.	0.	0.	0.	0.	0.	
21. 5 Air	0	.	0.	0.	0.	0.	0.	0.	0.	0.	
22. Angle	0.	10.	20.	30.	40.	50.	60.	70.	80.	90.	Hemis
23. Tsol	<b>0.472</b>	<b>0.475</b>	<b>0.467</b>	<b>0.456</b>	<b>0.442</b>	<b>0.416</b>	<b>0.361</b>	<b>0.261</b>	<b>0.117</b>	<b>0.000</b>	<b>0.388</b>
24. Abs1	<b>0.238</b>	<b>0.241</b>	<b>0.250</b>	<b>0.257</b>	<b>0.259</b>	<b>0.266</b>	<b>0.286</b>	<b>0.310</b>	<b>0.270</b>	<b>0.001</b>	<b>0.266</b>
25. Abs2	<b>0.094</b>	<b>0.095</b>	<b>0.095</b>	<b>0.097</b>	<b>0.099</b>	<b>0.099</b>	<b>0.098</b>	<b>0.083</b>	<b>0.059</b>	<b>0.000</b>	<b>0.092</b>
26. Abs3	0.	0.	0.	0.	0.	0.	0.	0.	0.	0.	0.
27. Abs4	0.	0.	0.	0.	0.	0.	0.	0.	0.	0.	0.
28. Abs5	0.	0.	0.	0.	0.	0.	0.	0.	0.	0.	0.
29. Abs6	0.	0.	0.	0.	0.	0.	0.	0.	0.	0.	0.
30. Rfsol	0.196	0.189	0.187	0.190	0.200	0.219	0.257	0.345	0.555	0.999	0.244

**Sample Entry from the DOE-2 Window Library (continued)**

31. Rbsol	0.205	0.201	0.199	0.200	0.207	0.224	0.265	0.363	0.569	1.000	0.254
32. Tvis	0.745	0.744	0.739	0.733	0.722	0.693	0.820	0.468	0.232	0.000	0.841
33. Rfvis	0.112	0.111	0.112	0.115	0.125	0.151	0.217	0.362	0.620	1.000	0.194
34. Rbvis	0.141	0.140	0.141	0.145	0.155	0.181	0.250	0.400	0.655	1.000	0.226
35. SHGC	0.564	0.567	0.560	0.551	0.538	0.513	0.458	0.349	0.181	0.000	0.480
36. SC:	0.66										

37.  
38.  
39.

40. Layer ID#	401	3	0	0	0	0					
41. Tir	0.000	0.000	0.	0.	0.	0.					
42. Emis F	0.840	0.840	0.	0.	0.	0.					
43. Emis B	0.100	0.840	0.	0.	0.	0.					
44. Thickness(mm)	6.0	6.0	0.	0.	0.	0.					
45. Cond(W/m2-C)	150.0	150.0	0.	0.	0.	0.					
46. Spectral File	None	None	None	None	None	None					

47.

48. Overall and Center-of-Glass Window U-values (W/m2-C)

49. Outdoor Temperature					-17.8C		15.6C		26.7C		37.8C	
50. Solar	WdSpd	hcout	hrout	hin								
51. (W/m2)	(m/s)	(W/m2-C)										
52. 0	0.00	12.25	3.24	7.58	1.93	1.40	1.88	1.33	1.90	1.37	1.96	1.44
53. 0	6.71	25.47	3.21	7.60	1.98	1.46	1.92	1.38	1.94	1.42	2.00	1.49
54. 783	0.00	12.25	3.47	7.24	1.94	1.42	1.96	1.44	2.00	1.49	2.04	1.53
55. 783	6.71	25.47	3.34	6.82	2.00	1.49	1.99	1.47	2.03	1.53	2.07	1.57

# APPENDIX F

## ALPHABETICAL LIST OF COMMANDS AND KEYWORDS FOUND IN DOE-2.1E

Appendix F is an alphabetized compilation of all commands and keywords found in the current version of the program. Commands are bold-faced and indicated with a bullet (•). To the right of each command/keyword is its abbreviation, followed by the subprogram where it resides and, for a keyword, the command with which it is associated. The subprograms have been shortened to a single letter designation (L = LOADS, S = SYSTEMS, P = PLANT, E = ECONOMICS). The next four columns list page numbers where the word can be found. The last column shows the program version and date when the command/keyword was introduced. There is no column for the *Engineers Manual* yet. The *Users Guide* has been replaced by *DOE-2 Basics*.

### Alphabetical List of Commands and Keywords found in DOE-2.1E

We have compiled an alphabetical list of all commands and keywords found in the current version of the program. Commands are bold-faced and indicated with a bullet (•). To the right of each command/keyword is its abbreviation, followed by the subprogram where it resides and, for a keyword, the command with which it is associated. The subprograms have been shortened to a single letter designation (L = LOADS, S = SYSTEMS, P = PLANT, E = ECONOMICS). The next four columns list page numbers where the word can be found. The last column shows the program version and date when the command/keyword was introduced. There is no column for the *Engineers Manual* yet. The *Users Guide* has been replaced by *DOE-2 Basics*.

•COMMAND or Keyword	Abbrev	Subprogram — Command	DOE-2 Basics (2.1E)	BDL Summary (2.1E)	Supp (2.1E)	Ref Man (2.1A)	Program version	Year added
•ABORT		LSPE	F.3	7,28, 47,59		II.19	2.0—	2/15/79
ABSOR1-CAP-FT		P — EQUIPMENT-QUAD		55	4.81	V.40,43	2.1—	5/15/80
ABSOR1-HIR		P — PLANT-PARAMETERS	4.11,F.16	51		V.22	2.1—	5/15/80
ABSOR1-HIR-FPLR		P — EQUIPMENT-QUAD		55	4.81	V.40,43	2.1—	5/15/80
ABSOR1-HIR-FT		P — EQUIPMENT-QUAD		55	4.81	V.40,43	2.1—	5/15/80
ABSOR2-CAP-FT		P — EQUIPMENT-QUAD		55	4.81	V.40,43	2.1—	5/15/80
ABSOR2-HIR		P — PLANT-PARAMETERS	4.11,F.16	51	4.10	V.22	2.1—	5/15/80
ABSOR2-HIR-FPLR		P — EQUIPMENT-QUAD		55	4.81	V.40,43	2.1—	5/15/80
ABSOR2-HIR-FT		P — EQUIPMENT-QUAD		55	4.81	V.40,43	2.1—	5/15/80
ABSORG-CAP-FT		P — EQUIPMENT-QUAD		55	4.8,4.10, 4.81	V.40,43	2.1D—	6/30/89
ABSORG-HCAP-FQC		P — EQUIPMENT-QUAD		55	4.9, 4.10 4.81		2.1D —	6/30/89
ABSORG-HCAPR		P — PLANT-PARAMETERS		51	4.10		2.1D—	6/30/89
ABSORG-HEAT-XBEFF		P — PLANT-PARAMETERS	4.11,F.16	51	4.9,4.10		2.1D—	6/30/89
ABSORG-HIR		P — PLANT-PARAMETERS	4.11,F.16	51			2.1D—	6/30/89
ABSORG-HIR1-FIT		P — EQUIPMENT-QUAD		55	4.8,4.10, 4.81		2.1D—	6/30/89
ABSORG-HIR-FPLR		P — EQUIPMENT-QUAD		55	4.8,4.10, 4.81		2.1D—	6/30/89
ABSORG-HIR-FT		P — EQUIPMENT-QUAD		55	4.8,4.10, 4.81		2.1D—	6/30/89

•COMMAND or Keyword	Abbrev	Subprogram -- Command	DOE-2 Basics (2.1E)	BDL Summary (2.1E)	Supp (2.1E)	Ref Man (2.1A)	Program version	Year added
ABSORPTANCE	ABS	L -- CONSTRUCTION	2.11,F.5	11,12		III.82	2.0--	2/15/79
ABSOR-TO-TWR-WTR	A-T-T-W	P -- PLANT-PARAMETERS		53		V.23,V.26	2.0--	2/15/79
AIR-CHANGES/HR	A-C/HR	L -- SPACE-CONDITIONS	2.21,F.6	17	3.119	III.50	2.0--	2/15/79
		S -- ZONE-AIR	3.69,F.11	30		IV.189	2.0--	2/15/79
AIR-FLOW-CTRL-DT	A-F-C-DT	L -- WALL-PARAMETERS		15	2.12		2.1C--	5/15/84
AIR-FLOW-RATE	A-F-R	L -- WALL-PARAMETERS		15	2.12		2.1C--	5/15/84
AIR-FLOW-TYPE	A-F-T	L -- WALL-PARAMETERS		15	2.10		2.1C--	5/15/84
•ALT-HOLIDAYS		L		8			2.1E--	8/15/93
ALTITUDE	ALT	L -- BUILDING-LOCATION	2.4,F.3	8		III.30	2.0--	2/15/79
ANNUAL-COST	A-C	E -- COMPONENT-COST		61		VI.8	2.0--	2/15/79
AREA	A	L -- INTERIOR-WALL	2.32,F.7	24		III.113	2.0--	2/15/79
		L -- SPACE	2.24,F.7	18		III.97	2.0--	2/15/79
		L -- UNDERGROUND-WALL or -FLOOR	2.33,F.7	25		III.118	2.0--	2/15/79
AREA/PERSON	A/P	L -- SPACE-CONDITIONS	2.16,F.6	16			2.1D--	6/30/89
•ASSIGN		LS		26,46			2.1C--	5/15/84
ASSIGNED-CFM	A-CFM	S -- ZONE-AIR	3.69,F.11	30		IV.188	2.0--	2/15/79
ASSIGN-SCHEDULE	A-SCH	P -- LOAD-MANAGEMENT		57		V.60	2.0--	2/15/79
ATM-MOISTURE	ATM-M	L -- BUILDING-LOCATION		8	2.52		2.1B--	1/15/83
ATM-TURBIDITY	ATM-T	L -- BUILDING-LOCATION		8	2.52		2.1B--	1/15/83
AUX-ELEC-METER	AUX-EM	S -- PLANT-ASSIGNMENT		45	3.6,3.10		2.1E --	8/15/93
		S -- SYSTEM		40	3.6,3.10		2.1E --	8/15/93
		S -- ZONE		32	3.6,3.10		2.1E --	8/15/93
AXIS-ASSIGN	A-A	L -- HOURLY-REPORT		26		III.127	2.0A--	6/15/79
AXIS-MAX	A-MAX	L -- HOURLY-REPORT		26		III.127	2.0A--	6/15/79
AXIS-MIN	A-MIN	L -- HOURLY-REPORT		26		III.128	2.0A--	6/15/79
AXIS-TITLES	A-T	L -- HOURLY-REPORT		26		III.127	2.0A--	6/15/79
AZIMUTH	AZ	L -- BUILDING-LOCATION	2.5,F.3	7		III.31	2.0--	2/15/79
		L -- BUILDING-SHADE		14		III.35	2.0--	2/15/79
		L -- EXTERIOR-WALL or ROOF	2.25,F.7	19		III.102	2.0A--	6/15/79
		L -- FIXED-SHADE		14			2.1B--	1/15/83
		L -- INTERIOR-WALL		24	2.7		2.1C--	5/15/84



•COMMAND or Keyword	Abbrev	Subprogram -- Command	DOE-2 Basics (2.1E)	BDL Summary (2.1E)	Supp (2.1E)	Ref Man (2.1A)	Program version	Year added
		L - SPACE		18		III.97	2.0-	2/15/79
		L - TROMBE-WALL-V or -NV		20			2.1B-	1/15/83
BASEBOARD-CTRL	B-C	S - ZONE-CONTROL	3.67,F.10	30	3.116	IV.194	2.0-	2/15/79
BASEBOARD-RATING	B-R	S - ZONE	F.11,	32	3.116	IV.200	2.0-	2/15/79
BASEBOARD-SCH	B-SCH	S - SYSTEM-CONTROL	3.78	34	3.54,3.74	IV.209	2.0-	2/15/79
BASEBOARD-SOURCE	BASEB-S	S - SYSTEM	3.90,F.13	39	3.56,3.74	IV.260-262	2.0-	2/15/79
•BASELINE	E			61		VI.9		
BERNOU-1		S - SUBR-FUNCTIONS		42	1.6		2.1D-	6/30/89
BILLING-DAYS	B-D	E - UTILITY-RATE	5.4,F.18	60	5.9		2.1E -	8/15/93
•BLOCK-CHARGE	E		5.1,5.5,F.18	59	5.4,5.16		2.1E-	8/15/93
BLOCK-CHARGE	B-C	E - UTILITY-RATE	5.3,F.18	60	5.8		2.1E -	8/15/93
BLOCK-SCH	B-SCH	E - BLOCK-CHARGE	5.5,F.18	59	5.16		2.1E -	8/15/93
BLOCK1-DATA	B1-D	E - BLOCK-CHARGE	5.6,F.18	59	5.17		2.1E -	8/15/93
BLOCK1-TYPE	B1-T	E - BLOCK-CHARGE	5.5,F.18	59	5.16		2.1E -	8/15/93
BLOCK2-DATA	B2-D	E - BLOCK-CHARGE	5.7,F.18	59	5.18		2.1E -	8/15/93
BLOCK2-TYPE	B2-T	E - BLOCK-CHARGE	5.7,F.18	59	5.18		2.1E -	8/15/93
BLOCK3-DATA	B3-D	E - BLOCK-CHARGE	5.7,F.18	59	5.18		2.1E -	8/15/93
BLOCK3-TYPE	B3-T	E - BLOCK-CHARGE	5.7,F.18	59	5.18		2.1E -	8/15/93
BOILER-CONTROL		P - PLANT-PARAMETERS		52		V.24,V.30	2.1-	5/15/80
BOILER-EIR		S - PLANT-ASSIGNMENT		44	3.35		2.1E -	8/15/93
BOILER-HIR		S - PLANT-ASSIGNMENT		44	3.35		2.1E -	8/15/93
BOILER-HIR-FPLR		S - PLANT-ASSIGNMENT		44	3.35		2.1E -	8/15/93
BOILER-LOSS		S - PLANT-ASSIGNMENT		44	3.36		2.1E -	8/15/93
BOILER-MAX-RATIO		S - PLANT-ASSIGNMENT		44	3.35		2.1E -	8/15/93
BOILER-MAX-SCH		S - PLANT-ASSIGNMENT		44	3.35		2.1E -	8/15/93
BOILER-MIN-RATIO		S - PLANT-ASSIGNMENT		44	3.35		2.1E -	8/15/93
BOILER-SCH		S - PLANT-ASSIGNMENT		44	3.35		2.1E -	8/15/93
BOILER-SET-POINT		S - PLANT-ASSIGNMENT		44	3.35		2.1E -	8/15/93

COMMAND or Keyword	Abbrev	Subprogram -- Command	DOE-2 Basics (2.1E)	BDL Summary (2.1E)	Supp (2.1E)	Ref Man (2.1A)	Program version	Year added
BOILER-SET-SCH		S -- PLANT-ASSIGNMENT		44	3.36		2.1E --	8/15/93
BOILER-SIZE		S -- PLANT-ASSIGNMENT		44	3.35		2.1E --	8/15/93
BOILER-THROTTLE		S -- PLANT-ASSIGNMENT		44	3.36		2.1E --	8/15/93
BOILER-TYPE		S -- PLANT-ASSIGNMENT		44	3.35		2.1E --	8/15/93
•BUILDING-LOCATION	B-L	L	2.2.4,F.3	8	1.5,2.76,2.86	III.30	2.0--	2/15/79
•BUILDING-RESOURCE	B-R	L		25		III.39	2.0--	2/15/79
•BUILDING-SHADE	B-S	L		14	2.79	III.35	2.0--	2/15/79
<hr/>								
•CALCULATE		LS		26.46	1.10		2.1C--	5/15/84
CCIRC-DESIGN-T-DROP		P -- PLANT-PARAMETERS	4.13,F.16	54		V.25,V.33	2.1--	5/15/80
CCIRC-ELEC-METER		P -- PLANT-PARAMETERS		54	4.4.4.46		2.1E --	8/15/93
CCIRC-HEAD		P -- PLANT-PARAMETERS	4.13,F.16	54		V.25,V.33	2.1--	5/15/80
CCIRC-IMPELLER-EFF		P -- PLANT-PARAMETERS		54		V.25,V.33	2.1--	5/15/80
CCIRC-LOSS		P -- PLANT-PARAMETERS	4.13,F.16	54		V.25,V.33	2.1--	5/15/80
CCIRC-MIN-PLR		P -- PLANT-PARAMETERS	4.14,F.16	54	4.46		2.1C--	5/15/84
CCIRC-MOTOR-EFF		P -- PLANT-PARAMETERS		54		V.25,V.33	2.1--	5/15/80
CCIRC-PUMP-TYPE		P -- PLANT-PARAMETERS	4.14,F.16	54	4.45		2.1C--	5/15/84
CCIRC-SIZE-OPT		P -- PLANT-PARAMETERS	4.13,F.16	54	4.45		2.1C--	5/15/84
CFM/SQFT		S -- ZONE-AIR	3.69,F.11	30	3.119	IV.189	2.0--	2/15/79
CFMINE-0		S -- SUBR-FUNCTIONS		42	1.6		2.1D--	6/30/89
CFMINE-1		S -- SUBR-FUNCTIONS		42	1.6		2.1D--	6/30/89
CHANNEL-WIDTH	C-W	L -- WALL-PARAMETERS		15	2.71		2.1B--	1/15/83
CHILLER-CONTROL		P -- PLANT-PARAMETERS		51		V.22,V.23	2.1--	5/15/80
CHILL-WTR-T		P -- PLANT-PARAMETERS	4.11,F.16	51	4.43	V.22,V.23	2.0--	2/15/79
CHILL-WTR-THROTTLE		P -- PLANT-PARAMETERS		51	4.43	V.22,V.23	2.1--	5/15/80
CIRC-HEAD		S -- PLANT-ASSIGNMENT		44	3.41,3.90		2.1E --	8/15/93
CIRC-IMPELLER-EFF		S -- PLANT-ASSIGNMENT		44	3.41,3.90		2.1E --	8/15/93
CIRC-MIN-PLR		S -- PLANT-ASSIGNMENT		44	3.41,3.90		2.1E --	8/15/93
CIRC-MOTOR-EFF		S -- PLANT-ASSIGNMENT		44	3.41,3.90		2.1E --	8/15/93

•COMMAND or Keyword	Abbrev	Subprogram — Command	DOE-2 Basics (2.1E)	BDL Summary (2.1E)	Supp (2.1E)	Ref Man (2.1A)	Program version	Year added
CIRC-PUMP-FPLR		S — PLANT-ASSIGNMENT		44	3.41,3.90		2.1E —	8/15/93
CIRC-PUMP-SCH		S — PLANT-ASSIGNMENT		44	3.41,3.90		2.1E —	8/15/93
CIRC-PUMP-TYPE		S — PLANT-ASSIGNMENT		44	3.41,3.90		2.1E —	8/15/93
CLEARNESS	CL	L — DESIGN-DAY		9		III.27	2.0 —	2/15/79
CLEARNESS-NUMBER	C-N	L — BUILDING-LOCATION	2.6,F.3	8		III.32	2.0 —	2/15/79
CLOUD-AMOUNT	C-A	L — DESIGN-DAY		9		III.27	2.0 —	2/15/79
CLOUD-TYPE	C-T	L — DESIGN-DAY		9		III.27	2.0 —	2/15/79
COEFFICIENTS	COEF	SP — CURVE-FIT		29		IV.184	2.0 —	2/15/79
COGEN-TRACK-MODE		P — PLANT-PARAMETERS		54	4.47		2.1C —	5/15/84
		P — HEAT-RECOVERY		56	4.48		2.1E —	8/15/93
		P — LOAD-ASSIGNMENT		56	4.48		2.1E —	8/15/93
COGEN-TRACK-SCH		P — PLANT-PARAMETERS		54	4.47		2.1C —	5/15/84
		P — HEAT-RECOVERY		56	4.48		2.1E —	8/15/93
		P — LOAD-ASSIGNMENT		56	4.48		2.1E —	8/15/93
COIL-BF	C-BF	S — SYSTEM-EQUIPMENT		36	3.25	IV.246	2.1 —	5/15/80
COIL-BF-FCFM	C-BF-FC	S — SYSTEM-EQUIPMENT		37		IV.242,247	2.1 —	5/15/80
COIL-BF-FPLR	C-B-FPLR	S — SYSTEM-EQUIPMENT		37	3.128		2.1E —	8/15/93
COIL-BF-FT	C-BF-FT	S — SYSTEM-EQUIPMENT		37		IV.242,247	2.1 —	5/15/80
COMP-KW/TON-END		P — PLANT-PARAMETERS		52	4.18		2.1E —	8/15/93
COMP-KW/TON-START		P — PLANT-PARAMETERS		52	4.17		2.1E —	8/15/93
COMP-MODE-DCHG		P — PLANT-PARAMETERS		52	4.16		2.1E —	8/15/93
•COMPONENT-COST	C-C	E		61		VI.6	2.0 —	2/15/79
COMPONENT-LIFE	C-L	E — COMPONENT-COST		61		VI.6	2.0 —	2/15/79
COMPRESSOR-TYPE	C-TYPE	S — SYSTEM-EQUIPMENT		37	3.25	IV.249	2.1 —	5/15/80
•COMPUTE ECONOMICS		E	F.19	63		II.34	2.0 —	2/15/79
•COMPUTE LOADS		L	F.9	27		II.34	2.0 —	2/15/79
•COMPUTE PLANT		P	F.17	58		II.34	2.0 —	2/15/79
•COMPUTE SYSTEMS		S	F.14	46		II.34	2.0 —	2/15/79
COMP-TO-TWR-WTR	C-T-T-W	P — PLANT-PARAMETERS		51	4.36	V.22,V.23	2.0 —	2/15/79
CONCHN		S — SUBR-FUNCTIONS		42	1.6		2.1D —	6/30/89

COMMAND or Keyword	Abbrev	Subprogram -- Command	DOE-2 Basics (2.1E)	BDL Summary (2.1E)	Supp (2.1E)	Ref Man (2.1A)	Program version	Year added
COND-FLOW-TYPE		S -- SYSTEM-FLUID		35	3.34,3.84		2.1E --	8/15/93
COND-WTR-FLOW		S -- SYSTEM-FLUID		35	3.34,3.42, 3.84		2.1E --	8/15/93
CONDENSER-TYPE		S -- SYSTEM		36	3.96		2.1E --	8/15/93
CONDUCTIVITY	COND	L -- MATERIAL		11		III.73	2.0--	2/15/79
CONDUCT-SCHEDULE	C-SCH	L -- WINDOW	2.28,F.8	21		III.107	2.0--	2/15/79
CONDUCT-TMIN-SCH	C-T-SCH	L -- WINDOW	2.28,F.8	21	2.62		2.1B--	1/15/83
*CONSTRUCTION	CONS	L	2.2,2.9,F.5	11		III.80	2.0--	2/15/79
CONSTRUCTION	CONS	L -- DOOR	2.31,F.9	23		III.110	2.1--	5/15/80
		L -- EXTERIOR-WALL or ROOF	F.7	19		III.100	2.0--	2/15/79
		L -- INTERIOR-WALL	2.32,F.7	24		III.113	2.0--	2/15/79
		L -- TROMBE-WALL-V or -NV		20			2.1B--	1/15/83
		L -- UNDERGROUND-WALL or -FLOOR	2.33,F.7	25		III.119	2.0--	2/15/79
CONSUMABLES	C	P -- PLANT-EQUIPMENT		48		V.13	2.0--	2/15/79
CONSUMABLES-EXP	C-E	P -- PLANT-COSTS		57			2.1B--	1/15/83
CONSUMABLES-REF	C-R	P -- REFERENCE-COSTS		58		V.94	2.0--	2/15/79
CONVERGENCE-TOL	C-T	L -- GLASS-TYPE		13			2.1E--	8/15/93
COOLING-CAPACITY	C-CAP	S -- SYSTEM-EQUIPMENT		36		IV.241	2.1--	5/15/80
		S -- ZONE		31		IV.201	2.1--	5/15/80
COOLING-EIR	C-EIR	S -- SYSTEM-EQUIPMENT		36	3.25	IV.244	2.1--	5/15/80
COOLING-SCHEDULE	C-SCH	S -- SYSTEM-CONTROL	3.75,F.12	33	3.74,3.123	IV.18,206	2.0--	2/15/79
COOL-CAP-FRPM	C-C-FRPM	S -- SYSTEM-EQUIPMENT		38	3.44,3.50		2.1E --	8/15/93
COOL-CAP-FT	C-C-FT	S -- SYSTEM-EQUIPMENT		37		IV.241,2	2.1--	5/15/80
COOL-CFM-FPLR	C-C-FPLR	S -- SYSTEM-EQUIPMENT		38			2.1E --	8/15/93
COOL-CLOSS-FPLR	C-C-FPLR	S -- SYSTEM-EQUIPMENT		38	3.44,3.50		2.1E --	8/15/93
COOL-CLOSS-MIN	C-C-MIN	S -- SYSTEM-EQUIPMENT		38	3.45,3.50		2.1E --	8/15/93
COOL-CONTROL	C-C	S -- SYSTEM-CONTROL	3.75,F.12	33		IV.207	2.0--	2/15/79
COOL-CTRL-RANGE	C-C-R	S -- SYSTEM-EQUIPMENT		36		IV.248	2.1--	5/15/80
COOL-EIR-FPLR	C-E-FP	S -- SYSTEM-EQUIPMENT		37		IV.242,244	2.1--	5/15/80
COOL-EIR-FRPM	C-E-FRPM	S -- SYSTEM-EQUIPMENT		38	3.46,3.50		2.1E --	8/15/93

COMMAND or Keyword	Abbrev	Subprogram -- Command	DOE-2 Basics (2.1E)	BDL Summary (2.1E)	Supp (2.1E)	Ref Man (2.1A)	Program version	Year added
COOL-EIR-FT	C-E-FT	S -- SYSTEM-EQUIPMENT		37	3.44	IV.242,244	2.1--5/15/80	
COOL-EIR-LS-FT		S -- SYSTEM-EQUIPMENT		37	3.44		2.1E -- 8/15/93	
COOL-ELEC-METER	COOL-EM	S -- PLANT-ASSIGNMENT		45	3.5,3.9		2.1E -- 8/15/93	
		S -- SYSTEM		40	3.5,3.9		2.1E -- 8/15/93	
		S -- ZONE		32	3.5,3.9		2.1E -- 8/15/93	
COOL-FT-MIN	C-FT-MIN	S -- SYSTEM-EQUIPMENT		37		IV.245	2.1--5/15/80	
COOL-FUEL-METER	COOL-FM	S -- PLANT-ASSIGNMENT		45	3.7,3.9		2.1E -- 8/15/93	
		S -- SYSTEM		40	3.7,3.9		2.1E -- 8/15/93	
		S -- ZONE		32	3.7,3.9		2.1E -- 8/15/93	
COOL-MULTIPLIER	C-M	P -- LOAD-MANAGEMENT		57		V.59	2.0--2/15/79	
COOL-PEAK-PERIOD	C-P-P	L -- BUILDING-LOCATION		8		III.32	2.1--5/15/80	
COOL-RESET-SCH	C-R-SCH	S -- SYSTEM-CONTROL	3.76,F.12	33		IV.207	2.0--2/15/79	
COOL-RPM-LIMITS	C-R-LIM	S -- SYSTEM-EQUIPMENT		37	3.44,3.50		2.1E -- 8/15/93	
COOL-SET-SCH	C-S-SCH	S -- SYSTEM-CONTROL	3.76,F.12	33		IV.207	2.0--2/15/79	
COOL-SET-T	C-S-T	S -- SYSTEM-CONTROL		33		IV.207	2.0--2/15/79	
COOL-SH-CAP	C-S-C	S -- SYSTEM-EQUIPMENT		36		IV.245	2.1--5/15/80	
		S -- ZONE		31		IV.201	2.1--5/15/80	
COOL-SH-FT	C-S-FT	S -- SYSTEM-EQUIPMENT		37		IV.242,245	2.1--5/15/80	
COOL-SIZING-RATIO		S -- SYSTEM		39	3.140		2.1E -- 8/15/93	
COOL-STORE-RATE	C-ST-R	P -- ENERGY-STORAGE		57	4.20	V.73	2.0--2/15/79	
COOL-STORE-SCH	C-ST-SCH	P -- ENERGY-STORAGE		57	4.21	V.73	2.0--2/15/79	
COOL-SUPPLY-RATE	C-SU-R	P -- ENERGY-STORAGE		57	4.20	V.73	2.0--2/15/79	
COOL-TEMP-SCH	C-T-SCH	S -- ZONE-CONTROL	3.67,F.10	30	3.65	IV.18,194	2.0--2/15/79	
COOL-WASTE-HEAT	C-W-HEAT	S -- SYSTEM-EQUIPMENT		38	3.46,3.53		2.1E -- 8/15/93	
COOL-WH-FT	C-W-FT	S -- SYSTEM-EQUIPMENT		38	3.46,3.53		2.1E -- 8/15/93	
COOL-WH-FRPM	C-W-FRPM	S -- SYSTEM-EQUIPMENT		38	3.46,3.53		2.1E -- 8/15/93	
CRANKCASE-HEAT	C-H	S -- SYSTEM-EQUIPMENT		36		IV.249	2.1--5/15/80	
CRANKCASE-MAX-T	C-M-T	S -- SYSTEM-EQUIPMENT		36		IV.249	2.1A--5/15/81	
CTANK-BASE-T	C-B-T	P -- ENERGY-STORAGE		57	4.21	V.74	2.0--2/15/79	
CTANK-ENV-T	C-E-T	P -- ENERGY-STORAGE		57	4.21	V.76	2.0--2/15/79	

•COMMAND or Keyword	Abbrev	Subprogram — Command	DOE-2 Basics (2.1E)	BDL Summary (2.1E)	Supp (2.1E)	Ref Man (2.1A)	Program version	Year added
CTANK-ENV-T-SCH		P — ENERGY-STORAGE		57	4.21		2.1E —	8/15/79
CTANK-FREEZ-T	C-F-T	P — ENERGY-STORAGE		57		V.76	2.0—	2/15/79
CTANK-LOSS-COEF	C-L-C	P — ENERGY-STORAGE		57	4.21	V.74	2.0—	2/15/79
CTANK-T-RANGE	C-T-R	P — ENERGY-STORAGE		57	4.21	V.74	2.0—	2/15/79
•CURVE-FIT	C-F	SP		28,47		IV.180	2.1A—	5/15/81
<hr/>								
DATA		SP — CURVE-FIT		29		IV.182	2.1—	5/15/80
•DAY-ASSIGN-SCH	D-A-SCH	P		47		V.97	2.0—	2/15/79
•DAY-RESET-SCH	D-R-SCH	S	3.63,3.64 F.10	29		IV.176	2.0—	2/15/79
•DAY-SCHEDULE	D-SCH	LSP	2.2,3.63, 3.64,F.4,F.10	9,28, 47,59	1.36	II.23,V.8	2.0—	2/15/79
DAYCLS-1		S — SUBR-FUNCTIONS		42	1.6		2.1D—	6/30/89
DAYCLS-2		S — SUBR-FUNCTIONS		42	1.6		2.1D—	6/30/89
DAYCLS-3		S — SUBR-FUNCTIONS		42	1.6		2.1D—	6/30/89
DAYCLS-4		S — SUBR-FUNCTIONS		42	1.6		2.1D—	6/30/89
DAYCLS-5		S — SUBR-FUNCTIONS		42	1.6		2.1D—	6/30/89
DAYCLS-6		S — SUBR-FUNCTIONS		42	1.6		2.1D—	6/30/89
DAYLIGHTING	DAY	L — SPACE-CONDITIONS		17	2.53		2.1B—	1/15/83
DAYLIGHT-REP-SCH	D-R-SCH	L — SPACE-CONDITIONS		17	2.57		2.1B—	1/15/83
DAYLIGHT-SAVINGS	D-S	L — BUILDING-LOCATION	2.4,F.3	8		III.31	2.0—	2/15/79
DAYL-FUNCTION		L — BUILDING-LOCATION		8	1.5		2.1C—	5/15/84
DAYL-ILLUM-FN		L — SPACE		18	1.5		2.1C—	5/15/84
DAYL-LTCTRL-FN		L — SPACE		18	1.5		2.1C—	5/15/84
DAYS		LSPE — WEEK-SCHEDULE					2.0—	2/15/79
DBUN-CAP-COR-REC		P — PLANT-PARAMETERS		51		V.23,27,43	2.1—	5/15/80
DBUN-CAP-FT		P — EQUIPMENT-QUAD		55	4.82	V.42,3	2.1—	5/15/80
DBUN-CAP-FTRISE		P — EQUIPMENT-QUAD		55	4.82	V.42	2.1—	5/15/80
DBUN-COND-T-ENT		P — PLANT-PARAMETERS		51		V.23,27	2.1—	5/15/80

•COMMAND or Keyword	Abbrev	Subprogram -- Command	DOE-2 Basics (2.1E)	BDL Summary (2.1E)	Supp (2.1E)	Ref Man (2.1A)	Program version	Year added
DBUN-COND-T-REC		P -- PLANT-PARAMETERS	4.12.F.16	51		V.23,V.27	2.1--	5/15/80
DBUN-EIR-COR-REC		P -- PLANT-PARAMETERS		51		V.23,27	2.1--	5/15/80
DBUN-EIR-FPLR		P -- EQUIPMENT-QUAD		55	4.82	V.42,43	2.1--	5/15/80
DBUN-EIR-FT		P -- EQUIPMENT-QUAD		55	4.82	V.42,43	2.1--	5/15/80
DBUN-EIR-FTRISE		P -- EQUIPMENT-QUAD		55	4.82	V.42,43	2.1--	5/15/80
DBUN-HT-REC-RAT		P -- PLANT-PARAMETERS		51		V.23,V.27	2.1--	5/15/80
DBUN-MIN-HEAT		P -- PLANT-PARAMETERS		51	4.7		2.1C--	5/15/84
		P -- HEAT-RECOVERY		56	4.48		2.1E--	8/15/93
		P -- LOAD-ASSIGNMENT		56	4.48		2.1E--	8/15/93
DBUN-TO-TWR-WTR	D-T-T-W	P -- PLANT-PARAMETERS		51		V.22,V.23	2.0--	2/15/79
DBUN-UNL-RAT-DES		P -- PLANT-PARAMETERS		51		V.23,V.28	2.1--	5/15/80
DBUN-UNL-RAT-REC		P -- PLANT-PARAMETERS		51		V.23,V.28	2.1--	5/15/80
DC-MAX-CHILL-WTR-T		P -- PLANT-PARAMETERS		53	4.42		2.1E --	8/15/93
DC-MAX-OAT		P -- PLANT-PARAMETERS		53	4.42		2.1E --	8/15/93
DC-TWR-WTR-SETPT		P -- PLANT-PARAMETERS		53	4.42		2.1E --	8/15/93
DDSF-0		S -- SUBR-FUNCTIONS		42	1.6		2.1D--	6/30/89
DDSF-1		S -- SUBR-FUNCTIONS		42	1.6		2.1D--	6/30/89
DEFROST-CTRL	D-CTRL	S -- SYSTEM-EQUIPMENT		36	3.25,3.26		2.1E --	8/15/93
DEFROST-FRAC-FT	D-F-FT	S -- SYSTEM-EQUIPMENT		36	3.46,3.51		2.1E --	8/15/93
DEFROST-T	D-T	S -- SYSTEM-EQUIPMENT		36	3.25,3.26	IV.251	2.1--	5/15/80
DEFROST-TYPE	D-TYPE	S -- SYSTEM-EQUIPMENT		36	3.25,3.26		2.1E --	8/15/93
DELAY-CHARGE-HR		P -- PLANT-PARAMETERS		52	4.19		2.1E --	8/15/93
DEMAND-1	D-1	P -- HEAT-RECOVERY	4.15.F.17	56		V.66	2.0--	2/15/79
DEMAND-2	D-2	P -- HEAT-RECOVERY	4.15.F.17	56		V.66	2.0--	2/15/79
DEMAND-5	D-5	P -- HEAT-RECOVERY	4.15.F.17	56		V.66	2.0--	2/15/79
DEMAND-CHGS	D-CHG	E -- UTILITY-RATE	5.3.F.18	60	5.7		2.1E --	8/15/93
DEMAND-QUALS	D-Q	E -- UTILITY-RATE		60	5.9		2.1E --	8/15/93
DEMAND-RATCHETS	D-R	E -- BLOCK-CHARGE		59	5.18		2.1E --	8/15/93
		E -- UTILITY-RATE		60	5.8		2.1E --	8/15/93
DEMAND-WINDOW	D-WIN	E -- UTILITY-RATE		60	5.11		2.1E --	8/15/93

•COMMAND or Keyword	Abbrev	Subprogram — Command	DOE-2 Basics (2.1E)	BDL Summary (2.1E)	Supp (2.1E)	Ref Man (2.1A)	Program version	Year added
DEM-UNIT-NAME		P — ENERGY-RESOURCE		58	4.6,4.7		2.1E —	8/15/93
DENSITY	DENS	L — MATERIAL		11		III.73	2.0A—	6/15/79
DEPTH	D	L — MATERIAL		11			2.0—	2/15/79
		L — SPACE		18		III.97	2.0—	2/15/79
DESC-CTRL-MODE		S — SYSTEM		39	3.78		2.1E —	8/15/93
DESC-DEW-SET		S — SYSTEM		39	3.78		2.1E —	8/15/93
DESC-GAS-FTW		S — SYSTEM-EQUIPMENT		37			2.1E —	8/15/93
DESC-KW-FTW		S — SYSTEM-EQUIPMENT		37			2.1E —	8/15/93
DESC-T-FTW		S — SYSTEM-EQUIPMENT		37			2.1E —	8/15/93
DESC-W-FTW		S — SYSTEM-EQUIPMENT		37			2.1E —	8/15/93
DESFO-0		S — SUBR-FUNCTIONS		42	1.6		2.1D—	6/30/89
DESFO-1		S — SUBR-FUNCTIONS		42	1.6		2.1D—	6/30/89
DESICCANT	DESIC	S — SYSTEM		39	3.76		2.1E —	8/15/93
DESICCANT-AIR	DESC-A	S — SYSTEM		39	3.76		2.1E —	8/15/93
DESICCANT-XEFF		P — PLANT-PARAMETERS		51	4.9		2.1E —	8/15/93
DESIGN		S — SUBR-FUNCTIONS		42	1.6		2.1D—	6/30/89
DESIGN-COOL-T	D-C-T	S — ZONE-CONTROL	3.67,F.10	29	3.65	IV.18,194	2.0—	2/15/79
•DESIGN-DAY	D-D	L		9		III.25	2.0—	2/15/79
DESIGN-HEAT-T	D-H-T	S — ZONE-CONTROL	3.67,F.10	29	3.65	IV.18,193	2.0—	2/15/79
DESIND-0		S — SUBR-FUNCTIONS		42	1.6		2.1D—	6/30/89
DESIND-1		S — SUBR-FUNCTIONS		42	1.6		2.1D—	6/30/89
DESPIU-0		S — SUBR-FUNCTIONS		42	1.6		2.1D—	6/30/89
DESPIU-1		S — SUBR-FUNCTIONS		42	1.6		2.1D—	6/30/89
DEWPT-HI	DP-H	L — DESIGN-DAY		9		III.27	2.0—	2/15/79
DEWPT-LO	DP-L	L — DESIGN-DAY		9		III.27	2.0—	2/15/79
DHOUR-HI	DH-H	L — DESIGN-DAY		9		III.27	2.0—	2/15/79
DHOUR-LO	DH-L	L — DESIGN-DAY		9		III.27	2.0—	2/15/79
DHW-EIR		S — PLANT-ASSIGNMENT		44	3.58,3.61		2.1E —	8/15/93
DHW-EIR-FPLR		S — PLANT-ASSIGNMENT		44	3.58,3.61		2.1E —	8/15/93



•COMMAND or Keyword	Abbrev	Subprogram — Command	DOE-2 Basics (2.1E)	BDL Summary (2.1E)	Supp (2.1E)	Ref Man (2.1A)	Program version	Year added
DHW-EIR-FT		S — PLANT-ASSIGNMENT		44	3.58,3.61		2.1E —	8/15/93
DHW-ELEC-METER	DHW-EM	S — PLANT-ASSIGNMENT		45	3.6,3.10		2.1E —	8/15/93
		S — SYSTEM		40	3.6,3.10		2.1E —	8/15/93
		S — ZONE		32	3.6,3.10		2.1E —	8/15/93
DHW-FLOW		S — PLANT-ASSIGNMENT		45	3.57,3.61		2.1E —	8/15/93
DHW-FUEL-METER	DHW-FM	S — PLANT-ASSIGNMENT		45	3.7,3.10		2.1E —	8/15/93
		S — SYSTEM		40	3.7,3.10		2.1E —	8/15/93
		S — ZONE		32	3.7,3.10		2.1E —	8/15/93
DHW-GAL/MIN		S — PLANT-ASSIGNMENT	3.92,F.13	45	3.57,3.61		2.1E —	8/15/93
DHW-HEAT-RATE		S — PLANT-ASSIGNMENT		44	3.57,3.61		2.1E —	8/15/93
DHW-HEAT-RATE-FT		S — PLANT-ASSIGNMENT		44	3.58,3.61		2.1E —	8/15/93
DHW-HIR		P — PLANT-PARAMETERS	4.13,F.16	52		V.24,V.30, V.31	2.1—	5/15/80
DHW-HIR-FPLR		P — EQUIPMENT-QUAD		55	4.82	V.44,45	2.1—	5/15/80
DHW-HSTOR-RATE		S — PLANT-ASSIGNMENT		44	3.59,3.61		2.1E —	8/15/93
DHW-HSUP-RATE		S — PLANT-ASSIGNMENT		44	3.59,3.61		2.1E —	8/15/93
DHW-INLET-T-SCH		S — PLANT-ASSIGNMENT	3.93,F.13	45	3.57,3.61		2.1E —	8/15/93
DHW-LOSS		S — PLANT-ASSIGNMENT		44	3.58,3.61		2.1E —	8/15/93
DHW-PUMP-ELEC		S — PLANT-ASSIGNMENT		44	3.58,3.61		2.1E —	8/15/93
DHW-PUMP-SCH		S — PLANT-ASSIGNMENT		44	3.59,3.61		2.1E —	8/15/93
DHW-SCH		S — PLANT-ASSIGNMENT	3.93,F.13	45	3.57		2.1E —	8/15/93
DHW-SIZE		S — PLANT-ASSIGNMENT		44	3.57,3.61		2.1E —	8/15/93
DHW-SUPPLY-T		S — PLANT-ASSIGNMENT	3.93,F.13	45	3.57,3.61		2.1E —	8/15/93
DHW-TYPE		S — PLANT-ASSIGNMENT		44	3.57,3.61		2.1E —	8/15/93
•DIAGNOSTIC		LSPE	F.3	7,28, 47,59		II.16	2.0—	2/15/79
DIESEL-EXH-EFF		P — PLANT-PARAMETERS		54			2.1C—	5/15/84
DIESEL-EXH-FPLR		P — EQUIPMENT-QUAD		55	4.83	V.46	2.1C—	5/15/84
DIESEL-FUEL	D-F	P — EQUIPMENT-QUAD					2.0A—	6/15/79
DIESEL-GEN-EFF		P — PLANT-PARAMETERS		54			2.1C—	5/15/84

•COMMAND or Keyword	Abbrev	Subprogram -- Command	DOE-2 Basics (2.1E)	BDL Summary (2.1E)	Supp (2.1E)	Ref Man (2.1A)	Program version	Year added
DIESEL-IO-FPLR		P -- EQUIPMENT-QUAD		55	4.83	V.46	2.1	5/15/80
DIESEL-JL-EFF		P -- PLANT-PARAMETERS		54			2.1C	5/15/84
DIESEL-JAC-FPLR		P -- EQUIPMENT-QUAD		56	4.83		2.1E	8/15/93
DIESEL-JCLB-FPLR		P -- EQUIPMENT-QUAD		55			2.1C	5/15/84
DIESEL-LUB-FPLR		P -- EQUIPMENT-QUAD		56	4.83		2.1E	8/15/93
DIESEL-STACK-FU		P -- EQUIPMENT-QUAD		56	4.83		2.1E	8/15/93
DIESEL-TEX-FPLR		P -- EQUIPMENT-QUAD		55	4.83	V.46	2.1	5/15/80
DIESEL-TRACK-MODE		P -- PLANT-PARAMETERS		54	4.47		2.1C	5/15/84
DIRECT-COOL-KW		P -- HEAT-RECOVERY		56	4.48		2.1E	8/15/93
DIRECT-COOL-MODE		P -- LOAD-ASSIGNMENT		56	4.48		2.1E	8/15/93
DIRECT-COOL-SCH		P -- PLANT-PARAMETERS		53	4.42		2.1E	8/15/93
DIRECT-EFF		P -- PLANT-PARAMETERS		53	4.42		2.1E	8/15/93
DIRECT-EFF-FCFM		S -- SYSTEM-EQUIPMENT		36	3.64,3.67, 3.70		2.1E	8/15/93
DISCOUNT-RATE	D-R	S -- SYSTEM-EQUIPMENT		37	3.68		2.1E	8/15/93
DIVIDE		P -- PLANT-COSTS		57		V.91	2.0	2/15/79
DKTEMP-0		LS -- HOURLY-REPORT		26		III.128	2.0A	6/15/79
DKTEMP-1		S -- SUBR-FUNCTIONS		42	1.6		2.1D	6/30/89
DKTEMP-2		S -- SUBR-FUNCTIONS		42	1.6		2.1D	6/30/89
DKTEMP-3		S -- SUBR-FUNCTIONS		42	1.6		2.1D	6/30/89
DOETRM-0		S -- SUBR-FUNCTIONS		42	1.6		2.1D	6/30/89
DOETRM-1		S -- SUBR-FUNCTIONS		42	1.6		2.1D	6/30/89
•DOOR		L	2.2.2.31 F.9	24	2.77	III.69, III.110	2.1	5/15/80
DOORWAY-H	D-H	L -- WALL-PARAMETERS		15	2.13		2.1C	5/15/84
DOORWAY-W	D-W	L -- WALL-PARAMETERS		15	2.13		2.1C	5/15/84
DOUBLE-0		S -- SUBR-FUNCTIONS		42	1.6		2.1D	6/30/89
DOUBLE-1		S -- SUBR-FUNCTIONS		42	1.6		2.1D	6/30/89

•COMMAND or Keyword	Abbrev	Subprogram -- Command	DOE-2 Basics (2.1E)	BDL Summary (2.1E)	Supp (2.1E)	Ref Man (2.1A)	Program version	Year added
DRYBULB-HI	DB-H	L -- DESIGN-DAY		9		III.26	2.0--2/15/79	
DRYBULB-LIMIT		S -- SYSTEM-CONTROL		33	3.33,3.99		2.1E -- 8/15/93	
DRYBULB-LO	DB-L	L -- DESIGN-DAY		9		III.26	2.0--2/15/79	
DUCT-AIR-LOSS	D-A-L	S -- SYSTEM-AIR		33		IV.217	2.1--5/15/80	
DUCT-DELTA-T	D-D-T	S -- SYSTEM-AIR		33		IV.217	2.1--5/15/80	
<hr/>								
EBAL-0		S -- SUBR-FUNCTIONS		42	1.6		2.1D--6/30/89	
EBAL-1		S -- SUBR-FUNCTIONS		42	1.6		2.1D--6/30/89	
ECONO-1		S -- SUBR-FUNCTIONS		42	1.6		2.1D--6/30/89	
ECONO-2		S -- SUBR-FUNCTIONS		42	1.6		2.1D--6/30/89	
ECONO-3		S -- SUBR-FUNCTIONS		42	1.6		2.1D--6/30/89	
ECONO-4		S -- SUBR-FUNCTIONS		42	1.6		2.1D--6/30/89	
ECONO-LIMIT-T	E-L-T	S -- SYSTEM-CONTROL	3.78,F.12	33	3.33	IV.210	2.0--2/15/79	
ECONO-LOCKOUT		S -- SYSTEM-CONTROL		33	3.100		2.1E -- 8/15/93	
ECONO-LOW-LIMIT	E-L-L	S -- SYSTEM-CONTROL		33	3.33,3.100, 3.118		2.1B--1/15/83	
•ECONOMICS-REPORT	E-R	E	5.19,F.18	61		VI.12	2.0--2/15/79	
ELEC-DHW-LOSS		P -- PLANT-PARAMETERS		52		V.24,V.31	2.1--5/15/80	
ELEC-INPUT-RATIO	E-I-R	P -- PART-LOAD-RATIO	4.9,F.15	50	4.10,4.13, 4.38	V.18,20	2.0--2/15/79	
ELEC-METER		P -- PLANT-EQUIPMENT		48	3.6,4.3		2.1E -- 8/15/93	
ELEC-MULTIPLIER	E-M	S -- SYSTEM		40	3.6		2.1E -- 8/15/93	
EMISSIVITY	EM	P -- LOAD-MANAGEMENT		57		V.59	2.0--2/15/79	
•END		L -- WALL-PARAMETERS		15	2.71		2.1B--1/15/83	
		LSPE		26,46, 60,61		II.33	2.0--2/15/79	
•END-FUNCTION		LS	F.9,F.14, F.17,F.19	26,46, 60,61	1.10		2.1C--5/15/84	
ENERGY-CHG	E-CHG	E -- UTILITY-RATE	5.3,F.18	60	5.7		2.1E -- 8/15/93	
ENERGY-CHG-SCH	E-SCH	E -- UTILITY-RATE	5.3,F.18	60	5.7		2.1E -- 8/15/93	
ENERGY-COST	E-C	E -- BASELINE		61		VI.11	2.0--2/15/79	

•COMMAND or Keyword	Abbrev	Subprogram -- Command	DOE-2 Basics (2.1E)	BDL Summary (2.1E)	Supp (2.1E)	Ref Man (2.1A)	Program version	Year added
ENERGY-COST-ADIS	E-C-A	E -- UTILITY-RATE		60	5.11		2.1E --	8/15/93
ENERGY-QUALS	E-Q	E -- UTILITY-RATE		60	5.9		2.1E --	8/15/93
•ENERGY-RESOURCE	E-R	P	4.7,4.16 F.17	58			2.1C--	5/15/84
ENERGY-UNIT		P -- ENERGY-RESOURCE		58	4.6		2.1E --	8/15/93
ENERGY-USE-SITE	E-U-SITE	E -- BASELINE		61		VI.11	2.0--	2/15/79
ENERGY-USE-SRC	E-U-SRC	E -- BASELINE		61		VI.11	2.0--	2/15/79
•ENERGY-STORAGE	E-S	P		57		V.8,73	2.0--	2/15/79
ENG-CH-CAP-FT		P -- EQUIPMENT-QUAD		55	4.12,4.13		2.1D--	6/30/89
ENG-CH-COND-TYPE		P -- PLANT-PARAMETERS	4.11,F.16	51	4.13		2.1D--	6/30/89
ENG-CH-COP		P -- PLANT-PARAMETERS	4.11,F.16	51	4.13		2.1D--	6/30/89
ENG-CH-COP-FPLR1		P -- EQUIPMENT-QUAD		55	4.11,4.13, 4.82		2.1D--	6/30/89
ENG-CH-COP-FPLR2		P -- EQUIPMENT-QUAD		55	4.11,4.13, 4.82		2.1D--	6/30/89
ENG-CH-COP-FPLRS		P -- EQUIPMENT-QUAD		55	4.11,4.13, 4.82		2.1D--	6/30/89
ENG-CH-COP-FT		P -- EQUIPMENT-QUAD		55	4.11,4.13, 4.82		2.1D--	6/30/89
ENG-CH-COP-FTS		P -- EQUIPMENT-QUAD		55	4.11,4.13, 4.82		2.1D--	6/30/89
ENG-CH-HREJ-FPLR		P -- EQUIPMENT-QUAD		55	4.12,4.13, 4.82		2.1D--	6/30/89
ENG-CH-HREJ-FT		P -- EQUIPMENT-QUAD		55	4.12,4.13, 4.82		2.1D--	6/30/89
ENG-CH-IDLE-RAT		P -- PLANT-PARAMETERS		51	4.13		2.1D--	6/30/89
ENG-CH-REC-EFF		P -- PLANT-PARAMETERS		51	4.13		2.1D--	6/30/89
ENTHALPY-LIMIT		S -- SYSTEM-CONTROL		33	3.33,3.99		2.1E --	8/15/93
EQUIP-ELEC-METER	EQUIP-EM	S -- PLANT-ASSIGNMENT		44	3.5,3.10		2.1E --	8/15/93
		S -- SYSTEM		40	3.5,3.10		2.1E --	8/15/93
		S -- ZONE		32	3.5,3.10		2.1E --	8/15/93

•COMMAND or Keyword	Abbrev	Subprogram -- Command	DOE-2 Basics (2.1E)	BDL Summary (2.1E)	Supp (2.1E)	Ref Man (2.1A)	Program version	Year added
EQUIPMENT-KW	E-KW	L -- SPACE-CONDITIONS	2.19,F.6	16		III.46	2.0--2/15/79	
EQUIPMENT-LIFE	E-L	P -- PLANT-EQUIPMENT		48		V.14	2.0--2/15/79	
•EQUIPMENT-QUAD	E-Q	P		55		V.8,38	2.1--5/15/80	
EQUIPMENT-W/SQFT	E-W	L -- SPACE-CONDITIONS	2.19,F.6	16		III.47	2.0--2/15/79	
EQUIP-LATENT	E-L	L -- SPACE-CONDITIONS	2.20,F.6	16		III.47	2.0--2/15/79	
EQUIP-SCHEDULE	E-SCH	L -- SPACE-CONDITIONS	2.19,F.6	16		III.46	2.0--2/15/79	
EQUIP-SENSIBLE	E-S	L -- SPACE-CONDITIONS	2.20,F.6	16		III.47	2.0--2/15/79	
ESCALATION	ESC	E -- UTILITY-RATE		60	5.2		2.0--2/15/79	
EVAP-CL-AIR		S -- SYSTEM-EQUIPMENT		36	3.67		2.1E -- 8/15/93	
EVAP-CL-KW		S -- SYSTEM-EQUIPMENT		36	3.64,3.66, 3.70		2.1E -- 8/15/93	
EVAP-CL-LIMIT-T		S -- SYSTEM-EQUIPMENT		36	3.67		2.1E -- 8/15/93	
EVAP-CL+M-SUP		S -- SYSTEM-EQUIPMENT		36	3.66		2.1E -- 8/15/93	
EVAP-CL+REC-RA		S -- SYSTEM-EQUIPMENT		36	3.64,3.66,		2.1E -- 8/15/93	
EVAP-CL-TYPE		S -- SYSTEM-EQUIPMENT		36	3.64,3.66,		2.1E -- 8/15/93	
EVAP-DELTA-T		P -- PLANT-PARAMETERS		52	4.18		2.1E -- 8/15/93	
EVAP-PCC-EFF	E-P-EFF	S -- SYSTEM		39	3.96		2.1E -- 8/15/93	
EVAP-PCC-ELEC	E-P-ELEC	S -- SYSTEM		39	3.97		2.1E -- 8/15/93	
EVAP-PCC-SCH	E-P-SCH	S -- SYSTEM		39	3.96		2.1E -- 8/15/93	
EXCESS-KVAR-FRAC	E-K-F	E -- UTILITY-RATE		60	5.12		2.1E -- 8/15/93	
EXCESS-KVAR-CHG	E-K-CHG	E -- UTILITY-RATE		60	5.12		2.1E -- 8/15/93	
EXHAUST-CFM	E-CFM	S -- ZONE-AIR	3.70,F.11	30		IV.190	2.0--2/15/79	
EXHAUST-EFF	E-E	S -- ZONE-AIR	3.70,F.11	30		IV.190	2.0--2/15/79	
EXHAUST-KW	E-KW	S -- ZONE-AIR	3.70,F.11	30		IV.191	2.1--5/15/80	
EXHAUST-STATIC	E-S	S -- ZONE-AIR	3.70,F.11	30		IV.190	2.0--2/15/79	
EXT-ELEC-KW		S -- PLANT-ASSIGNMENT	3.92,F.13	45	3.14		2.1E -- 8/15/93	
EXT-ELEC-METER	E-E-M	S -- PLANT-ASSIGNMENT		45	3.6,3.14		2.1E -- 8/15/93	
EXT-ELEC-SCH		S -- PLANT-ASSIGNMENT	3.92,F.13	45	3.14		2.1E -- 8/15/93	
EXT-FUEL-BTU/HR		S -- PLANT-ASSIGNMENT	3.92,F.13	45	3.7,3.13		2.1E -- 8/15/93	

COMMAND or Keyword	Abbrev	Subprogram - Command	DOE-2 Basics (2.1E)	BDL Summary (2.1E)	Supp (2.1E)	Ref Man (2.1A)	Program version	Year added
EXT-FUEL-METER	E-F-M	S - PLANT-ASSIGNMENT		45	3.13		2.1E -	8/15/93
EXT-FUEL-POWER		S - PLANT-ASSIGNMENT		45	3.13		2.1E -	8/15/93
EXT-FUEL-SCH		S - PLANT-ASSIGNMENT	3.92,F.13	45	3.13		2.1E -	8/15/93
EXT-LIGHT-KW		S - PLANT-ASSIGNMENT		45	3.5,3.14		2.1E -	8/15/93
EXT-LIGHT-METER	E-L-M	S - PLANT-ASSIGNMENT		45	3.14		2.1E -	8/15/93
EXT-LIGHT-SCH		S - PLANT-ASSIGNMENT		45	3.14		2.1E -	8/15/93
EXTERIOR-WALL or -ROOF	E-W	L	2.2,2.25 F.7	19	2.79	III.100	2.0 -	2/15/79
E-HW-BOILER-LOSS		P - PLANT-PARAMETERS		52		V.24	2.1 -	5/15/80
E-STM-BOILER-LOSS		P - PLANT-PARAMETERS		52		V.24	2.1 -	5/15/80
FANPWR		S - SUBR-FUNCTIONS		42	1.6		2.1D -	6/30/89
FAN-CONTROL	F-C	S - SYSTEM-FANS	3.84,F.12	34	3.25,3.74	IV.18,221	2.0 -	2/15/79
FAN-EIR-FPLR	F-E-FPLR	S - SYSTEM-FANS		34		IV.228	2.1 -	5/15/80
FAN-KW	F-KW	L - WALL-PARAMETERS		15	2.13		2.1B -	1/15/83
FAN-PLACEMENT	F-P	S - SYSTEM-FANS		34		IV.226	2.0 -	2/15/79
FAN-SCHEDULE	F-SCH	S - SYSTEM-FANS	3.84,F.12	34	3.74,3.102	IV.221	2.0 -	2/15/79
FCOIL-0		S - SUBR-FUNCTIONS		42	1.6		2.1D -	6/30/89
FCOIL-1Z		S - SUBR-FUNCTIONS		42	1.6		2.1D -	6/30/89
FCOIL-2Z		S - SUBR-FUNCTIONS		42	1.6		2.1D -	6/30/89
FCOIL-3		S - SUBR-FUNCTIONS		42	1.6		2.1D -	6/30/89
FIRST-COST	F-C	E - BASELINE		61		VI.9,11	2.0 -	2/15/79
		E - COMPONENT-COST		61		VI.6	2.0 -	2/15/79
FIRST-COST-EXP	F-C-E	P - PLANT-EQUIPMENT		48		V.13	2.0 -	2/15/79
FIRST-COST-REF	F-C-R	P - PLANT-COSTS		57			2.1B -	1/15/83
FIXED-SHADE	F-S	P - REFERENCE-COSTS		58		V.94	2.0 -	2/15/79
FLOOR-MULTIPLIER	F-M	L	2.24,F.7	14	2.74,2.79		2.1C -	5/15/84
		L - SPACE		18	2.89		2.1B -	1/15/83
		S - ZONE		31			2.1B -	1/15/83
FLOOR-WEIGHT	F-W	L - SPACE-CONDITIONS	2.23,F.6	16		III.51	2.0 -	2/15/79

•COMMAND or Keyword	Abbrev	Subprogram -- Command	DOE-2 Basics (2.1E)	BDL Summary (2.1E)	Supp (2.1E)	Ref Man (2.1A)	Program version	Year added
FLUID-HEAT-CAP	F-H-C	S -- SYSTEM-FLUID		35		IV.235	2.0--2/15/79	
FLUID-VOLUME		S -- PLANT-ASSIGNMENT		44	3.42		2.1E -- 8/15/93	
		S -- SYSTEM-FLUID		35	3.34,3.84		2.1E -- 8/15/93	
FNSYS1-1		S -- SUBR-FUNCTIONS		42	1.6		2.1D--6/30/89	
FNSYS1-2Z		S -- SUBR-FUNCTIONS		42	1.6		2.1D--6/30/89	
FNSYS1-3Z		S -- SUBR-FUNCTIONS		42	1.6		2.1D--6/30/89	
FNSYS1-4Z		S -- SUBR-FUNCTIONS		42	1.6		2.1D--6/30/89	
FNSYS1-5		S -- SUBR-FUNCTIONS		42	1.6		2.1D--6/30/89	
FOR		L -- SET-DEFAULT		9			2.0--2.15.79	
		L -- WALL-PARAMETERS		15	2.10,2.71		2.1B--1/15/83	
FRAC-LEAK-AREA	F-L-A	L -- SPACE-CONDITIONS		17	2.86		2.1B--1/15/83	
FRAC-VENT-AREA	F-V-A	S -- SYSTEM-AIR		33	3.33,3.34 3.122-25		2.1D--6/30/89	
FRACTION		E -- RATCHET		60	5.28		2.1E -- 8/15/93	
FRAME-ABS	F-ABS	L -- GLASS-TYPE		13	2.116		2.1E -- 8/15/93	
FRAME-CONDUCTANC	F-C	L -- GLASS-TYPE		13	2.116		2.1E -- 8/15/93	
FRAME-WIDTH	FR-W	L -- WINDOW		21	2.115		2.1E -- 8/15/93	
FIDEV		S -- SUBR-FUNCTIONS		42	1.6		2.1D--6/30/89	
FUEL-METER		P -- ENERGY-RESOURCE		58	4.5		2.1E -- 8/15/93	
		P -- PLANT-EQUIPMENT		48	4.3		2.1E -- 8/15/93	
		S -- SYSTEM		40	3.7		2.1E -- 8/15/93	
•FUNCTION		LS		26,46	1.4		2.1D--6/30/89	
FUNCTION		L -- BUILDING-LOCATON		8	1.5		2.1C--5/15/84	
		L -- DOOR		23	1.5		2.1C--5/15/84	
		L -- EXTERIOR-WALL or ROOF		19	1.5		2.1C--5/15/84	
		S -- PLANT-ASSIGNMENT		43	1.5		2.1D--6/30/89	
		L -- SPACE		18	1.5		2.1C--5/15/84	
		S -- SYSTEM		39	1.5		2.1D--6/30/89	
		L -- UNDERGROUND-WALL or -FLOOR		26	1.5		2.1C--5/15/84	
		L -- WINDOW		21	1.5		2.1C--5/15/84	
		S -- ZONE		31	1.5		2.1D--6/30/89	
FURNAC		S -- SUBR-FUNCTIONS		42	1.6		2.1D--6/30/89	

•COMMAND or Keyword	Abbrev	Subprogram -- Command	DOE-2 Basics (2.1E)	BDL Summary (2.1E)	Supp (2.1E)	Ref Man (2.1A)	Program version	Year added
FURNACE-AUX	F-A	P -- PLANT-PARAMETERS		52		V.24,V.31	2.1-	5/15/80
FURNACE-AUX-KW	F-A-KW	S -- SYSTEM-EQUIPMENT		36		IV.252	2.1-	5/15/80
FURNACE-HIR	F-HIR	S -- SYSTEM-EQUIPMENT		36	3.56	V.24,V.31	2.1E --	8/15/93
FURNACE-HIR-FPLR	F-H-FP	P -- PLANT-PARAMETERS		52		IV.252	2.1-	5/15/80
FURNITURE-TYPE	F-TYPE	S -- SYSTEM-EQUIPMENT		36		V.44,45	2.1-	5/15/80
FURN-FRACTION	F-F	P -- EQUIPMENT-QUAD		55	4.82	III.53	2.1-	5/15/80
FURN-WEIGHT	F-WGT	L -- SPACE-CONDITIONS		16		III.53	2.1-	5/15/80
		L -- SPACE-CONDITIONS		16		III.53	2.1-	5/15/80
GLARE-CTRL-PROB	G-C-P	L -- WINDOW		21	2.62		2.1B-	1/15/83
GLASS-CONDUCTANCE	G-C	L -- GLASS-TYPE	2.13,F.3	13		III.88	2.0-	2/15/79
•GLASS-TYPE	G-T	L	2.2,2.13,F.3	13	2.113,2.116	III.87	2.0-	2/15/79
GLASS-TYPE	G-T	L -- WINDOW	2.27,F.8	21	2.119	III.107	2.0-	2/15/79
GLASS-TYPE-CODE	G-T-C	L -- GLASS-TYPE		13		III.87	2.0-	2/15/79
GLASS-TYPE-SW		L -- WINDOW		22	2.119		2.1E --	8/15/93
GND-FORM-FACTOR	G-F-F	L -- DOOR		23		III.110	2.1-	5/15/80
		L -- EXTERIOR WALL or ROOF		19		III.100	2.0-	2/15/79
		L -- TROMBE-WALL-V or -NV		21			2.1B-	1/15/83
		L -- WINDOW		21		III.107	2.0-	2/15/79
GND-REFLECTANCE	G-R	L -- EXTERIOR WALL or ROOF	2.25,F.7	19		III.100	2.0-	2/15/79
		L -- TROMBE-WALL-V or -NV		21			2.1B-	1/15/83
GROSS-AREA	G-A	L -- BUILDING-LOCATION	2.6,F.3	8		III.32	2.0-	2/15/79
GROUND-T	G-T	L -- BUILDING-LOCATION	2.6,F.3	8		III.32	2.0-	2/15/79
		L -- DESIGN-DAY		9		III.27	2.0-	2/15/79
GTURB-CAP-FT		P -- EQUIPMENT-QUAD		55	4.10		2.1C-	5/15/84
GTURB-EXH-EFF		P -- PLANT-PARAMETERS		54	4.8		2.1C-	5/15/84
GTURB-EXH-FPLR		P -- EQUIPMENT-QUAD		55	4.10		2.1C-	5/15/84
GTURB-EXH-FTO	U-N	P -- EQUIPMENT-QUAD		56	4.83		2.1E --	8/15/93
GTURB-GEN-EFF		P -- PLANT-PARAMETERS		54	4.8		2.1C-	5/15/84



•COMMAND or Keyword	Abbrev	Subprogram -- Command	DOE-2 Basics (2.1E)	BDL Summary (2.1E)	Supp (2.1E)	Ref Man (2.1A)	Program version	Year added
GTURB-I/O-FPLR		P -- EQUIPMENT-QUAD		55	4.83	V.44,46	2.1-5/15/80	
GTURB-I/O-FTO	U-N	P -- EQUIPMENT-QUAD		56	4.83		2.1E -- 8/15/93	
GTURB-STACK-FU	U-N	P -- EQUIPMENT-QUAD		56	4.83		2.1E -- 8/15/93	
GTURB-TEX-FPLR		P -- EQUIPMENT-QUAD		56	4.83	V.44,47	2.1-5/15/80	
GTURB-TEX-FTO	U-N	P -- EQUIPMENT-QUAD		56	4.83		2.1E -- 8/15/93	
HCIRC-DESIGN-T-DROP		P -- PLANT-PARAMETERS	4.13,F.16	54		V.25	2.1-5/15/80	
HCIRC-ELEC-METER		P -- PLANT-PARAMETERS		54	4.4,4.6		2.1E -- 8/15/93	
HCIRC-HEAD		P -- PLANT-PARAMETERS	4.13,F.16	54		V.25	2.1-5/15/80	
HCIRC-IMPELLER-EFF		P -- PLANT-PARAMETERS		54		V.25	2.1-5/15/80	
HCIRC-LOSS		P -- PLANT-PARAMETERS	4.13,F.16	54		V.25	2.1-5/15/80	
HCIRC-MIN-PLR		P -- PLANT-PARAMETERS	4.14,F.16	54	4.46		2.1C-5/15/84	
HCIRC-MOTOR-EFF		P -- PLANT-PARAMETERS		54		V.25	2.1-5/15/80	
HCIRC-PUMP-TYPE		P -- PLANT-PARAMETERS	4.14,F.16	54	4.45		2.1C-5/15/84	
HCIRC-SIZE-OPT		P -- PLANT-PARAMETERS		54	4.45		2.1C-5/15/84	
HE		S -- SUBR-FUNCTIONS		42	1.6		2.1D-6/30/89	
HEATING-CAPACITY	H-CAP	S -- SYSTEM-EQUIPMENT	3.91,F.13	36	3.26,3.65,3.74	IV,249	2.1-5/15/80	
		S -- ZONE		31		IV,201	2.1-5/15/80	
HEATING-EIR	H-EIR	S -- SYSTEM-EQUIPMENT		36	3.25,3.26	IV,250	2.1-5/15/80	
HEATING-SCHEDULE	H-SCH	S -- SYSTEM-CONTROL	3.74,F.12	33	3.74,3.123	IV,18,203	2.0-2/15/79	
HEAT-CAP-FRPM	H-C-FRPM	S -- SYSTEM-EQUIPMENT		38	3.45,3.51		2.1E -- 8/15/93	
HEAT-CAP-FT	H-C-FT	S -- SYSTEM-EQUIPMENT		38	3.26	IV,242-3 IV,249	2.1-5/15/80	
HEAT-CFM-FPLR	H-C-FPLR	S -- SYSTEM-EQUIPMENT		38			2.1E -- 8/15/93	
HEAT-CLOSS-FPLR	H-C-FPLR	S -- SYSTEM-EQUIPMENT		38	3.45,3.51		2.1E -- 8/15/93	
HEAT-CLOSS-MIN	H-C-MIN	S -- SYSTEM-EQUIPMENT		38	3.46,3.51		2.1E -- 8/15/93	
HEAT-CONTROL	H-C	S -- SYSTEM-CONTROL	3.74,F.12	33		IV,204	2.0-2/15/79	
HEAT-EIR-FPLR	H-E-FP	S -- SYSTEM-EQUIPMENT		37	3.26	IV,243,250	2.1-5/15/80	
HEAT-EIR-FRPM	H-E-FRPM	S -- SYSTEM-EQUIPMENT		38	3.45,3.51		2.1E -- 8/15/93	

•COMMAND or Keyword	Abbrev	Subprogram -- Command	DOE-2 Basics (2.1E)	BDL Summary (2.1E)	Supp (2.1E)	Ref Man (2.1A)	Program version	Year added
HEAT-EIR-FT	H-B-FT	S -- SYSTEM-EQUIPMENT		37	3.26,3.45	IV.250	2.1--5/15/80	
HEAT-EIR-LS-FT		S -- SYSTEM-EQUIPMENT		37	3.45		2.1E -- 8/15/93	
HEAT-ELEC-METER	HEAT-EM	S -- PLANT-ASSIGNMENT		45	3.5,3.10		2.1E -- 8/15/93	
		S -- SYSTEM		40	3.5,3.10		2.1E -- 8/15/93	
		S -- ZONE		32	3.5,3.10		2.1E -- 8/15/93	
HEAT-EXCH-EFF		S -- SYSTEM		39	3.82		2.1E -- 8/15/93	
HEAT-EXCH-DELP		S -- SYSTEM		39	3.82		2.1E -- 8/15/93	
HEAT-FUEL-METER	HEAT-FM	S -- PLANT-ASSIGNMENT		45	3.7,3.10		2.1E -- 8/15/93	
		S -- SYSTEM		40	3.7,3.10		2.1E -- 8/15/93	
		S -- ZONE		32	3.7,3.10		2.1E -- 8/15/93	
HEAT-MULTIPLIER	H-M	P -- LOAD-MANAGEMENT		57		V.59	2.0--2/15/79	
HEAT-PEAK-PERIOD	H-P-P	L -- BUILDING-LOCATION		8		III.32	2.1--5/15/80	
•HEAT-RECOVERY	HEAT-R	P	4.7,4.15 F.17	56	4.50	V.8.66	2.0--2/15/79	
HEAT-RESET-SCH	H-R-SCH	S -- SYSTEM-CONTROL	3.75,F.12	33		IV.205	2.0--2/15/79	
HEAT-RPM-LIMITS	H-R-LIM	S -- SYSTEM-EQUIPMENT		38	3.45,3.50		2.1E -- 8/15/93	
HEAT-SET-SCH	H-S-SCH	S -- SYSTEM-CONTROL	3.74,F.12	33		IV.205	2.0--2/15/79	
HEAT-SET-T	H-S-T	S -- SYSTEM-CONTROL	3.74,F.12	33		IV.205	2.0--2/15/79	
HEAT-SIZING-RATIO		S -- SYSTEM		39	3.138		2.1E -- 8/15/93	
HEAT-SOURCE	HEAT-S	S -- SYSTEM	3.89,F.13	39	3.50,3.56, 3.74	IV.259,261	2.0--2/15/79	
HEAT-STORE-RATE	H-ST-R	P -- ENERGY-STORAGE		57		V.73	2.0--2/15/79	
HEAT-STORE-SCH	H-ST-SCH	P -- ENERGY-STORAGE		57		V.74	2.0--2/15/79	
HEAT-SUPPLY-RATE	H-SU-R	P -- ENERGY-STORAGE		57		V.73	2.0--2/15/79	
HEAT-TEMP-SCH	H-T-SCH	S -- ZONE-CONTROL	3.67,F.10	29	3.65,3.117	IV.18,193	2.0--2/15/79	
HEAT-WASTE-HEAT	H-W-HEAT	S -- SYSTEM-EQUIPMENT		38	3.46,3.54		2.1E -- 8/15/93	
HEAT-WH-FT	H-W-FT	S -- SYSTEM-EQUIPMENT		38	3.46,3.53		2.1E -- 8/15/93	
HEAT-WH-FRPM	H-W-FRPM	S -- SYSTEM-EQUIPMENT		38	3.47,3.54		2.1E -- 8/15/93	
HEIGHT	H	L -- BUILDING-SHADE		14		III.35	2.0--2/15/79	
		L -- DOOR	2.31,F.9	24		III.110	2.1--5/15/80	
		L -- EXTERIOR-WALL or ROOF	2.25,F.7	19		III.102	2.0--2/15/79	

•COMMAND or Keyword	Abbrev	Subprogram -- Command	DOE-2 Basics (2.1E)	BDL Summary (2.1E)	Supp (2.1E)	Ref Man (2.1A)	Program version	Year added
		L -- FIXED-SHADE		14			2.1B--	1/15/83
		L -- INTERIOR-WALL		24		III.113	2.1--	5/15/80
		L -- SPACE		18		III.97	2.0--	2/15/79
		L -- TROMBE-WALL-V or -NV		20		III.118	2.1B--	1/15/83
		L -- UNDERGROUND-WALL or -FLOOR		25		III.108	2.1--	5/15/80
		L -- WINDOW	2.27,F.8	21	2.115		2.0--	2/15/79
HERM-CENT-CAP-FT		P -- EQUIPMENT-QUAD		55	4.81	V.41.43	2.1--	5/15/80
HERM-CENT-COND-PWR		P -- PLANT-PARAMETERS		51		V.23, V.26	2.1--	5/15/80
HERM-CENT-COND-TYPE		P -- PLANT-PARAMETERS	4.12,F.16	51		V.23, V.26	2.1--	5/15/80
HERM-CENT-EIR-FPLR		P -- EQUIPMENT-QUAD		55	4.81	V.41.43	2.1--	5/15/80
HERM-CENT-EIR-FT		P -- EQUIPMENT-QUAD		55	4.81	V.41.43	2.1--	5/15/80
HERM-CENT-UNL-RAT		P -- PLANT-PARAMETERS		51		V.23, V.26	2.1--	5/15/80
HERM-REC-CAP-FT		P -- EQUIPMENT-QUAD		55	4.81	V.41.43	2.1--	5/15/80
HERM-REC-COND-PWR		P -- PLANT-PARAMETERS		51		V.23, V.26	2.1--	5/15/80
HERM-REC-COND-TYPE		P -- PLANT-PARAMETERS	4.12,F.16	51		V.23, V.26	2.1--	5/15/80
HERM-REC-EIR-FPLR		P -- EQUIPMENT-QUAD		55	4.81	V.41.43	2.1--	5/15/80
HERM-REC-EIR-FT		P -- EQUIPMENT-QUAD		55	4.81	V.41.43	2.1--	5/15/80
HERM-REC-UNL-RAT		P -- PLANT-PARAMETERS		51		V.23	2.1--	5/15/80
HOLIDAY	HOL	L -- BUILDING-LOCATION	2.5,F.3	8		III.31	2.0--	2/15/79
HOR-LEAK-FRAC	H-L-F	L -- SPACE-CONDITIONS		17	2.86		2.1B--	1/15/83
HOR-VENT-FRAC	H-V-F	S -- SYSTEM-AIR		33	3.33,3.34 3.122-3		2.1D--	6/30/89
HOURLY		S -- SUBR-FUNCTIONS		42	1.6		2.1D--	6/30/89
HOURLY-HI	H-H	L -- DESIGN-DAY		9		III.26	2.0--	2/15/79
HOURLY-LO	H-L	L -- DESIGN-DAY		9		III.26	2.0--	2/15/79
HOURLY-DATA-SAVE	H-D-S	L -- LOADS-REPORT		25			2.1D--	6/30/89
		P -- PLANT-REPORT		58			2.1D--	6/30/89
		S -- SYSTEMS-REPORT		46			2.1D--	6/30/89
•HOURLY-REPORT	H-R	LSP		26,46, 58	1.31	II.32,III.127, IV.273, IV.8,V.103	2.0--	2/15/79

•COMMAND or Keyword	Abbrev	Subprogram -- Command	DOE-2 Basics (2.1E)	BDL Summary (2.1E)	Supp (2.1E)	Ref Man (2.1A)	Program version	Year added
HOURS		LSP -- DAY-SCHEDULE					2.0--2/15/79	
HOURS-CHARGING		P -- PLANT-PARAMETERS		58	4.16		2.1E -- 8/15/93	
HOURS-DISCHARGING		P -- PLANT-PARAMETERS		58	4.16		2.1E -- 8/15/93	
HOURS-USED	H-U	P -- PLANT-EQUIPMENT		48		V.4	2.0--2/15/79	
HPUNIT		S -- SUBR-FUNCTIONS		42	1.6		2.1D--6/30/89	
HP-LOOP-COOLING		S -- PLANT-ASSIGNMENT		43	3.34		2.1E -- 8/15/93	
HP-LOOP-HEATING		S -- PLANT-ASSIGNMENT		43	3.34		2.1E -- 8/15/93	
HP-SUPP-HT-CAP	S-H-C	S -- SYSTEM-EQUIPMENT		36	3.27		2.1C--5/15/84	
HP-SUPP-SOURCE	SUPP-S	S -- SYSTEM-EQUIPMENT		36	3.25,3.27, 3.51		2.1C--5/15/84	
HR8PL-FWB1WB6	HRPL-FWB	S -- SYSTEM-EQUIPMENT		37	3.73,3.74		2.1D--6/30/89	
HR8-FWB1WB6	HR-FWB	S -- SYSTEM-EQUIPMENT		37	3.73,3.74		2.1D--6/30/89	
HTANK-BASE-T	H-B-T	P -- ENERGY-STORAGE		57		V.74	2.0--2/15/79	
HTANK-ENV-T	H-E-T	P -- ENERGY-STORAGE		57		V.76	2.0--2/15/79	
HTANK-FREEZ-T	H-F-T	P -- ENERGY-STORAGE		57		V.76	2.0--2/15/79	
HTANK-LOSS-COEF	H-L-C	P -- ENERGY-STORAGE		57		V.74	2.0--2/15/79	
HTANK-T-RANGE	H-T-R	P -- ENERGY-STORAGE		57		V.74	2.0--2/15/79	
HTPUMP-0Z		S -- SUBR-FUNCTIONS		42	1.6		2.1D--6/30/89	
HTPUMP-1Z		S -- SUBR-FUNCTIONS		42	1.6		2.1D--6/30/89	
HTPUMP-2		S -- SUBR-FUNCTIONS		42	1.6		2.1D--6/30/89	
HTREL-ELEC-METER	HTREL-EM	S -- PLANT-ASSIGNMENT		45	3.5,3.10		2.1E -- 8/15/93	
		S -- SYSTEM		40	3.5,3.10		2.1E -- 8/15/93	
		S -- ZONE		32	3.5,3.10		2.1E -- 8/15/93	
HUMIDIFIER-TYPE	H-TYPE	S -- SYSTEM	3.90,F.13	39	3.23,3.120		2.1B--1/15/83	
HVUNIT-0		S -- SUBR-FUNCTIONS		42	1.6		2.1D--6/30/89	
HVUNIT-1Z		S -- SUBR-FUNCTIONS		42	1.6		2.1D--6/30/89	
HVUNIT-2		S -- SUBR-FUNCTIONS		42	1.6		2.1D--6/30/89	
HVUNIT-3		S -- SUBR-FUNCTIONS		42	1.6		2.1D--6/30/89	
HW-BOILER-HR		P -- PLANT-PARAMETERS	4.13,F.16	52		V.24,V.30	2.1--5/15/80	
HW-BOILER-HR-FPLR		P -- EQUIPMENT-QUAD		55	4.82	V.44,45	2.1--5/15/80	

•COMMAND or Keyword	Abbrev	Subprogram -- Command	DOE-2 Basics (2.1E)	BDL Summary (2.1E)	Supp (2.1E)	Ref Man (2.1A)	Program version	Year added
ICE-HARVEST-RATIO		P -- PLANT-PARAMETERS		52	4.19		2.1E --	8/15/93
INDIR-EFF		S -- SYSTEM-EQUIPMENT		36	3.64,3.67		2.1E --	8/15/93
INDIR-EFF-FCFM		S -- SYSTEM-EQUIPMENT		37	3.68		2.1E --	8/15/93
INDOOR-FAN-MODE	I-F-M	S -- SYSTEM-FANS		34			2.1E --	8/15/93
INDUCTION-RATIO	I-R	S -- SYSTEM-TERMINAL		35		IV.231	2.0--	2/15/79
INDUC-0		S -- SUBR-FUNCTIONS		42	1.6		2.1D--	6/30/89
INDUC-1Z		S -- SUBR-FUNCTIONS		42	1.6		2.1D--	6/30/89
INDUC-2		S -- SUBR-FUNCTIONS		42	1.6		2.1D--	6/30/89
INDUC-MODE-SCH	I-M-SCH	S -- SYSTEM-FLUID		35		IV.234	2.0--	2/15/79
INF-CFM/SQFT	I-CFM	L -- SPACE-CONDITIONS	2.23,F.6	17		III.50	2.0--	2/15/79
INDUCED-AIR-ZONE	I-A-Z	S -- ZONE	3.71,F.11	31	3.19		?	?
INF-COEF	I-C	L -- DOOR		23		III.110	2.1--	5/15/80
		L -- EXTERIOR-WALL or ROOF		19		III.101	2.0--	2/15/79
		L -- TROMBE-WALL-V or -NV		20			2.1B--	1/15/83
		L -- WINDOW		21		III.107	2.0--	2/15/79
INF-METHOD	I-M	L -- SPACE-CONDITIONS	2.22,F.6	16,17		III.49	2.0--	2/15/79
INF-SCHEDULE	I-SCH	L -- SPACE-CONDITIONS	2.23,F.6	17		III.49	2.0--	2/15/79
•INPUT ECONOMICS		E	F.18	61		II.15,III.21	2.0--	2/15/79
•INPUT LOADS		L	2.2,F.3	7		II.15,III.21	2.0--	2/15/79
•INPUT PLANT		P	F.15	47		II.15,III.21	2.0--	2/15/79
•INPUT SYSTEMS		S	F.10	28		II.15,III.21	2.0--	2/15/79
INPUT-TYPE		S,P			1.38		2.0--	2/15/79
INPUT-UNITS		INPUT-ECONOMICS		61			2.0--	2/15/79
		INPUT-LOADS		7			2.1B--	1/15/83
		INPUT-PLANT		47			2.1B--	1/15/83
		INPUT-SYSTEMS		28			2.1B--	1/15/83
		LIBRARY-INPUT LOADS		7			2.1--	5/15/80
		METRIC (option)			1.34		2.1B--	1/15/83
		PARAMETRIC-INPUT			1.34		2.1B--	1/15/83
		ECONOMICS		61			2.1B--	1/15/83
		LOADS		7			2.1B--	1/15/83

COMMAND or Keyword	Abbrev	Subprogram -- Command	DOE-2 Basics (2.1E)	BDL Summary (2.1E)	Supp (2.1E)	Ref Man (2.1A)	Program version added	Year added
		PLANT SYSTEMS		47			2.1B-- 1/15/83	
INSIDE-EMISS	I-E	L -- GLASS-TYPE		29			2.1B-- 1/15/83	
INSIDE-FILM-RES	I-F-R	L -- LAYERS		13			2.1B-- 1/15/83	
INSIDE-SOL-ABS	I-S-A	L -- EXTERIOR-WALL or ROOF	2.7.F.5	11		III.76	2.0-- 2/15/79	
		L -- INTERIOR-WALL		19	2.14		2.1C-- 5/15/84	
		L -- TROMBE-WALL-V or -NV		24	2.14		2.1C-- 5/15/84	
		L -- UNDERGROUND-WALL or -FLOOR		20			2.1C-- 5/15/84	
INSIDE-VIS-REFL	I-V-R	L -- DOOR		25	2.14		2.1C-- 5/15/84	
		L -- EXTERIOR-WALL or ROOF		23	2.64		2.1B-- 1/15/83	
		L -- INTERIOR-WALL		19	2.64		2.1B-- 1/15/83	
		L -- TROMBE-WALL-V or -NV		24	2.64		2.1B-- 1/15/83	
		L -- UNDERGROUND-WALL or -FLOOR		20			2.1B-- 1/15/83	
		L -- WINDOW		25	2.64		2.1B-- 1/15/83	
INSTALLATION	I	P -- PLANT-EQUIPMENT		21	2.64		2.1B-- 1/15/83	
INSTALLATION-EXP		P -- PLANT-COSTS		48		V.13	2.0-- 2/15/79	
INSTALLATION-REF	I-R	P -- REFERENCE-COSTS		57			2.1B-- 1/15/83	
INSTALLED-NUMBER	I-N	P -- PLANT-EQUIPMENT	F.15	58	4.38	V.94	2.0-- 2/15/79	
INSTALL-COST	I-C	E -- COMPONENT-COST		48		V.11.1	2.0-- 2/15/79	
INT-ELEC-KW	I-E-M	S -- PLANT-ASSIGNMENT	3.92.F.13	61		VI.6	2.0-- 2/15/79	
INT-ELEC-SCH	I-F-M	S -- PLANT-ASSIGNMENT		45	3.14		2.1E -- 8/15/93	
INT-ELEC-METER	I-F-M	S -- PLANT-ASSIGNMENT	3.92.F.13	45	3.14		2.1E -- 8/15/93	
INT-FUEL-BTU/HR	I-W-TYPE	S -- PLANT-ASSIGNMENT	3.92.F.13	45	3.14		2.1E -- 8/15/93	
INT-FUEL-METER	I-W	S -- PLANT-ASSIGNMENT		45	3.13		2.1E -- 8/15/93	
INT-FUEL-POWER	I-W-TYPE	S -- PLANT-ASSIGNMENT	3.92.F.13	45	3.13		2.1E -- 8/15/93	
INT-FUEL-SCH	I-W-TYPE	S -- PLANT-ASSIGNMENT		45	3.13		2.1E -- 8/15/93	
INT-WALL-TYPE	I-W	L -- INTERIOR-WALL		24	2.90		2.1B-- 1/15/83	
INTERIOR-WALL		L	2.2.2.32 F.7	24	2.90	III.69, III.113	2.0-- 2/15/79	
LABOR	L	P -- PLANT-COSTS		57		V.91	2.0-- 2/15/79	

•COMMAND or Keyword	Abbrev	Subprogram -- Command	DOE-2 Basics (2.1E)	BDL Summary (2.1E)	Supp (2.1E)	Ref Man (2.1A)	Program version	Year added
LABOR-INFLT	L-I	P -- PLANT-COSTS		57		V.91	2.0-	2/15/79
LATITUDE	LAT	L -- BUILDING-LOCATION	2.4,F.3	8		III.30	2.0-	2/15/79
•LAYERS	LA	L	2.2,2.7 F.5	11		III.76	2.0-	2/15/79
LAYERS	LA	L -- CONSTRUCTION	2.9,F.5	11		III.80	2.0-	2/15/79
LEFT-FIN-A	L-F-A	L -- DOOR	F.9	23			2.1B-	1/15/83
LEFT-FIN-B	L-F-B	L -- WINDOW	2.29,F.8	21			2.1B-	1/15/83
LEFT-FIN-D	L-F-D	L -- DOOR	F.9	23			2.1B-	1/15/83
LEFT-FIN-H	L-F-H	L -- WINDOW	2.29,F.8	21			2.1B-	1/15/83
LEVEL		L -- DOOR	F.9	23			2.1B-	1/15/83
		L -- WINDOW	2.29,F.8	21			2.1B-	1/15/83
		LS -- FUNCTION		26			2.1C-	5/15/84
•LIBRARY-INPUT LOADS		L		7			2.1-	5/15/80
LIFE-EXP	L-E	P -- PLANT-COSTS		58			2.1B-	1/15/83
LIFE-REF	L-R	P -- REFERENCE-COSTS		57		V.94	2.0-	2/15/79
LIGHTING-KW	L-KW	L -- SPACE-CONDITIONS	2.17,F.6	16		III.44	2.0-	2/15/79
LIGHTING-SCHEDULE	L-SCH	L -- SPACE-CONDITIONS	2.17,F.6	16		III.44	2.0-	2/15/79
LIGHTING-TYPE	L-T	L -- SPACE-CONDITIONS	2.17,F.6	16		III.44	2.0-	2/15/79
LIGHTING-W/SQFT	L-W	L -- SPACE-CONDITIONS	2.18,F.6	16		III.45	2.0-	2/15/79
LIGHT-CTRL-PROB	L-C-P	L -- SPACE-CONDITIONS		17	2.56		2.1B-	1/15/83
LIGHT-CTRL-STEPS	L-C-S	L -- SPACE-CONDITIONS		17	2.55		2.1B-	1/15/83
LIGHT-CTRL-TYPE1	L-C-T1	L -- SPACE-CONDITIONS		17	2.54		2.1B-	1/15/83
LIGHT-CTRL-TYPE2	L-C-T2	L -- SPACE-CONDITIONS		17	2.54		2.1B-	1/15/83
LIGHT-ELEC-METER	LIGHT-EM	S -- PLANT-ASSIGNMENT		44	3.4,3.9		2.1E --	8/15/93
		S -- SYSTEM		40	3.4,3.9		2.1E --	8/15/93
		S -- ZONE		32	3.4,3.9		2.1E --	8/15/93
LIGHT-HEAT-TO	L-H-T	L -- SPACE-CONDITIONS		16	2.81		2.1B-	1/15/83
LIGHT-RAD-FRAC	L-R-F	L -- SPACE-CONDITIONS		16	2.82		2.1B-	1/15/83
LIGHT-REF-POINT1	L-R-P1	L -- SPACE-CONDITIONS		17	2.53		2.1B-	1/15/83

•COMMAND or Keyword	Abbrev	Subprogram -- Command	DOE-2 Basics (2.1E)	BDL Summary (2.1E)	Supp (2.1E)	Ref Man (2.1A)	Program version	Year added
LIGHT-REF-POINT2	L-R-P2	L -- SPACE-CONDITIONS		17	2.53		2.1B--	1/15/83
LIGHT-SET-POINT1	L-S-P1	L -- SPACE-CONDITIONS		17	2.54		2.1B--	1/15/83
LIGHT-SET-POINT2	L-S-P2	L -- SPACE-CONDITIONS		17	2.54		2.1B--	1/15/83
LIGHT-TO-OTHER	L-T-O	L -- SPACE-CONDITIONS		16	2.81		2.1B--	1/15/83
LIGHT-TO-RETURN	L-T-R	L -- SPACE-CONDITIONS		16	2.81		2.1B--	1/15/83
LIGHT-TO-SPACE	L-T-S	L -- SPACE-CONDITIONS	2.18,F.6	16	2.81	III.46	2.0--	2/15/79
LIMITS		LSPE -- DIAGNOSTIC		7			2.0--	2/15/79
•LOAD-ASSIGNMENT	L-A	P		56	4.2,4.49	V.8,52	2.0--	2/15/79
LOAD-ASSIGNMENT	L-A	P -- LOAD-MANAGEMENT		57		V.60	2.0--	2/15/79
•LOAD-MANAGEMENT	L-M	P		57		V.8,59	2.0--	2/15/79
LOAD-RANGE	L-R	P -- LOAD-ASSIGNMENT		56	4.49	V.52	2.0--	2/15/79
•LOADS-REPORT	L-R	L	2.2,2.34 F.9	25		III.123	2.0--	2/15/79
LOCATION	LOC	L -- EXTERIOR-WALL or ROOF L -- INTERIOR-WALL		19		III.102	2.0--	2/15/79
		L -- TROMBE-WALL-V or -NV		24		III.113	2.1--	5/15/80
		L -- UNDERGROUND-WALL or -FLOOR		20			2.1B--	1/15/83
LONGITUDE	LON	L -- BUILDING-LOCATION	2.4,F.3	25		III.119	2.1--	5/15/80
LOWER-VENT-AREA	L-V-A	L -- WALL-PARAMETERS		8		III.30	2.0--	2/15/79
LOW-SPEED-RATIOS	L-S-R	S -- SYSTEM-FANS		15	2.12,2.71		2.1B--	1/15/83
				34		IV.227	2.1--	5/15/80
MAINTENANCE	M	P -- PLANT-EQUIPMENT		48		V.14	2.0--	2/15/79
MAINTENANCE-EXP	M-E	P -- PLANT-COSTS		58			2.1B--	1/15/83
MAINTENANCE-REF	M-R	P -- REFERENCE-COSTS		58		V.94	2.0--	2/15/79
MAJ-OVHL-COST	MAJ-O-C	E -- COMPONENT-COST		61		V.8	2.0--	2/15/79
MAJ-OVHL-CST-EXP	MAJ-O-C	P -- PLANT-COSTS		57			2.1B--	1/15/83
MAJ-OVHL-CST-REF	MAJ-O-C	P -- REFERENCE-COSTS		58		V.95	2.0--	2/15/79
MAJ-OVHL-INT	MAJ-O-I	E -- COMPONENT-COST		61		V.8	2.0--	2/15/79
MAJ-OVHL-INT-EXP	MAJ-O-I	P -- PLANT-COSTS		57			2.1B--	1/15/83
MAJ-OVHL-INT-REF	MAJ-O-I	P -- REFERENCE-COSTS		58		V.95	2.0--	2/15/79



•COMMAND or Keyword	Abbrev	Subprogram - Command	DOE-2 Basics (2.1E)	BDL Summary (2.1E)	Supp (2.1E)	Ref Man (2.1A)	Program version	Year added
MAJOR-OVHL-COST	MAJ-O-C	P - PLANT-EQUIPMENT		48		V.14	2.0-	2/15/79
MAJOR-OVHL-INT	MAJ-O-I	P - PLANT-EQUIPMENT		48		V.14	2.0-	2/15/79
•MATERIAL	MAT	L		11		III.73	2.0-	2/15/79
MATERIAL	MAT	L - LAYERS	2.7,F.5	11		III.76	2.0-	2/15/79
MATERIALS-INFLTN	M-I	P - PLANT-COSTS		57		V.91	2.0-	2/15/79
MAX-COND-RCVRY	M-C-R	S - SYSTEM-EQUIPMENT	3.90,F.13	36		IV.249	2.1-	5/15/80
MAX-COOL-RATE	MAX-C-R	S - ZONE		31		IV.18,200	2.0-	2/15/79
MAX-FAN-RATIO	MAX-F-R	S - SYSTEM-FANS		34	3.31,3.74	IV.227	2.0-	2/15/79
MAX-FLUID-T	MAX-F-T	S - SYSTEM-FLUID		35	3.34	IV.235	2.0-	2/15/79
		S - PLANT-ASSIGNMENT		44	3.42		2.1E-	8/15/93
MAX-GLARE	M-G	L - SPACE-CONDITIONS		17	2.57,2.69		2.1B-	1/15/83
MAX-HEAT-RATE	MAX-H-R	S - ZONE		31		IV.18,199	2.0-	2/15/79
MAX-HP-SUPP-T	M-SUPP-T	S - SYSTEM-EQUIPMENT		36	3.25,3.26		2.1C-	5/15/84
MAX-HUMIDITY	MAX-H	S - SYSTEM-CONTROL	3.76,F.12	33	3.74,3.118	IV.208	2.0-	2/15/79
MAX-NUMBER-AVAIL	M-N-A	P - PLANT-EQUIPMENT		49	4.38	V.11.1	2.0-	2/15/79
MAX-OA-FRACTION	M-O-F	S - SYSTEM-AIR		34	3.33	IV.217	2.1-	5/15/80
MAX-RATIO	MAX-R	P - PART-LOAD-RATIO		50	4.10,4.13, 4.38	V.18	2.0-	2/15/79
MAX-SOLAR-SCH	M-S-SCH	L - WINDOW	2.27,F.8	21	2.61		2.1B-	1/15/83
MAX-SUPPLY-T	MAX-S-T	S - SYSTEM-CONTROL	3.74,F.12	33	3.25	IV.203	2.0-	2/15/79
MAX-VENT-RATE	M-V-R	S - SYSTEM-AIR		33	3.122-3		2.1D-	6/30/89
METERS		E - UTILITY-RATE		60	5.6		2.1E -	8/15/93
MINOR-OVHL-COST	MIN-O-C	P - PLANT-EQUIPMENT		48			2.0-	2/15/79
MINOR-OVHL-INT	MIN-O-I	P - PLANT-EQUIPMENT		48			2.0-	2/15/79
MIN-AIR-SCH	M-A-SCH	S - SYSTEM-AIR	3.80,F.12	33	3.74	IV.215	2.0-	2/15/79
MIN-CFM-RATIO	M-C-R	S - SYSTEM-TERMINAL	3.90,F.13	35		IV.231	2.0-	2/15/79
		S - ZONE	3.72,F.11	31	3.19	IV.200	2.1-	5/15/80
MIN-CFM-SCH	M-C-SCH	S - ZONE	3.73,F.11	31	3.20,3.121		2.1B-	1/15/83
MIN-COND-AIR-T		P - PLANT-PARAMETERS	4.11,F.16	51	4.36	V.22,V.23	2.1-	5/15/80
MIN-FAN-RATIO	MIN-F-R	S - SYSTEM-FANS		34	3.23,3.72	IV.227	2.0-	2/15/79

•COMMAND or Keyword	Abbrev	Subprogram -- Command	DOE-2 Basics (2.1E)	BDL Summary (2.1E)	Supp (2.1E)	Ref Man (2.1A)	Program version	Year added
MIN-FLUID-T	MIN-F-T	S - SYSTEM-FLUID		35	3.32,3.82	IV.234	2.0-2/15/79	
		S - PLANT-ASSIGNMENT		44			2.1E - 8/15/93	
MIN-HGB-RATIO	M-H-R	S - SYSTEM-EQUIPMENT		36		IV.248	2.1-5/15/80	
MIN-HP-T	M-H-T	S - SYSTEM-EQUIPMENT		36	3.23,3.24	IV.251	2.1-5/15/80	
MIN-HUMIDITY	MIN-H	S - SYSTEM-CONTROL	3.77,F.12	33		IV.208	2.0-2/15/79	
MIN-LIGHT-FRAC	M-L-F	L - SPACE-CONDITIONS		17	2.55		2.1B-1/15/83	
MIN-MON-CHGS	M-M-CHG	E - UTILITY-RATE	5.4,F.18	60	5.8		2.1E - 8/15/93	
MIN-MON-DEM-CHGS	M-D-CHG	E - UTILITY-RATE	5.4,F.18	60	5.8		2.1E - 8/15/93	
MIN-MON-RATCHETS	M-M-R	E - UTILITY-RATE		60	5.12		2.1E - 8/15/93	
MIN-OUTSIDE-AIR	M-O-A	S - SYSTEM-AIR	3.79,F.12	33	3.25,3.65, 3.74	IV.214	2.0-2/15/79	
		P - PLANT-EQUIPMENT				V.14	2.0-2/15/79	
MIN-OVHL-COST	MIN-O-C	E - COMPONENT-COST		61		V.18	2.0-2/15/79	
MIN-OVHL-CST-EXP	MIN-O-C	P - PLANT-COSTS		57			2.1B-1/15/83	
MIN-OVHL-CST-REF	MIN-O-C	P - REFERENCE-COSTS		58		V.94	2.0-2/15/79	
MIN-OVHL-INT	MIN-O-I	E - COMPONENT-COST		61		VI.8	2.0-2/15/79	
		P - PLANT-EQUIPMENT				V.14	2.0-2/15/79	
MIN-OVHL-INT-EXP	MIN-O-I	P - PLANT-COSTS		57			2.1B-1/15/83	
MIN-OVHL-INT-REF	MIN-O-I	P - REFERENCE-COSTS		58		V.94	2.0-2/15/79	
MIN-POWER-FRAC	M-P-F	L - SPACE-CONDITIONS		17	2.55		2.1B-1/15/83	
MIN-RATIO	MIN-R	P - PART-LOAD-RATIO		50	4.10,4.13, 4.38	V.18	2.0-2/15/79	
		S - SYSTEM-CONTROL		33			2.1E - 8/15/93	
MIN-SUPPLY-SCH	M-S-SCH	S - SYSTEM-CONTROL	3.75,F.12	33	3.25,3.128	IV.206	2.0-2/15/79	
MIN-SUPPLY-T	MIN-S-T	S - PLANT-ASSIGNMENT	4.12	43	3.89		2.1E - 8/15/93	
MIN-TWR-WTR-T		P - PLANT-PARAMETERS	F.16	53				
		P - PLANT-PARAMETERS		54	4.47		2.1C-5/15/84	
		P - HEAT-RECOVERY			4.48		2.1E-8/15/93	
		P - LOAD-ASSIGNMENT			4.48		2.1E-8/15/93	
MIN-TWR-WTR-T		S - PLANT-ASSIGNMENT			3.38,3.87		2.1E-8/15/93	
MIN-UNLOAD-RATIO	M-U-R	S - SYSTEM-EQUIPMENT		36		IV.248	2.1-5/15/80	

COMMAND or Keyword	Abbrev	Subprogram - Command	DOE-2 Basics (2.1E)	BDL Summary (2.1E)	Supp (2.1E)	Ref Man (2.1A)	Program version	Year added
MISC-ELEC-METER		P - PLANT-PARAMETERS		54	4.4,4.46		2.1E -	8/15/93
MONTH-CHGS	M-CHG	E - UTILITY-RATE	5.2,F.18	62	5.6		2.1E -	8/15/93
MOTOR-PLACEMENT	M-P	S - SYSTEM-FANS		34		IV.225	2.0 -	2/15/79
MSTR-ELEC-METER	MSTR-EM	S - PLANT-ASSIGNMENT		44	3.9		2.1E -	8/15/93
		S - SYSTEM		40	3.9		2.1E -	8/15/93
		S - ZONE		32	3.9		2.1E -	8/15/93
MSTR-FUEL-METER	MSTR-FM	S - PLANT-ASSIGNMENT		44	3.9		2.1E -	8/15/93
		S - SYSTEM		40	3.9		2.1E -	8/15/93
		S - ZONE		32	3.9		2.1E -	8/15/93
MULTIPLIER	M	L - DOOR		24		III.110	2.1 -	5/15/80
		L - EXTERIOR-WALL or ROOF	2.25,F.7	19		III.102	2.0 -	2/15/79
		L - SPACE		18	2.89	III.94	2.0 -	2/15/79
		L - TROMBE-WALL-V or -NV		20			2.1B -	1/15/83
		L - UNDERGROUND-WALL or -FLOOR		25		III.119	2.0 -	2/15/79
		L - WINDOW		21		III.107	2.0 -	2/15/79
		S - ZONE		31		IV.8,199	2.0 -	2/15/79
NAME		LS - FUNCTION		26	1.4		2.1D -	6/30/89
NATURAL-VENT-AC	N-V-A	S - SYSTEM			3.123		2.0A -	6/15/79
		S - SYSTEM-AIR	3.81,F.12	33	3.123	IV.217	2.1 -	5/15/80
NATURAL-VENT-SCH	N-V-SCH	S - SYSTEM			3.123		2.0A -	6/15/79
		S - SYSTEM-AIR	3.81,F.12	33	3.123	IV.217	2.1 -	5/15/80
NEUTRAL-LEVEL	N-L	L - SPACE-CONDITIONS		17	2.86,3.123		2.1C -	5/15/84
NEUTRAL-ZONE-HT	N-Z-H	L - SPACE-CONDITIONS		17		III.51	2.0 -	2/15/79
NEXT-TO	N-T	L - INTERIOR-WALL	2.32,F.7	24		III.114	2.0 -	2/15/79
NIGHT-CYCLE-CTRL	N-C-C	S - SYSTEM-FANS	3.86,F.12	34	3.21,3.72	IV.18,228	2.1 -	5/15/80
NIGHT-VENT-CYCLE	N-V-C	S - SYSTEM-FANS		34	3.113		2.1B -	1/15/83
NIGHT-VENT-DT	N-V-D	S - SYSTEM-FANS		34	3.114		2.1B -	1/15/83
NIGHT-VENT-RATIOS	N-V-R	S - SYSTEM-FANS		34	3.114		2.1B -	1/15/83
NIGHT-VENT-SCH	NT-V-SCH	S - SYSTEM-FANS		34	3.113		2.1B -	1/15/83
NUM-MONTHS		E - RATCHET		60	5.27		2.1E -	8/15/93

•COMMAND or Keyword	Abbrev	Subprogram -- Command	DOE-2 Basics (2.1E)	BDL Summary (2.1E)	Supp (2.1E)	Ref Man (2.1A)	Program version	Year added
NUMBER	N	P -- LOAD-ASSIGNMENT		56		V.53	2.0--2/15/79	
NUMBER-OF-PEOPLE	N-O-P	L -- SPACE-CONDITIONS	2.16,F.6	16		III.43	2.0--2/15/79	
NUMBER-OF-UNITS	N-O-U	E -- COMPONENT-COST		61		VI.6	2.0--2/15/79	
OA-CFM/PER	O-CFM/P	S -- ZONE-AIR	3.69,F.11	30		IV.190	2.0--2/15/79	
OA-CHANGES	O-C	S -- ZONE-AIR	3.69,F.11	30		IV.190	2.0--2/15/79	
OA-CONTROL	O-CTRL	S -- SYSTEM-AIR	3.80,F.12	33	3.25,3.26, 3.98	IV.215	2.0--2/15/79	
OA-FROM-SYSTEM	OA-F-S	S -- SYSTEM		39	3.117		2.1E -- 8/15/93	
OFFSET		E -- RATCHET		60	5.28		2.1E -- 8/15/93	
OPEN-CENT-CAP-FT		P -- EQUIPMENT-QUAD		55	4.81	V.41.43	2.1--5/15/80	
OPEN-CENT-COND-PWR		P -- PLANT-PARAMETERS		51	4.36	V.23,V.26	2.1--5/15/80	
OPEN-CENT-COND-TYPE		P -- PLANT-PARAMETERS		51	4.36	V.23,V.26	2.1--5/15/80	
OPEN-CENT-EIR-FPLR		P -- EQUIPMENT-QUAD		55	4.81	V.42.43	2.1--5/15/80	
OPEN-CENT-EIR-FT		P -- EQUIPMENT-QUAD		55	4.81	V.42	2.1--5/15/80	
OPEN-CENT-MOTOR-EFF		P -- PLANT-PARAMETERS		51	4.36	V.23,V.26	2.1--5/15/80	
OPEN-CENT-UNL-RATIO		P -- PLANT-PARAMETERS		51	4.36	V.23,V.26	2.1--5/15/80	
OPEN-REC-CAP-FT		P -- EQUIPMENT-QUAD		55	4.82	V.42.43	2.1--5/15/80	
OPEN-REC-COND-PWR		P -- PLANT-PARAMETERS		51	4.36	V.23,V.27	2.1--5/15/80	
OPEN-REC-COND-TYPE		P -- PLANT-PARAMETERS		51	4.36	V.23,V.27	2.1--5/15/80	
OPEN-REC-EIR-FPLR		P -- EQUIPMENT-QUAD		55	4.82	V.42.43	2.1--5/15/80	
OPEN-REC-EIR-FT		P -- EQUIPMENT-QUAD		55	4.82	V.42.43	2.1--5/15/80	
OPEN-REC-MOTOR-EFF		P -- PLANT-PARAMETERS		51	4.36	V.23,V.27	2.1--5/15/80	
OPEN-REC-UNL-RAT		P -- PLANT-PARAMETERS		51	4.36	V.23,V.27	2.1--5/15/80	
OPEN-SHADE-SCH	O-S-SCH	L -- WINDOW		21	2.35		2.1C--5/15/84	
OPEN-VENT-SCH	O-V-SCH	S -- SYSTEM-AIR		33	3.121,3.123		2.1D--6/30/89	
OPERATING-RATIO	O-R	P -- PART-LOAD-RATIO		50	4.13,4.38	V.18	2.0--2/15/79	
OPERATIONS-COST	O-C	E -- BASELINE		61		VI.9,11	2.0--2/15/79	
OPERATION-MODE	O-M	P -- LOAD-ASSIGNMENT		56		V.54	2.0--2/15/79	

•COMMAND or Keyword	Abbrev	Subprogram -- Command	DOE-2 Basics (2.1E)	BDL Summary (2.1E)	Supp (2.1E)	Ref Man (2.1A)	Program version	Year added
OPSTRT		S -- SUBR-FUNCTIONS		42	1.6		2.1D--	6/30/89
OPTION	O	LS -- HOURLY-REPORT		26,46		III.127	2.0A--	6/15/79
OTHER-FUEL-NAME		P -- ENERGY-RESOURCE		58	4.6		2.1E --	8/15/93
OUTPUT-MAX		SP -- CURVE-FIT		28	3.140		2.1B--	1/15/83
OUTPUT-MIN		SP -- CURVE-FIT		28	3.140		2.1B--	1/15/83
OUTPUT-UNITS		L -- INPUT-LOADS		7			2.1B--	1/15/83
		P -- INPUT-PLANT		47			2.1B--	1/15/83
		S -- INPUT-SYSTEMS		28			2.1B--	1/15/83
		PARAMETRIC-INPUT			1.30		2.1B--	1/15/83
		ECONOMICS		61			2.1B--	1/15/83
		LOADS		7			2.1B--	1/15/83
		PLANT		47			2.1B--	1/15/83
		SYSTEMS		28			2.1B--	1/15/83
OUTSIDE-AIR-CFM	O-A-CFM	S -- ZONE-AIR	3.69,F.11	30			2.0--	2/15/79
OUTSIDE-EMISS	O-E	L -- GLASS-TYPE		13			2.1E --	8/15/93
		L -- EXTERIOR-WALL or -ROOF		19			2.1E --	8/15/93
OUTSIDE-FAN-CFLT	O-F-CFLT	S -- SYSTEM-EQUIPMENT		38	3.52		2.1E --	8/15/93
		S -- SYSTEM-FANS		34	3.47		2.1E --	8/15/93
OUTSIDE-FAN-ELEC	O-F-HFLT	S -- SYSTEM-EQUIPMENT		36	3.56		2.1E --	8/15/93
OUTSIDE-FAN-HFLT	O-F-HFLT	S -- SYSTEM-EQUIPMENT		38	3.52		2.1E --	8/15/93
		S -- SYSTEM-FANS		34	3.47		2.1E --	8/15/93
OUTSIDE-FAN-MODE	O-F-M	S -- SYSTEM-EQUIPMENT		36		IV.249	2.1--	5/15/80
OUTSIDE-FAN-T	O-F-T	S -- SYSTEM-EQUIPMENT		36		IV.249	2.1--	5/15/80
OUTSIDE-HI	O-H	S -- DAY-RESET-SCH	3.64,F.10	29		IV.177	2.0--	2/15/79
OUTSIDE-LO	O-L	S -- DAY-RESET-SCH	3.64,F.10	29		IV.177	2.0--	2/15/79
OVERHANG-A	OH-A	L -- DOOR	F.9	23	2.77		2.1B--	1/15/83
		L -- WINDOW	2.28,F.8	21	2.77		2.1B--	1/15/83
OVERHANG-ANGLE	OH-ANG	L -- DOOR	F.9	23	2.77		2.1B--	1/15/83
		L -- WINDOW	2.28,F.8	21	2.77		2.1B--	1/15/83
OVERHANG-B	OH-B	L -- DOOR	F.9	23	2.77		2.1B--	1/15/83
		L -- WINDOW	2.28,F.8	21	2.77		2.1B--	1/15/83
OVERHANG-D	OH-D	L -- DOOR	F.9	23	2.77		2.1B--	1/15/83

•COMMAND or Keyword	Abbrev	Subprogram — Command	DOE-2 Basics (2.1E)	BDL Summary (2.1E)	Supp (2.1E)	Ref Man (2.1A)	Program version	Year added
OVERHANG-W	OH-W	L — WINDOW L — DOOR L — WINDOW	2.28,F.8 F.9 2.28,F.8	21 23 21	2.77 2.77 2.77		2.1B— 2.1B— 2.1B—	1/15/83 1/15/83 1/15/83
PANEL-OZ		S — SUBR-FUNCTIONS		42	1.6		2.1D—	6/30/89
PANEL-I		S — SUBR-FUNCTIONS		42	1.6		2.1D—	6/30/89
PANEL-LOSS-RATIO	P-L-R	S — ZONE		31		IV.200	2.0—	2/15/79
PANES	P	L — GLASS-TYPE	2.13,F.3	13		III.87	2.0—	2/15/79
•PARAMETER		LSPE		8,28, 47,59		II.20,V.8	2.0—	2/15/79
•PARAMETRIC-INPUT								
•ECONOMICS		E		59		II.15,II.16	2.1—	5/15/80
•LOADS		L		7		II.15,II.16	2.1—	5/15/80
•PLANT		P		47		II.15,II.16	2.1—	5/15/80
•SYSTEMS		S		27		II.15,II.16	2.1—	5/15/80
•PART-LOAD-RATIO	P-L-R	P	4.9,F.15	50		V.8,18	2.0—	2/15/79
PCT-SRCHGS-APPLY	SRG-APLY	E — UTILITY-RATE		60	5.14		2.1E —	8/15/93
PCT-SRCHG-DATA	PCT-SRG	E — UTILITY-RATE		60	5.14		2.1E —	8/15/93
PCT-TAX-DATA	PCT-TX	E — UTILITY-RATE		60	5.13		2.1E —	8/15/93
PCT-TAXES-APPLY	TX-APLY	E — UTILITY-RATE		62	5.13		2.1E —	8/15/93
PEOPLE-HEAT-GAIN	P-H-G	L — SPACE-CONDITIONS	2.16,F.6	16		III.43	2.0—	2/15/79
PEOPLE-HG-LAT	P-H-L	L — SPACE-CONDITIONS	2.17,F.6	16		III.44	2.0—	2/15/79
PEOPLE-HG-SENS	P-H-S	L — SPACE-CONDITIONS	2.17,F.6	16		III.44	2.0—	2/15/79
PEOPLE-SCHEDULE	P-SCH	L — SPACE-CONDITIONS	2.16,F.6	16		III.43	2.0—	2/15/79
PER-COMP-REDUCT/F		P — PLANT-PARAMETERS		52	4.17		2.1E —	8/15/93
PERCENT-STORED		P — PLANT-PARAMETERS		52	4.16		2.1E —	8/15/93
PIU-0		S — SUBR-FUNCTIONS		42	1.6		2.1D—	6/30/89
PIU-1		S — SUBR-FUNCTIONS		42	1.6		2.1D—	6/30/89
•PLANT-ASSIGNMENT	P-A	P	4.9,F.16	48				
•PLANT-ASSIGNMENT	P-A	S	3.92,F.13	43		IV.267,V.8,98	2.0—	2/15/79

COMMAND or Keyword	Abbrev	Subprogram — Command	DOE-2 Basics (2.1E)	BDL Summary (2.1E)	Supp (2.1E)	Ref Man (2.1A)	Program version	Year added
•PLANT-COSTS	P-C	P		57		V.8,91	2.0—	2/15/79
•PLANT-EQUIPMENT	P-E	P	4.7.F.13	48		V.8,9	2.0—	2/15/79
PLANT-EQUIPMENT	P-E	P — LOAD-ASSIGNMENT		56		V.8,53	2.0—	2/15/79
•PLANT-PARAMETERS	P-P	P	4.7.F.16	51	4.1,4.8, 4.13	V.8,22	2.0—	2/15/79
•PLANT-REPORT	P-R	P	4.7.4.17 F.17	58		V.8,100	2.0—	2/15/79
PLANT-REPORTS		S — PLANT-ASSIGNMENT		43			2.1E—	8/15/93
PLANT-SIZING-BY		P — PLANT-PARAMETERS		51			2.1E—	8/15/93-??
PLENUM-NAMES	P-N	S — SYSTEM		39	3.74	IV.264	2.0—	2/15/79
POWER-FACTOR	P-F	E — UTILITY-RATE		60	5.12		2.1E —	8/15/93
PRED-LOAD-RANGE	P-L-R	P — LOAD-MANAGEMENT		57		V.60	2.0—	2/15/79
PREHEAT-SOURCE	PREHEAT	S — SYSTEM	3.90.F.13	39	3.54,3.56	IV.260-3	2.0—	2/15/79
PREHEAT-T	P-T	S — SYSTEM-CONTROL	3.70.F.12	33			2.0—	2/15/79
PROCESS-CHW-BTU/HR		S — PLANT-ASSIGNMENT	3.93.F.13	45	3.14		2.1E —	8/15/93
PROCESS-CHW-POWER		S — PLANT-ASSIGNMENT		45	3.14		2.1E —	8/15/93
PROCESS-CHW-SCH		S — PLANT-ASSIGNMENT	3.93.F.13	45	3.15		2.1E —	8/15/93
PROCESS-HW-BTU/HR		S — PLANT-ASSIGNMENT	3.93.F.13	45	3.14		2.1E —	8/15/93
PROCESS-HW-POWER		S — PLANT-ASSIGNMENT		45	3.14		2.1E —	8/15/93
PROCESS-HW-SCH		S — PLANT-ASSIGNMENT	3.93.F.13	45	3.14		2.1E —	8/15/93
PROJECT-LIFE	P-L	P — PLANT-COSTS		57			2.0—	2/15/79
PTAC-0		S — SUBR-FUNCTIONS		42	1.6		2.1D—	6/30/89
PTAC-1Z		S — SUBR-FUNCTIONS		42	1.6		2.1D—	6/30/89
PTAC-2		S — SUBR-FUNCTIONS		42	1.6		2.1D—	6/30/89
PUMP+AUX-KW		P — PLANT-PARAMETERS		52	1.48		2.1E —	8/15/93
PUMP+AUX-SCH		P — PLANT-PARAMETERS		52	1.49		2.1E —	8/15/93
QREGPL-FWB1WB6	QRPL-FWB	S — SYSTEM-EQUIPMENT		37	3.71,3.72		2.1D—	6/30/89
QREG-FWB1WB6	QR-FWB	S — SYSTEM-EQUIPMENT		37	3.71,3.72		2.1D—	6/30/89

COMMAND or Keyword	Abbrev	Subprogram -- Command	DOE-2 Basics (2.1E)	BDL Summary (2.1E)	Supp (2.1E)	Ref Man (2.1A)	Program version	Year added
QUALIFY-RATE	Q-R	E -- UTILITY-RATE		60	5.10		2.1E --	8/15/93
QUAL-SCH	Q-SCH	E -- UTILITY-RATE		60	5.11		2.1E --	8/15/93
•RATCHET		E		60	5.3.5.27		2.1E--	8/15/93
RATCHET-SCH	R-SCH	E -- RATCHET		60	5.28		2.1E --	8/15/93
RATE-LIMITATION	R-L	E -- UTILITY-RATE	5.4,F.18	60	5.3.5.9		2.1C--	5/15/84
RECOVERY-EFF	REC-E	S -- SYSTEM-AIR	3.80,F.12	33	3.33	IV.215	2.0--	2/15/79
•REFERENCE-COSTS		P		58		V.8.94	2.0--	2/15/79
REFG-AUX-HEAT	R-C	S -- ZONE		31	3.7.3.105		2.1C--	5/15/84
REFG-AUX-KW		S -- ZONE		31	3.7.3.105		2.1C--	5/15/84
REFG-AUX-SCH		S -- ZONE		31	3.7.3.105		2.1C--	5/15/84
REFG-COMP-CAP		S -- SYSTEM		40	3.8.3.106		2.1C--	5/15/84
REFG-COMP-BER		S -- SYSTEM		40	3.9.3.107		2.1C--	5/15/84
REFG-COMP-GROUP		S -- SYSTEM		40	3.9.3.107		2.1C--	5/15/84
REFG-COND-TYPE		S -- SYSTEM		40	3.10.3.108		2.1C--	5/15/84
REFG-DEF-CTRL		S -- ZONE		32	3.8.3.106		2.1C--	5/15/84
REFG-DEF-EFF		S -- ZONE		32	3.8.3.106		2.1C--	5/15/84
REFG-DEF-MECH		S -- ZONE		32	3.8.3.106		2.1C--	5/15/84
REFG-DISCHARGE-T		S -- ZONE		31	3.7.3.105		2.1C--	5/15/84
REFG-ELEC-METER	REFG-EM	S -- PLANT-ASSIGNMENT		45	3.6.3.10		2.1E --	8/15/93
		S -- SYSTEM		40	3.6.3.10		2.1E --	8/15/93
		S -- ZONE		32	3.6.3.10		2.1E --	8/15/93
REFG-EVAP-T		S -- ZONE		31	3.7.3.105		2.1C--	5/15/84
REFG-FAN-KW		S -- SYSTEM		40	3.9.3.107		2.1C--	5/15/84
REFG-FAN-T		S -- SYSTEM		40	3.10.3.108		2.1C--	5/15/84
REFG-HTREC-GROUP		S -- SYSTEM		40	3.10.3.108		2.1C--	5/15/84
REFG-HTREC-T		S -- SYSTEM		40	3.10.3.108		2.1C--	5/15/84
REFG-HTREC-UNITS		S -- SYSTEM		40	3.10.3.108		2.1C--	5/15/84
REFG-KW-FPLR		S -- SYSTEM-EQUIPMENT		37	3.11.3.109		2.1C--	5/15/84



COMMAND or Keyword	Abbrev	Subprogram -- Command	DOE-2 Basics (2.1E)	BDL Summary (2.1E)	Supp (2.1E)	Ref Man (2.1A)	Program version	Year added
REFG-KW-FTCOND		S -- SYSTEM-EQUIPMENT		37	3.11.3.109		2.1C-	5/15/84
REFG-LAT-SCH		S -- ZONE		31	3.7.3.105		2.1C-	5/15/84
REFG-MAX-HITREC		S -- SYSTEM		40	3.10.3.108		2.1C-	5/15/84
REFG-MIN-COND-T		S -- SYSTEM		40	3.10.3.108		2.1C-	5/15/84
REFG-PUMP-KW		S -- SYSTEM		40	3.10.3.108		2.1C-	5/15/84
REFG-SENS-SCH		S -- ZONE		31	3.7.3.105		2.1C-	5/15/84
REFG-SIZING-RAT		S -- SYSTEM		40	3.8.3.106		2.1C-	5/15/84
REFG-ZONE-DES-RH		S -- ZONE		31	3.7.3.105		2.1C-	5/15/84
REFG-ZONE-DES-T		S -- ZONE		31	3.6.3.104		2.1C-	5/15/84
REFG-ZONE-LOAD		S -- ZONE		31	3.6.3.104		2.1C-	5/15/84
REFG-ZONE-SHR		S -- ZONE		31	3.6.3.104		2.1C-	5/15/84
REFRIG-T-AT-PC		P -- PLANT-PARAMETERS		52	4.17		2.1E --	8/15/93
REG-HEAT-SOURCE		S -- SYSTEM		39	3.77		2.1E --	8/15/93
REHEAT-DELTA-T	R-D-T	S -- SYSTEM-TERMINAL	3.90.F.13	35		IV.231	2.0-	2/15/79
REPLACE-COST	R-C	S -- SYSTEM	3.72.F.11	31	3.19		2.1C-	5/15/84
REPORT-BLOCK	R-B	S -- ZONE		61		VI.9.11	2.0-	2/15/79
		E -- BASELINE		46		II.30,III.130, IV.275,V.8, IV.105	2.0-	2/15/79
		LSPE				III.127, IV.273, V.103	2.0-	2/15/79
REPORT-FREQUENCY	R-F	LSP -- HOURLY-REPORT		26,46 58				
REPORT-SCHEDULE	R-SCH	LOADS-REPORT		25	1.29		2.1C-	5/15/84
		PLANT-REPORT		58	1.29		2.1C-	5/15/84
		SYSTEMS-REPORT		46	1.29		2.1C-	5/15/84
RESET-SCHEDULE	R-SCH	HOURLY-REPORT		26,46		III.127,IV.273 V.103	2.0-	2/15/79
RESISTANCE	RES	S	3.63.F.10	29		IV.176	2.0-	2/15/79
RESOURCE	R	L -- MATERIAL		11		III.74	2.0-	2/15/79
		P -- ENERGY-RESOURCE	4.16.F.17	58	4.5,4.14		2.1C-	5/15/84

•COMMAND or Keyword	Abbrev	Subprogram — Command	DOE-2 Basics (2.1E)	BDL Summary (2.1E)	Supp (2.1E)	Ref Man (2.1A)	Program version	Year added
RESYS-0		E — UTILITY-RATE	5.2,F.18	60	5.6,5.15		2.0—2/15/79	
RESYS-1Z		S — SUBR-FUNCTIONS		42	1.6		2.1D—6/30/89	
RESYS-2Z		S — SUBR-FUNCTIONS		42	1.6		2.1D—6/30/89	
RESYS-3Z		S — SUBR-FUNCTIONS		42	1.6		2.1D—6/30/89	
RESYS-4Z		S — SUBR-FUNCTIONS		42	1.6		2.1D—6/30/89	
RESYS-5		S — SUBR-FUNCTIONS		42	1.6		2.1D—6/30/89	
RES-EVAP-COOLER		S — SYSTEM-EQUIPMENT		42	1.6		2.1D—6/30/89	
RES-EVAP-CL-CFM		S — SYSTEM-EQUIPMENT		36	3.70		2.1E — 8/15/93	
RES-INF-COEF	R-I-C	L — SPACE-CONDITIONS	2.22,F.6	36	3.70	III.50	2.1E — 8/15/93	
RESIST-CAP-RATIO		S — SYSTEM-EQUIPMENT		17			2.0A—6/15/79	
RETURN-AIR-PATH	R-A-P	S — SYSTEM-EQUIPMENT		36	3.25,3.26		2.1E — 8/15/93	
RETURN-CFM	R-CFM	S — SYSTEM-AIR		39	2.83,3.72	IV.262	2.0—2/15/79	
RETURN-DELTA-T	RET-D-T	S — SYSTEM-FANS	3.86,F.12	33		IV.214	2.0—2/15/79	
RETURN-EFF	R-E	S — SYSTEM-FANS		34		IV.226	2.1—5/15/80	
RETURN-KW	R-KW	S — SYSTEM-FANS	3.86,F.12	34		IV.227	2.0—2/15/79	
RETURN-STATIC	R-S	S — SYSTEM-FANS		34		IV.226	2.1—5/15/80	
RIGHT-FIN-A	R-F-A	L — DOOR		34		IV.227	2.0—2/15/79	
RIGHT-FIN-B	R-F-B	L — WINDOW	F.9	23	2.77		2.1B—1/15/83	
RIGHT-FIN-D	R-F-D	L — WINDOW	2.29,F.8	21	2.77		2.1B—1/15/83	
RIGHT-FIN-H	R-F-H	L — DOOR	F.9	23	2.77		2.1B—1/15/83	
ROUGHNESS	RO	L — WINDOW	2.30,F.8	21	2.77		2.1B—1/15/83	
•RUN-PERIOD		L — WINDOW	F.9	23	2.77		2.1B—1/15/83	
		L — CONSTRUCTION	2.30,F.8	21	2.77		2.1B—1/15/83	
		L	2.12,F.5	11,12		III.84	2.0—2/15/79	
			2.2,2.3	7		III.21	2.0—2/15/79	
			F.3					
•SAVE-FILES	LS			27,46		II.34	2.1—5/15/80	

•COMMAND or Keyword	Abbrev	Subprogram — Command	DOE-2 Basics (2.1E)	BDL Summary (2.1E)	Supp (2.1E)	Ref Man (2.1A)	Program version	Year added
•SCHEDULE	SCH	LSPE	2.2,3.3, 5.1,5.15 F.4,F.10,F.18	10,29, 48,59	5.4	II.12,29,V.8	2.0—	2/15/79
SCH-FLAG	FLAG	E — BLOCK-CHARGE E — RATCHET E — UTILITY-RATE	5.5,F.18	59 60 60	5.11,5.16,5.28		2.1E —	8/15/93 8/15/93 8/15/93
SDSF-0		S — SUBR-FUNCTIONS		42	1.6		2.1D—	6/30/89
SDSF-1		S — SUBR-FUNCTIONS		42	1.6		2.1D—	6/30/89
SETBACK	SETB	L — DOOR L — WINDOW	2.31,F.9 2.27,F.8	23 21		III.110 III.107	2.1—	5/15/80 2.0— 2/15/79
•SET-DEFAULT	SET	L		9		II.22,V.8	2.0—	2/15/79
SHADE-DIF-REFL		L — BUILDING-SHADE L — FIXED-SHADE		14 14			2.1E—	8/15/93 8/15/93
SHADE-GND-REFL	S-G-R	L — BUILDING-SHADE L — FIXED-SHADE		14 14	2.52 2.52		2.1B—	1/15/83 1/15/83
SHADE-REFL-ROUGH		L — BUILDING-SHADE L — FIXED-SHADE		14 14			2.1E—	8/15/93 8/15/93
SHADE-SCHEDULE	S-SCH	L — BUILDING-SHADE L — FIXED-SHADE		14 14	2.79 2.79		2.1B—	1/15/83 1/15/83
SHADE-SPEC-REFL		L — BUILDING-SHADE L — FIXED-SHADE		14 14			2.1E—	8/15/93 8/15/93
SHADE-VIS-REFL	S-V-R	L — BUILDING-SHADE L — FIXED-SHADE		14 14	2.52 2.52		2.1B—	1/15/83 1/15/83
SHADING-COEF	S-C	L — GLASS-TYPE	2.13,F.3	13		III.88	2.0—	2/15/79
SHADING-DIVISION	S-D	L — DOOR L — EXTERIOR-WALL or ROOF L — TROMBE-WALL-V or -NV L — WINDOW		23 19 20 21		III.110 III.102 III.107	2.1—	5/15/80 2.0— 2/15/79 2.1B— 1/15/83 2.0— 2/15/79
SHADING-SCHEDULE	S-SCH	L — WINDOW	2.27,F.8	21		III.107	2.0—	2/15/79
SHADING-SURFACE	S-S	L — EXTERIOR-WALL or ROOF L — TROMBE-WALL-V or -NV		19 20	2.79		2.1B—	1/15/83 1/15/83
SHAPE		L — SPACE		18		III.97	2.0—	2/15/79
SHIELDING-COEF	S-COEF	L — BUILDING-LOCATION		8	2.86,3.123		2.1B—	1/15/83

•COMMAND or Keyword	Abbrev	Subprogram — Command	DOE-2 Basics (2.1E)	BDL Summary (2.1E)	Supp (2.1E)	Ref Man (2.1A)	Program version	Year added
SHW-HP-SIZE		S — SYSTEM		39	3.62		2.1E —	8/15/93
SHW-HP-SOURCE		S — SYSTEM		39	3.62		2.1E —	8/15/93
SHW-HP-ZONE		S — SYSTEM		39	3.62		2.1E —	8/15/93
SHW-HT-CAP-FT		S — PLANT-ASSIGNMENT		43	3.63		2.1E —	8/15/93
SHW-HT-EIR		S — PLANT-ASSIGNMENT		43	3.63		2.1E —	8/15/93
SHW-HT-EIR-FT		S — PLANT-ASSIGNMENT		43	3.63		2.1E —	8/15/93
SHW-HT-EIR-FPLR		S — PLANT-ASSIGNMENT		43	3.63		2.1E —	8/15/93
SINGLE-SPACED		LSPE — DIAGNOSTIC		7			2.1B —	1/15/83
SITE-FACTOR	S-F	P — PLANT-COSTS		57		V.92	2.0 —	2/15/79
SIZE		P — PLANT-EQUIPMENT	4.7,F.15	48	4.37	V.11	2.0 —	2/15/79
SIZE-REF	S-R	P — REFERENCE-COSTS		57		V.94	2.0 —	2/15/79
SIZING-OPTION	S-O	S — SYSTEM		39		IV.262	2.1 —	5/15/80
SIZING-RATIO	S-R	S — ZONE		31		IV.201.1	2.1B —	1/15/83
SKY-FORM-FACTOR	S-F-F	S — SYSTEM	3.90,F.13	39		IV.18,262	2.0 —	2/15/79
SOLAR-FRACTION	S-F	L — DOOR		23		III.110	2.1 —	5/15/80
		L — EXTERIOR-WALL or ROOF		19		III.100	2.0 —	2/15/79
		L — TROMBE-WALL-V or -NV		20			2.1B —	1/15/83
		L — WINDOW		21		III.107	2.0 —	2/15/79
		L — EXTERIOR-WALL or ROOF		19		III.103	2.1 —	5/15/80
		L — INTERIOR-WALL		24		III.114	2.1 —	5/15/80
		L — TROMBE-WALL-V or -NV		20			2.1B —	1/15/83
		L — UNDERGROUND-WALL or -FLOOR		25		III.119	2.1 —	5/15/80
SOL-TRANS-SCH	S-T-SCH	L — WINDOW		21	2.8		2.1C —	5/15/84
SOURCE-BTU/HR	S-B	L — SPACE-CONDITIONS	2.21,F.6	16		III.48	2.0 —	2/15/79
SOURCE-ELEC-METER	SRC-EM	S — PLANT-ASSIGNMENT		45	3.5,3.10		2.1E —	8/15/93
		S — SYSTEM		40	3.5,3.10		2.1E —	8/15/93
		S — ZONE		32	3.5,3.10		2.1E —	8/15/93
SOURCE-FUEL-METER	SRC-FM	S — PLANT-ASSIGNMENT		45	3.7,3.10		2.1E —	8/15/93
		S — SYSTEM		40	3.7,3.10		2.1E —	8/15/93
		S — ZONE		32	3.7,3.10		2.1E —	8/15/93
SOURCE-LATENT	S-L	L — SPACE-CONDITIONS	2.21,F.6	16		III.49	2.0 —	2/15/79
SOURCE-SCHEDULE	S-SCH	L — SPACE-CONDITIONS	2.21,F.6	16				III.48

COMMAND or Keyword	Abbrev	Subprogram -- Command	DOE-2 Basics (2.1E)	BDL Summary (2.1E)	Supp (2.1E)	Ref Man (2.1A)	Program version	Year added
SOURCE-SENSIBLE	S-S	L - SPACE-CONDITIONS	2.21,F.6	16		III.49	2.0-	2/15/79
SOURCE-SITE-EFF	S-S-E	P - ENERGY-RESOURCE	4.16,F.17	58	4.5		2.0A-	6/15/79
SOURCE-TYPE	S-T	L - SPACE-CONDITIONS	2.20,F.6	16		III.47	2.0-	2/15/79
SPACE	S	L	2.2.2.24 F.7	18	1.5,2.89	III.94	2.0-	2/15/79
SPACE-CONDITIONS	S-C	L	2.2.2.15 F.6	16	2.81,2.86	III.42	2.0-	2/15/79
SPACE-CONDITIONS	S-C	L - SPACE	2.24	17		III.97	2.0-	2/15/79
SPACER-TYPE-CODE	S-H	L - GLASS-TYPE		13	2.113		2.1E -	8/15/93
SPECIFIC-HEAT	S-H	L - MATERIAL		11		III.73	2.0-	2/15/79
SSBASB		S - SUBR-FUNCTIONS		42	1.6		2.1D-	6/30/89
SSFCOR.		S - SUBR-FUNCTIONS		42	1.6		2.1D-	6/30/89
SS-FLOW-T-SCH	S-V-CST	S - ZONE-AIR		30	2.16		2.1C-	5/15/84
SS-VENT-CST	S-V-KW	S - ZONE-AIR		30	2.15		2.1C-	5/15/84
SS-VENT-KW	S-V-L-T	S - ZONE-AIR		30	2.16		2.1C-	5/15/84
SS-VENT-LIMIT-T	S-V-SCH	S - ZONE-AIR		30	2.15		2.1C-	5/15/84
SS-VENT-SCH	S-V-TEMP	S - ZONE-AIR		30	2.15		2.1C-	5/15/84
SS-VENT-TEMP	S-V-T-SCH	S - ZONE-AIR		30	2.15		2.1C-	5/15/84
SS-VENT-T-SCH	S-V-WND	S - ZONE-AIR		30	2.15		2.1C-	5/15/84
SS-VENT-WND								
STM-BOILER-HIR		P - PLANT-PARAMETERS	4.13,F.16	52		V.24,V.30	2.1-	5/15/80
STM-BOILER-HIR-FPLR		P - EQUIPMENT-QUAD		55	4.82	V.44,45	2.1-	5/15/80
STM-PRES		P - PLANT-PARAMETERS		54		V.25,V.32	2.0-	2/15/79
STM-SATURATION-T		P - PLANT-PARAMETERS		54		V.25,V.32	2.0-	2/15/79
STOP	L		F.19	27,46, 60,61		II.35	2.0-	2/15/79
STURB-ENTH-FPIX		P - EQUIPMENT-QUAD		56			2.1C-	5/15/84
STURB-EXH-PRES		P - PLANT-PARAMETERS		54		V.24,V.31	2.0-	2/15/79
STURB-I/O-FPLR		P - EQUIPMENT-QUAD		56	4.83	V.44,47	2.1-	5/15/80
STURB-MECH-EFF		P - PLANT-PARAMETERS		54			2.1C-	5/15/84

•COMMAND or Keyword	Abbrev	Subprogram -- Command	DOE-2 Basics (2.1E)	BDL Summary (2.1E)	Supp (2.1E)	Ref Man (2.1A)	Program version	Year added
STURB-PRES		P -- PLANT-PARAMETERS		54		V.24, V.32	2.0--2/15/79	
STURB-T		P -- PLANT-PARAMETERS		54		V.25, V.32	2.0--2/15/79	
STURB-WTR-RETURN		P -- PLANT-PARAMETERS		54		V.25, V.32	2.0--2/15/79	
SUMMARY	S	E -- ECONOMICS-REPORT L -- LOADS-REPORT P -- PLANT-REPORT S -- SYSTEMS-REPORT	5.19,F.18 2.34,F.9 4.17 3.94,F.14	61 25 58 46		VI.12 III.123 V.100 IV.269	2.0--2/15/79 2.0--2/15/79 2.0--2/15/79 2.0--2/15/79	
•SUBR-FUNCTIONS		S		42	1.6			
SUM-1		S -- SUBR-FUNCTIONS		42	1.6		2.1D--6/30/89	
SUM-2Z		S -- SUBR-FUNCTIONS		42	1.6		2.1D--6/30/89	
SUM-3Z		S -- SUBR-FUNCTIONS		42	1.6		2.1D--6/30/89	
SUM-4Z		S -- SUBR-FUNCTIONS		42	1.6		2.1D--6/30/89	
SUM-5		S -- SUBR-FUNCTIONS		42	1.6		2.1D--6/30/89	
SUNSPACE	SUNSP	L -- SPACE-CONDITIONS		17	2.6		2.1C--5/15/84	
SUN-CTRL-PROB	S-C-P	L -- WINDOW		21	2.62		2.1B--1/15/83	
SUPP-ELEC-METER	SUPP-EM	S -- PLANT-ASSIGNMENT		45	3.6,3.10		2.1E -- 8/15/93	
		S -- SYSTEM		40	3.6,3.10		2.1E -- 8/15/93	
		S -- ZONE		32	3.6,3.10		2.1E -- 8/15/93	
SUPP-FUEL-METER	SUPP-FM	S -- PLANT-ASSIGNMENT		45	3.7,3.10		2.1E -- 8/15/93	
		S -- SYSTEM		40	3.7,3.10		2.1E -- 8/15/93	
		S -- ZONE		32	3.7,3.10		2.1E -- 8/15/93	
SUPPLY-1	S-1	P -- HEAT-RECOVERY	4.15,F.17	56		V.66	2.0--2/15/79	
SUPPLY-2	S-2	P -- HEAT-RECOVERY	4.15,F.17	56		V.66	2.0--2/15/79	
SUPPLY-5	S-5	P -- HEAT-RECOVERY	4.15,F.17	56		V.66	2.0--2/15/79	
SUPPLY-CFM	S-CFM	S -- SYSTEM-AIR	3.79,F.12	33	3.65,3.122	IV.213	2.0--2/15/79	
SUPPLY-DELTA-T	SUP-D-T	S -- SYSTEM-FANS	3.85,F.12	34	3.25,3.74	IV.223	2.1--5/15/80	
SUPPLY-EFF	S-E	S -- SYSTEM-FANS		34		IV.225	2.0--2/15/79	
SUPPLY-HI	S-H	S -- DAY-RESET-SCH	3.64,F.10	29		IV.176	2.0--2/15/79	
SUPPLY-KW	S-KW	S -- SYSTEM-FANS	3.85,F.12	34	3.25	IV.224	2.1--5/15/80	
SUPPLY-LO	S-L	S -- DAY-RESET-SCH	3.64,F.10	29		IV.177	2.0--2/15/79	

COMMAND or Keyword	Abbrev	Subprogram -- Command	DOE-2 Basics (2.1E)	BDL Summary (2.1E)	Supp (2.1E)	Ref Man (2.1A)	Program version	Year added
SUPPLY-MECH-EFF	S-M-E	S -- SYSTEM-FANS		34		IV.224	2.0-	2/15/79
SUPPLY-STATIC	S-S	S -- SYSTEM-FANS		34		IV.224	2.0-	2/15/79
SWITCH-CONTROL	L -- WINDOW	L -- WINDOW		22	2.120		2.1E --	8/15/93
SWITCH-SCH	L -- WINDOW	L -- WINDOW		22	2.120		2.1E --	8/15/93
SWITCH-SET-HI	L -- WINDOW	L -- WINDOW		22	2.120		2.1E --	8/15/93
SWITCH-SET-LO	L -- WINDOW	L -- WINDOW		22	2.120		2.1E --	8/15/93
SYSTEM	SYST	S	3.63,3.88 F.13	39	2.83	IV.18,257	2.0-	2/15/79
SYSTEM-AIR	S-A	S	3.63,3.79 F.12	33		IV.213	2.0-	2/15/79
SYSTEM-AIR	S-A	S -- SYSTEM	3.88	39		IV.259	2.0-	2/15/79
SYSTEM-CONTROL	S-C	S	3.63,3.74 F.12	33		IV.203	2.0-	2/15/79
SYSTEM-CONTROL	S-C	S -- SYSTEM	3.88	39		IV.18,258	2.0-	2/15/79
SYSTEM-EQUIPMENT	S-EQ	S	3.43	37		IV.237	2.1-	5/15/80
SYSTEM-EQUIPMENT	S-EQ	S -- SYSTEM		39		IV.259	2.1-	5/15/80
SYSTEM-FANS	S-FANS	S	3.63,3.84 F.12	34		IV.18,221	2.0-	2/15/79
SYSTEM-FANS	S-FANS	S -- SYSTEM	3.88	39		IV.18,259	2.0-	2/15/79
SYSTEM-FLUID	S-FLU	S	3.63	35		IV.234	2.0-	2/15/79
SYSTEM-FLUID	S-FLU	S -- SYSTEM	F.13	39		IV.259	2.0-	2/15/79
SYSTEM-NAMES	S-N	S -- PLANT-ASSIGNMENT	3.92,F.13	43		IV.267	2.0-	2/15/79
SYSTEM-REPORTS	S-N	S -- SYSTEM		39			2.1E--	8/15/93
SYSTEM-TERMINAL	S-T	S	3.63	35		IV.231	2.0-	2/15/79
SYSTEM-TERMINAL	S-T	S -- SYSTEM		39		IV.259	2.0-	2/15/79
SYSTEM-TYPE	S-TYPE	S -- SYSTEM	3.88,F.13	39		IV.18,257	2.0-	2/15/79
SYSTEMS-REPORT	S-R	S	3.63,3.94 F.14	46		IV.269	2.0-	2/15/79
SZCI-0		S -- SUBR-FUNCTIONS		42	1.6		2.1D-	6/30/89
SZCI-1Z		S -- SUBR-FUNCTIONS		42	1.6		2.1D-	6/30/89

COMMAND or Keyword	Abbrev	Subprogram - Command	DOE-2 Basics (2.1E)	BDL Summary (2.1E)	Supp (2.1E)	Ref Man (2.1A)	Program version	Year added
SZCI-2		S - SUBR-FUNCTIONS		42	1.6		2.1D-	6/30/89
T8PL-FWB1WB6	TPL-FWB	S - SYSTEM-EQUIPMENT		37	3.71,3.72		2.1D-	6/30/89
T8-FWB1WB6	T-FWB	S - SYSTEM-EQUIPMENT		37	3.71,3.72		2.1D-	6/30/89
TABLE		LS - ASSIGN			1.9		2.1D-	6/30/89
TASK-ELEC-METER	TASK-EM	S - PLANT-ASSIGNMENT		44	3.4,3.10		2.1E -	8/15/93
		S - SYSTEM		40	3.4,3.10		2.1E -	8/15/93
		S - ZONE		32	3.4,3.10		2.1E -	8/15/93
TASK-LIGHTING-KW	T-L-KW	L - SPACE-CONDITIONS	2.19,F.6	16		III.46	2.0-	2/15/79
TASK-LIGHT-SCH	T-L-SCH	L - SPACE-CONDITIONS	2.19,F.6	16		III.46	2.0-	2/15/79
TASK-LT-W/SQFT	T-L-W	L - SPACE-CONDITIONS	2.19,F.6	16		III.46	2.0-	2/15/79
TC-CHLR-CAP-FT		P - EQUIPMENT-QUAD		56		V.44,45	2.1A-	5/15/81
TDVPIU-0		S - SUBR-FUNCTIONS		42	1.6		2.1D-	6/30/89
TDVPIU-1		S - SUBR-FUNCTIONS		42	1.6		2.1D-	6/30/89
TEMDEV-0		S - SUBR-FUNCTIONS		42	1.6		2.1D-	6/30/89
TEMDEV-1		S - SUBR-FUNCTIONS		42	1.6		2.1D-	6/30/89
TEMDEV-2		S - SUBR-FUNCTIONS		42	1.6		2.1D-	6/30/89
TEMDEV-3		S - SUBR-FUNCTIONS		42	1.6		2.1D-	6/30/89
TEMPERATURE	T	L - SPACE-CONDITIONS	2.16,F.6	16		III.43	2.0-	2/15/79
TERMINAL-TYPE	TER-TYPE	S - ZONE	3.71	31	3.19		2.1C-	5/15/84
TERRAIN-PAR1	T-P1	L - BUILDING-LOCATION		8	2.87,3.123		2.1B-	1/15/83
TERRAIN-PAR2	T-P2	L - BUILDING-LOCATION		8	2.87,3.123		2.1B-	1/15/83
TES-PRIORITY		P - PLANT-PARAMETERS		52	4.16		2.1E -	8/15/93
TES-TYPE		P - PLANT-PARAMETERS		52	4.15		2.1E -	8/15/93
THERMOSTAT-TYPE	T-TYPE	S - ZONE-CONTROL	3.68,F.10	29		IV.18,195	2.0-	2/15/79
THICKNESS	TH	L - LAYERS	2.8,F.5	11		III.77	2.0-	2/15/79
		L - MATERIAL		11		III.73	2.0-	2/15/79
THROTTLING-RANGE	T-R	S - ZONE-CONTROL	3.68,F.10	29	3.21,3.116	IV.18,196	2.0-	2/15/79
		L - BUILDING-SHADE		14		III.35	2.0-	2/15/79
TILT		L - EXTERIOR-WALL or ROOF	2.26,F.7	19		III.102	2.0-	2/15/79



•COMMAND or Keyword	Abbrev	Subprogram -- Command	DOE-2 Basics (2.1E)	BDL Summary (2.1E)	Supp (2.1E)	Ref Man (2.1A)	Program version	Year added	
		L -- FIXED-SHADE		14			2.1B--	1/15/83	
		L -- INTERIOR-WALL		24		III.115	2.1--	5/15/80	
		L -- TROMBE-WALL-V or -NV		20			2.1B--	1/15/83	
		L -- UNDERGROUND-WALL or -FLOOR		26		III.120	2.1--	5/15/80	
TIME-ZONE	T-Z	L -- BUILDING-LOCATION	2.4,F.3	8		III.30	2.0--	2/15/79	
•TITLE		LSPE	2.2,3.63, 4.7,F.3, F.10,F.15, F.18	7,29, 47,61		II.19,V.8 II.19,V.8	2.0--	2/15/79 2.0--	2/15/79
TOU-SEASON-LINKS	TOU-LINK	E -- BLOCK-CHARGE	5.7,F.18	59	5.19		2.1E --	8/15/93	
TRANSMITTANCE	TR	L -- BUILDING-SHADE L -- FIXED-SHADE		14 14		III.35	2.0-- 2.1B--	2/15/79 1/15/83	
•TROMBE-WALL-NV	T-W-NV	L		21	2.70		2.1B--	1/15/83	
•TROMBE-WALL-V	T-W-V	L		21	2.70		2.1B--	1/15/83	
TROM-VENT-SCH	T-V-SCH	S -- ZONE		31	2.71		2.1B--	1/15/83	
TSOLVE-0		S -- SUBR-FUNCTIONS		42	1.6		2.1D--	6/30/89	
TSOLVE-1		S -- SUBR-FUNCTIONS		42	1.6		2.1D--	6/30/89	
TWR-APP-FRFRACT		S -- SYSTEM-EQUIPMENT		37	3.11,3.109		2.1C--	5/15/84	
TWR-CAP-CTRL		S -- PLANT-ASSIGNMENT	4.12,F.16	43	3.38,3.87		2.1E --	8/15/93	
TWR-CELL-CTRL		P -- PLANT-PARAMETERS		53	4.41		2.1E --	8/15/93	
TWR-CELL-MAX-GPM		S -- PLANT-ASSIGNMENT		43	3.38,3.87		2.1E --	8/15/93	
TWR-CELL-MIN-GPM		S -- PLANT-ASSIGNMENT		43	3.40,3.91		2.1E --	8/15/93	
TWR-DESIGN-APPRO		S -- PLANT-ASSIGNMENT		43	3.40,3.91		2.1E --	8/15/93	
TWR-DESIGN-RANGE		P -- PLANT-PARAMETERS		53	4.39		2.1E --	8/15/93	
TWR-DESIGN-WETBU		P -- PLANT-PARAMETERS	F.16	53	4.39	V.23,V.28	2.1E --	8/15/93	
TWR-EIR		S -- PLANT-ASSIGNMENT	4.12	43	3.40,3.89		2.1E --	8/15/93	
TWR-FAN-FPLR		S -- PLANT-ASSIGNMENT		43	3.36,3.85		2.1E --	8/15/93	
		S -- PLANT-ASSIGNMENT		43	3.40,3.89		2.1E --	8/15/93	
		P -- EQUIPMENT-QUAD		55	4.44,4.82		2.1E --	8/15/93	

•COMMAND or Keyword	Abbrev	Subprogram — Command	DOE-2 Basics (2.1E)	BDL Summary (2.1E)	Supp (2.1E)	Ref Man (2.1A)	Program version	Year added
TWR-FAN-LOW-CFM		P — PLANT-PARAMETERS S — PLANT-ASSIGNMENT		53 43	4.41 3.39	V.24, V.28	2.1— 5/15/80 2.1E — 8/15/93	
TWR-FAN-LOW-ELEC		P — PLANT-PARAMETERS S — PLANT-ASSIGNMENT		53 43	4.41 3.39,3.88	V.24, V.28	2.1— 5/15/80 2.1E — 8/15/93	
TWR-FAN-OFF-CFM		P — PLANT-PARAMETERS S — PLANT-ASSIGNMENT		53 43	4.41 3.39,3.88	V.24, V.28	2.1— 5/15/80 2.1E — 8/15/93	
TWR-GPM-FRA		S — PLANT-ASSIGNMENT		43	3.40,3.89		2.1E — 8/15/93	
TWR-GPM-FWB		P — EQUIPMENT-QUAD		55	4.44,4.82		2.1E — 8/15/93	
TWR-IMPELLER-EFF		S — PLANT-ASSIGNMENT P — EQUIPMENT-QUAD		43 55	3.41,3.92 4.44,4.82		2.1E — 8/15/93 2.1E — 8/15/93	
TWR-MIN-FAN-SPEED		S — PLANT-ASSIGNMENT P — PLANT-PARAMETERS		53 43	4.42 3.39,3.88	V.24, V.28	2.1— 5/15/80 2.1E — 8/15/93	
TWR-MOTOR-EFF		P — PLANT-PARAMETERS S — PLANT-ASSIGNMENT		53 43	4.42 3.39	V.24, V.28	2.1— 5/15/80 2.1E — 8/15/93	
TWR-NUM-CELLS		S — PLANT-ASSIGNMENT		43	3.36,3.85		2.1E — 8/15/93	
TWR-PUMP-HEAD		P — PLANT-PARAMETERS S — PLANT-ASSIGNMENT	F.16 4.12	53 43	4.42 3.39,3.88	V.24, V.28	2.1— 5/15/80 2.1E — 8/15/93	
TWR-RESET-RATIO		S — PLANT-ASSIGNMENT P — PLANT-PARAMETERS		43 53	3.38,3.87		2.1E — 8/15/93 2.1E — 8/15/93	
TWR-SCH		S — PLANT-ASSIGNMENT		43	3.36		2.1E — 8/15/93	
TWR-SETPT-CTRL		S — PLANT-ASSIGNMENT P — PLANT-PARAMETERS	4.12,F.16	43 53	3.37,3.86 4.39		2.1E — 8/15/93 2.1E — 8/15/93	
TWR-SETPT-SCH		S — PLANT-ASSIGNMENT		43	3.37,3.86		2.1E — 8/15/93	
TWR-SETPT-T		S — PLANT-ASSIGNMENT P — PLANT-PARAMETERS	4.12 F.16	43 53	3.37,3.86 3.36,3.85		2.1E — 8/15/93 2.1E — 8/15/93	
TWR-SIZE		S — PLANT-ASSIGNMENT		43	3.36,3.85		2.1E — 8/15/93	
TWR-TYPE		S — PLANT-ASSIGNMENT		43	3.36,3.87		2.1E — 8/15/93	
TWR-THROTTLE		S — PLANT-ASSIGNMENT P — PLANT-PARAMETERS		43 53	3.37,3.86 4.40		2.1E — 8/15/93 2.1E — 8/15/93	
TWR-SETPT-T		P — PLANT-PARAMETERS		53	4.40	V.24, V.29	2.1— 5/15/80	

•COMMAND or Keyword	Abbrev	Subprogram — Command	DOE-2 Basics (2.1E)	BDL Summary (2.1E)	Supp (2.1E)	Ref Man (2.1A)	Program version	Year added
TYPE								
U-EFFECTIVE	U-EFF	L — UNDERGROUND-WALL or -FLOOR		25		III.120	2.1A—	5/15/81
•UNDERGROUND-WALL or -FLOOR	U-W U-F	L	2.2.2.33 F.7	25		III.69,III.118	2.0—	2/15/79
UNIT-0		S — SUBR-FUNCTIONS		42	1.6		2.1D—	6/30/89
UNIT-1Z		S — SUBR-FUNCTIONS		42	1.6		2.1D—	6/30/89
UNIT-2Z		S — SUBR-FUNCTIONS		42	1.6		2.1D—	6/30/89
UNIT-3		S — SUBR-FUNCTIONS		42	1.6		2.1D—	6/30/89
UNITV-0		S — SUBR-FUNCTIONS		42	1.6		2.1D—	6/30/89
UNITV-1Z		S — SUBR-FUNCTIONS		42	1.6		2.1D—	6/30/89
UNITV-2		S — SUBR-FUNCTIONS		42	1.6		2.1D—	6/30/89
UNIT-AUX-KW	U-A-KW	S — SYSTEM-EQUIPMENT		3	382		2.1E —	8/15/93
UNIT-PUMP-ELEC	U-P-ELEC	S — SYSTEM-EQUIPMENT		38	3.52		2.1E —	8/15/93
UNIT-NAME	U-N	E — COMPONENT-COST P — ENERGY-RESOURCE		61		VI.6	2.0—	2/15/79
UNIT-SRCHG-DATA	UNIT-CHG	E — UTILITY-RATE		58	4.6,4.7		2.1E —	8/15/93
UNIT-TAX-DATA	UNIT-TX	E — UTILITY-RATE		60	5.14		2.1E —	8/15/93
UPPER-VENT-AREA	U-V-A	L — WALL-PARAMETERS		60	5.13		2.1E —	8/15/93
USE-MIN-QUALS	U-M-Q	E — UTILITY-RATE		15	2.12,2.71		2.1B—	1/15/83
•UTILITY-RATE	E	E	5.1.5.2 F.18	60	5.10		2.1E —	8/15/93
U-VALUE	U	L — CONSTRUCTION	2.9.F.5	11	5.3,5.6	III.80	2.1E—	8/15/93
VARIABLE-LIST	V-L	LSPE — REPORT-BLOCK		25,46,58	1.29	III.130,	2.0—	2/15/79

•COMMAND or Keyword	Abbrev	Subprogram — Command	DOE-2 Basics (2.1E)	BDL Summary (2.1E)	Supp (2.1E)	Ref Man (2.1A)	Program version	Year added
VARIABLE-TYPE	V-T	LSPE — REPORT-BLOCK		26,46,60	1.29	IV.275, IV.105	2.0—	2/15/79
VARVOL-0		S — SUBR-FUNCTIONS		42	1.6		2.1D—	6/30/89
VARVOL-1Z		S — SUBR-FUNCTIONS		42	1.6		2.1D—	6/30/89
VARVOL-2		S — SUBR-FUNCTIONS		42	1.6		2.1D—	6/30/89
VARVOL-3		S — SUBR-FUNCTIONS		42	1.6		2.1D—	6/30/89
VENT-ELEC-METER	VENT-EM	S — PLANT-ASSIGNMENT		45	3.6,3.10		2.1E —	8/15/93
		S — SYSTEM		40	3.6,3.10		2.1E —	8/15/93
		S — ZONE		32	3.6,3.10		2.1E —	8/15/93
VENT-METHOD	V-M	S — SYSTEM-AIR		33	3.33,3.122		2.1D—	6/30/89
VENT-TEMP-SCH	V-T-SCH	S — SYSTEM-AIR	3.81,F.12	33	3.20,3.34 3.125	IV.217	2.1—	5/15/80
VERIFICATION	V	S — SYSTEM-FANS		61	3.116		2.1E—	8/15/93
		E — ECONOMICS-REPORT	5.19,F.18	25		VI.12	2.0—	2/15/79
		L — LOADS-REPORT	2.34,F.9	58		III.123	2.0—	2/15/79
		P — PLANT-REPORT	4.17	46		V.100	2.0—	2/15/79
		S — SYSTEMS-REPORT	3.94	15		IV.269	2.0—	2/15/79
VERT-VENT-SEP	V-V-S	L — WALL-PARAMETERS		17	2.12,2.71		2.1B—	1/15/83
VIEW-AZIMUTH	V-AZ	L — SPACE-CONDITIONS		13	2.57		2.1B—	1/15/83
VIS-TRANS	V-T	L — GLASS-TYPE		21	2.53		2.1B—	1/15/83
VIS-TRANS-SCH	V-T-SCH	L — WINDOW		18	2.61,2.69		2.1B—	1/15/83
VOLUME	V	L — SPACE	2.24,F.7	15		III.97	2.0—	2/15/79
•WALL-PARAMETERS	W-P	L		15	2.10,2.71		2.1B—	1/15/83
WALL-PARAMETERS	W-P	L — CONSTRUCTION		11			2.1B—	1/15/83
WASTE-HEAT-USE	W-SCH	S — SYSTEM-EQUIPMENT		38	3.53		2.1E —	8/15/93
•WEEK-SCHEDULE	W-SCH	LSPE	2.2,3.63 F.4,F.10,	10,28, 47,59		II.27,V.8	2.0—	2/15/79

•COMMAND or Keyword	Abbrev	Subprogram -- Command	DOE-2 Basics (2.1E)	BDL Summary (2.1E)	Supp (2.1E)	Ref Man (2.1A)	Program version	Year added
•WEIGHTING-FACTOR			F.18					2.?-?
WEIGHTING-FACTOR	W-F	L -- SPACE-CONDITIONS		16		III.53	2.1-5/15/80	
WIDTH	W	L -- BUILDING-SHADE		14		III.35	2.0-2/15/79	
		L -- DOOR	2.31,F.9	23		III.110	2.1-5/15/80	
		L -- FIXED-SHADE		14			2.1B-1/15/83	
		L -- EXTERIOR-WALL or ROOF	2.25,F.7	19		III.102	2.0-2/15/79	
		L -- INTERIOR-WALL		24		III.113	2.1-5/15/80	
		L -- SPACE		18		III.97	2.0-2/15/79	
		L -- TROMBE-WALL-V or -NV		20			2.1B-1/15/83	
		L -- UNDERGROUND-WALL or -FLOOR		25		III.119	2.1-5/15/80	
•WINDOW	WI	L -- WINDOW	2.27,F.8	21	2.115	III.108	2.0-2/15/79	
		L	2.2,2.27 F.8	21	1.5,2.77, 2.115,2.119	III.107	2.0-2/15/79	
WINDOW-SPEC-FN		L -- WINDOW		21	1.5		2.1C-5/15/84	
WIND-DIR	W-D	L -- DESIGN-DAY		9		III.27	2.0-2/15/79	
WIND-SPEED	W-S	L -- DESIGN-DAY		9		III.27	2.0-2/15/79	
WIN-SHADE-TYPE	W-S-T	L -- WINDOW		21	2.61		2.1B-1/15/83	
WS-ECONO		S -- SYSTEM-CONTROL		33	3.84		2.1E -- 8/15/93	
WS-ECONO-MIN-DT		S -- SYSTEM-CONTROL		33	3.84		2.1E -- 8/15/93	
WS-ECONO-XEFF		S -- SYSTEM-EQUIPMENT		36	3.84		2.1E -- 8/15/93	
WS-HEIGHT	W-H	L -- BUILDING-LOCATION		8	2.87,3.123		2.1B-1/15/83	
WS-HEIGHT-LIST	W-H-L	L -- BUILDING-LOCATION		8			2.1D-6/30/89	
WS-TERRAIN-PAR1	W-T-P1	L -- BUILDING-LOCATION		8	2.87,3.123		2.1B-1/15/83	
WS-TERRAIN-PAR2	W-T-P2	L -- BUILDING-LOCATION		8	2.87,3.123		2.1B-1/15/83	
X		L -- BUILDING-SHADE		14		III.35	2.0-2/15/79	
		L -- DOOR		23		III.110	2.1-5/15/80	
		L -- EXTERIOR-WALL or ROOF		19		III.102	2.0-2/15/79	
		L -- INTERIOR-WALL		24	2.7		2.1C-5/15/84	
		L -- SPACE		18		III.97	2.0-2/15/79	
		L -- TROMBE-WALL-V or -NV		20			2.1B-1/15/83	