

# Lawrence Berkeley National Laboratory

## Lawrence Berkeley National Laboratory

### **Title**

Software-Based Challenges of Developing the Future Distribution Grid

### **Permalink**

<https://escholarship.org/uc/item/7sx305hk>

### **Author**

Stewart, Emma

### **Publication Date**

2014-06-01



# ERNEST ORLANDO LAWRENCE BERKELEY NATIONAL LABORATORY

---

## Software-Based Challenges of Developing the Future Distribution Grid

Emma M. Stewart  
Sila Kiliccote  
Charles McParland

Affiliation:

Lawrence Berkeley National Laboratories  
Environmental Energy Technologies Division  
Berkeley, CA

June 2014

This work was funded by the U.S. Department of Energy's Advanced Research Projects Agency-Energy (ARPA-E), under Contract No. DE-AC02-05CH11231.

## **Disclaimer**

This document was prepared as an account of work sponsored by the United States Government. While this document is believed to contain correct information, neither the United States Government nor any agency thereof, nor The Regents of the University of California, nor any of their employees, makes any warranty, express or implied, or assumes any legal responsibility for the accuracy, completeness, or usefulness of any information, apparatus, product, or process disclosed, or represents that its use would not infringe privately owned rights. Reference herein to any specific commercial product, process, or service by its trade name, trademark, manufacturer, or otherwise, does not necessarily constitute or imply its endorsement, recommendation, or favoring by the United States Government or any agency thereof, or The Regents of the University of California. The views and opinions of authors expressed herein do not necessarily state or reflect those of the United States Government or any agency thereof or The Regents of the University of California.

## **Acknowledgements**

The authors would like to thank the ARPA-E project team for their contributions including Alexandra von Meier, and Reza Argandeh of CIEE, and Josh Gould, Timothy Heidel and Colin Schauder (ARPA-E) for their review and updates. We also wish to thank Nan Wishner for her patience and technical editing.

## Abstract

The software that the utility industry currently uses may be insufficient to analyze the distribution grid as it rapidly modernizes to include active resources such as distributed generation, switch and voltage control, automation, and increasingly complex loads. Although planners and operators have traditionally viewed the distribution grid as a passive load, utilities and consultants increasingly need enhanced analysis that incorporates active distribution grid loads in order to ensure grid reliability. Numerous commercial and open-source tools are available for analyzing distribution grid systems. These tools vary in complexity from providing basic load-flow and capacity analysis under steady-state conditions to time-series analysis and even geographical representations of dynamic and transient events. The need for each type of analysis is not well understood in the industry, nor are the reasons that distribution analysis requires different techniques and tools both from those now available and from those used for transmission analysis. In addition, there is limited understanding of basic capability of the tools and how they should be practically applied to the evolving distribution system. The study reviews the features and state of the art capability of current tools, including usability and visualization, basic analysis functionality, advanced analysis including inverters, and renewable generation and load modeling. We also discuss the need for each type of distribution grid system analysis. In addition to reviewing basic functionality current models, we discuss dynamics and transient simulation in detail and draw conclusions about existing software's ability to address the needs of the future distribution grid as well as the barriers to modernization of the distribution grid that are posed by the current state of software and model development. Among our conclusions are that accuracy, data transfer, and data processing abilities are key to future distribution grid modeling, and measured data sources are a key missing element. Modeling tools need to be calibrated based on measured grid data to validate their output in varied conditions such as high renewables penetration and rapidly changing topology. In addition, establishing a standardized data modeling format would enable users to transfer data among tools to take advantage of different analysis features.

# Table of Contents

Abstract.....	3
Table of Contents .....	4
Acronyms.....	5
1 Introduction and Background.....	6
2 Why Transmission Planning Tools Cannot Be used for Distribution Planning, Modeling, and Analysis.....	9
3 Measured data sources in the future distribution grid.....	12
4 Review of Distribution Grid Planning and Analysis Tools.....	14
4.1 Graphical User Interfaces, Visualization, and Results Presentation.....	14
4.1.1 Graphical User Interfaces .....	15
4.1.2 Visualization of Grid Data.....	16
4.1.3 Results Presentation.....	19
4.1.4 Summary of Graphical User Interfaces, Visualization, and Results Presentation Review.....	21
4.2 Basic Analysis Capabilities.....	22
4.2.1 Steady-State Analysis .....	22
4.2.2 Time-Series Analysis .....	23
4.2.3 Fault-Current and Short-Circuit Analysis.....	25
4.2.4 Dynamic Analysis .....	27
4.2.5 Transient Analysis.....	28
4.2.6 Summary of Software Tools' Basic Functionality .....	28
4.3 Advanced Criteria for Evaluating Tools' Capabilities to Analyze the Future Distribution Grid .....	29
4.3.1 Inverter, Load, and Distributed Energy Resource Modeling.....	29
4.3.2 Data-Processing Capability .....	39
5 Accuracy in Distribution Modeling.....	43
5.1 Input Data Errors.....	44
5.1.1 Geographic Information System Data Errors.....	44
5.1.2 Switching and Topology Errors .....	46
5.1.3 Customer and Load Databases .....	46
5.2 Data-Transfer Errors.....	47
5.3 Solutions to Accuracy Barriers .....	50
5.3.1 Model Validation.....	50
5.3.2 Data Source Validation.....	53
5.3.3 Common Information Model.....	53
6 Summary and Conclusions .....	55
References.....	58

## Acronyms

AC	alternating current
AMI	advanced metering infrastructure
ANSI	American National Standards Institute
CIM	common information model
DER	distributed energy resources
DG	distributed generation
DR	demand response
EPRI	Electric Power Research Institute
EV	electric vehicle
FIDVR	fault-induced delayed voltage recovery
GB	gigabyte
GHz	gigahertz
GIS	geographic information system
GUI	graphical user interface
IEC	International Electrotechnical Commission
IEEE	Institute of Electrical and Electronics Engineers
KVAR	kilovolt-ampere reactive
kW	kilowatt
NREL	National Renewable Energy Laboratory
OLTC	on-load tap changer
PV	photovoltaic
RAM	random access memory
SCADA	supervisory control and acquisition data
ZIP model	impedance, current, and power model
WECC	Western Electricity Coordinating Council

# 1 Introduction and Background

The distribution grid was planned to deliver energy reliably and efficiently from the transmission grid to customers. For many years, the transmission system has been planned based on capacity and stability studies by tools that model the distribution grid as a simple load, omitting its details and physical components. However, the distribution grid is evolving into an active resource with complex modeling needs. Within the next 10 years, the distribution grid could contain a complex mix of load, generation, and automated resources all operating on different time scales. With the growth of distributed generation (DG) and demand response (DR), the need is growing for real-time monitoring and quasi- real-time planning analysis of the distribution grid.

DG can include both grid-level and customer photovoltaics (PV) as well as other localized generation such as fuel cells and electric vehicles (EVs), and energy storage, e.g., batteries. The distribution grid will likely have more complex control and visualization needs in the future, such as automated switching and reconfiguration as well as voltage control through new localized and generation-based devices rather than traditional capacitors and regulators. There will also be an increase in measured data sources, such as advanced metering infrastructure (AMI), distribution synchrophasors, and advanced line sensors. However, measured data will only be useful if it can be interpreted and utilized effectively in combination with planning tools, which will require new forms of data management and education of tool users.

This report reviews and discusses the future of planning tools to address the modernized distribution system, including the need for measured data and validated models that accurately represent impedances and loads. Barriers affecting operational tools as well as data availability barriers are closely linked to the subject of this report and are addressed in a separate report *“Using micro-synchrophasor data for advanced planning and operations applications”*. The current report covers distribution grid planning software issues; the uPMU report discusses the applicability and availability of high-fidelity measured data for existing state estimation and operational analysis tools.

Distribution planning tools were developed in response to a need for efficient analysis and digitization of data. Most tools assume and short-time-scale (minutes and hours rather than months ahead) control characteristics and one-way power flow without high penetration of

renewables. The future distribution grid will require longer-term advance planning and entail two-way power flows.

The current approach to distribution grid planning software development is a combination of accommodating detailed models and approximating representations of key components, such as inverters and loads. This is not an integrated approach and thus cannot address all needs of the future grid. Although some advanced analysis tools have been developed, current tools are in a rudimentary stage relative to the analysis required for a modernized grid. Moreover, the capabilities and appropriate use of these tools for distribution planning are not well understood.

As the distribution system modernizes, time scales of analysis for planning and operations are becoming closer. Whereas in the past planning was more long term and operations were more short term in their time horizons, planning analysis is required faster and operations need to consider longer term issues. As the distribution system becomes an active resource, the number of components on the system increases, which in turn increases the number of unknowns and thus the potential for error in system models. Data errors data are prevalent in the distribution system, leading to a lack of confidence in analysis and operations. This creates a reluctance to undertake advanced grid analysis simulations. The data errors could for example take the form of geographical mistakes, modeling representations of components incorrectly or electrical connectivity issues.

From a planning analysis standpoint, there are numerous barriers to modernization of the distribution grid:

- Lack of reliable data and model validation
- Need (and cost) to purchase multiple, sometimes overlapping software tools to perform different analyses or work with data in different proprietary formats
- Lack of models that address inverters, loads, and distributed energy resources (DER)
- Lack of integrated system modeling and data processing
- Lack of communication and data transfer capability among models

New requirements on the electricity grid require striking a balance between legacy equipment and integration of new technology. The future grid will contain a mix of controllable and non-controllable resources that are both distributed and centralized; the common practice of



aggregating system elements to perform efficient impact analyses will become an increasingly complex as a result. For aging infrastructure and existing control schemes to accommodate distribution grid developments will require significant operational and technical changes. Currently, functional operations requirements and response schemes for the new technology mix are largely undeveloped. Because it is not currently possible to simulate conditions that may occur on the future distribution grid, it is not possible to plan for them.

This report examines the need for tools to perform various types of distribution grid analysis, problems with the accuracy of grid data, potential solutions for these problems, and the key types of analysis that will be required for a modernized distribution grid.

The remainder of this report is structured as follows;

*Section 2* discusses the differences between transmission and distribution planning and analysis and why traditional transmission planning software does not work for distribution

*Section 3* reviews the measured data sources in the current and the future modernized distribution grid.

*Section 4* reviews types of power systems analysis that are specific to the distribution grid.

*Section 5* discusses software barriers to the modernized grid, including issues related to the accuracy and validation of models.

## **2 Why Transmission Planning Tools Cannot Be used for Distribution Planning, Modeling, and Analysis**

It is often assumed that transmission planning tools can be applied to the distribution grid. In this section, we discuss the key differences between the transmission and distribution grid and the reasons that transmission planning tools are not applicable to the distribution grid.

Transmission planning analysis focuses on the overall capacity of the transmission and generation system and its ability meet loads. Some key features of transmission planning are active power balance and frequency stability, reactive power balance and voltage stability, and angular generator stability. Generation dispatch is a key element of transmission analysis because rotating supply is the most influential factor for transmission system stability. Dispatch order and scenarios are determined through software packages such as PPLUS (P Plus Corporation 2013) for economic dispatch and communicated to transmission planning for capacity and contingency analysis using tools such as PSS/E and PSLF. Transmission system stability is calculated based on rotor angle (synchronous after a transient or short- time-scale disturbance), voltage, and frequency.

Distribution planning is focused on the design and maintenance of the steady state distribution grid. Planners will often conduct studies in designs of new line routes, and perform analyses on feeder loading, and voltage drops, phase balancing and determine alternative service arrangements for planned outages. Whereas ten years ago planners would rely on manual or spreadsheet calculations, geographical and distribution planning tools developed to automate and streamline those processes. As the active sources and loads have evolved on the distribution grid, the planning tools functionality has not moved at similar speed. Transient conditions are introduced and of concern now, and the three phase balanced positive sequence load flow approaches for solving these conditions are not applicable.

Transmission software has been pushed to apply to distribution scenarios, and distribution scenarios are being increasingly strained to fit transmission modeling approaches. Although applying transmission software might have been effective for modeling the passive distribution system (which could be assumed to be balanced), transmission software cannot model a distribution grid with a high penetration of active resources. New software is needed that contains specific distribution modeling features. These include modeling of both balanced and

unbalanced scenarios and of highly distributed load and control that encompasses DG, EVs, and DR. Dynamic models or characterization of these technologies is necessary.

A validated network model is the core of all distribution and transmission planning applications. For the distribution system, the model must represent many more features than for the transmission system. These features include single- and three-phase power as well as lines, equipment, regulators, and transformers. A validated model should be able to represent the system accurately and replicate responses to certain measured events. **Table 1** defines and compares the important electrical characteristics for distribution and transmission modeling.

**Table 1. Important Characteristics for Distribution and Transmission Modeling**

Feature	Transmission Electrical Characteristics	Distribution Electrical Characteristics
Overhead conductors	Impedance, kVA* rating	Spacing, phasing, height, conductor
Underground conductors	Impedance, kVA rating	Spacing, phasing, conductor/cable type, thickness
Conductor data	Geometric mean radius (GMR), diameter, resistance, ampacity, failure rate	GMR, diameter, resistance, ampacity, failure rate
Voltage regulators	Impedance, kVA rating, voltage rating, losses	Potential transformer ratios, current transformer ratios, compensator settings, R and X*
Transformers	Capacity, control schemes	KVA rating, voltage rating, impedance (R, X or %), iron core losses
Capacitors	Impedance, kVA rating	Capacity, phasing, control type
Switches		Type, capacity
Protection		Settings

\* kVA – kilovolt-ampere; KVAR – kilovolt-ampere reactive; R – Resistance (Ohms); X – Reactance (Ohms)

Construction details, such as conductor type and separation, are more important in distribution system modeling than in transmission system modeling, as is information about smaller equipment such as switches and fusing, which is not modeled in most transmission planning tools.

Distribution lines have low impedance ( $X/R$ ) (Reactance/Resistance in Ohms) ratios, and the fast decoupled Newton Raphson solver method employed in transmission planning packages does not accurately address distribution-line ratios. A standard approximation for facilitating power-flow calculations rests on the assumption that  $R$  is very small compared to  $X$ . For transmission lines, this is generally a good assumption. However, for distribution conductors,  $R$  tends to equal or exceed  $X$ . Physically this is because resistance scales as the inverse square of conductor diameter while line inductance depends on the ratio of phase spacing to conductor diameter and thus varies much less with scale. Because of this difference between the impedance of transmission and distribution lines, transmission software cannot accurately solve for distribution lines.

The technical differences in transmission and distribution structure mean that there are differences in the applicability of software to transmission and distribution modeling. To understand these differences, we look at two of the key transmission packages, PSS/E and PSLF. These are positive-sequence load-flow packages with advanced capability for dynamic analysis of the transmission system. Both were developed to include Western Electricity Coordinating Council (WECC)- approved and Institute of Electrical and Electronics Engineers (IEEE) standard models for all components that affect the steady-state and dynamic performance of the transmission system.

Dynamic performance is affected by generator performance, so transmission software models generator components, control, and time constants, including exciters, governors, and other elements that impact the disturbance response. Data are exchangeable between transmission formats, and both PSS/E and PSLF feature scripting options through either custom interfaces or Python. Each package can accommodate user-defined models for wind and PV or can use generic models.

Areas in which transmission software cannot accurately model the distribution system include the large number of nodes and devices on the distribution system. Transmission models limits the number of these elements, but the distribution system has more of these than the transmission system does. There is also poor convergence for radial distribution systems in transmission software, purely because of the volume of data. In addition, PSSE and PSLF model only three-phase-balanced systems. This does not accurately represent the current distribution system, and the discrepancy will become even greater as the distribution system becomes more dynamic.

Moving data between distribution and transmission planning software is another challenge. For example, in distribution modeling software, equipment is often located in the model as attached to a line section whereas in transmission equipment is attached to a bus. In addition, as noted above, distribution systems have many more nodes than transmission systems.

Finally, there is the issue of validating models. Transmission models have normally been verified by numerous sources, and many task forces have addressed the validation of transmission models (NERC 2012) There has been no comparable effort for the distribution system, and the absence of distribution data make such an effort problematic.

### **3 Measured data sources in the future distribution grid**

The future distribution grid will likely contain large numbers of DG units, including solar PV, and thus will require different control mechanisms and more complex analysis than is currently performed. As the distribution grid evolves to accommodate an increasing number of DG installations, the time scales of these sources will influence the development of features of distribution modeling tools from steady state (single point in time), to transient (sub-cycle). (See Section 4 for a discussion of these types of power system analysis). Possible data sources required in a future distribution grid scenario include (Martinez et. al. 2011):

- DR metering
- Smart metering and AMI
- Phasor measurement unit supervisory control and data acquisition (SCADA) data, line sensors, and distribution phasor measurement units
- Grid models and geographic information systems
- Inverter and DG component models
- Weather data
- Economic price signals

Each of these sources, like power systems themselves, has inherently different time scales of importance. For example, economic price signaling to DR could be on an hourly basis but could inform customer behavior and therefore load in short time steps following an economic decision. Weather data for forecasting of short-term variability is on the seconds-to-minutes scale. Grid and

component models require scales from sub-cycle to seconds to hours (**Figure 1**). Future distribution grid planning and management decisions will require knowledge on evolving grid conditions that is collected in many different time scales.

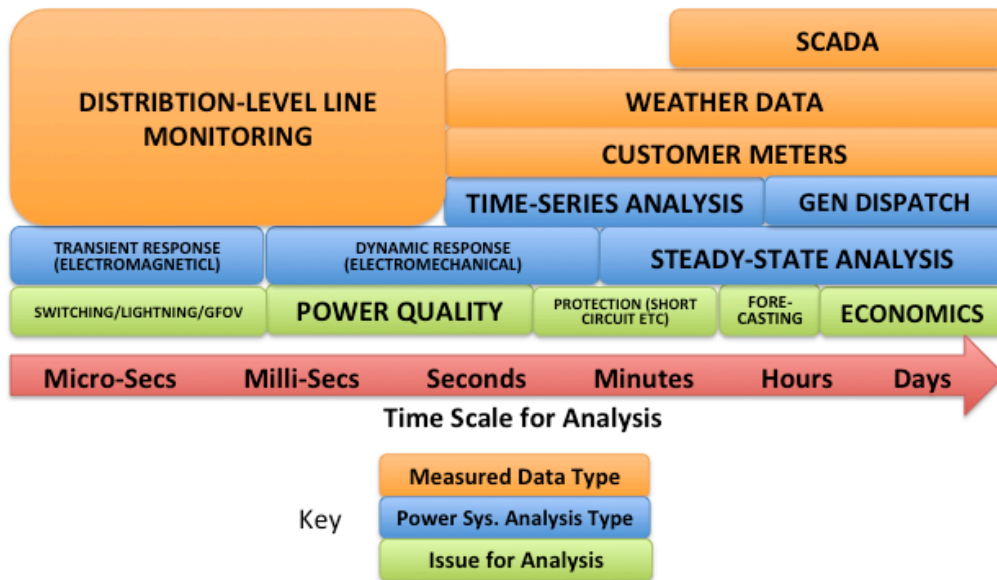

**Figure 1. The range of data requirements and time scales at utilities**

Data quality from these and future sources must improve from current standards, and model validation is an essential application of enhanced measured data. Data quality should be defined by the latency, accuracy, ease of use, and, most importantly, availability of the data. Distribution planners and operators must be accurately informed in a timely manner so that they can make valid choices in both the near and far term. Data quality will translate directly into power system model accuracy and will directly affect the quality of the results from distribution grid analysis tools.

## 4 Review of Distribution Grid Planning and Analysis Tools

Distribution grid tools must have basic functionality for some or all of the following analyses: steady state, time series, dynamic, protection, and transient. We review the basic functionality of the following commercially available distribution grid analysis tools:

- SynerGEE Electric (GL Noble Denton)
- CymDist (Cooper)
- PSS/Sincal (Siemens PTI)
- DigSilent Power Factory (DigSilent GMBH)
- DEW (EDD)

We also briefly discuss Gridlab-D (PNNL) and OpenDSS (EPRI) but do not focus on them.

We examine how the analysis time frames in each tool apply to new distribution grid functions such as renewables integration and distribution automation. We also look at usability in the areas of graphical user interface, data input and output, and results presentation. Accuracy generally depends on a tool's solver, the data entered, and the calibration of the model to the measured data.

Each of the tools reviewed is evaluated using the power systems analysis concepts listed above as well as for the tool's ability to address technological developments such as an increase in DG and improvements in visualization. Many distribution planning tools currently address specific issues, such as visualization of voltage or flow conditions, and most focus on the vendor's specific areas of expertise. A future approach will need to be more integrated, offering a range of analyses and expertise.

The goal of this report is primarily to evaluate commercially available tools that are or would be used in a distribution planning and engineering environments. Transmission planning tools PSSE (Siemens PTI) and PSLF (GE) are discussed primarily as a comparison to distribution modeling platforms.

### 4.1 Graphical User Interfaces, Visualization, and Results Presentation

Although the analysis packages contained in software are of primary importance, a software tool's value also depends on its usability, the quality of its presentation of results, and its

controllability in an external environment. Therefore, we begin by examining graphical user interfaces (GUIs), visualization, and results presentation in the tools.

### **4.1.1 Graphical User Interfaces**

The advanced functionality of distribution software is only meaningful if it is employed effectively and interpreted accurately by knowledgeable users. In a utility planning and operations environment, software that has a simple, easily controlled user interface and requires little user manipulation is desirable. Most of the commercially available packages reviewed have an effective GUI. Open-source packages, such as GridLab-D and OpenDSS, although analytically powerful and highly customizable, have no GUI commercially available.

One essential feature of GUIs in tools used to analyze the modernized distribution grid will be ease of input and access to data from the growing numbers of distribution grid data sources, to enable use and analysis of these data to the greatest possible degree of fidelity as well as to ensure accurate presentation and interpretation of results. The transfer of data from the geographic information system (GIS) or planning environment used in current distribution analysis tools is typically cumbersome. User understanding of the analysis tool behind the interface will also be essential for accessing and inputting these data in the future. Another key element of future GUIs will be ease of ensuring security of data imports and exports, which is an essential feature for utilities. Saving historical changes and the ability to undo changes and revert to previous conditions will also be essential features of distribution tool GUIs.

Planning models need updating; they also need to allow for creation of “what-if” scenarios, often by changing conductors, adding features, or switching loads. The GUI must make these tasks simple. SynerGEE Electric, CymDist, DigSilent, PSS/Sincal, and DEW employ similar model build features, in which the user typically needs only to point and click to create new lines or to click on certain features to open up a dialogue box of changes. All five tools also offer a model comparison option in which scenarios can be run and saved. CymDist and PSS/Sincal allow for analysis comparison internal to their tools; SynerGEE includes a function to output data and compare externally using tools such as Excel. The examples of an effective GUI given here, including ability to change models with ease, and scenario development options, are one of the key benefits of the commercial packages for power systems packages versus open source options.



DEW and SynerGEE Electric each have a tool to build scenarios. Users can define and arrange different steady-state applications like power flow, load allocation, fault location, and system restoration in a queue or in a loop for different operation and planning scenarios and studies.

DigSilent has numerous scripting and automation options, the first in its own programming language DPL (DigSilent Programming language), which will allow the full range of DigSilent options to be scripted. DPL can be extended to access external data and commands.

In future distribution grid software packages, scenario development, automation and multi objective planning analyses, will be essential for effective distribution grid analysis, as the grid will have more dynamic configuration and therefore more options for analysis. All tools discussed here have taken steps towards this type of simulation. The development of these scenarios, ability to change the models within the tools, and general analysis needs must be contained within an effective GUI, allowing the user to perform the analysis accurately and with ease. Scenarios and multiple simulation scripting is often in the tools own automation language, such as DigSilent Programming Language. Streamlining this with an integrated GUI will allow the future grid to be more simply analyzed, while technically becoming more complex.

#### **4.1.2 Visualization of Grid Data**

This subsection reviews the visualization of grid data in current tools.

The topology and geographical features of the distribution grid can provide vital information for reliability and repair time metrics. Distribution system models are normally either schematic or geographical. Geographical representations are effective for analyzing renewable energy generation, which may rely on weather forecasting in localized geographical areas for future operations and planning scenarios. Coupling geographical mapping with enhanced measurement techniques and visualization improves the ability to locate faults and plan for restoration. Future planning also requires analysis of localized DER voltage control. Thus, integration of measurement devices with geographical visualization tools is essential. A geographical layout of conductors and equipment, including notation of types and settings, allows a user to quickly identify any outstanding validation issues. Geographical representations can be stand-alone with a blank background, overlaid on a mapping tool for basic features, or overlaid with visualization of results.

Although geographical representation has a number of benefits, for some power systems analysis techniques, such as harmonics and transient analysis, schematic circuit maps are more effective because they allow better visualization and analysis of protection coordination and fault scenarios. The one-line representation provides a more orderly view of detailed system components (**Figure 2** and **Figure 3**).

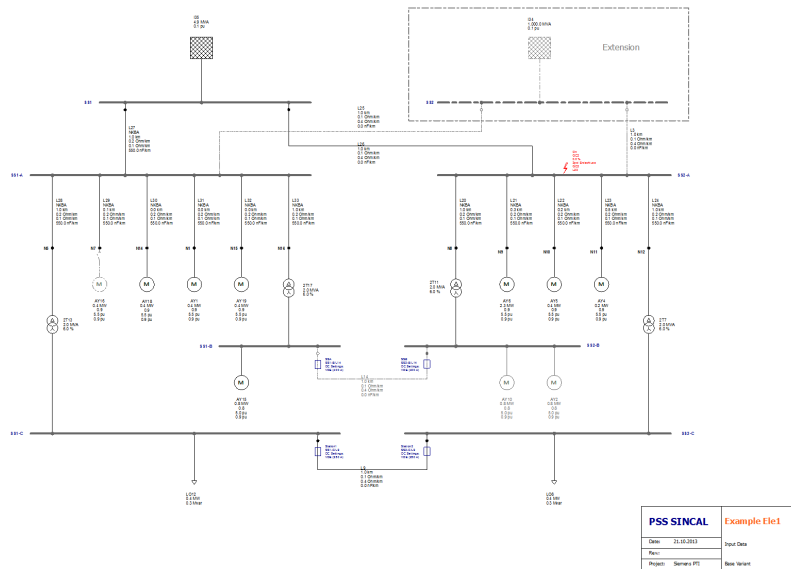

**Figure 2. Example schematic/online from PSS/Sincal**

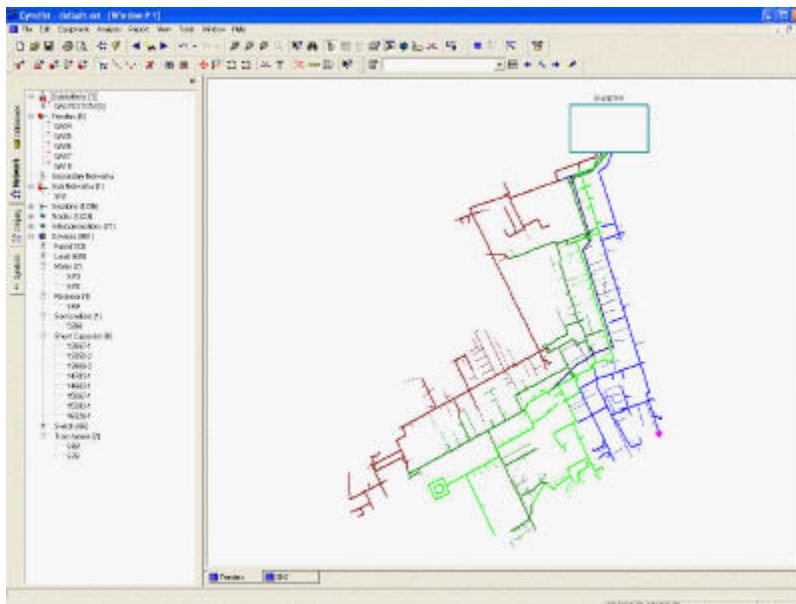

**Figure 3. Example geographical model - CymDist**

SynerGEE electric provides geographical representations only. Coordinates are modeled as X-Y referenced, and the user must select the appropriate coordinate reference zone. SynerGEE provides interactive mapping, in which the line model can be overlaid on a Google Earth map. Models can be created using this reference. SynerGEE does not provide a schematic mapping or one-line option. Results presented in tabular format can be exported to Excel CSV files.

CymDist has a separate geographical overlay module, which allows raster or vector images to be overlaid on a circuit map. The map is added as a layer underneath the model similar to the arrangement in SynerGEE. This option uses graphic computing power, but it can be toggled on and off as needed.

PSS/Sincal displays background maps and offers advanced feature that allows import of vector graphics as features of the electrical model. This facilitates a rapid model build process. PSS/Sincal, DigSilent and CymDist can convert between topological and schematic maps.

DigSilent uses GIS in its model build process and allows for concurrent display of GIS-based and electrical model data. One-lines and geographical maps are available, and the package can toggle between the two modes. If information is missing, DigSilent has options to replace it with particular system defaults. DigSilent can also overlay features on geographical maps.

DEW provides a geographical view of the grid (generally built from a GIS model) that can be layered over Google Earth or other mapping-system views such as ESRI. Analysis calculations can be run and inspected from any of the views.

Model based tools are strong with the ability to visualize the grid structure being analyzed. A tool with the ability to visualize geographical data, with mapping either turned on or off in the background, and oneline presentation will give the user many options for decision making and distribution grid analysis. Only DigSilent , PSS/Sincal and CymDist offer visualization in all these areas. A key development in this area would be allowing the user to build models with a geographical map in the background. This is offered in SynerGEE Electric but is computationally intensive.

### 4.1.3 Results Presentation

Results presentation can be geographical (i.e., color thermal mapping), graphical, or tabular. Each has benefits and negative aspects. As the example in **Figure 4** illustrates, presenting results as a thermal map has the advantage of communicating topological changes and allowing quick identification of hot spots where, for example, voltage has risen close to or above limits.

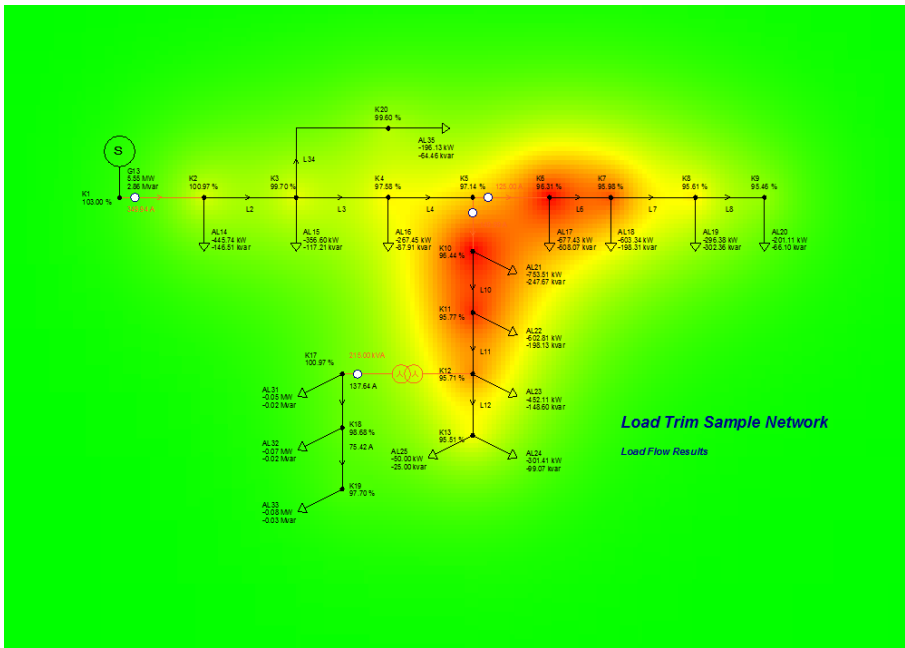

**Figure 4. Example of thermal mapping (PSS/SINCAL)**

Each tool discussed presents a version of thermal mapping. There are two variations. The first being thermal mapping on the grid lines themselves, meaning a line will turn a different color based on which variable is being thermally mapped. This is the method employed in SynerGEE Electric, DEW, DigSilent and CymDist. PSS/Sincal employs the method shown in **Figure 4** where the thermal mapping is part of the background, and not a clearly defined section.

For detailed analysis, a tabular results format for calibration is beneficial. Some packages offer flexibility in the tabular format by allowing changes in the order of results within the table or through a built-in graphing function. PSS/Sincal and CymDist offer particular flexibility in these two areas, allowing tables to be re-ordered and different levels of simulation to be considered. SynerGEE Electric results are presented in tabular format, but customization is not available. SynerGEE Electric will flag “out-of-range” results, which means that, for example, a voltage violation above the high or low range the user has specified will be highlighted first in the results

summary and in red/bold font in the results themselves. This makes it simple to distinguish problem conditions within a large volume of results.

In DigSilent, results can be automatically evaluated or graphed. For evaluation of power quality, it is often preferable to see a graph indicating which voltage limits are violated or harmonic issues are present. DigSilent allows for customized results graphing concurrently with system models for analysis of out-of-range results. DigSilent allows for customized flagging of out-of-range values. This is also available in PSS/Sincal, and CymDist **Figure 5** shows an example.

DEW, PSS/Sincal, and DigSilent can export results to a built-in graphic tool for data visualization. The user can specify the appearance of the output variables from different applications in the tabular display as well as various statistics, such as maximum or average values, to be displayed. The tabular analysis data can be plotted within the analysis tools, or they can be exported to Excel or SQL Server for analysis and archiving.

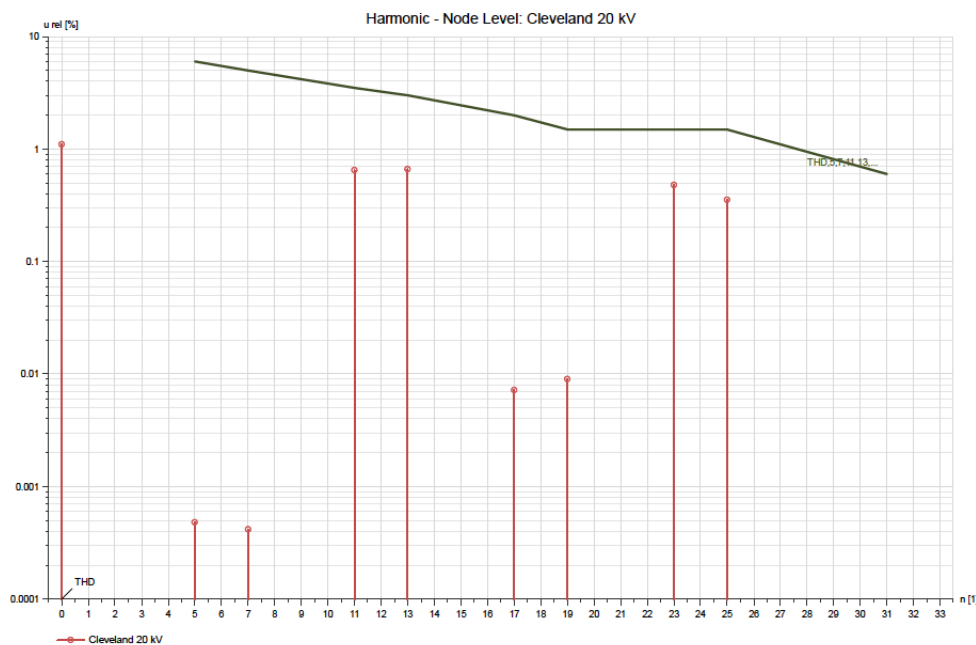

**Figure 5. PSS/Sincal Harmonics Results Graph**

**Figure 5** shows example results in PSS/Sincal of a harmonic analysis of a distribution feeder. Individual voltage harmonics and total harmonic distortion are plotted in red, and the allowed voltage harmonic corresponding to each voltage level is indicated by a green line. For purposes of determining the impact of a range of scenarios, graphical results presentation in this format is essential because it eliminates the requirement for the user to export and review multiple times.

**Figure 6** shows a geographical representation of load results in DEW, which clearly pinpoints the point of overload.

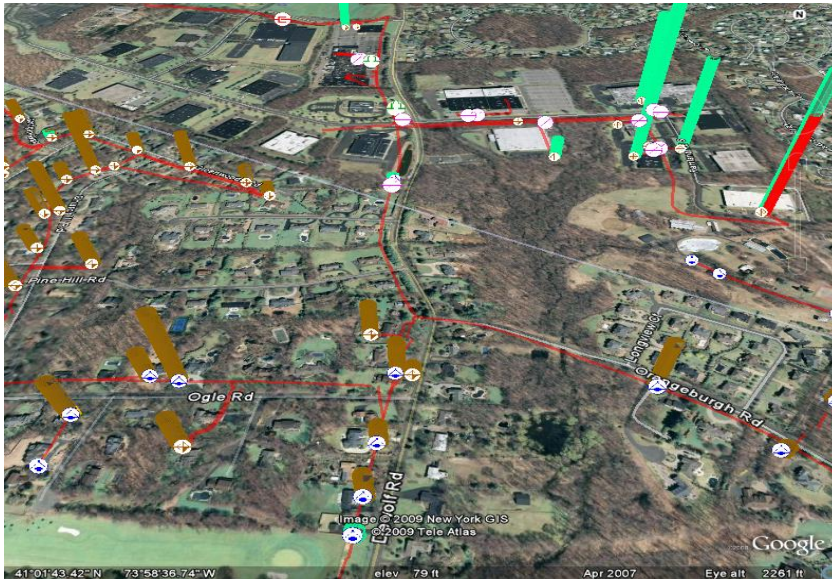

**Figure 6. DEW load-density bar charts over Google Earth**

#### **4.1.4 Summary of Graphical User Interfaces, Visualization, and Results Presentation Review**

User interfaces, grid visualization, and results presentation form the backbone of distribution analysis software. Accurate, useful geographical representations that incorporate key equipment information will be essential for management of the modernized distribution grid. As analysis features grow more complex, the user interface must be designed so that it guides users, who could be utility engineers or consultants, in a simple manner so that they obtain the most benefit and most efficient analysis from the tools. Where GUI development and visualization is strong in many of the tools reviewed, results presentation is varied. A strength in both CymDist and DigSilent is its ability to present the grid data in geographical and online format, whereas some tools like DEW and SynerGEE Electric focus on one or the other. Some tools such are developing highly customizable tabular and exportable data formats such as PSS/Sincal and CymDist, whereas some are moving towards mostly graphical representations of results, which may be less accurately interpreted. All tools must make some developments in the area of analysis automation, to allow users not familiar with software code development to fully utilize the

distribution grid resources in the future, and optimize the use of all analysis types. We now discuss what these analysis types are and the tools capabilities in each area.

## **4.2 Basic Analysis Capabilities**

The subsections below describe the following types of analysis capabilities offered in software tools: steady-state, time-series, fault-current, short-circuit, dynamic, and transient.

### **4.2.1 Steady-State Analysis**

Steady-state analysis is a power-flow or load-flow study at a single point in time and thus has the slowest time frame of all grid studies. Power flow in steady state is used to determine operational values of components and capacity at a particular time. Steady-state analysis it solves the sequence of power-flow components for all points in the distribution feeder depending on the load conditions allocated. Traditionally in distribution systems, steady-state analysis has been performed for the peak-load condition. However, on the modernized distribution grid, peak load may no longer be the main point of interest (Behnke et al. 2011, Lindl et al. 2013, McGranaghan et al. 2008). Constraints analyzed are voltage, current, real and reactive power, power factors, and losses. Power-flow studies are performed as capacity-type analyses to review loading of components and voltage regulation device settings or potentially to plan for future upgrades or capacity limitations. The user determines, either from internal software processing or external analysis, whether the system is within operational standard range as designated by the utility, the utilities commission, or American National Standards Institute (ANSI) C84.1-2011 standards (ANSI 2011, PG&E 1999).

The primary differences among steady-state analysis packages are in options for load-flow analysis and in whether the software offers three-phase balanced or single-phase-unbalanced representation. PSS/E and PSLF are traditional transmission planning tools that are used for three-phase balanced load analysis. The Newton Rhapsod analysis technique used to solve the three-phase balanced models in these two packages is inefficient for analyzing the distribution grid. Numerous analysis techniques that can solve the larger number of variables associated with distribution are presented in literature (Ochoa et al. 2008, Zhang et al. 1994, Alarcon-Rodriguez 2008). In distribution planning tools such as CymDist and PSS/Sincal, single-phase alternating current (AC) representations are popular load-flow types, and other types of representations available are powerful methods of solving the network; they include forwards (current

summation) and backwards (voltage drop) sweep. DEW is the only tool that uses a graph-edge rather than matrix-based analysis technique.

All tools perform a load flow in steady state to baseline the system conditions at any given point. The main difference is in the analytical solving method used, and the need for these different methods is defined by the size of system required to solve. For small systems or single distribution feeders the method used in tools such as SynerGEE Electric is adequate, but for larger systems non matrix based solving methods such as DEW are advantageous. As the distribution grid changes the need for quicker, more reliable solvers with more data will grow also.

#### **4.2.2 Time-Series Analysis**

Time-series analysis is a series of steady-state analyses and is growing in importance with the move toward more DER because distributed resources are inherently variable over time. As load shapes change with the increase in DR and renewables, so will the need to plan beyond a single point in time (Hossain et al. 2010, Stewart and Aukai et al. 2012, Davis et al. 2007, Ellis et.al 2012). Minimum load and variability will require analysis under varied conditions. On a modernized distribution grid, there are multiple voltage control devices to consider, each with different deadband (control band) and time-delay features. The interaction among these will be a critical analysis concern (Stewart and MacPherson et.al 2012, Bank 2013). Distribution software needs to model time-series impacts for simulation of both loads and PV inverters.

Concurrent modeling of generation and load over time is required for situations such as DR. For example, if 50% of people in a geographical area or on a feeder respond to price signals at the same time that a renewable resource experiences a large uncontrolled variation, the potentially significant technical impact on the distribution grid might not be detected without detailed time-series distribution modeling. Detailed time-series simulations can provide operational data for determining the risk of such an event as well as how to prevent a negative impact. The probabilistic nature of such risk events may also require analysis using Monte Carlo simulations, which are available in some tools such as DEW and DigSilent.

Next, we consider the software capabilities for regulation devices. Voltage regulation devices inherently require analysis over the time scales of their potential actions. On-load tap changers (OLTCs), and regulators have a deadband of measured voltage in which no action will occur; this deadband is typically 2% of nominal voltage (Stewart and MacPherson et al. 2012, Ellis 2012,



Davis et.al 2007). When the voltage is outside that deadband, there is a delay, typically between 15 to 60 seconds, before a tap change or regulation action occurs. A tap change can occur every 1 to 5 seconds until the voltage reaches the control set point. This dynamic voltage control by active resources will have significant impact on the grid and will require time-series analysis. Dynamic reactive power compensation and reverse power flow through voltage regulation devices designed to be unidirectional will have similar impact and require similar analysis. Capacitors may also be used, either in substations or farther down the line to provide reactive power and voltage support. Capacitors are often fixed or switched with control that can be based on voltage or power factor or managed by operators (although capacitors are most commonly autonomous devices). Line regulators are present on longer distribution lines, often to boost voltage so that it does not drop below ANSI standards for voltage. Distribution regulators are basically tap changers that operate in a similar manner to transformers. Line regulators are normally unidirectional and set to one voltage control point.

SynerGEE Electric has a time-series model to evaluate steady-state time steps. This model is designed for hourly time-step analysis, with 24 steps for each day type (peak, weekday, weekend). Static load composition can vary in composition over time steps. SynerGEE Electric allows for variation of load percentage over time with user input on a steady-state time-step basis. Three time-step profiles are available. Time-series results within SynerGEE Electric are limited to warnings of out-of-limit conditions in steady state and information on selected variables such as tap position. To complete a detailed plot or comparison, time-series results from this software must be output to csv files and manually plotted. Scripting functionality is available within SynerGEE enabling many time steps and load settings to be programmed to run without user intervention and results to be extracted to plotting software. No dynamic package is available, so composite models are not required. SynerGEE Electric models tap changers, voltage regulators, and capacitors, with control options based on time or voltage. There is a time-delay input for the tap changer, but this delay is not integrated with the time-series analysis. Time steps are arbitrary; within each month the user can perform 3 “days” worth of 24 steady-state time steps. A tap change or regulation change can occur with each time step. As the number of voltage control devices and the complexity increase on the distribution grid, the complexity of these time steps will also need to increase. Where one device may regulate in 15-second time steps, another may regulate in 30-second intervals. If the time step was assumed to be 15 seconds, one device might operate within this time step while the other might not, and the analysis would not capture the change in the device that operated outside the specified time step.

DEW can be used to model steady-state time intervals that may be defined by the measurement data set, including kWh monthly data, load-demand data, and kWh data from AMI. Delays on capacitor switching and voltage regulators can be modeled and accounted for within the simulation environment.

CymDist has a long-term dynamics module, which is a sequential time-series power flow with slower dynamic controls included including delays in regulator, capacitor switching, and OLTC operation. The long-term dynamics algorithm supports multiple metering units as fixed demands and large metered customers as fixed load. For time-series voltage regulation, CymDist includes models of tap changers, voltage regulators, and capacitors. Tap-changer time delays can be modeled and integrated in the long-term dynamic time-series analysis. Control options available for capacitors include kilovolt-ampere reactive (kVAR), power factor, and time.

PSS/Sincal can complete time-series sensitivity analyses including regulator and capacitor settings, PV inverter models (dynamic, steady state, fault current, and time series).

DigSilent has two versions of time-series analysis; one is based in slower dynamics, and the second offers a series of steady-state time steps. The slower dynamic package is used to evaluate different time-series impacts, such as OLTC time delays, and coordinates with other voltage control devices.

Time series analysis is an essential need for future grid analysis tools. Tools with fixed time steps will miss many of the complexities of the future distribution grid voltage control schemes and renewables operation with varied time delays of importance and must develop further to enable this feature.

### **4.2.3 Fault-Current and Short-Circuit Analysis**

Short-circuit analysis determines the magnitude of fault current generated by a short circuit on the system and is used to assess the adequacy of protection devices such as breakers and fuses.

Coordination analysis ensures that the combination of time scales and limits of protection devices is sufficient to operate in an order that minimizes the extent of outages and protects key circuit components. A single PV inverter may not significantly alter the fault current at the protection

devices, but, as PV penetration increases, the fault current value changes incrementally. The interaction of advanced inverter configurations, including low-voltage ride-through, may influence future protection scenarios and coordination (Ellis 2012, Stewart and MacPherson 2012).

Protection engineers and consultants use distribution analysis tools to evaluate distribution system fault current and protection devices. Fault-current analysis determines the levels of current that would come from the transmission system to the distribution system in the event of a fault. This type of analysis is used to determine appropriate coordination and setting of protection devices.

Recommendations for protection improvements are based on a short-circuit current analysis, a protection coordination study, the load flows of existing and proposed configurations, and single-contingency analyses. Devices included in protection studies must be appropriately modeled and include breakers, re-closers, fuses and switches, and distributed generation.

This section evaluates the short-circuit analysis capabilities of the software packages; however, load modeling and inverter/DER modeling also play a large part in accurate fault-current analysis, so the information below should be reviewed with those elements in mind.

As is true for the other types of analysis already discussed, software that is used for fault-current and protection analysis must be able to model multiple scenarios and time frames as well as advanced devices and controls.

Some software specializes in fault current analysis or offer advanced functionality as a separate package. Other software offers differing levels of functionality in this area as part of the base package.

Any distribution grid analysis package should be able to perform the following analyses:

- Balanced/unbalanced
- Radial and meshed/looped
- Pre-fault loading short circuit
- Pre-/post-fault flow voltage
- Protection coordination

- Contingency
- Multiple faults

Each package should also include the following options:

- Fault type options: asymmetrical, three-phase, single-phase to ground, two-phase to ground
- Inverter/DG representation options
- Fault type options: asymmetrical, three phase, single-phase to ground, two phase to ground

Each package reviewed had capability in all but two of the areas above: inverter modeling and contingency analysis. Inverter modeling is limited in SynerGEE Electric to either an equivalent model created using a negative load and transformer for impedance or a three-phase contributor. Not all packages could create a switching plan and evaluate multiple configurations; PSS/Sincal and DEW were limited in this area.

#### **4.2.4 Dynamic Analysis**

Dynamic analysis examines the ability of a system to remain stable during faults and small signal fault conditions. Dynamic analysis in power systems evaluates the response of system to voltage and frequency oscillations and rotor angle swing. This analysis is typically performed for the transmission system to evaluate bulk system stability during disturbances; it is strongly influenced by bulk system generator characteristics. Although dynamic analysis is not normally considered for small PV penetrations, recent discussions suggest that it is needed to evaluate 1) bulk system stability with high grid-wide renewable penetration and 2) local distribution stability where there is high penetration of inverters, particularly with basic (no control) and advanced characteristics such as low-voltage ride-through.

DigSilent and PSS/Sincal have full three-phase and single-phase dynamic analysis packages incorporating representations of modeled rotating elements and frequency dependency. CymDist has a package, CYMSTAB, available to model three-phase dynamics. The CYMSTAB package takes a detailed unbalanced model and balances it for the purposes of dynamic analysis. DEW and SynerGEE Electric do not have dynamic stability packages.

Dynamic stability in distribution is not well understood and most packages are at a rudimentary stage of developing this feature. The inherent imbalances in the distribution system alter the complexity of dynamic stability and will therefore be an essential piece in dynamic distribution analysis. DigSilent and PSS/Sincal are the only packages that offer full unbalanced stability analysis, but CymDist and DEW are making clear steps towards this.

#### **4.2.5 Transient Analysis**

Transient analysis is in the time domain and is used to analyze electromagnetic responses to sudden, microsecond-level conditions. A transient analysis commonly conducted as part of an advanced renewable interconnection study would be to evaluate the ground fault overvoltage potential of a particular site. This type of analysis involves detailed modeling of the components in a particular location, including control models used to study switching transients, harmonics and power quality, and control systems. The solution in a transient study is often computationally intense, so such a study cannot be used to solve very large systems. In distribution systems this requires creating an equivalent representation of the source system, i.e., the sub-transmission system. Transient analysis is not commonly available as part of a distribution planning package and is normally completed using a specialist package such as PSCAD (Manitoba Hydro International Limited) or EMTP-RV (EMTP-RV). A transient study requires that the user or model builder have specific and advanced knowledge of, for example, inverter topology or of other devices with feedback and control loops. This control strategy and design information are often proprietary, which makes it difficult to create a generic response and validate that response at the grid level.

#### **4.2.6 Summary of Software Tools' Basic Functionality**

**Figure 7** summarizes the capabilities of the software packages in the areas of basic functionality reviewed in this section.

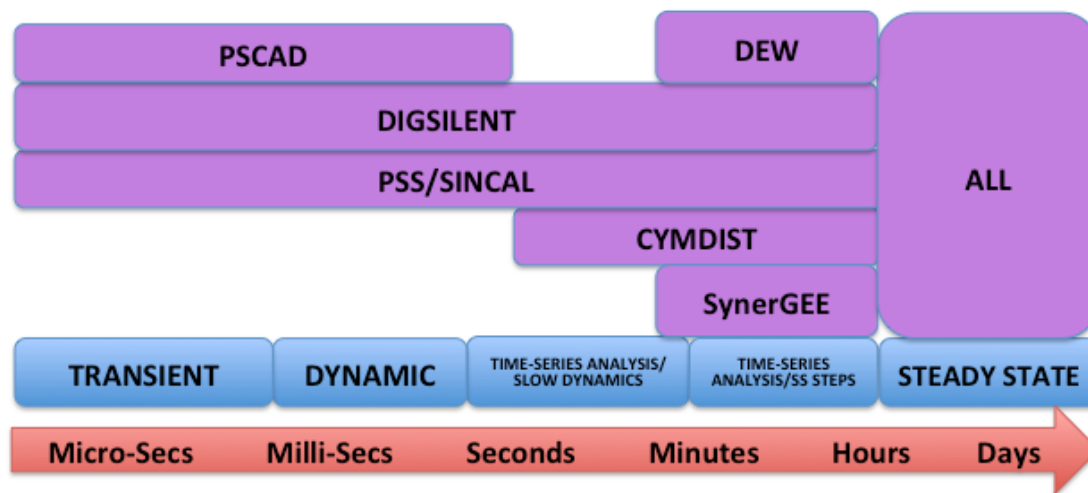

Figure 7. Summary of basic analysis areas in each evaluation tool

### 4.3 Advanced Criteria for Evaluating Tools' Capabilities to Analyze the Future Distribution Grid

In this section we discuss specific capabilities that are needed for tools to be able to accurately model and analyze features of the modernized distribution grid. These features include renewable resources, advanced measurement sources, rapidly changing topology and load, and increased automation and control. Modeling of these devices and characteristics can be in all time frames addressed in our software review above.

#### 4.3.1 Inverter, Load, and Distributed Energy Resource Modeling

The subsections below examine the capabilities of transmission software packages for modeling inverters, loads, and DER on the distribution grid.

##### 4.3.1.1 Inverter Modeling

Distribution feeders in California are experiencing large increases in connected residential and commercial PV units, forming clusters in some utility areas, and the future distribution grid will have large numbers of integrated DER with numerous power conversion devices (i.e., inverters). Each of these devices will need to be represented in grid models. Representative inverter models are developed either physically through block modeling interface devices or through differential equations validated using measured data to represent device behavior (Keller et al. 2010, Muljadi et al. 2013, Kersting et al. 2006). Software based on block modeling is easier to use than software

based on differential equations, but current software is not capable of modeling the large number of these devices that will be part of the future distribution grid.

PV can provide numerous benefits to the grid, including operational reserve and voltage support, but to ensure grid reliability we need to be able to analyze the behavior of the large number of inverters that will be present on the future grid as well as their interaction with other devices.

At the moment, the restrictions imposed by IEEE 1547 prevent PV from providing the protection and control benefits that it could offer to the grid, such as participating in voltage control or islanding. However, because distributed PV was developed with control and protection systems to “get out of the way,” i.e., disconnect from the grid in the event of a grid fault, restrictions on PV’s participation in voltage control are ultimately likely to be lifted.

Inverter models in power system simulation are widely discussed in the literature (Behnke et al. 2011, Ellis et al. 2012, Ropp et al. 2012, Muljadi et al. 2013). Keller et al. (2010) and Ropp et al. (2012) have analyzed the progress in modeling of inverters in fault current, dynamic and transient realms. We do not repeat the conclusions of these studies but summarize the key issues in each software package for modeling in these realms.

As PV and distributed resources are allowed play a role in grid stability and interaction, the modeling complexities will increase. The way distributed PV is currently modeled, as a load reduction or negative load that does not cause reverse power flow, means that modeling cannot account for PV’s protection and control benefits. In the event of a fault, distributed PV as a negative load cannot be modeled as islanding or tripping during load-shedding and switching operations. Therefore, because models cannot simulate what PV can do, it is not possible to plan for fully utilizing its protection and control capabilities.

The key reason that it is critical to accurately model PV’s protection and control behavior is that, if this is not modeled, numerous detrimental impacts can result from large volumes of distributed and uncontrollable PV on an unprepared distribution grid: (1) voltage violations, (2) flicker and other power-quality issues, (3) reverse power flow and protection coordination issues, (5) increased wear on utility equipment, (5) real and reactive power imbalances.

Based on our review of the basic functionality of software packages (Section 4.2), we then looked at their ability to model inverters within the types of analyses that each software package is capable of performing; for example, if a software package does not include dynamic analysis, then we did not look at whether it could do dynamic inverter modeling. Inverter-based distributed generation will be a key piece of the future grid. Different types of interconnection and integration analysis for the grid require different types of inverter models to be integrated into distribution planning tools. The complexity of the inverter models increases from steady state to transient studies, and as the time frame for analysis decreases, the number of components required to be modeled in the inverter model increases. The more components in the inverter model, the more likely the model and inverter configuration data will be proprietary, therefore more difficult to model than the non proprietary case.

Inverter topologies and control characteristics vary significantly for each vendor and the importance of that topology increases as the complexity of the analysis increases; that is, in a simple steady-state model advanced features might not need to be included, but in a dynamic situation control and protection must be simulated and a vendor-specific model is often needed. In transient analysis in a component-level model, detailed feedback loops and sub-cycle performance characteristics must be included. As complexity grows, so does the risk of error in validation. We discuss distribution tools individually for their ability to model inverters in each of the time frames for analysis. However, rather than having an inverter model in each software package, for the future distribution grid analysis, the ability to use similar models or hook a single model in a generic package (such as Simulink) into different commercial analysis packages would be advantageous (for more information about the ability of each tool to fit into other tools or packages, see *“Using uPMU data for advanced planning and operations applications”*).

A steady-state load flow model primarily on the low-voltage or customer side of the meter has traditionally been represented as a negative load, captured during the load allocation and measurement process. In scenarios with low to medium penetration of renewables, this is a partially accurate assumption for steady-state performance. What is missing is quantification of the masked load, i.e., how much load is present on the customer side of the meter in the event that the inverter generation resource is tripped. When there is significant penetration of renewables, this modeling assumption can lead to errors in setting of equipment and outage response scenarios. It also leads to longer-term forecasting errors for load growth. As penetration of DR, storage, and EVs increases, this will be a harder value to quantify.



In short-circuit and protection coordination scenarios, the contribution of fault current from the inverter-based generation must be quantified and considered in combination with load characteristics. In the early stages of inverter modeling, the methodology was to represent inverters as synchronous generators. However, this was found to be inaccurate and to introduce irrelevant rotating-component complexities, particularly inertial response characteristics. Keller et al. (2010) test and discuss inverters' fault current contribution, reported in numerous sources to be one to two times the full load current. A grid reference simulator was developed with inverters connected. A fault was simulated and the fault current contribution measured in the transient and post-fault times. It was found that this was a significant variable of approximately 2 to 5 times the rated current output. Modeling of the internal inverter impedance was recommended to accurately simulate the potential contribution of inverters to fault current analysis. These models will need to be developed to interact with the protection coordination analyses in software for future distribution grid analysis.

SynerGEE electric provides only steady-state, short-circuit, and quasi-steady-state analysis options for modeling inverters. In steady-state analysis, generator models can have a particular generation profile or be referenced to in-program weather data, but this is effectively a load-reduction model in which the generators are voltage sources, contributing constant power. Fault-current analysis models allow the user to set a desired fault-current contribution percentage up to 120%. Fault current is available in single-phase balanced and unbalanced as well as three-phase configuration. The generator models are not detailed; they are simply increased current sources in the event of a fault, and knowledge of a particular inverter's characteristics are necessary. SynerGEE electric does not have an integrated dynamic or transient package. An alternate method is provided to model a transformer and equivalent source, which can be tuned to output the desired fault-current amount. This method is somewhat inaccurate and assumes knowledge of each inverter's specific fault current contribution capability, which may be unknown. Generator models available are synchronous, induction, wind, PV and constant power. Weather modeling is integrated but only in long (hourly steady-state) time steps.

PSS/Sincal allows for modeling of inverters in steady-state, short-circuit, dynamic, and transient form. The steady-state and short-circuit models are impedance based and do not have to be modeled separately. The load-flow model allows for fault-current and/or dynamic analysis data to be entered, making it a multi-functional model, so the user does not have to maintain separate

models to run these three types of analysis. In dynamic modeling, PSS/SINCAL also allows for user-defined models through the graphical model building, block modeling interface. PSS/Sincal offers a transient stability method that works in unbalanced networks. Models can be built using the graphical model builder or existing models in alternate platforms such as Matlab/Simulink can be used. PSS/Sincal is particularly powerful for DER modeling because one generator block can be coupled with steady-state, short-circuit, and dynamic models, and the user can also input harmonic characteristics for advanced high penetration analyses. PSS/Sincal also allows input of custom irradiance and weather data.

CymDist offers load profiling as part of its base package, providing detailed (time-series steady-state) models of PV with an insolation curve input option, and short-time-step time series. CymDist also has a specialized long-term dynamics model. The PV output model is a function of the current and voltage at maximum power point, and the insolation curve in watts per square meter. Data input parameters are inline with solar module data sheets, including maximum power rating, rated current and voltage, short-circuit current and open circuit voltage, and thermal performance parameters. Impact studies with these models can consider reactive compensation and capacitor switching, voltage regulation (OLTC and line), and voltage profiles over time. Events analyzed in the long-term dynamics package include cloud transients and load variation/profiles.

DEW includes the five inverter models defined by the Electric Power Research Institute (EPRI) (EPRI 2012) plus additional optimal control models. DEW also provides a Matlab Simulink interface that can be used to interface inverter manufacturer dynamic models in Matlab with the DEW power flow. DEW does not have a dynamic analysis package, so the interface is limited to steady-state and control features. DEW has automated interfaces to historical solar generation data through NREL and Clean Power Research as well as interfaces to forecasted solar generation through Clean Power Research (Hummon et al. 2012).

CymDist and PSS/Sincal have integrated advanced control, time-series functionality for load flow. Load-flow controllers are available for highly varied time steps, quasi-steady-state, and irradiance input packages.

Dynamic modeling of inverters is not available in packages that do not have dynamic functionality; therefore, we only evaluate SynerGee Electric and DEW for steady-state and fault-current analyses.

DigSilent PowerFactory allows for numerous types of inverter modeling, including steady state, fault current, dynamic, and transient. Time-series load analysis is available based on different load and generation profiles. Dynamic component models are available, and dynamic and transient models are supported via internal model build interfaces and external interfaces to Simulink models. DigSilent uses the IEEE controller models, and the protection library can be integrated with the models when analyzing stability.

DigSilent and PSS/Sincal are two commercially available packages for steady-state and dynamic planning functions that also include a transient package. Aside from these two models, other transient models normally require a specialist software package for component and control loop modeling of inverters. Although these two packages are strong in the very-short-time-scale and component modeling realm, they are limited in the volume of data that can be modeled. Transient analysis is limited to a number of specific packages with time domain functionality.

PSCAD is a specific transient analysis package. Node numbers and data input are limited in this package, and the distribution system must generally be reduced. In addition, these models are complex; the developer needs a qualified and experienced practitioner to develop this model. Knowledge of all components and control loops that may operate in the transient domain is also necessary but not always provided by the device manufacturers.

Milsoft offers WindMIL for PV modeling. While this tool is not a focus in this report, WindMIL has been used specifically in interconnection studies (Ortmeyer et al. 2008). WindMIL can model the system down to the customer meter. Solar PV models in WindMIL include negative load loads, fixed power factor, reactive power control and simple current sources. Each power flow in WindMIL iterates to reach reactive current and hold specified voltage for control. The fault flow model is a voltage source and impedance. Dynamic and transient applications are not available.

The most powerful distributed generation packages allow for accurate steady-state, time-series, protection and dynamic analysis. Steady-state and fault-current analysis tools such as SynerGEE Electric that do not explicitly allow for varying the contribution without manual changes by the

user require further development to meet the needs of systems with many inverters. Packages such as DigSilent and PSS/Sincal have the ability to couple with other models such as Simulink. This enables the software to use a single inverter model. Eliminating the need for multiple inverter models in different packages will enable software to meet the needs of the rapidly changing grid more efficiently. In addition, transient analysis is becoming more important as the penetration of renewables increases and the control schemes for inverters become more complex. Transient impacts of renewables may be better analyzed within specific tools such as PSCAD.

#### **4.3.1.2 Load Modeling**

A widespread blackout in 1996 (Taylor 1999) was reportedly caused by oscillations in the transmission system. That blackout resulted from failure to account for the dynamic behavior of transmission systems, which was neither predicted by models nor detected with conventional instrumentation (this event took place prior to the use of synchrophasors). The dynamic characteristics in this case originated from interactions between generators and long alternating-current lines.

As noted earlier, the distribution grid has been traditionally considered a static load. However, WECC has been developing and validating composite load models (Kosterev et al. 2008) that are now implemented in most transmission simulation packages (such as PSLF and PSS/E). WECC's models are intended to represent the characteristics of advanced thermally dependent loads and motor starting/stalling characteristics.

The load at distribution level has a higher variability in multiple locations than transmission load. This means that lumped load characteristics at any given location could lead to inaccuracy and incorrect responses over short time periods. Loads are considered either static or dynamic in software models. In distribution modeling software packages, loads are commonly defined as static, with time-invariant constant current, constant impedance, and constant power. This definition might be suitable at a particular steady-state time but is not appropriate for time-series simulation. Over time, load makeup changes based on customers' use patterns for different devices; therefore, the ratios of constant power current and impedance change over time, and thermal composite loads may also be considered. One-hour changes in load makeup are common (Coughlin et al. 2008)**Error! Reference source not found..** Dynamic loads depend on both voltage and time. Dynamic loads with thermal cycles have additional modeling complexities;

examples of this type of load include heat exchangers; ovens and cooking devices; and heating, ventilation, and air conditioning (HVAC). These devices often also have control systems to regulate power consumption to within a set range when voltage varies.

Load elements can be connected in different configurations, and different phases can have different load compositions. Unbalanced delta or wye configurations are possible, and the impact of the imbalances can be reflected throughout the distribution system, leading to inefficiencies and potential for fault-related impacts such as fault-induced delayed voltage recovery (FIDVR). FIDVR detection is discussed in (Bravo 2013). On the modernized distribution grid, it is essential to identify the near-real-time varying contribution to total load of devices such as single-phase induction motors in residential and small commercial air conditioners because these can pose an increased risk of FIDVR.

Although the occurrence of FIDVR can be readily identified after the fact through voltage magnitude measurements, there is currently no way to anticipate or predict this phenomenon other than awareness that a circuit is generally at risk because of climate zone, current weather, and the presence of switched capacitor banks that result from its dependency on thermal loads with motor characteristics. An FIDVR event, and a re-creation of the event, can then be simulated using software packages.

Accurate knowledge of detailed load profiles is difficult to obtain. Bulk representation may be known or closely estimated (Coughlin et al. 2008); for example, most utilities could estimate the split of HVAC loads, with and without motor based starters, and other non-thermal loads as well as distribution losses. Proportioning this out to low-voltage customers requires either detailed measured data or detailed customer reporting.

Customers served by the distribution grid have a combination of thermal and simple end-use devices. Non-thermal devices do not operate with integrated control loops that regulate device output to within a specific range and turn on and off depending on that set point. With an integrated control loop, energy consumed is a function of the voltage and time for which the device is on. Loads without thermal cycles can be modeled as constant impedance (Z), current (I), power (P). This is referred to as a composite or ZIP model. As the voltage varies, the load will vary. The difficulty in validating a model is determining the percentage contribution of each of these components over time. The percentage contribution is estimated for common devices in

(Schneider et al. 2010), but as households use more electronic and demand-controlled devices, these percentages will become increasingly unknown unless enhanced measurement and validation are undertaken. The modernized distribution grid will have fewer loads that can be represented simply. With the increase in DR technology and energy-efficient devices, loads are becoming electronics-based, controllable from varying sources, and may include variable-frequency drives. Household load is made up of a number of sources. In power systems modeling software, load composition is typically developed based on customer class (residential, commercial, industrial), weather data, transformer size, and monthly billing data.

To summarize, the issue of load in distribution modeling is complex in contrast to the aggregated distribution load used in transmission modeling. Integrating high-fidelity measurement data with simulation programs would be beneficial for distribution load modeling. With the addition of active sources to traditional distribution loads and the reduction in load predictability resulting from incorporation of DR, simulation and analysis tools can no longer assume predictable load profiles. Non-aggregated load is more variable overall than aggregated load at the distributed level, and localized load can step instantaneously by large percentages over total load. Planning tools for dynamics and stability at the distribution level, particularly for micro-grids and islanding conditions, must model, accurately and in detail, the generation source, distribution characteristics, and end-use load.

We summarize below the capabilities of each of the programs for load modeling.

SynerGEE Electric completes load allocation and estimation using customer consumption data (kWh), distribution transformer size (connected kVA), and real consumption (kVA or kilowatts [kW]). The algorithm supports multiple metering units as fixed demands and large metered customers as fixed load. Static load composition can be specified using the ZIP format, and composition can vary over time steps.

The following measurements and load models can be included in the DEW model: kWh monthly data, load demand data, kWh data from AMI or load research programs, constant power loads, constant current loads, impedance loads, voltage-dependent loads, and SCADA measurements. Delays on capacitor switching and voltage regulators can be modeled.

CymDist has a load model library for common mixes of ZIP. Load allocation and estimation in CymDist are completed using customer consumption data (kWh), distribution transformer size (connected kVA), and potentially real consumption (kVA or kW) input from billing or measured data. The long-term dynamics algorithm supports multiple metering units as fixed demands and large metered customers as fixed load.

PSS/Sincal allows for use of both the ZIP and composite load model techniques. Individual load models at buses can be detailed to include ZIP models and motor models. Distribution load can be allocated using coincidental kW (with logged AMI readings if available). Transformer KVA can be allocated seasonally in combination with billing data (kWh). PSS/Sincal has a data-retrieval interface and a viewer for SCADA and customer data. Time-series sensitivity analyses are possible, including regulator and capacitor settings, PV inverter models (dynamic, steady state, fault current, and time series). Load allocation with partial advanced metering is also an option, in which meter data are allocated first and then load allocation is estimated from other model data. Load models in PSS/SINCAL include, impedance constant power consumption quadratic to voltage, real and reactive power constant, power consumption independent of voltage, and power consumption proportional to voltage.

DigSilent has PQ, ZIP, and advanced load-modeling capability. Advanced capability can model voltage dependency of percentages of real and reactive power. A dynamic load model is developed, which is described by speed and torque characteristics of a motor.

#### ***4.3.1.3 Inverter and Load Modeling and Barriers/Future Needs***

Models for inverter dynamic and transient stability are generally proprietary. Although some generic modeling is available, the components' time constants and control loops are unpublished, so detailed modeling will always have inherent estimations and errors. The single-model-source concept, in which the user of simulation software would not need to coordinate among multiple model types (steady state, short circuit, dynamic, transient) to analyze advanced grid conditions, would address the limitations imposed by the current proprietary models.

The key features of a dynamic inverter model from the transmission planning perspective are discussed in (Ellis and Behnke et al. 2011) as being a representation of inverter devices though configurable gains, time constants and switches, without black boxing the devices, stable over

sub-cycle time steps, cross platform compatibility, documented, and validated. This is often requested by developers and utilities from the inverter vendors, but will be provided as a proprietary model. Current industry practice is to use proprietary manufacturer-specific models. The complexity and volume of potential inverter models makes the high penetration of renewable distribution grid a daunting prospect. WECC's renewable energy modeling task force is working to improve the availability and accuracy of both wind and PV models for bulk system studies. Currently there is no approved PV inverter modeling standard as is available for Wind generation devices (Ellis 2011) but a PV standard is expected in the near future.

### **4.3.2 Data-Processing Capability**

Distribution systems have large, complex data-processing needs and many actions and variables that must be considered concurrently. The radial nature of existing distribution systems allows for analysis to be sectionalized. Substations and geographical areas can be modeled as individual sections, with the transmission-system equivalence at the substation high-voltage side.

However, as the distribution grid modernizes, sectionalized analysis may not be possible because the distribution grid will be reconfigured frequently, and a much larger area of control and concern will need to be analyzed. This, in turn, will require a greater volume of analytical and graphical processing and thus increased computing power, which is often not available at the average utility. We must therefore consider the data- processing ability of distribution modeling tools for the different types of analysis.

#### ***4.3.2.1 Dynamic and Time-Series Analysis Data Constraints***

Time-series or quasi-steady-state analysis as outlined earlier (in Section 4), is time-stepped steady-state analysis, meaning that each time step requires a full power flow for however many nodes and control points the distribution model has. Thus, for one-second steps for 24 hours, a total of 86,400 power-flow simulations would be required. Dynamic and active sources will require additional models. Currently in PSLF an inverter can be fully modeled using the following invocations (with an optional user-written model for irradiance data input).

- EPCTRB: User-written model for PV irradiance input
- GEWTG: Generator/converter model
- EWTGFC: Electrical control for full converter generator
- LHFRT: Frequency ride through generator protection



Therefore, for each inverter or equivalent PV system, there are three or four dynamic model pieces on top of the PSLF distribution model (or PSS/E generic model). User written models with similar capabilities are available in PSS/Sincal and CymDist CYMSTAB and DigSilent. To perform modeling for a small western U.S. utility that currently has more than 7,000 on-line inverters, at least three times as many dynamic models as inverters would be required (21,000). This is outside the model processing capability of many transmission models; most transmission analysis packages can only use approximately 4,000 models. In addition to analyzing DER, models (dynamic, transient, and steady state) are also required for transformers, and protection and voltage regulation devices. In dynamic analysis control, models are required to invoke such features as under-frequency load shedding, which exponentially increases the processing requirements. However, there are a number of ways to address this problem other than increasing computing power; these include model aggregation and node reduction, as described in the next subsection.

#### ***4.3.2.2 Model Aggregation and Node Reduction***

As the distribution grid modernizes and DER becomes an integral part of the control schema, aggregating models and device control features may reduce accuracy; therefore, inverter and load characterization will be essential. Characterization means representing performance using representative differential equations, control loops, or measured data. Planners and operators will need rapid analysis and processing time for dynamic and increased switching operations. This is another example of the need for quick planning analysis that rapidly translates into operational actions. The accuracy of the analysis will depend on convergence of the simulation, which, without improving the data processing capacity that is found in commonly available distribution software, will limit planning capabilities. Solvers available for the distribution system were discussed in Section 4.

Distribution feeders can have as few as 20 nodes or more than 500. A node in distribution modeling is a bus, pole location, or geographical / physical point used to localize a particular piece of equipment such as a switch or fuse. Node volume is greater in distribution modeling than transmission as there are many more single- and three-phase radial branches from the trunk of the distribution line. Node reduction will be essential for numerous applications in larger models; this is a feature offered in varying degrees of detail in the software packages that we reviewed. SynerGEE Electric offers a node reduction option to join lines with the same conductor

type and remove the nodes or poles; although geographic detail is lost, simulation time can be significantly decreased.

Some analysis applications may not require single-phase or low-voltage analysis. The ability of software to equivalence around selected control points will be a key advantage in its applicability in the future distribution grid. This feature is often packaged with a node- reduction function. For example, in SynerGEE Electric, the user can reduce single-phase branches and equivalence at the closest three-phase node, either balancing the load or not. In CymDist and DEW there are features to black-box low-voltage and other portions of the network, which, while it reduces the user's need to visualize these portions, does not reduce simulation time.

With sufficient validation and control points, multi-feeder protection coordination analysis for advanced and automated systems may initially be needed only at the trunk of the feeder. Software would be appropriate that equivalences and de-equivalences so that data do not need to be re-modeled accurately. Similarly, if large sections of the distribution grid are essentially islanded from other areas, they could be equivalenced so that their impact on the bulk system during large distribution events could still be accurately quantified or not pulled into the simulation at all.

Many power systems packages now state they have no node limitation, and that the analysis is only limited by the computing power available. The average desktop used at a utility or consulting firm will be limited, for most packages, to approximately 10,000 nodes for steady-state analysis. Past this point, the packages are often unstable.

Below we outline the data-processing capabilities of selected simulation packages.

DEW has model-management capabilities for multi-core or blade computer calculations. These capabilities provide for an scalable, real-time analysis environment, including: a one-model server that serves up models with SCADA measurements for real-time analysis and control; and two-circuit queues, in which each application in a collaborating analysis environment has an inbox and outbox. The approach to system analysis used in DEW allows for distribution of large-scale models and the calculations that run on them.

To meet minimum installation requirements, PSS/Sincal states the need for a 2-gigahertz processor and 4 gigabytes of random access memory. The hard disk needs available space above 20GB, and the graphics card must support 1280 x 1024. PSS/Sincal claims to be able to handle more than 50,000 buses but advises the use of 10,000 or fewer for fast processing. To reduce computing time, results processing can be minimized.

CymDist minimum installation requirements are Intel Pentium 4 processor or above, with a minimum of 1GB of RAM and 1GB of hard disk space. There is no explicit limit on number of nodes that can be analyzed.

## 5 Accuracy in Distribution Modeling

The preceding sections of this report described the abilities of current distribution modeling software packages and the need for various features in distribution analysis and modeling tools. We also discussed the likely features of the modernized distribution grid that will drive the need for more accurate analysis than is currently performed. Accurate analysis is defined by, for example, how closely a tool's output during a fault or generator trip corresponds to measured, real-world grid behavior. Although a tool may have many advanced features, it is not useful if its model is not accurate. The quality of the data input to the models directly affects the accuracy of the results. We previously highlighted the need and potential to increase the measured data collected from the distribution grid. Using measured data to validate and calibrate models will exponentially enhance the value of grid analysis tools.

Lack of validation in distribution modeling leads to many issues including underutilized resources, undetected overloads, and lack of renewable resource development because of over- or under-conservative impact estimates. In this section, we discuss how data for grid models is input and some challenges to achieving greater accuracy, the most important being the lack of measured data to validate models. We then propose solutions for accuracy issues, including iterative validation and use of common data formats for grid data.

A degree of error is accepted in engineering analysis of the distribution system. The IEEE standard for accuracy is to within 0.5% for voltage and current output at nodes. The practical impact of errors at these levels is small, but when the percentage error is greater, it can result in both economic and technical impacts on the grid. What follows is an example of the impacts that might result from planning for upgrades and interconnections. A system impact study of the distribution system could indicate a power-quality issue caused by an interconnecting generator. A number of items could affect the accuracy of the simulation results, from conductor type to source impedance and control strategy for existing equipment. If the study results are erroneous, the utility might require the interconnecting generator to install expensive mitigation that might not actually be necessary. Impacts such as this limit renewables integration, which is an important target in many areas for utilities. Conversely, the model could err in representing the interconnection as not having a negative impact, which could then result in an unanticipated power-quality issue that would have economic and technical impacts on both customers and the utility. Significant safety impacts could result if, for example, a lack of accurate knowledge of grid

topology led field workers to inadvertently switch into an unknown topology and cause an arc flash or overloading. Many of these issues would be solved by validating distribution models using reliable measured data, but until recently data were not available for this purpose.

Error in distribution operations and planning can come from either the data source or the process of transferring data among different packages for various analyses. The subsections below describe both types of errors.

## **5.1 Input Data Errors**

Three major contributors to input data error in electrical distribution modeling are:

- GIS data (equipment, conductors)
- Switching and topology reporting
- Customer and load data (aggregate and locational)

Each is discussed in a separate subsection below.

### **5.1.1 Geographic Information System Data Errors**

Most utility distribution planning models are based on GIS data. GIS data are a database series of interconnected features and layers documenting coordinates of key equipment and topology, for example pole locations and conductor types. For electrical analysis these data are exported, using methods that are normally proprietary, to numerous different packages for electrical simulation. Because the accuracy of the distribution model is based on the GIS system and input data, these are a key source of error.

Although GIS packages are not the subject of this report, we look briefly at the commonly used packages ESRI and ARCGIS. The database format for ARCGIS is usually Microsoft Access. GIS developers such as ESRI in some cases work closely with distribution software manufacturers to create custom import tools that convert GIS data to electrical model data. Some examples include MiddleLink from SynerGEE Electric, Cyme Gateway, and Sam Six from NRG. GIS errors can include missing switching cabinets and switchgear, missing fuse and protection data, missing PV locations, and missing equipment information.

The GIS database should contain most of the information specifically needed for modeling an electrical distribution network, but these databases were often not constructed with this function in mind for the distribution system. The databases often contain numerous non-congruous lines,

and feature IDs for generation may not link to a specific customer or distribution transformer. Legacy conductor information from upgraded or now-redundant lines may also remain in the database, creating ghost sections that are not sourced in the distribution extract from the database. The GIS model import into a software package can be associated with component errors, especially in switches. A switch really has two voltages with a single nod, but GIS databases usually do not handle different power phases across a switch. The circuit that is built on the GIS database can therefore create topological constructs that might not make physics-based sense. Some software packages like DEW and SynerGEE automatically discover topological errors in GIS modeling. Power flow can solve models using imported information on switching cabinets, poles, towers, manholes, and other structural elements, or this information can be filtered during the import process.

When models are extracted to power system software, they are not synchronized back to the GIS data. This ensures that the primary source for all data will not be tainted by, for example, construction data that are analyzed as part of a future project. Data once extracted to the simulation tool is often in a proprietary format, so transferring between simulation packages either requires custom software or is a laborious manual process.

Conductors and other equipment are referenced in the GIS system by a name; for example, 4/0 AAC OH would represent a 4/0 overhead aluminum conductor. Line impedance (positive, negative, and zero) is calculated from this name via the reference database. The lines and other impedance information are stored in the model database as the conductor name or impedance, referenced or calculated from the tool's conductor reference database as the master or entered into the model as impedance. Both techniques can cause errors if the reference database on which they depend is inaccurate.

Dummy or redundant sections of conductors or switchgear can create errors throughout the distribution system model once imported from GIS because they are often represented incorrectly as very short sections of a low-impedance conductor, potentially with missing or incorrect phasing. These will often be flagged as unfed sections; although they might not stop the simulation from converging, they will increase the time required for convergence because the system will be trying to solve for an unfed area. SynerGEE Electric and other distribution analysis tools offer a process to clean models of unfed sections and redundant paths and to report on connectivity issues.

Common distribution equipment other than conductors (e.g., transformers, regulators and protection devices) is often stored in a reference database where similar data entry accuracy issues are possible.

DEW interfaces have a number of algorithms that can be used to automatically correct physics modeling errors that are made in GIS systems, such as modeling a switch, which really has two voltages, with a single node, or modeling a junction, that really has three current flows, with just two edges.

A further source of error in GIS and input data comes from DG and distributed resources. Data interfaces among software and hardware and different types of information are often lacking; for example, although physical DG locations might be included in the GIS database, the electrical linkage might not be represented after exporting the model to distribution analysis software.

### **5.1.2 Switching and Topology Errors**

In the existing distribution system, switch status is often unknown at both the three-phase and single-phase levels. There may be SCADA data on certain devices, and if switching operations have taken place the correct status may be noted, but often because of the time lag between data extraction and switching operations, the status will be incorrect. This issue results in part from lack of physical and electronic communication among parties and in part from lack of upkeep of GIS systems. Incorrect topology will result in incorrect load allocation and placing; the importance of this error will grow as more distributed resources are present which will cause topology to change more frequently.

### **5.1.3 Customer and Load Databases**

The distribution system is a combination of three-phase trunks plus three-phase and single-phase laterals, which feed customers through distribution to low-voltage transformers. At a residential scale, each of those transformers feeds one to 50 customers. The system is often assumed to be a balanced load (i.e., load is equal across all three phases), but in reality lack of visibility of distributed resources has led to an increase in phase imbalances, which in turn leads to inefficiencies, power-quality issues, protection concerns, and stress on utility equipment. Although software tools may allow for analysis of unbalanced systems, this feature has not been considered essential until recently. Thus, knowledge of an imbalance and its location are not

passed intelligently to planners for remedial action. An imbalance will often be uncovered during pilot measurement scheme analysis or during system restoration or a planned upgrade.

Load modeling for steady state has different issues from those associated with load modeling for dynamic and transient impacts. In steady state, in both today's distribution grid and the future distribution grid, various factors impact load, such as load makeup (HVAC, EVs), other DER resources, and customer type (industrial, commercial, residential).

For steady-state load modeling, load data can be extracted from numerous databases including customer information systems, which are often linked to billing. Customer information data are imported with GIS data, and load is then allocated to a measured substation or feeder. Load could also be aggregated and allocated as a percentage of the kVA capacity of the low-voltage customer transformer. Customer numbers can often be paired with transformer size. These numbers, if accurate, give a snapshot in time but no representation of how the load changes over time with DR. In addition, weather data will impact both the 24-hour load shape and, increasingly, generation shape.

Accurate knowledge or measured information is needed regarding the customer impedance mix (thermal, non-thermal, manageable, and industrial loads as well as generation sources and EVs). It is essential to validate simulation tools using this information. The majority of distribution models do not allow for this type of validation although specialized and open-source tools such as GridLab-D are developing functionality in this area.

## **5.2 Data-Transfer Errors**

As discussed throughout this report, a large number of software tools containing varied applications are available for modeling the distribution system. These tools are used for purposes such as interconnecting renewables, planning new developments and capital expenditures, and analyzing capacity. Typically no single tool is used for all the types of power system analysis that are performed. A utility's software purchases are not usually strategic decisions that involve all departments but rather are driven by the need for a particular application. For example, a tool's strength might be in performing detailed analysis of components of load or of a particular device, but it might be weak larger applications such as switching between multiple feeders or analysis of time series and dynamic impacts for high penetration of renewable resources.



In addition, as noted earlier, even if a tool has particular functional strengths, its results are only as accurate as the data that are input to the tool, the degree to which its model has been validated, and the reliability of the interpretation of its results. Errors are prevalent in all of these realms (Martinez et al. 2011, Lindl et al. 2013, Kroposki 2011)

In view of the above limitations, a user, when deciding to purchase software, must determine what functions are required for the particular analysis that is needed and whether the tool must be all-encompassing. For example, the user might be concerned with generation variability but not component behavior. In this example a tool with strength in long-term dynamics would be advantageous.

Interconnection analysis, which has the goal of determining the impacts and ultimately the permissibility of interconnecting a specific DG resource to the grid, is a good example of how users might have to stretch the capabilities of software or cobble together several types of software to achieve the goal. In this case, users might attempt to make a particular piece of software designed for other purposes fit the needs of the interconnection analysis because the format of data supplied by the utility or interconnecting party is compatible with that particular tool. Alternately a utility might purchase multiple pieces of software to fit the types of data supplied or functions required, resulting in duplicative functions (and expenditures).

Numerous types of power systems analysis may be requested by a utility during a system impact or interconnection study. This analysis depends in part on the existing percentage of PV capacity, the amount of PV being installed, and the peak load. Currently the interconnection process is not standardized (Kroposki 2011, McGranaghan et al. 2008). In future distribution grid scenarios, interconnection analyses might consider a greater level of control than is analyzed today as well as interaction of inverters with other interconnected devices (including voltage control, EVs, and DR). **Table 2** outlines the potential applications of selected types of software for commonly requested PV interconnection analysis functions.

**Table 2. Software packages commonly used for PV interconnection analysis**

<b>Simulation Type</b>	<b>Time Scale</b>	<b>Analysis Type</b>	<b>Software Options</b>
Load flow, thermal limitations, voltage rise, etc.	Hours, weeks, year	Steady state	SynerGEE Electric, PSLF, PSSE, CymDist
Variability impact, OLTC cycling	Seconds, minutes	Quasi-steady state	SynerGEE Electric, PSLF, PSSE, CymDist
Protection and coordination	Sub-cycle, seconds, point in time	Steady state & dynamic	Aspen Distriview, Oneliner, SynerGee Electric, PSCAD
Transient voltage impacts (ground fault over voltage, etc.)	Sub-cycle	Transient	PSCAD, PSPICE, SIMULINK
Ride-through, Switching impacts, dynamic response	Cycle and sub-cycle	Dynamic	PSCAD, PSSE , PSLF, CymDist
Harmonics & power quality	Seconds, sub-cycle	Dynamic and quasi-steady state	PSCAD, PSS/Sincal, SynerGEE (radial only)

A consistent distribution system model expedites the analysis process and allows for “what-if” analyses that enable planners and operators to stay ahead of system change, maximize technical and economic grid performance, and minimize the risks of stranded assets and unknown errors.

When data are exchanged among applications, the naming and identification of components are of major concern. Even within a utility there can be problems with ensuring common identification of substations and equipment. Because substation names might not be identical from one application to the next, they must be matched by hand to connect the entire model. The accuracy of this process largely depends on the tool being used. Changes in original data cannot be automatically input to other applications that utilize the source data or an output based on those data. This results in projects being delayed and a significant amount of time lost while engineers complete these conversions. Significant time savings and other gains could be achieved if data sets used a common format. Because high-impact conditions such as weather, peaking and minimum loads, and contingencies are best managed with combined and integrated planning

techniques, standardization of the format for data and data transfer is a key growth area in simulation and analysis packages. A number of standardized data formats have been proposed. The most prevalent and well developed is the International Electrotechnical Commission (IEC) common information model (CIM), which is discussed in Section 5.3.3.

The lack of a standardized data format also means that few power system software packages can seamlessly exchange distribution and transmission information. Distribution systems can often be aggregated and simplified to create an equivalent representation in the transmission format, but details for single-phase and unbalanced analyses, which are essential in renewable integration studies, are lost. As previously mentioned, the lack of communication between network operators and planners results in utilities purchasing an ever-growing number of software packages to do various tasks, thereby reducing efficiency as users must convert data to and from different formats for different phases of analysis performed using different tools. Validated analytical abilities across both transmission and distribution are essential, but software integration is a major bottleneck (McMorran and Stewart et al. 2012, Lambert et al. 2010, McMorran and Ault et al. 2006, IEC 2010).

**Table 3** lists the import and export capabilities of the software packages reviewed in this report.

## **5.1 Solutions to Accuracy Barriers**

As noted earlier, accuracy problems result from errors in data sources and errors in data transfer between tools. Below we discuss a sample set of solutions to these errors. Key ways reduce the impact of errors in data sources are to validate models against measured data and create baseline models that all utility entities agree to use. The measured sources may themselves have errors, so we propose validating those sources against other measurements. Finally, we discuss the use of CIM as a vehicle for standardizing the format for transferring data among models.

### **5.1.1 Model Validation**

With numerous and growing sources of error, validation of models essential to ensure accurate simulation of the distribution system. Key validation elements will include re-creating steady-state performance, running simulation scenarios for which measured data are available, and locating sources of error. Dynamic measured response and analysis for selected operations can be used with enhanced measurement to determine whether devices are characterized effectively.

With future advanced measurement sources providing data, the validation process for distribution models could be as shown in **Figure 8**.

**Table 3. Formats Supported by Each Type of Software**

<b>Software</b>	<b>PSS/Sincal</b>	<b>DigSilent</b>	<b>CymDist</b>	<b>DEW</b>	<b>SynerGEE</b>
<b>CIM (and version)</b>	YES	Yes	YES	YES	No
<b>Other software Packages Directly</b>	PSS/E, CymDist,	PSSE, PSSU, PSS/Adept, UCTE-ENTSO-E, NePlan, NEtcal (input only) Bi-directional – PSS/E export	None	PSSE, PSLF	No
<b>Other</b>	Hub File, UCTE ASCII, DGS Exchange format, DVG exchange format	XML, IEEE, Access, Excel,		XML, IEEE, Access, Excel, SQL	No
<b>Export format</b>	Same as Import	XML, PSSE, CIM, ASCII	Access	Metafile, XML, Flat file Dew format	No
<b>Capability to 'hook' other models</b>	Yes Matlab/ Simulink	Yes Matlab/ Simulink	Yes Matlab/ Simulink	Yes Matlab/ Simulink Steady state only	No

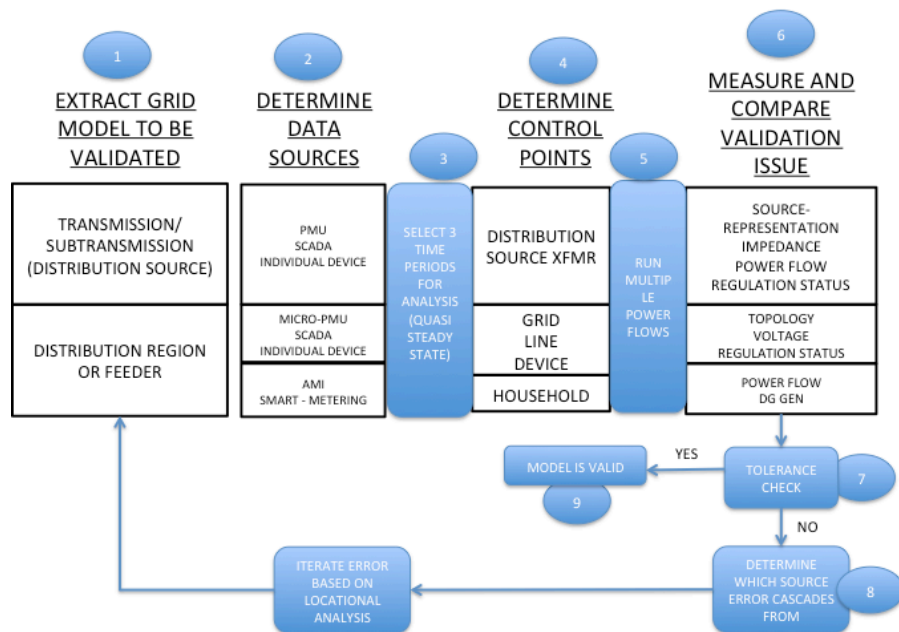

**Figure 8. Potential validation process for distribution planning models**

Adoption of a baselining process can reduce the need to constantly extract and update distribution models. For transmission this is normally done either once a year or every six months, depending on what major work is completed on the grid. A baselined model is considered to represent the up-to-date status of the grid for purposes of planning studies because validation on shorter time frames is currently difficult. A baselined model allows planners to build on a verified source. Baselining is a short-term solution for improving accuracy. Once more measured data are available, models can be validated and updated more frequently.

Energy management system data are updated at control centers on a second-by-second basis, but they are based on a limited number of control points, such as transmission substations, phasor measurement units, central renewable and conventional generation sites, and selected line points. Transmission planning models are baselined monthly or every six months and usually select three load conditions along with various generation conditions for analysis.



The following standards relevant to this study have either been developed or are in development;

- IEC 61970: Common Information Model (CIM)/Energy Management
- IEC 61968: Common Information Model (CIM)/Distribution Management (619680- 1-4,9,11,13)

Interoperability tests performed in creating these standards now include the unbalanced distribution network. CIM will not cover every requirement for data exchange between the applications mentioned in the previous section because CIM's focus, from a distribution perspective, has been primarily on power-flow and steady-state analysis along with integration of systems for asset management, work management, customer support, advanced metering infrastructure, etc. However, CIM provides the foundation for a common definition of the network itself and a data model that can be extended to accommodate the requirements of more advanced analysis applications. A CIM extension to represent dynamic data characteristics is also under development (IEC 2010).

CIM provides a standard format for electrical networks that can be balanced or unbalanced distribution and transmission. A number of existing software vendors support CIM and the CIM XML format with EPRI, UCA, and ENTSO-E sponsored interoperability tests (ENTSO-E 2010, McMorran and Stewart et al. 2012). Many of the vendors participating in this transmission network model exchange test also provide applications for the distribution network analysis described in Section 3.

A common format for both distribution and transmission network modeling would enable the integration these models without requiring either to be simplified or reduced and thereby lose precision. The most recent versions of CIM being developed by IEC contain specific components for modeling the unbalanced network and the properties for the individual-phase components. The most recent draft of CIM contains all the data required for the increasingly complex analyses needed for smart distribution networks. In addition, CIM's structure enables the model to be extended to support further cases that serve the goal of enhancing the standard. Thus, with CIM, the building blocks for data standardization for the modernized grid are in place.

## 6 Summary and Conclusions

Significant development has gone into commercial and open-source analysis tools for the distribution grid. These tools are developing concurrently with distribution grid technology. A holistic approach is needed in these tools that accounts for the entirety of the distribution grid and the changing nature of its load, including increasing penetration of renewable and distributed energy resources and other complexities such as EVs. Simply applying transmission modeling concepts to the distribution grid will not produce accurate results.

We reviewed models that perform the following types of analysis and elements:

- Steady state
- Quasi steady state (time series)
- Dynamic
- Transient
- Transmission versus distribution
  - Balanced versus unbalanced models
- Data import/export and GUIs

Based on our analysis, we conclude that:

- Distribution grid data sources are limited; increasing the availability of measured data and its integration into distribution grid modeling tools for validation and other purposes would improve the tools' accuracy and allow for more concentration on developing the tools rather than on their accuracy.
- Tools are only as useful as their ease of use and the skill of their users; interfaces must become more intuitive and better understood than is currently the case.
- No single tool can do every job, but tools can be separated into the categories of those that perform transient analysis and those that perform all other distribution grid analyses. As analysis grows more complex with mixing of dynamic and steady-state concepts, tools that can address both types of analysis are particularly powerful. Transient aspects of the grid are complex in and of themselves, so it is reasonable to have separate tools to address transient analysis.



- Modeling of detailed grid components such as inverters is well understood in the three-phase balanced realm and in transmission tools but not well understood in the distribution realm. As the number of inverters on the distribution grid grows, these devices might in future require more detailed control and coordination analysis as well as generic modeling that accounts for their proprietary aspects.
- Many tools do not communicate or transfer data with each other. Standardization of data into common formats such as CIM would be a positive step to rectify the limitations imposed by this lack of communication, but tool builders must adopt the common format for this solution to work. Although tool builders may be reluctant to share data formats for proprietary reasons, innovation will flourish if there is an open-source approach to formatting of grid models. Developers would be driven to incorporate enhanced features and usability if they could not rely on their proprietary data formats to hold users captive; this would, in turn, reduce the need (and associated costs) for utilities to purchase multiple different types of software to perform various analyses and work with data in various formats.
- As the distribution system evolves into a complex, active, controlled, automated resource, the depth of analysis required will evolve also, as will the need for higher-fidelity measurement devices. The applications of measured data will be numerous, including control of the grid, control of generation, improved fault restoration and better utilization of demand response resources.
- With regard to the ability of existing distribution analysis tools to meet the needs of the current and future distribution grid, we identified the following key work needed in simulation software development:
  - Incorporation of custom model package references (Simulink and standard component models)
  - Enhancement of model accuracy
  - Incorporation of control references
  - Addition of short time scales for analysis of dynamic and transient capability
- Standardization of data input and output standardization (CIM)

An effective package that would address the majority of analysis needs for the future distribution grid should have the following features:

- Clear concise user interface
- Displays of results in geographical, schematic, tabular, and graphical formats that are highly customizable
- A time-series package with slow dynamic analysis including time delays of key voltage-regulating equipment
- Data hooks for measurement devices, including advanced sensors, to enable configuration and validation
- A dynamic package that allows the user to create custom models and hook into other packages such as Simulink for generic modeling of devices such as inverters, storage, etc.
- Data and model import/export capability for standardized formats (e.g., CIM)

A complete network model must include a representation of the low-voltage distribution system. Whether that is in the form of a measured data input point, a validated representation, or a full network model will depend on the distribution planning needs in a particular area.

As noted above, dynamic and time-series analyses are of great importance for the future distribution grid, so the combination of these features is a powerful package.

Aggregation of inverters and DER has been at best and rarely done at the distribution transformer level. In the next 10 years, this characteristic will become significantly variable, and measurement of dynamic characteristics for input to planning models will be essential.

We found that no current package is currently fully capable of meeting the steady-state, dynamic, and transient analysis needs of a future distribution grid, but at the same time not all packages are required for all applications. A fully comprehensive tool has the benefit that new models and model conversions are not required for different types of analysis, but tools with packages covering all areas of analysis might not be as effective as using individual tools for their best features once a standardized data format is adopted. For example, both PSS/Sincal and DigSilent have transient packages, but PSCAD appears to be a more effective tool for transient analysis. However, PSCAD cannot do the full distribution system representation that PSS/Sincal and DigSilent can do. In sum, a tool that has combined steady-state and dynamic capabilities would be effective in combination with a separate transient tool.

## References

- Adinolfi, F., F. Baccino, M. Marinelli, S. Massucco. Innovative Smart Grid Technologies (ISGT Europe). 2012. "Model of a real medium-voltage distribution system network for analysis of distributed generation penetration in a smart grid scenario." 3rd IEEE PES International Conference and Exhibition, Berlin, Germany. pp. 1 – 7. October.
- Alarcon-Rodriguez, A., E. Haesen, G. Ault, J. Driesen, and R. Belmans. 2008. Multi-objective planning framework for stochastic and controllable distributed energy resources. IET Renewable Power Generation, July.
- Alizadeh, M., A. Scaglione, Z. Wang. 2010. On the impact of Smart grid Metering infrastructure on load forecasting, Communication, Control, and Computing (Allerton). 48th Annual Allerton Conference Allerton, IL, pp. 1628 – 1636.
- American National Standards Institute (ANSI). 2011. Standard for Electric Power Systems and Equipment, Voltage Ratings (60Hz) C84.1-2011.
- Aspen. Distriview. Available on line at:  
[http://www.aspeninc.com/web/index27cb.html?option=com\\_content&view=article&id=87&Itemid=68](http://www.aspeninc.com/web/index27cb.html?option=com_content&view=article&id=87&Itemid=68)
- Auswin, G., P. Jahangiri, D. Wu, C. Cai, H. Zhao, D. C. Aliprantis and L. Tesfatsion. 2012, "Intelligent Residential Air-Conditioning System with Smart-Grid Functionality." IEEE Transactions on Smart Grid 3(4): 2240-2251.
- Bank, J., B. Mather, J. Keller, and M. Coddington. 2013. High Penetration Photovoltaic Case Study Report. Golden CO: National Renewable Energy Laboratory Report NREL/TP-5500-54742.
- Benhke, M., A. Ellis, and J. Keller. 2011. Model Makers. Power and Energy Magazine, May 9(3): 55-61.
- Bower, W., S. Gonzalez, A. Akhil, S. Kuszmaul, L. Sena-Henderson, C. David, R. Reedy, K. Davis, D. Click, H. Moaveni, L. Casey, M. Prestero, J. Perkinson, S. Katz, M. Ropp, A. Schaffer. 2012, Solar Energy Grid Integration Systems: Final Report of the Florida Solar Energy Center Team, Sandia NM, Sandia National Laboratory Report, SAND2012-1395, March.
- Bravo, R. 2013. "FIDVR Events Analysis", FIDVR Working Group Meeting, Tempe, AZ.
- Cooper Power Systems. CymDist software. Available on line at:  
<http://www.cyme.com/software/cymdist/>
- Coughlin, K., M.A. Piette, C. A. Goldman, and S. Kiliccote. 2009. "Statistical analysis of baseline load models for non-residential buildings." Energy and Buildings 41(4):374-381.
- Coughlin, K., M.A. Piette, C.A. Goldman, S. Kiliccote. 2008. Estimating Demand Response Load Impacts: Evaluation of Baseline Load Models for Non-Residential Buildings in California, Ernest Orlando Lawrence Berkeley National Laboratory Report, LBNL-63728, January.

- Davis, M.W., R. Broadwater, J. Hambrick. 2007. Modeling and Verification of Distributed Generation Equipment and Voltage Regulation Equipment for Unbalanced Distribution Power Systems. Golden CO: National Renewable Energy Laboratory subcontract report NREL/SR-581-41885. June.
- Davis, W., R. Broadwater, and J. Hambrick. 2007. Modeling and Verification of Distributed Generation Equipment and Voltage Regulation Equipment for Unbalanced Distribution Power Systems, Golden CO: National Renewable Energy Laboratory subcontract report NREL/SR-581-41885. June.
- DigSilent GMBH. DigSilent Power Factory. Available on line at: <http://www.DigSilent.de>
- Electric Power Research Institute (EPRI). 2012. Modeling High-Penetration PV for Distribution Interconnection Studies: Smart Inverter Function Modeling in OpenDSS, Available on line at <http://www.epri.com/abstracts/Pages/ProductAbstract.aspx?ProductId=00000000001024353>
- Electric Power Research Institute (EPRI). OpenDSS. Available on line at: <http://www.smartgrid.epri.com/SimulationTool.aspx>
- Electrical Distribution Design (EDD). DEW/ISM Software Product Overview. Available on line at: [www.edd-us.com](http://www.edd-us.com)
- Ellis, A. 2012. Modeling Distribution-Connected PV in Bulk System Studies. Distribution Connection PV Modeling Workshop, La Jolla CA, July.
- Ellis, A. 2011, Wind Dynamic Models, WECC Modeling Workshop, Salt Lake City, UT, June
- EMTP RV, EMTP-RV software, Available on line at: <http://emtp.com>
- ENTSO-E Final Report. 2010. "Energy management system application program interface (EMS-API) Part 452: CIM Transmission Network Model Exchange Profile." August.
- GE Software. PSLF. Available on line at: <http://www.geenergyconsulting.com/practice-area/software-products/pslf>
- Hossain, M.R., A.M.T. Oo, A.B.M.S. Ali, "Evolution of smart grid and some pertinent issues." Universities Power Engineering Conference (AUPEC), 2010 20th Australasian, Issue Date: 2010, On page(s): 1 – 6,
- Hummon, M., E. Ibanez, G. Brinkman, D. Lew. 2012. Sub-Hour Solar Data for Power System Modeling from Static Spatial Variability Analysis, Golden CO: National Renewable Energy Laboratory Contractor Report NREL/CP-6A20-56204. December. National Renewable Energy Laboratory.
- IEEE. PES Distribution Systems Analysis Subcommittee Radial Test Feeders, <http://ewh.ieee.org/soc/pes/dsacom/testfeeders.html> accessed on: March 2012
- Institute of Electrical and Electronics Engineers (IEEE). 2008. "Standard for Interconnecting Distributed Resources with Electric Power Systems (1547.2-2008)." IEEE Application Guide for IEEE Standard 1547.

- Institute of Electrical and Electronics Engineers (IEEE). 2012. Standard 1815-2012 for Electric Power Systems Communication-Distributed Network Protocol (DNP3).
- International Electrotechnical Commission (IEC). 2004. Standard 61850 for Power Utility Automation
- International Electrotechnical Commission. 2010. "Application integration at electric utilities - System interfaces for distribution management - Part 13: CIM RDF Model exchange format for distribution", IEC, Edition 1.0, June 2008
- Katiraei, K.F., J.R. Agüero, J.R. 2011. "Solar PV Integration Challenges." Power and Energy Magazine May-June 9(3):62-71.
- Keane, A., L.F. Ochoa, C.L.T. Borges, G.W. Ault, Task force on Distributed Generation Planning and Optimization. 2013. "State of the Art Techniques and Challenges Ahead for Distributed Generation Planning and Optimization" IEEE Transactions on Power Systems, May 28(2): 1493-1502.
- Keller, J., and B. Kroposki. 2010. "Understanding Fault Characteristics of Inverter based Distributed Energy Resources." Golden CO: National Renewable Energy Laboratory Report NREL/TP-550-46698. January. National Renewable Energy Laboratory.
- Kersting, W.H. R.C. Dugan. 2006. "Recommended Practices for Distributed System Analysis." Proceedings of the IEEE Power Systems Conference and Exposition. Atlanta, GA. pp 499-504. November
- Kosterev, D., A. Meklin, J. Undrill, B. Lesieutre, W. Price, D. Chassin, P. Bravo, and S. Yang. 2008. "Load Modeling in Power System Studies: WECC Progress Update." IEEE PES General Meeting Pittsburgh, PA July.
- Kroposki, B. 2011. Distribution System Modeling for High Penetration PV. Sacramento CA: High Penetration Solar Deployment Workshop, June 13.
- Lambert, E., A. Queric,. 2010. Use of CIM for EDF Distribution Automation. IEEE PES General Meeting Minneapolis, MN, pp. 1 – 4, July.
- Lindl, T., K. Fox, A. Ellis, and R. Broderick. 2013. "Integrated Distribution Planning Concept Paper," Interstate Renewable Energy Council, Available online at: <http://www.irecusa.org/wp-content/uploads/2013/05/Integrated-Distribution-Planning-May-2013.pdf>, May 2013
- Manitoba Hydro International Limited. PSCAD. Available on line at:, <https://hvdc.ca/pscad/>
- Martinez J.A., V. Dinavahi, M.H. Nehrir, X. Guillaud. 2011. Tools for Analysis and Design of Distributed Resources—Part IV: Future Trends. IEEE Transactions on Power Delivery, 26(3):1671-1680.
- Martinez, J.A., J. Martin-Arnedo, 2011. "Tools for Analysis and Design of Distributed Resources – Part I: Tools for Feasibility Studies, IEEE Task force on Analysis Tools", IEEE Transactions on Power Delivery, 26(3):1643-1652.
- Martins, V., C. Borges, 2011. Active Distribution Network Integrated Planning Incorporating Distributed Generation and Load Response Uncertainties. IEEE Transactions on Power Systems, Nov. 26(4): 2164-2172.

- McGranaghan, M., T. Ortmeyer, D. Crudele, T. Key, J. Smith, P. Barker. 2008. Renewable Systems Interconnection Study: Advanced Grid Planning and Operations. Sandia NM: Sandia National Laboratory Report: SAND208-0944 P, February.
- McMorran, A., E. Stewart, C. Shand, S. Rudd, G. Taylor. 2012. Addressing the Challenge of Data Interoperability for Off-Line Analysis of Distribution Networks in the Smart Grid, IEEE PES Transmission and Distribution Conference and Exposition, Orlando, FL. May.
- McMorran, A.W., G.W.Ault, I.M. Elders, C. Morgan, and J.R. McDonald. 2006. "A Common Information Model (CIM) Toolkit Framework implemented in Java." IEEE Transactions on Power Systems 21 (1):194-201.
- MilSoft. MilSoft Utility Solutions Available on line at:  
<http://www.energy.siemens.com/hq/en/services/power-transmission-distribution/power-technologies-international/software-solutions/pss-sincal.htm>
- Muljadi, E., Singh, V. Gevorgian, and R. Bravo. 2013. "Dynamic Model Validation of PV Inverters Under Short-Circuit Conditions." Golden CO: National Renewable Energy Laboratory report. April. NREL/CP-5500-57341.
- North American Electric Reliability Corporation. 2012. Power System Model Validation, A White Paper. December.
- Ochoa, L., A. Padilha-Feltrin, and G. Harrison. 2008. Evaluating Distributed Time-Varying Generation Through a Multiobjective Index. IEEE Transactions on Power Delivery, April 23 (2): 1132-1138.
- Office of the National Coordinator for Smart Grid Interoperability, National Institution of Standards and Technology (NIST). 2010. Framework and Roadmap for Smart Grid Interoperability Standards Release 2.0 Available on line at  
[http://www.nist.gov/smartgrid/upload/NIST\\_Framework\\_Release\\_2-0\\_corr.pdf](http://www.nist.gov/smartgrid/upload/NIST_Framework_Release_2-0_corr.pdf),  
 Gaithersburg MD: NIST Special Publication 1108R2.
- Open Grid Systems Ltd., CIMphony Software, Available on line at: <https://cimphony.com/content>
- Ortmeyer, T., R. Dugan, D. Crudele, T. Key, P. Barker. 2008. Renewable Systems Interconnection Study: Utility Models, Analysis and Simulation Tools. Sandia NM: Sandia National Laboratory Report: SAND2008-0945 P, February.
- P Plus Corporation, PPLUS Software, Available on line at  
<http://www.ppluscorp.com/models/pgem.html>
- Pacific Gas and Electric Company. "Voltage Tolerance Boundary." 1999 Available on line at:  
[http://www.pge.com/includes/docs/pdfs/mybusiness/customerservice/energystatus/powerquality/voltage\\_tolerance.pdf](http://www.pge.com/includes/docs/pdfs/mybusiness/customerservice/energystatus/powerquality/voltage_tolerance.pdf)
- Pacific Northwest National Laboratory. GridlabD. Available on line at: <http://www.gridlabd.org/>
- Piette, M.A., G. Ghatikar, S. Kiliccote, E. Koch, D. Hennage, P. Palensky, and C. McParland. CEC OpenADR-Version 1.0 Report. 2009. Open Automated Demand Response Communications Specification (Version 1.0). California Energy Commission, PIER Program. CEC-500-2009-063 and LBNL-1779E

- Presidents Council of Economic Advisors and US Department of Energy's Office of Electricity Delivery and Energy Reliability. 2013. Economic Benefits of Increasing Electric Grid Resilience to Weather Outages, Report to the Executive Office of the President of the United States. August.
- Rizy, D., R. Staunton. 2002. Evaluation of Distribution Analysis Software for DER Applications. Oak Ridge National Laboratory Report: ORNL/TM-2001/215. September 2002.
- Ropp, M., S. Perlenfein, D. Joshi, C. Mettler, M. Mills-Price, M. Scharf, K. Gubba Ravikumar, and G. Zweigle. 2012. "Synchrophasors for Island Detection." Proceedings of the 38th IEEE Photovoltaic Specialists Conference. June.
- Schneider, K.P., J.C. Fuller. 2010. "End use load modeling for distribution system analysis." Proceedings of the IEEE Power and Energy Society General Meeting, Minneapolis, MN. July 25-29, pp. 1-7.
- Siemens PTI. PSS/E , Available on line at:  
<http://w3.usa.siemens.com/smartgrid/us/en/transmission-grid/products/grid-analysis-tools/transmission-system-planning/pages/transmission-system-planning.aspx>
- Siemens PTI. PSS/Sincal software. Available on line at:  
<http://www.energy.siemens.com/hq/en/services/power-transmission-distribution/power-technologies-international/software-solutions/pss-sincal.htm>
- Stewart, E., T. Aukai, S.D.J MacPherson, B.P. Quach, and D. Nakafuji. 2012. "A realistic irradiance-based voltage flicker analysis of PV applied to Hawaii distribution feeders." IEEE PES General Meeting, San Diego, CA, July.
- Stewart, E., J. MacPherson, S. Vasilic, D. Nakafuji, and T. Aukai. 2012. Analysis of High-Penetration Levels of Photovoltaics into the Distribution Grid on Oahu, Hawaii: Detailed Analysis of HECO Feeder WF1. Golden CO: National Renewable Energy Laboratory subcontract report NREL/SR-5500-54494.
- SynerGEE Electric. DNV-GL Software. Available on line at: [http://www.gl-group.com/en/powergeneration/SynerGEE\\_Electric.php](http://www.gl-group.com/en/powergeneration/SynerGEE_Electric.php)
- Taylor, C.W. 1999. Improving Grid Behavior, IEEE Spectrum Magazine, Jun 36(6): 40-45
- Taylor, G.A., M. R. Irving, N. Nusrat, R. Liao, and S. Panchadcharam. 2011. "Smart distribution network operation: Emerging techniques and standards." IEEE PES General Meeting, Detroit, Michigan, July 25-28.
- Zhang, S., M.R. Irving 1994. Enhanced Newton-Raphson algorithm for normal, controlled and optimal powerflow solutions using column exchange techniques. IEE Proceedings-Generation, Transmission and Distribution. 1994. pp. 647-657. November