

# Lawrence Berkeley National Laboratory

## Lawrence Berkeley National Laboratory

**Title**

CHARGED PARTICLE IDENTIFICATION WITH MODULES OF THE PLASTIC BALL

**Permalink**

<https://escholarship.org/uc/item/8d3090fh>

**Author**

Gutbrod, H.H.

**Publication Date**

1980-10-01

Peer reviewed



# Lawrence Berkeley Laboratory

UNIVERSITY OF CALIFORNIA

To be presented at the IEEE Nuclear Science Symposium,  
Orlando, FL, November 5-7, 1980

CHARGED PARTICLE IDENTIFICATION WITH MODULES OF THE PLASTIC  
BALL

H.H. Gutbrod, M.R. Maier, H.G. Ritter, A.I. Warwick,  
F. Weik, H. Wieman, and K.L. Wolf

October 1980

## TWO-WEEK LOAN COPY

*This is a Library Circulating Copy  
which may be borrowed for two weeks.  
For a personal retention copy, call  
Tech. Info. Division, Ext. 6782.*

RECEIVED  
LAWRENCE  
BERKELEY LABORATORY

DEC 11 1980

LIBRARY AND  
DOCUMENTS SECTION



LBL-11797 c. 2

CHARGED PARTICLE IDENTIFICATION WITH MODULES OF THE PLASTIC BALL

H.H. Gutbrod, M.R. Maier\*, H.G. Ritter, A. I. Warwick,  
F. Weik, H. Wieman, and K.L. Wolf†

Gesellschaft für Schwerionenforschung, Darmstadt, West Germany,  
and Nuclear Science Division, Lawrence Berkeley Laboratory  
University of California, Berkeley, California

Summary

The low energy pion channel (LEP) at LAMPF was used to calibrate the response of modules of the Plastic Ball detector for positive pions and protons. The detection efficiency was measured at various energies. The resolution and efficiency were found to be independent of the point at which the particle entered the detector. Scattered out particles could be well detected by including neighbouring detectors in the analysis.

Introduction

The Plastic Ball is a detector system designed for the study of relativistic heavy ion collisions at the Bevalac. It covers a solid angle of  $4\pi$  and consists of 815  $\Delta E$ -E scintillator telescopes. A detailed description of this detector has been published elsewhere<sup>1</sup>.

Fig. 1 shows a single module. The  $\Delta E$  segment is a 4 mm thick  $\text{CaF}_2$  (Eu) crystal<sup>2</sup> and the E segment is

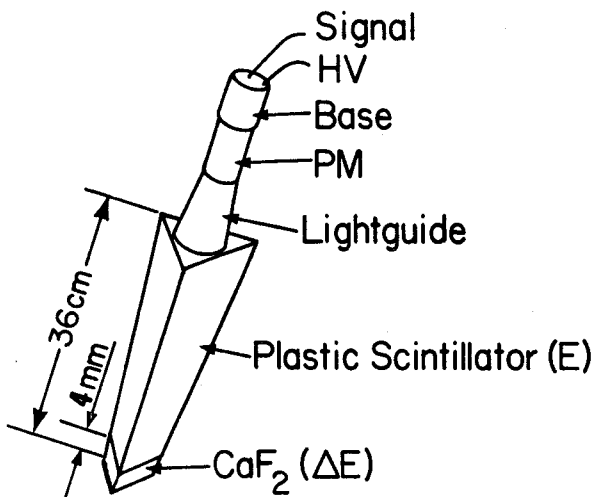

XBL 8010-12667

Fig. 1. Plastic Ball Module.

a 36 cm long plastic scintillator<sup>3</sup>. The signals of both parts are read out by one common photomultiplier where the E segment serves as a light guide for the  $\Delta E$  signal. The  $\Delta E$  and E information can be distinguished from one another by virtue of the considerably different decay times of the respective scintillators. It has been proven that such a telescope is capable of identifying the hydrogen and helium isotopes<sup>1</sup>. A further goal of the detector system is the identification of low energy positive pions.

Energies can be measured only for the case where the particles are stopped in the detector volume: up

to 210 MeV for p and up to 980 MeV for  $^4\text{He}$ . Depending on the projectile energy in relativistic heavy ion reactions the pion yield may be lower than that of protons by orders of magnitude<sup>4</sup>. In a simple  $\Delta E$ -E contour plot the pions would disappear in the background produced by heavier particles. Therefore, an additional tag signal is needed for pion identification. That is provided in the case of positive pions by measuring the occurrence of a positron signal from the delayed  $\pi^+$  decay over a period of 10  $\mu\text{s}$ . A stopped  $\pi^+$  decays into a  $\mu^+$  and a  $\nu$  ( $\tau = 26 \text{ ns}$ ) and the  $\mu^+$  decays subsequently into  $e^+$  and  $\bar{\nu}$  ( $\tau = 2.2 \mu\text{s}$ ).

To study and calibrate this detection scheme for  $\pi^+$ , an experiment has been performed at the low energy pion beam (LEP) at LAMPF with the further goal of getting some values for the detection efficiency for pions and protons.

Experimental Setup

As shown in fig. 2, an assembly of 13 Plastic Ball modules was placed in the beam defined by two 2 x 2 cm scintillation counters. Different kinds of

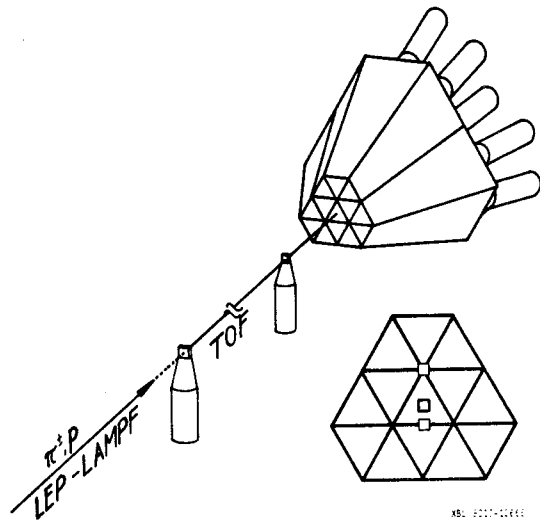

XBL 8010-12668

Fig. 2. Experimental setup.

particles with the same momentum (especially pions and protons) were selected by setting appropriate windows on the time of flight spectrum between those two counters. Thirteen modules were used, since then the central module is completely surrounded by all possible neighbours as shown in the front view in fig. 2. This configuration specifically permits studying the two dominating effects determining the detection efficiency: a) the scattering out of particles during the slowing down process and b) the detection probability for the positrons stemming from the  $\pi^+$  decay. (These positrons are emitted isotropically with a maximum energy of 53 MeV and have a high probability of leaving the module). Both effects make it necessary to take information in the

\*University of Marburg, Marburg, West Germany

†Argonne National Laboratory, Argonne

neighbouring modules into account and to reconstruct the event. By having particles impinge on the module in the three different points indicated in fig. 2 (centre point, side of two modules and corner of six modules), the dependence of the reconstruction efficiency on the geometrical entry point can be determined.

The energy of the incident pions was varied between 60 MeV and 300 MeV. Simultaneously the admixture of protons in the pion beam was used to calibrate the counters for protons with energies up to 75 MeV.

Fig. 3 shows schematically the electronics used for this test. Each photomultiplier output is fanned

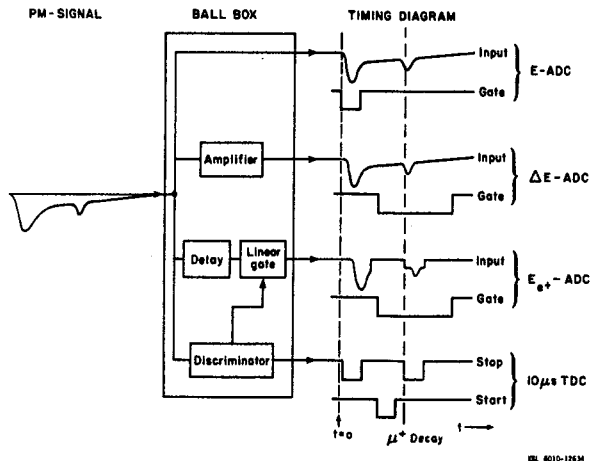

Fig. 3. Electronics diagram.

out to three ADC channels and one discriminator. The separation of E and  $\Delta E$  signals is performed by applying different gate pulses of the appropriate duration ( $2 \mu s$  for  $\Delta E$  and  $50 ns$  for E) to the two different ADC's, the  $\Delta E$  gate being delayed by  $200 ns$  relative to the E gate. The third ADC measures the energy of the positron from the pion decay. This is very important since the  $\Delta E$  signal, the true value of which is of the order of  $3 MeV$ , also may include the positron energy of up to  $53 MeV$ . In order to obtain the true  $\Delta E$  signal, the electron energy has to be subtracted. The output of the discriminator is fed to a TDC with a range of  $10 \mu s$  which is started after the occurrence of the direct E signal and therefore registers only decay times.

#### Analysis and Results

The analysis of the data requires several steps. A  $\Delta E$  signal in a module indicates that a charged particle has entered this particular module. The tail of the fast E scintillator pulse extends into the  $\Delta E$  gate interval and necessitates a correction to the  $\Delta E$  value, which amounts to about 13% of the measured value of E. An analogous correction (5%) has to be applied to the E signal in order to take the admixture of the fast components of the  $\Delta E$  pulse into account. These two corrections transform the inclined  $\Delta E$ -E axes shown in fig. 6, ref. 1, into a rectangular coordinate system. In the case of a pion and the presence of a decay positron during the opening time of the gate, the  $\Delta E$  signal has to be corrected. This correction can be done with satisfactory precision. For events where a positron is registered the  $\Delta E$  resolution after the correction is only 30% worse than for events with no decay positron. The  $\Delta E$  signal indicates, as mentioned above, the entrance of a particle into a

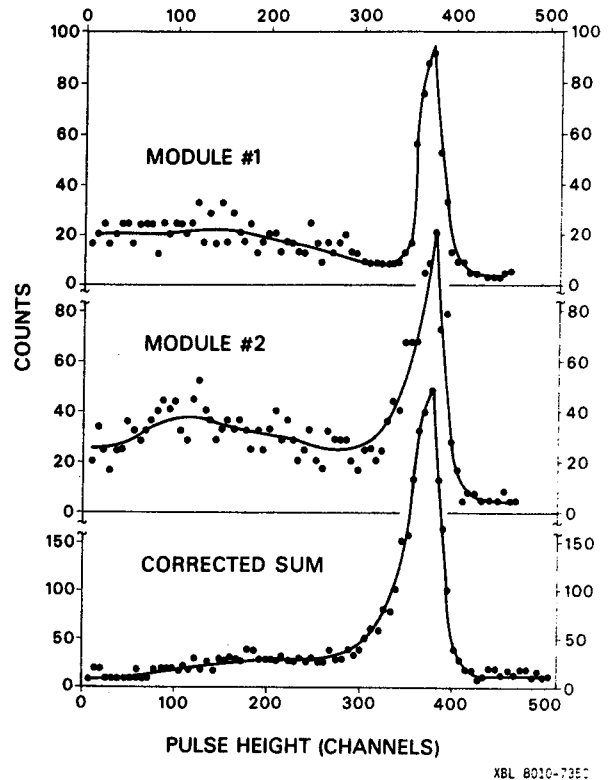

Fig. 4. Energy spectra measured for a monoenergetic pion beam entering between two modules as measured in the two individual counters (top two spectra) and after reconstruction (lower spectrum).

detector module. To check, however, whether this particle or its decay product have been stopped in the same module, neighbouring counters have to be inspected for possible losses. Fig. 4 shows the result of this procedure in a case where the beam entered between two modules, i.e., where the probability for scattering out is high. The top two spectra show the energy spectrum of a monoenergetic pion beam as detected in the two individual modules and the lowest spectrum shows the result of the reconstruction. A comparison of the detection efficiencies measured for the three different entry points into the module assembly yields the gratifying result that all scattering out can be reconstructed.

A very important task of the test was to obtain energy calibration curves for pions and protons. As can be seen from fig. 5, the calibration for pions and protons differ slightly since the quenching is larger for protons. In the ranges covered by the

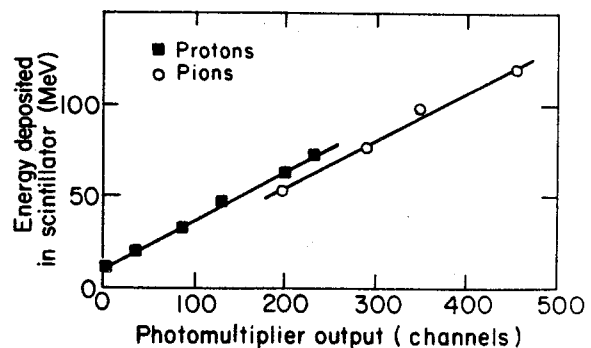

Fig. 5. Energy calibration.

measurement (low energy part for protons and high energy part for pions) the light output is surprisingly linear with energy. This was not expected, since the geometrical light collection along the particle path as measured on the surface with an electron source is not constant, the light collection near the  $\text{CaF}_2$  crystal being about a factor of 2 better than near the phototube.

It had been proven earlier in tests at the Bevalac that the energy resolution of the plastic scintillator and of the  $\text{CaF}_2$  crystal is good enough for particle identification<sup>1</sup>. For protons of 75 MeV the energy resolution in the plastic scintillator is 3.5 MeV FWHM, and in the  $\text{CaF}_2$ , where the protons lose about 8 MeV, the resolution is 1 MeV FWHM.

Fig. 6 shows the  $\Delta E$ -E contour plot for all measured pion and proton energies. The two branches

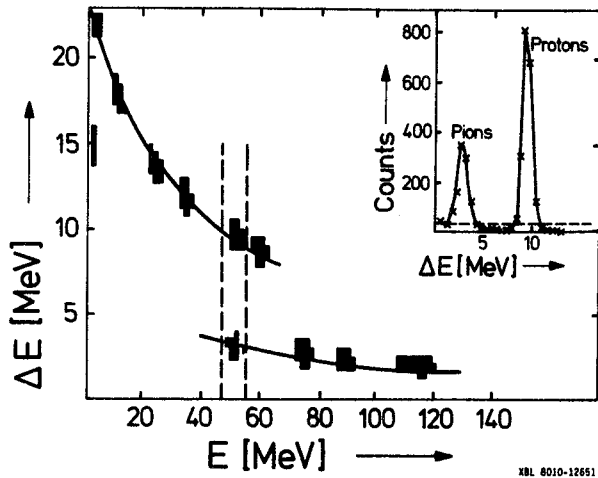
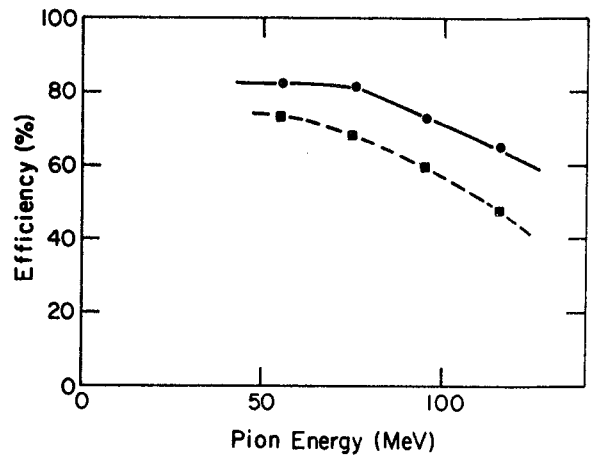

Fig. 6.  $\Delta E$ -E contour plot.

are well separated. The spectrum in the upper right corner is a projection of the interval indicated by dashed lines on the  $\Delta E$ -axis. It illustrates in a more quantitative way the quality of the particle discrimination. The dashed line at 32 counts in this spectrum indicates the intensity threshold in the contour plot.

The probability of detecting a proton within 10% of its correct energy is about 90% for the low energy protons measured.

The detection efficiency for pions is given in fig. 7. The solid curve indicates the probability of measuring a decay time in the range between 200 ns and 10  $\mu\text{s}$ . Theoretically, that probability is 90% and is independent of energy. Due to the discriminator threshold at about 4 MeV and the fact that the



XBL 8010-2269A

Fig. 7. Pion detection efficiencies.

continuous electron spectrum extends beyond that energy, 80% of the pions can be tagged at low energies. However, this number decreases with higher energy since in this case the stop point is closer to the end of the scintillator and the probability of the electrons leaving the counter system without giving a detectable signal increases. The dashed line in fig. 7 shows the probability of detecting a pion with an appropriate decay time and within 10% of the correct energy. Both efficiency curves have been corrected for accidental stops in the TDCs. The number of accidentals can be determined as flat background under the exponential decay curve.

#### Acknowledgements

We would like to thank Dr. L. Rosen and the staff of LAMPF for their strong support and hospitality. This work was supported in part by the Division of Nuclear Physics of the Office of High Energy and Nuclear Physics of the U.S. Department of Energy under Contract W-7405-ENG-48.

#### References

1. M.R. Maier, H.G. Ritter and H.H. Gutbrod, IEEE Transactions on Nuclear Science, Vol. NS-27, No. 1 (1980)
2. Harshaw Chemical Company, Solon, Ohio
3. C.I. Industries, Tokorosawa, Japan. Scintillator equivalent to NE114
4. K.L. Wolf, H.H. Gutbrod, W.G. Meyer, A.M. Poskanzer, A. Sandoval, R. Stock, J. Gosset, C.H. King, G. King, Nguyen Van Sen, and G.D. Westfall, Phys. Rev. Letters 42, 1448 (1979)