

# Lawrence Berkeley National Laboratory

## Lawrence Berkeley National Laboratory

### **Title**

RECHARGEABLE MOLTEN-SALT CELLS

### **Permalink**

<https://escholarship.org/uc/item/9jd9q84m>

### **Author**

Cairns, Elton J.

### **Publication Date**

1980-10-01



# Lawrence Berkeley Laboratory

UNIVERSITY OF CALIFORNIA

## ENERGY & ENVIRONMENT DIVISION

Presented at the 158th Meeting of the Electrochemical Society, Third International Symposium on Molten Salts, Physical Electrochemistry Division, Hollywood, FL, October 5-10, 1980

RECHARGEABLE MOLTEN-SALT CELLS

Elton J. Cairns

October 1980

RECEIVED  
LAWRENCE  
BERKELEY LABORATORY

JUL 17 1981

LIBRARY  
DOCUMENT

### TWO-WEEK LOAN COPY

This is a Library Circulating Copy  
which may be borrowed for two weeks.  
For a personal retention copy, call  
Tech. Info. Division, Ext. 6782

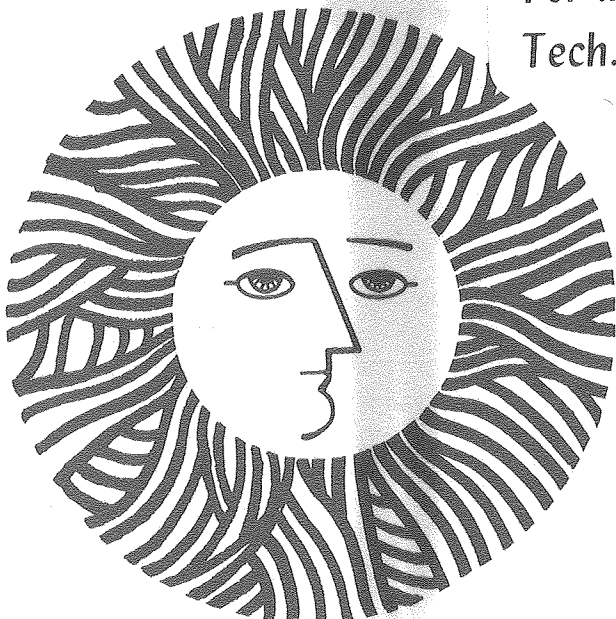

944c

LBL-11090 e.2

## DISCLAIMER

This document was prepared as an account of work sponsored by the United States Government. While this document is believed to contain correct information, neither the United States Government nor any agency thereof, nor the Regents of the University of California, nor any of their employees, makes any warranty, express or implied, or assumes any legal responsibility for the accuracy, completeness, or usefulness of any information, apparatus, product, or process disclosed, or represents that its use would not infringe privately owned rights. Reference herein to any specific commercial product, process, or service by its trade name, trademark, manufacturer, or otherwise, does not necessarily constitute or imply its endorsement, recommendation, or favoring by the United States Government or any agency thereof, or the Regents of the University of California. The views and opinions of authors expressed herein do not necessarily state or reflect those of the United States Government or any agency thereof or the Regents of the University of California.

RECHARGEABLE MOLTEN-SALT CELLS

Elton J. Cairns  
Lawrence Berkeley Laboratory, and  
University of California  
Berkeley, CA 94720

Presented at

158th Meeting of The Electrochemical Society  
3rd International Symposium on Molten Salts  
Physical Electrochemistry Division  
Hollywood, FL  
October 5-10, 1980

This work was supported by the U.S. Department of Energy  
under Contract W-7405-ENG-48.



## RECHARGEABLE MOLTEN-SALT CELLS

Elton J. Cairns  
Lawrence Berkeley Laboratory, and  
University of California  
Berkeley, CA 94720

### Abstract

Rechargeable molten-salt cells offer the opportunity for achieving higher specific energy than is available from ambient-temperature cells (200 W-h/kg), and a specific power in excess of 100 W/kg. Two main types of rechargeable cells employing molten salts are being developed: those with a molten salt as the sole electrolyte, and those with a combination of a solid electrolyte and a molten salt electrolyte. The status, recent research, and current problems for each of several systems in the above two categories are discussed. The most advanced systems in the first category are  $\text{LiAl/FeS}$  and  $\text{Li}_4\text{Si/FeS}_2$ ; in the second category,  $\text{Na/Na}_2\text{O}\cdot x\text{Al}_2\text{O}_3/\text{S}$  is the most advanced system. Interesting new cells continue to be proposed, having special features that may justify development. Overall, rechargeable molten-salt cells are making good progress. The main generic problems requiring additional work include corrosion-resistant current collectors and seals, ceramic electrolytes that resist degradation and thermal cycling, inexpensive corrosion-resistant porous separators, and improved electrode designs.

### Introduction

During the last decade, rechargeable molten-salt cells have been the subject of a wide range of investigations, from the most fundamental to highly applied. As time passes, the variety of molten-salt cells increases, resulting in a broader range of choices with regard to operating temperature, reactants, and cell characteristics. On first impression, it would seem that so much research and development activity is perhaps inappropriate, because of the inconvenience of accommodating the elevated-temperature requirement of molten-salt cells. Closer examination reveals that some (but by no means all) molten-salt cells offer the opportunity for the achievement of specific energy and specific power values significantly higher than those available from ambient-temperature rechargeable cells: 200 W-h/kg, and 100+ W/kg. Molten-salt electrolytes allow the use of alkali metal-containing negative electrodes (not possible with aqueous electrolytes), and allow very high concentrations of the alkali metal cation as the charge-carrying species, providing for low mass transport overvoltages. In addition, the elevated temperatures provide for

high exchange-current densities and low charge-transfer overvoltages (compared to the ambient-temperature values).

Two main types of rechargeable cells employing molten salts are being developed: those with a molten salt as the sole electrolyte, and those with a combination of a solid electrolyte (the main electrolyte) and a molten-salt mixture of reactant and subsidiary electrolyte. Examples of cells of each type are given in Table I. The operating temperatures for these cells range from about 450°C for the lithium/iron sulfide cells to about 250°C for the sodium/sulfur tetrachloride cell. In the next section, the status of a number of the cells listed in Table I will be presented and discussed.

<sup>2</sup> Table I. Rechargeable Cells with Molten-Salt Electrolytes

- A. Cells with molten salts as the sole electrolyte  
 LiAl/LiCl-KCl/FeS  
 LiAl/LiCl-KCl/FeS<sub>2</sub>  
 Li<sub>4</sub>Si/LiCl-KCl/FeS<sub>2</sub>  
 Ca<sub>2</sub>Si/LiCl-NaCl-CaCl<sub>2</sub>-BaCl<sub>2</sub>/FeS  
 Ca<sub>2</sub>Si/LiCl-NaCl-CaCl<sub>2</sub>-BaCl<sub>2</sub>/FeS<sub>2</sub>
- B. Cells with molten salts as the subsidiary electrolyte  
 Na/Na<sub>2</sub>O·xAl<sub>2</sub>O<sub>3</sub>/Na<sub>2</sub>S<sub>n</sub>-S  
 Na/Na-glass/Na<sub>2</sub>S<sub>n</sub>-S  
 Na/Na<sub>2</sub>O·xAl<sub>2</sub>O<sub>3</sub>/SCl<sub>3</sub>AlCl<sub>4</sub> in NaCl-AlCl<sub>3</sub>  
 Li/Li<sub>2</sub>O/LiNO<sub>3</sub>-KNO<sub>3</sub>/V<sub>2</sub>O<sub>5</sub>

Status of Rechargeable Molten-Salt Cells of Current Interest

The LiAl/LiCl-KCl/FeS Cell.

This cell has been undergoing research and development since the early 1970's, as a derivative of the very high specific energy Li/LiCl-KCl/S cell, (1-3) (2600 Wh/kg theoretical) which had liquid electrodes. Difficulties with solubility of polysulfides in the electrolyte, and retention of lithium in its current collector resulted in the use of the solid LiAl and FeS electrodes. There was, of course, a decrease in the theoretical specific energy to 458 Wh/kg, corresponding to the added weights of Al and Fe, and the decreased cell voltage (1.3 vs 2.4 V). This disadvantage is at least partially compensated by the very good stability of performance brought about by the use of solid electrodes of extremely low solubility in the electrolyte.

The overall cell reaction is

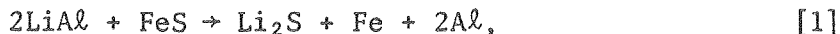

which takes place in two stages:

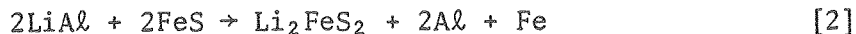

The cell potentials for Reactions 2 and 3 are essentially the same, 1.3 V at 450°C, so a single-plateau discharge curve is to be expected.

Various designs of LiAl/FeS cells have been operated, one of which is shown in Figure 1. (4) These cells have porous LiAl negative electrodes containing a screen-like current collector, and are in good electrical contact with the steel or stainless steel cell container. The separator, which prevents the electrodes from contacting each other, and must resist attack by the cell reactants and electrolyte, usually has been boron nitride cloth or felt. Recently, progress has been made in the use of relatively inexpensive MgO powder in place of the separator. (5) The positive electrode is a porous composite of FeS particles, graphite powder, and a metallic sheet or screen-like current collector (usually Fe). This porous mass may be molded into a sheet form, or bonded with a carbonaceous cement. Fine-mesh screens or ceramic cloths are used to prevent loss of particles from the positive electrode. Various numbers of positive and negative electrodes can be interleaved to produce "multiplate" cells, with all electrodes of each type connected in parallel, increasing the capacity of the cell (Figure 1 shows 3 negative, 2 positive electrodes). The cell container is welded closed, and has a leak-tight feedthrough to prevent ingress of air and moisture which react with lithium.

Cells of the type described above yield voltage vs capacity curves as shown in Figure 2. (6) The specific energy of such cells falls into the range 60-100 Wh/kg at 30 W/kg, the higher value corresponding to 22% of theoretical, and is for multiplate cells with capacities of about 320 Ah. (7) The specific energy of multiplate cells as a function of the number of complete discharge/recharge cycles is shown in Figure 3. (7) The cells experienced a specific energy decline of about 40% after about 300 cycles. A typical lifetime for the longer-lived cells is 5000 hours.

The specific power achievable with LiAl/FeS cells has been somewhat lower than desired for electric vehicle applications, so attention is being devoted to improved current collectors, especially for the FeS electrode. Also, the specific power can be increased by promoting better, more complete wetting of the BN separator by the electrolyte. This has been accomplished by the use of wetting aids such as LiAlCl<sub>4</sub> in small amounts (≈20 mg/cm<sup>2</sup>). (7) Other approaches to reducing the cell internal resistance include the use of cobalt sulfides and copper sulfides as additives to the FeS electrode.

In the cycling of cells, it has been found that full recharge is impeded by the formation of djerfischerite (LiK<sub>6</sub>Fe<sub>24</sub>S<sub>26</sub>Cl). (8) The



formation of this material can be reduced or eliminated by operation at higher temperatures and lower potassium ion concentrations in the electrolyte, hence an increased interest in lithium-richer electrolytes (the originally-used electrolyte was the eutectic, 58.8 m/o LiCl-41.2 m/o KCl, mp = 352°C).

The Li-Al electrode has been found to suffer a loss of capacity and performance as a result of the agglomeration with cycling of the originally finely-structured alloy. This behavior is being investigated in detail, and the possible beneficial effects of alloying agents are being examined. (9)

The most common mode of failure of LiAl/FeS cells is shorting, resulting from swelling and extrusion of the FeS electrode. The degree of swelling of the active material is a function of the particle size of the FeS, the electrode composition, the electrolyte composition, and the structural design of the electrode (containment). Optimization of these variables results in cells that can be operated for over 5000 hours and more than 500 cycles.

The progress of the LiAl/FeS cell toward the marketplace will be determined to a significant degree by cost. At the present time, the most expensive component of the cell is the BN separator (the woven BN cloth has been \$5000/m<sup>2</sup>; the BN felt is less expensive, but still far from a reasonable goal of \$10-20/m<sup>2</sup>). An approach to reducing this cost is the use of a powder such as MgO in place of the BN. This is similar to the paste electrolyte used in molten carbonate fuel cells, and in earlier work with lithium/chalcogen cells. (10,11)

Other areas requiring attention in the continuing development of the LiAl/FeS cell include the need for an inexpensive leak-free electrical feedthrough, excellent cell capacity matching (or a means of charge balance control), and a good thermal control system. Work in these areas has already begun, and 10-cell batteries of 320 Ah cells have been tested. (7) Even if these issues are successfully addressed, competition from ambient temperature rechargeable cells could have a strong influence on the degree to which the LiAl/FeS system finds application. This is true because specific energies above 70 Wh/kg have been reported for some ambient-temperature cells, vs about 100 Wh/kg for LiAl/FeS. The status is summarized in Table II.

#### The Li<sub>4</sub>Si/LiCl-KCl/FeS<sub>2</sub> Cell.

This cell is very similar to the one discussed above in many respects, including operating temperature (~450°C), however an important difference is the significantly higher specific energy of this one (944 Wh/kg vs 458 Wh/kg). The higher specific energy is traceable to the much lower equivalent weights of the reactants, and the higher cell voltage for the first half of the discharge. The overall cell reaction is:

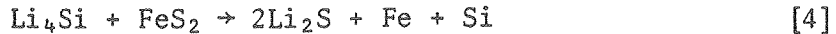

This reaction gives the impression of greater simplicity than is actually the case. Some perspective concerning the reactions of the  $\text{FeS}_2$  electrode can be gained by examining Figure 4, which shows the  $450^\circ\text{C}$  isothermal section of the Li-Fe-S phase diagram. (8) The path A-Z-X-B is followed by the composition of the  $\text{FeS}_2$  electrode during discharge at  $450^\circ\text{C}$ , and the steps in the reaction are: (12)

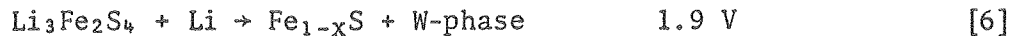

Reaction 6 involves only a few percent of the total charge of Reaction 4 (see Figure 4). Next, the solid-solution W-phase and

Table II

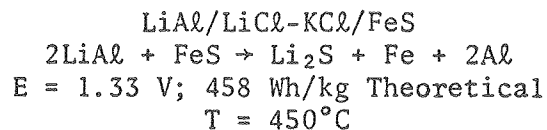

STATUS

|                 |                        |
|-----------------|------------------------|
| Specific Energy | 60-100 Wh/kg @ 30 W/kg |
| Specific Power  | 60-100 W/kg, peak      |
| Cycle Life      | 300+ @ 100% DOD        |
| Lifetime        | 5000+ h                |
| Cost            | >\$100/kWh             |

RECENT WORK

- Multielectrode cells
- LiX-rich electrolyte
- BN felt separators
- Wetting agent for separators
- Powder separators-MgO
- Batteries of 320 Ah cells
- Improved current collectors

PROBLEMS

- Low specific energy
- Low voltage per cell
- Cell shorting major failure mode
- Electrode swelling and extrusion
- Agglomeration of Li-Al with cycling
- Capacity loss
- High separator cost
- Leak-free feedthroughs
- Thermal control

and  $\text{Fe}_{1-x}\text{S}$  are converted to  $\text{Li}_2\text{FeS}_2$ , at which point, half of the overall reaction is completed (2 electrons per  $\text{FeS}_2$ ):



This is followed by:



The lithium-silicon negative electrode also is involved in a number of phase changes as the cell is operated. The phases involved at  $450^\circ\text{C}$  are  $\text{Li}_4\text{Si}$ ,  $\text{Li}_{15}\text{Si}_4$ ,  $\text{Li}_{21}\text{Si}_8$ ,  $\text{Li}_2\text{Si}$ , and  $\text{Si}$ . (13) These phases provide for a multi-plateau discharge curve. The reversible potentials (measured vs lithium) at  $450^\circ\text{C}$  are given in Table III.

Table III. Reversible Potentials for the Li-Si Electrode at  $450^\circ\text{C}$  (13)

| Phases in Equilibrium                                 | Volts vs Li |
|---|-------------|
| $\text{Si-Li}_2\text{Si}$                             | 0.326       |
| $\text{Li}_2\text{Si-Li}_{21}\text{Si}_8$             | 0.277       |
| $\text{Li}_{21}\text{Si}_8\text{-Li}_{15}\text{Si}_4$ | 0.149       |
| $\text{Li}_{15}\text{Si}_4\text{-Li}_{22}\text{Si}_5$ | 0.042       |
| $\text{Li}_{22}\text{Si}_5\text{-Li (Sat. with Si)}$  | 0.001       |

This electrode is capable of operating at high current densities ( $0.2\text{A}/\text{cm}^2$ ) with good utilization (70%+), and apparently does not agglomerate as does the  $\text{LiAl}$  electrode.

$\text{Li}_4\text{Si}/\text{FeS}_2$  cells comprised of two porous electrodes of  $\text{Li}_4\text{Si}$  powder with reticulated nickel current collectors, and a porous  $\text{FeS}_2$  electrode comprised of  $\text{FeS}_2$  and graphite powders with graphite cloth and molybdenum expanded mesh current collectors have been operated. (14) These cells contained BN cloth separators and  $\text{LiCl-KCl}$  eutectic electrolyte. A capacity of 70-80 Ah was typical, and specific energy values up to 182 Wh/kg (19% of theoretical) were obtained, as shown in Figure 5. Cycle lives of over 700, at 100% depth of discharge were obtained, along with lifetimes of about 11,000 hours. These results are presented in Figure 6.

Detailed post-test examination of  $\text{Li}_4\text{Si}/\text{FeS}_2$  cells revealed some attack of the molybdenum current collector for the  $\text{FeS}_2$  electrode, and the cell container (presumably by the Si). A continuing issue of importance is the identification of inexpensive electronically-conductive materials that resist attack in the  $\text{FeS}_2$  and  $\text{Li}_4\text{Si}$  electrodes (for current collectors), and inexpensive non-conductive separator materials stable to  $\text{FeS}_2$  and  $\text{Li}_4\text{Si}$ . As with the  $\text{LiAl}/\text{FeS}$  cell, inexpensive, leak-free feedthroughs are needed.

Recent work has included the operation of small bipolar  $\text{Li}_4\text{Si}/\text{FeS}_2$  cells, and two-cell batteries. (15) This work, if successfully implemented in full-scale systems, could play an important role in decreasing the number of (presumably expensive) feedthroughs needed in a battery system.

Overall, the  $\text{Li}_4\text{Si}/\text{FeS}_2$  is in an earlier stage of development than the  $\text{LiAl}/\text{FeS}$  cell, but offers the opportunity for 200 Wh/kg, which is more than double that achieved by any aqueous rechargeable system, and double that for the  $\text{LiAl}/\text{FeS}$  cell. This is probably the performance margin appropriate for the inconvenience of operating an elevated-temperature system. A condensed summary of the status of  $\text{Li}_4\text{Si}/\text{FeS}_2$  is presented in Table IV.

Table IV

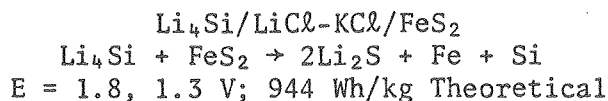

Status

|                 |   |
|-----------------|---|
| Specific Energy | 120 Wh/kg @ 30 W/kg<br>180 Wh/kg @ 7.5 W/kg |
| Specific Power  | 100 W/kg, peak                              |
| Cycle Life      | 700 @ 100% DOD                              |
| Lifetime        | ~15,000 h                                   |
| Cost            | >\$100/kWh                                  |

Recent Work

Bipolar cells  
 Li-Si electrodes  
 BN felt separators  
 70 Ah cells

Problems

Materials for  $\text{FeS}_2$  current collector  
 Leak-free feedthroughs  
 High internal resistance  
 Low-cost separators needed  
 Thermal control

The  $\text{Ca}_2\text{Si}/\text{LiCl}-\text{NaCl}-\text{CaCl}_2-\text{BaCl}_2/\text{FeS}_2$  cell.

This system represents an effort to replace the lithium of the system just discussed by calcium, which is less costly and more abundant. The calcium-silicon alloy can be operated at 460°C over the range  $\text{Ca}_2\text{Si}$  to at least  $\text{CaSi}_2$  in a Ca-containing electrolyte (the best composition to date is 29%  $\text{LiCl}$ -20%  $\text{NaCl}$ -35%  $\text{CaCl}_2$ -16%  $\text{BaCl}_2$ ). (7) This electrode has supported only relatively low current densities,

and modifications are being sought. One such is  $\text{CaAl}_{1.2}\text{Si}_{0.4}$  (equivalent weight = 83.7 vs 54.1 for  $\text{Ca}_2\text{Si}$ ), which yields the voltage-capacity curves shown in Figure 7. (16) The theoretical specific energy for this cell is about 560 Wh/kg (vs 750 Wh/kg for  $\text{Ca}_2\text{Si}/\text{FeS}_2$ ).

The overall reactions for the  $\text{Ca}_2\text{Si}/\text{FeS}_2$  cell is:

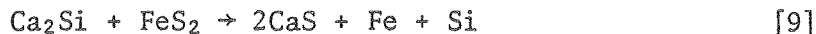

This reaction takes place stepwise over the voltage range 2.0 to 1.2 V. Some cells having capacities up to 100 Ah have been operated, but low specific energy values ( $\sim 40$  Wh/kg) and short cycle lives ( $\sim 60$ ) have been obtained. This system is in too early a stage of investigation to assess whether or not it will compete with the  $\text{Li}_4\text{Si}/\text{FeS}_2$  cell. Considerable improvements in performance and lifetime are necessary before such judgments can be made. The present status of work on this system is summarized in Table V.

Table V

$\text{Ca}_2\text{Si}/\text{LiCl}-\text{NaCl}-\text{CaCl}_2-\text{BaCl}_2/\text{FeS}_2$   
 $\text{Ca}_2\text{Si} + \text{FeS}_2 \rightarrow 2\text{CaS} + \text{Fe} + \text{Si}$   
 $E = 2.0-1.2$  V;  $\sim 750$  Wh/kg Theoretical  
 $T = 480^\circ\text{C}$

Status

|                 |                    |
|-----------------|--------------------|
| Specific Energy | 67 Wh/kg @ 13 W/kg |
| Specific Power  | 15 W/kg            |
| Cycle Life      | 60                 |
| Cost            | too early          |

Recent Work

$\text{BaCl}_2$  added to electrolyte  
 Larger cells - 100 Ah  
 Co added to  $\text{FeS}_2$   
 Ca-Al-Si electrode

Problems

Low specific power  
 Low current densities  
 BN separator not stable with  $\text{Ca}_2\text{Si}$   
 Rapid capacity loss

The  $\text{Na}/\text{Na}_2\text{O} \cdot x\text{Al}_2\text{O}_3/\text{Na}_2\text{S}_n$ -S Cell.

This is the cell most commonly referred to as the sodium/sulfur cell. The sodium polysulfide is included in the designation above to emphasize the fact that  $\text{Na}_2\text{S}_n$  is a molten-salt electrolyte as well as

an electrode reactant. The Na/Na<sub>2</sub>O·xAl<sub>2</sub>O<sub>3</sub>/Na<sub>2</sub>S<sub>n</sub>-S cell has been under development for over a decade. (17) It has been the first rechargeable cell of significance to make use of a solid electrolyte (Na<sub>2</sub>O·xAl<sub>2</sub>O<sub>3</sub>, 5 ≤ x ≤ 11), called beta alumina, and a molten-salt electrolyte (Na<sub>2</sub>S<sub>x</sub>). The solid electrolyte is used in the form of a closed-end tube, usually with the sodium inside it. The sulfur, with its graphite felt current collector, is kept on the outside of the tubular electrolyte, in the annular space between the solid electrolyte and the metal cell case. One such cell design is shown in Figure 8. (18) The cell must be hermetically sealed to avoid reaction of molten sodium with oxygen or moisture. A typical operating temperature is 350°C.

In the fully-charged condition, essentially all of the sodium is in the sodium compartment of the cell, and the sulfur electrode consists of nearly sodium-free sulfur, which is a poor conductor of electrons and ions. As the cell is discharged, sodium is oxidized to form sodium ions which pass through the electrolyte, and react with sulfur and electrons to form sodium polysulfides, Na<sub>2</sub>S<sub>n</sub>, which have a low solubility in sulfur. Because of this, the sodium polysulfides form a separate liquid phase, and serve as an electrolyte, transferring sodium ions, and as a reactant ultimately reaching the overall stoichiometry Na<sub>2</sub>S<sub>3</sub>, at which point Na<sub>2</sub>S<sub>2</sub> precipitates. This point is designated the end of discharge, or 100% depth of discharge.

As the cell is charged, the sodium polysulfides are converted to sulfur. Difficulties have been encountered in attempting to obtain full recharge because an insulating layer of sulfur forms on the surface of the beta alumina tube. Various approaches have been taken to ameliorate this problem, including the use of specially shaped graphite current collectors, the addition of C<sub>6</sub>N<sub>4</sub> to the sulfur to impart conductivity, and the use of graphite current collectors of graded resistance to appropriately distribute the electrochemical reaction zone.

After small laboratory cells (up to 20 Ah) had achieved acceptable life and performance, scale-up to 100-200 Ah was performed. These cells have demonstrated specific energy values of 85-140 Wh/kg, specific powers of 60-130 W/kg and cycle lives of 200-1500, depending on the cell size and design. Figure 9 shows the capacity of a Na/S cell as a function of the number of cycles. A few batteries of up to 10 kWh have been tested (e.g. reference 19), but the lifetimes of batteries have been relatively short.

The current problems being investigated for the improvement of Na/Na<sub>2</sub>S<sub>n</sub>-S cells include the search for inexpensive corrosion-resistant metal alloys that can serve as the cell container exposed to sulfur, and corrosion-resistant coatings for use on the sulfur container. Electronically-conductive ceramics such as doped TiO<sub>2</sub> are being evaluated as current collectors in sulfur-core cells. The ceramic electrolyte (β''-Al<sub>2</sub>O<sub>3</sub>) remains a very expensive item; work is

being done on the use of lower-cost starting materials and processing. An alternative electrolyte, called Nasicon ( $\text{Na}_{1+x}\text{Zr}_2\text{Si}_x\text{P}_{3-x}\text{O}_{12}$ ) is being investigated, but cell lifetimes have been shorter than with  $\beta''\text{-Al}_2\text{O}_3$ . A problem common to almost all Na/ $\text{Na}_2\text{S}_n$ -S cells is their inability to be cooled down and reheated without damage or performance loss. Frequently, the electrolyte or a ceramic seal is broken. Cracks and breakage of the ceramic electrolyte and its seals are the major cause of cell failure, even without thermal cycling.

The Na/ $\beta''\text{Al}_2\text{O}_3$ / $\text{Na}_2\text{S}_n$ -S cell has reached a relatively advanced state of development, and there are several pilot facilities for cell production in operation. Experience with small batteries of cells is beginning to accumulate, and larger batteries will be prepared in test quantities during the next few years. The status of this system is presented in Table VI.

Table VI

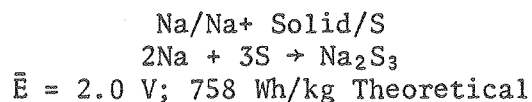

Status

|                 |                        |
|-----------------|------------------------|
| Specific Energy | 85-140 Wh/kg @ 30 W/kg |
| Specific Power  | 60-130 W/kg peak       |
| Cycle Life      | 200-1500               |
| Lifetime        | 3000-15,000 h          |
| Cost            | >\$100/kWh             |

Recent Work

- Batteries, ~10 kWh
- $\text{C}_6\text{N}_4$  additive to S
- Ceramic ( $\text{TiO}_2$ ) electronic conductors
- Shaped current collectors
- Tailored resistance current collectors
- Sulfur-core cells
- $\text{Na}_{1+x}\text{Zr}_2\text{Si}_x\text{P}_{3-x}\text{O}_{12}$
- Thermocompression bonded seals

Problems

- Corrosion-resistant material for contact with S
- Low cost seals
- Low cost electrolyte
- Specific power is low
- Thermal cycling

The Na/Na<sup>+</sup> glass/Na<sub>2</sub>S<sub>n</sub>-S Cell.

This cell operates according to the same principles and phase diagram as the cell discussed just above. The main differences are the substitution of a sodium-ion-conductive borate glass for the ceramic. Because the ionic conductivity of the glass is about a factor of 10<sup>4</sup> lower than that of β''-Al<sub>2</sub>O<sub>3</sub>, it is necessary to use very thin electrolyte layers. These take the form of thin, hollow fibers, and are incorporated into a cell structure as shown in Figure 10. (20) This cell design is very interesting because it provides a very large area of glass electrolyte with a very thin wall, allowing practical currents to be obtained at low current densities. Also, mass transport is required only over short distances (perhaps 100 μm).

Implementation of the design shown in Figure 10 requires the development of a highly reliable, durable seal of the thousands of glass fibers to a glass or ceramic tube sheet (glass is currently favored). Current collection is provided in the sulfur electrode by an aluminum foil (with a thin molybdenum or carbon coating to reduce corrosion). Most of the experience with this cell has been obtained with 6 Ah cells, but improvements in lifetime have justified recent work with a 40 Ah cell.

The problems with this version of the Na/Na<sub>2</sub>S<sub>n</sub>-S cell are similar to those discussed for the ceramic-electrolyte version. Also, there are problems associated with the development of optimum glass compositions for the tube sheet, such that a good seal is achieved, while having sufficient strength to avoid sagging. A status summary for this cell is given in Table VII.

The Na/Na<sub>2</sub>O·xAl<sub>2</sub>O<sub>3</sub>/SCL<sub>3</sub>AlCl<sub>4</sub> in AlCl<sub>3</sub>-NaCl Cell.

One of the more recently-investigated cells makes use of β''Al<sub>2</sub>O<sub>3</sub> and a low-melting mixture of AlCl<sub>3</sub> and NaCl as electrolytes. (21) The positive-electrode reactant is SCl<sub>3</sub><sup>+</sup> present as SCL<sub>3</sub>AlCl<sub>4</sub>. This cell is operated at temperatures near 250°C, and offers a relatively high potential of 4.2 V. The overall cell reaction is:



Note that sulfur undergoes a valence change of four: from S<sup>+4</sup> to S<sup>0</sup>. The theoretical specific energy for this reaction is 563 Wh/kg. It is also possible to reduce sulfur to S<sup>-2</sup>, at a somewhat lower voltage.

Simple glass laboratory cells have been operated, with capacities of up to a few ampere hours, yielding voltage charge or capacity curves as shown in Figure 11. (21) It is too early to evaluate specific energy and specific power capabilities for this system; more practical



Table VII

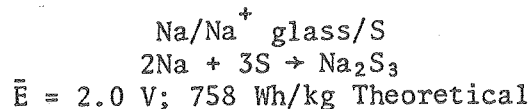

Status (6 Ah cells)

|                 |                   |
|-----------------|-------------------|
| Specific Energy | n.a.              |
| Specific Power  | n.a.              |
| Cycle Life      | 500 (75-100% DOD) |
| Lifetime        | 9000h             |
| Cost            | >\$100/kWh        |

Recent Work

Improved tube sheet and seal to tubes  
Mo coating on Al foil  
40 Ah cells

Problems

Sagging of tube sheet  
Seal to tubes  
Feedthroughs  
Coating on Al  
Compatibility of tubes and tube sheet

cell designs will be required first. Laboratory cells have operated for about 475 cycles and 7000 hours before failure.

Some of the problems encountered include the corrosiveness of the positive electrode reactant mixture toward metals (tungsten is used as the current collector), the slow wetting of the  $\beta$ -Al<sub>2</sub>O<sub>3</sub> by the sodium, the high vapor pressure of the AlCl<sub>3</sub>, and cracking of the  $\beta$ -Al<sub>2</sub>O<sub>3</sub>. The status of this cell is shown in Table VIII. This system could offer advantages where reduced operating temperatures (below the typical 350-450°C) and higher cell voltage (fewer cells for a given system voltage) are important. Work with more practical cell hardware will be needed for a more complete evaluation.

The Li/Li<sub>2</sub>O/LiNO<sub>3</sub>-KNO<sub>3</sub>/V<sub>2</sub>O<sub>5</sub> Cell.

A very recent report of a lower-temperature molten salt cell with a lithium electrode (22,23) makes use of a solid lithium or lithium-aluminum electrode with a very thin Li<sub>2</sub>O film which acts as a solid lithium-ion conducting electrolyte. The main electrolyte is the LiNO<sub>3</sub>-KNO<sub>3</sub> eutectic (mp = 135°C), and the positive electrode is V<sub>2</sub>O<sub>5</sub> which can intercalate Li. Because of the fact that lithium melts at 180°C, the temperature range for operation is rather narrow: 135-180°C.

Table VIII

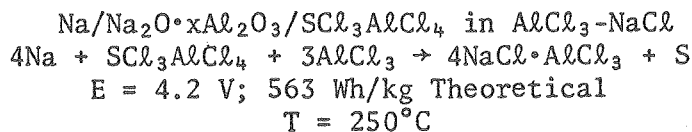

Status: glass lab cells only (4 Ah)

|                 |                                     |
|-----------------|-------------------------------------|
| Current Density | 20 mA/cm <sup>2</sup> @ 3.5 V       |
| Power Density   | 150 mW/cm <sup>2</sup> max. @ 2.5 V |
| Cycle Life      | 475 @ 100% DOD                      |
| Lifetime        | 7000 h                              |
| Cost            | too early                           |

Recent Work

Larger cells - 4 Ah  
Less expensive current collectors

Problems

Sodium wetting  
Vapor pressure  
Corrosion of metals and some electrolytes  
Electrolyte cracking  
Overcharge?

The overall cell reaction is:



For x = 1, the theoretical specific energy is 500 W-h/kg, at an average cell voltage of 3.5 V.

This combination of lithium with the nitrate melt imposes certain restrictions: a narrow range of operating temperatures 135-180°C, and a narrow range of potentials for the positive electrode. Above 4.2 V, oxygen and NO<sub>2</sub> are evolved from the positive electrode; below 2.6 V, nitrate is reduced to nitrite plus oxide. Also, there is a small corrosion current at the lithium electrode, corresponding to the dissolution of Li<sub>2</sub>O by the nitrate melt.

It is too early to tell if this exploratory work will lead to a lower-temperature lithium cell of practical interest.

Conclusions

Overall, good, solid progress is being made in the research and development of rechargeable molten-salt cells. Full-size cells, and a few full-size batteries have been demonstrated. Cell lifetimes of up to about two years have been achieved for some systems. In

general, specific energy values are lower than desirable, but 180 Wh/kg has been achieved with a  $\text{Li}_4\text{Si}/\text{FeS}_2$  cell.

Materials developments will probably set the pace of progress for the systems discussed above. Inexpensive, corrosion-resistant current collector materials for use with positive electrodes are needed for all of these systems. Corrosion-resistant container materials are also important. All these systems need leak-free feed-throughs that resist alkali metals and highly oxidizing conditions. Inexpensive separators that resist lithium attack are important for all of the lithium-containing systems. The development of a lithium-ion conducting solid electrolyte would add flexibility for many cells, and might make a Li/S cell feasible, offering the possibility of a very high specific energy (perhaps 500 Wh/kg; the theoretical value is 2600 Wh/kg).

#### REFERENCES

1. E.J. Cairns and H. Shimotake, *Science*, 164, 1347 (1969).
2. E.J. Cairns, J.P. Ackerman, P.D. Hunt, and B.S. Tani, presented at The Electrochemical Society Meeting, Cleveland, Ohio, October, 1971, Abstract No. 48; see also Extended Abstracts, p. 118.
3. E.J. Cairns, H. Shimotake, E.C. Gay, M.L. Kyle, and R.K. Steunenberg, presented at the International Society of Electrochemistry Meeting, Stockholm, Sweden, August 28-September 2, 1972.
4. P.A. Nelson, D.L. Barney, R.K. Steunenberg, A.A. Chilenskas, E.C. Gay, J.E. Battles, F. Hornstra, W.E. Miller, M.F. Roche, H. Shimotake, R. Hudson, R.J. Rubeschko, and S. Sudar, Progress Report for the Period October 1977-September 1978, Argonne National Lab Report 78-94, November, 1978.
5. T. Olszanski and H. Shimotake, presented at The Electrochemical Society Meeting, Pittsburgh, Pennsylvania, October, 1978, Abstract No. 53; see also Extended Abstracts 78-2 (1978).
6. H. Shimotake, W.J. Walsh, E.S. Carr, and L.G. Bartholme, in Proceedings of the 11th IECEC, Volume 1, American Institute of Chemical Engineers, New York, 1976, p. 473.
7. Argonne National Laboratory, Annual DOE Review of the Lithium/Metal Sulfide Battery Program, June, 1979.
8. M.F. Roche, L.E. Ross, C.C. Sy, S.K. Preto, L.G. Bartholme, and P.F. Eshman, Progress Report for the Period October 1978-March 1979, Argonne National Lab Report No. 70-39, May, 1979, pp. 94-106.

9. A.K. Fischer and D.R. Vissers, presented at The Electrochemical Society Meeting, Hollywood, Florida, October, 1978, Abstract No. 88; see also Extended Abstracts 80-2, 240 (1980).
10. E.J. Cairns and R.K. Steunenber, in Progress in High-Temperature Physics and Chemistry, Volume 5, C.A. Rouse, ed., Pergamon Press, New York, 1973, p. 63.
11. E.J. Cairns, H. Shimotake, and A.K. Fischer, Argonne Reviews, 5, 87 (1969).
12. Z. Tomczuk and A. Martin, Progress Report for the Period October 1978-September 1979, Argonne National Lab Report No. 79-94, March, 1980, pp. 142-151.
13. R.A. Sharma and R.N. Seefurth, Journal of The Electrochemical Society, 123, 1763 (1976).
14. E.J. Zeitner and J.S. Dunning, in Proceedings of the 13th IECEC, Society of Automotive Engineers, Warrendale, Pennsylvania, 1978, p. 697.
15. T.G. Bradley, in Proceedings of the 15th IECEC, American Institute of Aeronautics and Astronautics, New York, 1980, p. 228.
16. S.K. Preto, L.E. Ross, N.C. Otto, J.F. Lomax, and M.F. Roche, "Calcium/Iron Disulfide Secondary Cells," to be published in Proceedings of the 16th IECEC, Atlanta, Georgia, 1981.
17. N. Weber and J.T. Kummer, in Proceedings of the Annual Power Sources Conference, 21, 37 (1967).
18. General Electric Review of the Advanced Battery Development Program for Electric Utility Application, May 16, 1979.
19. W. Fischer, H.B. Gels, F. Gross, K. Liemert, and H. Meinhold, in Proceedings of the 14th IECEC, American Chemical Society, Washington, D.C., 1979, p. 710.
20. C.A. Levine, in Proceedings of the 10th IECEC, Institute of Electrical and Electronic Engineers, New York, 1975, p. 621.
21. G. Mamantov, R. Marassi, M. Matsunaga, Y. Ogata, J.P. Wiaux, and E.J. Frazer, Journal of The Electrochemical Society, 127, 2319 (1980).
22. J. Poris, I.D. Raistrick, and R.A. Huggins, in Proceedings of the Symposium on Lithium Batteries, The Electrochemical Society, Pennington, New Jersey, 1981.

23. I.D. Raistrick, J. Poris, and R.A. Huggins, in Proceedings of the Symposium on Lithium Batteries, The Electrochemical Society, Pennington, New Jersey, 1981.
24. Ford Aerospace & Communications Corporation, Annual DOE Review of the Sodium-Sulfur Battery Program, April 22, 1980.

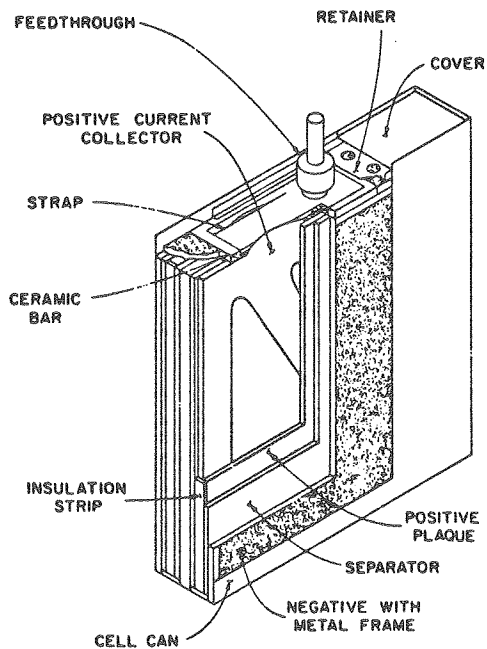

XBL 802-8073

Figure 1. Cutaway view of LiAl/FeS cell being developed at Argonne National Lab. (4)

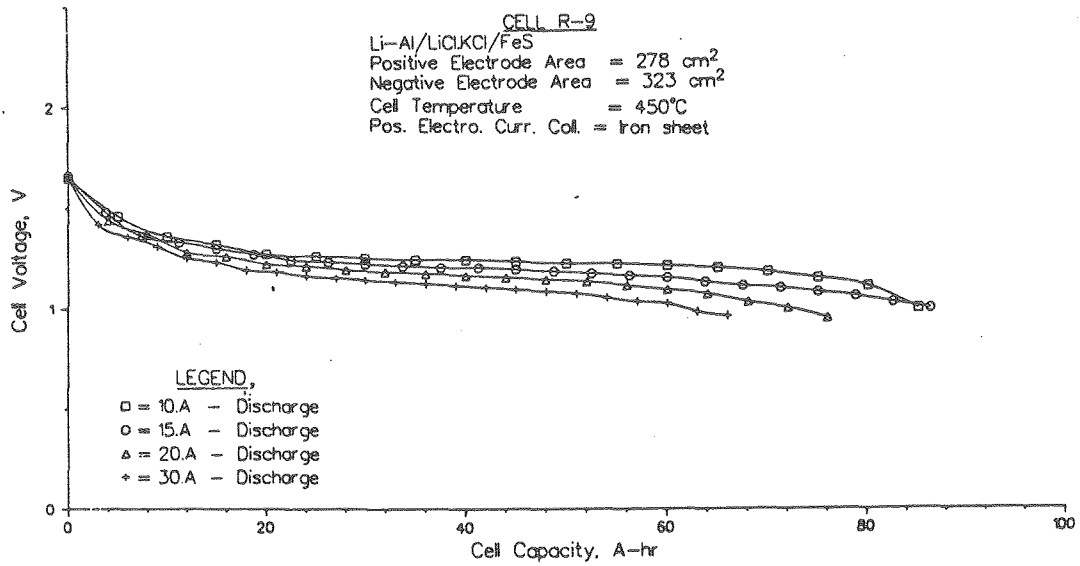

XBL 802-8069

Figure 2. Voltage-capacity curves for a LiAl/FeS cell. (6)

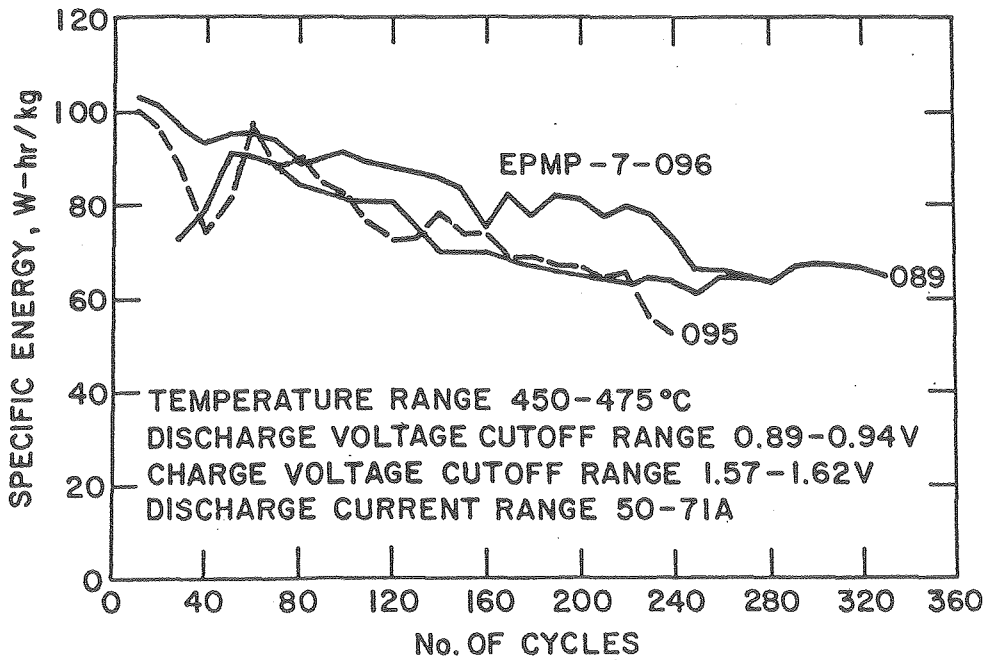

XBL 801-7729

Figure 3. Specific energy vs cycle number of LiAl/FeS cells. (7)

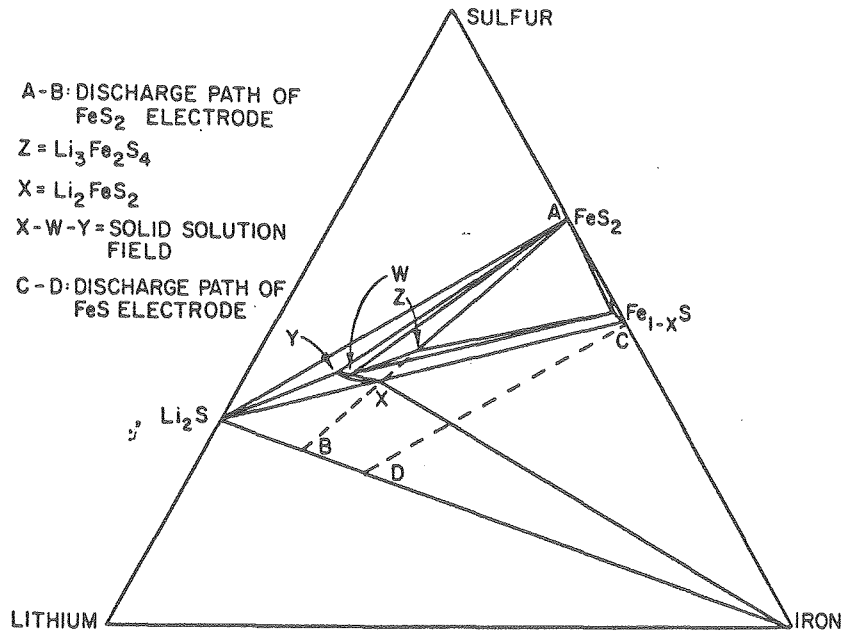

XBL 802-8072

Figure 4. Isothermal section of the lithium-sulfur-iron phase diagram at 450°C. (8)

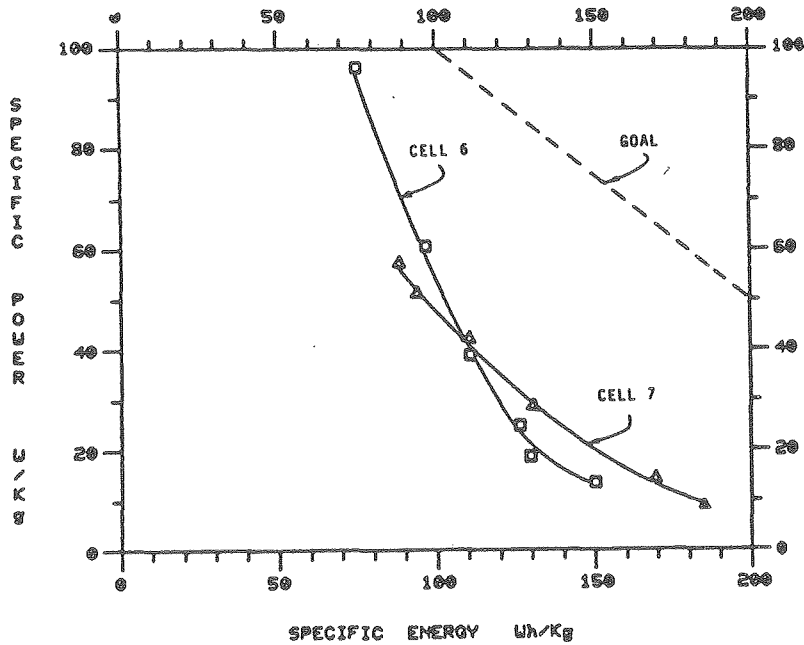

XBL 802-8065

Figure 5. Specific power vs specific energy plot for  $\text{Li}_4\text{Si}/\text{FeS}_2$  cells operating at about 475°C. (14)

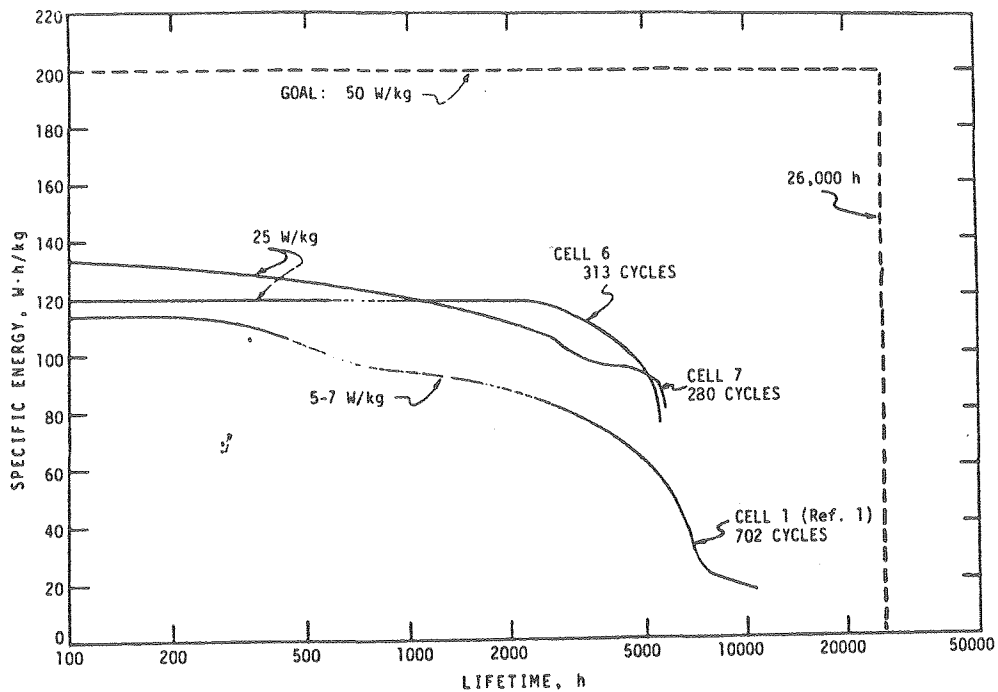

XBL 802-8066

Figure 6. Specific energy vs time for  $\text{LiAl}/\text{FeS}_2$  and  $\text{Li}_4\text{Si}/\text{FeS}_2$  cells. (14)

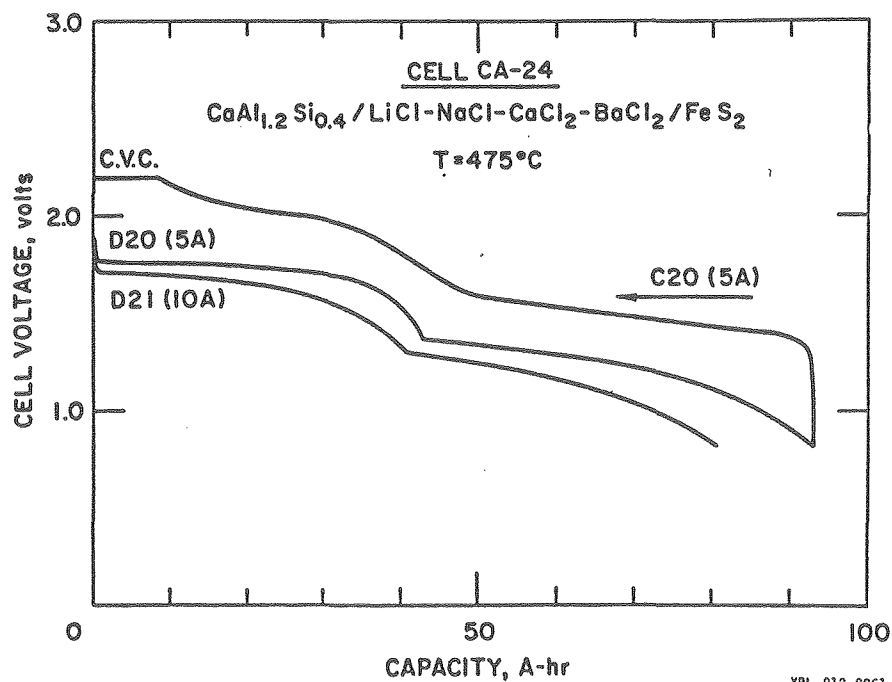

XBL 812-8061

Figure 7. Voltage vs capacity curves for a  $\text{CaAl}_{1.2}\text{Si}_{0.4}/\text{FeS}_2$  cell. (16)



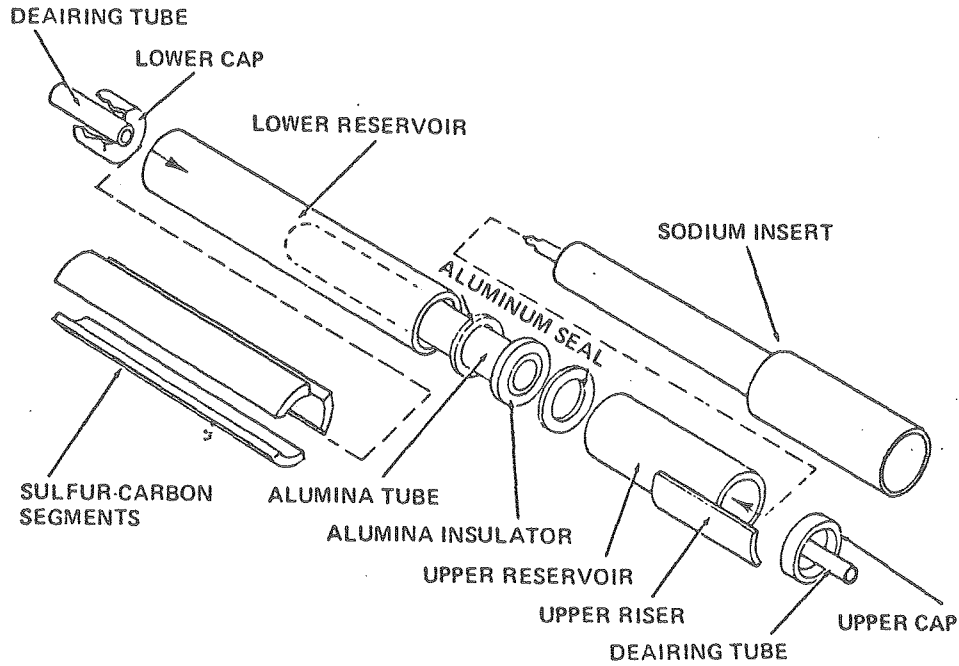

XBL 802-8070

Figure 8. Exploded view of a Na/S cell with a  $\beta''\text{Al}_2\text{O}_3$  electrolyte. (18)

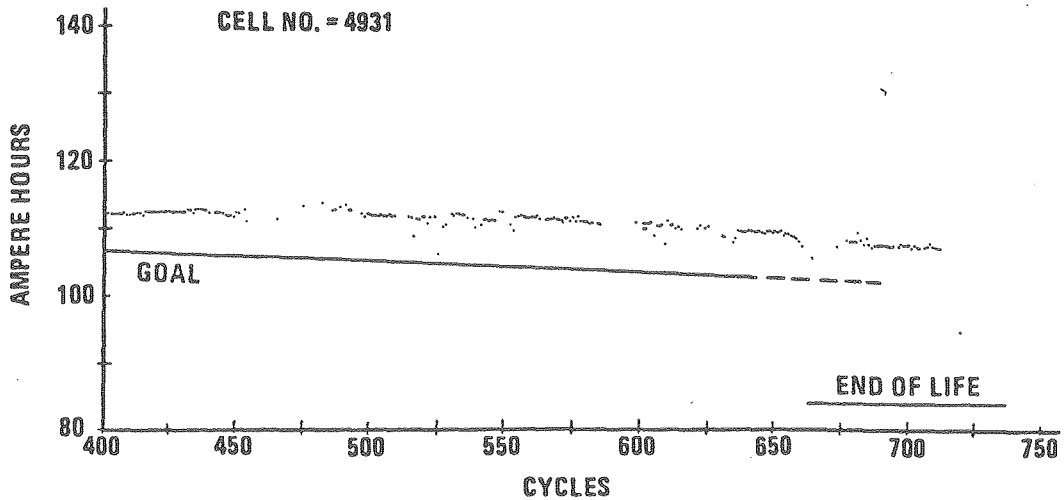

XBL 812-8062

Figure 9. Capacity vs cycle number for a Na/S cell. (24)

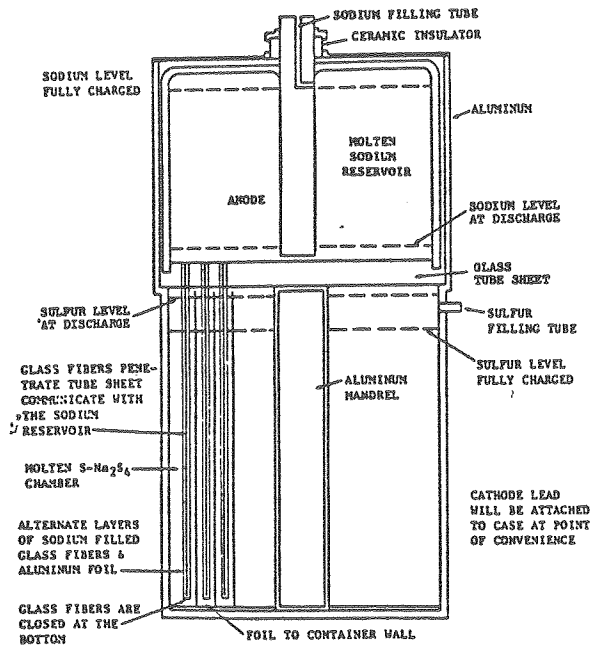

XBL 7912-13726

Figure 10. The DOW Sodium/Sulfur Hollow Fiber Cell. (20)

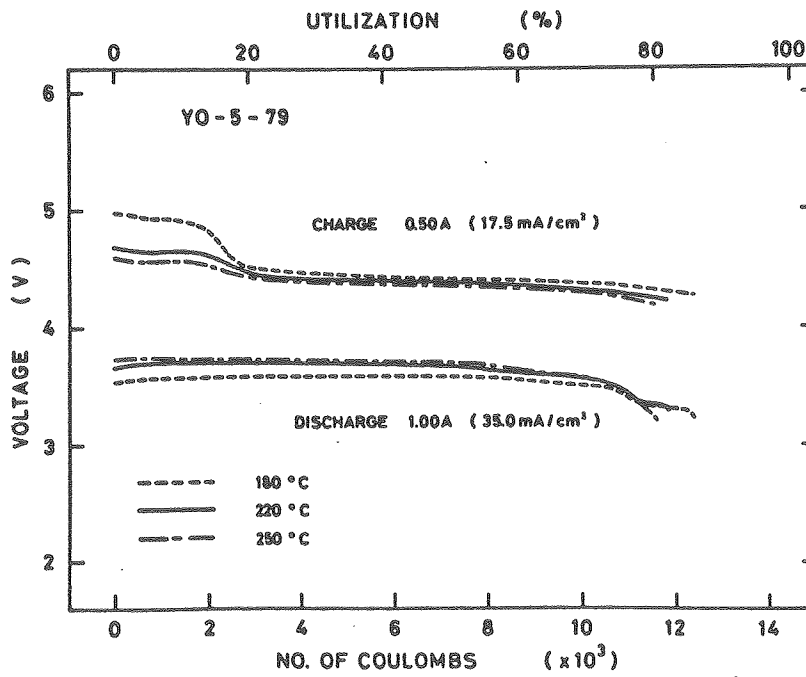

XBL 812-8063

Figure 11. Galvanostatic charge-discharge curves for a  $\text{Na}/\beta''\text{Al}_2\text{O}_3/\text{SCl}_3\text{AlCl}_4$  in  $\text{AlCl}_3\text{-NaCl}$  cell at three temperatures. (21)

| <u>Key Word</u>  | <u>Page Reference</u> |
|--|-----------------------|
| AlCl <sub>3</sub>  | 11                    |
| beta alumina   | 9                     |
| borate glass   | 11                    |
| boron nitride  | 3,4                   |
| calcium  | 7                     |
| Ca <sub>2</sub> Si/LiCl-NaCl-CaCl <sub>2</sub> -BaCl <sub>2</sub> /FeS <sub>2</sub> cell                                 | 7                     |
| C <sub>6</sub> N <sub>4</sub>  | 9                     |
| cobalt sulfides  | 3                     |
| copper sulfides  | 3                     |
| djerfischerite   | 3                     |
| Li/Li <sub>2</sub> O/LiNO <sub>3</sub> -KNO <sub>3</sub> /V <sub>2</sub> O <sub>5</sub> cell                             | 12                    |
| LiAl/LiCl-KCl/FeS cell   | 2                     |
| LiAlCl <sub>4</sub>  | 3                     |
| LiNO <sub>3</sub> -KNO <sub>3</sub>  | 12                    |
| Li <sub>2</sub> O  | 12                    |
| Li <sub>4</sub> Si/LiCl-KCl/FeS <sub>2</sub> cell  | 4                     |
| lithium-silicon  | 6                     |
| magnesium oxide  | 4                     |
| molten-salt  | 1                     |
| molten-salt cells  | 1                     |
| Na/Na <sup>+</sup> glass/Na <sub>2</sub> S <sub>n</sub> -S cell  | 11                    |
| Na/Na <sub>2</sub> O·xAl <sub>2</sub> O <sub>3</sub> /Na <sub>2</sub> S <sub>n</sub> -S cell                             | 8                     |
| Na/Na <sub>2</sub> O·xAl <sub>2</sub> O <sub>3</sub> /SCL <sub>3</sub> AlCl <sub>4</sub> in AlCl <sub>3</sub> -NaCl cell | 11                    |
| NaCl   | 11                    |
| Nasicon  | 10                    |
| rechargeable cells   | 1                     |
| SCL <sub>3</sub> AlCl <sub>4</sub>   | 11                    |
| sodium polysulfide   | 8                     |
| sodium/sulfur cell   | 8                     |
| solid electrolyte  | 2                     |
| TiO <sub>2</sub>   | 9                     |